

SAVIN[®]

9940DPC

General Reference

Read Me First

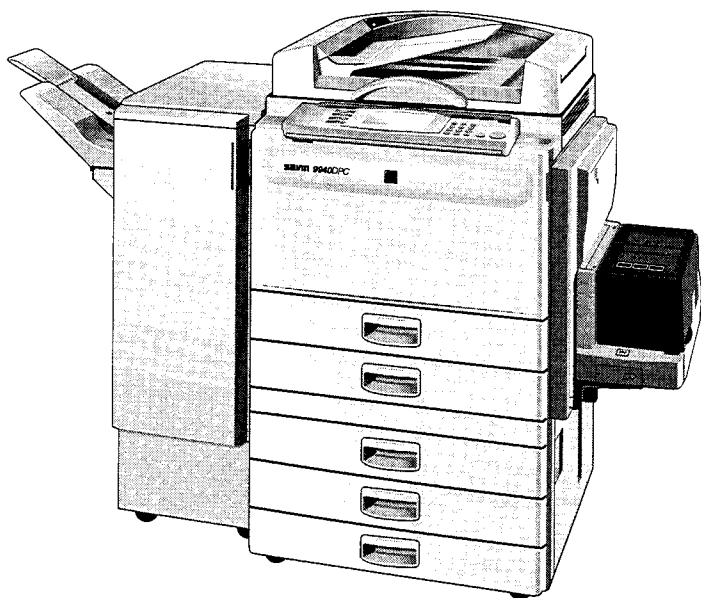

Operating Instructions

Please read the Safety Information section and keep this manual by the machine.

Warning:

This equipment has been tested and found to comply with the limits for a Class A digital device, pursuant to Part 15 of the FCC Rules. These limits are designed to provide reasonable protection against harmful interference when the equipment is operated in a commercial environment.

This equipment generates, uses, and can radiate radio frequency energy and, if not installed and used in accordance with the instruction manual, may cause harmful interference to radio communications.

Operation of this equipment in a residential area is likely to cause harmful interference in which case the user will be required to correct the interference at his own expense.

This digital apparatus does not exceed the Class A limits for radio noise emissions from digital apparatus as set out in the interference-causing equipment standard entitled "Digital Apparatus", ICES-003 of the Department of Communications.

Cet appareil numerique respecte les limites de bruits radioelectriques applicables aux appareils numeriques de Class A prescrites dans la norme sur le materiel brouilleur:

"Appareils Numeriques", NMB-003 edictee par le ministre des Communications.



Declaration of Conformity

"The Product complies with the requirements of **the EMC Directive 89/336/EEC** and the **Low Voltage Directive 73/23/EEC.**"

Konformitätserklärung

"Das Produkt entspricht den Anforderungen der **EMV-Richtlinie 89/336/ EWG** und der Niederspannungsrichtlinie **73/23/EWG.**"

Déclaration de conformité

"Le produit remplit toutes les conditions requises par la **directive EMC 89/336/CEE** ainsi que la **directive faible voltage 73/23/CEE.**"

Dichiarazione di conformità

"Il prodotto è conforme ai requisiti della **direttiva CEE 89/336 EMC** e della **direttiva CEE sulla bassa tensione 73/23.**"

EMC: CISPR-22:1985/EN 55022:1988 class B*

*** Note:**

This product contains Network Interface Card (NIC) options.

When using the NIC option, the product meets the requirements of EN55022 Class A.

Operator Safety:

This copier is considered a CDRH class I laser device, safe for office/EDP use. The Copier contains a 15-milliwatt, 760-800 nanometer wavelength, GaAlAs laser diode. Direct (or indirect reflected) eye contact with the laser beam may cause serious eye damage. Safety precautions and interlock mechanisms have been designed to prevent any possible laser beam exposure to the operator.

Laser Safety:

The Center for Devices and Radiological Health (CDRH) prohibits the repair of laser-based optical unit in the field. The optical housing unit can only be repaired in a factory or at a location with the requisite equipment. The laser subsystem is replaceable in the field by a qualified Customer Engineer. The laser chassis is not repairable in the field. Customer engineers are therefore directed to return all chassis and laser subsystems to the factory or service depot when replacement of the optical subsystem is required.

Warning:

Use of controls or adjustment or performance of procedures other than those specified in this manual may result in hazardous radiation exposure.

Notice:

Product names used herein are for identification purposes only and may be trademarks of their respective companies. The manufacturer disclaims any and all rights in those marks.

INTRODUCTION

This manual contains detailed instructions on the operation and maintenance of this machine. To get maximum versatility from this copier all operators should carefully read and follow the instructions in this manual. Please keep this manual in a handy place near the machine.

Please read the next section before using this copier. It contains important information related to *user safety and preventing equipment problems*.

SAFETY INFORMATION

When using your machine, the following safety precautions should always be followed.



Important Symbols Used In This Manual



 **WARNING:** *Ignoring this warning could cause serious injury or even death.*

 **CAUTION:** *Ignoring this caution could cause injury or damage to property.*

Examples

 **A situation that requires you take care.**

 **Do NOT carry out the operation represented by the symbol .**
This example means "Do not take apart."

 **A  symbol means you MUST perform this operation.**
This example means "You must remove the wall plug."

WARNINGS:



- *Only connect the machine to the power source described on the inside front cover of this manual.*
- *Avoid multi-wiring*
- *Do not damage, break or make any modifications to the power cord. Do not place heavy objects on it, pull it hard or bend it more than necessary. These actions could cause an electric shock or fire.*
- *Do not plug or unplug the power cord with your hands wet. Otherwise, an electric shock might occur.*



- *Make sure the wall outlet is near the machine and freely accessible so that in event of an emergency it can be unplugged easily.*



- *Do not remove any covers or screws other than those specified in this manual. Some parts of the machine are at a high voltage and could give you an electric shock. Also, if the machine has laser systems, direct (or indirect) reflected eye contact with the laser beam may cause serious eye damage. When the machine needs to be checked, adjusted, or repaired, contact your service representative.*
- *Do not take apart or attempt any modifications to this machine. There is a risk of fire, electric shock, explosion or loss of sight. If the machine has laser systems, there is a risk of serious eye damage.*



- *If the machine looks damaged or breaks down, smoke is coming out, there is a strange smell or anything looks unusual, immediately turn off the main switch then unplug the power cord from the wall. Do not continue using the machine in this condition. Contact your service representative.*
- *If metal, liquid or foreign matter falls into the machine, turn off the main switch. and unplug the main power cord. Contact your service representative. Do not keep using the machine with a fault or defect. If metal, liquid or foreign matter falls into the machine, turn off the main switch. and unplug the main power cord. Contact your service representative. Do not keep using the machine with a fault or defect.*



- *Do not put any metal objects or containers holding water (e.g. vases, flowerpots, glasses) on the machine. If the contents fall inside the machine, a fire or electric shock could occur.*



- Do not incinerate used toner or toner containers. Toner dust might ignite when exposed to an open flame. Dispose of the used toner containers according to local regulations for plastics.

CAUTIONS:



- Keep the machine away from humidity and dust. A fire or an electric shock might occur.
- Do not place the machine on an unstable or tilted surface. If it topples over, it could cause injury.



- After you move the machine, fix it with the caster fixture. Otherwise, the machine might move or come down to cause a personal injury.



- When you move the machine, unplug the power cord from the wall outlet to avoid fire or electric shock.
- When the machine will not be used for a long time, unplug the power cord.



- When you pull out the plug from the socket, grip the plug to avoid damaging the cord and causing fire or electric shock.



- If you use the machine in a confined space, make sure there is a continuous air turnover.



- Do not re-use stapled paper. Do not use aluminum foil, carbon-containing paper or other conductive paper. Otherwise, a fire might occur.



- When removing misfed paper, do not touch the fusing section because it could be very hot.



- This machine has been tested for safety using this supplier's parts and consumables. We recommend you only use these specified supplies.



- Do not eat or swallow toner.
- Keep toner or toner containers out of reach of children.

WHAT YOU CAN DO WITH THIS MACHINE

This machine can be used as a copier, printer, and scanner. Below is a summary of the main features. For more details, refer to the separate Copy, Printer and Scanner Reference manuals.

Copier Features

- Basic copy & copy with editing
- Reduction and enlargement
- Duplex
- Date print
- Electrical sort with memory
- Reverse sort with memory

Printer Features

This machine can be used stand-alone or as a network printer.

Options:

- PostScript2 Kit
- Ethernet NIC
- Token Ring NIC

Scanner Features

Scan in originals and load them into your PC.

MANUALS PROVIDED WITH THIS MACHINE

General Reference

Contains general information common to the Copier, Printer and Scanner features.

Copier Reference

Information specific to the Copier feature.

Printer Reference

Information specific to the Printer feature.

Scanner Reference

Information specific to the Scanner feature.

Table of Contents

INTRODUCTION	i
SAFETY INFORMATION	i
Important Symbols Used In This Manual	i
⚠ WARNINGS:	ii
⚠ CAUTIONS:	iii
WHAT YOU CAN DO WITH THIS MACHINE	iv
Copier Features	iv
Printer Features	iv
Scanner Features.....	iv
MANUALS PROVIDED WITH THIS MACHINE	v

WHERE IS IT & WHAT IS IT

MAIN UNIT AND OPTIONS	3
EXTERIOR AND INTERIOR PART NAMES	4
OPERATION PANEL	6
Keys.....	6
How To Use The Operation Panel.....	8

BASICS

STARTING THE MACHINE	11
When The Main Switch Is In The Stand-by Position	11
When The Display Is Off And The Clear Modes/Low Power Mode Key Is Lit	11
When Prompted For A User Code	12
SWITCHING BETWEEN THE PRINTER, COPIER AND SCANNER FUNCTIONS	13
INTERRUPTING THE CURRENT JOB	17
RECOMMENDED & NON-RECOMMENDED ORIGINALS	18

Recommended Originals	18
Non-recommended Originals For The Optional Document Feeder	18
SETTING ORIGINALS ON THE EXPOSURE GLASS	19
SETTING A STACK OF ORIGINALS IN THE OPTIONAL DOCUMENT FEEDER (ADF).....	19
SETTING ONE ORIGINAL AT A TIME IN THE OPTIONAL DOCUMENT FEEDER (SADF)	21

WHAT TO DO IF SOMETHING GOES WRONG

TROUBLESHOOTING.....	24
LOADING PAPER	26
Non-recommended Paper	26
Notes For Paper	26
Loading Paper In The Paper Tray	27
Loading Paper In The Large Capacity Tray.....	28
ADDING TONER	29
ADDING STAPLES	30
CLEARING MISFEEDS.....	31
Check The Display	31
Misfeeds In A, B, C, Y, Or Z Sections	32
Misfeed In The Large Capacity Tray.....	32
Misfeeds In P Section	33
Misfeeds In R Section	33
REMOVING JAMMED STAPLES	34

CHANGING SETTINGS

CHANGING THE PAPER SIZE	36
Changing The Paper Size In The 1st Tray	36
Changing The Paper Size In The Optional Tray Unit (Trays 2, 3, and 4) ..	41
USER TOOLS.....	42
User Tools Menu	42

How To Change The Basic Settings	43
Basic Settings	44
SERVICE REPRESENTATIVE SETTINGS.....	49

APPENDIX

MAINTAINING YOUR MACHINE.....	52
Document Feeder (Option).....	52
DO'S AND DON'TS.....	53
General Operations	53
When Adding Toner.....	53
When Removing Misfed Paper.....	53
Document Feeder (Option).....	54
Finisher (Option).....	54
PAPER TIPS.....	55
SCANNABLE AREA	55
WHERE TO PUT YOUR MACHINE.....	56
Environment.....	56
Power Connection	56
Access To The Machine.....	57
USE AND STORAGE OF SUPPLIES.....	58
Paper	58
Paper Storage.....	59
Toner Storage.....	59

SPECIFICATIONS

COPIER.....	62
PRINTER.....	62
SCANNER.....	63
GENERAL.....	63

DOCUMENT FEEDER (OPTION)..... 64

FINISHER (OPTION)..... 65

3-BIN SORTER..... 66

1000-SHEET TRAY UNIT (OPTION)..... 67

1500-SHEET TRAY UNIT (OPTION)..... 67

INDEX

INDEX 69

WHERE IS IT & WHAT IS IT

WHERE IS IT & WHAT IS IT

MAIN UNIT AND OPTIONS

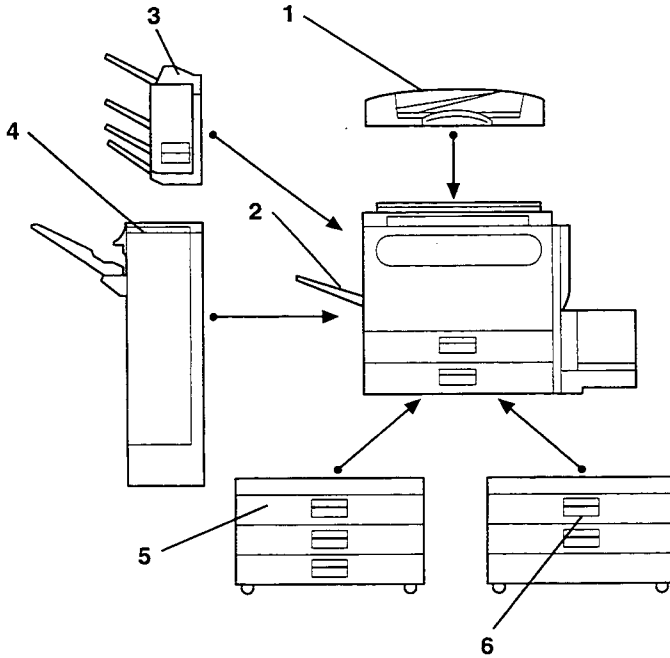

- | | |
|---|---|
| 1. Document feeder
(Option) | Insert a stack of originals here. They will be fed automatically. |
| 2. Copy tray
(Option) | Copied/printed papers are delivered here. |
| 3. 3 - bin sorter
(Option) | Sorts, stacks copied/printed papers. |
| 4. Finisher
(Option) | Sorts, stacks, and staples copied/printed papers. |
| 5. 1500-sheet tray unit
(Option) | Holds 1500 sheets of paper. |
| 6. 1000-sheet tray unit
(Option) | Holds 1000 sheets of paper. |

Other mechanical options: platen cover and key counter

EXTERIOR AND INTERIOR PART NAMES

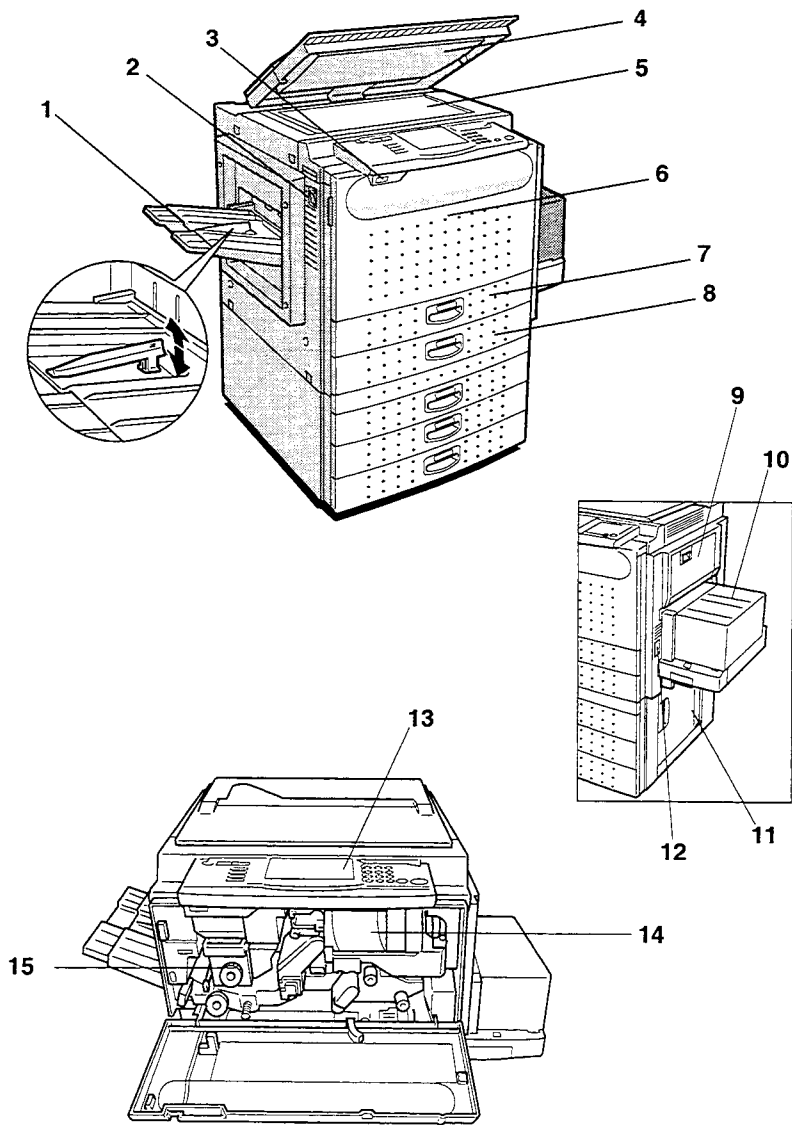

- | | |
|--|---|
| 1. Copy tray (option) | Completed copies are delivered here. Regarding the capacity of the tray, |
| 2. Main switch | Switches the machine between on and standby conditions. |
| 3. Auto response (human) sensor | When someone comes close to the machine, it will automatically switch from Low Power mode to standby mode. |
| 4. Platen cover (option) | Lower this cover over originals for copying. |
| 5. Exposure glass* | Position originals here face down for copying/scanning.
*After turning off the main switch, the exposure glass might be hot because of the anticondensation function. This is not a problem. |
| 6. Front cover | Open to access the inside of the machine. |
| 7. Unit for two-sided copies/prints (Duplex unit) | Makes two-sided copies/prints. |
| 8. Paper tray | Holds 500 sheets of copy paper. |
| 9. Bypass tray | Use to copy/print onto OHP sheets, adhesive labels, translucent paper, post cards, and non-standard size paper. |
| 10. Large capacity tray | Holds 1,000 sheets of paper. |
| 11. Right cover of the optional tray unit | Open to remove misfed paper. |
| 12. Key counter holder | Insert the optional key counter here. |
| 13. Operation panel | Operator controls and touch panel are located here. |
| 14. Toner bottle | Replace the toner bottle when "  Add Toner" is displayed on the display. |
| 15. Fusing unit | Fuses the image to the paper. When accessing the inside of the machine, use caution. This unit may be very hot. |

OPERATION PANEL

Keys

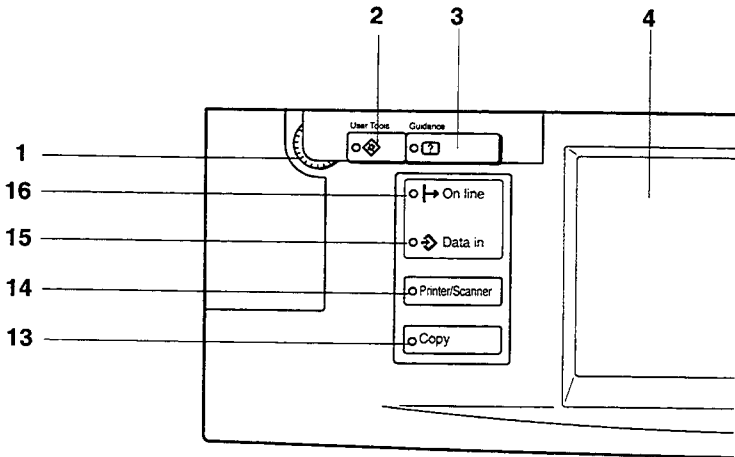
**1. Contrast Dial**

Changes the brightness of the display.

2. User Tools key

Changes the basic settings and copy features.

3. Guidance key

Shows guidance for functions.

4. Touch Panel Display**5. Program key**

Press to select the program mode.

6. Job Recall key

Use to recall your previous copy settings.

7. Clear Modes/Low Power Mode key

Press to clear the previously entered copy job settings. Also use to switch to and from Low Power mode.

8. Interrupt key

Press to make interrupt copies.

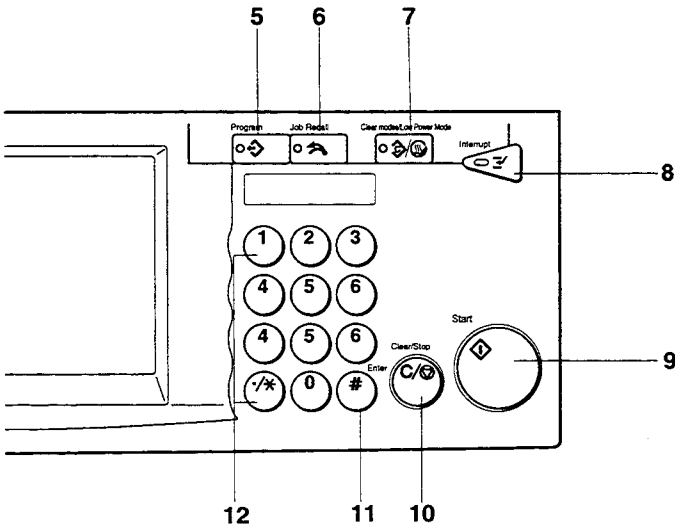
**9. Start key**

Press to start copying. Use to set the Auto Start.

10. Clear/Stop key

While entering numbers, press to cancel a number you have entered. While copying, press to stop copying.

11. Enter key

Use to enter data in selected modes.

12. Number keys

Use to enter the desired number of copies and data for selected modes.

13. Copy key

Use to enter Copy mode from Printer/Scanner mode.

14. Printer/Scanner key

Use to enter Printer/Scanner mode from the copy mode.

15. Data in indicator**16. On line indicator**

OPERATION PANEL

How To Use The Operation Panel

The type of operation panel is different depending on your location.

For U.S. model

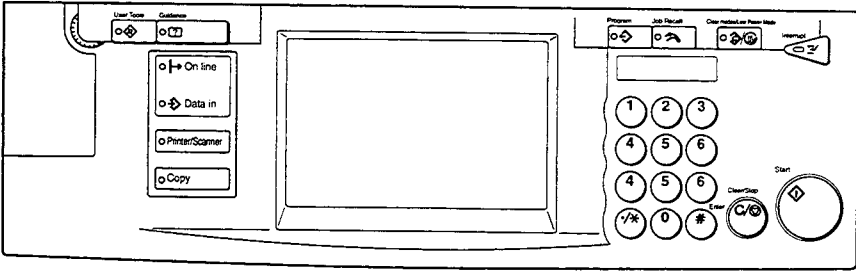

For Europe model

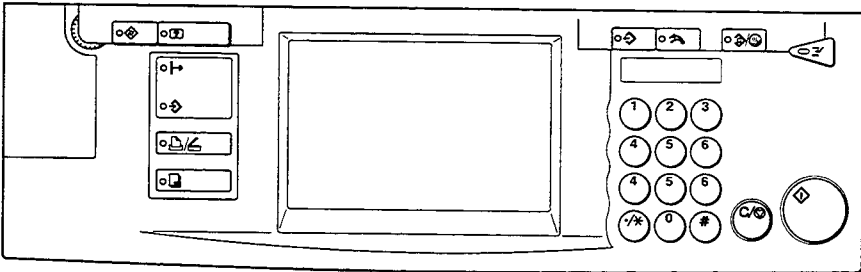

The panel layout is grouped as follows:

- Touch Panel Display
Use to make selections and navigate menus. Also shows the machine status and various messages. The status area is blank when in Printer mode and off-line.
- Numeric Keypad
Use to enter numbers and control how the machine functions.
- Control Keys
Other keys used when printing and configuring the machine.

When you first turn on the machine, the Touch Panel Display shows the Copy Menu. To access Printer mode, press the **[Printer/Scanner]** button on the left side of the operation panel.

Printer Mode (Printer controller option must be installed)

Press the **Printing/Scanner** key.

The on-line status screen will appear as below.

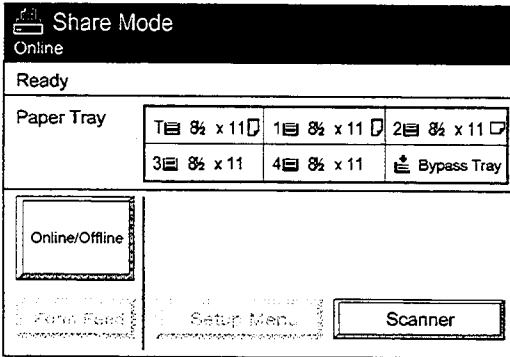

In this screen shot, access priority is "share".

Scanner Mode (Scanner kit option must be installed)

Press the **Printer/Scanner** key.

Touch **[Scanner]**.

BASICS

BASICS

STARTING THE MACHINE

When The Main Switch Is In The Stand-by Position

1 Turn on the main switch.

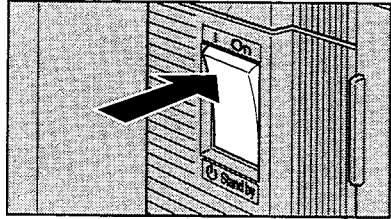

2 Wait for the machine to warm up. During the warm-up period (within 140 seconds), "⏸ Please wait." appears on the display.

3 After warm-up, "⏸ Ready" appears on the display.

When The Display Is Off And The Clear Modes/Low Power Mode Key Is Lit

The machine is in Low Power mode.

1 Hold down the **Clear Modes/Low Power Mode** key until the indicator goes out. The machine will return to the standby condition.

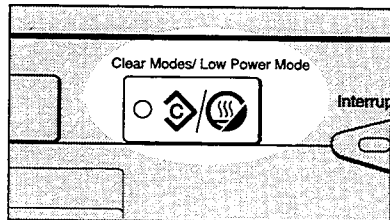

- The following actions will also wake up the machine:
 - ◆ Operating the machine.
 - ◆ Opening or closing the optional platen cover.
 - ◆ Opening or closing the optional document feeder.
 - ◆ Setting originals in the optional document feeder.
 - ◆ Opening or closing the bypass tray.
 - ◆ Pressing any key.

When Prompted For A User Code

- 1** The display instruct you to input your user code.

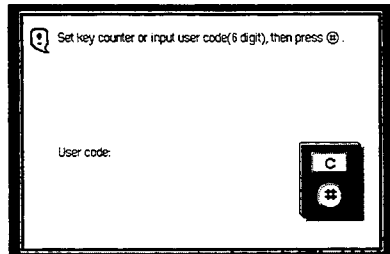

- 2** Enter your user code (6 digits) using the **Number** keys.

- If you make a mistake, touch the **[C]** key or press the **Clear/Stop** key. and enter the right number.

- 3** Touch the **[#]** key or press the **Enter** key.

- To prevent others from making copies with your user code, when you have finished using the machine, hold down the **Clear/Stop** key and press the **Clear Modes/Low Power Mode** key.

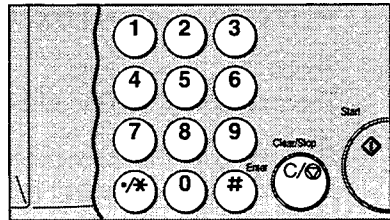

SWITCHING BETWEEN THE COPIER, PRINTER AND SCANNER FUNCTIONS

By default, the machine is in Share mode and set to Copier when you first switch on.

To Use The Copier:

Press the Copy key

Depending on the machine configuration, it may not be possible to use this function while another job is running.

To Use The Printer:

Press the Printer/Scanner key.

The display will change.

☛ refer the screen on page 9.

Depending on the machine configuration, it may not be possible to use this function while another job is still running.

To Use The Scanner:

1. **Press the Printer/Scanner key.**
The machine will switch to Printer.
☛ refer the figure on page 9.

2. Touch the Scanner key.
The machine will switch to Scanner.

Depending on the machine configuration, it may not be possible to use this function while another job is still running.

If the Scanner Only Mode is selected, scanner function can be used at the beginning.

How Are Multiple Scan, Print And Copy Jobs Handled?

Four modes are available that decide the priority the machine gives to various jobs.

Share Mode

Share mode lets you copy, print and scan, and is the default mode when you switch the machine on.

If there are no current print or scan jobs, the Copier screen is shown and you can use all the normal Copier functions.

The screen will change to the Printer screen if:

- A print job is received.
- You press the **[Printer/Scanner]** button.

If you wish to switch back to the Copy screen, just press the **[Copy]** key. If there are no current print jobs, the screen will change immediately. If the machine is printing, however, the screen will change as soon as the current print job has finished. Any other queued print jobs will be temporarily suspended until you finish your copying.

Note that even if the Copier screen is shown, the machine will still receive print jobs as long as the **Online** indicator is lit.

Printer Priority Mode

This is the same as Share mode, but you cannot use the **[interrupt]** buttons.

Printer Only Mode

Only printing is allowed. You cannot use the **[Interrupt]**, **[Copy]** or **[Scanner]** buttons.

Scanner Only Mode

Only scanning is allowed and the machine is off-line for print jobs. You cannot use the **[Interrupt]** or **[Copy]** keys.

SWITCHING BETWEEN THE COPIER, PRINTER AND SCANNER FUNCTIONS

Changing To Another Mode

- 1 Make sure the machine is in Copier mode.
Press the **Printer/Scanner** key to enter Printer mode.

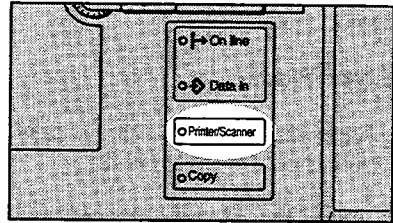

- 2 Touch [On-line/Off-line].

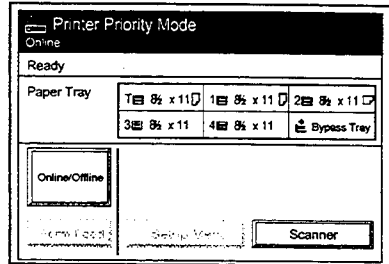

3 Touch **[Setup Menu]**.

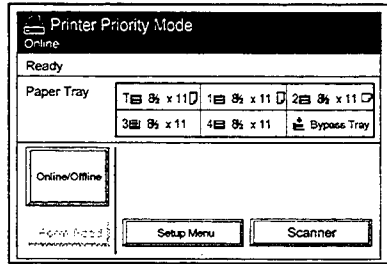

4 Touch **[Configuration Menu]**.

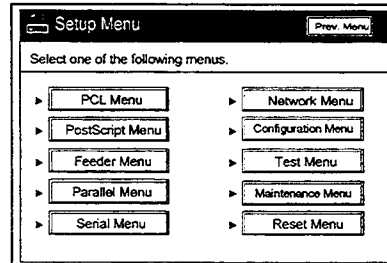

5 Touch **[Next]**.

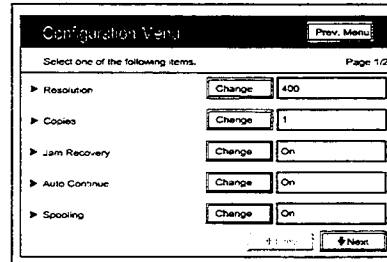

6 Touch **[Change]** in the mode options.
 Touch either **[Share]**, **[Scanner only]**, **[Printer Priority]** or **[Printer only]**.
 Touch **[Exit]**.

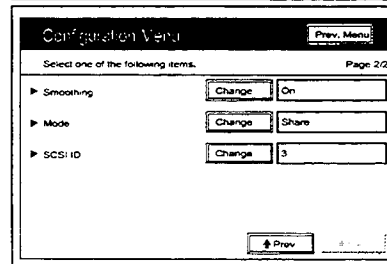

7 Touch **[Preve. Menu]** three times.

8 Touch **[On-line/Off-line]** to return to the printer on-line screen.

BASICS

INTERRUPTING THE CURRENT JOB

This machine cannot perform two jobs at the same time. Multiple jobs are carried out in the order that they were started.

You can interrupt a printing job to make copies.

Depending on the original configuration settings, you may not even be able to interrupt the above cases.

After your interrupt operation has finished and the auto-clear time has elapsed, the machine goes back to the operation it was doing before you interrupted it. For more about the configuration settings,

The following functions cannot be used during an interrupt operation:

- Duplex mode
- Sort, Rotate Sort
- Stack, Rotate Stack
- Stapling
- Adjust Image mode
- Stamp
- Combine
- Series Copies

Interrupting A Print Job To Make Copies

- 1** Press the **Interrupt** key.
- 2** Make your copies as you would normally do.

RECOMMENDED & NON-RECOMMENDED ORIGINALS

Recommended Originals

- ❑ For details of originals that the optional document feeder can handle, see page 62.

Non-recommended Originals For The Optional Document Feeder

⚠ CAUTION: *The following types of originals are not recommended for use with the document feeder. Place them directly on the exposure glass.*

- ❑ Originals thicker than 128 g/m², 34 lb.
- ❑ Originals thicker than 105 g/m², 28 lb. when using two-sided originals
- ❑ Originals thinner than 40 g/m², 11 lb. But for originals between 40 and 52 g/m² (11 and 14 lb.), the document feeder must be set to Thin Paper mode. See the "Copy Reference".
- ❑ Originals larger than A3, 11" x 17"
- ❑ Originals smaller than A5, 5 1/2" x 8 1/2"
- ❑ Paper with any kind of coating (such as carbon) on the back
- ❑ Folded, curled, creased, or damaged originals
- ❑ Mailing labels, or perforated originals
- ❑ OHP transparencies
- ❑ Translucent paper
- ❑ Pasted originals
- ❑ Damp originals
- ❑ Sticky originals
- ❑ Wavy originals
- ❑ Originals that are not made from paper
- ❑ Originals written in pencil on both sides, or two-sided carbon originals
- ❑ Thermal fax paper, CRO (camera ready original) or aluminum foil
- ❑ Originals with globs of ink from a ball-point pen

SETTING ORIGINALS ON THE EXPOSURE GLASS

- 1** Lift the optional platen cover or the optional document feeder.

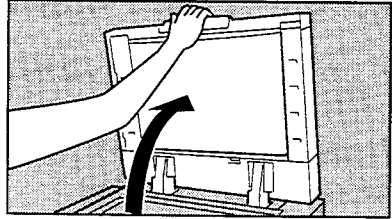

- 2** Set the original *face down* on the exposure glass. The original should be aligned to the rear left corner.

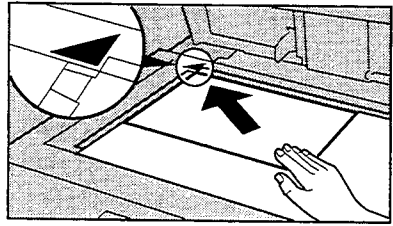

- 3** Lower the optional platen cover or the optional document feeder.

SETTING A STACK OF ORIGINALS IN THE OPTIONAL DOCUMENT FEEDER (ADF)

You can insert a stack of originals (one-sided or two-sided) of the same size into the document feeder. These originals are individually fed onto and removed from the exposure glass.

- 1** Correct any curl, fold, or crease in the originals before setting.

SETTING A STACK OF ORIGINALS IN THE OPTIONAL DOCUMENT FEEDER (ADF)

2 Confirm that the **Insert Original** indicator is lit before setting the originals.

3 Confirm that no previous originals remain on the exposure glass.

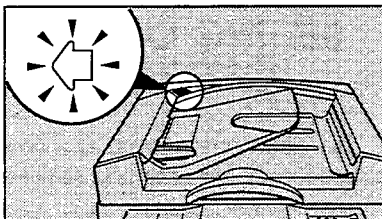

4 Adjust the guide to the original size.

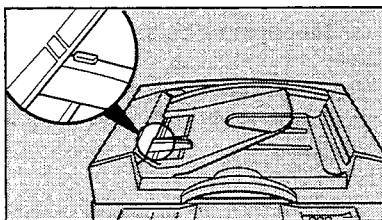

5 Set the originals into the document feeder until the **Insert Original** indicator goes off.

- When using the machine as a scanner, originals can be set either face down and face up.
- The guide must touch the front side of the originals.

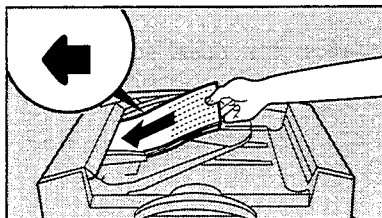

- Do not stack originals above the limit mark.

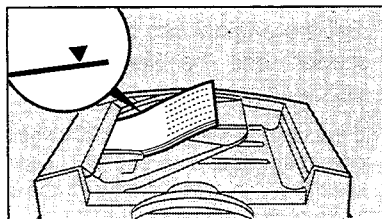

SETTING ONE ORIGINAL AT A TIME IN THE OPTIONAL DOCUMENT FEEDER (SADF)

You can insert one original at a time into the document feeder. The original is automatically fed onto and removed from the exposure glass.

- SADF is not available, when using the machine as a scanner with an ISIS driver.

1 Correct any curl, fold, or crease in the originals before setting.

2 Confirm that the **Insert Original** indicator is lit before setting the originals.

3 Confirm that no previous originals remain on the exposure glass.

4 Adjust the guide to the original size.

5 Set the original into the document feeder until the **Insert Original** indicator goes off.

- If you are copying a stack of originals one sheet at a time and you want to keep them in order, start with the last page of the originals.
- The original guide must touch the front side of the original.

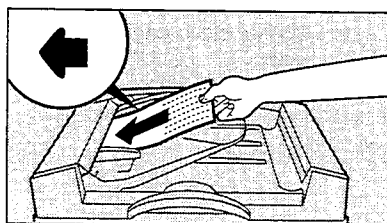
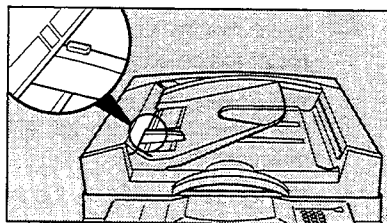
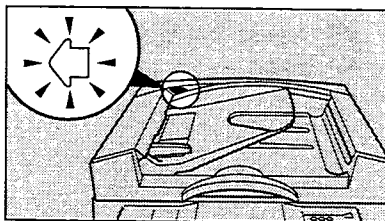

6 Press the **Start** key.

7 While the **Auto Feed** indicator is lit after an original is fed, set the next original. The original is automatically fed and copied.



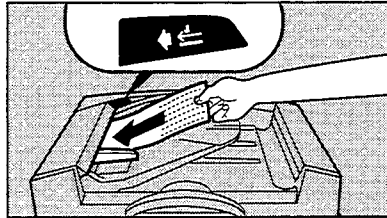







- If you have set more than two originals, the **Auto Feed** indicator is not lit after the last original is fed. In this case, press the **Start** key again after setting an original.



WHAT TO DO IF SOMETHING GOES WRONG

WHAT TO DO IF SOMETHING
GOES WRONG

TROUBLESHOOTING

Machine's Condition	Action
Nothing happens when the main switch is turned on.	Check the power cord. Is it properly plugged into the outlet? ⇒ Plug it in firmly.
The machine has automatically switches itself off (Auto Off).	Turn on the main switch.
The Clear Modes/Low Power Mode key is lit, and the display is off.	The copier is in Low Power mode. ⇒ Press the Clear Modes/Low Power Mode key.
 and messages are displayed.	Follow the instructions on the display.
Paper runs out.	Load paper.
 is displayed.	Add toner.
 is displayed.	Add staples.
 is displayed.	Remove misfed paper.
 is displayed.	
 is displayed.	Close the indicated doors or covers.
 is displayed.	Set the fusing unit correctly. For position of the fusing unit,
 is displayed.	Remove the jammed staples.
 is displayed.	Turn the main switch off, wait a few seconds, and then turn it on. If  appears again, call your service representative.
 is displayed.	Used toner bottle is full. Call your service representative.

Machine's Condition	Action
Staples do not come out at all.	After loading a new staple cartridge, staples might not be ejected the first few times you try to use the stapler. ➔ Try again.
	A few sheets might not be stapled. To correct this, try turning over the paper stack in the tray unit. If there is no improvement, change to paper with less curl.
	There are jammed staples in the stapler. ➔ Remove jammed staples.
Misfeeds occur frequently.	Is the right kind of paper in the paper tray? ➔ Paper size and weight must be within the specification for this copier.
	Is folded, wrinkled, damp, or curled paper in the paper tray? ➔ Always use dry, undamaged paper.
	Is the paper properly set in the paper tray? ➔ Always load paper correctly.
	Are there any pieces of misfed paper or other foreign objects in the machine? ➔ Make sure that the paper path is completely clear of paper and other material after a misfeed.
	Paper size setting is not correct. ➔ Set the proper paper size with the User Tools.

- ❑ For details of printer and scanner error messages, please refer to the Printer or Scanner Reference.
- ❑ If you cannot correct the problem by taking the above actions, please contact your service representative.

WHAT TO DO IF SOMETHING GOES WRONG

LOADING PAPER

- Regarding paper sizes that can be set, see the following pages:
 - 1st tray ➤ See page 36, 38, and 39.
 - optional tray unit ➤ See page 41.
 - large capacity tray ➤ See page 48.
- If you want to change the paper size, see the following pages:
 - 1st tray ➤ See page 36, 38, and 39.
 - optional tray unit ➤ See page 41.
 - large capacity tray ➤ See page 48.

Non-recommended Paper

- Folded, curled, creased, or damaged paper
- Torn paper
- Perforated paper
- Paper with conductive or low electrical resistance coating such as carbon or silver coating
- Thermal paper, art paper
- Thin paper that has low stiffness

Notes For Paper

- Load paper with the copy side down in the 500-sheet trays, and with the copy side up in the large capacity tray. If copies are curled, try turning the copy paper over in the tray. If there is no improvement, change to copy paper with less curl.
- Do not use paper that has been already copied/printed on.
- The following types of paper cannot be fed from the paper tray. Load them in the bypass tray.
 - OHP transparencies • adhesive labels • translucent paper
 - post card
- Correct curls in paper before loading.
- Fan paper to get air between the sheets before loading.

Loading Paper In The Paper Tray

- 1** Pull out the paper tray until it stops.

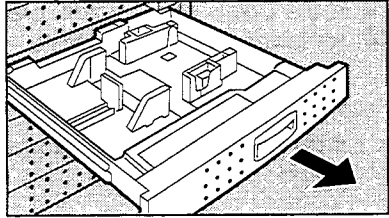

- 2** Load paper in the paper tray. Do not stack paper above the limit mark inside the paper tray.

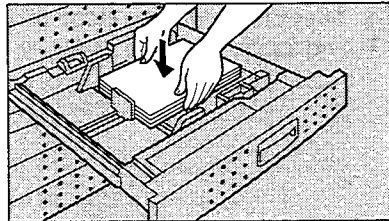

- 3** Push the tray in until it stops.

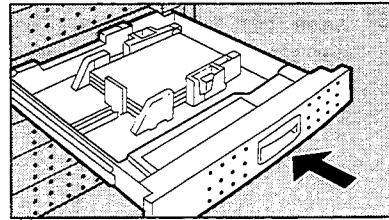

WHAT TO DO IF SOMETHING
GOES WRONG

Loading Paper In The Large Capacity Tray

- 1** If the **Down** key is not lit, press it to lower the bottom plate. The key will blink while the bottom plate is moving down.
- If the key is lit or blinking, proceed to step **2**.

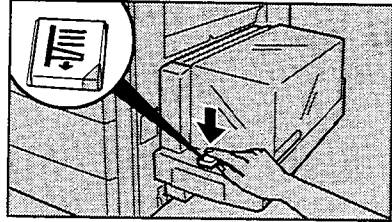

- 2** After the **Down** key stops blinking and lights, open the cover.

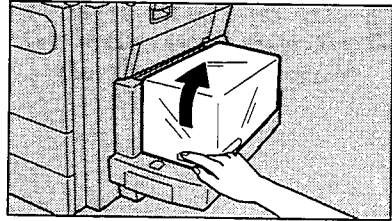

- 3** Load paper into the tray (not more than 1,000 sheets). The paper stack must be flush with the left side.

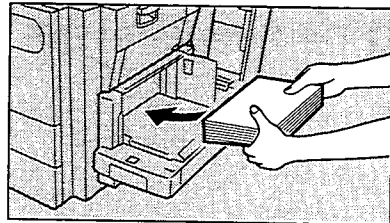

- 4** Close the cover.

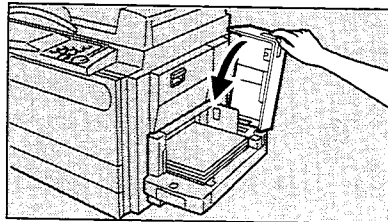

ADDING TONER

When "⚠️ Add Toner" is displayed on the display, it is time to supply toner.

⚠️ WARNING: Do not incinerate the used toner bottle. Toner bottle might ignite when exposed to open flame.

⚠️ WARNING: Dispose of the used toner bottle according to your local regulations.

NOTE: When adding toner, do not turn off the main switch. If you do, your copy settings are cleared.

NOTE: Before setting the new toner bottle, shake it well at least 5 or 6 times.

NOTE: Do not remove the toner cap of the new toner bottle.

1 Open the front cover of the machine.

2 You can find the sticker (with ⚠️ at the top) explaining how to add toner, inside the front cover as shown in the illustration.

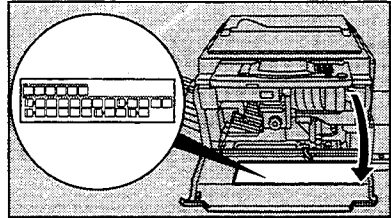

3 Load the new toner bottle following the instructions on the sticker.

WHAT TO DO IF SOMETHING GOES WRONG

ADDING STAPLES

When "🖨️ Add Staples" is displayed, add staples as follows:

- ❑ Do not remove the tape before setting the new staple refill in the cartridge. If you do, the staples fall into pieces.

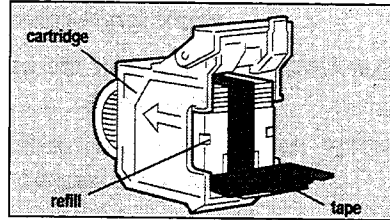

1 Open the front door of the finisher.

2 You can find a sticker (with 🖨️ at the top) explaining how to add a staple cartridge, inside the front door as shown in the illustration.

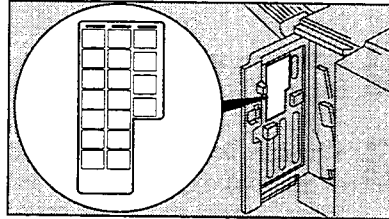



3 Add the new staple cartridge following the instructions on the sticker.

- ❑ After adding the new staple, several pages will be printed without stapling.

CLEARING MISFEEDS

 **WARNING:** Since some parts of the machine are supplied with high electrical voltage, touch only the parts specified in the instructions on the sticker inside the machine's cover.

 **WARNING:** When removing misfed paper from sections B and C, use caution. The fusing unit may be very hot. See page 4 for the position of the fusing unit.

 **CAUTION:** Do not leave any torn scraps within the machine.

NOTE: When clearing misfeeds, make sure that all units and levers are returned to their original positions and all covers are closed.

NOTE: Do not touch originals in the optional document feeder when a paper misfeed occurs in the machine. If you do, the machine will not know which originals have been copied and which should be copied.

Check The Display

The display shows the location of misfed paper. Remove them following instructions.

- P is indicated only when your machine is equipped with the optional document feeder.
- Right figure shows when your machine is equipped with the optional Finisher and Document Feeder.

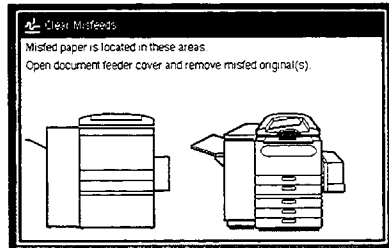

Misfeeds In A, B, C, Y, Or Z Sections

- 1** Open the front cover of the machine.
- 2** You can find a sticker (with  at the top) explaining how to remove misfed paper, inside the front cover as shown in the illustration.

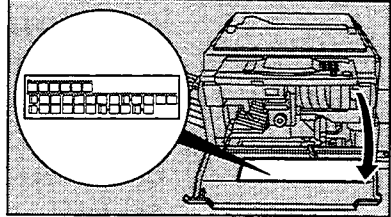

- 3** Remove misfed paper following the instructions on the sticker.

Misfeed In The Large Capacity Tray

- 1** Swing out the tray grasping the tray handle, and remove any misfed paper.
- 2** Return the tray to its original position.

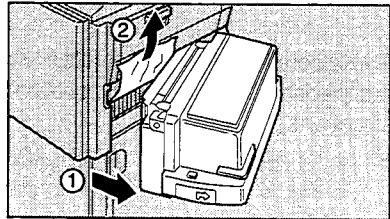

Misfeeds In P Section

- 1** You can find a sticker, explaining how to remove the misfed paper, on the optional document feeder as shown in the illustration.

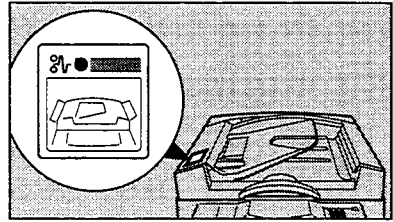

- 2** Remove the misfed original referring to the sticker.

Misfeeds In R Section

When The Optional Finisher Is Installed.

- 1** Open the front door of the optional finisher.
- 2** You can find a sticker (with $\%$ at the top) explaining how to remove misfed paper, inside the front door as shown in the illustration.

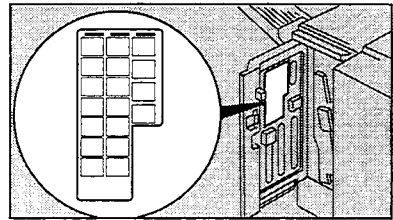



- 3** Remove misfed paper following the instructions on the sticker.

When The Optional 3-bin Sorter Is Installed

- 1** You can find a sticker, explaining how to remove the misfed paper, on the optional 3 bin sorter.
- 2** Remove the misfed paper referring to the sticker.

REMOVING JAMMED STAPLES

When " Check Staple Unit" is displayed, staples are jammed in the optional finisher. Follow these steps to solve the problem.

 **WARNING:** *Since some parts of the finisher are supplied with high electrical voltage, touch only the parts specified in the instructions on the sticker inside the finisher's cover.*

- After loading a new staple cartridge, staples might not be ejected the first few times you try to use the stapler.

1 Open the front door of the optional finisher.

2 You can find a sticker (with  at the top) explaining how to remove jammed staples, inside the front door as shown in the illustration.

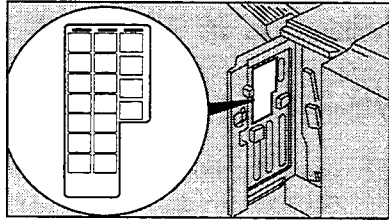

3 Remove jammed staples following the instructions on the sticker.

CHANGING SETTINGS

CHANGING THE PAPER SIZE

Changing The Paper Size In The 1st Tray

Standard Size Paper

☐ You can select paper of the following sizes:

Metric version	Inch version
A3 ☐, B4 ☐, A4 ☐ ☐, B5 ☐ ☐, A5 ☐ 8 1/2" x 11" ☐ ☐	11" x 17" ☐, 8 1/2" x 14" ☐, 8 1/2" x 11" ☐ ☐, 5 1/2" x 8 1/2" ☐*, A3 ☐, A4 ☐ ☐, A5 ☐

*: 5 1/2" x 8 1/2" : is not available when using 3 bin sorter.

1 Pull the paper tray out until it stops.

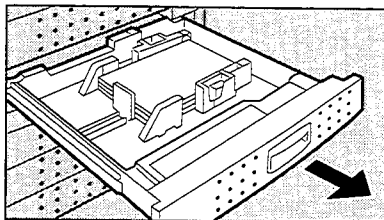

2 Remove the copy paper.

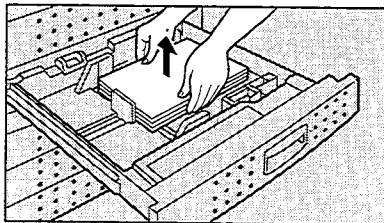

3 Remove the left guide as shown in the illustration.

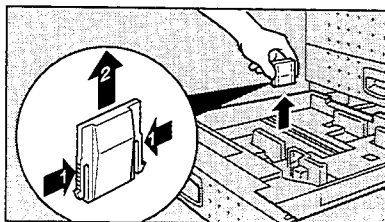

- 4** Set the left guide to the paper size you want to use as shown in the illustration.

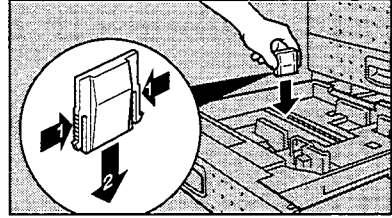

- 5** Load paper in the tray.
 □ Do not stack paper over the limit mark.

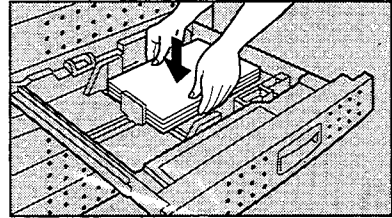

- 6** While pressing the release lever on the front guide, slide the front and rear guides to the paper size you want to use.

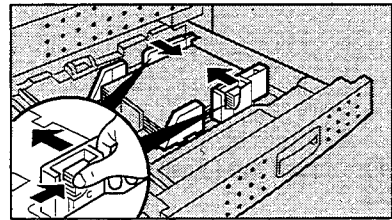

- 7** Select the paper size by adjusting the paper size selector on the back side of the tray.

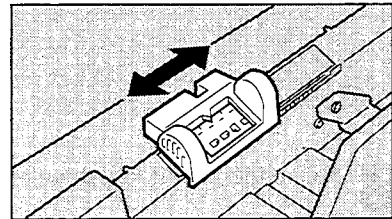

- 8** Push the paper tray in until it stops.

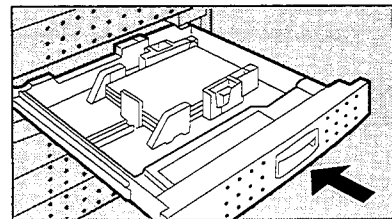

F/F4 Size Paper (8" x 13", 8 1/4" x 13", or 8 1/2" x 13)

1 Follow steps **1** to **6** on pages 36 and 37.

2 Select "F/F4" by adjusting the paper size selector on the back side of the tray.

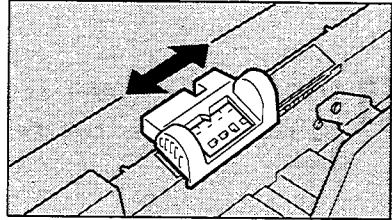

3 Press the **User Tools** key.

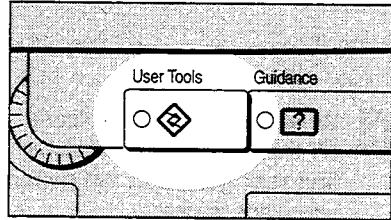

4 Touch the **[Basic Settings]** key.

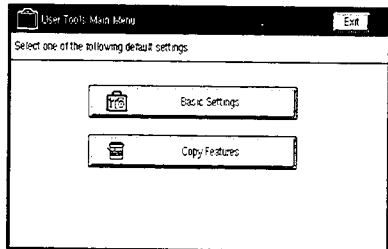

5 Touch the **[Next]** key three times to reach the paper size setting menu.

6 In the "Tray 1 <F/F4> Paper Size Setting" menu, the present size setting is displayed. Touch the **[Change]** key. Select the new paper size by touching a key. Then, touch the **[Exit]** key.

7 Press the **User Tools** key, then push the paper tray in until it stops.

Special Size Paper

□ You can select paper of the following sizes:

Metric version	Inch version
11" x 17" □, 8 1/2" x 14" □, 5 1/2" x 8 1/2" □*, 8" x 10" □	11" x 15" □, 10" x 14" □, 8" x 10 1/2" □, 8" x 10" □, B4 □

*:Whin using 3-bin sorter, 5 1/2" x 8 1/2" : is not displayd.

1 Follow steps **1** to **6** on pages 36 and 37.

2 Select * by adjusting the paper size selector on the back side of the tray.

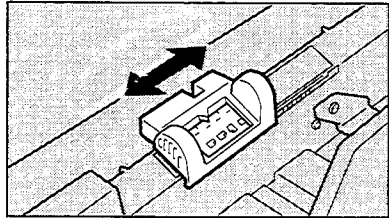

3 Press the **User Tools** key.

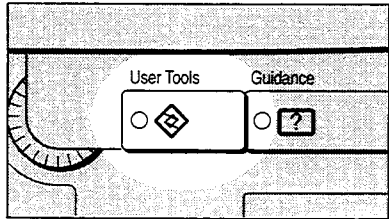

4 Touch the **[Basic Settings]** key.

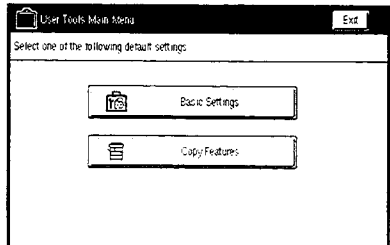

CHANGING THE PAPER SIZE

- 5** Touch the **[Next]** key three times to reach the paper size setting menu.
- 6** In the "Tray 1 <*> Paper Size Setting" menu, the present size setting is displayed. Touch the **[Change]** key. Select the new paper size by touching a key. Then, touch the **[Exit]** key.
 - "*" (asterisk) is displayed on the key for paper sizes that cannot be detected in some modes (ex. Auto Paper Select).
- 7** Press the **User Tools** key, then push the paper tray in until it stops.

Changing The Paper Size In The Optional Tray Unit (Trays 2, 3, and 4)

You can select paper of the following sizes:

Metric version	Inch version
A3 □, B4 □, A4 □ □, B5 □ □ 11" x 17" □, 8 1/2" x 14" □, 8 1/2" x 11" □ □, 8" x 10" □, 8" x 13" □, 8 1/2" x 13" □, 8 1/4" x 13" □	11" x 17" □, 8 1/2" x 14" □, 8 1/2" x 11" □ □, 11" x 15" □, 10" x 14" □, 8" x 10 1/2" □, 8" x 10" □, A3 □, B4 □, A4 □ □, 8" x 13" □, 8 1/2" x 13" □, 8 1/4" x 13" □

1 Follow steps **1** to **6** on pages 36 and 37.

2 Press the **User Tools** key.

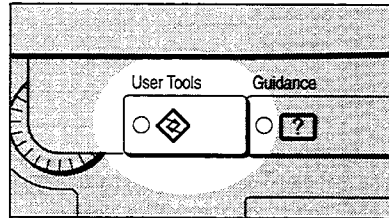

3 Touch the **[Basic Settings]** key.

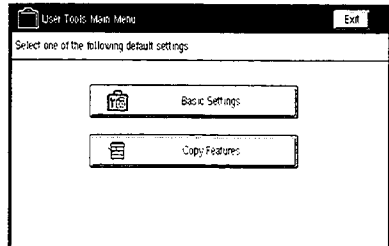

4 Touch the **[Next]** key three times to reach the paper size setting menu.

5 Find the paper tray (2, 3, or 4) and touch the **[Change]** key. Select the new paper size by touching a key. Then, touch the **[Exit]** key.

6 Press the **User Tools** key, then push the paper tray in until it stops.

This section is for operators in charge of this machine. The User Tools allow access to advanced settings.

User Tools Menu

Basic Settings

Menu	
	Auto Response (Human) Sensor
	Operation panel beeper
	Copy count display
	Set date
	Set time
	Auto Reset
	Low Power Timer
	Auto Off Timer
	Paper Type Display (for each tray)
	Tray 1 <*> Paper Size Setting
	Tray 1 <F/F4> Paper Size Setting
	Paper Size Setting (for tray 2, 3, and 4 (option))
	Paper Tray Priority
	Original: <F/F4> Size Setting
	ADF: Thin Paper Mode
	Auto Tray Switching
	Set User Code(s)
	Output Trays
	Function Timeout

How To Change The Basic Settings

1 Confirm that the machine is in the initial condition. If not, press the **Clear Modes/Low Power Mode** key.

2 Press the **User Tools** key.

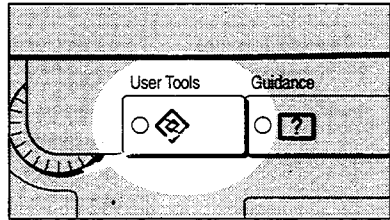

3 Touch the **[Basic Settings]** key.

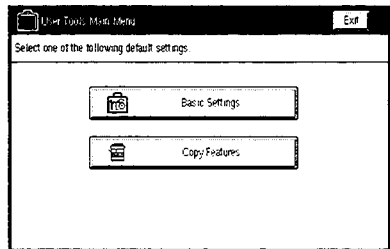

4 Select the desired settings following the instruction on the display.

- **[▼Next]** : Use to go to the next page.
- **[▲Prev.]** : Use to go back to the previous page.
- **[Exit]** : Touch this key after entering the new data.
In the "User Tools Main Menu", touch to exit the User Tools condition.
- **[Cancel]** : Touch to return to the previous menu without changing any data.
- **[Menu]** : Use to go back to the previous menu.

5 To return to the initial condition, press the **User Tools** key.

Basic Settings

MENU	DESCRIPTION
Auto Response (Human) Sensor	When the auto response sensor does not detect anyone operating the machine for a while, it will switch to one of the Reset modes (Auto Reset, Low Power mode, Auto Off, or SADF Auto Reset). You change the delay before this cuts in. <input type="checkbox"/> Default: Yes (On)
Operation panel beeper	The noise made when you push a button can be turned off. <input type="checkbox"/> Default: On
Copy count display	The copy counter can be set to show the number of copies made (count up) or the number of copies remaining to be made (count down). <input type="checkbox"/> Default: Up (count up)
Set date Set time	Use to set the date and copier's internal clock. <input type="checkbox"/> Date Stamping uses this date. <input type="checkbox"/> Remember to adjust the clock for Daylight Saving Time.
▼ Next	
Auto Reset	The machine returns to standby automatically a while after every job. You can change the delay from 0 (no Auto Reset) to 180 seconds. <input type="checkbox"/> Default: 30 seconds
Low Power Timer	[U.S. model] The copier will automatically enter a Low Power condition after the selected time after the last copying job has been completed. This time can be set from 1 to 120 minutes in 1 minute steps. <input type="checkbox"/> Default: 15 minutes <input type="checkbox"/> The operator can activate the Low Power mode by pressing the Clear Modes/Low Power Mode key for more than one second. <input type="checkbox"/> Time required to return to a ready condition from the Low Power mode is less than 30 seconds. <input type="checkbox"/> In this mode, power consumption is reduced from less than 0.20 kW (standby) to less than 0.11 kW [European model] The copier will automatically enter a Low Power mode while after the last job has been completed. You can change the delay from 0 (Low Power mode off) to 180 seconds. <input type="checkbox"/> When "0" is set, the machine does not enter a Low Power mode.

Auto Off Timer	<p>To conserve energy, this copier automatically turns off 60 minutes after the last copying job has been completed. This time can be set from 10 to 120 minutes in 10 minutes steps.</p> <ul style="list-style-type: none"> <input type="checkbox"/> Default: 60 minutes <input type="checkbox"/> To exit Auto Off mode, turn on the main switch. The main switch for this copier has three positions, press it all the way, and hold for 1 - 2 seconds. <input type="checkbox"/> In Auto Off mode, power consumption is reduced from less than 0.20kW (standby) to less than 0.04W. <input type="checkbox"/> This function is available when using the machine as a copier.
Output Trays	<p>Copy output tray and printer output tray can be select.</p> <ul style="list-style-type: none"> <input type="checkbox"/> This function is available when the 3-bin sorter is equipped.
Function Timeout	<p>0 to 180 seconds (step 10 seconds) can be selected.</p> <ul style="list-style-type: none"> <input type="checkbox"/> Default: 30 seconds

(Basic Settings)

MENU	DESCRIPTION
[▲ Prev.] [▼ Next]	
Paper Type Display	When recycled paper or special paper is in the paper trays, you can have the paper type shown on the display. <ul style="list-style-type: none"> <input type="checkbox"/> Default: No display <input type="checkbox"/> You cannot select both recycled paper and special paper in the same tray.
[▲ Prev.] [▼ Next]	
Tray 1 <*> Paper Size Setting	If you want to use a special paper size, you can select Tray 1 for this purpose. <ul style="list-style-type: none"> <input type="checkbox"/> Default: Metric version: 11" x 17" Inch version: 10" x 14" <input type="checkbox"/> For paper sizes that can be selected, see page 39. <input type="checkbox"/> Make sure you select * by adjusting the paper size selector on the back side of the tray. <input type="checkbox"/> * (asterisk) is displayed on paper size keys that cannot be used by Auto Paper Select.
Tray 1 <F/F4> Paper Size Setting	Select if you want to use 8 1/2" x 13, 8" x 13", or 8 1/4" x 13" paper for the 1st tray. <ul style="list-style-type: none"> <input type="checkbox"/> Default: 8 1/2" x 13 <input type="checkbox"/> For more details see page 38. <input type="checkbox"/> Make sure you select F/F4 by adjusting the paper size selector on the back side of the tray.
Paper Size Setting Tray 2, 3, and 4 (option)	Use to change the paper sizes in the optional tray unit. <ul style="list-style-type: none"> <input type="checkbox"/> Default: Metric version: A4 □ Inch version: 8 1/2" x 11" □ <input type="checkbox"/> Make sure you change the paper size setting, when changing the paper size in these trays otherwise a misfeed might occur. <input type="checkbox"/> Also be sure to select the paper size when installing the optional tray unit.
[▲ Prev.] [▼ Next]	

(Basic Settings)

MENU	DESCRIPTION
Paper Tray Priority	<div style="text-align: center;"> <input type="checkbox"/> [▲ Prev.] <input type="checkbox"/> [▼ Next] </div> <p><input type="checkbox"/> You can choose the tray which will be active under the following conditions:</p> <ul style="list-style-type: none"> ◆ when the main switch is turned on. ◆ after Auto Reset or Low Power mode ◆ after pressing the Clear Modes/Low Power Mode key <p>(* If "Auto Tray Switch" is on, these are valid in printer mode.)</p> <p><input type="checkbox"/> Default: Tray T (1000-sheet large capacity tray)</p> <p><input type="checkbox"/> This function is available, when using the machine as a copier.</p>
Original: <F/F4> Size Setting	<p>You can select one of the following original sizes to be detected in the Auto Paper Select and Auto Reduce/Enlarge modes as F size.</p> <p style="text-align: center;">8 1/2" x 13, 8 1/4" x 13", or 8" x 13"</p> <p><input type="checkbox"/> Default: 8 1/2" x 13"</p>
ADF: Thin Paper Mode	<p>Use when changing the type of originals to be fed into the optional document feeder. Select when you use thin originals (40 ~ 52 g/m² or 11 ~ 14 lb).</p> <p><input type="checkbox"/> Default: Normal (Not Thin)</p>
Auto Tray Switching	<p>If you load paper of the same size and in the same direction in two or more trays, the copier automatically shifts to another tray when the tray in use runs out of paper. You can cancel this setting.</p> <p>* If "Auto Tray Switch" is on, these are valid in printer mode.</p> <p><input type="checkbox"/> Default: Yes</p> <p><input type="checkbox"/> Trays for special paper and recycled paper can be used only when the Special Paper Size setting is the same.</p> <p><input type="checkbox"/> This function is available, when using the machine as a copier.</p>

(Basic Settings)

MENU	DESCRIPTION
Set User Code(s)	
<p>If User Codes are turned on, operators must input their user codes before using the machine. The machine keeps count of the number of copies made under each user code. To switch on this mode, utilize the "Set User Code Mode" User Tool and then contact your sales/service representative.</p>	
<p>Check/Reset/Print Copy Counter</p>	<p>Use to check the number of copies made under each user code, clear each code's counter, clear all code's counters and print the counter data for all user codes.</p>
<p>User Code Register/Change/Delete</p>	<p>Use to register, change, delete one user code, or delete all user codes.</p> <ul style="list-style-type: none"> <input type="checkbox"/> Up to 20 user codes (6 digits) can be registered. <input type="checkbox"/> When changing user codes, the number of copies made under the old code is added to that made under the new user code. <input type="checkbox"/> When deleting user codes, the number of copies made under the deleted code is deleted. <input type="checkbox"/> Registered codes will be sorted in numerical order.
<p>Assign/Activate Key Operator Code</p>	<p>If you select [Yes], only operators who know the key operator code can access User Tools from User Code mode.</p> <ul style="list-style-type: none"> <input type="checkbox"/> Default: No <input type="checkbox"/> If you select [Yes], you should register the key operator access code. ➔ Use the "Key Operator Code" menu.
<p>Key Operator Code</p>	<p>Use to register or change the key operator code.</p>
<p>Set User Code Mode</p>	<p>Turn User Codes on or off.</p> <ul style="list-style-type: none"> <input type="checkbox"/> Default: No (not User Code mode) <input type="checkbox"/> After select [Yes], please contact your sales/service representative to set your machine to the User Code mode.
<p>[▲ Prev.]</p>	

SERVICE REPRESENTATIVE SETTINGS

Some features can be adjusted by your service representative to suit your needs. This section gives a brief description of these features. For more information, contact your service representative.

LCT Paper Size Change

The large capacity tray holds A4 (for the metric version) or 8 1/2" x 11" (for the inch version) copy paper. If you need, A4 can be set for the inch version, and 8 1/2" x 11" can be set for the metric version.

Auto Stamping (for metric version)

If your machine is the metric version, Auto Stamping cannot be used as a default setting. You can cancel this setting and use this function.

A3, 11" x 17" Double Count

When you use A3, 11" x 17" paper, your service representative can set the copier to count each A3, 11" x 17" as two copies.

Auto Image Density Level Selection

Auto Image Density level can be adjusted to lighter or darker.

APS A5/5 1/2" x 8 1/2" Detection

Your service representative can set the copier to detect the original size on the exposure glass as A5 (for metric version) or 5 1/2" x 8 1/2" (for inch version) whenever the copier cannot detect it with Auto Paper Select.

APPENDIX

OTHERS

MAINTAINING YOUR MACHINE

To maintain high copy quality, clean the following parts and units regularly with a damp cloth and wipe them with a dry cloth.

Exposure glass

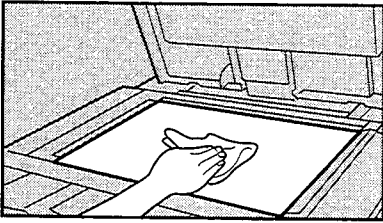

Platen cover

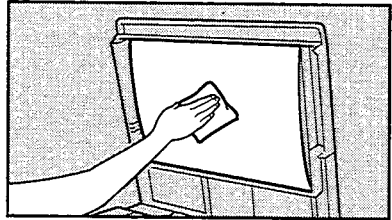

Document Feeder (Option)

Feed-in unit

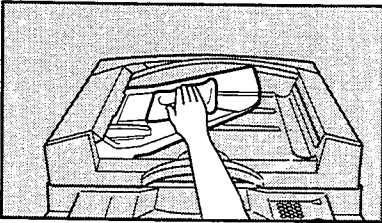

Belt

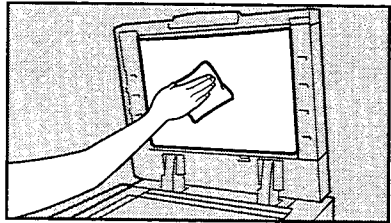

DO'S AND DON'TS

General Operations

- When using the bypass tray, paper should be set in the bypass tray lengthwise (☐).
- Do not place sheets of paper or originals on the cover of the large capacity tray.
- Do not move the machine when the main switch is turned on.
- Do not move the machine a few minutes after the main switch is turned off.

When Adding Toner

- Do not incinerate toner or toner containers. Toner dust might ignite when exposed to open flame.
- Dispose of the used toner bottle according to local regulations.
- When adding toner, do not turn off the main switch. If you do, your settings are cleared.
- Before setting the new toner, shake it well, at least 5 or 6 times.
- Do not remove the inner cap of the new toner bottle.

When Removing Misfed Paper

- Since some parts of the machine are supplied with high electrical voltage, touch only the parts specified in the instructions on the sticker inside the machine's cover.
- When removing misfed paper from sections B and C, use cautions. The fusing unit may be very hot.
- Do not leave any torn scrapes within the machine.
- When clearing misfeeds, do not turn off the main switch. If you do, your machine settings are cleared.
- After clearing misfeeds, make sure that all units and levers are returned to their original positions and all covers are closed.

Document Feeder (Option)

- While originals are fed from the original table to the exposure glass, do not pull out the originals.
- Do not lift the document feeder until the last original has been completely fed out.
- Do not press down or hold originals after inserting them.
- Do not press any parts of the document feeder strongly.

Finisher (Option)

- Do not remove papers from the shift tray while copying/printing.

PAPER TIPS

- If you get a lot of misfeeds, try turning over the paper stack in the 500-sheet or large capacity tray. If there is no improvement, change to paper with less curl.
- Load paper with the copy/print side *down* in the 500-sheet trays, and with the copy/print side up in the large capacity tray. If papers are curled, try turning the copy/print paper over in the tray. If there is no improvement, change the copy/print paper with less curl.

SCANNABLE AREA

Leading and side edges of the original image are not copied/scanned.

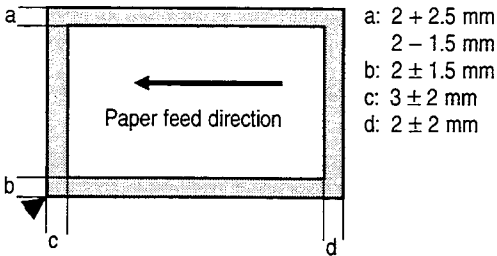

WHERE TO PUT YOUR MACHINE

Environment

The installation location should be carefully chosen because environmental conditions greatly affect the performance of a machine.

Optimum environmental conditions

- Temperature: 10 - 30 °C
- Humidity: 15 - 90 %
- A strong and level base.
- To avoid possible built-up of ozone, make sure to locate this machine in a large well ventilated room which has an air turnover of more than 30 m³/hr./person.
- The machine must be level within 5 mm both front or rear and left to right.

Environments to avoid

- Locations exposed to direct sunlight or strong light (more than 1,500 lux).
- Dusty areas.
- Areas with corrosive gasses.
- Places higher than 2,000 m above sea level.
- Places where the machine might be subjected to frequent strong vibration.
- Locations directly exposed to cool air from an air conditioner or heated air from a heater. (Sudden temperature changes might cause condensation within the machine.)

Power Connection

- Connect the machine to a power source meeting the specifications given on the inside from cover of this manual.
- Do not set anything on the power cord.
- Voltage must not fluctuate more than 10 %.
- Avoid multiwiring.
- Make sure that the wall outlet is near the machine and easily accessible.
- Make sure the plug is firmly inserted in the outlet.
- Always turn the machine off when you have finished using for the day, but leave it plugged in.

Access To The Machine

Place the machine near a power source, providing clearance as shown.

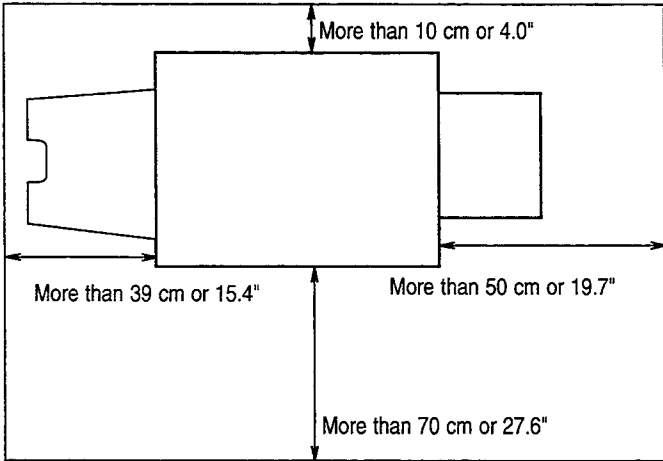

WHERE TO PUT YOUR MACHINE

With the optional finisher

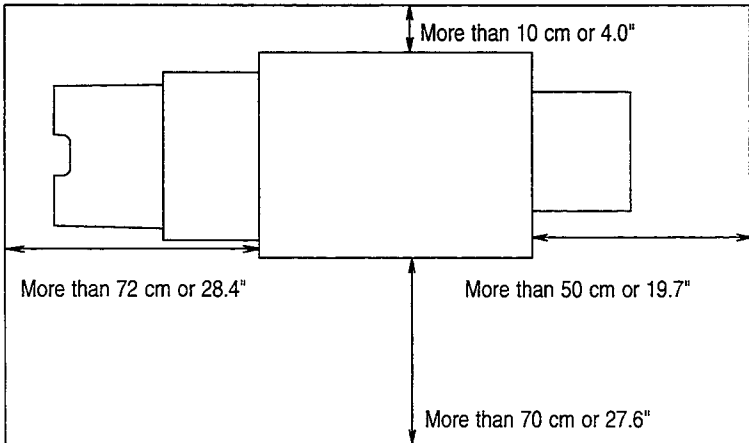

USE AND STORAGE OF SUPPLIES

Paper

- Paper of the types or in the conditions listed below are not recommended for this machine.
 - Folded, curled, creased, or damaged paper.
 - Torn paper
 - Damp paper
 - Perforated paper
 - Paper with conductive or low electrical resistance such as carbon or silver coating.
 - Wavy paper
 - Thermal paper, art paper
 - Thin paper that has low stiffness
- Use the bypass tray to copy/print onto OHP transparencies, adhesive labels, translucent paper, and post cards. Before making copies/prints onto them, read the following:
 - Adhesive labels should be fed from the bypass tray one sheet at a time.
 - OHP transparencies should be fed from the bypass tray. You can set ten sheets at a time. However, if misfeed or multi-feed occurs, set one sheet at a time.
 - OHP transparencies should be fanned to get air between the sheets before loading.
 - Translucent paper should be fed from the bypass tray.
 - Translucent paper should be fanned to get air between the sheets and any curls should be corrected before loading.
 - Post cards should be fed from the bypass tray.
 - It is recommended to feed one post card at a time.
 - Correct any curl in post cards before loading.
- For good copy/print quality, please use the type of OHP transparencies recommended by your sales and service representatives.
- When using the bypass tray, the large capacity tray cannot be used.
- Do not touch paper if your fingers are wet or oily; finger prints may appear on the copy/print.
- Do not use paper that has been already copied/printed on.
- Do not set paper over the limit mark inside the tray.
- To avoid problems caused by curly papers, try turning over the paper stack in the 500-sheet or large capacity tray. If there is no improvement, change to paper with less curl.
- Load paper with the copy side down in the 500-sheet trays, and with the copy side up in the large capacity tray. If copies are curled, try turning the copy paper over in the tray. If there is no improvement, change the copy paper with less curl.

Paper Storage

Paper should always be stored properly. Improperly stored paper might result in poor image reproduction, creased copies, or paper misfeeds. Generally, avoid curling and absorption of moisture.

- Avoid storing paper in humid areas. Under high temperature and high humidity, or low temperature and low humidity conditions, store paper in a vinyl bag.
- Do not store paper where it will be exposed to heat.
- Store on a flat surface.
- Use older stock first.
- Do not lay heavy objects on paper.
- Keep open reams of paper in the package, and store as you would unopened paper.

Toner Storage

- Store toner bottles vertically in a cool, dark place.
- Never store toner where it will be exposed to heat.
- Do not lay heavy objects on toner bottles.

USE AND STORAGE OF SUPPLIES

SPECIFICATIONS

SPECIFICATIONS

Configuration:	Desktop
Process:	Dry electrostatic transfer system
Memory capacity:	approximately 1.7GB hard disk
Scanning method:	Flatbed solid state scanner
Resolution:	400 x 400 dpi
Gray scale:	256 levels
Originals:	Sheet, book
Original thickness:	less than 30 mm, 1.18"
Original size:	Maximum: A3, 11" x 17"
Copying speed:	40 copies/minute (A4 □, 8 1/2" x 11" □, in Full Size mode)
Warm-up time:	less than 140 seconds (20°C, 68°F)

* Refer the Copier Reference for details.

PRINTER

Resolution:	300, 400*, 600 dpi (* 400dpi is available only when using the Postscript.)
Speed:	40 ppm (300dpi), 20ppm (600dpi)
Interface:	Standard Centronics compatible Standard RS232C
Options:	1000 sheet tray unit 1500 sheet tray unit Finisher bin 3-bin sorter Network Interface Card (Ether Net, Token Ring) Postscript Kit

* Refer the Printer Reference for details.

SCANNER

Resolution: 400 dpi (100 to 1600 dpi internal conversion)
Grayscale: 256 levels
Interface: SCSI 2

* Refer the Scanner Reference for details.

GENERAL

Power consumption:

	Copier only	Full system*
Warm-up	less than 0.88 kW	less than 0.90 kW
Stand-by	less than 0.20 kW	less than 0.22 kW
Maximum	less than 1.50 kW	less than 1.50 kW

* Full system: copier with document feeder, finisher, and paper tray unit

Noise emission:

Sound pressure level (The measurements are made according to ISO 7779 at the operator position)

Dimensions:

	Width	Depth	Height
with platen cover, copy tray, and paper tray unit	1,150 mm 45.3"	655 mm 25.8"	1,024 mm 40.4"
with document feeder, finisher, and paper tray unit	1,551 mm 61.1"	655 mm 25.8"	980+130mm 43.8"
with document feeder, 3-bin sorter, and paper tray unit	1,300 mm 51.2"	655 mm 25.8"	1,110 mm 43.8"

Weight:

with platen cover, copy tray, and 1500-sheet paper tray unit	137.5 kg 303.2 lb
with document feeder, finisher, and 1500-sheet paper tray unit	178.5 kg 393.6 lb
with document feeder, 3-bin sorter, and 1500-sheet paper tray unit	161.0 kg 355.0 lb

Specifications are subject to change without notice.

DOCUMENT FEEDER (OPTION)

Original feed: Automatic reverse document feed (ARDF)
two-sided originals mode
Automatic document feed (ADF)
one-sided originals mode
Semi-automatic document feed (SADF)
Single copies mode

Original size & weight:

Number of originals to be set:

Paper weight (g/m ²)	40	47	53	64	81	105	128	
Paper weight (lb)	11	12.5	14	17	22	28	34	
Maximum number of originals to be set	50	50	50	50	50	30	25	
A3	lengthwise	☆	☆	○	○	○	○	☆
A4	lengthwise	☆	☆	○	○	○	○	☆
	sideways	☆	☆	●	●	●	●	★
A5	lengthwise	☆	☆	○	○	○	○	☆
	sideways	☆	☆	●	●	●	●	★
B4	lengthwise	☆	☆	○	○	○	○	☆
B5	lengthwise	☆	☆	○	○	○	○	☆
	sideways	☆	☆	●	●	●	●	★
B6	lengthwise			☆	☆	☆	☆	☆
	sideways	☆	☆	★	★	★	★	★

●: ARDF (2 sided originals), ADF (1 sided originals), SADF, Single copies mode

○: ARDF, ADF, SADF

★: ADF, SADF, Single copies mode

☆: ADF, SADF

Original set: Copier: Face up, first sheet on top
Scanner: Face up/down

Original transport: One flat belt

Power consumption: DC 24V ± 10 % (from copier)

Power consumption: 45 W

Weight: Approximately 10.5 kg, 23.2 lb

Dimensions (W x D x H): 610 x 507 x 130 mm, 24.1" x 20.0" x 5.2"

□ Specifications are subject to change without notice.

FINISHER (OPTION)

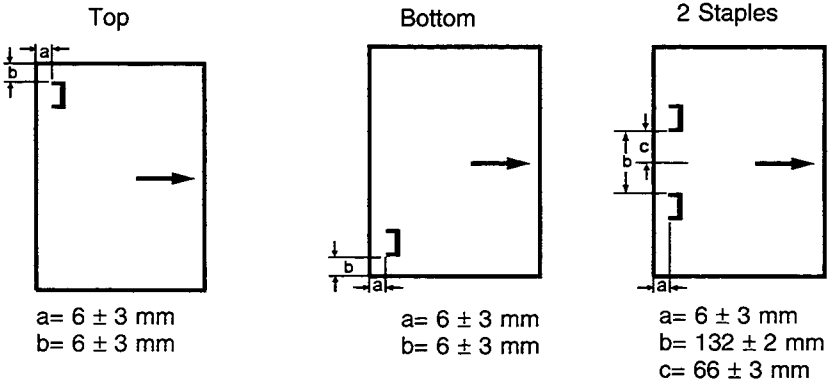

Staple replenishment: Cartridge exchange (5,000 pieces/cartridge)

Power source: DC 24V (from the main body)

Power consumption: 48 W

Weight: 35 kg, 77.2 lb

Dimensions (W x D x H): 671 x 514 x 950 mm, 26.5" x 20.3" x 37.5"

□ Specifications are subject to change without notice.

3-BIN SORTER

Paper capacity:	1st bin: 500 sheets (A4, 80g/m ²) 2nd bin: 250 sheets (A4, 80g/m ²) 3rd bin: 250 sheets (A4, 80g/m ²)
Power consumption:	30W
Power source:	DC 24V, DC5V (from the main body)
Dimensions (W x D x H):	468 x 483 x 490 mm, 18.5" x 19.1" x 19.4" (maximum)
Weight:	13 kg

Specifications are subject to change without notice.

1000-SHEET TRAY UNIT (OPTION)

Paper size:	☛ See page 41.
Paper weight:	52 - 105 g/m ² (14 lb - 28 lb)
Paper capacity:	1,000 sheets (500 sheets (80 g/m ²) for each tray)
Power source:	DC 24V, 5V, AC 120V (from copier)
Power consumption:	Average: less than 50 W (copying) Maximum: less than 110.5 W (copying)
Weight:	Approximately 36 kg, 79.4 lb
Dimensions (W x D x H):	620 x 632 x 390 mm, 24.5" x 24.9" x 15.4"

Specifications are subject to change without notice.

1500-SHEET TRAY UNIT (OPTION)

Paper size:	☛ See page 41.
Paper weight:	52 - 105 g/m ² (14 lb - 28 lb)
Paper capacity:	1,500 sheets (500 sheets (80 g/m ²) for each tray)
Power source:	DC 24V, 5V, AC 120V (from copier)
Power consumption:	Average: less than 50 W (copying) Maximum: less than 110.5W (copying)
Weight:	Approximately 38 kg, 83.8 lb
Dimensions (W x D x H):	620 x 632 x 390 mm, 24.5" x 24.9" x 15.4"

Specifications are subject to change without notice.

1500-SHEET TRAY UNIT (OPTION)

INDEX

INDEX

Index

!

paper56
 1000-sheet tray unit65
 1500-sheet tray unit65, 66
 3-BIN SORTER64
 [Cancel] key43
 [Exit] key43
 [Menu] key43
 [Next] key43
 [Prev.] key43

A

A3, 11" x 17" Double
 Count48
 ADF19, 20
 ADF: Thin Paper Mode46
 APS A5/5 1/2" x 8 1/2"
 Detection48
 Auto Image Density Level
 Selection48
 Auto Reset44
 Auto Response (Human)
 Sensor44
 auto response sensor5
 Auto Stamping
 (for metric version)48
 Auto Tray Switching46

B

Basic Settings44
 ADF: Thin Paper Mode46
 Auto Reset44
 Auto Response (Human)
 Sensor44
 Auto Tray Switching46
 Copy count display44
 Low Power Timer44
 Operation panel beeper44
 Original: /F4 Size Setting46

Paper Size SettingTray
 2, 3, and 4(option) 45
 Paper Tray Priority 46
 Paper Type Display 45
 Set date/Set time 44
 Set User Code(s) 47
 Tray 1 * Paper Size
 Setting 45
 Tray 1 /F4 Paper Size
 Setting 45
 bypass tray 5

C

CAUTION i
 CHANGING PAPER SIZE ... 36, 37, 38,
 39, 40, 41
 Clear Modes/Low Power
 Mode key 6, 11
 Clear/Stop key 7
 Contrast Dial 6
 copier 60
 Copy count display 44
 copy paper, loading 26, 27, 28
 copy tray 3, 5

D

DO'S AND DON'TS 51, 52
 document feeder 3, 52, 62
 duplex unit 5

E

Enter key 7
 exposure glass 5

F

finisher 3, 52, 63
 front cover 5
 fusing unit 5

G

GENERAL61

H

hard keys6

How To Use The Operation
Panel8**I**

installation environments54, 55

Interrupt key6

J

Job Recall key6

K

key counter holder5

L

large capacity tray5

large capacity tray, loading
paper28

LCT Paper Size Change48

Low Power mode11

Low Power Timer44

M

main switch5, 11

MAIN UNIT AND
OPTIONS3, 4, 5MAINTAINING YOUR
COPIER50

misfeeds31, 32, 33

N

Number keys7

O

operation panel5, 6, 7, 8, 9

hard keys6

Operation panel beeper44

Original: /F4 Size Setting46

originals18

originals, setting18

P

paper56

Paper Size SettingTray 2, 3,
and 4(option)45

PAPER TIPS53

paper tray5

Paper Tray Priority46

paper tray unit3

paper tray, loading paper27

Paper Type Display45

paper, changing size

1st tray36

optional tray unit41

paper, loading26, 27, 28

platen cover5

PRINTER60

Printer Mode9

Program key6

S

SADF21, 22

SAFETY INFORMATIONi

SCANNABLE AREA53

SCANNER61

Scanner Mode9

Set date/Set time44

Set User Code(s)47

specifications

1000-sheet tray unit65

1500-sheet tray unit65, 66

copier60

document feeder62

finisher63

INDEX

staples, adding30
staples, jammed34
STARTING THE
MACHINE 11, 12
SWITCHING BETWEEN
THE PRINTER, COPIER
AND SCA13, 14, 15, 16

T

toner57
toner bottle5
toner, adding29
Touch Panel Display6
Tray 1 * Paper Size
Setting45
Tray 1 /F4 Paper Size
Setting45
TROUBLESHOOTING24, 25
 jammed staples34
 misfeeds31, 32, 33

U

User Code mode12
User Tools42, 43, 44,
45, 46, 47, 48
 Basic Settings44
User Tools key6

W

WARNINGi
WHERE TO PUT YOUR
COPIER54, 55

SAVIN CORPORATION

Southeast Regional Office
1670 Oakbrook Drive
Suite 350
Norcross, GA 30093
404-446-1227

333 Ludlow Street
Stamford, CT 06904

Western Regional Office
4201 Spring Valley Road
Suite 1106
Dallas, TX 75244
214-392-9750

Central Regional Office
222 North LaSalle
Suite 830
Chicago, IL 60601
312-987-4230

Printed in Japan
UE (USA) A1958507

2853

Free Manuals Download Website

<http://myh66.com>

<http://usermanuals.us>

<http://www.somanuals.com>

<http://www.4manuals.cc>

<http://www.manual-lib.com>

<http://www.404manual.com>

<http://www.luxmanual.com>

<http://aubethermostatmanual.com>

Golf course search by state

<http://golfingnear.com>

Email search by domain

<http://emailbydomain.com>

Auto manuals search

<http://auto.somanuals.com>

TV manuals search

<http://tv.somanuals.com>