

Read this manual carefully before you use the product and keep it handy for future reference. For safe and correct use, please be sure to read the Safety Information in "Safety Information" before using the machine.

1 Where to Put the Printer

The printer's location should be carefully chosen because environmental conditions greatly affect its performance.

Warning

- Confirm that the wall outlet is near the machine and freely accessible, so that in event of an emergency, it can be unplugged easily.
- Only connect the machine to the power source described on this manual.
- Avoid multi-wiring.
- Do not damage, break or make any modifications to the power cord. Do not place heavy objects on it, pull it hard or bend it more than necessary. These actions could cause an electric shock or fire.
- The supplied power cord is for use with this equipment only. Do not use with other appliances. Doing so may result in fire, electric shock, or injury.

Caution

- Do not handle the plug with wet hands. Doing so might cause an electrical shock.
- Keep the machine in an area that is within optimum environmental conditions. Operating the machine in an environment that is outside the recommended ranges of humidity and temperature can cause an electrical fire hazard. Keep the area around the socket free of dust. Accumulated dust can become an electrical fire hazard.
- Place the machine on a strong and level surface. Otherwise, it might fall and injure someone.
- If you use the machine in a confined space, ensure there is continuous air circulation.

Space Required for Installation

Leave enough space around the printer. This space is necessary to operate the printer. The recommended (or minimum) space requirements are as follows:

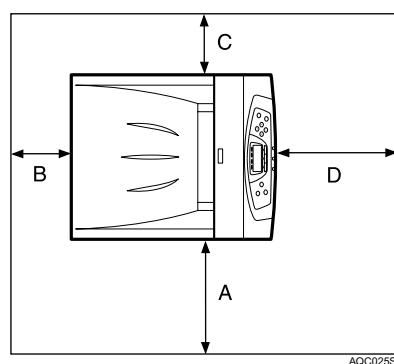

- A: 50 cm (19.7 inches) or more
- B: 10 cm (4 inches) or more
- C: 10 cm (4 inches) or more
- D: 70 cm (27.6 inches) or more

Optimum Environmental Conditions

Permissible and recommended temperature and humidity ranges are as follows:

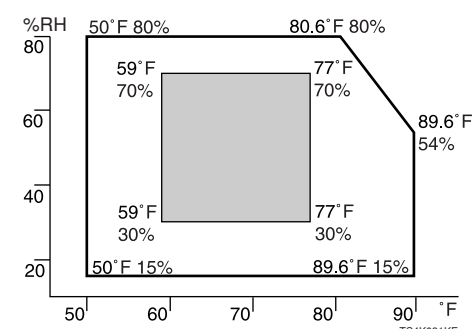
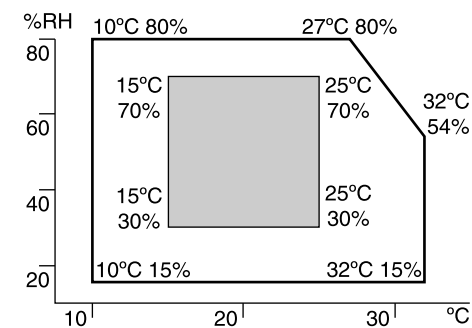

- White area: Permissible Range
- Gray area: Recommended Range

Note

- The machine must be level within 5 mm, 0.2" from both front to rear and left to right.
- To avoid possible build-up of ozone, locate this machine in a large well ventilated room that has an air turnover of more than 30 m³/hr/person.
- When you use this machine for a long time in a confined space without good ventilation, you may detect an odd smell. To keep the workplace comfortable, we recommend you keep it well ventilated.

Space Required for Installation

Important

- Areas exposed to direct sunlight or strong light
- Dusty areas
- Areas with corrosive gases
- Areas that are excessively cold, hot, or humid
- Locations near air conditioners or humidifiers
- Locations near other electronic equipment
- Locations subject to frequent strong vibration

Power Source

Connect the power cable to a power source of the following specification:

- 120 V, 60 Hz, 11 A or more

2 Checking the Contents of the Box

Follow the procedure below to verify the items that come with the printer.

Important

- Ensure that the box contains all items listed below. If there are any missing or defective items, contact your sales representative.

Manuals and CD-ROMs

- Quick Installation Guide (This manual)
- CD-ROM "Printer Drivers and Utilities"
- CD-ROM "Manuals"
- CD-ROM "Document Management Utility"

- Ferrite Core x 2

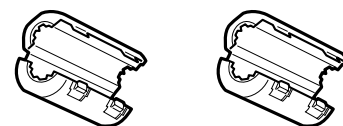

- Toner Cartridges: Black (K), Magenta (M), Cyan (C), Yellow (Y)

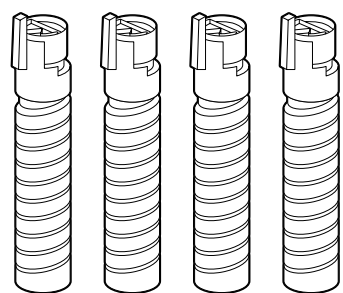

- Paper Feed Unit Labels

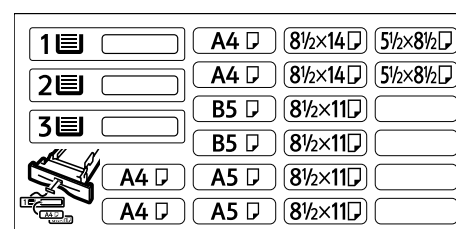

- Color Calibration Sample Sheet

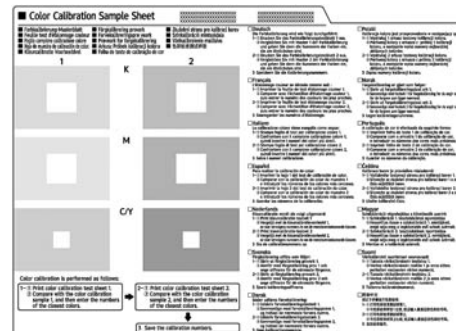

- Additional Documentation

Note

- This package does not include an interface cable. Purchase one to use with your host computer. See "Appendix", Hardware Guide.

3 Unpacking

To protect it from shock and vibration during transit, this printer comes packaged in cushioning foam and secured with tape. Remove these protective materials after bringing the machine to where it will be installed.

Caution

- When lifting the machine, use the inset grips on both sides. The printer could break or cause an injury if dropped.
- Place no objects on the left or inner cover.

Important

- Be sure to remove all four strips of tape from the photo conductor unit to avoid malfunction.
- Removed tape is dirty. Be careful not to let it touch your hands or clothes.

1 Remove the plastic bag.

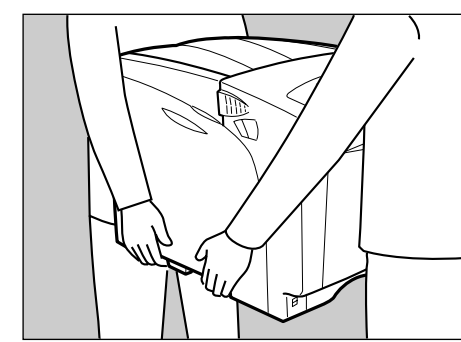

2 Lift the printer with two people by using the inset grips on both sides of the printer.

Important

- Leave the tape holding the paper feed tray and cover in place while moving the printer.
- Lower the machine slowly and carefully to prevent trapping your hands.

3 Remove the orange adhesive tape from the printer body.

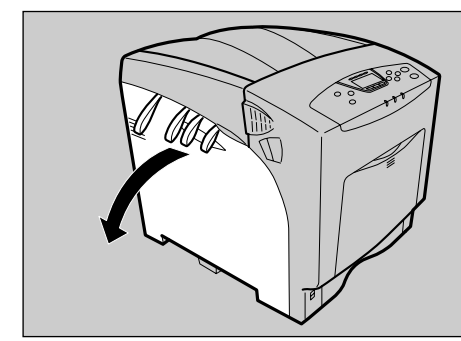

4 Open the left cover. Do not remove the orange tape attached to the left cover.

5 Turn the two green levers counterclockwise (1), and then slowly open the inner cover (2).

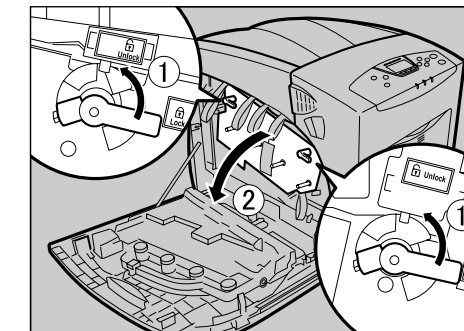

6 Remove the end of the tape from the printer.

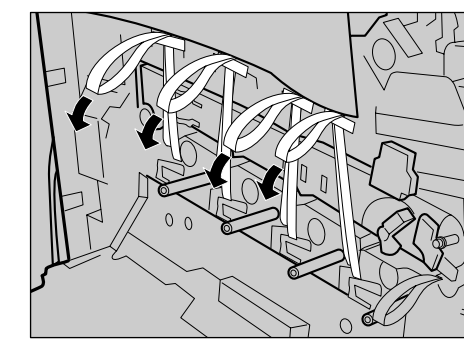

7 Remove the four pieces of tape from the photo conductor unit.

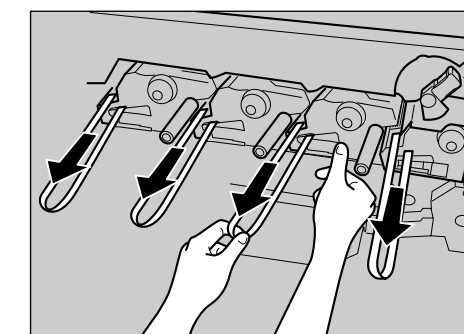

8 Remove the securing pin, as shown, from the transfer unit. Pinch it, and then pull it out.

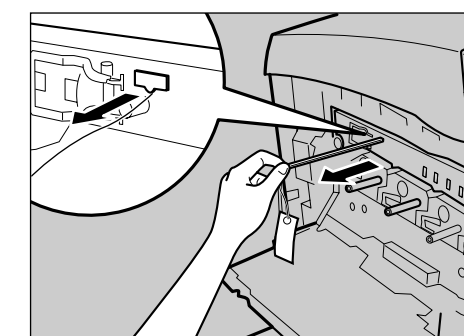

9 Turn the green lever of the transfer unit counterclockwise to unlock the unit.

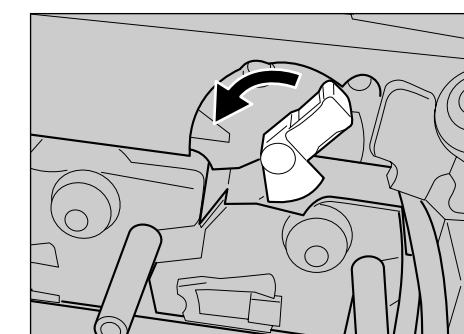

10 Remove the protective sheet, as shown. Pinch the orange tape, and then pull it out.

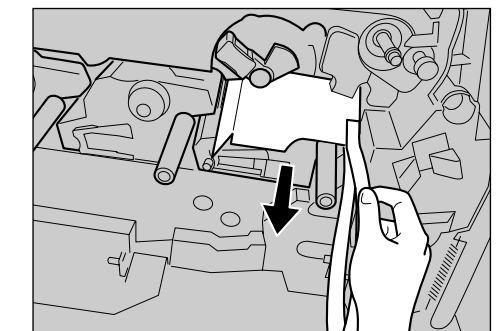

11 Turn the green lever clockwise to lock the unit.

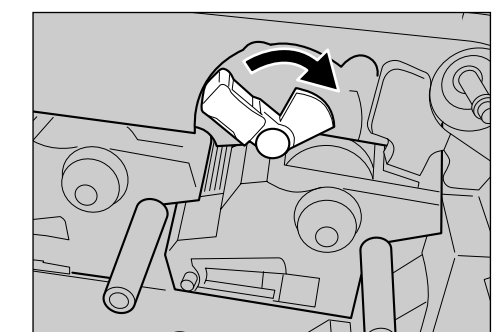

12 Close the inner cover. Lock the inner cover by pressing in (1) and then turning the two green levers clockwise (2).

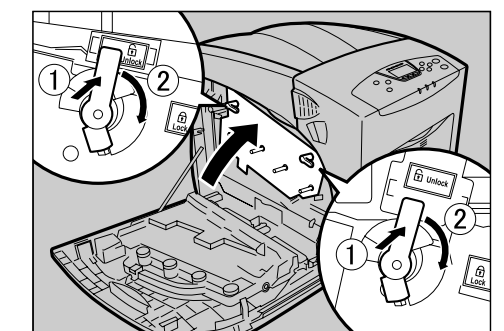

13 Close the left cover. Close the left cover firmly using both hands, until it clicks into place.

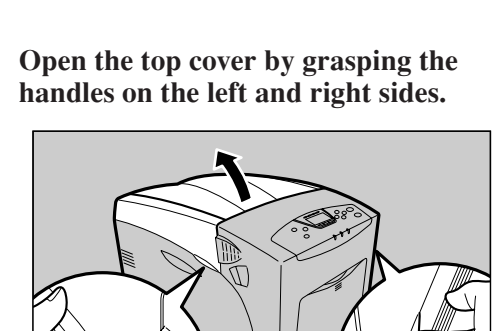

14 Open the top cover by grasping the handles on the left and right sides.

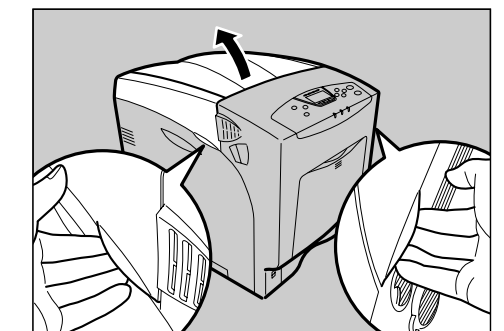

15 Be sure to remove the caution sheet, which is put on the toner cartridge's compartment.

16 Remove the tapes and cover as shown.

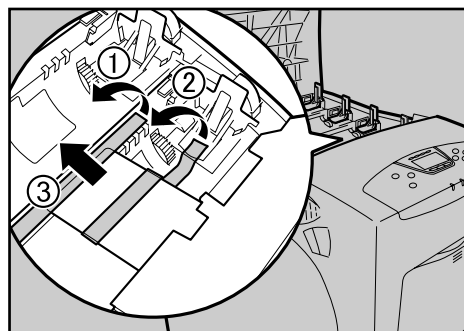

17 Remove the clips protecting the mouths of all four toner cartridges.

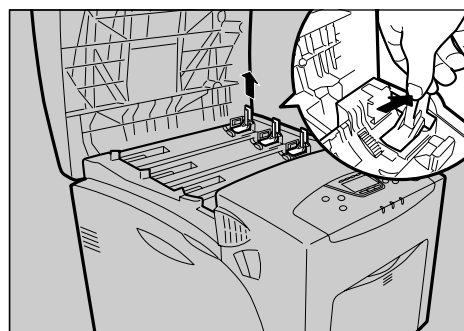

18 Put labels "1" on the front of the paper tray.

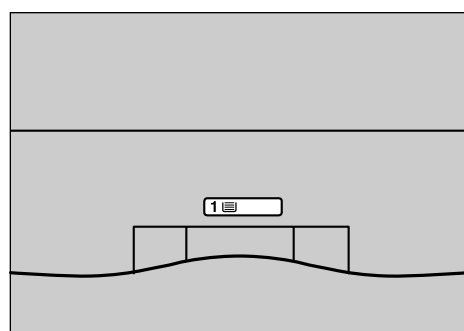

19 Be sure to read the label, which is attached on the front surface of the printer. This warns you that ink-jet paper cannot be used with this printer.

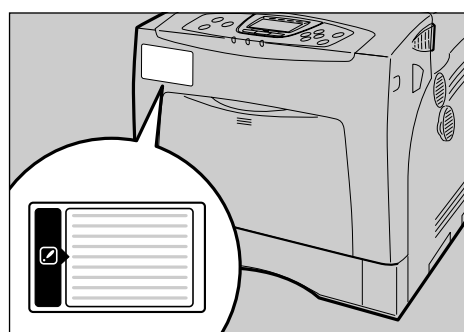

4 Installing the Toner Cartridge

The following procedure describes how to install the toner cartridge.

Warning

- Do not incinerate spilled toner or used toner. Toner dust is flammable and might ignite when exposed to an open flame. Disposal should take place at an authorized dealer or an appropriate collection site. If you dispose of the used toner cartridges yourself, dispose of them according to local regulations. Do not store toner, used toner, or toner containers in a place with an open flame. The toner might ignite and cause burns or a fire.

Caution

- Keep ink (used or unused) and ink containers out of reach of children.
- If toner or used toner is inhaled, gargle with plenty of water and move into a fresh air environment. Consult a doctor if necessary.
- If your skin comes into contact with toner or used toner, wash the affected area thoroughly with soap and water.
- If toner or used toner gets into your eyes, flush immediately with large amounts of water. Consult a doctor if necessary.

Caution

- If toner or used toner is swallowed, dilute by drinking a large amount of water. Consult a doctor if necessary.
- Avoid getting toner on your clothes or skin when removing a paper jam or replacing toner. If your skin comes into contact with toner, wash the affected area thoroughly with soap and water.
- If toner gets on your clothing, wash with cold water. Hot water will set the toner into the fabric and may make removing the stain impossible.

Important

- When you first use this printer, use the four toner cartridges supplied with the printer.

Note

- The toner cartridges that comes with the printer will allow you to print up to about 3,000 pages. These numbers were obtained from printing A4 5% charts, but the actual number of pages will vary depending on the paper type, size, contents, and settings.
- The toner cartridge for replacement comes in two types for different number of printable pages: 15,000 pages and 5,000 pages.
- Toner Cartridges (consumable) are not covered by warranty. However, if there is a problem, contact the dealer where you purchased the printer.
- Toner cartridge mouths may become dirty during quality inspection.

1 Take the toner cartridges out of the box.

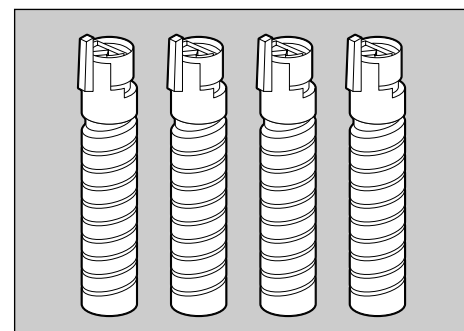

2 Shake the toner cartridge up and down seven or eight times.

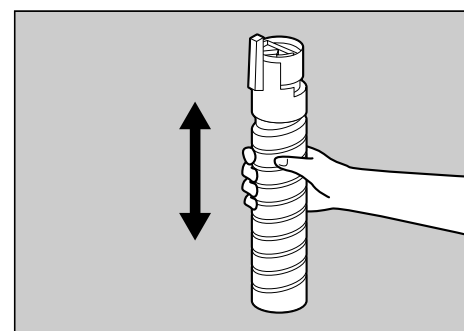

3 Remove the tape holding the toner cartridge.

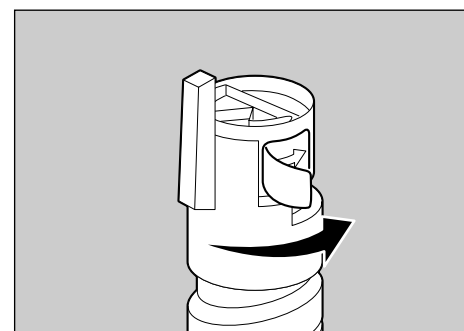

4 First, install the yellow toner cartridge. Holding the toner cartridge horizontally (1) with the locking lever on the upper side, install the toner cartridge bottom first, and then move the locking lever to the triangle mark (2).

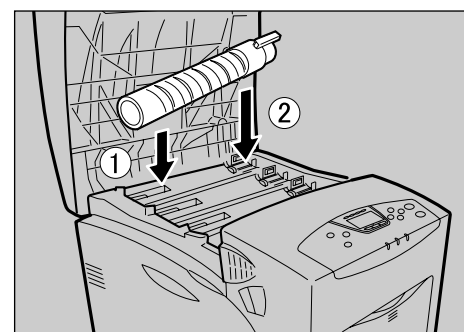

5 Turn the locking lever to the circle mark. Pull the locking lever toward you, until it locks and clicks into place.

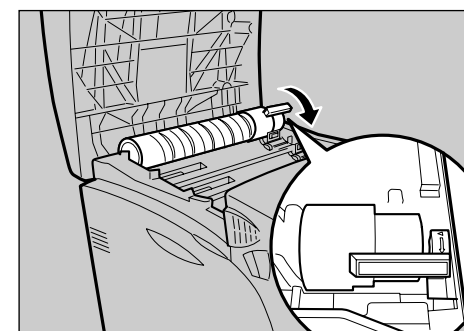

Important

- Do not repeatedly insert and remove toner cartridges. Doing so results in toner leakage.

6 Use the same procedures to insert the remaining three toner cartridges: cyan (C), magenta (M), and black (K).

7 Close the top cover.

Important

- Do not turn off the power switch while "Loading Toner..." appears on the display. Doing so results in malfunction.

5 LOADING PAPER

The following describes how to load paper into the standard paper tray (Tray 1).

Caution

- Do not pull out the paper tray forcefully. If you do, the tray might fall and cause an injury.

Important

- To avoid paper jams, make sure paper is not stacked above the limit mark inside the tray. Misfeeds might occur.
- Do not mix different types of paper in a single paper tray.

1 Slowly slide out the paper tray (Tray1), until it stops. Then, lift it slightly, and then pull it out completely.

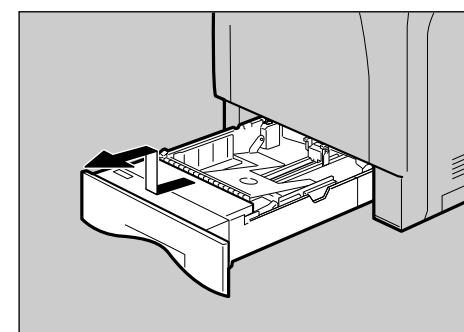

Place it on a flat surface.

2 Pinch the green clips of the side guide and the end guide and adjust the guides to the paper size being loaded.

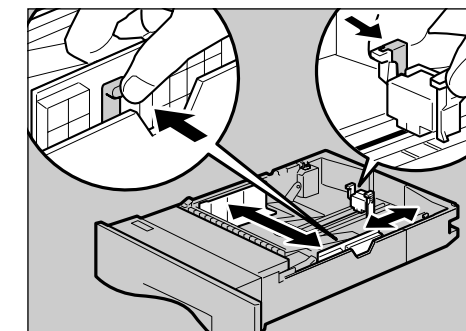

3 Slide the green switch on the front of the tray to the type of paper to be loaded. When loading paper of 75 g/m², 20 lb., or thicker, slide the switch to the right.

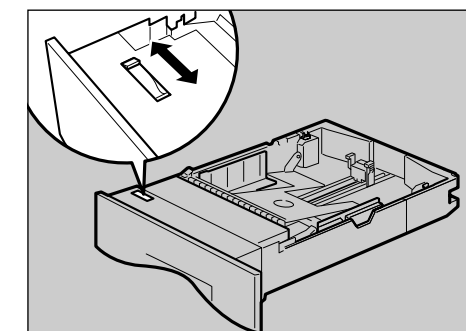

4 Load the new paper stack print side up, making sure the paper is flush against the paper guides. Adjust the paper guides to close any gaps.

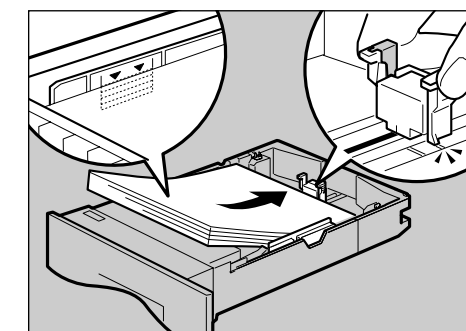

5 Lift the front of the paper tray (Tray 1), and slowly slide the paper tray back, until it stops. Make sure the tray is fully inserted to prevent paper jams.

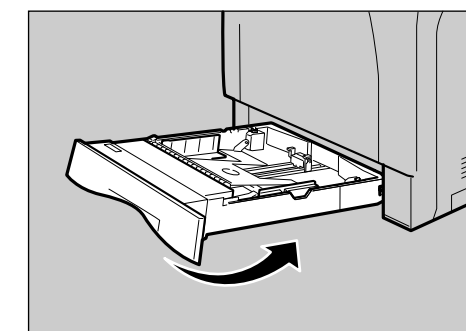

Reference

- For details about usable types of paper, see "Loading Paper", Hardware Guide.

6 Turning the Power On

Follow the procedure below to turn the power on.

Warning

- Plug and unplug the power cable with dry hands, or an electric shock could occur.

1 Make sure the power switch is set to "Off".

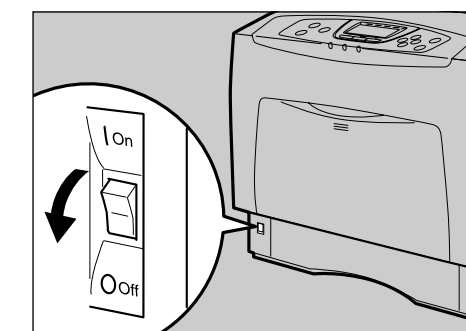

2 Plug in the power cable.

Important

- Make sure the power cable is plugged securely into the wall outlet.
- Turn the power switch off when plugging and unplugging the power plug.

3 Turn the power switch to "On".

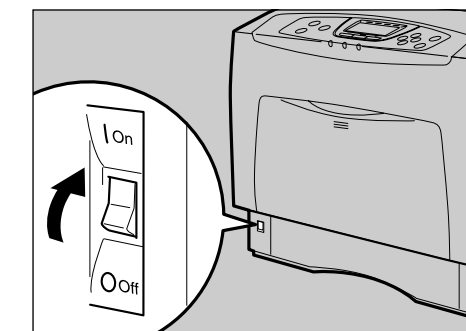

The power indicator on the control panel lights up.

Note

- Wait until "Ready" appears on the display panel.
- The machine may make a noise while initializing. This noise does not indicate a malfunction.

Important

- Do not turn off the power switch until initializing is completed. Doing so results in malfunction.

7 Selecting the Display Language

Select a language using the procedure described here. The message for the selected language will appear on the display. If you want to use the display in English, the following procedures are unnecessary.

Note

- The default setting is English.

1 Press the [Menu] key.

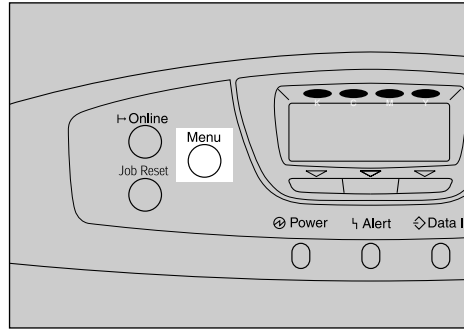

AQC0015

2 Select [Language] using [▼] or [▲], and then press the [OK] key.

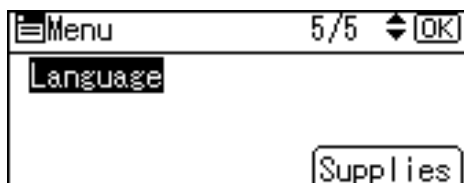

3 Select the language using [▼] or [▲], and then press the [OK] key.

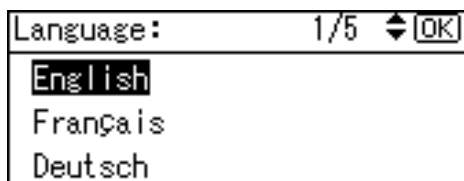

4 Press the [Menu] key to return to the initial screen.

8 Test Printing

The following explains the procedure for test printing of the configuration page.

Test printing in order to verify that the printer is working normally. Test printing checks printer performance only; it does not test the connection to the computer.

1 Press the [Menu] key.

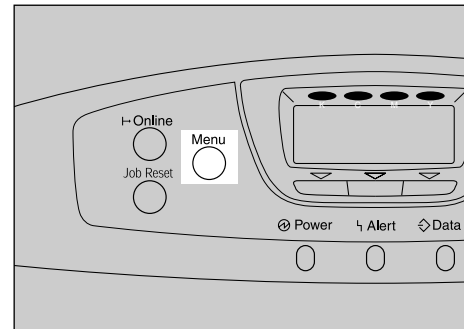

AQC0015

2 Select [List/Test Print] using [▼] or [▲], and then press the [OK] key.

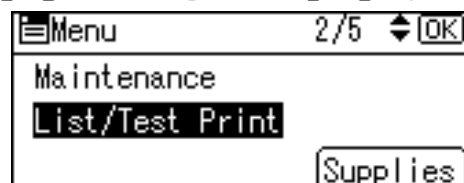

3 Select [Config. Page] using [▼] or [▲], and then press the [OK] key.

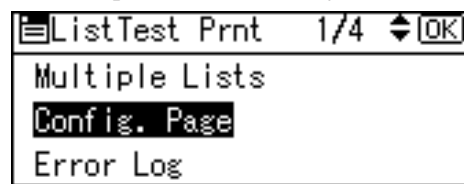

The configuration page will be printed.

If printing is not normal, check to see if an error message appears on the display. If there is an error message, see "Troubleshooting", Hardware Guide.

4 Check the options.

For details about the configuration page, see "Interpreting the Configuration Page", Software Guide.

5 Press the [Menu] key to return to the initial screen.

9 Network Connection

Follow the procedure below to connect the printer to the computer through the network. Prepare the hub and other network devices before connecting the 10 BASE-T or 100 BASE-TX cable to the machine's Ethernet port.

Important

- Use shielded Ethernet cable. Unshielded cables create electromagnetic interference that could cause malfunctions.
- The Ethernet cable is not supplied with this machine. Select your cable according to the network environment.

1 Attach one ferrite core at the printer end of the Ethernet cable, and then attach the other ferrite core about 10 cm (4 inches) (1) from this core.

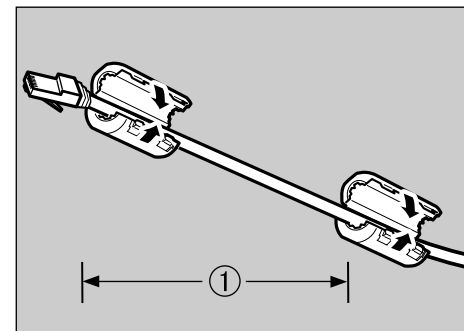

AET1215

2 Connect the Ethernet cable to the Ethernet port.

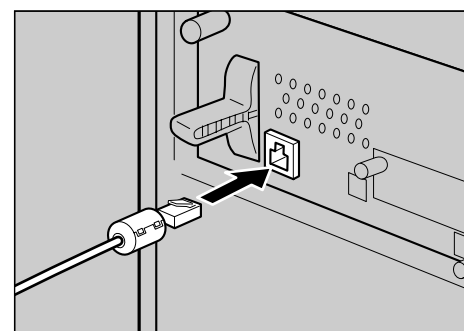

AET1225

3 Connect the other end of the cable to the printer's network, such as a hub.

Note

- The printer's ethernet and USB ports are not available when the gigabit ethernet board is attached to the printer.

Reference

- For details about network environment settings, see Software Guide.

Reading the LED Lamps

- For standard ethernet port

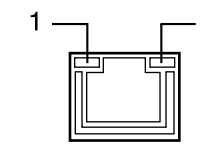

AQC0705

- Yellow: comes on when 100BASE-TX is being used. It comes off when 10BASE-T is being used.
- Green: comes on when the printer is properly connected to the network.

10 USB Connection

Important

- USB2.0 interface cable is not supplied. Obtain it separately, according to the computer you are using.
- USB connection is possible under Windows 98 SE/Me/2000/XP, Windows Server 2003, Mac OS 9.x, and Mac OS X.
- Windows 98SE/Me supports USB1.1 speeds.
- USB connection with Macintosh is only possible via the printer's USB port.

1 Connect the square-shaped connector of the USB2.0 cable to the USB port.

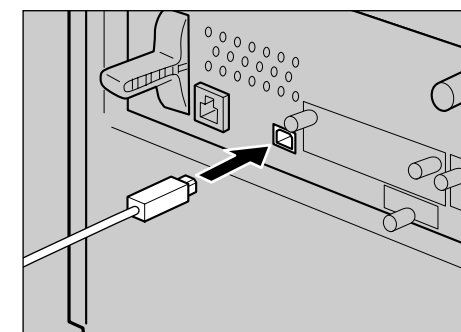

AET1245

2 Connect the opposite end's flat connector to devices such as your computer's USB interface, or a USB hub.

11 Ethernet Configuration

Make the following network settings according to the network interface you are using. You can use SmartDeviceMonitor for Admin or a Web browser to make IP address-related settings in a TCP/IP-capable environment.

Important

- Configure the printer for the network using the control panel.
- The following table shows the control panel settings and their default values. These items appear in the "Host Interface" menu.
- After configuring the network settings, making security settings is recommended. For details, see the "Notes to Administrator" sheet.

Setting Name	Value	
Auto-Obtain (DHCP)	On	
IPv4 Address	011.022.033.044	
Subnet Mask	000.000.000.000	
Gateway Address	000.000.000.000	
Frame Type (NW)	Auto	
Effective Protocol	IPv4	Effective
	IPv6	Effective
	NetWare	Effective
	SMB	Effective
	AppleTalk	Effective
Ethernet Speed	Auto	
LAN Type	Auto	

Note

- If Auto Obtain (DHCP) is in use, the IPv4 address, subnet mask, and gateway address are all set automatically.
- Make this setting only when it is necessary. See Software Guide.

Detecting the Network Address Automatically (Using DHCP)

Important

- When you use this printer in DHCP environment, select [Auto-Obtain (DHCP)] following this procedure.
- When [Auto-Obtain (DHCP)] is selected, you cannot make settings for the following items:
 - IP Address
 - Subnet Mask
 - Gateway Address
- Consult your network administrator for information about making network settings.

1 Press the [Menu] key.

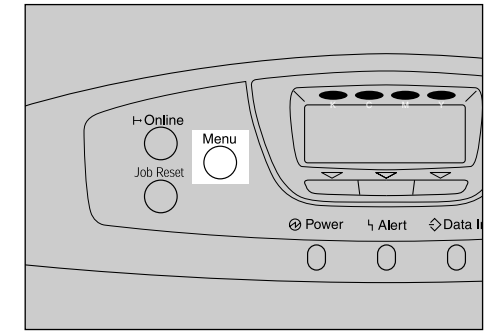

AQC0015

2 Select [Host Interface] using [▼] or [▲], and then press the [OK] key.

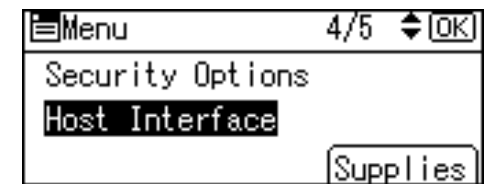

3 Select [Network] using [▼] or [▲], and then press the [OK] key.

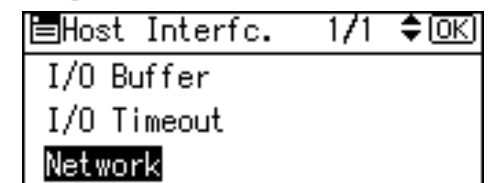

4 Select [Machine IPv4 Address] using [▼] or [▲], and then press the [OK] key.

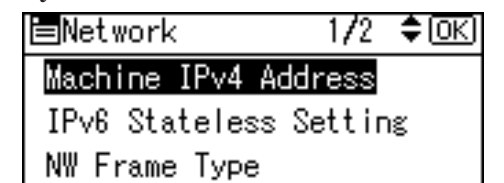

5 Select [Auto-Obtain (DHCP)] using [▼] or [▲], and then press the [OK] key.

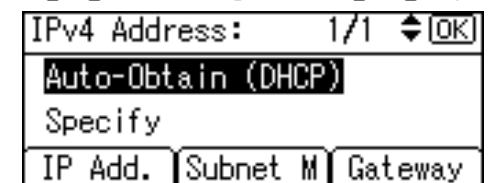

The address detected by the printer will appear. To check the detected addresses, press the followings:

- [IP Add.]: IP address
- [Subnet]: Subnet Mask

6 Press the [MENU] key to return to the initial screen.

7 Print a configuration page to confirm the settings made.

Reference

- For details about printing the configuration page, see "Test Printing".

Specifying a Network Address

1 Press the **[Menu]** key.

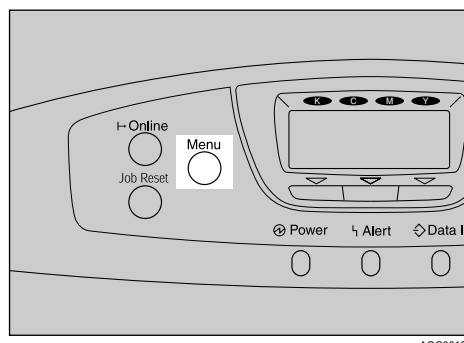

2 Select **[Host Interface]** using **[▼]** or **[▲]**, and then press the **[OK]** key.

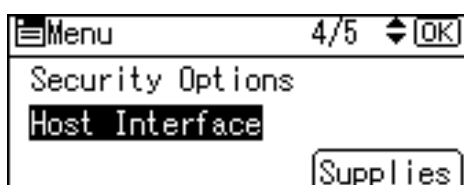

3 Select **[Network]** using **[▼]** or **[▲]**, and then press the **[OK]** key.

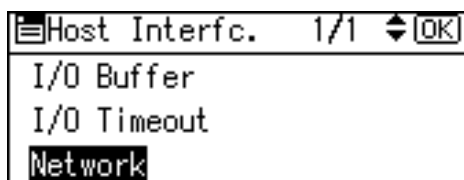

4 Select **[Effective Protocol]** using **[▼]** or **[▲]**, and then press the **[OK]** key.

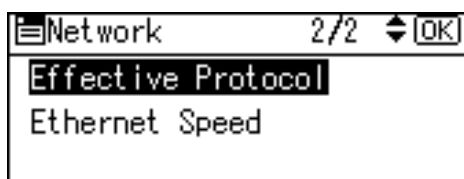

5 Select the network protocol using **[▼]** or **[▲]**, and then press the **[OK]** key.

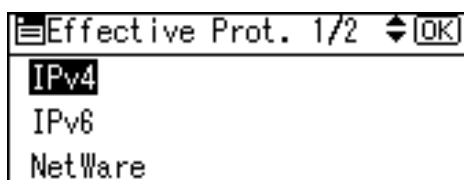

6 Select **[Effective]** or **[Invalid]** using **[▼]** or **[▲]**, and then press the **[OK]** key.

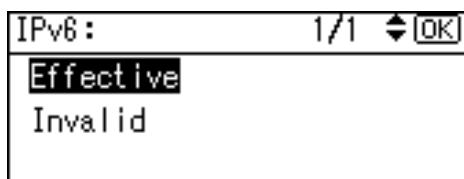

Set other protocols you need to set in the same way.

- Select **[Invalid]** for unused protocols.
- Enable IPv4 to use the Pure IPv4 environment of NetWare 5/5.1, NetWare 6/6.5.

7 Press the **[Escape]** key until the screen returns to the **[Network]** menu.

8 If you use IPv4, assign the IPv4 address to the printer. Select **[Machine IPv4 Address]** using **[▼]** or **[▲]**, and then press the **[OK]** key.

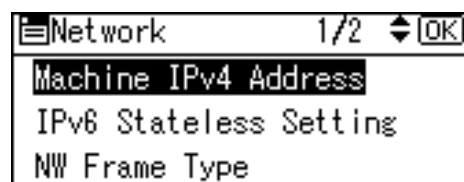

To get the IPv4 address for the printer, contact your network administrator.

9 To specify the IPv4 Address, press **[IP Add.]**.

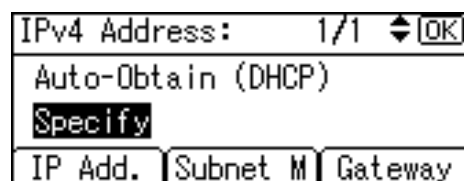

If you use IPv4, assign also Subnet Mask and Gateway Address. To assign these, press **[Subnet M]** or **[Gateway]** instead.

10 Enter the address using **[▼]** or **[▲]**, and then press the **[OK]** key. settings made.

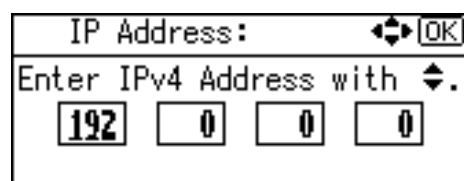

Press the **[▼]** or **[▲]** key to enter the left most entry field of the address. After entering the left field, press the **[OK]** key, and then you can enter the next field. After completing to enter in the all fields, press the **[OK]** key. Use this method to assign Subnet Mask and Gateway Address.

- Do not set "011.022.033.044" as the IPv4 address.
- The value moves by 10 if the **[▼]** or **[▲]** key is kept pressed.

11 Select **[Specify]** using **[▼]** or **[▲]**, and then press the **[OK]** key.

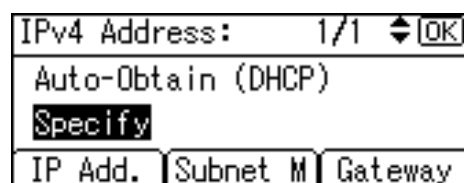

If you do not select **[Specify]** in this step, the address you set will not be saved.

12 Press the **[Menu]** key to return to the initial screen.

13 Print a configuration page to confirm the settings made.

Reference

- For details about printing the configuration page, see "Test Printing".

12 INSTALLING THE PRINTER DRIVER

You can install the printer drivers and software easily from the CD-ROM labeled "Printer Drivers and Utilities".

Click **[Quick Install]** in the window of the CD-ROM to install PCL and RPCS printer drivers. To install the PostScript 3 printer driver, click the **[PostScript 3 Printer Driver]** button. For more information about the PostScript 3 printer driver, see Software Guide on the CD-ROM labeled "Manuals".

When the TCP/IP protocol is used, SmartDevice Monitor for Client will be installed as well.

When using with TCP/IP protocol, confirm the followings:

- The printer is connected to a network with the 5 interface cable.
- The TCP/IP protocol is set.
- The IP (IPv4) address is set for the printer and the computer.

Important

- To install printer driver under Windows 2000/XP Professional, Windows Server 2003, and Windows NT 4.0, you must have an account that has Manage Printers permission. Log on as an Administrator.
- Only the printer driver, and not the SmartDevice Monitor for Client is installed when using this printer under USB or parallel. If you connect using USB, see Software Guide.

1 Quit all applications currently running.

2 Insert the CD-ROM into the CD-ROM drive.

The installer starts. Auto Run may not work with the certain operating system settings. If this happens, launch "Setup.exe" on the CD-ROM root directory.

3 Select an interface language, and then click **[OK]**.

The default interface language is English.



4 Click **[Quick Install]**. The software license agreement appears in the **[License Agreement]** dialog box.

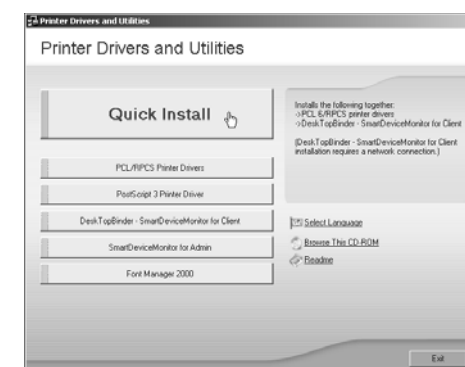

This is an example when English is selected in step 3.

5 After reading through all of the contents, click **[I accept the agreement]** to agree with the License Agreement, and then click **[Next >]**.



6 Select the printer model you want to install in the "Select Printer" dialog box.



Note

- For a network connection via TCP/IP, select the printer whose IP address is displayed in **[Connect to]**.
- For parallel connection, select the printer whose printer port is displayed in **[Connect to]**.

7 Click **[Install]**.

The following display appears while installing the printer driver.

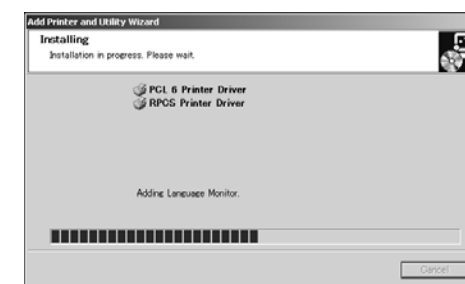

8 Click **[Finish]**. A message about restarting the computer may appear. Restart the computer to complete installation.

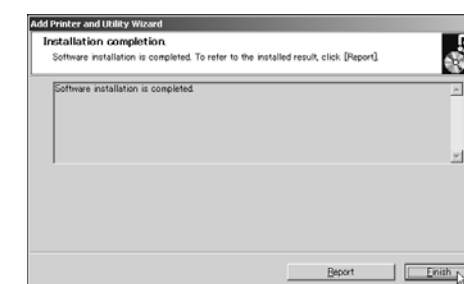

9 Click **[Exit]** in the first dialog box of the installer, and then take out the CD-ROM.



Note

- To stop installation of the selected software, click **[Cancel]** before installation is completed.
- Auto Run may not work with the certain operating system settings. If this happens, launch "Setup.exe" on the CD-ROM root directory.
- Select a printer to whose IP (IPv4) address is displayed in **[Connect To]** to install SmartDeviceMonitor for Client when using TCP/IP.

Reference

- Quick Install is not available unless bidirectional communication between the printer and computer is enabled via parallel connection. For details about bidirectional communication between printer and computer, see "Printing with Parallel Connection", Software Guide.

Free Manuals Download Website

<http://myh66.com>

<http://usermanuals.us>

<http://www.somanuals.com>

<http://www.4manuals.cc>

<http://www.manual-lib.com>

<http://www.404manual.com>

<http://www.luxmanual.com>

<http://aubethermostatmanual.com>

Golf course search by state

<http://golfingnear.com>

Email search by domain

<http://emailbydomain.com>

Auto manuals search

<http://auto.somanuals.com>

TV manuals search

<http://tv.somanuals.com>