

SCHLAGE

CYLINDERS, KEYS AND KEY CONTROL



IR Security & Safety
Proven Source. Proven Solutions.™

Patented Key and High Security Cylinder System

The Primus® system offers a new dimension in high security cylinders and key control. The system features a specially designed, patent protected key which operates a choice of Underwriters Laboratories Listed 20-500 series, Controlled Access 20-700 series and standard cylinders all in one integrated key system. Primus cylinders are compatible with Schlage's commercial grade locks. Multiple security levels are available to provide the choice of geographical exclusivity, key control, convenience, and service which best meets the demands of each installation.

Exploded View - Primus Mortise Cylinder

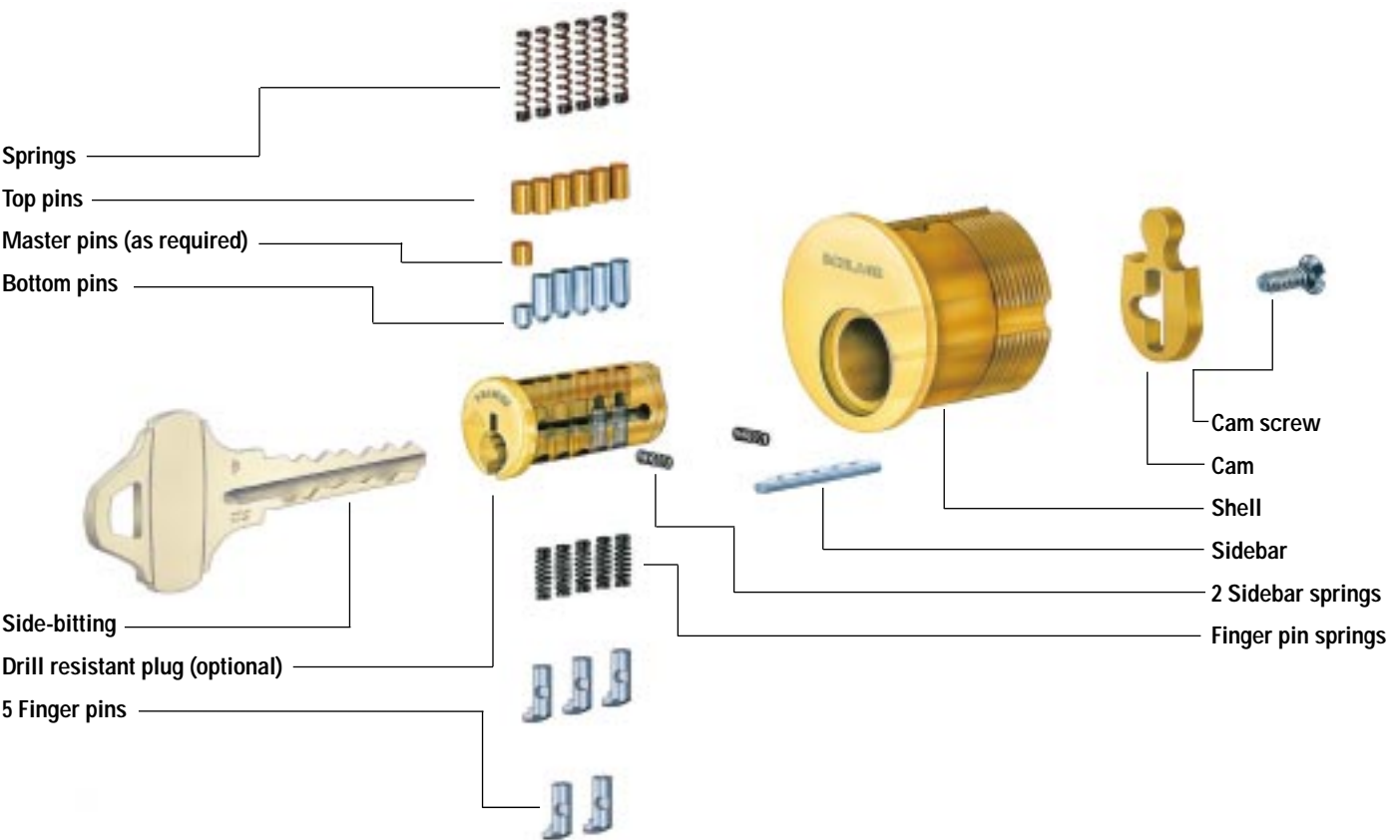

INDEX	
Authorization Forms	27
Bulk Pack Cylinder Kit	26
Classic Key and Keyways	22 - 23
Cylinders for Schlage locksets	8 - 17
Cylinders for Other Manufacturers' Locks	18 - 19
Cylinder Terminology	29
Everest Key and Keyways	20 - 21
Exploded View: Mortise Cylinder	ii
How to Order	28
I.D. Cards	27
Interchangeable Core	10 - 17
Multiple Tail Piece Cylinder	26
Performance Features	2
Security Levels	28
Service Equipment & Tolls	25
Small Format Key Blanks	24
Special Cams	9
Specifications	1

Specifications

Key Control Patents*:

Everest and Primus cylinders and keys are covered by one or more of the following U.S. utility patents:

4,756,177

4,815,307

5,715,717

5,809,816

For international Patent coverage information, please contact Schlage Commercial Customer Service.

Materials:

Cylinder plug and shell are brass. Bottom pins, finger pins, sidebar, and keys are nickel silver. Top pins and master pins are brass.

Standard Keying:

All Primus cylinders have six conventional pins and five finger pins. Everest C123 keyway standard with two keys per cylinder.

Keying Options:

Interchangeable core cylinders. Master keying, grand master keying, and construction keying.

Warranty:

Three-year limited.

Software:

Primus Cylinders can be used in conjunction with SITEMASTER 200® key control management software, for highly effective key control.

Certifications

ANSI:

20-500 High Security cylinder – A156.5, Grade 1.

20-700 Controlled Access cylinder – ANSI A156.5, Grade 1 Operational.

UL / ULC:

20-500 Series Primus cylinders are UL437 Listed Locking Cylinders.

**Any infringement of these patents will be forcefully defended in the courts of law by the Schlage Lock Company.*

Primus Flexibility

Unlike many other brands of high security cylinders, Schlage can easily integrate Primus UL 437 Listed cylinders, Primus Controlled Access cylinders, and Schlage conventional cylinders all into the same key system, and this happens with no adverse affects on keying capacity!

Primus keys will operate conventional cylinders but conventional keys will not operate Primus cylinders. You can secure exterior doors and sensitive areas with Primus cylinders and use conventional cylinders on the remaining doors. This cuts the cost of the overall job.

Security can be tailored to meet the exact needs of each door without sacrificing the convenience of having a single building master key.

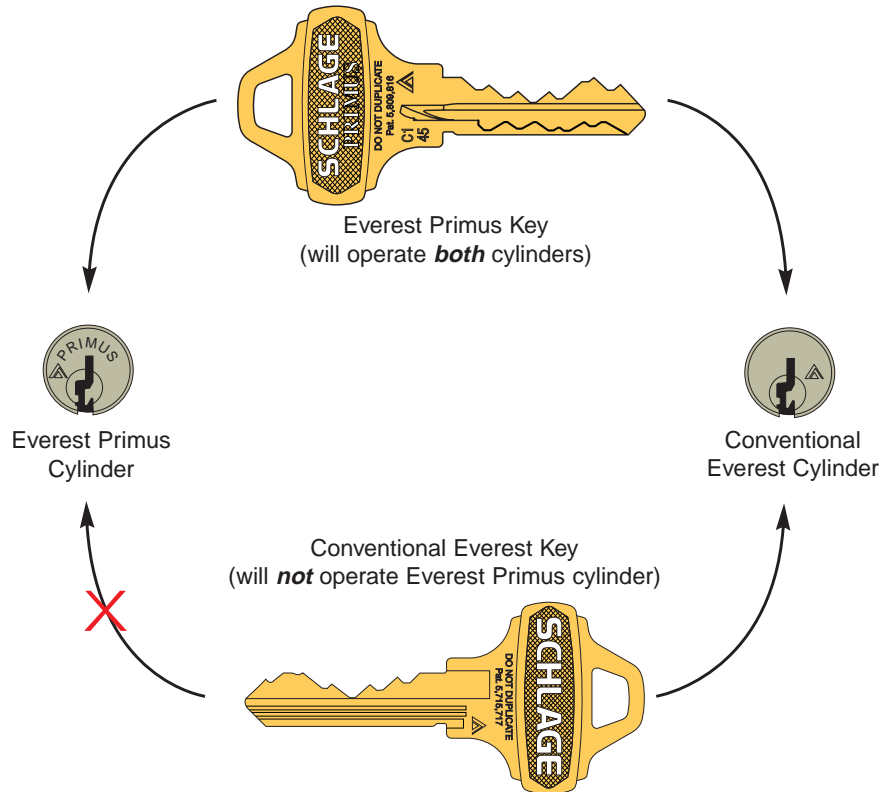

Note: Everest Primus keys are compatible with Everest C Family Open *or* Everest D Family Restricted key systems.

Performance Features

The Schlage Primus High Security cylinder is precision built to extremely close tolerances and the highest standards of quality. These “dual-locking” cylinders consist of two independent locking mechanisms, operated by a single specially designed Primus key. In addition to a standard 6 pin tumbler mechanism there is a locking sidebar which is independently controlled by a set of 5 fingerpins that interface with the side biting on the patented Primus key.

Primus cylinders are offered in two different versions. The 20-500 High Security series which is UL Listed and the 20-700 Controlled Access series which offers the same key control protection when UL Listed cylinders are not necessary. Both series are fully compatible in application and can be combined into the same master key system, along with other Schlage conventional cylinders. For added flexibility, all Primus cylinders can be retrofitted into existing Schlage locks as well as many competitive products.

Choose the Right Cylinder for Each Application

Conventional (Standard) Cylinders

Schlage® locks are provided with cylinders precision built to extremely close tolerances and the highest standards of accuracy. Using only solid brass bar stock plugs and shells, phosphor bronze springs, nickel silver keys and bottom pins, ensures long life and ease of operation.

6-pin Everest cylinders in C123 keyway with two patented keys are standard for stock. C145 is standard for new master key systems.

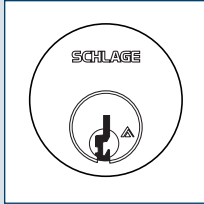

Interchangeable Core (IC) Cylinders

For use where fast rekeying by non-technical personnel is desired, Schlage Primus and conventional interchangeable cores offer a great blend of security and convenience. The special control key for the system is all that is required to remove the old core and install the new one. The core itself can be rekeyed with standard Schlage pin kits.



Unlike some other brands, Schlage interchangeable cores can always be integrated into existing systems with no adverse affect on the key system.

IC locks are especially well suited to chain stores and restaurants where frequent employee turnover requires immediate rekeying by store management.

Primus® High Security Cylinders

Primus high security cylinders are available to add patented key control and varying degrees of geographical exclusivity to most Schlage 6-pin key systems, whether Everest or Classic keyways.

In addition to a conventional pin tumbler mechanism, Primus cylinders incorporate a patented finger pin and sidebar design providing a “dual-locking” cylinder that is virtually pick-proof. Resistance to drilling and other physical attack is optional by specifying 20-500 Series UL437 Listed cylinders.



Primus® Lockout Cylinders

Available in rim and mortise cylinders only, Lockout cylinders are designed for doors where it is frequently desirable to disable all keys from operating the lock temporarily. The special *lockout key* can be removed while the plug is turned to the 11 o'clock position, preventing all normal operating keys, including master keys, from fully entering the cylinder.

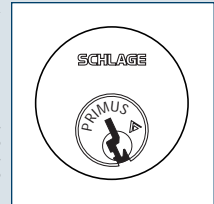

Suggested applications for lockout cylinders include laboratories, dark rooms, clean rooms, and exterior doors to dormitories.

Schlage will not master key lockout cylinders.

Cylinders for Schlage Locksets

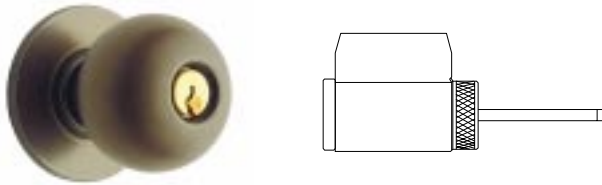

Cylinders for A-Series Knobs

Number	Description
21-002	6-Pin conventional cylinder (standard, non-Orbit)
21-002-122	6-Pin conventional cylinder (standard, Orbit design only)
20-724	Primus cylinder, non-Orbit
20-724-122	Primus cylinder, Orbit design only
20-524	Primus UL437 Listed high security cylinder, non-Orbit
20-524-122	Primus UL437 Listed high security cylinder, Orbit design only
21-003	Conventional hotel function (A85) with indicator, non-Orbit
21-003-168	Conventional hotel function (A85) with indicator, Orbit only

Available 606 and 626 finish only. Everest C123 keyway standard.



Cylinders for BC100-Series (Order tailpiece and housing separately.)

Number	Description
22-002	Conventional cylinder only
20-729	Primus cylinder only
20-529	Primus UL437 Listed high security cylinder only

Available 606 and 626 finish only. Everest C123 keyway standard.

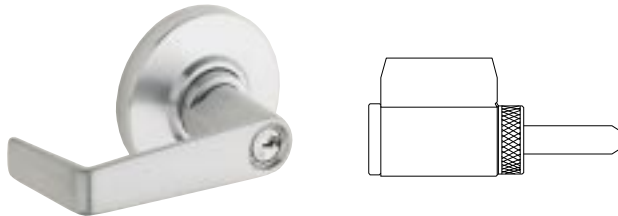

Cylinders for AL-Series Levers

Number	Description
21-020	6-Pin conventional cylinder (standard)
20-728	Primus cylinder
20-528	Primus UL437 Listed high security cylinder
21-021	Conventional hotel function (AL85) with occupancy indicator

Available 606 and 626 finish only. Everest C123 keyway standard.



Cylinders for B250-Series (Order tailpieces separately.)

This table also applies to discontinued B100, B200 and B400-Series deadlocks, and the top cylinders of H and S200-Series interconnected locksets.

Number	Description
22-002	6-Pin conventional cylinder only
20-729	Primus cylinder only
20-529	Primus UL437 Listed high security cylinder only
22-019	6-Pin conventional cylinder in outside housing
20-730	Primus cylinder in outside housing
20-530	Primus UL437 Listed high security cylinder in outside housing
22-019	6-Pin conventional cylinder in inside housing
20-730	Primus cylinder in inside housing
20-530	Primus UL437 Listed high security cylinder in inside housing

Cylinder itself available 606 and 626 finish only. Housing is available in B250, H, and S200-Series finishes. Everest C123 keyway standard.

Cylinders for Schlage Locksets

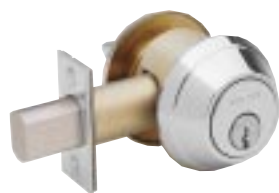

B600-Series - Conventional Cylinder
B700-Series - Primus Cylinder
B800-Series - UL437 Listed Primus Cylinder

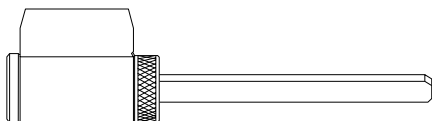

Cylinders for B600/700/800-Series Deadlocks (Housing not included)

Lockset Function	Cylinder Number	Door Thickness	Cylinder Mechanism
B660, B663	22-644	1 $\frac{3}{8}$ " - 2 $\frac{1}{2}$ "	Conventional
B661, B664	22-642	1 $\frac{3}{8}$ " - 2"	
	22-643	2" - 2 $\frac{1}{2}$ "	
B662	22-645	1 $\frac{3}{8}$ " - 2"	
	22-646	2" - 2 $\frac{1}{2}$ "	
B760, B763	20-744	1 $\frac{3}{8}$ " - 2 $\frac{1}{2}$ "	Primus
B761, B764	20-742	1 $\frac{3}{8}$ " - 2"	
	20-743	2" - 2 $\frac{1}{2}$ "	
B762	20-745	1 $\frac{3}{8}$ " - 2"	
	20-746	2" - 2 $\frac{1}{2}$ "	
B860, B863	20-544	1 $\frac{3}{8}$ " - 2 $\frac{1}{2}$ "	Primus UL437 Listed
B861, B864	20-542	1 $\frac{3}{8}$ " - 2"	
	20-543	2" - 2 $\frac{1}{2}$ "	
B862	20-545	1 $\frac{3}{8}$ " - 2"	
	20-546	2" - 2 $\frac{1}{2}$ "	

Available 606 and 626 finish only. Everest C123 keyway standard.

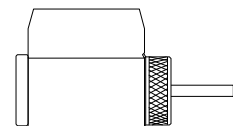

Cylinders for D-Series Knobs

Number	Description
23-001	6-Pin conventional cylinder (standard)
20-748	Primus cylinder
20-548	Primus UL437 Listed high security cylinder
23-003	Conventional hotel function (D85) with occupancy indicator
21-002	6-Pin conventional cylinder, 2" - 2 $\frac{1}{2}$ " thick door
20-724	Primus cylinder, 2" - 2 $\frac{1}{2}$ " thick door
20-524	Primus UL437 Listed high security cylinder, 2" - 2 $\frac{1}{2}$ " door
23-003-098	Conventional hotel function (D85) w/indicator, 2" - 2 $\frac{1}{2}$ " door

Available 606 and 626 finish only. Everest C123 keyway standard.

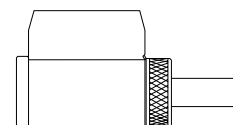

Cylinders for D-Series Levers

Number	Description
23-013	6-Pin conventional cylinder (standard)
20-750	Primus cylinder
20-550	Primus UL437 Listed high security cylinder
23-014	Conventional hotel function (D85) with occupancy indicator

Available 606 and 626 finish only. Everest C123 keyway standard.

Cylinders for Schlage Locksets

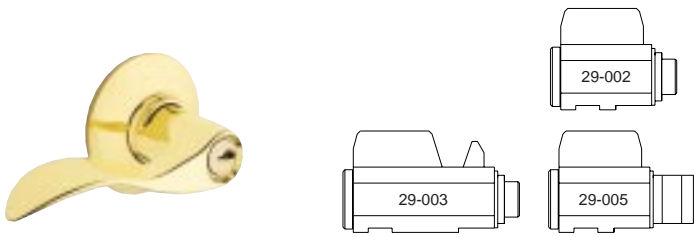

Cylinders for F-Series Knobs and Levers

Number	Description
29-002	Bell, Georgian and Plymouth knobs
29-003	Orbit knob
29-005	Accent and Flair levers

Available 429 (to match 626) and 430 (to match 606) finish. 5-pin C keyway only.



Cylinders for S-Series Levers

Number	Description
21-028	Conventional cylinder
20-752	Primus cylinder
20-552	Primus UL437 Listed high security cylinder only

Available 606 and 626 finish. Everest C123 keyway standard.

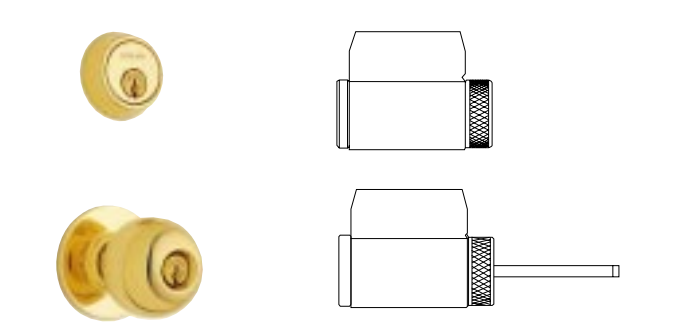

Cylinders for H-Series Interconnected Locksets

Description	Cylinder
Top cylinder (deadlock)	See B200/400-Series deadlock cylinder table
Bottom cylinder (knob)	See A-Series knob cylinder table

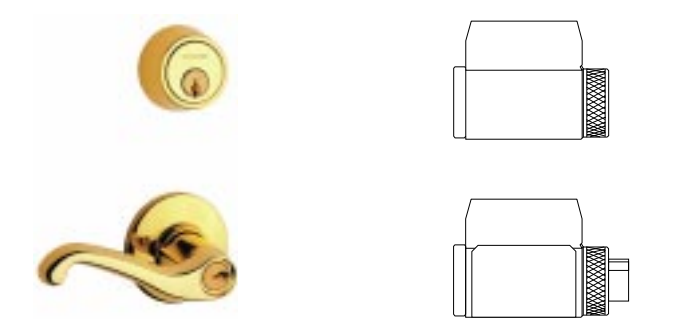

Cylinders for S200-Series Interconnected Locksets

Description	Cylinder
Top cylinder (deadlock)	See B200/400-Series deadlock cylinder table
Bottom cylinder (lever)	See S-Series lever cylinder table

Cylinders for Schlage Locksets



Blocking Rings*

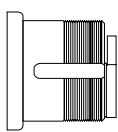

Cylinder Only

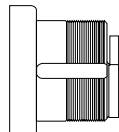

Compr. Ring & Spring

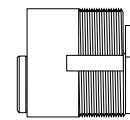

Concealed Shell Cylinder

Cylinders for Schlage L-Series Mortise Locks

	Design	Function	Cylinder Mechanism				
			Conventional	Primus	Primus UL437	Primus Lockout	Primus UL437 Lockout
	L & N Escutcheons (cylinders and spring only)	All Except Below	30-021	20-793	20-593	20-717**	20-517**
		L9060P Outside	26-021	20-701	20-501	20-715**	20-515**
		L9485, L9486 Hotel Functions	30-022*	N/A	N/A	N/A	N/A
	L Escutcheon with concealed shell cylinder (C suffix)	All Except Below	30-004	20-789	20-589	N/A	N/A
		L9080P Outside	26-023	N/A	N/A	N/A	N/A
		L9485, L9486 Hotel Functions	30-005*	N/A	N/A	N/A	N/A
	Sectional Trim (cylinder with compression ring & spring)	All Except Below	30-001	20-787	20-587	20-717	20-517
		L9060P Outside	20-001	20-700	20-500	20-715	20-515
		L9060P Outside	30-002*	N/A	N/A	N/A	N/A

* Specify door hand for hotel function cylinders.

** Discard compression ring for Lockout cylinders with escutcheon trim.

- Notes
1. Available 605, 606, 612, 613, 625, 626, 629, and 630 finish. Concealed shell cylinders available 606 and 626 only.
 2. To differentiate between Classic and Everest, specify keyway. Example: C or CP (Classic), C123 (Everest). Everest C123 keyway standard.
 3. 1-1/8" length standard. Optional lengths available in 1/8" (4mm) increments up to 1-3/4" (44mm).
 4. To order less Schlage logo, specify with K510-612 faceplate.
 5. Lockout keys must be ordered separately and lockout cylinders will not be master keyed by Schlage.
 6. Specify LKB if 0-bitted Primus cylinders are required less key blanks.

Cam for All Functions Except L9060 Outside

Cam for L9060 Outside and Most Brands of Old Black Cast Iron Mortise Locks

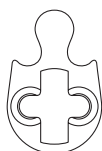

L583-254

Classic Conventional



L583-153

Everest & Primus



B502-191

Classic Conventional



B502-948

Everest & Primus

Cabinet Locks and Padlocks

CL-Series Cabinet Locks

CL1000

CL2000

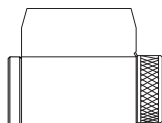

Door

Drawer

Application	Bolt	Complete Lock			Cylinder Only		
		Conventional	Primus	Primus UL	Conventional	Primus	Primus UL
Door	1" (std)	CL1000PB	CL1740PB	CL1540PB	20-172	20-772	20-572
	1/2"	CL1009PB	CL1749PB	CL1549PB			
Drawer	1/2" (std)	CL2000PB	CL2740PB	CL2540PB	20-174	20-774	20-574
	3/4"	CL2009PB	CL2749PB	CL2549PB			

Available 606 and 626 finish.
Everest C123 keyway standard.

PL-Series Padlocks

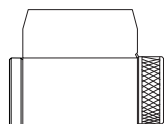
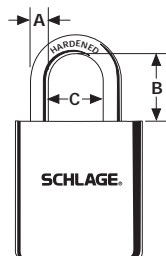

Padlock Series	Shackle Dimensions			Complete Padlock			Cylinder Only		
	A	B	C	Conventional	Primus	Primus UL	Conventional	Primus	Primus UL
PL1000 1 3/4" x 2 1/8" x 3/4"	5/16"	1 1/8"	3/4"	PL1001	PL1741	PL1541	47-410	47-740	47-540
	5/16"	2"	3/4"	PL1002	PL1742	PL1542			
	5/16"	3"	3/4"	PL1003	PL1743	PL1543			
PL2000 2" x 2 1/8" x 3/4"	3/8"	1 1/8"	3/4"	PL2001	PL2741	PL2541			
	3/8"	2"	3/4"	PL2002	PL2742	PL2542			
	3/8"	3"	3/4"	PL2003	PL2743	PL2543			
PL3000 2 1/4" x 2 3/8" x 7/8"	7/16"	1 1/8"	1 5/16"	PL3001	PL3741	PL3541			
	7/16"	2"	1 5/16"	PL3002	PL3742	PL3542			

Available 606 finish only.
Everest C123 keyway standard.

Cylinders for Exit Devices, Aluminum Doors, etc.

Rim Cylinders

Number	Description
20-022	Conventional cylinder
20-710	Primus cylinder
20-716	Primus lockout cylinder
20-510	Primus UL437 Listed cylinder
20-516	Primus UL437 Listed lockout cylinder

Available 605, 606, 612, 613, 625 and 626 finish.
Everest C123 keyway standard.



Cylinders for Adams Rite MS, 4500 and 4700 Series, Lori 4500 Series and Corbin Russwin DL3000 Series.

Number	Description
26-072	Conventional cylinder only
20-013	Conventional cylinder with 3/8" blocking ring
20-706	Primus cylinder with 3/8" blocking ring
20-510	Primus UL437 Listed cylinder
20-718	Primus lockout cylinder
20-518	Primus UL437 Listed lockout cylinder

These cylinders include set screw pack B220-050 for Adams Rite locks.



B502-292
Cam for Classic
Conventional



B502-944
Cam for Everest
& Primus

Cylinders for Adams Rite 4070 Series

Number	Description
26-073	Conventional cylinder only
20-708	Primus cylinder only
20-508	Primus UL437 Listed cylinder only



B502-380
Cam for Classic
Conventional



B502-945
Cam for Everest
& Primus

- Notes
1. Available 605, 606, 612, 613, 625, 626, 629, and 630 finish.
 2. To differentiate between Classic and Everest, specify keyway. Example: C or CP (Classic), C123 (Everest). Everest C123 keyway standard.
 3. 1-1/8" length standard. Optional lengths available in 1/8" (4mm) increments up to 1-3/4" (44mm).
 4. To order less Schlage logo, specify with K510-612 faceplate.
 5. Lockout keys must be ordered separately and lockout cylinders will not be master keyed by Schlage.
 6. Specify LKB if 0-bitted Primus cylinders are required less key blanks.

Full Size Interchangeable Core



A-Series
ORBIT DESIGN



D-Series Lever
ALL DESIGNS



AL-Series
SATURN DESIGN



H-Series Knob
ORBIT DESIGN

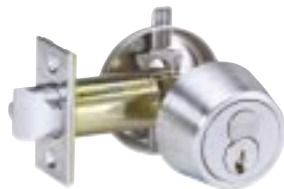

BC100-Series
B250-Series



L-Series
ALL DESIGNS

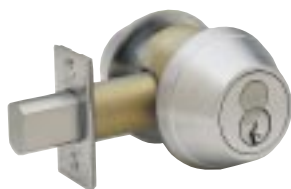

B600 / 700-Series



S-Series
ALL DESIGNS
EXCEPT FLAIR



D-Series Knob
ORBIT DESIGN



S200-Series
ALL DESIGNS FOR S210.



ALL EXCEPT FLAIR FOR
OTHER FUNCTIONS

Full Size Interchangeable Core Cylinders for Schlage Locksets

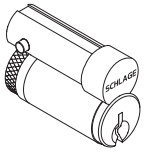

Full Size Core Only

Number	Mechanism
23-030	Conventional core
30-120	Conventional core for hotel function (specify hand)
20-730	Primus core (not available in hotel function)

Available 606 and 626 finish only. Everest C123 keyway standard.
Order control keys separately.

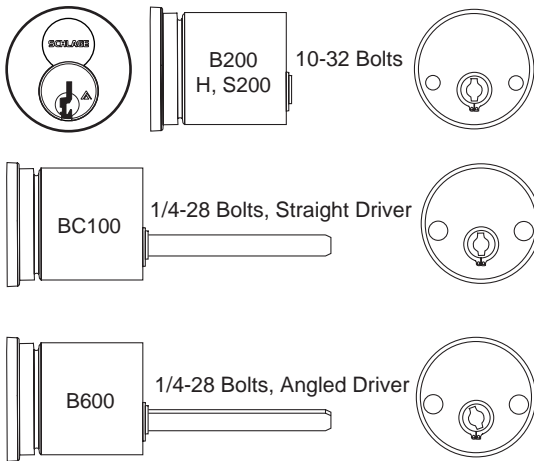

IC Housings for Bored Deadlocks, Less Core

Lockset Series	Description	Number	Specify Finish
BC100-Series	Outside	B220-203	605, 609, 612, 613, 625, 626
	Inside	B220-204	See Note Below
B250, H, S200-Series	Outside	22-061	605, 606, 609, 610, 611, 612, 613, 616, 625, 626
	Inside of B252	22-062	
B600 / 700-Series	Outside	B610-027	605, 606, 609, 612, 613, 625, 626
	Inside	B610-028	See Note Below

Specify finish of B610-031 inside snap-on faceplate ordered separately for BC162 and B662/762.

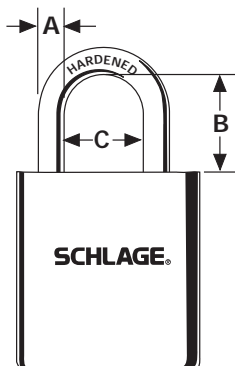

Interchangeable Core Padlocks

Padlock Series	Shackle Dimensions			Padlock with Core	
	A	B	C	Conventional	Primus
PL4000 2" x 2 1/4" x 7/8"	3/8"	1 1/8"	3/4"	PL4001	PL4741
	3/8"	2"	3/4"	PL4002	PL4742
	3/8"	3"	3/4"	PL4003	PL4743

Full Size Interchangeable Core Mortise Cylinders

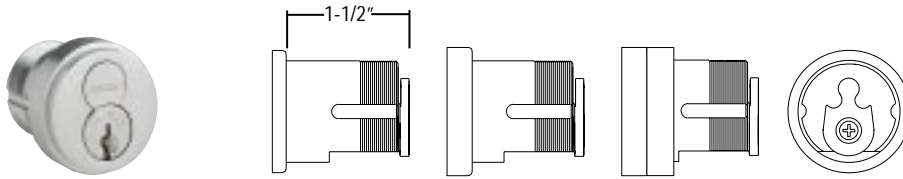

Cylinders for Schlage L-Series Mortise Locks

Design	Function	Core Mechanism		
		Conventional	Primus	Housing Less Core
	All Except Below	30-008	20-798	30-007
	L9060P Outside	30-030	20-782	30-032 + 36-083
	L9485P, L9486P Hotel Functions	30-010*	N/A	30-007
	All Except Below	30-138	20-776	30-137
	L9060P Outside	20-061	20-783	30-032 + 36-083 + 35-082-037
	L9485P, L9486P Hotel Functions	30-140*	N/A	30-137



L583-255
Cam for All Functions Except L9060 Outside



K510-680
Cam for L9060 Outside

* Hotel function cores are handed. Specify hand of door.

Mortise Cylinders with Straight Cam for Exit Devices and Most Old Black Cast Iron Mortise Locksets

Number	Core Mechanism	Collar
26-091	Conventional core	Compression ring & spring
20-061		3/16" + 3/8" blocking rings
20-763	Primus core	Compression ring & spring
20-771		3/16" + 3/8" blocking rings
20-059	Housing less core	None
26-064		Compression ring & spring
26-094		3/16" + 3/8" blocking rings



K510-730
Straight Cam, Other Applications

- Notes
1. Available 605, 606, 612, 613, 625, and 626 finish. Cores furnished 606 and 626 only.
 2. To differentiate between Classic and Everest, specify keyway. Example: C or CP (Classic), C123 (Everest). Everest C123 keyway standard.
 3. All cylinders are 1-1/2" long.
 4. Specify LKB if 0-bitted Primus cylinders are required less key blanks.

Full Size Interchangeable Core Cylinders for Exit Devices, Aluminum Doors, etc.

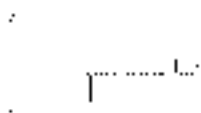

Interchangeable Core Rim Cylinders for Exit Devices

Number	Core Mechanism
20-057	Conventional core
20-757	Primus core
20-079	Housing only, less core

Available 605, 606, 612, 613, 625 and 626 finish.
Everest C123 keyway standard.



**Cylinders for Adams Rite MS and 4700 Series,
Lori 4500 Series and Corbin Russwin DL3000 Series.**

Number	Core Mechanism	Collar
26-098	Conventional core	Compression ring & spring
20-062	Conventional core	3/16" + 3/8" blocking rings
20-766	Primus core	3/16" + 3/8" blocking rings
20-060	Housing less core	None



K510-711
Adams Rite
MS Cam

These cylinders include set screw pack B220-050 for Adams Rite locks.

Cylinders for Adams Rite 4070 Series Deadlocks

Number	Core Mechanism	Collar
20-091	Conventional core	3/16" + 3/8" blocking rings
20-722	Primus core	3/16" + 3/8" blocking rings
20-090	Housing less core	None



B520-378
Adams Rite
4070 Cam

- Notes
1. Available 605, 606, 612, 613, 625, and 626 finish. Cores furnished 606 and 626 only.
 2. To differentiate between Classic and Everest, specify keyway. Example: C or CP (Classic), C123 (Everest). Everest C123 keyway standard.
 3. All cylinders are 1-1/2" long.
 4. Specify LKB if 0-bitted Primus cylinders are required less key blanks.

Small Format (Best Style) Interchangeable Core



AL-Series
SATURN DESIGN



D-Series Lever
ALL DESIGNS



BC100-Series
B250-Series



L400-Series

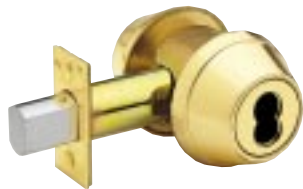

B600 / 700-Series



L9000-Series
ALL DESIGNS

Small Format Interchangeable Core Cylinders for Schlage Locksets



Small Format Core Only

Number	Mechanism
80-036	7-pin Everest B Family restricted keyway core, uncombined
80-037	7-pin Everest B Family restricted keyway core, uncombined
80-043	6-pin Best keyway core, uncombined
80-033	7-pin Best keyway core, uncombined

- Notes
1. Available 606 and 626 finish only.
 2. Suffix keyway, e.g. 80-036 B235, 80-043 AB, etc.
 3. Proper authorization required for Everest cores. Order control keys separately.
 4. 80-043 and 80-033 available in Best A, D, E, F, G, H, J, K, L and M keyways. Suffix "B" to keyway letter, e.g. AB, DB, etc.

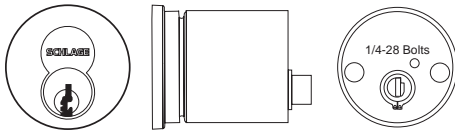

IC Housings for Bored Deadlocks, Less Core



Lockset Series	Description	Number	Specify Finish
BC100-Series	Outside	B610-282	605, 609, 612, 613, 625, 626
	Inside	B610-281	See Note Below
B600-Series	Outside	B610-027	605, 606, 609, 612, 613, 625, 626
	Inside	B610-028	See Note Below

Tailpieces not included.
Specify finish of B610-014 snap-on faceplate ordered separately for inside of BC162 and B662.

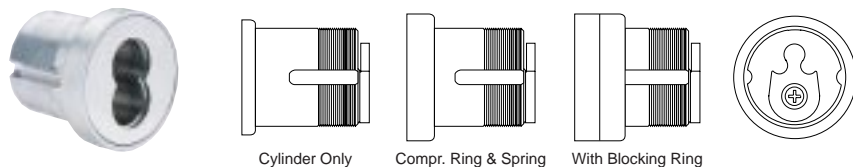
Small Format Interchangeable Core Mortise Cylinders



Cylinders for Schlage L-Series Mortise Locks

Design	Function	Cylinder Mechanism			
		Everest Restricted (GD Suffix)	Keyed Construction (HD Suffix)	Disposable Construction (BDC Suffix)	Housing Less Core (BD Suffix)
 <p>L & N Escutcheons (cylinders with compression ring and spring)</p>	All* except L9060 Outside	80-308	80-138	80-115	80-108
	L9060 Outside	80-304	80-134	80-112	80-104
 <p>Sectional Trim (Cylinder with compression ring, spring, and 1/4" blocking ring)</p>	All* except L9060 Outside	80-301	80-131	80-109	80-101
	L9060 Outside	80-304 + 36-082-025	80-134 36-082-025	80-112 36-082-025	80-104 36-082-025



L583-255
Cam for All Functions Except L9060 Outside



K510-680
Cam for L9060 Outside

Mortise Cylinders with Straight Cam for Exit Devices and Most Old Black Cast Iron Mortise Locksets

Number	Core Type
80-302	Everest restricted core
80-110	Disposable constr. core
80-132	Keyed constr. core
80-102	Housing less core



K510-730
Straight Cam,
Other Applications

Furnished with compression ring, spring and 1/4" blocking ring

Notes 1. Available 605, 606, 612, 613, 625, and 626 finish. Cores furnished 606 and 626 only.
2. All cylinders are 1-3/8" long.

Small Format Interchangeable Core Cylinders for Exit Devices, Aluminum Doors, etc.



Interchangeable Core Rim Cylinders for Exit Devices

Number	Core Mechanism
20-057	Conventional core
20-757	Primus core
20-079	Housing only, less core

Available 605, 606, 612, 613, 625 and 626 finish.
Everest C123 keyway standard.

**Cylinders for Adams Rite MS and 4700 Series,
Lori 4500 Series and Corbin Russwin DL3000 Series.**

Number	Core Type
80-303	Everest restricted core
80-111	Disposable constr. core
80-133	Keyed constr. core
80-103	Housing less core



K510-711
Adams Rite
MS Cam

Furnished with compression ring, spring and 7/16" blocking ring.
These cylinders include set screw pack B220-050 for Adams Rite locks.

Cylinders for Adams Rite 4070 Series Deadlocks









Number	Core Type
80-305	Everest restricted core
80-113	Disposable constr. core
80-135	Keyed constr. core
80-105	Housing less core

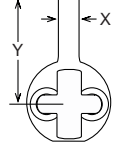
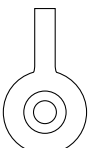

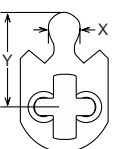
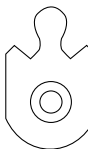
B520-378
Adams Rite
4070 Cam

Furnished with compression ring, spring and 1/4" blocking ring
Notes 1. Available 605, 606, 612, 613, 625, and 626 finish. Cores furnished 606 and 626 only.
2. All cylinders are 1-3/8" long.

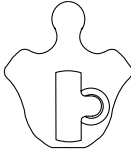
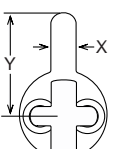
Cams for Schlage Mortise Cylinders in Other Manufacturers' Mortise Locks

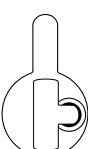
	Classic Conventional	Interchangeable Core	Everest & Primus Non-IC
	20-001	20-061, 20-771, 26-094, 80-102, 80-110, 80-132, 80-302	20-001 Everest 20-500 and 20-700 Primus
Corbin Russwin® DL4000 Series (Old Corbin 420 and Russwin 1503)	B520-295  Dim. X = .155 Y = .775	B520-254 	B520-366 
Corbin Russwin® ML2200 Series (Old Corbin 7000-9000 and Russwin 4000-5000) All functions except ML2255 and ML2242 inside (see straight cam)	B520-233  Dim. X = .232 Y = .729	B520-253 	B520-309 
Corbin Russwin A65 ML2200 master ring deadbolt functions manufactured before 6/10/93 and old Russwin cast iron residential locks	B520-223  Dim. X = .235 Y = .729	B520-360 	B520-367 
Yale® 2160 Arrow® #004 Sargent® 13-0660 All functions except 16 inside and 50 outside	B520-256  Dim. X = .186 Y = .718	B520-296 	B520-329 

The following complete cylinders are available. Specify the desired cam from the correct column above:

Cylinder Mechanism

- Conventional cylinder
- Primus cylinder
- Primus UL437 Listed cylinder
- Full size IC with conventional core
- Full size IC with Primus core
- Full size IC housing less core
- SFIC with Everest core
- SFIC with keyed construction core
- SFIC with disposable construction core
- SFIC housing less core

Collar

- compression ring and spring
- compression ring and spring
- compression ring and spring
- compression ring, spring, 3/8" blocking ring
- compression ring, spring, 3/8" blocking ring
- compression ring, spring, 3/8" blocking ring
- compression ring, spring, 1/4" blocking ring
- compression ring, spring, 1/4" blocking ring
- compression ring, spring, 1/4" blocking ring
- compression ring, spring, 1/4" blocking ring

How to Order

- 20-001 x cam number
- 20-700 x cam number
- 20-500 x cam number
- 20-061 x cam number
- 20-771 x cam number
- 26-094 x cam number
- 80-302 x cam number
- 80-132 x cam number
- 80-110 x cam number
- 80-102 x cam number

Other manufacturers' registered trade names are for identification and reference only.

Cylinders for Other Manufacturers' Products

Corbin Russwin CL3400, CL3600 Series

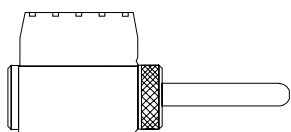

Corbin Russwin CK4200, UT5200 Series

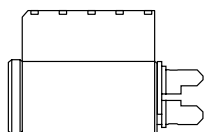

Sargent 7, 8, 10, 65 Line Levers

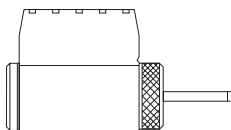

Sargent 7, 8 Line Knobs

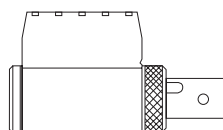

Sargent 6 Line (Except B Knobs)

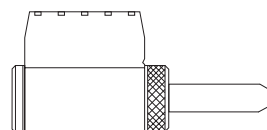

Yale 5300LN, 5400LN, 6400LN Levers

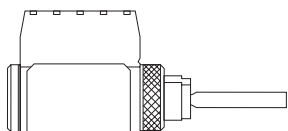

Yale 5300, 5400, 6200 Knobs

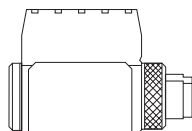

Conventional Cylinder	Primus	Primus UL437	Description
24-139	20-739	20-539	Corbin Russwin CL3400, CL3600
24-127	20-727	20-527	Corbin Russwin CK4200, UT5200
24-126	20-726	20-526	Sargent 6 Line (Except B Knobs)
24-120	20-720	20-520	Sargent 7, 8, 9 Line Knobs
24-119	20-719	20-519	Sargent 7, 8, 10, 65 Line Levers
24-123	20-723	20-523	Yale 5300, 5400, 6200 Knobs
24-147	20-747	20-547	Yale 5300LN, 5400LN, 6400LN Levers

Other manufacturers' registered trade names are for identification and reference only.

Everest Full Size Key Blanks

Numbers shown are for key blanks. For cut keys, change "35" prefix to "48" for change keys and "49" for master keys. Suffix key section, e.g. 35-009 C123. See facing page for available key sections.

Conventional

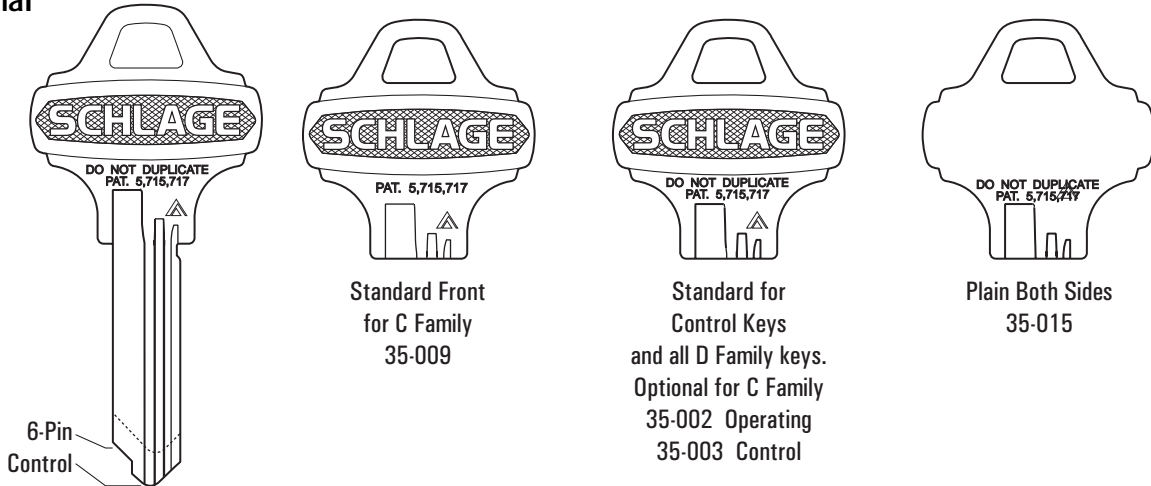

Everest conventional keys are available with and without DO NOT DUPLICATE. Specify plain bow keys for applications when keys must be stamped with additional information such as special die stamps, serial numbering, etc.

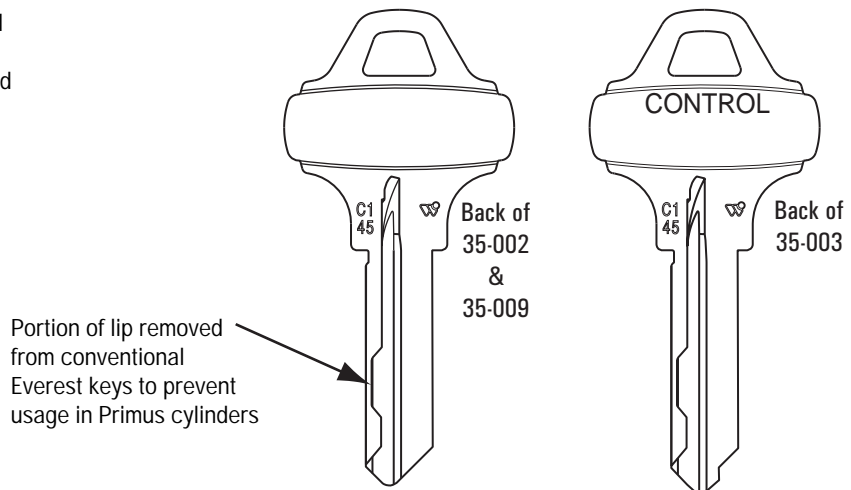

Primus

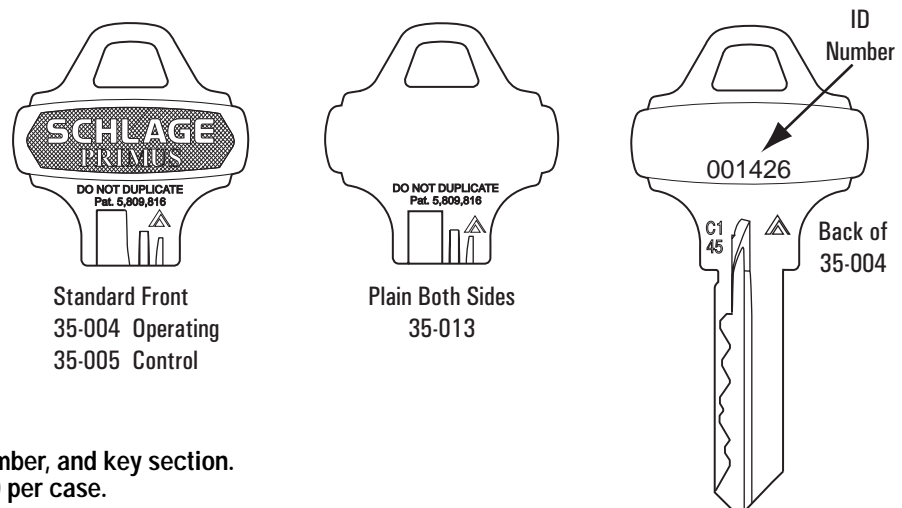

To order, specify quantity, 6-digit ID number, and key section. Key blanks are packed 50 per box, 1000 per case.

Everest Keyways for New Key Systems

C Family Keyways

for Everest conventional cylinders and Primus Levels 7, 8, and 9

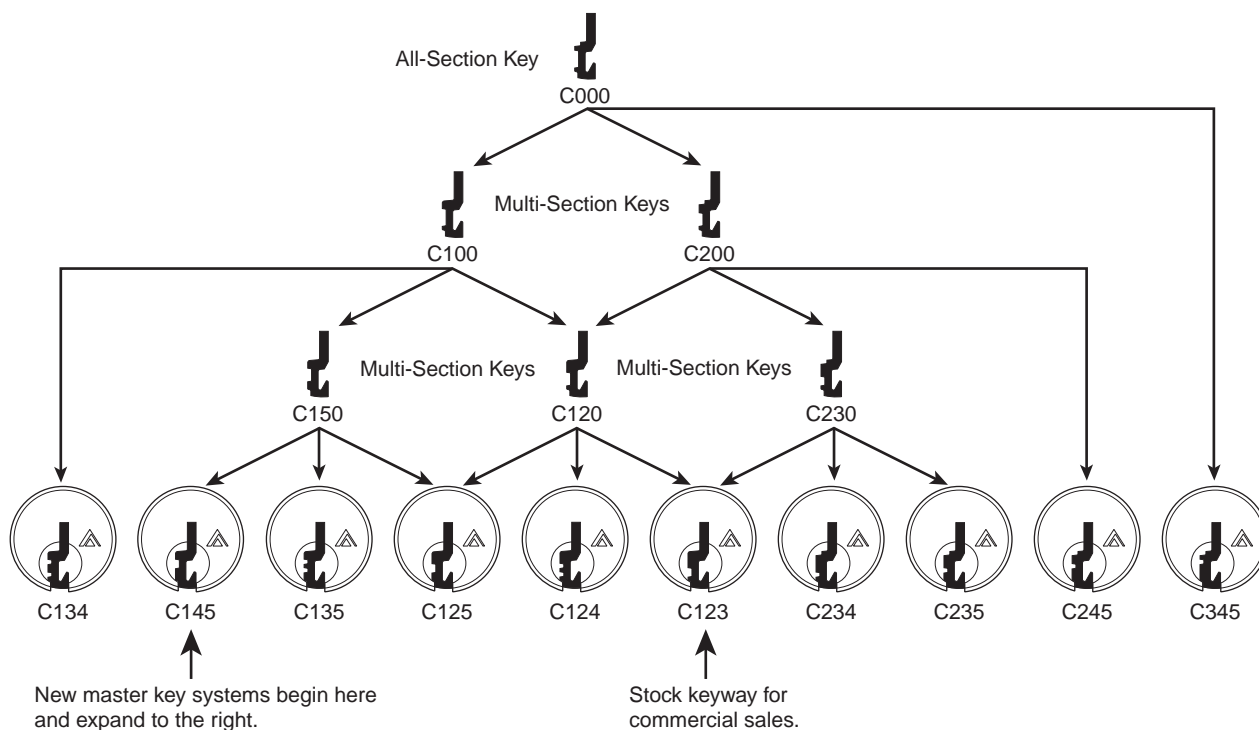

By definition, all Primus keys are restricted. Primus keys are downward compatible to operate Schlage *conventional* cylinders with compatible keyways. Key blanks for Schlage Everest *conventional* cylinders with C Family keyways (above) are openly available to locksmiths and contract hardware dealers but not normally found in retail stores that duplicate keys.

D Family Restricted Keyways (not shown)

D Family keyways are end user restricted keyways. They are not stocked by locksmiths or other dealers. Conventional (non-Primus) cylinders with D Family restricted keyways offer economical patent protection but no geographical exclusivity. All orders for D Family keys and blanks require a letter of authorization from the end user.

The D Family keyways are only available at Primus Level 9 where product is shipped directly to the end user or his designated agent. Primus cylinders add the geographical exclusivity of the side biting as well as the high security features of the finger pin and sidebar mechanism.

Classic Key Blanks

Numbers shown are for key blanks. For cut keys, change "35" prefix to "48" for change keys and "49" for master keys. Suffix key section, e.g. 35-101 E. See facing page for available key sections.

Conventional

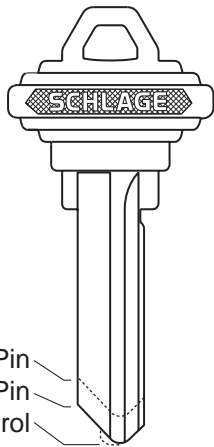

5-Pin
6-Pin
Control

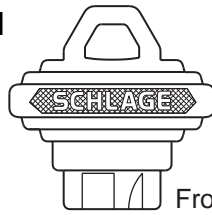

Standard
Front and Back

- 35-100 5-Pin
- 35-101 6-Pin
- 35-056 Control

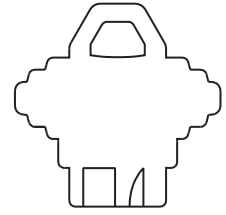

- Plain Both Sides
- 35-130 5-Pin
 - 35-131 6-Pin
 - 35-076 Control

Primus

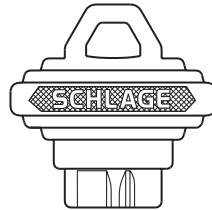

- Standard Front
- 35-157 Operating
 - 35-158 Control

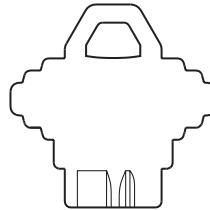

- Plain Front
- 35-053 Operating
 - 35-052 Control

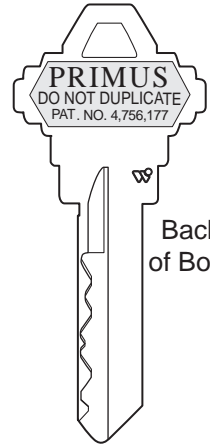

Back
of Both

Standard Bow

To order conventional key blanks with DO NOT DUPLICATE, specify XQ06-878.

Specify plain bow keys for applications when keys must be stamped with additional information such as special die stamps, serial numbering, etc.

Large Bow

Ideal for special keys which must be visibly distinctive within a key system, or for very specialized marking.

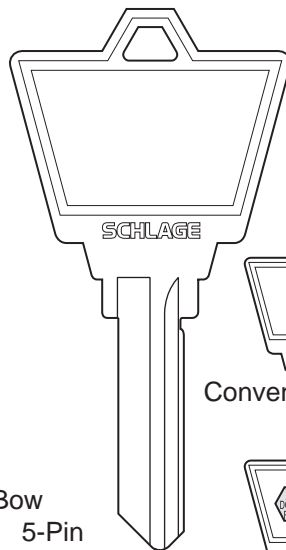

- Large Bow
- 35-140 5-Pin
 - 35-141 6-Pin
 - 35-116 Primus



Conventional Back



Primus Back

Access Bow

Conforms to California Title 24 for handicap access.

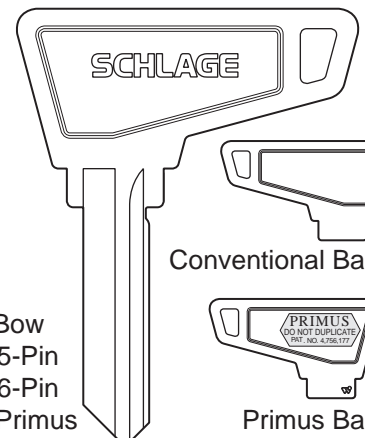

- Access Bow
- 35-143 5-Pin
 - 35-144 6-Pin
 - 35-115 Primus

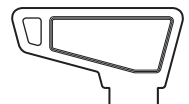

Conventional Back

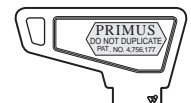

Primus Back



Classic Keyways for Older Key Systems

Obverse Keyways

for Classic Conventional cylinders

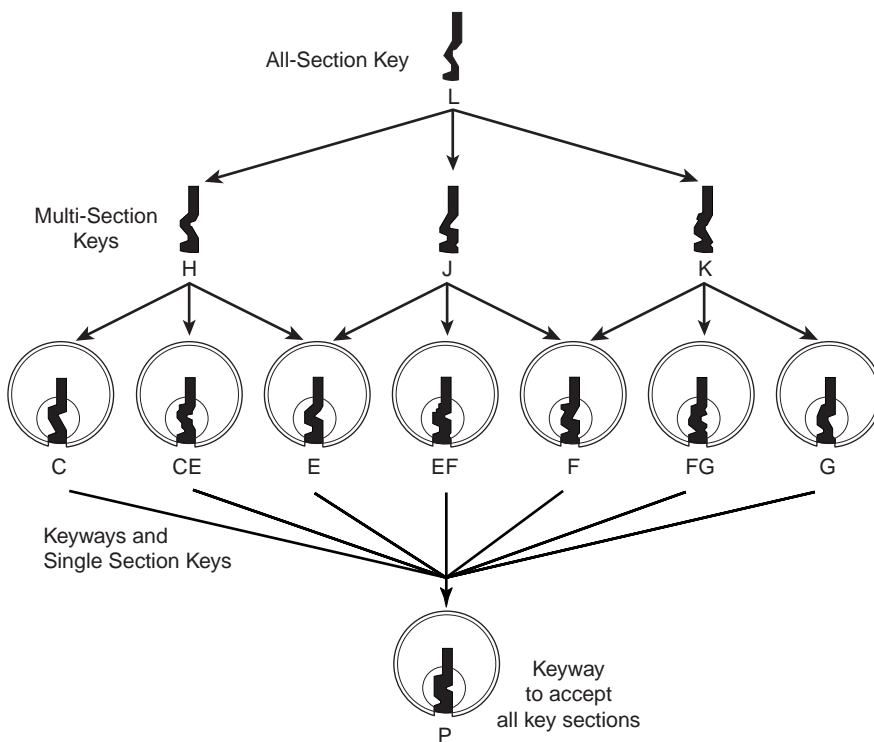

Obverse Keyways

for Classic Primus cylinders
Levels 1 through 4

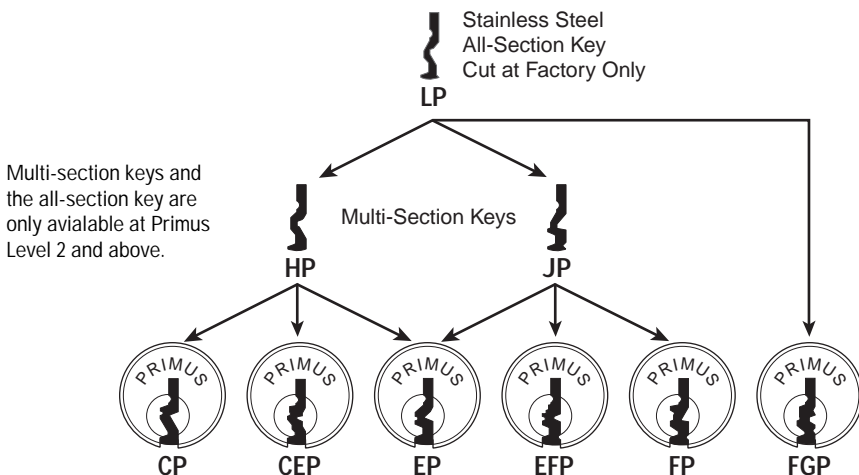

Restricted Keyways (not shown)

By definition, all Primus keys are restricted. They are downward compatible to operate Schlage conventional cylinders with corresponding keyways. Schlage Classic conventional cylinders may have keyways which are openly available as shown above, or they may be restricted (without patent protection) and require a letter of authorization from the end user. Not all Classic restricted keyways are Primus compatible.

Small Format Key Blanks

For cut keys, change "35" prefix to "48" for change keys and "49" for master keys. Suffix key section, e.g. 35-009 C123. See facing page for available key sections.

Everest B Family Patented Restricted Key Blanks

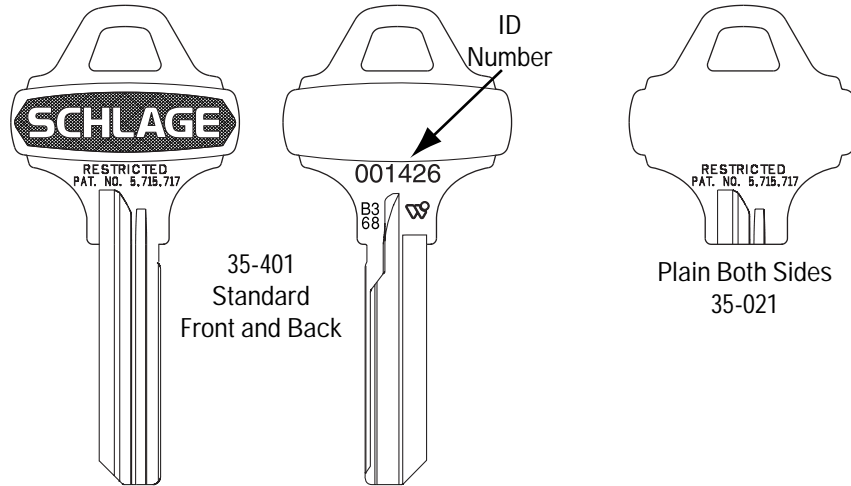

B235 Dealer Keyway

Available to locksmiths and service-oriented contract hardware dealers, this keyway is controlled similar to Primus Levels 1+ and 7. Each dealer signs a contract agreeing to certain key control procedures and agreeing not to duplicate keys marked with another dealer's ID number.

The dealer cuts all B235 keys and cannot sell key blanks to the end user. If the end user needs to cut keys, B Family end user keyways (below) should be furnished instead of B235. Contact your Schlage commercial wholesaler or local IR Security & Safety Consultants office for further information.

B Family End User Keyways

The B Family end user restricted keyways are not stocked by locksmiths or other dealers. They are drop shipped directly to the end user and offer economical patent protection but no geographical exclusivity. All orders for B Family keys and blanks require a letter of authorization from the end user.

Best® Type Key Blanks

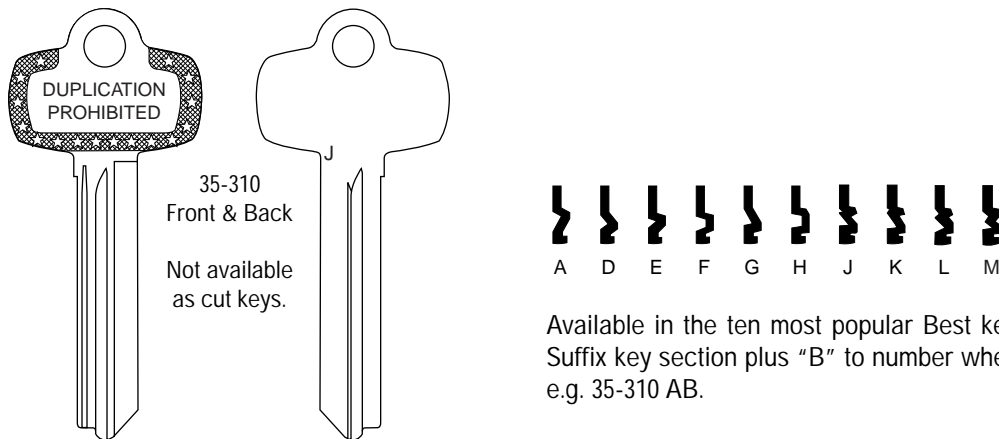

Available in the ten most popular Best key sections. Suffix key section plus "B" to number when ordering, e.g. 35-310 AB.

To order, specify quantity and key section. Include 6-digit ID number for Everest B Family. Key blanks are packed 50 per box, 1000 per case.

Cylinder Service Equipment and Tools

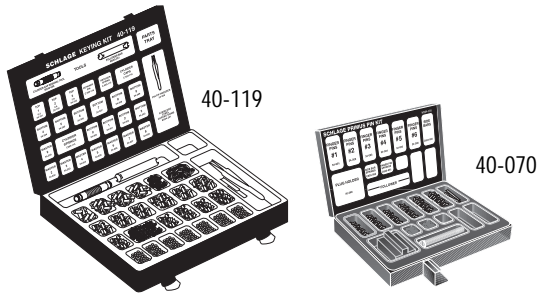

Pin Kits

- 40-119 For full size conventional cylinders
Contains bottom, top and master pins, springs, cap pins, cap pin springs, caps, follower, tweezers, key gauge, shims, cap removal tool
- 40-070 Primus
Contains finger pins, sidebars, springs, plug holder
- 40-129 SFIC wooden pin kit for A2 System
Contains all pins and springs, key gauge, tweezers, capping tool, capping block, ejector tool

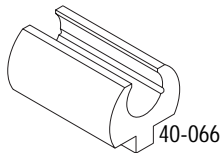

Full Size Cylinder Tools (included in kits above)

- 40-066 Primus plug holder
- 40-116 Shell loading tool
- M204-200 Pin tweezers
- M540-056 Cylinder cap removal tool

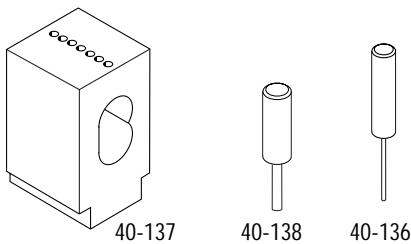

Small Format IC Tools (included in 40-129 kit)

- 40-137 Capping block
- 40-136 Ejector tool
- 40-138 Capping tool

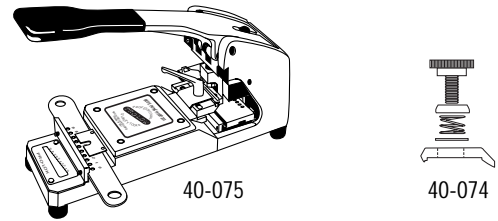

Blue Punch Key Machine

- 40-075 Classic Obverse and Everest C Family keys only (Conventional and Primus)
- 40-071 Everest B Family small format IC keys only
- 40-074 Upgrade jaw kit adds Everest C Family capability to Blue Punch machines made before July 1999

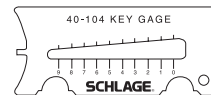

Key Gauge

- 40-104 Full size keys
- 40-128 A2 System SFIC keys

Bulk Pack Cylinder Kit

Bulk Packs are 10-packs that contain the components you need to quickly build 10 cylinders. All shells are pre-loaded with top pins and springs.

Classic Conventional	Everest Conventional	Primus	Description
09-409	09-751	09-764	Key-in-knob / lever
09-412	09-754	09-767	Mortise (specify length)
09-410	09-752	09-765	Rim
09-411	09-753	20-766	Full size interchangeable core

Specify keyway and finish.
Keys and tailpieces/cams must be ordered separately.

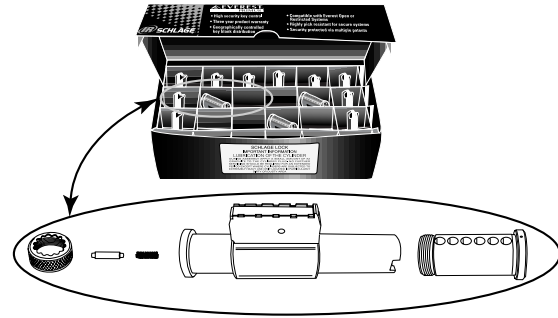

Multiple Tailpiece Cylinders

Reduce cylinder inventory by stocking these cylinders packed with tailpieces to fit these locks:

- A-Series (all designs)
- AL-Series
- D-Series knobs
- D-Series levers
- H-Series knobs (all designs)

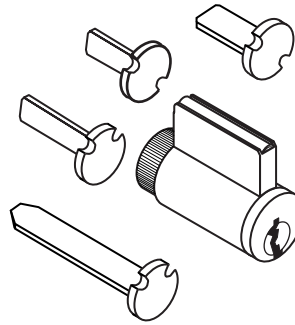

Multiple Tailpiece Cylinders

- 40-100 Conventional
- 40-700 Primus
- 40-500 Primus UL

- Notes
1. Available 606 or 626 finish.
 2. Specify keyway to distinguish between Everest and Classic. Example: C or CP (Classic) vs. C123 (Everest). Available in all full size keyways.
 3. Cylinders are only available 0-bitted.
 4. Not available for hotel function cylinders with occupancy indicator.
 5. Primus key blanks must be ordered separately.

Primus I.D. Cards

Primus I.D. cards are used as authorization credentials for Primus Level 1, 1+, 2, and 8 keys. Cards have a signature panel on the back and are issued by the servicing locksmith or dealer who directly supports the system owner. The owner must present the I.D. card to obtain duplicate keys or additions to his system. The signature will be validated by the dealer.

Primus Cards

Level	Number
1	40-061
1 Plus	40-065
2	40-062
7 & 8	40-060

Classic Primus Level 1 I.D. Card

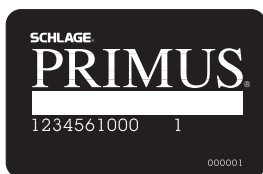

Everest Primus I.D. Card



Primus & Everest Sales Aids



- Cylinder Demo Kits** (Cutaway cylinders included)
- 40-077 Everest conventional, Primus and SFIC demo kit
 - 40-146 Classic conventional and Primus demo kit

Cutaway Cylinders

- 40-073 Everest conventional
- 40-093 Everest Primus
- 40-072 Classic Primus

Primus Dealer Advertising

- 40-141 Primus bumper sticker
- 40-142 Primus baseball cap
- 40-143 Primus dealer window decal
- 40-144 Primus dealer uniform patch

Primus Authorization Forms

Number	Description
MS-E110	Primus Restricted Key Order Form This form is a three-part imprintable form used to record and track the issuance of Primus keys.
MS-E120	Primus Face Sheet Form This form must accompany all Level 3, 4 and 9 orders and provides the factory with a customer authorized signature which is compared to the signature on file, a Primus reference number (for additions to an existing Primus system) and shipping instructions for that order.
MS-E130	Primus Signature Card Form This form is used as a permanent record against which the signature of individuals authorized to obtain service and support for their Primus System is validated. This form must accompany all new Level 3, 4 and 9 factory orders.
MS-E160	Primus I.D. Card Control Register This form is used by locksmiths and dealers to account for the issuance of Primus I.D. Cards.

Contact Schlage Commercial Customer Service to order these forms, or visit www.schlagelock.com.

Security Levels

The Primus system features multiple levels of security. Primus systems with Classic keyways (Levels 1 through 4) are ideal for upgrading older key systems. All new systems should be specified with Everest keyways (Levels 7 - 9) for maximum patent life, durability, and master keying capacity. Each level requires an appropriate I.D. card and/or signature verification for key duplication. All levels utilize patent protected Primus cylinders and keys to protect against unauthorized duplication. To select the proper level of security, consideration should be given to the overall key control, convenience and service required for the installation.



Level One

One standard side bitting is allocated for Level One systems. Level One locksmiths are permitted to stock Level One Primus cylinders and keys on a local basis. The end user is assigned an I.D. card by the locksmith which must be presented to obtain additional keys.

Level One Plus

Primus Level One Plus combines the convenience of locally stocked keys and cylinders with the security of multiple side bittings distributed on a limited basis. Level One Plus key blanks are sold to a wholesaler on a nationwide exclusive basis. These blanks are distributed through select locksmiths who are assigned unique ID numbers. Level One Plus locksmiths are only able to stock and duplicate keys with their own I.D. number on them. End users are issued an I.D. card which must be presented to the originating locksmith to obtain additional keys.

Level Two

Level Two systems provide local service and inventory of Primus products, but on a more restricted basis. Level Two offers the end user a special side bitting which is exclusive to a contract hardware dealer within his time zone. The Primus Level Two dealer cuts all keys and performs all keying services after validating the Primus I.D. card and verifying the customer signature.

Level Three

At Level Three the Schlage factory maintains control of the Primus key system. For systems with fewer than 60 cylinders, Schlage assigns the side bitting from a small pool of combinations that may be repeated locally. For systems over 60 cylinders, the side bitting is assigned to each installation based on the first two digits of the zip code. Authorized signatures are verified by the Schlage factory with each order for key blanks, duplicate keys or additions to a factory master keyed system.

Level Four

As with Level Three, the factory maintains control of Primus Level Four systems. Side bittings are assigned on either a time zone or nationwide basis, depending on the end user's purchase commitment. Authorized signatures are verified by the Schlage factory with each order for key blanks, duplicate keys or additions to a factory master keyed system.



Everest Primus does not have an equivalent level to the Classic Level One. Users seeking restricted key systems should consider an Everest Restricted key system. Everest Restricted key systems provide key control via a factory verified letter of authorization containing a shipping address for all keys and key blanks.

Level Seven - Wholesaler/Locksmith

Similar to Level One Plus, Level Seven offers key blanks with side bittings that are distributed on a limited basis. Level Seven key blanks are sold to a wholesaler on a nationwide exclusive basis. These blanks are distributed through select locksmiths who are assigned unique ID numbers. Level One Plus locksmiths are only able to stock and duplicate keys with their own I.D. number on them. End users are issued an I.D. card which must be presented to the originating locksmith to obtain additional keys.

Level Eight - Servicing Dealer

Level Eight systems combine the durability and long patent life of Everest C Family keyways with the security controls of Classic Primus Level Two. Level Eight offers any servicing dealer approved by Schlage a time zone exclusive side bitting. The dealer cuts all keys and performs all keying services after validating the customer signature on the I.D. card.

Level Nine - End User

Level Nine combines the end user features of Classic Primus Level Three and Level Four. For Level Nine systems with fewer than 60 cylinders, Schlage assigns the side bittings randomly from a small pool of factory controlled combinations. Systems over 60 cylinders are assigned exclusive side bittings based on the first two digits of the zip code. For very large systems, time zone or nationwide exclusive side bitting exclusivity is also available based on the end user's purchase commitment. Authorized signatures are verified by the Schlage factory with each order for key blanks, duplicate keys or additions to a factory master keyed system.

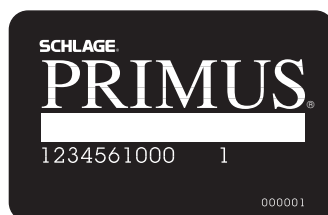

Schlage Cylinder Terminology

Over the last few years Schlage has introduced a variety of new keyways and cylinder types. This chart illustrates our cylinder terms and how they are related. The definitions below provide additional information.

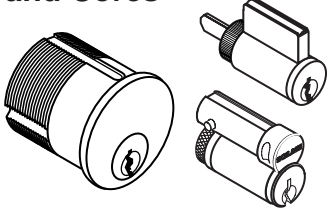
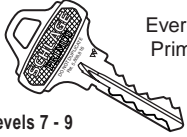
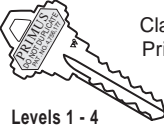
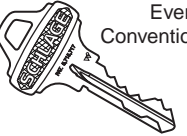
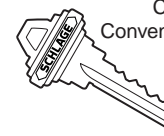
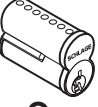
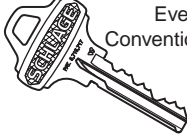
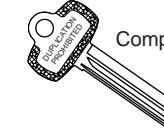
Cylinder Category	Mechanism	Key Control	Keyway Type	
			EVEREST™ Keyways	CLASSIC Keyways
Full Size Cylinders and Cores 	PRIMUS. High Security & Geographical Exclusivity	Adds Patented Restricted Duplication Even to Open Keyways	 Everest Primus Levels 7 - 9	 Classic Primus Levels 1 - 4
	Conventional (Non-Primus)	Open and Restricted Keyways	 Everest Conventional	 Classic Conventional
Small Format (Best Style) Interchangeable Core 	Conventional (Non-Primus)	Open and Restricted Keyways	 Everest Conventional	 Best® Compatible

Keyways

Everest

Cylinders and keys which incorporate all new keyways with the patented undercut groove on the right side of the key section. C Family is the name of the open family of keyways. B Family (for SFIC) and D Family keyways are restricted.



Opposing Terms

Classic

Schlage pin tumbler keyways which existed before Everest keyways. Obverse is the name of the open family of keyways (C, E, etc.) and there are three other families of restricted keyways: Reverse, Numbered and Quad.

Cylinder Mechanisms

Primus Cylinders

Schlage's high security sidebar cylinder mechanism. Patented key control, geographical exclusivity, and pick resistance are standard. UL437 drill resistance is optional. Primus keys operate conventional cylinders.



Opposing Terms

Conventional Cylinders

Normal, standard cylinders.

Key Control

Restricted Keyways

Special non-stock keyways set aside for limited use and a higher degree of key control. A letter of authorization from the end user is required to process orders for keys, blanks and cylinders.



Opposing Terms

Open Keyways

Standard keyways available without any ordering formalities. C Family (Everest Conventional) and Obverse (Classic Conventional) keyways are open. All others are restricted.

Cylinder Category

Small Format Interchangeable Core (SFIC)

A core completely interchangeable with Best, Falcon, etc. No Primus version exists. Pins, springs, keys and keyways are based on a plug diameter smaller than the standard 1/2".



Opposing Terms

Full Size

Pertaining to cylinders (including interchangeable cores), keys and keyways based on the industry standard plug diameter of about 1/2".

Administrative Offices

1915 Jamboree Drive, Suite 165
Colorado Springs, CO 80920
(719) 264-5300
FAX (719) 264-5382

Commercial Customer Service

1915 Jamboree Drive, Suite 165
Colorado Springs, CO 80920
(800) 847-1864
FAX (800) 452-0663
Order Entry
FAX (800) 452-0665

International Division

Ingersoll-Rand Architectural Hardware
1076 Lakeshore Road East
Mississauga, Ontario, L5E 1E4, Canada
(905) 278-6128
FAX (905) 278-1413

Internet

<http://www.schlage.com>

Fax-On-Demand

(888) 321-3228

IR Security & Safety Americas

111 Congressional Boulevard
STE 200
Carmel, IN 46032
800-847-1864
800-452-0663 Fax
www.irsecurityandsafety.com

An  **Ingersoll-Rand** business



Free Manuals Download Website

<http://myh66.com>

<http://usermanuals.us>

<http://www.somanuals.com>

<http://www.4manuals.cc>

<http://www.manual-lib.com>

<http://www.404manual.com>

<http://www.luxmanual.com>

<http://aubethermostatmanual.com>

Golf course search by state

<http://golfingnear.com>

Email search by domain

<http://emailbydomain.com>

Auto manuals search

<http://auto.somanuals.com>

TV manuals search

<http://tv.somanuals.com>