

48049-183-02

09/01

Cedar Rapids IA, USA

ECN 161A

Instruction Bulletin

Full-function Test Kit

v 1.0

Retain for future use.



Merlin Gerin

Modicon

Square D

Telemecanique

Federal Pioneer

Federal Pacific

Schneider
 **Electric**

NOTICE

Read these instructions carefully and look at the equipment to become familiar with the device before trying to install, operate, service or maintain it. The following special messages may appear throughout this bulletin or on the equipment to warn of potential hazards or to call attention to information that clarifies or simplifies a procedure.



The addition of either symbol to a "Danger" or "Warning" safety label indicates that an electrical hazard exists which will result in personal injury if the instructions are not followed.



This is the safety alert symbol. It is used to alert you to potential personal injury hazards. Obey all safety messages that follow this symbol to avoid possible injury or death.

DANGER

DANGER indicates an imminently hazardous situation which, if not avoided, **will result in** death or serious injury.

WARNING

WARNING indicates a potentially hazardous situation which, if not avoided, **can result in** death or serious injury.

CAUTION

CAUTION indicates a potentially hazardous situation which, if not avoided, **can result in** minor or moderate injury.

CAUTION

CAUTION, used without the safety alert symbol, indicates a potentially hazardous situation which, if not avoided, **can result in** property damage.

NOTE: Provides additional information to clarify or simplify a procedure.

Electrical equipment should be serviced only by qualified personnel. No responsibility is assumed by Schneider Electric for any consequences arising out of the use of this material. This document is not intended as an instruction manual for untrained persons.

This equipment has been tested and found to comply with the limits for a Class A digital device, pursuant to part 15 of the FCC Rules. These limits are designed to provide reasonable protection against harmful interference when the equipment is operated in a commercial environment. This equipment generates, uses, and can radiate radio frequency energy and, if not installed and used in accordance with the instruction manual, may cause harmful interference to radio communications. Operation of this equipment in a residential area is likely to cause harmful interference in which case the user will be required to correct the interference at his own expense.

Table of Contents

Full-function Test Kit Identification	4
Technical Specifications	5
Determining Trip Unit Compatibility	5
Connections	5
Connecting Power Cord	6
COMPACT® NS Circuit Breakers Equipped with STR Trip Units.....	6
MICROLOGIC® and ET Trip Units	6
Power-on Test.....	7
Language Selection	8
From Full-function Test Kit Title Screen	8
From Select Test Kit Function Screen.....	8
Secondary Injection Testing.....	9
Secondary Injection Test Setup Procedures	9
Configuring Circuit Breaker Parameters.....	9
Automatic Trip Curve Test (All Trip Units Except STR22ME)	12
Configuring Protection Parameters.....	13
Configuring Automatic Trip Curve Test.....	13
Saving Test Files	14
Automatic Trip Curve Test (STR22ME Trip Unit Only).....	15
Configuring Protection Parameters.....	15
Configuring Automatic Trip Curve Test.....	16
Saving Test Files	17
Manual Trip Curve Test (All Trip Units Except STR22ME).....	18
Saving Test Files	19
Manual Trip Curve Test (STR22ME Trip Unit Only).....	20
Saving Test Files	21
Mechanical Operation Trip Test	22
Zone-selective Interlocking Test	23
Inhibit Functions	25
Ground-fault Inhibit.....	25
Thermal-imaging Inhibit	27
Viewing and Deleting Test Files.....	29
Viewing Previously Saved Test Files.....	29
Deleting Previously Saved Test Files.....	30
Deleting One Saved Test File.....	30
Deleting All Saved Test Files.....	31
Configuring Full-function Test Kit Options.....	32
Language Selection.....	32
Setting Display Screen Backlight.....	32
Setting Display Screen Contrast.....	32
Maintenance.....	33
Fuse Replacement	33
Calibration	33
Cleaning	33
Troubleshooting	34
General.....	34
Error Messages	36
Glossary	37

FULL-FUNCTION TEST KIT IDENTIFICATION



Figure 1: Full-function Test Kit and Case Contents

Technical Specifications

Table 1: Full-function Test Kit Technical Specifications

Parameter		Value	
Fuse	120 Vac Applications	2 A, 250 Vac, Fast-blow (Recommended Fuse: Bussman Part No. AGC-2)	
	230 Vac Applications	1A, 250 Vac, Fast-blow (Recommended Fuse: Bussman Part No. AGC-1)	
Nominal Operating Voltage		115–230 Vac	
Operating Voltage Range		102–144 Vac 207–253 Vac	
Operating Frequency		50 Hz 60 Hz	
Operating Temperature		-20–50 °C	
Storage Temperature		-20–60 °C	
24 Vdc Power	Nominal Voltage	24 Vdc	
	Tolerance	22.8–25.2 Vdc	
	Maximum Output Current	100 mA	
Trip Time Measurement	Accuracy	±5 mS	
	Resolution	1 mS	
	Range	0–3000 sec.	
Fault Signal	Voltage Source	Accuracy (Percent Error in Amplitude + Percent Error in Frequency)	±3%
		Nominal Frequency	60 Hz
		Amplitude Range	0.031–21.5 at 60 Hz Vrms
	Current Source	Accuracy	±3%
		Amplitude Range	0.020–2.3 Amperes dc
Installation Category (Overvoltage Category)		Category II	
Maximum Power Rating		60 W	

Determining Trip Unit Compatibility

Table 2: Trip Unit Compatibility

Trip Unit Family/Type		Test Cable	Test Functions				Inhibit Functions	
			Automatic Trip	Manual Trip	Mechanical Operation	ZSI Function	Ground-fault Inhibit	Thermal-imaging Inhibit
Non-communicating	STR22ME, STR22GE, STR22SE, STR23SE, STR23SP, STR43ME	2-Pin Test Cable	■	■	■			
	STR53UP, STR53UE	7-Pin Test Cable	■	■	■			
	ET 1.0, ET 1.0I, ET 1.0M		■	■	■			
Communicating	MICROLOGIC 2.0, 3.0, 5.0	7-Pin Test Cable	■	■	■	■		■
	MICROLOGIC 2.0A, 3.0A, 5.0A, 7.0A		■	■	■	■		■
	MICROLOGIC 5.0P, 5.0H, 7.0P, 7.0H		■	■	■	■	■	■
	MICROLOGIC 6.0A, 6.0P, 6.0H		■	■	■	■	■	

CONNECTIONS

Connecting Power Cord

COMPACT® NS Circuit Breakers Equipped with STR Trip Units

The power cord, test cables, keys and instruction bulletin are located in lid compartment of Full-function Test Kit case. Refer to Table 2 to determine which tests and functions are applicable then follow appropriate connection procedures below.

1. Connect socket end of power cord to power cord receptacle on Full-function Test Kit.
2. Plug other end of power cord into a grounded outlet.

NOTE: If Full-function Test Kit is used in a noisy environment, power cord ground connection must be connected to same potential as chassis of circuit breaker being tested.

1. Connect test cable 10-pin connector (A) to 10-pin port on Full-function Test Kit.
2. Connect test cable 2-pin connector (B) to test port on STR trip units. Make sure to observe correct polarity.

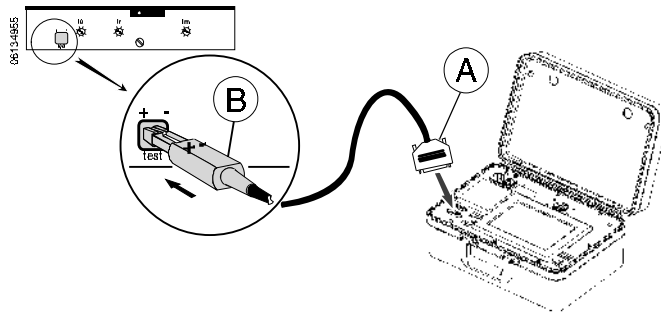

Figure 2: Connection to STR Trip Units

MICROLOGIC® and ET Trip Units

1. Connect test cable 10-pin connector (A) to 10-pin port on Full-function Test Kit.

CAUTION
HAZARD OF EQUIPMENT DAMAGE
Pins on test cable 7-pin connector (see Figs. 4 and 5) can bend or break if forced. Avoid using excess force when connecting to trip unit test port.
Failure to follow this instruction can result in equipment damage.

2. Connect test cable 7-pin connector (B) to test port on MICROLOGIC trip units.
 - A. To plug in, push in 7-pin connector and turn clockwise.
 - B. To unplug, push in 7-pin connector and turn counterclockwise.

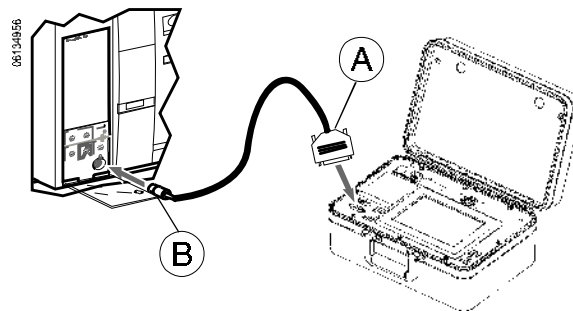

Figure 3: Connection to MICROLOGIC and ET Trip Units

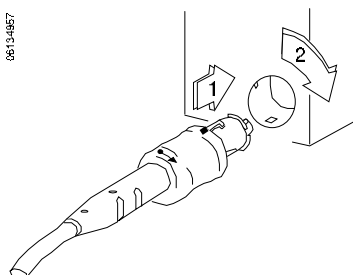

Figure 4: Plug in 7-pin connector

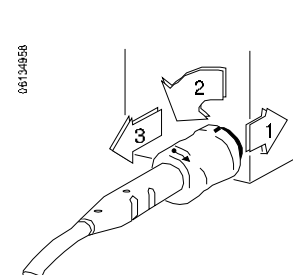

Figure 5: Unplug 7-pin connector

POWER-ON TEST

This test, performed each time the Full-function Test Kit power switch is turned on, verifies memory has not been corrupted. It also confirms functionality of interface screen.

Spinning Schneider Electric logo (Fig. 6) is displayed on interface screen during power-on test. If logo continues to spin longer than ten seconds, Full-function Test Kit has failed power-on test. If Full-function Test Kit passes test, spinning logo screen will advance to Full-Function Test Kit title screen (Fig. 7).

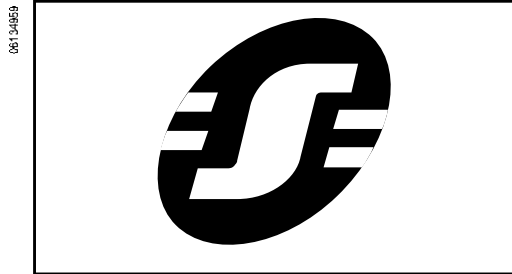

Figure 6: Power-on Test Screen

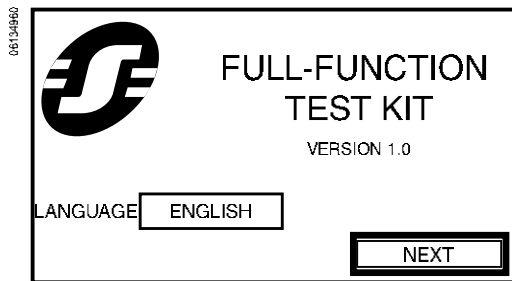

Figure 7: Full-function Test Kit Title Screen

LANGUAGE SELECTION

From Full-function Test Kit Title Screen

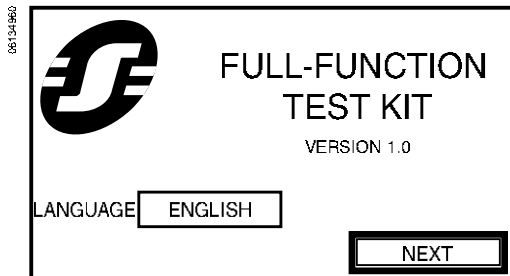

Figure 8: Full-function Test Kit Title Screen

The Full-function Test Kit supports English, French, Spanish, German and Italian. The language setting can be changed in two places.

NOTE: Pressing a language touch key on Select Language screen will automatically change all Full-function Test Kit language settings.

1. From Full-function Test Kit title screen, press Language touch key.

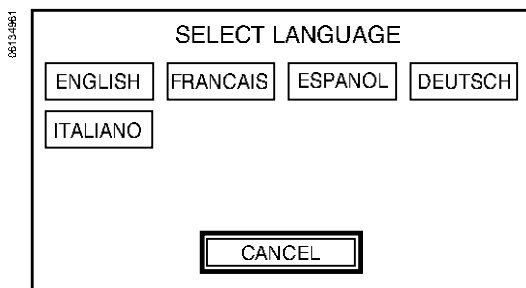

Figure 9: Select Language Screen

2. Select appropriate language setting from Select Language screen. Display screen will return to Full-function Test Kit title screen (Fig. 8).

From Select Test Kit Function Screen

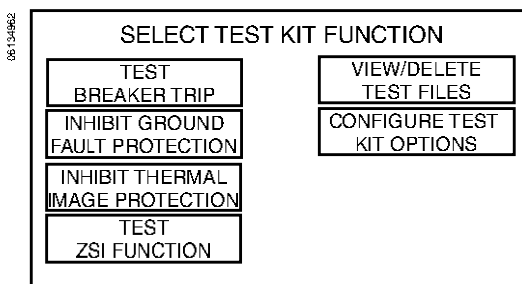

Figure 10: Select Test Kit Function Screen

NOTE: Pressing a language touch key on Select Language screen will automatically change all Full-function Test Kit language settings.

1. From Select Test Kit Function screen press Configure Test Kit Options. Display screen will advance to Configure Test Kit Options screen.



Figure 11: Configure Test Kit Options Screen

2. From Configure Test Kit Options screen press Language touch key.
3. Select appropriate language setting from Select Language screen (Fig. 9). Display screen will return to Configure Test Kit Options screen (Fig. 11).

SECONDARY INJECTION TESTING

Secondary Injection Test Setup Procedures

⚠ DANGER

HAZARD OF ELECTRIC SHOCK, BURN, OR EXPLOSION

- This equipment must be installed and serviced only by qualified electrical personnel.
- Turn off all power supplying this equipment before working on or inside equipment.
- Always use a properly rated voltage sensing device to confirm power is off.
- Replace all devices, doors and covers before turning on power to this equipment.

Failure to follow these instructions will result in death or serious injury.

The following set-up procedures apply to automatic, manual and mechanical secondary injection tests.

From Select Test Kit Function screen press TEST BREAKER TRIP to advance to Configure Circuit Breaker Parameters screen.

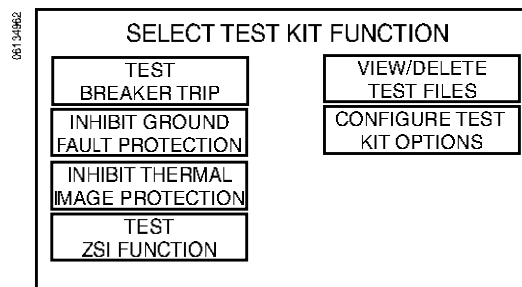

Figure 12: Select Test Kit Function Screen

CONFIGURING CIRCUIT BREAKER PARAMETERS

Parameters selected on Configure Circuit Breaker Parameters screen determine type and magnitude of fault to be injected into circuit breaker during secondary injection test. Values must be selected for all parameters on Configure Circuit Breaker Parameters screen before advancing to next screen.

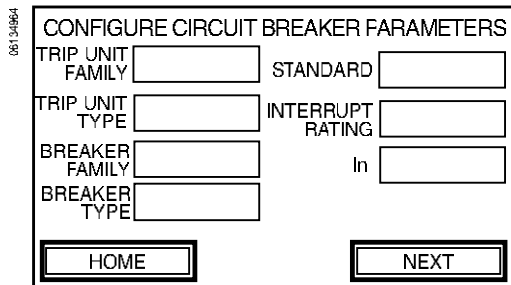

Figure 13: Configure Circuit Breaker Parameters Screen

1. Press touch key beside each parameter name to select its value. Refer to Figures 14 and 15 for examples of parameter value locations on circuit breaker labels and trip units. Parameter input sequence is controlled by Full-function Test Kit according to the following hierarchy:

- TRIP UNIT FAMILY—select trip unit family (see Table 2 for compatibility)
- TRIP UNIT TYPE—select trip unit type (see Table 2 for compatibility)
- STANDARD—choose electrical standard for circuit breaker (UL, IEC, ANSI or CCEE)
- BREAKER FAMILY—select circuit breaker family (COMFACT, MASTERFACT or POWERFACT)
- BREAKER TYPE—select type of circuit breaker (NS, NSJ, ET, NT, NW, M, P or R)
- INTERRUPT RATING—choose interrupting rating for circuit breaker
- In—select trip unit sensor plug rating

Parameters must be selected according to the hierarchy outlined above. An empty touch key next to a parameter label indicates its value must be selected before moving to next parameter touch key. Parameter values displayed in reverse video either have only one available option which cannot be altered or are automatically determined by means of communication between Full-function Test Kit and a communicating trip unit. If these preset values are incorrect, refer to the trip unit instruction bulletin for more details.

NOTE: Verify that each parameter value is correct before continuing to next screen. Full-function Test Kit records parameter values entered from most recent secondary injection test performed.

06134965 06134966 06134967

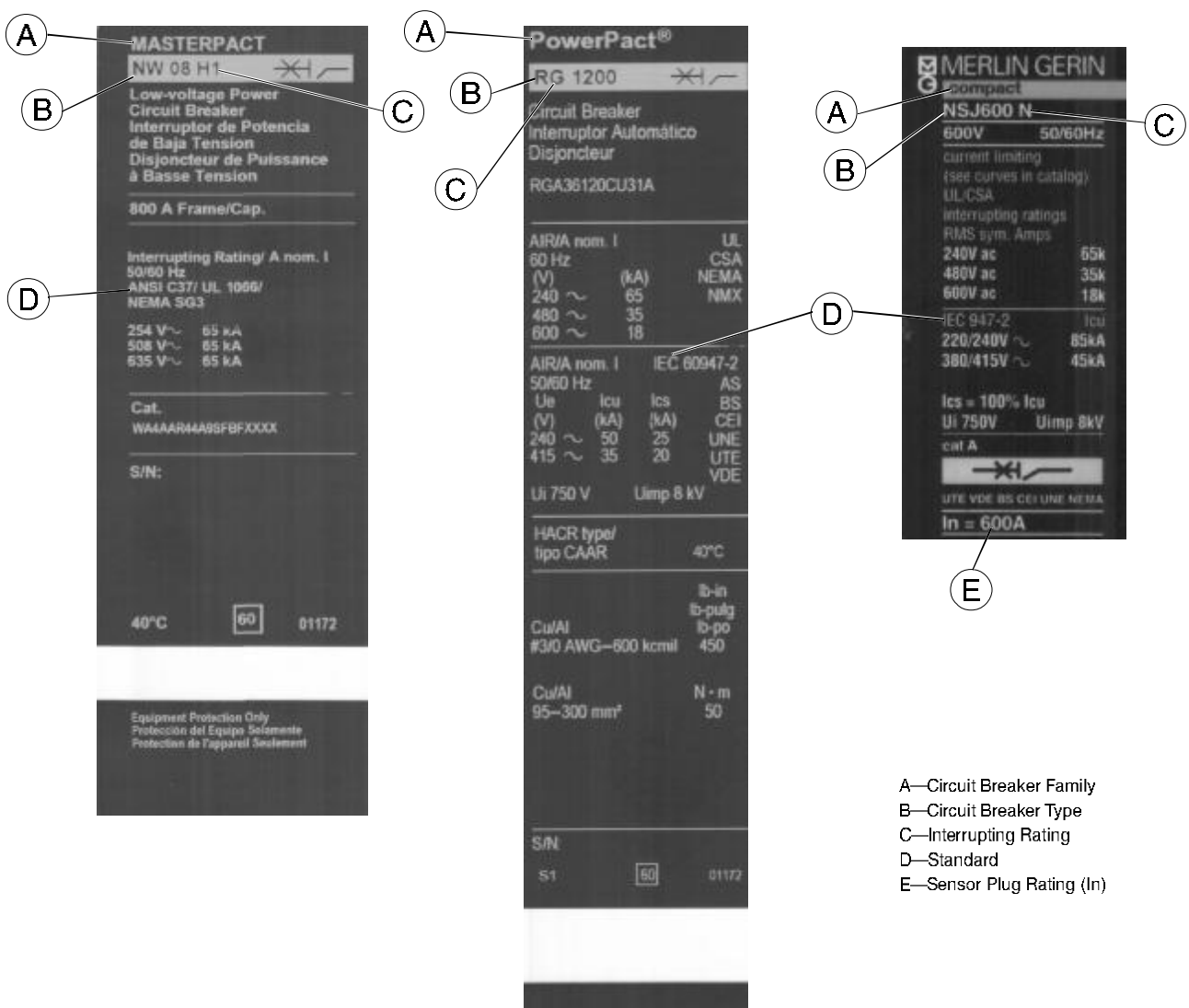

- A—Circuit Breaker Family
- B—Circuit Breaker Type
- C—Interrupting Rating
- D—Standard
- E—Sensor Plug Rating (In)

Figure 14: Circuit Breaker Label Examples for Configure Circuit Breaker Parameters Screen

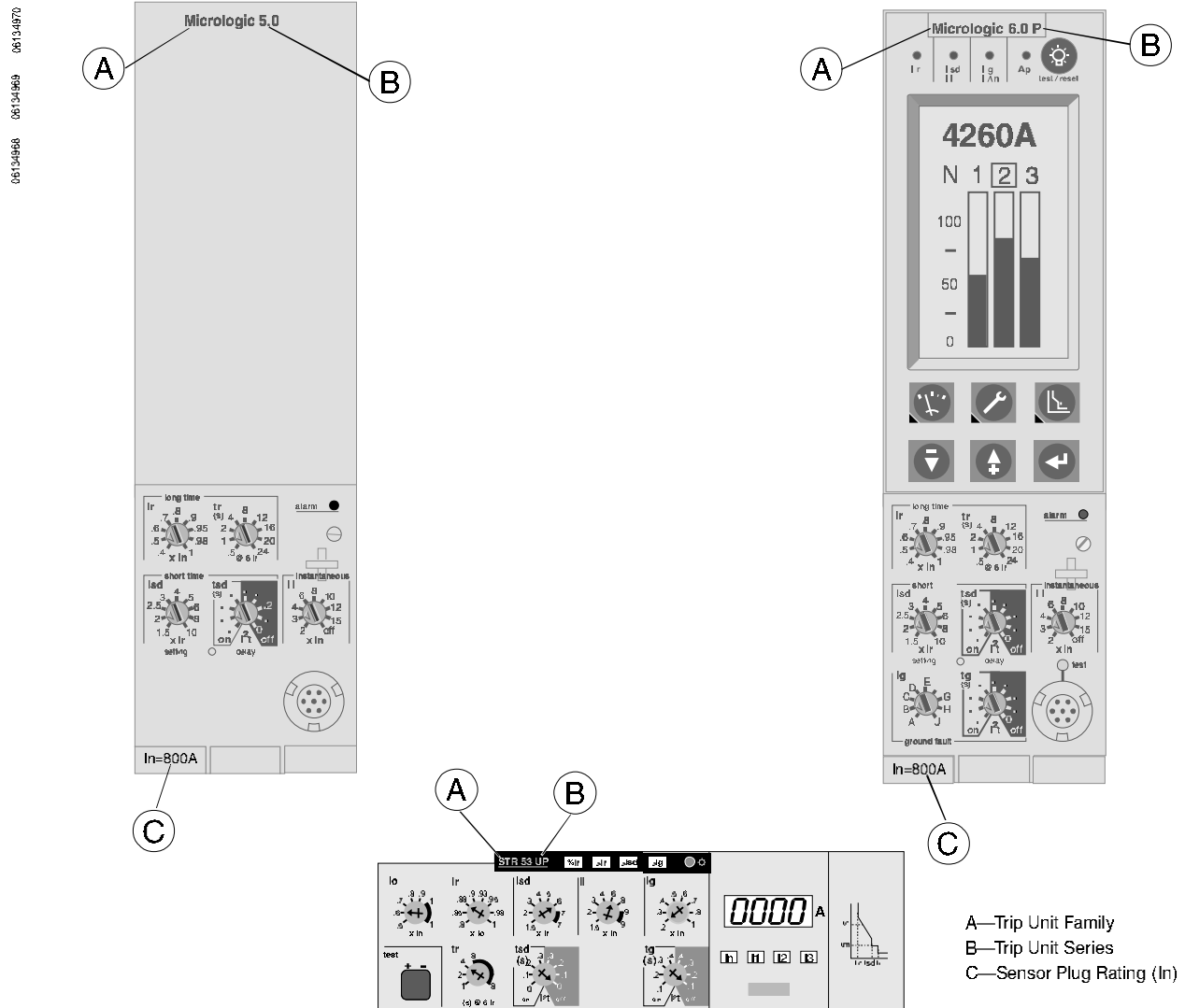

Figure 15: Trip Unit Examples for Configure Circuit Breaker Parameters Screen

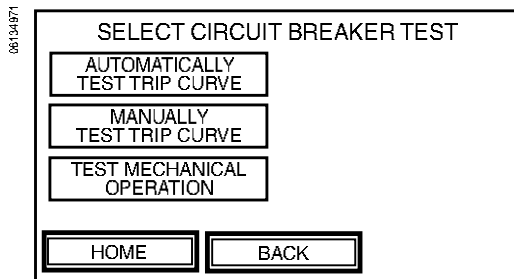

Figure 16: Select Circuit Breaker Test Screen

- Once all parameter values have been entered and confirmed on the Configure Circuit Breaker Parameters screen (Fig. 13), press NEXT to advance to Select Circuit Breaker Test screen.

NOTE:

- Parameter values displayed in reverse video either have only one available option which cannot be altered or are automatically determined by means of communication between Full-function Test Kit and a communicating trip unit. For all trip units, Full-function Test Kit identifies trip unit family/type by connection of either 2-pin or 7-pin test cable. For communicating MICROLOGIC trip units (see Table 2), Full-function Test Kit identifies sensor plug value and all available pickup and delay settings for LSIG protection for device being tested. In addition to reading these values, Full-function Test Kit can read BREAKER FAMILY, BREAKER TYPE, INTERRUPT RATING and STANDARD for MICROLOGIC P- and H-type trip units if these trip units have been properly configured.
- Verify values for device parameters are correct before continuing with test. Full-function Test Kit records values entered from previous secondary injection test performed.
- For MICROLOGIC trip units, circuit breaker will be ZSI self-restrained for both equipment ground-fault and short-time protection during secondary injection testing.
- Contact wear counter on MICROLOGIC P- and H-type trip units will not increment during secondary injection testing.
- All advanced protections, logging of trips, logging of alarms and activation of alarms are disabled during secondary injection testing for MICROLOGIC P- and H-type trip units. Refer to trip unit instruction bulletin for more information on these functions.
- Full-function Test Kit cannot disable thermal imaging on non-communicating trip units (see Table 2). Therefore, a 15-minute delay must be observed from the last long-time trip test performed until the next long-time trip test performed.
- SDE counter, located in circuit breaker communication module (BCM), will increment each time circuit breaker opens due to a fault secondary injected by Full-function Test Kit. Refer to trip unit instruction bulletin for more information regarding this condition.
- Full-function Test Kit will only test residual equipment ground-fault protection. Systems using Modified Differential Ground Fault (MDGF) and Ground Source Return cannot be tested.
- For MICROLOGIC 7.0A, 7.0H and 7.0P trip units, Full-function Test Kit cannot test earth leakage pickup and delay (VIGI) protection. Full-function Test Kit will only test LSI protection functions of the circuit breaker.
- For MICROLOGIC A-type trip units only, performing secondary injection test will reset to zero maximum recorded value on each phase. If necessary, record maximum values before testing.

**Automatic Trip Curve Test (All Trip Units
Except STR22ME)**

This mode provides an automated test of circuit breaker time-current curve, allowing Full-function Test Kit to verify long-time, short-time, instantaneous and ground-fault functions. Full-function Test Kit injects secondary fault signals based on trip unit and circuit breaker pickup and delay settings to measure amount of time delay before trip signal is initiated. This data is automatically compared to circuit breaker time-current curve to determine if device is within tolerance. This comparison of data will determine which specific protection functions passed or failed.

NOTE: Test points are chosen to minimize test time required to adequately test each trip curve segment.

NOTE:

- Parameter values displayed in reverse video either have only one available option which cannot be altered or are automatically determined by means of communication between Full-function Test Kit and a communicating trip unit. For all trip units, Full-function Test Kit identifies trip unit family/type by connection of either 2-pin or 7-pin test cable. For communicating MICROLOGIC trip units (see Table 2), Full-function Test Kit identifies sensor plug value and all available pickup and delay settings for LSIG protection for device being tested. In addition to reading these values, Full-function Test Kit can read BREAKER FAMILY, BREAKER TYPE, INTERRUPT RATING and STANDARD for MICROLOGIC P- and H-type trip units if these trip units have been properly configured.
- Verify values for device parameters are correct before continuing with test. Full-function Test Kit records values entered from previous secondary injection test performed.
- For MICROLOGIC trip units, circuit breaker will be ZSI self-restrained for both equipment ground-fault and short-time protection during secondary injection testing.
- Contact wear counter on MICROLOGIC P- and H-type trip units will not increment during secondary injection testing.
- All advanced protections, logging of trips, logging of alarms and activation of alarms are disabled during secondary injection testing for MICROLOGIC P- and H-type trip units. Refer to trip unit instruction bulletin for more information on these functions.
- Full-function Test Kit cannot disable thermal imaging on non-communicating trip units (see Table 2). Therefore, a 15-minute delay must be observed from the last long-time trip test performed until the next long-time trip test performed.
- SDE counter, located in circuit breaker communication module (BCM), will increment each time circuit breaker opens due to a fault secondary injected by Full-function Test Kit. Refer to trip unit instruction bulletin for more information regarding this condition.
- Full-function Test Kit will only test residual equipment ground-fault protection. Systems using Modified Differential Ground Fault (MDGF) and Ground Source Return cannot be tested.
- For MICROLOGIC 7.0A, 7.0H and 7.0P trip units, Full-function Test Kit cannot test earth leakage pickup and delay (VIGI) protection. Full-function Test Kit will only test LSI protection functions of the circuit breaker.
- For MICROLOGIC A-type trip units only, performing secondary injection test will reset to zero maximum recorded value on each phase. If necessary, record maximum values before testing.

**Automatic Trip Curve Test (All Trip Units
Except STR22ME)**

This mode provides an automated test of circuit breaker time-current curve, allowing Full-function Test Kit to verify long-time, short-time, instantaneous and ground-fault functions. Full-function Test Kit injects secondary fault signals based on trip unit and circuit breaker pickup and delay settings to measure amount of time delay before trip signal is initiated. This data is automatically compared to circuit breaker time-current curve to determine if device is within tolerance. This comparison of data will determine which specific protection functions passed or failed.

NOTE: Test points are chosen to minimize test time required to adequately test each trip curve segment.

CONFIGURING PROTECTION PARAMETERS

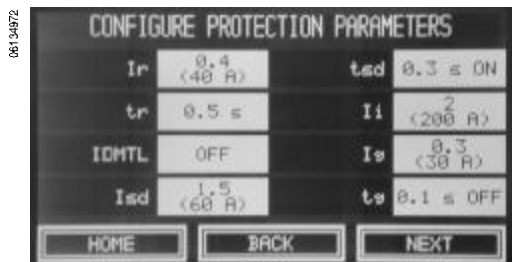

Figure 17: Configure Protection Parameters Screen

1. Follow secondary injection test setup procedures.
2. Choose or confirm the applicable LSIG circuit breaker protection settings on Configure Protection Parameters screen:
 - Io—derating value (STR trip units only).
 - Ir—long-time pickup.
 - tr—long-time delay.
 - IdmtL—inverse definite mean time lag (refer to MICROLOGIC P- or H-type trip unit instruction bulletin for more information.)
 - Isd—short-time pickup.
 - tsd—short-time delay.
 - Ii—instantaneous trip.
 - Ig—ground-fault pickup.
 - tg—ground-fault delay.

NOTE: All applicable values for LSIG protection must be entered before moving to Configure Automatic Trip Curve Test screen.

3. Once all LSIG protection settings are confirmed, press NEXT to advance to Configure Automatic Trip Curve Test screen.

CONFIGURING AUTOMATIC TRIP CURVE TEST



Figure 18: Configure Automatic Trip Curve Test Screen

The parameter touch keys on Configure Automatic Trip Curve Test screen (Long-time, Short-time, Instantaneous and Ground Fault) represent specific segments of a trip unit time-current curve. Some segments may be disabled and appear in reverse video or may not appear at all depending on type and individual settings of trip unit and circuit breaker being tested. Refer to Table 2 for application compatibility. Applicable time-current curve segments can be enabled or disabled by toggling touch key next to the appropriate parameter touch key.

1. Select time-current curve segments to be tested by toggling appropriate touch keys to ENABLED.
2. Press NEXT to proceed to Automatic Trip Curve Test Alert screen.

NOTE: Circuit breaker must be in closed position to guarantee correct test results. Full-function Test Kit will automatically test circuit breaker by injecting appropriate current required to test each enabled section of time-current curve.

NOTE: MICROLOGIC 5.0 trip units with short-time delay setting of I^2t on will fail test on short-time segment of time-current curve. This failure may be due to thermal-imaging feature which causes circuit breaker to trip on long-time function. Refer to trip unit instruction bulletin for more information on thermal imaging. To accurately test short-time segment of time-current curve for MICROLOGIC 5.0 trip unit with short-time delay setting of I^2t on, wait 15 minutes after testing long-time segment of time-current curve, then toggle LONG TIME time touch key on Configure Automatic Trip Curve Test screen (Fig. 18) to DISABLED and perform test. The 15-minute wait period applies each time short-time segment of time-current curve is tested since thermal imaging feature is operable regardless of time-current curve segment being tested.

3. Read alert message, verify circuit breaker is closed and press YES to initiate test.

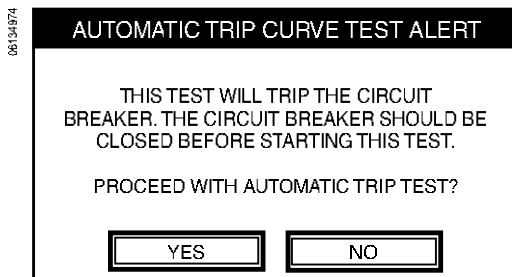

Figure 19: Automatic Trip Curve Test Alert Screen



Figure 20: Automatic Trip Curve Test Screen

⚠ CAUTION

HAZARD OF LOSS OF GROUND-FAULT PROTECTION

Equipment ground-fault protection will be disabled for up to two minutes if test cable is removed from test port on a communicating MICROLOGIC trip unit without properly exiting secondary injection testing function. Wait two minutes before re-energizing circuit breaker.

Failure to follow this instruction can result in injury or equipment damage.

The Automatic Trip Curve Test screen displays a table with three columns:

- INJECTION CURRENT—shows magnitude of current, in amperes, during testing of each segment of time-current curve.
- TRIP TIME—displays time, in seconds, until circuit breaker trips.
- STATUS—indicates testing progress for each protective function.

The following variables can appear in status column:

NOTE: If test cable is removed from test port on a communicating MICROLOGIC trip unit without properly exiting secondary injection testing function, advanced protection, activation of alarms, logging of events, equipment ground-fault protection and thermal imaging may be disabled for up to two minutes after cable has been removed. Circuit breaker may also be ZSI restrained for up to two minutes for equipment ground-fault and short-time protection.

- INITIALIZING (blinking): initializing Full-function Test Kit and trip unit.
- TESTING: injecting fault signal.
- TRIPPED: fault signal caused circuit breaker to trip.
- STOPPING (blinking): exiting test mode.
- STOPPED (user initiated): fault signal removed.
- PASSED: segment of time-current curve passed.
- FAILED: segment of time-current curve failed.
- ERROR: communication error occurred.

4. After each segment of time-current curve is tested, close circuit breaker before continuing to next segment of time-current curve.

The Full-function Test Kit records amount of time required to initiate trip signal for each time-current curve segment and automatically compares results with circuit breaker time-current curve points. After checking each time-current curve segment, STATUS column indicates which functions passed or failed.

NOTE: If performing another long-time trip test, a 15-minute delay must be observed on non-communicating MICROLOGIC, ET and STR trip units to allow reset of thermal memory.

SAVING TEST FILES



Figure 21: Save Test File Screen

1. From Automatic Trip Curve Test screen, press NEXT to advance to Save Test File screen. Results of up to 50 completed time-current curve tests can be saved.
2. A default test file name is automatically provided in the FILE NAME touch key. To change default file name press FILE NAME touch key to bring up keypad screen and enter a new file name.
3. Toggle SAVE MODE touch key to indicate whether file is new (CREATE) or replacing an existing file (OVERWRITE).

NOTE: If 50 files already exist it will be necessary to overwrite one of them. If no files exist, OVERWRITE option is not selectable.



Figure 22: Test File Status Screen

4. Press NEXT to save file and proceed to TEST FILE STATUS screen.

Automatic Trip Curve Test (STR22ME Trip Unit Only)

This mode provides an automated test of the circuit breaker time-current curve. This function allows Full-function Test Kit to verify long-time, short-time and instantaneous functions. Full-function Test Kit injects secondary fault signals based on trip unit settings and measures amount of time delay before trip signal is initiated. This data will then automatically be compared to circuit breaker time-current to determine if device is within tolerance. This comparison of data will determine which specific functions passed or failed.

CONFIGURING PROTECTION PARAMETERS

1. Follow secondary injection test setup procedures.
2. Set trip unit long-time pickup to minimum value.

NOTE: The Full-function Test Kit cannot accurately detect when circuit breaker has tripped if pickup setting is higher than minimum value. If pickup setting is normally set higher than minimum value, record the value so it can be reset after testing is complete.



Figure 23: Configure Protection Parameters Screen

3. From Configure Protection Parameters screen, press Ir touch key.

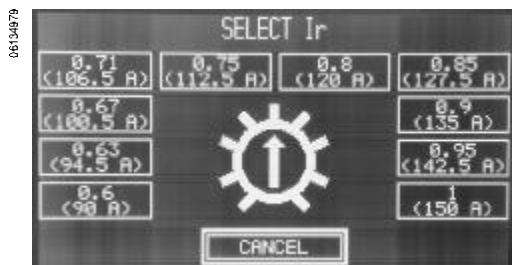

Figure 24: Select Ir Screen

4. Choose minimum long-time pickup (Ir) dial setting on Select Ir screen.
5. Press NEXT to advance to Configure Automatic Trip Curve Test screen.

CONFIGURING AUTOMATIC TRIP CURVE TEST



Figure 25: Configure Automatic Trip Curve Test Screen

The parameter touch keys on Configure Automatic Trip Curve Test screen (Long-time, Short-time and Instantaneous) represent specific segments of a trip unit time-current curve. Some segments may be disabled and appear in reverse video or may not appear at all depending on type and individual settings of trip unit and circuit breaker being tested. Refer to Table 2 for application compatibility. Applicable time-current curve segments can be enabled or disabled by toggling touch key next to the appropriate touch key label.

1. Select time-current curve segments to be tested by toggling appropriate touch keys to ENABLED.
2. Press NEXT to proceed to Automatic Trip Curve Test Alert screen.

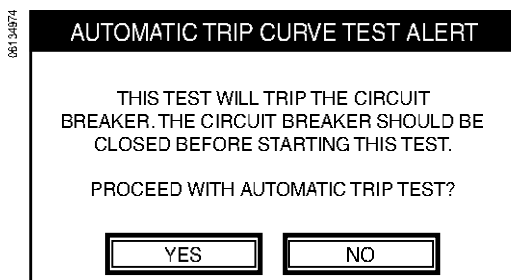

Figure 26: Automatic Trip Curve Test Alert Screen

NOTE: Circuit breaker must be in closed position to guarantee correct test results. Full-function Test Kit will then automatically test circuit breaker by injecting appropriate current required to test each enabled section of time-current curve.

3. Read alert message, verify circuit breaker is closed and press YES to initiate test.



Figure 27: Automatic Trip Curve Test Screen

The Automatic Trip Curve Test screen displays a table with three columns:

- INJECTION CURRENT—shows magnitude of current, in amperes, during testing of each segment of time-current curve.
- TRIP TIME—displays time, in seconds, until circuit breaker trips.
- STATUS—indicates testing progress for each protective function.

The following variables can appear in status column:

- INITIALIZING (blinking): initializing Full-function Test Kit and trip unit.
- TESTING: injecting fault signal.
- TRIPPED: fault signal caused circuit breaker to trip.
- STOPPING (blinking): exiting test mode.
- STOPPED (user initiated): fault signal removed.
- PASSED: segment of time-current curve passed.
- FAILED: segment of time-current curve failed.
- ERROR: communication error occurred.

4. After each segment of time-current curve is tested, close circuit breaker before continuing to next segment of time-current curve.

The Full-function Test Kit records amount of time required to initiate trip signal for each time-current curve segment and automatically compares results with circuit breaker time-current curve points. After checking each time-current curve segment, STATUS column indicates which functions passed or failed.

NOTE: If performing another long-time trip test, a 15-minute delay must be observed on non-communicating MICROLOGIC, ET and STR trip units to allow reset of thermal memory.

5. Restore trip unit long-time pickup setting to original value.

SAVING TEST FILES



Figure 28: Save Test File Screen

1. From Automatic Trip Curve Test screen, press NEXT to advance to Save Test File screen. Results of up to 50 completed time-current curve tests can be saved.
2. A default test file name is automatically provided in the FILE NAME touch key. To change default file name press FILE NAME touch key to bring up keypad screen and enter a new file name.
3. Toggle SAVE MODE touch key to indicate whether file is new (CREATE) or replacing an existing file (OVERWRITE).

NOTE: If 50 files already exist it will be necessary to overwrite one of them. If no files exist, OVERWRITE option is not selectable.



Figure 29: Test File Status Screen

4. Press NEXT to save file and proceed to TEST FILE STATUS screen.

Manual Trip Curve Test (All Trip Units Except STR22ME)

This test allows manual current injection specifications regardless of trip unit settings. Full-function Test Kit monitors and displays trip time associated with selected current. Trip times reported by Full-function Test Kit must be manually compared to a published trip unit time-current curve for trip unit being tested.

1. Follow secondary injection test setup procedures.
2. From Configure Manual Trip Curve Test screen, press INJECTION CURRENT touch key to advance to Select Injection Current screen.



Figure 30: Configure Manual Trip Curve Test Screen

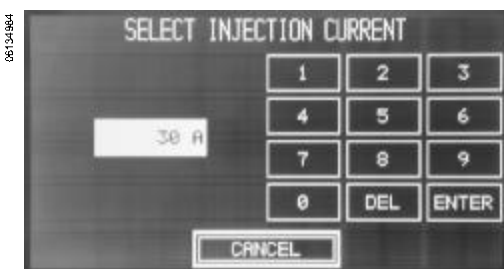

Figure 31: Select Injection Current Screen

3. Use numerical keypad to type in desired fault current in amperes.
4. Press ENTER to return to Configure Manual Trip Curve Test screen (Fig. 30).
5. From Configure Manual Trip Curve Test screen, scroll TRIP TYPE touch key to select segment of time-current curve to be tested (Long-time, Short-time, Instantaneous or Ground-fault).

NOTE: Make sure TRIP TYPE value matches exact segment of time-current curve to be tested. If incorrect value is selected for fault injected, circuit breaker may trip too fast or too slow. When performing secondary injection testing on all STR trip units, injected fault signal is dc current. The amplitude of dc signal will either simulate RMS value or peak value depending on TRIP TYPE option selected. If LONG TIME is selected, signal injected will simulate RMS value of an actual fault signal seen at iron core CT secondary windings. If INSTANTANEOUS is selected, signal injected simulates peak value of actual fault signal seen at iron core CT secondary windings.

6. Press NEXT to proceed to Manual Trip Curve Test Alert screen.

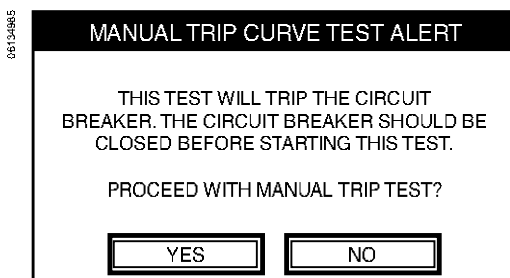

Figure 32: Manual Trip Curve Test Alert Screen

7. Read alert message, verify circuit breaker is closed and press YES to initiate test.



Figure 33: Manual Trip Curve Test Screen

CAUTION

HAZARD OF LOSS OF GROUND-FAULT PROTECTION

Equipment ground-fault protection will be disabled for up to two minutes if test cable is removed from test port on a communicating MICROLOGIC trip unit without properly exiting secondary injection testing function. Wait two minutes before re-energizing circuit breaker.

Failure to follow this instruction can result in injury or equipment damage.

The Manual Trip Curve Test screen displays a table with three columns:

- INJECTION CURRENT—shows magnitude of current, in amperes, during testing of each segment of time-current curve.
- TRIP TIME—displays time, in seconds, until circuit breaker trips.
- STATUS—indicates testing progress for each protective function.

The following variables can appear in status column:

NOTE: If test cable is removed from test port on a communicating MICROLOGIC trip unit without properly exiting secondary injection testing function, advanced protection, activation of alarms, logging of events, equipment ground-fault protection and thermal imaging may be disabled for up to two minutes after cable has been removed. Circuit breaker may also be ZSI restrained for up to two minutes for equipment ground-fault and short-time protection.

- INITIALIZING (blinking): initializing Full-function Test Kit and trip unit.
- TESTING: injecting fault signal.
- STOPPING (blinking): exiting test mode.
- STOPPED (user initiated): fault signal removed.
- TRIPPED: fault signal caused circuit breaker to trip.
- ERROR: communication error occurred.

The Full-function Test Kit records amount of time required to initiate trip signal for each time-current curve segment.

- Once circuit breaker trips, compare value recorded in TRIP TIME column with published time-current curve for circuit breaker being tested.

SAVING TEST FILES



Figure 34: Save Test File Screen

- From Manual Trip Curve Test screen, press NEXT to advance to Save Test File screen. Results of up to 50 completed time-current curve tests can be saved.
- A default test file name is automatically provided in the FILE NAME touch key. To change default file name press FILE NAME touch key to bring up keypad screen and enter a new file name.
- Toggle SAVE MODE touch key to indicate whether file is new (CREATE) or replacing an existing file (OVERWRITE).

NOTE: If 50 files already exist it will be necessary to overwrite one of them. If no files exist, OVERWRITE option is not selectable.



Figure 35: Test File Status Screen

- Press NEXT to save file and proceed to TEST FILE STATUS screen.

Manual Trip Curve Test (STR22ME Trip Unit Only)

The Full-function Test Kit monitors and displays trip time associated with selected current. Trip times reported by Full-function Test Kit must be manually compared to a published trip unit time-current curve for trip unit being tested.

1. Follow secondary injection test setup procedures.
2. Set trip unit long-time pickup to minimum value.

NOTE: The Full-function Test Kit cannot accurately detect when circuit breaker has tripped if pickup setting is higher than minimum value. If pickup setting is normally set higher than minimum value, record the value so it can be reset after testing is complete.

3. From Configure Manual Trip Curve Test screen, press INJECTION CURRENT touch key to advance to Select Injection Current screen.



Figure 36: Configure Manual Trip Curve Test Screen

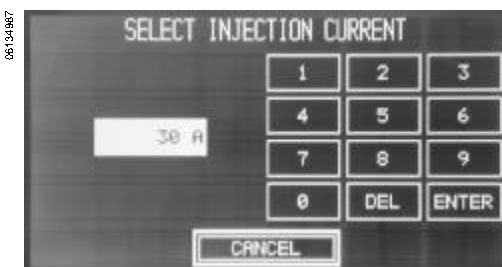

Figure 37: Select Injection Current Screen

4. Use numerical keypad to type in primary current in amperes.
5. Press ENTER to return to Configure Manual Trip Curve Test screen (Fig. 36).
6. From Configure Manual Trip Curve Test screen, scroll TRIP TYPE touch key to select fault type (Long-time, Short-time or Instantaneous).

NOTE: Make sure TRIP TYPE value matches exact segment of time-current curve to be tested. If incorrect value is selected for fault injected, circuit breaker may trip too fast or too slow. When performing secondary injection testing on all STR trip units, injected fault signal is dc current. The amplitude of dc signal will either simulate RMS value or peak value depending on TRIP TYPE option selected. If LONG TIME is selected, signal injected will simulate RMS value of an actual fault signal seen at iron core CT secondary windings. If INSTANTANEOUS is selected, signal injected simulates peak value of actual fault signal seen at iron core CT secondary windings.

7. Press NEXT to proceed to Manual Trip Curve Test Alert screen.
8. Read alert message, verify circuit breaker is closed and press YES to initiate test.

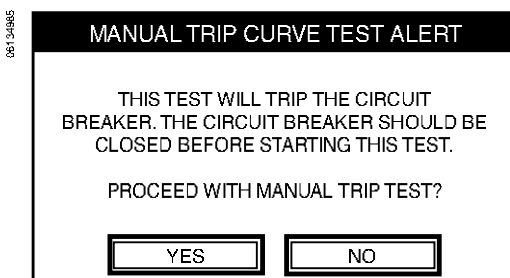

Figure 38: Manual Trip Curve Test Alert Screen



Figure 39: Manual Trip Curve Test Screen

The Manual Trip Curve Test screen displays a table with three columns:

- INJECTION CURRENT—shows magnitude of current, in amperes, during testing of each segment of time-current curve.
- TRIP TIME—displays time, in seconds, until circuit breaker trips.
- STATUS—indicates testing progress for each protective function.

The following variables can appear in status column:

- INITIALIZING (blinking): initializing Full-function Test Kit and trip unit.
- TESTING: injecting fault signal.
- STOPPING (blinking): exiting test mode.
- STOPPED (user initiated): fault signal removed.
- TRIPPED: fault signal caused circuit breaker to trip.
- ERROR: communication error occurred.

The Full-function Test Kit records amount of time required to initiate trip signal for each time-current curve segment.

9. Once circuit breaker trips, compare value recorded in TRIP TIME column with published time-current curve for circuit breaker being tested.

SAVING TEST FILES



Figure 40: Save Test File Screen

1. From Manual Trip Curve Test screen, press NEXT to advance to Save Test File screen. Results of up to 50 completed trip curve tests can be saved.
2. A default test file name is automatically provided in the FILE NAME touch key. To change default file name press FILE NAME touch key to bring up keypad screen and enter a new file name.
3. Toggle SAVE MODE touch key to indicate whether file is new (CREATE) or replacing an existing file (OVERWRITE).

NOTE: If 50 files already exist it will be necessary to overwrite one of them. If no files exist, OVERWRITE option is not selectable.



Figure 41: Test File Status Screen

4. Press NEXT to save file and proceed to TEST FILE STATUS screen.

Mechanical Operation Trip Test

This test verifies trip unit short-circuit protection. Full-function Test Kit supplies power to trip unit while injecting a secondary fault signal large enough to cause tripping and opening of circuit breaker.

1. Follow secondary injection test setup procedures.
2. Make sure circuit breaker is in closed position.
3. From Mechanical Operation Trip Test Alert screen read alert message, verify circuit breaker is closed and press YES to initiate test.
4. Full-function Test Kit injects a fault.
Once Full-function Test Kit has removed fault, it displays a message indicating test is complete.
5. Verify circuit breaker tripped.

06134289

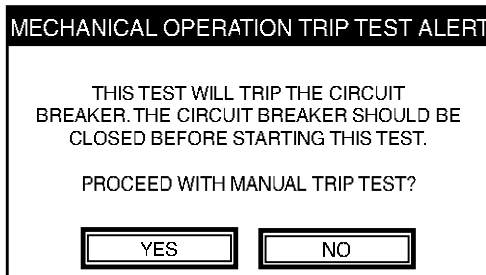

Figure 42: Mechanical Operation Trip Test Screen

ZONE-SELECTIVE INTERLOCKING TEST

This test verifies field wiring between multiple circuit breakers connected in a Zone-selective Interlocking (ZSI) system (see Table 2). While connected to a downstream trip unit, Full-function Test Kit causes trip unit to transmit a ZSI test signal to all connected upstream trip units.

NOTE: Trip units on upstream circuit breakers must support ZSI.

NOTE: Advanced protection and alarms in MICROLOGIC P- and H-type trip units will be disabled. Refer to trip unit instruction bulletin for advanced protection features.

NOTE: If test cable is removed from test port on a communicating MICROLOGIC trip unit without properly exiting ZSI test, advanced protection, activation of alarms and logging of events may be disabled for up to two minutes after cable has been removed. Circuit breaker may also be ZSI restrained for up to two minutes for equipment ground-fault and short-time protection.

1. Press TEST ZSI FUNCTION on Select Test Kit Functions screen.

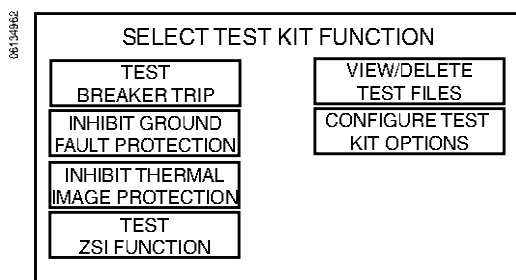

Figure 43: Select Test Kit Function Screen

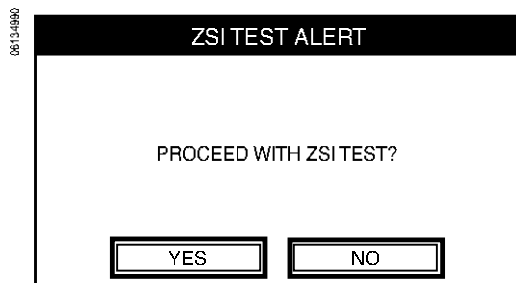

Figure 44: ZSI Test Alert Screen

2. Read alert message and press YES to initiate ZSI test.

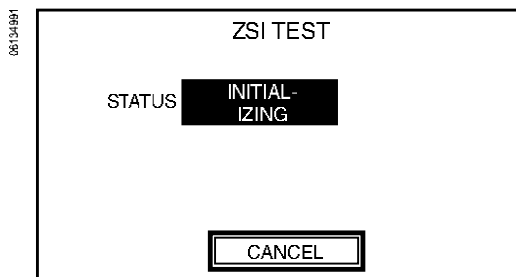

Figure 45: ZSI Test Screen

3. The STATUS display on ZSI Test screen will flash INITIALIZING.

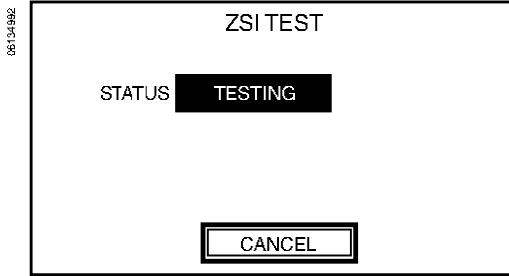

Figure 46: ZSI Test Screen

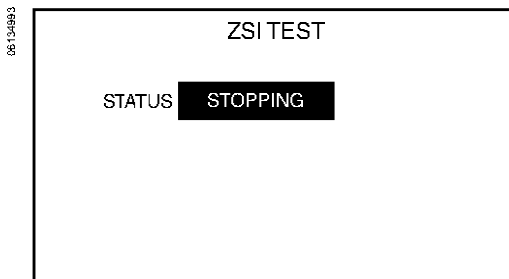

Figure 47: ZSI Test Screen

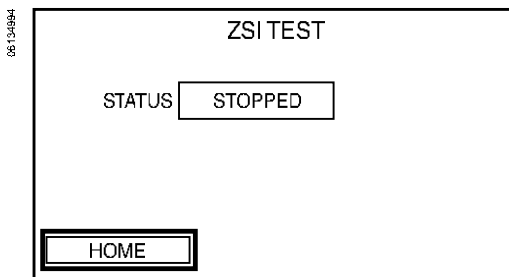

Figure 48: ZSI Test Screen

4. While STATUS display flashes TESTING, ZSI test is in progress. Check that Isd/li and/or Ig trip indicator LEDs are flashing on upstream circuit breakers. A second Full-function Test Kit or a Hand-held Test Kit can be used to power upstream trip unit(s), if necessary.
 - If ground-fault protection only is configured for ZSI, Ig trip indicator LED will flash
 - If short-time protection only is configured for ZSI, Isd/li trip indicator LED will flash
 - If both ground-fault and short-time protection are configured for ZSI, both Ig and Isd/li trip indicator LEDs will flash.
5. Press CANCEL to terminate ZSI test.
6. STATUS display will flash STOPPING to indicate Full-function Test Kit is exiting test mode.
7. Once STOPPED appears in STATUS display, ZSI test is complete.

INHIBIT FUNCTIONS

Inhibit functions are only available during long-time, short-time, instantaneous and ground-fault (LSIG) primary-injection testing of communicating MICROLOGIC trip units (see Table 2). For MICROLOGIC P- and H-type trip units, inhibit functions disable advanced protection, alarms and logging of events. Refer to trip unit instruction bulletin for advanced protection features.

Ground-fault Inhibit

The ground-fault inhibit function allows user to temporarily disable equipment ground-fault protection on MICROLOGIC communicating trip units so as to perform LSI time-current curve testing using single-phase primary injection.

▲ CAUTION

HAZARD OF LOSS OF GROUND-FAULT PROTECTION

Equipment ground-fault protection will be disabled for up to two minutes if test cable is removed from test port on a communicating MICROLOGIC trip unit without properly exiting ground-fault inhibit function. Wait two minutes before re-energizing circuit breaker.

Failure to follow this instruction can result in injury or equipment damage.

NOTE: If test cable is removed from test port on a communicating MICROLOGIC trip unit without properly exiting ground-fault inhibit function, advanced protection, activation of alarms, logging of events, equipment ground-fault protection and thermal imaging may be disabled for up to two minutes after cable has been removed. Circuit breaker may also be ZSI restrained for up to two minutes for equipment ground-fault and short-time protection.

NOTE: The contact wear counter on MICROLOGIC P- and H-type trip units will not increment during the time ground fault is being inhibited.

NOTE: For communicating MICROLOGIC trip units, activating ground-fault inhibit will automatically activate thermal-imaging inhibit and enable zone-selective interlocking (ZSI) self-restraint. Therefore, a 15-minute waiting period between long-time trip tests does not need to be observed to obtain accurate results.

To execute the ground-fault inhibit function:

1. Press INHIBIT GROUND-FAULT PROTECTION on Select Test Kit Function screen.

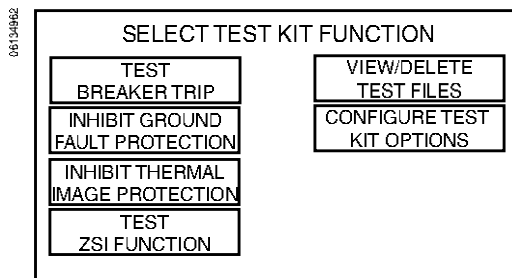

Figure 49: Select Test Kit Function Screen

2. Read alert message and press YES to inhibit ground fault.

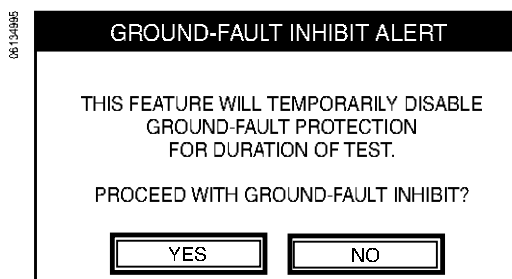

Figure 50: Ground-fault Inhibit Alert Screen

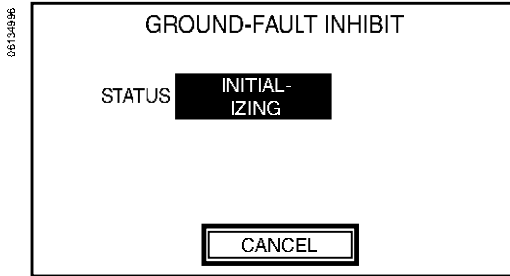

Figure 51: Ground-fault Inhibit Initializing Screen

3. STATUS display on Ground-fault Inhibit screen will flash INITIALIZING for communicating MICROLOGIC trip units.

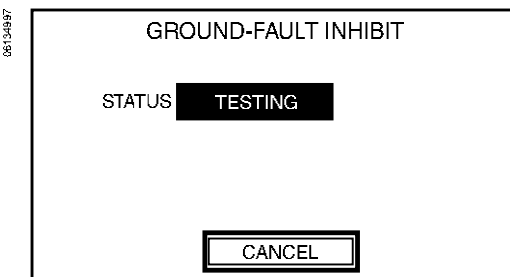

Figure 52: Ground-fault Inhibit Enabled Screen

4. Once STATUS display flashes TESTING, ground-fault and thermal imaging are being inhibited and circuit breaker is ready for primary injection testing.

NOTE: Each time circuit breaker trips, ground-fault inhibit function must be stopped and restarted before performing another primary injection test.

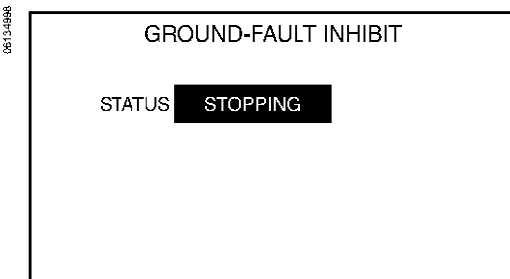

Figure 53: Ground-fault Inhibit Stopping Screen

5. When primary injection testing is completed, press CANCEL to stop ground-fault inhibit function. STATUS display will flash STOPPING to indicate test exit communication between Full-function Test Kit and trip unit.

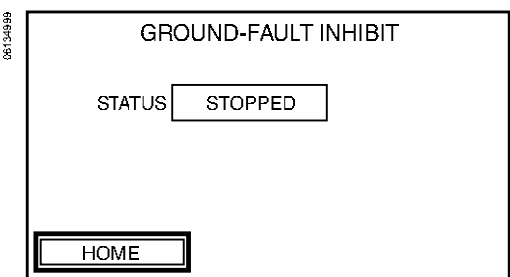

Figure 54: Ground-fault Inhibit Disabled Screen

6. Once STOPPED appears in STATUS display, test exit communication is complete.

Thermal-imaging Inhibit

Thermal-imaging provides continuous temperature rise status of circuit breaker cabling, both before and after a device trips. Under normal conditions a 15-minute delay is required following a device tripping to allow system to cool before returning to normal functionality. The thermal-imaging inhibit function inhibits thermal imaging thus overriding 15-minute delay and allowing for multiple consecutive primary injection tests.

NOTE: If test cable is removed from test port on MICROLOGIC communicating trip unit without properly exiting thermal-imaging inhibit function, advanced protection, activation of alarms, logging of events and thermal imaging may be disabled for up to two minutes after cable has been removed. Circuit breaker may also be ZSI restrained for up to two minutes for short-time protection.

NOTE: Contact wear counter on MICROLOGIC P- and H-type trip units will not increment while thermal imaging is being inhibited.

NOTE: Activating thermal-imaging inhibit will enable zone-selective interlocking (ZSI) self-restraint. Therefore, a 15-minute waiting period between long-time trip tests does not need to be observed to obtain accurate results.

To execute thermal-imaging inhibit function:

1. Press INHIBIT THERMAL IMAGE PROTECTION on Select Test Kit Function screen.

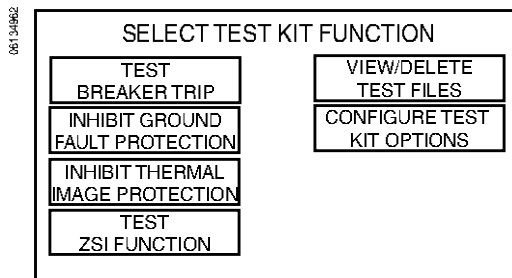

Figure 55: Select Test Kit Function Screen

2. Read alert message and press YES to inhibit thermal imaging.

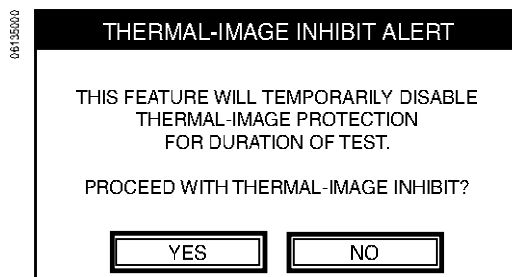

Figure 56: Thermal-image Inhibit Alert Screen

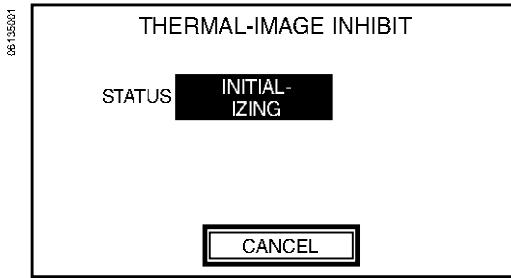

Figure 57: Thermal-image Inhibit Initializing Screen

3. STATUS display on Thermal-image Inhibit screen will flash INITIALIZING.

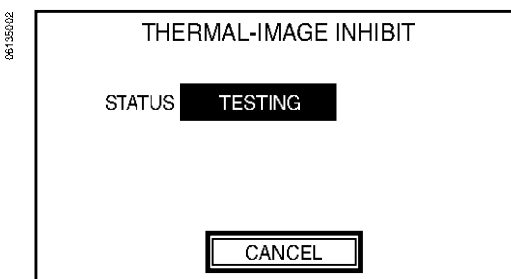

Figure 58: Thermal-image Inhibit Enabled Screen

4. Once STATUS display flashes TESTING thermal imaging is being inhibited and circuit breaker is ready for primary injection testing.

NOTE: Each time circuit breaker trips, thermal-image inhibit function must be stopped and restarted before performing another primary injection test.

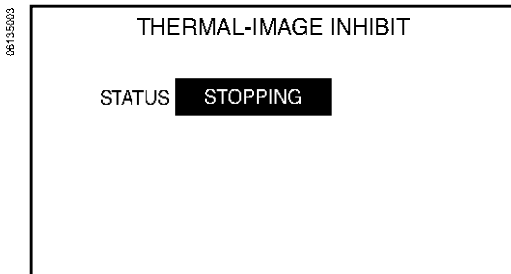

Figure 59: Thermal-image Inhibit Stopping Screen

5. When primary injection testing is completed, press CANCEL to stop thermal-imaging inhibit function. STATUS display will flash STOPPING to indicate test exit communication between Full-function Test Kit and trip unit.

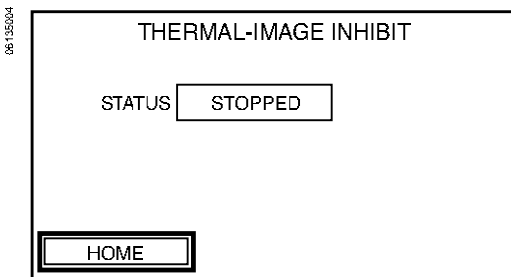

Figure 60: Thermal-image Inhibit Disabled Screen

6. Once STOPPED appears in STATUS display, test exit communication is complete.

VIEWING AND DELETING TEST FILES

NOTE: The View/Delete Test Files touch key will not appear on the Select Test Kit Function screen until at least one test file is saved.

Viewing Previously Saved Test Files

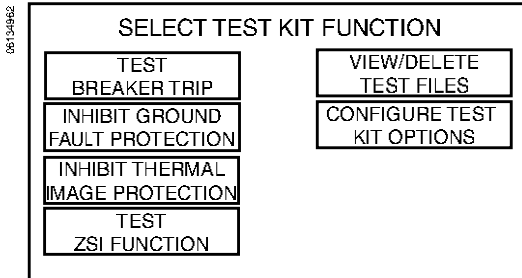

Figure 61: Select Test Kit Function Screen

1. From Select Test Kit Functions screen, press VIEW/DELETE TEST FILES. Interface screen will advance to Select Test File Function screen.



Figure 62: Select Test File Function Screen

2. To view results of a previous trip test, from Select Test File Function screen press VIEW TEST FILE.



Figure 63: Select Test File Screen

3. From Select Test File screen, press desired test file name touch key. Display screen will advance to Circuit Breaker Parameters screen to show the settings entered for this particular saved test.

NOTE: Parameter display fields are neither selectable nor modifiable when viewing saved files.



Figure 64: Circuit Breaker Parameters Screen

4. Press NEXT on Circuit Breaker Parameters screen to advance to Protection Parameters screen and view protection settings entered for this particular saved test.



Figure 65: Protection Parameters Screen

- Press NEXT on Protection Parameters screen to advance to Trip Curve Test screen and view test results for this particular saved test. Screen title will read Automatic Trip Curve Test, Manual Trip Curve Test or Mechanical Trip Curve Test depending on original test type of this particular saved test.



Figure 66: Automatic Trip Curve Test Screen

Deleting Previously Saved Test Files

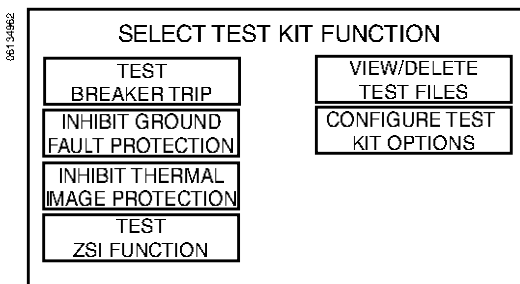

Figure 67: Select Test Kit Function screen

To delete one or all saved test files, press VIEW/DELETE TEST FILES on Select Test Kit Functions screen. Display screen will advance to Select Test File Function screen.

DELETING ONE SAVED TEST FILE

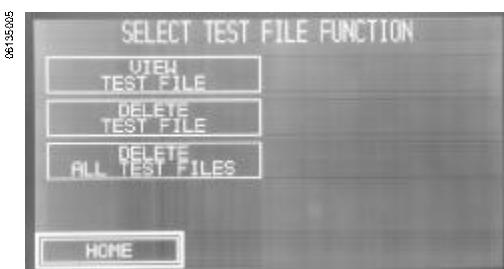

Figure 68: Select Test File Function Screen

- To delete one saved test file, from Select Test File Function screen press DELETE TEST FILE. Display screen will advance to Select Test File screen.



Figure 69: Select Test File Screen

- From Select Test File screen, press desired test file name touch key for deletion. Display screen will advance to File Delete Alert screen.



Figure 70: Select Test File Screen

- Read alert message. Press YES to delete selected test file and proceed to Select Test File Function screen. Press NO to cancel test deletion procedure and return to Select Test File Function screens. Once YES is pressed this action cannot be undone.

DELETING ALL SAVED TEST FILES



Figure 71: Select Test File Function screen

- To delete all saved test files, from Select Test File Function screen press DELETE ALL TEST FILES. Display screen will advance to File Delete Alert screen.

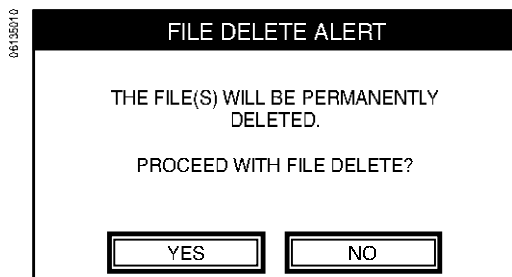

Figure 72: Select Test File Screen

- Read alert message. Press YES to delete all saved selected files and proceed to Select Test File Function screen. Press NO to cancel file deletion procedure and return to Select Test File Function screens. Once YES is pressed this action cannot be undone.

CONFIGURING FULL-FUNCTION TEST KIT OPTIONS

From Select Test Kit Function screen press Configure Test Kit Options. Display screen will advance to Configure Test Kit Options screen.

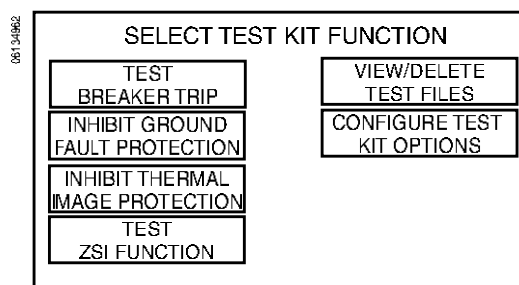

Figure 73: Select Test Kit Function Screen

Language Selection

NOTE: Pressing a language touch key on Select Language screen will automatically change all Full-function Test Kit language settings.



Figure 74: Configure Test Kit Options Screen

1. From Configure Test Kit Options screen press Language touch key.

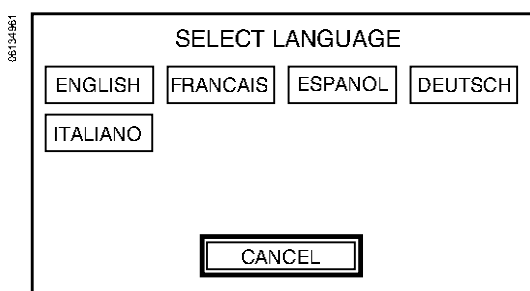

Figure 75: Select Language screen

2. Select appropriate language setting from Select Language screen. Display screen will return to Configure Test Kit Options screen.

Setting Display Screen Backlight

Scroll DISPLAY BACKLIGHT touch key Configure Test Kit Options screen (Fig. 73) to desired setting. Value range for DISPLAY BACKLIGHT touch key decreases from 100% to 30% in increments of 10 percent.

Setting Display Screen Contrast

Scroll DISPLAY CONTRAST touch key on Configure Test Kit Options screen (Fig. 73) to desired setting. Value range for DISPLAY CONTRAST touch key decreases from 80% to 35% in increments of 5 percent.

MAINTENANCE

Fuse Replacement

▲ DANGER

HAZARD OF ELECTRIC SHOCK, BURN, OR EXPLOSION

- This equipment must be installed and serviced only by qualified electrical personnel.
- Turn off all power supplying this equipment before working on or inside equipment.
- Always use a properly rated voltage sensing device to confirm power is off.
- Replace all devices, doors and covers before turning on power to this equipment.
- Select the proper type and value for the replacement fuse(s).
- Make sure two fuses are installed at all times in the line-fuse holder.
- Select proper system voltage for the Full-function Test Kit.

Failure to follow this instruction will result in death or serious injury.

NOTE: There are no repairable or adjustable parts inside the Full-function Test Kit.

1. Turn off power switch and unplug power cable from Full-function Test Kit.
2. Carefully pry open line-fuse holder cover (A) using a screwdriver.
3. Remove line-fuse holder (B) from power switch module.
4. Replace fuses (C) as required. See Table 1 for fuse recommendations.
5. Make sure both fuses are installed in line-fuse holder and insert line-fuse holder back into power switch module.
6. Close line-fuse holder cover. Make sure correct system voltage value on voltage selector appears in window.

06135011

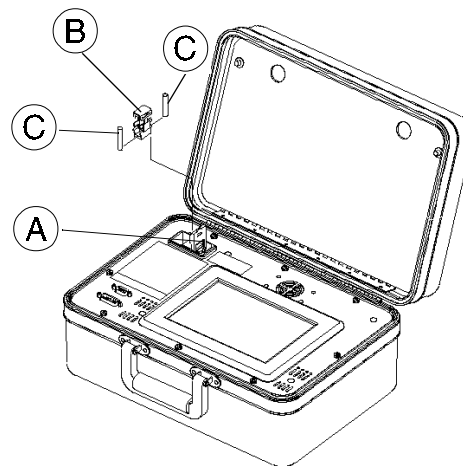

Figure 76: Fuse Replacement

Calibration

The Full-function Test Kit does not require periodic calibration. The Full-function Test Kit performs a self-check of the microprocessor-generated fault signal before signal is injected into trip unit. If fault signal is out of tolerance, interface screen displays error message and will not allow continuation of test.

Cleaning

Use a soft cloth moistened with a diluted window-cleaning solution to clean the Full-function Test Kit case and interface screen.

CAUTION

HAZARD OF EQUIPMENT DAMAGE

Avoid corrosive or abrasive agents when cleaning the Full-function Test Kit interface screen.

Failure to follow this instruction can result in equipment damage.

TROUBLESHOOTING

General

Condition	Probable Causes	Solutions
Circuit breaker trips faster than minimum trip band for instantaneous protection when performing automatic trip curve test on short-time or instantaneous segments of time-current curve and/or HARDWARE appears in status cell on Automatic Trip Curve Test screen.	Secondary injected fault into trip unit has exceeded one or more of the following circuit breaker protection levels: <ul style="list-style-type: none"> – Instantaneous override – Close and latch – Selectivity 	Make sure circuit breaker is always in closed position before beginning secondary injection of each fault. This will eliminate tripping due to close and latch protection. Does long-time segment of time-current curve pass when performing automatic trip curve test? A. YES For communicating MICROLOGIC trip units, if AP trip indicator LED on trip unit comes on when testing short-time or instantaneous segments of time-current curve, then circuit breaker has tripped on instantaneous override, close and latch or selectivity protection functions. For non-communicating MICROLOGIC trip units, no trip indicator LED is available. Check that peak value for signal being injected does not exceed instantaneous override or selectivity protection levels. See published time-current curves. B. NO Contact local field office.
STR or ET trip units trip faster than published time-current curves when performing manual trip curve test.	<ol style="list-style-type: none"> 1. Incorrect trip unit settings entered. 2. Fault type selection (LSIG) set to instantaneous when type of fault to be tested is long-time or short-time. 3. Fifteen-minute waiting period not observed between long-time tests. 	<ol style="list-style-type: none"> 1. Check trip unit settings. 2. Check fault type setting. 3. Contact local field office.
Circuit breaker trips up to twice as long as expected when performing primary injection test.	While performing primary injection using either ground-fault or thermal-image inhibit function, interface screen displayed Communications Error. In response ground fault or thermal imaging was re-inhibited without stopping primary injection causing circuit breaker to trip long when long-time segment of time-current curve tested.	Terminate primary injection test completely, start ground-fault or thermal-image inhibit function and then start primary injection test.
Circuit breaker trips faster than short-time delay, but slower than maximum trip band for instantaneous protection when instantaneous protection on MICROLOGIC trip units is turned off. For communicating MICROLOGIC trip units, AP trip indicator LED on trip unit illuminated.	Fault level being secondary injected into the trip unit is near tripping levels for instantaneous override, close and latch or selectivity protection functions.	If at any time there is variation in amplitude of signal exceeding pickup levels for instantaneous override, close and latch or selectivity protection functions, circuit breaker will trip.
When choosing segments of time-current curve to be tested using automatic trip curve test, short-time segment of time-current curve cannot be enabled.	<ol style="list-style-type: none"> 1. Trip unit being tested does not support short-time protection. 2. Short-time protection available, but trip unit dial settings have been altered to disable short-time protection. 	<ol style="list-style-type: none"> 1. Refer to Table 2 to determine if test is applicable to trip unit. 2. Adjust trip unit dial settings.
When performing automatic trip curve test on STR trip units, current injected for long-time, short-time, instantaneous and ground fault should not cause circuit breaker to trip. But circuit breaker does trip and Full-function Test Kit reports trip unit passes all segments of the time-current curve.	Incorrect In value entered.	Make sure correct In value entered.
STR53UE or STR53UP trip units trip faster than published time-current curves when performing automatic trip curve test.	Short-time pickup setting less than ground-fault pickup setting causing trip unit to trip on short-time protection.	Test ground-fault protection by either dialing down ground-fault pickup or dialing up short-time pickup so that short-time pickup is greater than ground-fault pickup.
For STR22ME trip unit, long-time, short-time or instantaneous segment of published time-current curves fails when performing automatic trip curve test.	Long-time pickup value (Ir) not set to correct position.	Set Ir to minimum position before performing tests.
STR22ME trip unit reports "Timed Out" status for Trip Time cell when performing manual trip curve test.	Long-time pickup value (Ir) not set to correct position.	Set Ir to minimum position before performing tests.

Continued on next page

General—Continued

Condition	Probable Causes	Solutions
<p>Isd/Ii and/or Ig LED not flashing on upstream circuit breaker when performing ZSI test.</p>	<ol style="list-style-type: none"> 1. Upstream circuit breaker not wired for ZSI configuration. 2. Trip unit on upstream circuit breaker does not have power applied to it. 3. Interface screen displayed Communications Error. 4. Upstream circuit breaker not wired for short-time ZSI restraint. 5. Upstream circuit breaker not wired for ground-fault ZSI restraint. 6. MICROLOGIC 3.0 trip unit connected to Full-function Test Kit. (MICROLOGIC 3.0 trip unit does not provide short-time or ground-fault protection.) 	<ol style="list-style-type: none"> 1. ZSI test cannot be performed. 2. Connect and turn on auxiliary 24 V power source to upstream circuit breaker. A second Full-function Test Kit or a Hand-held Test Kit can be used for this purpose. 3. Check that pins of 7-pin test cable have not been bent, pushed in, pulled out or otherwise damaged, thereby compromising connection between Full-function Test Kit and trip unit. 4. Refer to Table 2 to determine if test is applicable to trip unit type. 5. Refer to Table 2 to determine if test is applicable to trip unit type. 6. Refer to Table 2 to determine if test is applicable to trip unit type. <p>If both upstream and downstream trip units are powered and trip indicator LEDs are not flashing, verify wiring between devices.</p> <ol style="list-style-type: none"> A. Terminal Z1 from downstream trip unit must be connected to terminal Z3 of upstream trip unit. B. Terminal Z2 of downstream trip unit must be connected to terminals Z4 (for short time) and Z5 (for ground fault) of upstream trip unit. <p>If wiring is correct and trip indicators still do not flash while Full-function Test Kit is initiating ZSI test, then verify trip unit is not self-restrained. Use an ohmmeter to verify terminal Z3 is not shorted to terminals Z4 and/or Z5. All devices are factory-shipped in self-restrained configuration with Z3 shorted to Z4 and Z5.</p> <p>If system includes Restraint Interface Module (RIM), push-to-test button will also send a ZSI test signal to upstream device(s). Refer to the RIM instruction bulletin for correct wiring and operation instructions.</p>
<p>STR43ME trip unit does not trip according to long-time delay setting.</p>	<p>STR43ME trip unit will trip in same time whether long-time delay is set to hot or cold setting for class rating. For example, if tr is set to 20 hot, circuit breaker will trip in same time as if tr is set to 20 cold. If circuit breaker is set to 10 hot it will trip in same time as if setting was 10 cold, etc. The purpose of hot and cold settings on long-time delay is for systems with different profiles for motor starting. Hot and cold settings offer two motor cooling time constants associated with motor starting class.</p> <p>The first class of motor protection allows for short cooling time constant. This provides maximum continuity of service and satisfactory motor protection and is used mainly for motors that start and stop frequently. It allows for frequent inrush currents without building toward trip condition.</p> <p>The second class of motor protection allows for long cooling time constant (four times the short cooling time constant). This setting provides maximum motor protection.</p>	<p>NA</p>
<p>Circuit breaker does not trip on ground fault when testing STR53UE or STR53UP trip units.</p>	<ol style="list-style-type: none"> 1. Incorrect 2-pin test cable polarity. 2. Trip unit does not provide ground-fault protection. 	<ol style="list-style-type: none"> 1. Reverse polarity on 2-pin test cable connection. 2. Refer to Table 2 to determine if test is applicable to trip unit.
<p>Circuit breaker installed with MICROLOGIC 6.0A, MICROLOGIC 6.0H or MICROLOGIC 6.0P trip unit does not trip when performing ground-fault test.</p>	<ol style="list-style-type: none"> 1. Fault level injected not high enough to cause trip on ground-fault protection. 2. Circuit breaker connected in modified differential ground-fault (MDGF) or source-ground return configuration. 	<ol style="list-style-type: none"> 1. Inject higher fault current 2. Refer to Table 2 to determine if test is applicable to trip unit.

Continued on next page

General—Continued

Condition	Probable Causes	Solutions
When performing automatic trip curve test, Full-function Test Kit reports failure, circuit breaker does not trip and no trip time is displayed.	<ol style="list-style-type: none"> 1. Full-function Test Kit has not detected circuit breaker has tripped. Full-function Test Kit has a time out limit for maximum amount of time it can inject a given fault level. It removes the fault if the duration is 20% greater than maximum trip band for any given fault. 2. Full-function Test Kit is damaged. 	<ol style="list-style-type: none"> 1. Check if any test cable pins are pushed in or bent. 2. Contact local field office.
Full-function Test Kit reports "Timed Out" in Status cell when performing manual trip curve test.	<ol style="list-style-type: none"> 1. Full-function Test Kit has not detected circuit breaker has tripped. Full-function Test Kit has a time out limit for maximum amount of time it can inject a given fault level. 2. Full-function Test Kit is damaged. 	<ol style="list-style-type: none"> 1. Check if any test cable pins are pushed in or bent. 2. Contact local field office.
Full-function Test Kit displays "Timed Out" in Status cell when performing mechanical operation trip test.	<ol style="list-style-type: none"> 1. Maximum time reached for injecting fault level without detecting circuit breaker has tripped. 2. Full-function Test Kit is damaged. 	<ol style="list-style-type: none"> 1. Check if any test cable pins are pushed in or bent. 2. Contact local field office.
When power switch is turned on, Full-function Test Kit beeps twice with two different tones and nothing is displayed on interface screen.	Object in contact with interface screen when power switch turned on.	Turn off power switch, remove any objects in contact with interface screen and turn power switch on.
Spinning Schneider logo remains on the interface screen longer than 15 seconds when powering Full-function Test Kit.	<ol style="list-style-type: none"> 1. Voltage selector set for 230 Vac but 115 Vac applied. 2. Full-function Test Kit is damaged. 	<ol style="list-style-type: none"> 1. Change voltage selector to 115 Vac. 2. Contact local field office.
Interface screen and fan do not turn on when power is applied to Full-function Test Kit.	<ol style="list-style-type: none"> 1. Voltage selector set for 115 Vac but 230 Vac applied. 2. Incorrect fuse size. 3. Full-function Test Kit is damaged. 	<ol style="list-style-type: none"> 1. Change voltage selector to 230 Vac. 2. Make sure correct fuse being used. 3. Contact local field office.

Error Messages

Message	Probable Causes	Solutions
Trip unit disconnected from test kit. Operation aborted.	<ol style="list-style-type: none"> 1. Test cable removed from trip unit. 2. Test cable pins not making good contact between Full-function Test Kit and trip unit. 	<ol style="list-style-type: none"> 1. Check if any pins are pushed in or bent. 2. Make sure test cable is making good connection at both trip unit and Full-function Test Kit connectors.
Test kit power supply overload detected. Operation aborted.	Current source on-time, time-out or over-temperature.	Reduce interface screen backlight or turn off Full-function Test Kit and allow it to cool.
Communication error detected.	Communication error between Full-function Test Kit and trip unit.	<p>Press CANCEL. If error persists make sure pins on 7-pin test cable are not pushed in or bent. Make sure Full-function Test Kit earth ground connection is at same potential as earth ground connection of circuit breaker chassis.</p> <p>If drawout circuit breaker is being tested and error persists, rack circuit breaker out into disconnect position.</p>
Test kit calibration error. Test aborted. Contact local field office.	Full-function Test Kit has determined it cannot reliably secondary inject a fault signal into trip unit to test circuit breaker.	Contact local field office.
Fatal error detected. All operations halted. Contact field office if problem persists.	Full-function Test Kit internal failure.	Press CANCEL to reboot. If error persists, contact local field office.
Error detected when determining if the trip unit is connected to the test kit. Operation aborted.	<ol style="list-style-type: none"> 1. Damaged test cable. 2. Damaged Full-function Test Kit. 3. Damaged trip unit. 	<ol style="list-style-type: none"> 1. Check if any pins are pushed in or bent. 2. Contact local field office 3. Contact local field office
Error detected when determining if the trip unit has tripped. Operation aborted.	<ol style="list-style-type: none"> 1. If testing STR22ME trip unit, long-time pickup is not set to minimum value. 2. Damaged trip unit. 3. Damaged circuit breaker. 	<ol style="list-style-type: none"> 1. Set STR22ME trip unit long-time pickup value to minimum value. 2. Contact local field office 3. Contact local field office
Level of injection current out of test kit range.	Value entered for Injection Current on Configure Manual Trip Curve Test screen is too high or too low for Full-function Test Kit to test.	Limit maximum current to be tested to 20 x In. Limit minimum current to be tested to 0.3 x In.
Level of injection current out of trip unit range.	Value entered for Injection Current on the Configure Manual Trip Curve Test screen exceeds maximum value trip unit can handle via secondary injection testing.	Limit maximum current to be tested to 20 x In. Limit minimum current to be tested to 0.3 x In.
Non-volatile memory error detected. Contact local field office if problem persists. Operation aborted.	Information being accessed from Full-function Test Kit memory is corrupted.	Press CANCEL to reboot. If error persists, contact local field office.

GLOSSARY

ASIC: (Application Specific Integrated Circuit) Electronic device located inside MICROLOGIC electronic trip units that senses overload, short circuit, ground-fault or earth-leakage conditions and activates mechanical mechanism for tripping circuit breaker.

Circuit Breaker Family: Circuit breaker series being tested. Full-function Test Kit tests COMPACT, MASTERFACT or POWERFACT circuit breakers. Verify circuit breaker family by referring to circuit breaker label (Fig. 14) or instruction bulletin when configuring circuit breaker parameters for secondary injection testing.

Circuit Breaker Type: Specific type of circuit breaker within circuit breaker family. Verify circuit breaker type by referring to circuit breaker label (Fig. 14) or instruction bulletin when configuring circuit breaker parameters for secondary injection testing.

Close and Latch: Rating used to describe level of root mean square (RMS) current a circuit breaker is capable of closing into and carrying in a closed position for a specific amount of time (usually up to 30 cycles).

Earth-leakage Delay (th): Full-function Test Kit DOES NOT test this function.

Earth-leakage Pickup (Ih): Full-function Test Kit DOES NOT test this function.

Ground-fault Delay (tg): Length of time ground-fault timer runs before initiating trip signal (i.e., determines amount of time circuit breaker will wait before initiating trip signal. There are two choices for ground-fault delay characteristics:

- **I²t ON**—Delay characteristic which results in inverse-time delay that coordinates best with zero sequence ground-fault relays used in conjunction with thermal magnetic circuit breakers and fusible switches.
- **I²t OFF**—Delay characteristic which results in constant delay that coordinates best with electronic trip circuit breakers with ground-fault option.

Ground-fault Pickup (I_g): Ground-fault current level at which ground-fault delay timer starts (i.e., sets ground-fault current level at which trip unit begins timing).

In: Sensor rating; 100% full-load circuit breaker rating.

Instantaneous Override: Rating used to describe level of root mean square (RMS) current that will cause circuit breaker to trip without an adjustable delay.

Interrupt Rating: Defines maximum circuit breaker withstand rating depending on circuit breaker standard. Verify interrupt rating by referring to circuit breaker label when configuring circuit breaker parameters for secondary injection testing.

LSIG/LSIV: Abbreviations for electronic trip unit protection features.

L—Long-time pickup and delay

S—Short-time pickup and delay

I—Instantaneous pickup

G—Ground-fault pickup and delay

V—Earth-leakage pickup and delay (VIGI)

Long-time Ampere Rating: Circuit breaker current-carrying capacity or “handle rating.”

Long-time Delay (tr): Time period long-time delay timer runs before initiating a trip signal (i.e., length of time circuit breaker will carry sustained, low-level overload before initiating trip signal).

Long-time Pickup (I_r): Current level at which long-time delay timer starts.

Selectivity: General term used to describe interaction among multiple circuit breakers where circuit breaker nearest fault will open and circuit breakers closer to source will remain closed to carry remaining load.

Short-time Delay (tsd): Time period the short-time delay timer runs before initiating trip signal (i.e., short-time delay allows circuit breaker to carry or withstand low-level or high-level short-circuit currents, up to published withstand ratings, with intentional time delay before tripping). There are two choices for short-time delay characteristics:

- **I²t ON**—Delay characteristic which results in inverse-time delay that most closely parallels time-current characteristics of fuses.
- **I²t OFF**—Delay characteristic which results in constant delay that coordinates best with thermal-magnetic and electronic trip circuit breakers.

Short-time Pickup (I_{sd}): Current level at which short-time delay timer starts (i.e., current at which short-time function recognizes overcurrent).

Standard: Electrical standard by which circuit breaker is certified. Standards for Full-function Test Kit are UL, IEC, ANSI or CCEE. Some circuit breakers may be certified under multiple standards. Use appropriate standard for application and location. Selecting incorrect standard can produce inaccurate test results. Verify standard by referring to circuit breaker label when configuring circuit breaker parameters for secondary injection testing.

Trip Unit: Electronic device that controls protection pickup and delay points of a circuit breaker. Trip unit, along with circuit breaker mechanical trip mechanism, is primary component tested by Full-function Test Kit.

Trip Unit Family: Series of trip unit being tested. Full-function Test Kit tests MICROLOGIC, ET and STR trip units. Verify trip unit family by referring to trip unit face (Fig. 15) or instruction bulletin and Table 2 when configuring circuit breaker parameters for secondary injection testing.

Trip Unit Type: Specific type of trip unit within trip unit family. Verify trip unit type by referring to trip unit face (Fig. 15) or instruction bulletin and Table 2 when configuring circuit breaker parameters for secondary injection testing.

Square D Company
PO Box 3069
3700 Sixth St SW
Cedar Rapids IA 52406-3069 USA
1-888-SquareD (1-888-778-2733)
www.SquareD.com

Electrical equipment should be serviced only by qualified personnel. No responsibility is assumed by Schneider Electric for any consequences arising out of the use of this material. This document is not intended as an instruction manual for untrained persons.

Bulletin No. 48049-183-02 September 2001 Replaces 48049-183-01 dated 06/01.

Free Manuals Download Website

<http://myh66.com>

<http://usermanuals.us>

<http://www.somanuals.com>

<http://www.4manuals.cc>

<http://www.manual-lib.com>

<http://www.404manual.com>

<http://www.luxmanual.com>

<http://aubethermostatmanual.com>

Golf course search by state

<http://golfingnear.com>

Email search by domain

<http://emailbydomain.com>

Auto manuals search

<http://auto.somanuals.com>

TV manuals search

<http://tv.somanuals.com>