

User Manual

KVM Switch

KVM2132P
KVM2116P
KVM1116P

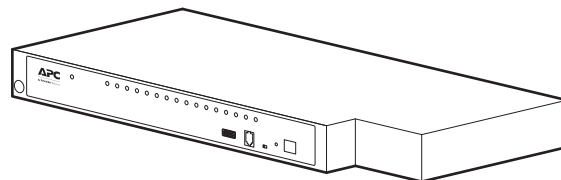

American Power Conversion Legal Disclaimer

The information presented in this manual is not warranted by the American Power Conversion Corporation to be authoritative, error free, or complete. This publication is not meant to be a substitute for a detailed operational and site specific development plan. Therefore, American Power Conversion Corporation assumes no liability for damages, violations of codes, improper installation, system failures, or any other problems that could arise based on the use of this Publication.

The information contained in this Publication is provided as is and has been prepared solely for the purpose of evaluating data center design and construction. This Publication has been compiled in good faith by American Power Conversion Corporation. However, no representation is made or warranty given, either express or implied, as to the completeness or accuracy of the information this Publication contains.

IN NO EVENT SHALL AMERICAN POWER CONVERSION CORPORATION BE LIABLE FOR ANY DIRECT, INDIRECT, CONSEQUENTIAL, PUNITIVE, SPECIAL, OR INCIDENTAL DAMAGES (INCLUDING, WITHOUT LIMITATION, DAMAGES FOR LOSS OF BUSINESS, CONTRACT, REVENUE, DATA, INFORMATION, OR BUSINESS INTERRUPTION) RESULTING FROM, ARISING OUT, OR IN CONNECTION WITH THE USE OF, OR INABILITY TO USE THIS PUBLICATION OR THE CONTENT, EVEN IF AMERICAN POWER CONVERSION CORPORATION HAS BEEN EXPRESSLY ADVISED OF THE POSSIBILITY OF SUCH DAMAGES. AMERICAN POWER CONVERSION CORPORATION RESERVES THE RIGHT TO MAKE CHANGES OR UPDATES WITH RESPECT TO OR IN THE CONTENT OF THE PUBLICATION OR THE FORMAT THEREOF AT ANY TIME WITHOUT NOTICE.

Copyright, intellectual, and all other proprietary rights in the content (including but not limited to software, audio, video, text, and photographs) rests with American Power Conversion Corporation or its licensors. All rights in the content not expressly granted herein are reserved. No rights of any kind are licensed or assigned or shall otherwise pass to persons accessing this information.

This Publication shall not be for resale in whole or in part.

Contents

- General Information 1**
 - Overview 1
 - KVM2132P / KVM2116P / KVM1116P KVM Switches 1
 - KVM2132P / KVM2116P KVM Switches only 2
 - Safety 2
 - Taking Delivery 3
 - Inventory 3
 - System Requirements 4
 - Remote User Computers 4
 - Servers 4
 - Video 4
 - KVM Server Modules and cables 5
 - Supported Operating Systems 5
 - Browsers 5
 - Max Server connections 6
 - Components 7

- Installation 9**
 - Overview 9
 - Rack Mounting 9
 - Rack Mounting - Front 9
 - Rack Mounting - Rear 10
 - Optional KVM to LCD Console Mounting 10
 - Single Level Installation 11
 - KVM1116P Single Level Installation Diagram 11
 - KVM2132P Single Level Installation Diagram 12
 - Tiering Multiple KVM Switches 13
 - KVM1116P Two Level Installation 13
 - Two Level Installation Diagram 13
 - Three Level Installation and (1 or 2) Bus Configurations 14
 - KVM2132P / KVM2116P Two busTiered Diagram 14
 - KVM1116P One Bus Tiered Diagram 15

Hardware Setup	15
Cable Length Considerations	15
Hot Plugging	15
The Adapter ID Function	16
Powering Off and Restarting	16
Port ID Numbering	16
Port Selection	16
PDU Connection (KVM2132P, KVM2116P)	16

Super Administrator Setup..... 17

Overview	17
First Time Setup	17
Network Setup	17
Changing the Super Administrator Login	17

Logging In 19

Overview	19
Local Console Login	19
Browser Login.	19
Windows Client AP Login	20
Connect using Windows Client AP	20
The File Menu	20
Java Client AP Login	21
Connect using - Java Client AP	21

The User Interface 22

Overview	22
The Web Browser Main Page	22
The Tab Bar	23
The AP GUI Main Page	23
The Local Console GUI Main Page	24

The Control Panel	24
WinClient Control Panel Functions	26
Macros	27
Video Settings	30
The Message Board	31
Virtual Media	32
Zoom	33
The On-Screen Keyboard	33
Mouse Pointer Type	34
Mouse DynaSync Mode	34
Control Panel Configuration	35
The Java Control Panel	36
Port Access	37
Overview	37
The Sidebar	38
The Sidebar Tree Structure	38
Sidebar Utilities	38
Port and Outlet Naming	39
Scan	40
Array	40
Filter	40
KVM Devices and Ports - Connections Page	40
Device Level	40
Port Level	41
PDU Devices - Device Monitor Page	42
The Main Panel - Group View	44
Outlet Settings	45
Adding a PDU in the KVM GUI main page	46
History	49
Favorites	49
User Preferences	51
Sessions	52
Access	53
Device Level Browser GUI Interface	53
Port Level Browser GUI Interface	54
Device Level AP GUI Interface	54
Port Level AP GUI Interface	54

Port Configuration	55
Device Level	55
Port Level	55
Port Properties	55
Associated Links	55
Power Management	56
Adding and Removing Associations	56
Configuration	57
Synchronization	58

User Management..... 59

Overview	59
Users	59
Adding Users	60
Modifying User Accounts	61
Deleting User Accounts	61
Groups	62
Creating Groups	62
Modifying Groups	62
Deleting Groups	62
Users and Groups	63
Assigning Users to a Group From the User's Notebook	63
Removing Users From a Group in the User's Notebook	64
Assigning Users to a Group From the Group's Notebook	64
Removing Users From a Group From the Group's Notebook	64
Device Assignment	64
Assigning Device Permissions From the User's Notebook	65
Assigning Device Permissions From the Groups' Notebook	66

Device Management 67

Device Information 67

General	67
Environment	67
Operating Mode	67
Network	68
IPv4 Settings	69
IPv6 Settings	70
ANMS	70
Authentication	71
OOBC	73

Security 75

Login Failures	75
Filter	75
Account Policy	76
Encryption	77
Mode	77
Private Certificate	78
Certificate Signing Request	79
Date/Time	79

PDU Devices 81

Configuration Page	81
Outlet Configuration	82
Configure Outlet Time Delay	82

Port Operation..... 83

Connecting to a Port 83

Port Toolbar 83

Toolbar icons	84
Toolbar Hotkey Port Switching	84
Auto Scanning	84
Skip Mode	85

Recalling the Port Access Page 85

GUI Hotkey Summary Table 85

Keyboard Emulation 86

Mac Keyboard	86
Sun Keyboard	87

Panel Array Mode	88
Panel Array Toolbar	88
Multuser Operation	89
Users and Buses	89
Log	90
Log Information	90
Log Notification Settings	91
Maintenance	92
Main Firmware Upgrade	92
Adapter Firmware Upgrade	92
Firmware Upgrade Recovery	93
Adapter Firmware Upgrade Recovery	93
Backup/Restore	93
Backup	93
Restore	93
Ping	94
Restore Values	94
Reset on exit	94
The Download Tab	94
The Log Server	95
Installation	95
Starting Up	95
The Menu Bar	95
The Log Server Main Screen	96
LDAP Server Configuration	97
Introduction	97
Configuring LDAP under Windows 2003 Server.	97
OpenLDAP	102
Factory Default Settings	103
Serial Adapter Pin Assignments	104
KVM KVM2132P / KVM2116P / KVM1116P	104

Supported KVM Switches	104
Supported PDUs	104
KVM2132P / KVM2116P only	104
Virtual Media Support	105
WinClient ActiveX Viewer / WinClient AP	105
Java Applet Viewer / Java Client AP	105
IP Address Determination	105
IP Installer	105
Browser	106
IPv6	106
Port Forwarding	106
PPP Modem Operation	107
Connection Setup Example (Windows XP)	108
Additional Mouse Synchronization Procedures	108
Fan Location and Speed Information	109
KVM2132P / KVM2116P only	109
Fan Location	109
Fan Speed	109
Temperature Sensor Location and Information	109
KVM2132P / KVM2116P only	109
KVM-SERIAL Server Module Configuration and Operation	109
Configuration	109
Operation	110
Internal Serial Interface Configuration	110
Navigation	110
Operation	111
Switch Level Configuration	111
Port Level Configuration	111
Trusted Certificates	112
Overview	112
Installing the Certificate	112
Self-Signed Private Certificates	112

Troubleshooting 114

- General Operation 114
- Mouse Problems 115
- Virtual Media 116
- Web Browser 116
- The WinClient ActiveX Viewer and the WinClient AP 116
- The Java Applet and Java Client AP 118
- Sun Systems 118
- Mac Systems 118
- Redhat Systems 119
- The Log Server 119
- Panel-Array Mode 119

Specifications 120

- KVM2132P / KVM2116P / KVM1116A 120

General Information

Overview

KVM2132P / KVM2116P / KVM1116P KVM Switches



Note: Save these instructions. Read and adhere to all the instructions. All servicing must be performed by authorized personnel only.

The KVM switch allows local and remote users to monitor and access multiple servers from a single console. The switch models differ by number of buses and KVM ports.

SKU	Bus Support	KVM Ports
KVM2132P	1 Local, 2 Remote	32
KVM2116P	1 Local, 2 Remote	16
KVM1116P	1 Local shared with 1Remote	16

- Each bus permits a separate user session so that up to three (KVM2132P or KVM2116P) concurrent independent connections to the attached servers can take place.
- The switches use TCP/IP communications protocol. They can be accessed by their IP addresses from anywhere on the LAN, WAN, or Internet. The location of the connecting computer is irrelevant.
- Remote users log in using a browser or stand-alone Windows or Java GUI applications. Java allows the switches to work with JRE (Java Runtime Environment) enabled operating systems, ensuring multi-platform operability.
- The client software allows operators to exchange keyboard, video and mouse signals with the servers attached to the switches just as if they were working on the equipment directly.
- Up to 32 (KVM2132P) users can share the switch's buses. A Message Board feature allows them to communicate with each other to facilitate port sharing.
- Administrators can perform maintenance tasks from installing and running GUI applications, to BIOS level troubleshooting, routine monitoring, concurrent maintenance, and system administration.
- Local console operation is accomplished by entering hotkey combinations from the keyboard with a full screen GUI display.
- The Auto Scan feature permits automatic switching from port to port at user-specified intervals, while the Panel Array Mode can display the video output of up to 42 servers at the same time.
- CAT 5e cable links the switch to the servers. A 16 or 32 port switch can be installed in a 1U rack, and use the internal network wiring in most modern commercial buildings.
- The switch receives keyboard input directly. There is no software installation.
- Download firmware updates from **www.apc.com**.
- Adapter ID function stores port information like the adapter ID, OS, keyboard language, adapter name, operation modes and more. When a KVM Adapter Cable is moved from one port to another, the switch recognizes the adapter cable at the new location.
- Upgrade the entire installation from a single remote console located anywhere in the world.
- Virtual Media support.

KVM2132P / KVM2116P KVM Switches only

- Dual power is available on KVM2132P and KVM2116P. Power cords plugged into separate power sources ensure power to the switch if one power sources fails.
- Variable fan speed: changes according to the switches temperature.
- PDU connection port allows administrators to boot or reboot servers.
- Two 10/100/1000 Mbps NICs for redundant LAN or two IP operations.

Safety

Read all of these instructions. Save them for future reference. Follow all warnings and instructions marked on the device.

⚠ DANGER

HAZARD OF ELECTRIC SHOCK

- Do not use the device near water, Never spill liquid of any kind on the device.
- Unplug the device from the wall outlet before cleaning. Do not use liquid or aerosol cleaners. Use a damp cloth for cleaning.
- The device should be operated from the type of power source indicated on the marking label. If you are not sure of the type of power available, consult your dealer or local power company.
- To prevent damage to your installation it is important that all devices are properly grounded. The device is equipped with a 3-wire grounding type plug. This is a safety feature. If you are unable to insert the plug into the outlet, contact your electrician to replace the outlet. Do not attempt to defeat the purpose of the grounding-type plug. Always follow local/national wiring codes.
- If an extension cord is used with this device make sure that the total of the ampere ratings of all products used on this cord does not exceed the extension cord ampere rating. Make sure that the total of all products plugged into the wall outlet does not exceed 15 amperes.
- To help protect your system from sudden, transient increases and decreases in electrical power, use a surge suppressor, line conditioner, or uninterruptible power supply (UPS).
- Position system cables and power cables carefully; Be sure that nothing rests on any cables.
- Never push objects of any kind into or through cabinet slots. They may touch dangerous voltage points or short out parts resulting in a risk of fire or electrical shock.
- There is a risk of explosion if the battery is replaced by an incorrect type. Dispose of used batteries according to the instructions.
- Use the power cords supplied with this package. If it becomes necessary to replace the cords supplied with this package, be sure to use cords of at least the same standard as the ones provided. Contact your dealer for information about power cords.
- Do not attempt to service the device yourself. Refer all servicing to qualified service personnel.

Failure to follow these instructions can result in death or serious injury.

⚠ CAUTION

INJURY OR EQUIPMENT DAMAGE

- Do not connect the RJ-11 connector marked “UPGRADE” to a public telecommunication network.
- Before working on the rack, make sure that the stabilizers are secured to the rack, extended to the floor, and that the full weight of the rack rests on the floor. Install front and side stabilizers on a single rack or front stabilizers for joined multiple racks before working on the rack.
- Always load the rack from the bottom up, and load the heaviest item in the rack first.
- Make sure that the rack is level and stable before extending a device from the rack.
- Use caution when pressing the device rail release latches and sliding a device into or out of a rack; the slide rails can pinch your fingers.
- After a device is inserted into the rack, carefully extend the rail into a locking position, and then slide the device into the rack.
- Do not overload the AC supply branch circuit that provides power to the rack. The total rack load should not exceed 80 percent of the branch circuit rating.
- Make sure that all equipment used on the rack, including power strips and other electrical connectors, is properly grounded.
- Ensure that proper airflow is provided to devices in the rack.
- Ensure that the operating ambient temperature of the rack environment does not exceed the maximum ambient temperature specified for the equipment by the manufacturer
- Do not step on or stand on any device when servicing other devices in a rack.
- Do not place the device on an unstable surface. If the device falls, serious damage will result.
- Do not block ventilation openings. Overheating of internal components may occur.
- Route the power cord and cables so that they cannot be stepped on or tripped over.

Failure to follow these instructions can result in injury or equipment damage.

Taking Delivery

Examine the components at the time of delivery to be sure all parts are present and in good working order. Anything missing or damaged must be reported immediately to the shipping firm and to APC.

Inventory

The package consists of:

- KVM Switch
- NEMA 5 - 15 power cord
- C13 - C14 power cord
- Rack Mount Bracket
- Serial Adapter (for modem connection)
- KVM Access Management Software USB key (please retain for future license upgrade)
- Literature Kit: Quick Start Guide, Safety Sheet, China ROHS and CD (containing KVM Access Management software)

System Requirements

Remote User Computers

Remote user computers (also referred to as client computers) are computers logged into the switch from remote locations over the internet.

These computers must have the following equipment installed:

- At least a PIII 1 GHz processor, with the screen resolution set to 1024 x 768.
- Browsers must support 128 bit SSL encryption.
- A network transfer speed of at least 512kbps.
- For the browser-based WinClient ActiveX Viewer, DirectX 8 must be present, and at least 150MB of memory must be available after installation.
- For the browser-based Java Applet Viewer the latest version of the Java Runtime Environment (JRE) must be installed, and at least 205MB of memory must be available after installation.
- For the Windows Client AP, DirectX 8 must be present, and at least 90MB of memory must be available after installation.
- For the Java Client AP, the latest version of the Java Runtime Environment (JRE) must be installed, and at least 145MB of memory must be available after installation.
- For the Log Server, you must have the Microsoft Jet OLEDB 4.0 or higher driver installed.

Servers

Servers are the computers connected to the switch by KVM Adapter Cables.

These servers must have the following equipment installed:

- A VGA, SVGA or multisync port
- For USB KVM Adapter Cable Connections: a Type A USB port and USB host controller
- For PS/2 KVM Adapter Cable Connections: 6-pin Mini-DIN keyboard and mouse ports

Video

Only the following non-interlaced video signals are supported:

Resolution	Refresh Rates
640 x 480	60, 70, 72, 75, 85
720 x 400	70, 75
800 x 600	56, 60, 70, 72, 75, 85
1024 x 768	60, 70, 75, 85
1152 x 864	60, 70, 75, 85
1152 x 900	66, 76
1280 x 1024	60, 70, 75, 85,
1600 x 1200	60

KVM Server Modules and cables



Note: KVM server modules are also referred to as adapter cables in some dialog boxes..

- Cat5e (or higher) cable connects the switch to the KVM server modules.
- The following KVM server modules and cables are required for use with the switch.

Cable Type	Port Type
KVM-PS2	Connect to devices with PS/2 ports
KVM-PS2VM	Connect to devices with PS/2 ports, virtual media support
KVM-USB	Connect to devices with USB ports
KVM-USBVM	Connect to devices with USB ports, virtual media support
KVM-USBVMCAC	Connect to devices with USB ports, virtual media and smart card/CAC support
KVM-SERIAL	Connect to serial based devices
AP5641	(Optional) Connect a rack PDU to the KVM

Supported Operating Systems

- Microsoft Windows
- Linux
- UNIX
- Mac
- DOS

Browsers

Supported browsers for remote users:

Browser		Version
IE		6 and higher,
Chrome		8.0 and higher
Firefox	Windows	3.5 and higher
	Linux	3.0 and higher
Safari	Windows	4.0 and higher
	Mac	3.1 and higher
Opera		10.0 and higher
Mozilla	Windows	1.7 and higher
	Sun	1.7 and higher
Netscape		9.0 and higher

Max Server connections

Parent KVM Model	Ports	Child Tiered KVM	Ports	Servers in a Single Level Tier	Servers in a Two Level Tier	Maximum Levels
KVM2132P	32	KVM0216A *	16	32 x 16 x 16 = 8192	16 x 8 x 16 = 2048	3
KVM2116P	16	KVM0216A *	16	16 x 16 x 16 = 4096	8 x 8 x 16 = 1024	3
KVM1116P	16	KVM0116A *	16	16 x 16 = 256		2
KVM1116P	16	KVM0108A *	8	16 x 8 = 128		2

* Not covered in this manual. See the User Manuals for these models for more information.

Components

Front

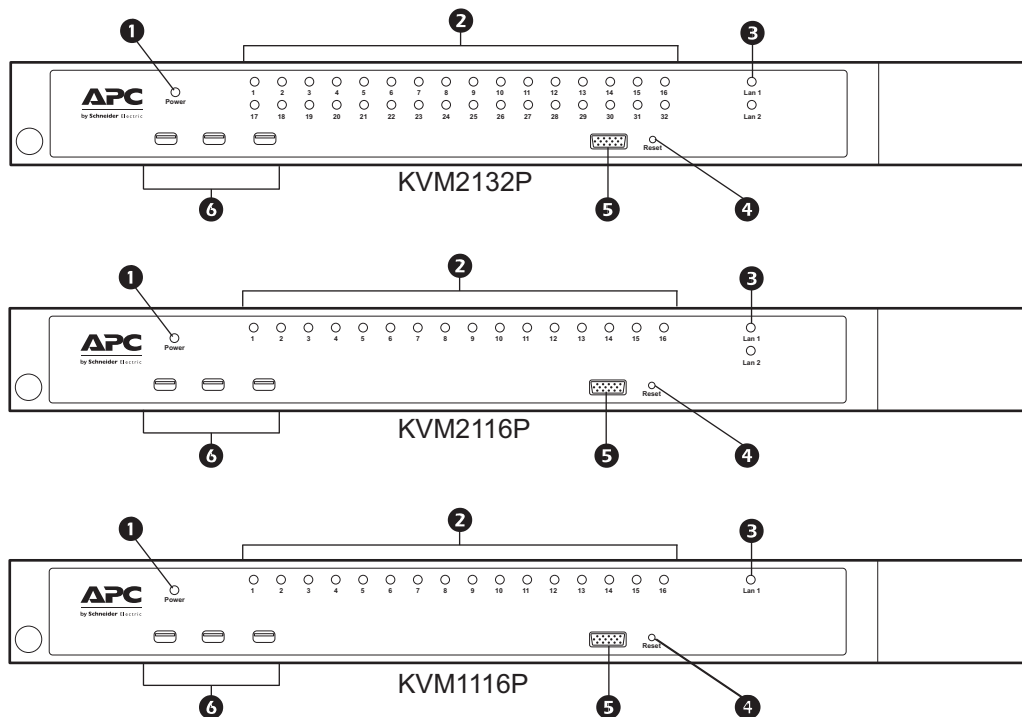

Item	Name	Description
1	Power LED	Illuminated when the unit is powered up and ready to operate.
2	Port LEDs	Provides status information about corresponding KVM Ports. <ul style="list-style-type: none"> • GREEN: The computer attached to the port is On Line. • RED: The computer attached to the port is Selected (has KVM focus). • GREEN + RED (ORANGE): The computer attached to the port is On Line and Selected. The LEDs are continuously ON under normal conditions. An LED flashes at half second intervals when its corresponding port is accessed under Auto Scan Mode or Skip Mode.
3	LAN LEDs	Primary and Secondary 10/100/1000 Mbps LAN LEDs. <ul style="list-style-type: none"> • RED: 10 Mbps • RED + GREEN (ORANGE): 100 Mbps • GREEN: 1000 Mbps Flashes to indicate that the switch is being accessed.
4	Reset Switch	Use a small object like a paper clip or ballpoint pen to press the reset switch. <ul style="list-style-type: none"> • To perform a system reset, press and release when the unit is running. • To reset to the factory default settings, press and hold for +3 seconds when the unit is running. Note: This does not clear User Account information. See “Factory Default Settings” on page 103, for information on clearing user account information. <ul style="list-style-type: none"> • To return to factory default firmware settings, rather than any upgraded version press and hold while powering on the unit. This allows recovery from a failed firmware upgrade so the upgrade may be tried again. Note: This operation is only performed after a firmware upgrade failure that results in the device becoming inoperable.
5	Console Port	A Rack LCD Console may be installed in this port.
6	USB Ports	<ul style="list-style-type: none"> • Connect USB storage peripherals (CD/DVD, HD, flash drives, etc.). • A USB keyboard and mouse can be used in place of, or in addition to, a keyboard and mouse plugged in on the rear panel.

Rear

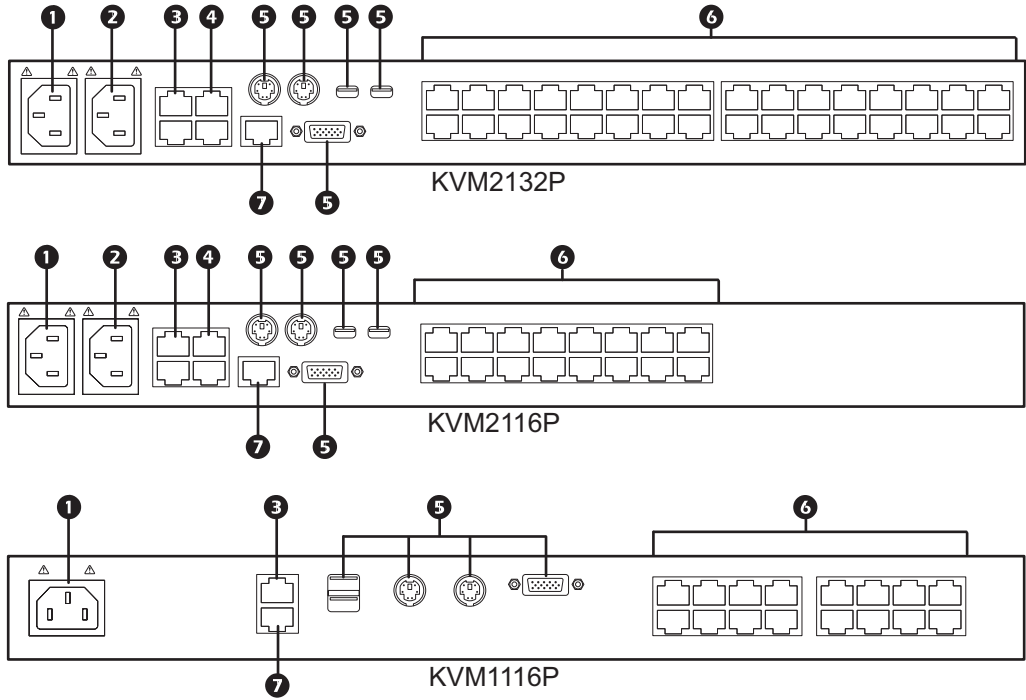

Item	Name	Description
❶	Power Socket 1	Plug power cable for Power Source 1 in here.
❷	Power Socket 2	Plug power cable for Power Source 2 in here.
❸	LAN Port(s)	Connect the unit to the network interface (10/100/1000 Mbps) here
❹	PDU Port(s)	Connect to a PDU unit (which allows servers attached to the KVM switch to be booted remotely over the net).
❺	Local Console Port(s)	Local console devices (keyboard, monitor and mouse), plug in here. Any combination of USB and PS/2 keyboards and mice can be used.
❻	KVM Ports	Cat 5e cables plug in to link the unit to the KVM Adapter Cables, which connect to the servers.
❼	Modem Port	Dial in connection if the unit becomes unavailable over the network.

Installation

Overview

KVM Adapter Cables connect the switch to the connected devices. A separate KVM Adapter Cable is required for each server or device connection. See the list of KVM Adapter Cables on page 5 or contact APC Customer Support for help.



- Note:** 1. Refer to the Safety section of this manual before installing the KVM switch.
2. Power to any device that will be connected to the installation must be turned off. Unplug the power cords of any computers that have the Keyboard Power On function.

Rack Mounting

The switch can be mounted in a 19" (1U) rack. The mounting brackets can screw into either the front or the back of the unit so that it can attach to the front or the back of the rack.



- Note:** Use cage nuts (not provided) for racks that are not pre-threaded.

Rack Mounting - Front

1. Position the switch in the front of the rack.
Align the mounting bracket holes with the holes in the rack.
2. Secure the mounting brackets to the rack.

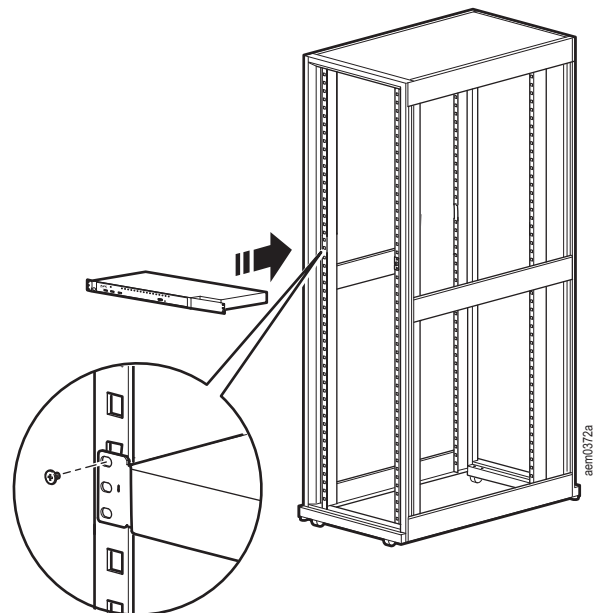

Rack Mounting - Rear

1. Remove the brackets from the front of the KVM switch.
Remove the plug from the alignment hole.

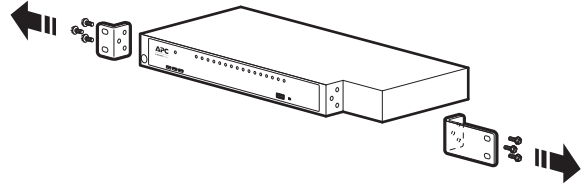

2. Install the smaller bracket from the front of the unit to the back. Install the rack mounting bracket from the inventory to the rear of the unit.

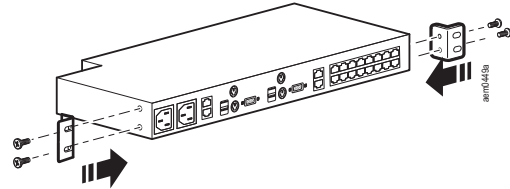

3. Slide the switch into the rack. Align the mounting bracket holes with the holes in the rack.
4. Secure the mounting brackets to the rear of the rack.

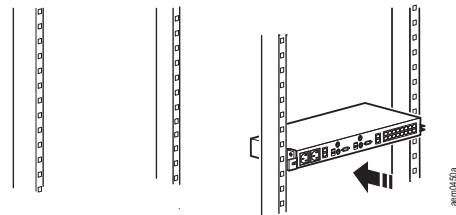

Optional KVM to LCD Console Mounting

The KVM switch can be mounted to a Rack LCD Console (not included). See the installation sheet for the Rack LCD Console KVM switch bracket kit for more information.

Single Level Installation

In a single level installation, no additional switches are tiered from the original switch.

1. Plug the keyboard, monitor, and mouse of your Local Console into the Console Ports of the KVM parent switch. Each port is color coded and marked with an appropriate icon.



Note: 1. Any combination of keyboard and mouse connections can be used.
2. USB keyboards and mice can be plugged into the USB ports on the front panel or into the console ports on the back.

2. Use Cat 5e cable to connect a KVM port to a KVM server module appropriate for the server being installed.
3. Plug the connectors on the KVM server module into the appropriate server ports.
4. Plug a cable from the LAN or WAN into the KVM switch's primary network interface socket.
5. (Optional) Plug another cable from the LAN or WAN into the KVM switch's backup (secondary) network interface socket.
6. (Optional) Use Cat 5e cable to connect the switch's Modem port to an SA0142 Serial Adapter. Connect the Adapter's serial connector to the modem's DB-9 port.
7. Plug the supplied power cord(s) into the switch's power socket(s), then into an AC power source.
8. Turn on the servers.

KVM1116P Single Level Installation Diagram

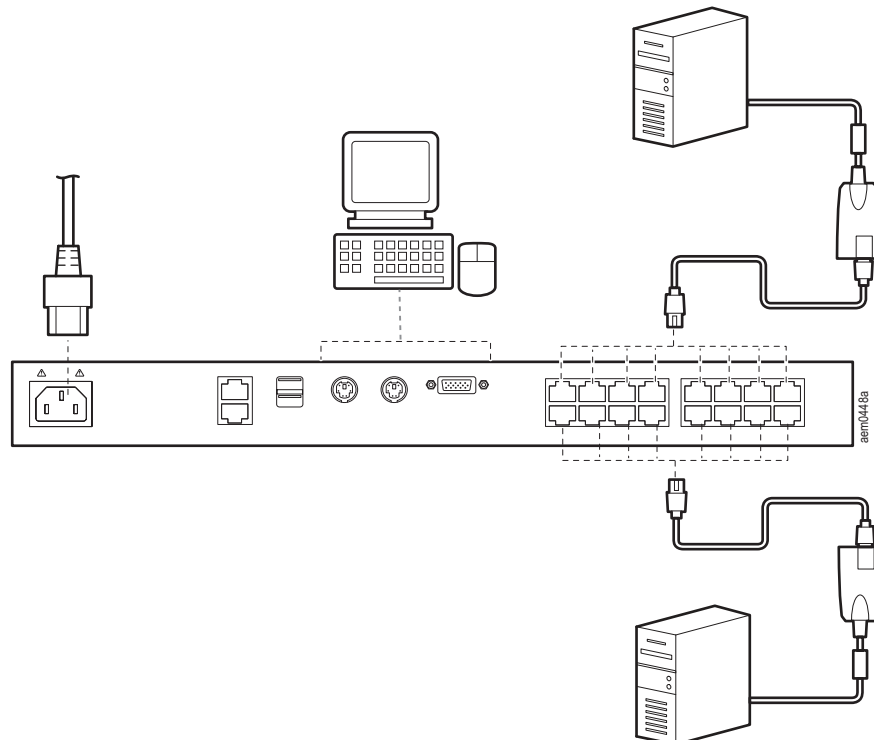

KVM2132P Single Level Installation Diagram

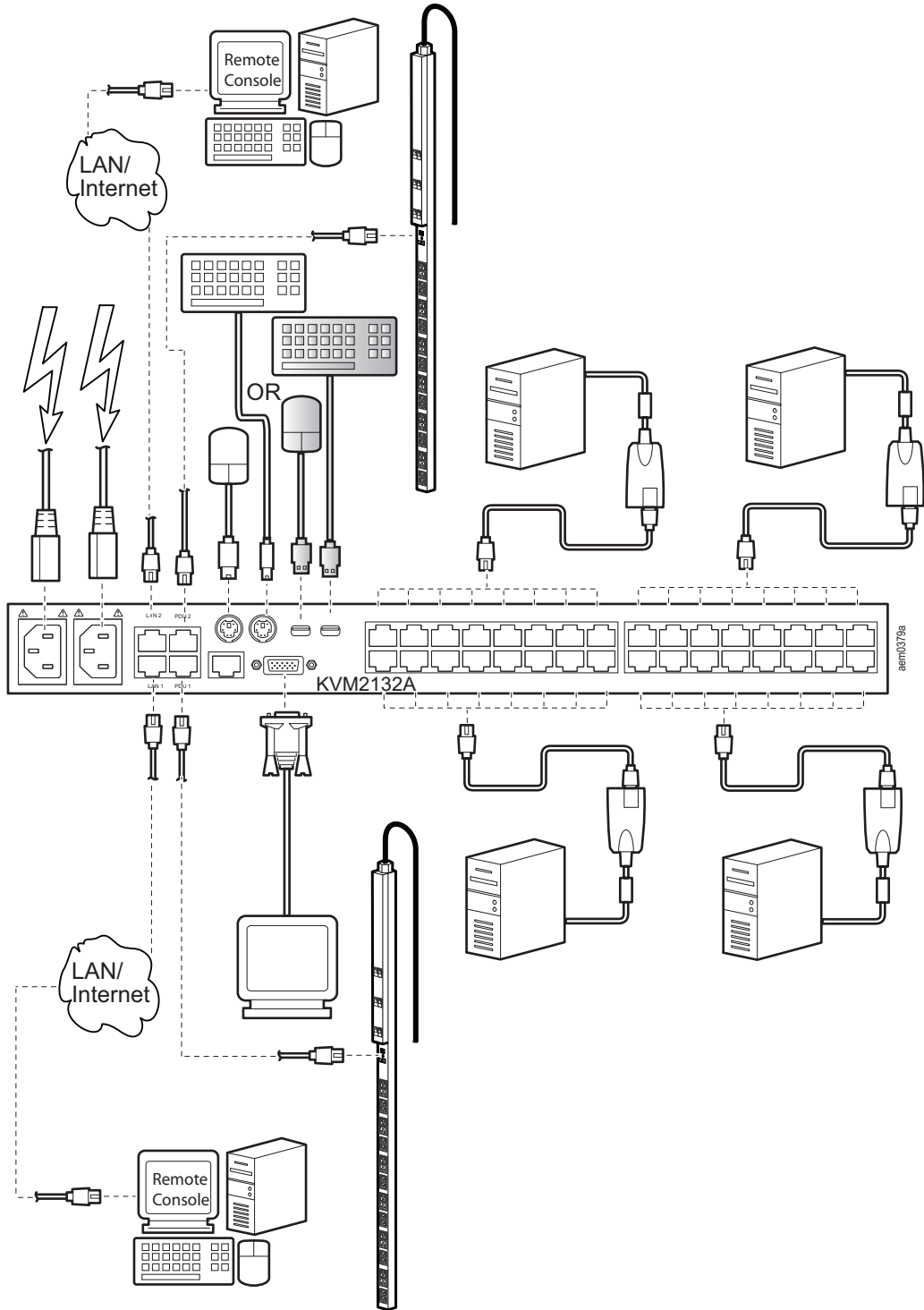

Note: KVM2116P Single Level Installation is the same except for the number of KVM ports.

Tiering Multiple KVM Switches

A tiered installation will greatly expand the number of servers that can be added to the installation. Cascaded tiering adds capacity to a KVM installation, but the parent loses at least one KVM port for each tiered KVM switch. KVM2132P, and KVM2116P support tiering up to 3 levels. When the KVM consoles of the first-level KVM switch invoke the OSD, all computers on the tiered KVM installation are listed in the port directory.

KVM1116P Two Level Installation

Up to 16 additional KVM switches can be tiered from the KVM ports of the original KVM switch. As many as 256 servers can be controlled in a complete two level installation. In a tiered installation, the (KVM1116P) switch is considered the First Level or Parent unit, the tiered switches are considered Second Level or Child units (KVM0116A / KVM0108A) . Turn off power to all the devices, including all pre-existing devices on the installation .

1. Use Cat 5e cable to connect any available KVM Port on the First Level unit (KVM1116P) to a KVM-PS2 Adapter Cable.
2. Plug the adapter cable's KVM connectors to the Keyboard, Video, and Mouse Console ports of the Second Level switch (KVM0116A / KVM0108A).
3. Connect any available KVM port on the Second Level unit to the Keyboard, Video, and Mouse ports of the server.
4. Power on the First Level switch, then power on the Second Level switches .
5. Turn the servers on last.

Two Level Installation Diagram

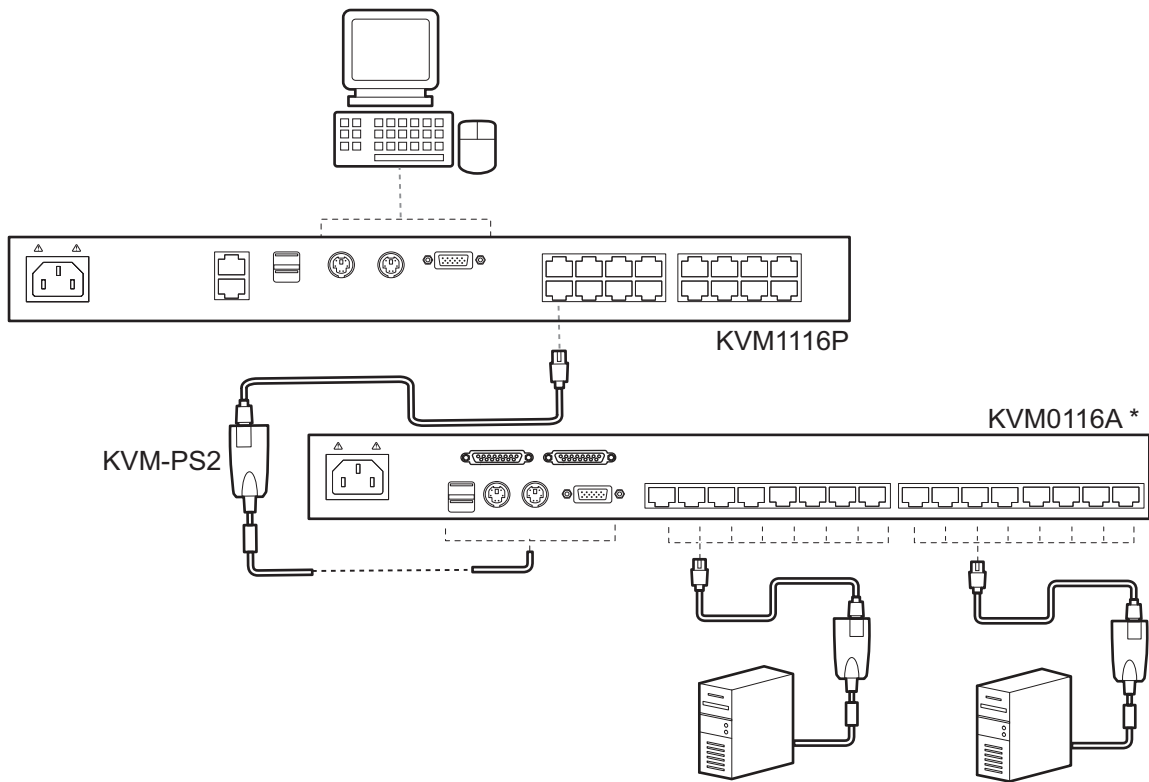

* See the User Manual for KVM0116A and KVM0108A for more information about this unit.

Three Level Installation and (1 or 2) Bus Configurations

In tiered installations, the number of bus connections between a parent and child KVM switch determines the number of users that can simultaneously access the KVM ports of a child switch. A bus connection is established by connecting a KVM port on the parent switch to a LAN port on the child switch. The KVM switch (KVM2132P, KVM2116P) supports a maximum of two bus connections for each tiered switch.

In a two-bus tiered configuration, two bus connections between every parent switch and child switch in the installation are created so both KVM consoles on the first-level KVM switch can access the KVM ports of any tiered switches at the same time. Console connectors of the child switches are inoperable.

In a one-bus tiered configuration only a single bus connection is created between a parent switch and a child switch. Only one of the consoles connected to the parent switch has access to a child switch at any time. The second console can still control and access the ports of the parent switch. Only one console of each child switch is available to access the KVM ports on the same level or lower level switch. KVM consoles connected to tiered switches cannot access the ports of a parent switch and can perform only port switching and user profile changes. No other administrative functions can be executed.

KVM2132P / KVM2116P Two busTiered Diagram

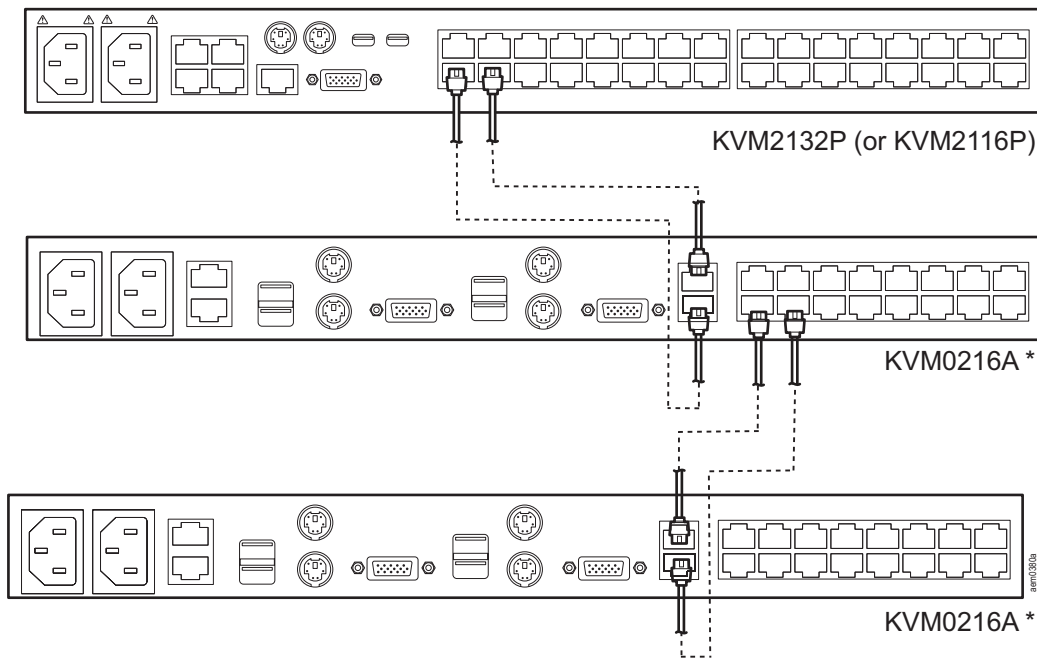

* See the User Manual for KVM0216A for more information about this KVM switch.

KVM1116P One Bus Tiered Diagram

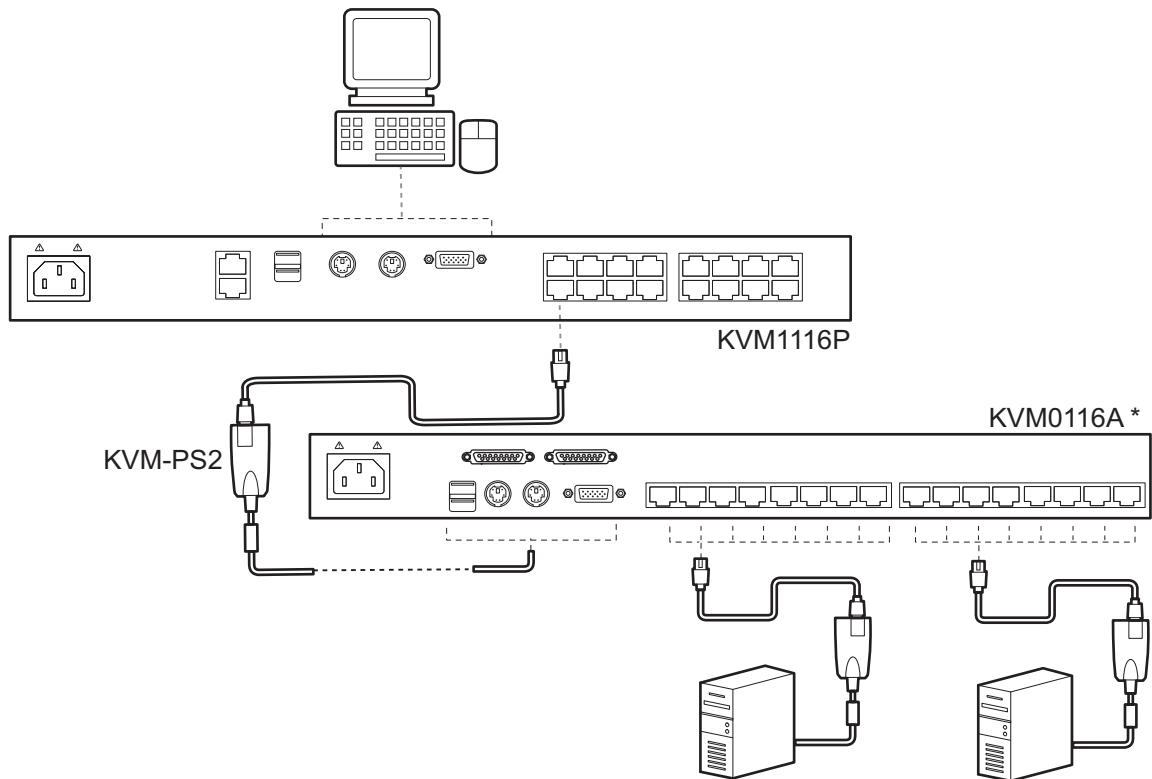

* See the User Manual for KVM0116A and KVM0108A for more information about these KVM switches.

Hardware Setup

Cable Length Considerations



Note: KVM server modules are also referred to as KVM adapter cables.

- Do not exceed 66 feet (20m) between the switch and the local monitor.
- The distance between the First Level (Parent) KVM switch and the Second Level (Child) KVM switch must not exceed 93 feet (30m).
- To support a resolution of 1280x1024, the recommended maximum distance between the KVM switch and the KVM server module is 164 feet (50m).
- The total distance between any KVM switch and any KVM server module in the installation cannot exceed 164 feet (50m).

Hot Plugging

The KVM switch supports hot plugging. Components can be removed and added by unplugging and re-plugging cables from the ports without shutting the unit down.



Note: The Operating System of the server must support hot plugging for this function to work properly.

The Adapter ID Function

Server module information (the Adapter ID, port name, OS, keyboard language, and access mode) is stored on the server module. The switch's Adapter ID function stores this information along with the server module's configuration information (access rights, etc.), so that when a server is moved with its server module from one port to another, its settings do not have to be reconfigured. The Adapter ID function restores them at the new location. Only the port number changes.

When moving the server and server module cable to another switch, only the information that is stored on the server module is retained. Other settings must be reconfigured, or the Backup/Restore function can be used (see page 93).

Port settings are stored with the server module. If a server is moved to a new port without its original server module, or if a different server is connected to the server module, the port settings for the new server must be manually configured. See “Sidebar Utilities” on page 38 for port configuration details.

Powering Off and Restarting

If the switch is powered off, or if the switch loses power and needs to be restarted, wait 10 seconds before powering it back on. Servers should not be affected, but if any fail, restart them.

Port ID Numbering

Each server on the installation is assigned a unique Port ID.

1. A server attached to a first level KVM switch has a one segment Port ID that corresponds to the KVM Port number to which it is connected.
2. A server attached to a Second Level KVM switch has a two segment Port ID.
 - a. The first segment represents the First Level unit's KVM Port number that connects to the Second Level KVM unit.
 - b. The second segment represents the Second Level unit's KVM Port number that connects to the server.

Example: A Port ID of 12 - 3 refers to a server connected to KVM Port 3 of a Second Level unit (child) connected to KVM Port 12 of the First Level unit (parent).

A server attached to a third level KVM switch has a three segment Port ID. Example: 12-03-05.

Port Selection

Port selection is accomplished by means of the GUI. See Port selection details on page 37.

PDU Connection (KVM2132P, KVM2116P)

- Connect the PDU and KVM switch with connection cable AP5641.
- The RJ12 connector plugs into the PDU port labeled “Serial”.
- The RJ45 connector plugs into the KVM port labeled “PDU1” or “PDU2”.

Super Administrator Setup

Overview

First Time Setup

The Super Administrator sets up the unit for user operation (set the network parameters, change the default Super Administrator login) for the first time from the local console if possible. See “IP Address Determination” on page 105 to set up remotely.

Since this is the first time you are logging in, use the default Username “**apc**” and Password “**apc**”. The Local Console Main Page will open following a successful login.



Note: For security purposes, changing to a unique Username and Password is recommended.

Network Setup

1. Click the Device Management tab.
2. Select the Network tab.
3. Fill in the fields according to the information provided under Network, page 68.

Changing the Super Administrator Login

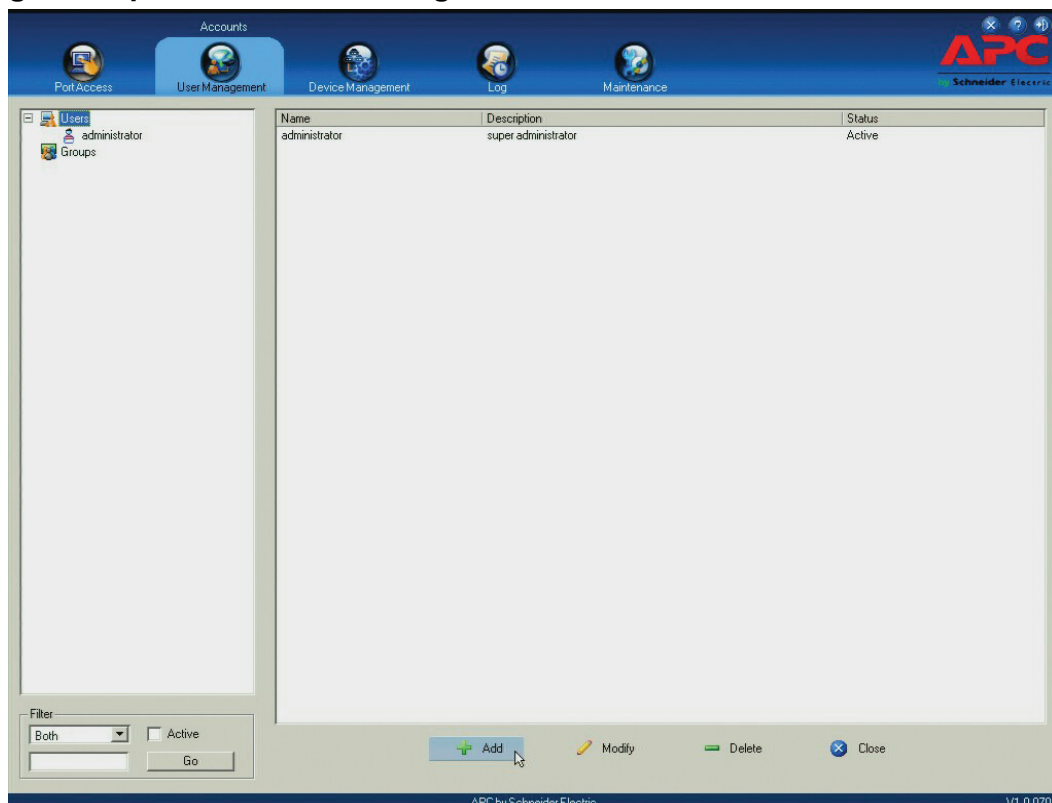

1. At the top of the screen, click the User tab.
The page lists Users and Groups in the Sidebar at the left, and more details in the center panel.
The first time the page is accessed, only the Super Administrator appears.

2. Click on **Administrator** in the left panel or select **Administrator** in the central panel. Click **Modify** at the bottom of the page to open the User Information page.

The screenshot displays the 'User Information' page. At the top, there are tabs for 'User', 'Groups', and 'Devices'. The main content area is titled 'User Information' and contains several sections:

- Username:** administrator
- Password:** [masked with dots]
- Confirm Password:** [masked with dots]
- Description:** super administrator
- Role:** Radio buttons for Super Administrator (selected), Administrator, and User.
- Permissions:** A grid of checkboxes for various permissions:
 - Device Management (checked)
 - Maintenance (checked)
 - Windows Client (checked)
 - Telnet Client (checked)
 - Port Configuration (checked)
 - System Log (checked)
 - Java Client (checked)
 - Force to Grayscale (unchecked)
 - User Management (checked)
 - View only (unchecked)
 - SSH Client (checked)
 - Power Management (checked)
- Status:** Radio buttons and checkboxes for account settings:
 - Disable account (unchecked)
 - Account never expires (selected)
 - Account expires on: [empty text box]
 - User must change password at next login (unchecked)
 - User cannot change password (unchecked)
 - Password never expires (selected)

3. Change the Username and Password.
4. Enter the new password again in the Confirm Password field and click **Save**.
5. Click **OK** in the dialog box that says the change completed successfully.
6. Click on another item on the Local Console Main Page, to close the User Information page.

Logging In

Overview

Switches can be accessed from a local console, an internet browser, a Windows application (AP) program, and a Java application (AP) program.

The switch's authentication procedure requires a valid username and password. Invalid login information will open an Invalid Username or Password, or Login Failed message.



Note: If the login fails, log in again with a correct username and password. If the number of invalid login attempts exceeds a specified amount, a timeout period is invoked. The timeout period must expire before another login is attempted. See Login Failures, page 75.

Local Console Login

Enter your Username and Password, then click Login to open the Local Console Main Page. The Local Console Main Page is similar to the Web Browser, WinClient and Java Client Main Pages. For a description of the Web Browser Main Page, see page 22.

Browser Login

The switch can be accessed from an Internet browser running on any platform.

1. Specify the IP address of the switch you want to access in the browser's address bar.



Note: If the administrator added a login string for security purposes, include a forward slash and the login string along with the IP address when you log in.

2. When a Security Alert dialog box opens, accept the certificate. It can be trusted. If a second certificate appears, accept it as well to open the login page.
3. Provide your username and password and click **Login** to open the Web Main Page.

Windows Client AP Login

The Windows AP Client allows direct remote access to Windows systems users, without going through a browser although initially the Windows AP Client program must be downloaded from the browser page.

Double-click the WinClient.exe icon to open the Windows Client Connection Screen:

The Windows Client AP Connection Screen

Item	Description
Menu Bar	The Menu Bar contains two items: File and Help. <ul style="list-style-type: none">• The File Menu allows the operator to Create, Save, and Open user created Work files.• The Help Menu displays the WinClient AP version.
Server List	WinClient.exe searches the user's local LAN segment for switches, and lists them in this box. Double-click to connect to one of these units. Note: 1. The switch's Enable Device List configuration parameter must be enabled. 2. Units in the Server List are those whose Access Port settings match the number specified for Port in the Server area of this dialog box.
Server	Used when connecting to a switch at a remote location. Select an address from the IP list box. If the address isn't listed, enter the target IP address in the IP field, and its port number in the Port field. If you don't know the port number, contact your Administrator. <ul style="list-style-type: none">• When the IP address and Port number have been specified, click Connect.• When finished, return to this dialog box and click Disconnect to end the connection.
Message Panel	Lists status messages regarding the connection to the switch.
Switch to Remote View	Click to switch to the GUI Main Page (page 23).

Connect using Windows Client AP

1. Select the device from the Server List box and double-click on it or specify its IP address and port number in the Server IP and Port input boxes.
2. Click **Connect** to open the Login dialog box.
3. Enter a valid Username and Password, and click **OK**.
4. Following authentication, the **Switch to Remote View** button becomes active. Click it to connect to the switch and bring up its GUI Main Page.

The File Menu

Create, Save, and Open user created Work files. A Work File consists of all the information specified in a Client session including the Server List, Server IP list items, and Hotkey settings. The Client program opens with the values contained in the current work file. The current work file consists of the values that were in effect the last time the program was closed.

New	Create a named work file so its values will not be lost, and it will be available for future recall.
Open	Open a previously saved work file and use the values contained in it.
Save	Save the values presently in effect as the current work file.
Exit	Exits the WinClient.

Java Client AP Login

The Java AP Client provides direct remote access to non-Windows systems users although the Java AP Client program is initially downloaded from the browser page. Double-click the JavaClient.jar icon to open the Java Client Connection Screen.

Item	Description
Server List	JavaClient.jar searches the user's local LAN segment for KVM switches, and lists them in this box. Double-click to connect to one of these units. Note: 1. The switch's Enable Device List configuration parameter must be enabled. 2. Units in the Server List are those whose Access Port settings match the number specified for Port in the Server area of this dialog box.
Server	Used when connecting to a switch at a remote location. Select an address from the IP list box. If the address isn't listed, enter the target IP address in the IP field, and its port number in the Port field. If you don't know the port number, contact your Administrator. <ul style="list-style-type: none">• When the IP address and Port number have been specified, click Connect.• When finished, return to this dialog box and click Disconnect to end the connection.
Message Panel	Lists status messages regarding the connection to the switch.
Switch to Remote View	Click this button to switch to the GUI Main Page.

Connect using - Java Client AP

To connect to a KVM switch:

1. Select the device from the Server List box and double-click on it or specify its IP address and port number in the Server IP and Port input boxes.
2. Click **Connect** to open the Login dialog box.
3. Enter a valid Username and Password, and click **OK**.
4. Following authentication, the **Switch to Remote View** button becomes active. Click it to connect to the switch and open its GUI Main Page.

The User Interface

Overview

The look of the user interface Main Page varies depending on the method used to log in.

The Web Browser Main Page

Access the KVM switches with most standard web browsers. Once users log in and are authenticated, the Web Browser Main Page opens with the Port Access page displayed.

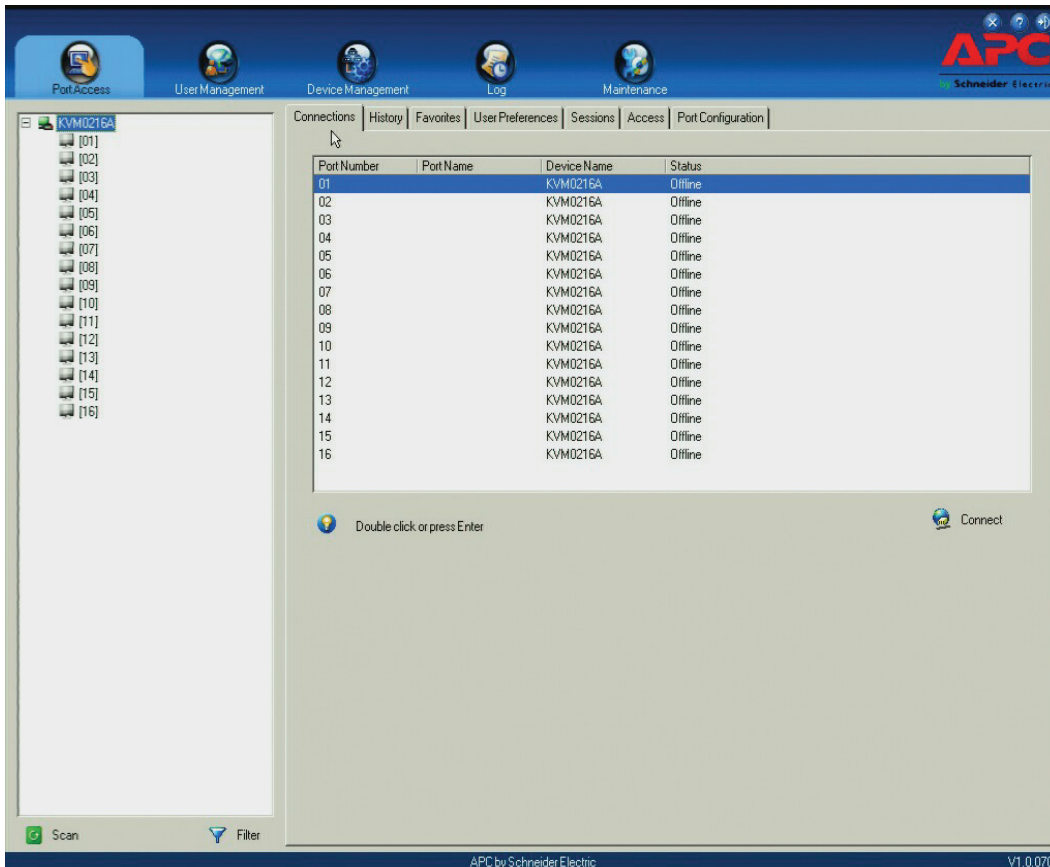





Note: Depending on a user's type and permissions, not all elements appear.

Item	Description
Tab Bar	Contains the KVM switch's main operation categories. Items appearing in the tab bar are determined by user type, and authorization options.
Menu Bar	Contains operational sub-categories related to the selected item in the tab bar. Items in the menu bar are determined by user type, and authorization options.
Sidebar	Provides a tree view listing of ports related to the tab bar and menu bar selections. Click an item in the Sidebar to open a detail page. Expand or narrow the scope of the ports that appear in the tree by clicking the Filter button at the bottom of the Sidebar. See the Filter function on page 40 for details.
About	Provides information regarding the switch's current firmware version.
Logout	Click this button to log out of your KVM switch session.
Welcome Message	If enabled (see Welcome Message*, page 112), a welcome message displays here.

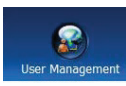
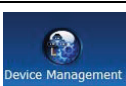

Interactive Display Panel	The main work area. The screens reflect menu choices and Sidebar item selection.
---------------------------	--

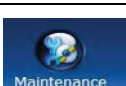
The Tab Bar

The number and type of icons that appear on the Tab Bar at the top of the page are determined by user type (Super Administrator, Administrator, User) and permissions.

Icon	Description
	Port Access: The Port Access page is used to access and control the devices on the KVM switch installation. This page is available to all users.
	Create and manage Users and Groups, also assign devices to them. This tab is available to the Super Administrator, administrators, and users who have User Management permission. The tab does not appear for other administrators and users.
	Configure and control the overall operation of the KVM switch. This page is available to the Super Administrator, administrators, and users who have Device Management permission. The tab doesn't appear for other administrators and users.
	Displays the contents of the log file.
	Install new firmware; backup and restore configuration and account information; ping network devices; and restore default values. This page is available to the Super Administrator (and Administrators and Users with Maintenance permission). The icon doesn't display on the page of ordinary administrators and users.
	Download AP versions of the Windows Client, the Java Client, and the Log Server. This page is available to all users. The programs that can be downloaded depend on the user's permissions.

There are two small icons at the extreme right of the page.

Icon	Description
	Click the About icon to see information about the KVM switch firmware version.
	Click the Logout icon to log out and end your KVM switch session.

The AP GUI Main Page

The GUI Main Page is similar to that of the Web Browser. The differences are:

1. The AP GUI version does not have a menu bar below the tab bar. It has tabs like a notebook. Like the Web Browser interface, the makeup of the tabs changes depending on the items selected on the main Tab Bar and in the Sidebar.
2. In addition to Filter, there are also buttons for Scan and Array Mode at the bottom of the Sidebar. See “Port Access” on page 37 for more information.
3. There is a hidden Control Panel at the upper (default position) or lower center of the screen that becomes visible when the mouse is moved over it.
4. There is an additional icon at the extreme right of the page. Click this icon to close the GUI Main Page and go to the display of the last selected port.

5. The GUI can be navigated via the keyboard.

Keys	Action
Ctrl + P	Opens the Port Access page.
Ctrl + U	Opens the User Management page.
Ctrl + C	Opens the Device Management page.
Ctrl + L	Opens the Log page.
Ctrl + M	Opens the Maintenance page.
Ctrl + D	Opens the Download page.
F1	To see About information
F2	To edit the port name of the selected port
F4	Selects the Sidebar (left) panel.
F5	Selects the main (right) panel
F7	Closes the GUI.
F8	To log out.

The Local Console GUI Main Page

The main difference between the Local Console GUI Main Page and the Java and Windows AP GUI Main Page is the Local Console Main Page does not have a tab for Download.

The Control Panel

The WinClient Control Panel (for the ActiveX Web Viewer and WinClient AP) contains the most complete functionality. This section describes the WinClient Control Panel.

The Java Control Panel (for the Web Viewer and Java Client AP) does not enable all of the features that the WinClient Control Panel enables. The features that are common to both panels also function similarly.

The Control Panel is hidden at the upper (the default position) or lower center of the screen, and becomes visible when the mouse moves over it. The panel consists of three rows: an icon row at the top, and two text rows below.



Note: The icons that appear can be user selected. See “Control Panel Configuration” on page 35, for details.

- By default, the upper text row shows the video resolution of the remote display. As the mouse pointer moves over the icons, the information in the upper text row changes to describe the icon's function. If a message from another user is entered in the message board, and the message board has not been opened, the message will appear in the upper row.

- The lower row shows the IP address of the device you are accessing at the left of the row. The center of the row indicates which bus the user is on (the number before the slash), and the total number of users on that bus (the number behind the slash).







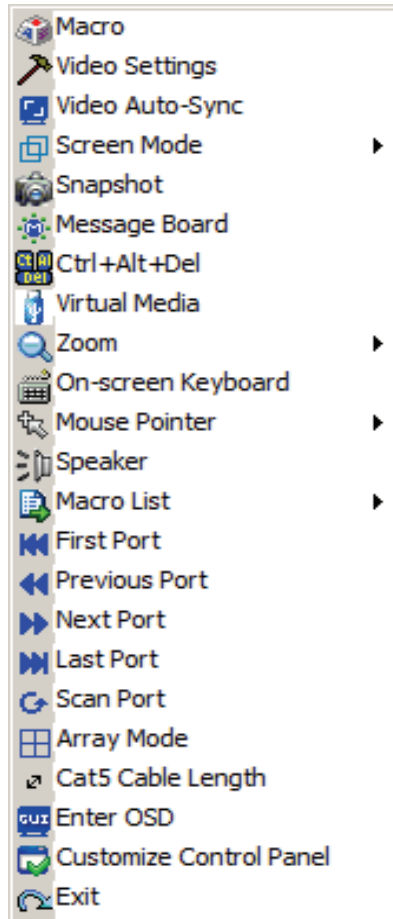













Note: Bus and user information only display if enabled.









- Right click in the text row area to open a menu-style version of the toolbar. Select options for the Screen Mode, Zoom, Mouse Pointer type, and Mouse Sync Mode.



- To move the Control Panel to a different location on the screen, move the mouse pointer over the text row area, then click and drag.

WinClient Control Panel Functions

Icon	Function
	Toggle icon. Click to make the Control Panel always display on top of other screen elements. Click again to have it display normally.
	Macro icon. Click to open the Macros dialog box (see page 30 for details).
	Hammer icon. Click to open the Video Options dialog box. Right-click to perform a quick Auto Sync (see “Video Settings” on page 30 for details).
	Click to perform a video and mouse autosync operation. It is the same as clicking the Auto-sync button in the Video Options dialog box (see “Video Settings” on page 30).
	Toggle the display between Full Screen Mode and Window Mode.
	Click to take a snapshot (screen capture) of the remote display. See “Snapshot” on page 35 for details.
	Click to open the Message Board (see “The Message Board” on page 31).
	Click to send a Ctrl+Alt+Del signal to the remote system.
	Click to toggle the remote display between color and gray scale views.
	Click to open the Virtual Media dialog box. See “Virtual Media” on page 32 for details. Note: 1. This icon is displayed on the switches only. 2. This icon displays in gray when the function is disabled or not available.
	Click to zoom the remote display window. Note: This feature is only available in windowed mode (Full Screen Mode is off). See “Zoom” on page 33 for details.
	Click to open the on-screen keyboard (see “The On-Screen Keyboard” on page 33).
	Click to select the mouse pointer type. Note: This icon changes depending on which mouse pointer type is selected (see “Mouse Pointer Type” on page 34)
	Click to toggle Automatic or Manual mouse sync. • When the selection is Automatic, a green V appears on the icon. • When the selection is Manual, a red X appears on the icon. See “Mouse DynaSync Mode” on page 34 for details.
	Click to open a list of User macros in order to access and run macros more conveniently than using the Macros dialog box.
	Under an accessed port, click to skip to the first port accessible to the user on the entire installation without going to the Port Access page.
	Under an accessed port, click to skip to the first port accessible to the user that is previous to the current one without going to the Port Access page.
	Under an accessed port, click to skip to the first port accessible to the user that is after the current one without going to the Port Access page.

	Under an accessed port, click to skip to the last port accessible to the user on the entire installation without going to the Port Access page.
	Under an accessed port, click to begin Auto Scan Mode. The KVM switch automatically switches among the ports selected for Auto Scanning with the Filter function (see Filter, page 40). Monitor the activity of the ports without switching through them manually.
	Under an accessed port, click to invoke Panel Array Mode (see “Panel Array Mode” on page 88).
	Under an accessed port, click this icon to select the Adapter cable (Short, Medium, Long) that connects the device to the switch. The length of the line in the icon indicates the selection.
	Under an accessed port, click to recall the GUI.
	Click to open the Control Panel Configuration dialog box. See “Control Panel Configuration” on page 35, for more information.
	Click to exit the viewer. <ul style="list-style-type: none"> • Exit from a Browser Viewer session brings you back to the web browser Main Page. • Exit from a WinClient AP session brings you back to the login dialog box. • Exit from a Java Client AP session brings you back to the login dialog box.
	These icons show the Num Lock, Caps Lock, and Scroll Lock status of the remote computer. <ul style="list-style-type: none"> • When the lock is On, the LED is bright green and the lock hasp is closed. • When the lock is Off, the LED is dull green and the lock hasp is open. Click on the icon to toggle the status. Note: These icons and your local keyboard icons are in sync. Press a Lock key on your keyboard and the icon changes accordingly.

Macros

There are three functions in the Macros dialog box: Hotkeys, User Macros, and System Macros.

Hotkeys. The Hotkey Setup utility (accessed by clicking the icon), lets you configure which hotkeys perform actions. The hotkeys that invoke an action are shown to the right of its name. Click to put a check in the checkbox to the left of an action's name to enable or disable its hotkey.

To change the hotkey for an action:

1. Highlight the Action, then click **Set Hotkey**.
2. Press your selected Function keys (one at a time). The key names appear in the Hotkeys field as you press them.
 - a. The same function keys can be used for more than one action, as long as the key sequence is not the same.
 - b. To cancel setting a hotkey value, click **Cancel**. To clear an action's Hotkeys field, click **Clear**.
3. When you have finished entering your sequence, click **Save**. To reset all the hotkeys to their default values, click **Reset**.

Hotkey actions:

Action	Explanation
Exit remote location	Breaks the connection to the KVM switch and returns you to local client computer operation. This is equivalent to clicking the Exit icon on the Control Panel. The default keys are F2, F3, F4.
Adjust Video	Opens the Video Settings dialog box. This is equivalent to clicking the Video Settings icon on the Control Panel. The default keys are F5, F6, F7.
Toggle Control Panel	Toggles the Control Panel Off and On. The default keys are F3, F4, F5.
Toggle mouse display	If the display of the two mouse pointers (local and remote) is confusing or annoying, shrink the non-functioning pointer down to a tiny circle, which can be ignored. This function is a toggle. Use the hotkeys to bring the mouse display back to its original configuration. This is equivalent to selecting the Single pointer type from the Mouse Pointer icon on the Control Panel. The default keys are F7, F8, F9. Note: The Java Control Panel does not have this feature.
Adjust mouse	This synchronizes the local and remote mouse movements. The default keys are F7, F8, F9.
Video Auto-sync	This combination performs an auto-sync operation. It is equivalent to clicking the Video Autosync icon on the Control Panel. The default keys are F8, F7, F6.
Show/Hide Local Cursor	Toggles your local mouse pointer off and on. This is equivalent to selecting the Null pointer type from the Mouse Pointer icon on the Control Panel. The default keys are F4, F5.
Substitute Ctrl key	If your local computer captures Ctrl key combinations, preventing them from being sent to the remote server, implement their effects on the remote server by specifying a function key to substitute for the Ctrl key. Example: Substituting the F11 key, pressing [F11 + 5] would appear to the remote server as [Ctrl + 5]. The default key is F11.
Substitute Alt key	In order to implement [Alt + Tab] and [Ctrl + Alt + Del] effects on the remote server, another key is substituted for the Alt key. Substituting the F12 key, for example, you would use [F12 + Tab] and [Ctrl + F12 + Del]. The default key is F12.

User Macros. User Macros perform specific actions on the remote server.

To create the macro:

1. Select User Macros, then click **Add**.
2. Replace the “New Macro” text in the dialog box with a name of your choice for the macro.
3. Click **Record**. The dialog box closes, and a small panel opens at the top left of the screen.
4. Press the keys for the macro.
 - a. To pause macro recording, click **Pause**. To resume, click **Pause** again.
 - b. Clicking Show opens a dialog box that lists each keystroke that you make, together with the amount of time each one takes:
 - c. Click **Cancel** to cancel all keystrokes.
 - d. When you have finished, click **Stop**. (This is the equivalent of clicking Done in Step 5.)



Note: 1. The function is not case-sensitive.

2. When recording the macro, the focus must be on the remote screen not the macro dialog box.

3. Only the default keyboard characters may be used.

5. If the Show dialog box has not been opened, click **Done** when you have finished recording your macro. The screen returns to the Macros dialog box with system macro key presses displayed in the Macro column
6. To change keystrokes, select the macro and click **Edit**. This dialog box is similar to the one for Show. Keystrokes, order, etc. can be changed.

Three ways to run macros:

1. Use the assigned hotkey.
2. Click on the macro from the Macro List on the Control Panel.
3. Open the Macros dialog box and click **Play**.
Run the macro from the Macros dialog box to have the option of specifying how the macro runs.
 - Click **Play Without Wait** to run the keypresses one after another with no time delay between them.
 - Click **Play With Time Control** and wait for the amount of time between key presses that you took when you created the macro. Click on the arrow next to Play to choose.
 - Click **Play** without opening the list to run with the default choice (NoWait or TimeCtrl), which is shown in the Playback column. Change the default choice by clicking on the current choice and selecting the alternate choice.



Note: User Macros are stored on the Local Client computer of each user.

There is no limit on the of number of macros, the size of the macro names, or makeup of the hotkey combinations.

Click the **Search** button at the bottom of the dialog box to filter the list of macros in the upper panel to play or edit. Click a radio button to choose whether to search by name or by key. Enter a string for the search, then click **Search**. All instances that match the search string appear in the upper panel.

System Macros. System Macros are used to create exit macros for closing a session.

Example: As an added measure of security, create a macro that sends the Winkey-L combination which will cause the remote server's log in page to open the next time the device is accessed. To create the macro:

1. Select System Macros, then click **Add**.
2. In the dialog box, replace the “New Macro” text with a name for the macro.
3. Click **Record** to close the dialog box, and open a small panel at the top left of the screen:
4. Press the keys for the macro.
 - a. To pause macro recording, click **Pause**. To resume, click **Pause** again.
 - b. Click **Show** to open a dialog box listing each keystroke that you make, together with the amount of time each one takes.
5. If **Show** has not been opened, click **Done** when you have finished recording your macro. Return to the Macros dialog box and the system macro key presses display in the Macro column
6. To change keystrokes, select the macro and click **Edit**. A dialog box similar to the one for **Show** opens. Keystrokes, order, etc. can be changed.

Once system macros have been created, they are available for use on a port-by-port basis. Select them on a port's Port Configuration > Port Properties page.

Video Settings

Clicking the Hammer icon on the Control Panel brings up the Video Settings dialog box. Adjust the placement and picture quality of the remote screen on your monitor with these options.

Options	Usage
Screen Position	Adjust the horizontal and vertical position of the remote server window by clicking the Arrow buttons.
Auto-Sync	Click to have the vertical and horizontal offset values of the remote screen detected and automatically synchronized with the local screen. Note: 1. If the local and remote mouse pointers are out of sync, in most cases, performing this function will bring them back into sync. 2. This function works best with a bright screen. 3. If the results are unsatisfactory, use the Screen Position arrows to position the remote display manually.
RGB	Drag the slider bars to adjust the RGB (Red, Green, Blue) values. When an RGB value is increased, the RGB component of the image is correspondingly increased. If you enable Set to Grayscale , the remote video display is changed to grayscale.
Gamma	This section allows you to adjust the video display's gamma level.
Network Type	Select the type of internet connection that the local client computer uses. The switch will use that selection to automatically adjust the Video Quality and Detect Tolerance settings to optimize the quality of the video display. Since network conditions vary, if none of the pre-set choices work well, select Customize and use the Video Quality and Detect Tolerance slider bars to adjust the settings to suit your conditions.
Video Quality	Drag the slider bar to adjust the overall Video Quality. The larger the value, the clearer the picture and the more video data goes through the network. Depending on the network bandwidth, a high value may adversely effect the PDU response time.
Enable Refresh	Select Enable Refresh and enter a number from 1 through 99. The KVM switch will refresh the screen at the interval specified. This feature is disabled by default. Click to put a check mark in the box next to Enable Refresh to use this feature. Note: 1. The switch starts counting the time interval when mouse movement stops. 2. Enabling this feature increases the volume of video data transmitted over the network. The lower the number specified, the more often the video data is transmitted. Setting the value too low may adversely affect PDU response.
Transparency	Adjusts toolbar transparency when the GUI hotkey is invoked. Slide the bar until the display in the example window is satisfactory.
Color Depth Control	This setting determines the richness of the video display by adjusting the amount of color information.
Detect Tolerance	This setting governs detecting or ignoring pixel changes. A high setting can result in a lower quality display due to less data transfer. A lower setting will result in better video quality. Setting the threshold too low may allow too much data to be transferred, negatively impacting network performance.

Gamma Adjustment. If it is necessary to correct the gamma level for the remote video display, use the Gamma function of the Video Adjustment dialog box.





- Under Basic configuration, there are ten preset and four user-defined levels to choose from. Choose the most suitable one from the list.
- For greater control, click the **Advanced** button to open the dialog box
- Click and drag the diagonal line at as many points as needed for the display output desired.
- Click **Save As** to save up to four user-defined configurations. Saved configurations can be opened from the list box.
- Click **Reset** to abandon any changes and return the gamma line to its original position.
- Click **OK** to save your changes and close the dialog box.
- Click **Cancel** to abandon your changes and close the dialog box.



Note: For best results, change the gamma while viewing a remote server.

The Message Board

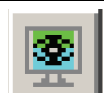
A message board has been provided for users to communicate and to alleviate access conflicts. The buttons on the Button Bar are toggles. Their actions are described in the table below:

Button	Action
	Enable/Disable Chat. When disabled, messages posted to the board are not displayed. The button is shadowed when Chat is disabled. The icon displays next to the user's name in the User List panel when the user has disabled Chat.
	Occupy/Release Keyboard/Video/Mouse. When you Occupy the KVM, other users cannot see the video, and cannot input keyboard or mouse data. The button is shadowed when the KVM is occupied. The icon displays next to the user's name in the User List panel when the user has occupied the KVM.
	Occupy/Release Keyboard/Mouse. When you Occupy the KM, other users can see the video, but cannot input keyboard or mouse data. The button is shadowed when the KVM is occupied. The icon displays next to the user's name in the User List panel when the user has occupied the KVM.
	Show/Hide User List. When you Hide the User List, the User List panel closes. The button is shadowed when the User List is open.

Message Display Panel. Messages that users post to the board as well as system messages display in this panel. If Chat is disabled, messages posted to the board will not appear.

Compose Panel. Enter the messages in this panel. Click **Send**, or press [ENTER] to post the message to the board.

User List Panel. The names of all the logged in users are listed in this panel.



- Your name appears in blue. Other users' names appear in black.
- By default, messages are posted to all users. To post a message to one individual user, select the user's name before sending your message.
- If a user's name is selected, and you want to post a message to all users, select **All Users** before sending your message.
- If a user has disabled Chat, the icon displays before the user's name.
- If a user has occupied the KVM, its icon displays before the user's name.

Virtual Media

The Virtual Media feature allows a drive, folder, image file, or removable disk on a user's system to appear and act as if it were installed on the remote server.



Note: 1. Virtual Media is only supported on remote servers that use the specified adapter cables. 2. The Virtual Media icon changes depending on the status of the virtual media function.

Button	Action
	The icon displays in gray to indicate that the virtual media function is disabled or not available
	The icon displays in blue to indicate that the virtual media function is available. Click the icon to bring up the virtual media dialog box.
	The icon displays in blue with a red X to indicate that a virtual media device has been mounted on the remote server. Click the icon to unmount all redirected devices.

Mounting Virtual Media. To mount a virtual media device:

1. Click the Virtual Media icon to open the Virtual Media dialog box.



Note: The T button at the top right opens a slider bar to adjust the transparency of the dialog box. After making your adjustment, click anywhere in the dialog box to dismiss the slider.

2. Click **Add**, then select the media source. Additional dialog boxes open to enable selection of the drive, file, folder, or removable disk. See “Virtual Media Support” on page 105 for a list of supported virtual media types.
3. If your device only supports full speed USB, put a check in the **Disable High Speed USB Operation Mode** checkbox.
4. To add additional media sources, click **Add**, and select the source as many times as required. Up to three virtual media choices can be mounted. The top three in the list are the selected sources. To rearrange the selection order, highlight the device to be moved, then click the **Up or Down Arrow** button to promote or demote it in the list.
5. **Read** refers to the redirected device being able to send data to the remote server. **Write** refers to the redirected device being able to have data from the remote server written to it. For the redirected device to be writable as well as readable, click to put a check in the **Enable Write** checkbox. If a redirected device cannot be written to, it appears in gray.
6. To remove an entry from the list, select it and click **Remove**.
7. After you have made your media source selections, click **Mount** and the dialog box closes. The virtual media devices that you have selected are redirected to the remote server where they show up as drives, files, folders, etc. on the remote server's file system. Once mounted, you can treat the virtual media as if they really existed on the remote server. Drag and drop files to or from them, open files on the remote server for editing, and save them to the redirected media. Files that you save to the redirected media will actually be saved on your local client computer's storage. Files that you drag from the redirected media will actually come from your local client computer's storage.
8. To end the redirection, open the Control Panel and click on the Virtual Media icon. All mounted devices are automatically unmounted.

Zoom

The Zoom icon controls the zoom factor for the remote view window.

Setting	Description
100%	Sizes and displays the remote view window at 100%.
75%	Sizes and displays the remote view window at 75%.
50%	Sizes and displays the remote view window at 50%.
25%	Sizes and displays the remote view window at 25%.
1:1	Sizes and displays the remote view window at 100%. The difference between this setting and the 100% setting is that when the remote view window is resized, its contents don't resize. They remain at the size they were. To see any objects that are outside of the viewing area move the mouse to the window edge, to have the screen scroll.

The On-Screen Keyboard

The KVM switch supports an on-screen keyboard, available in multiple languages, with all the standard keys for each supported language. Click the icon to open the on-screen keyboard.

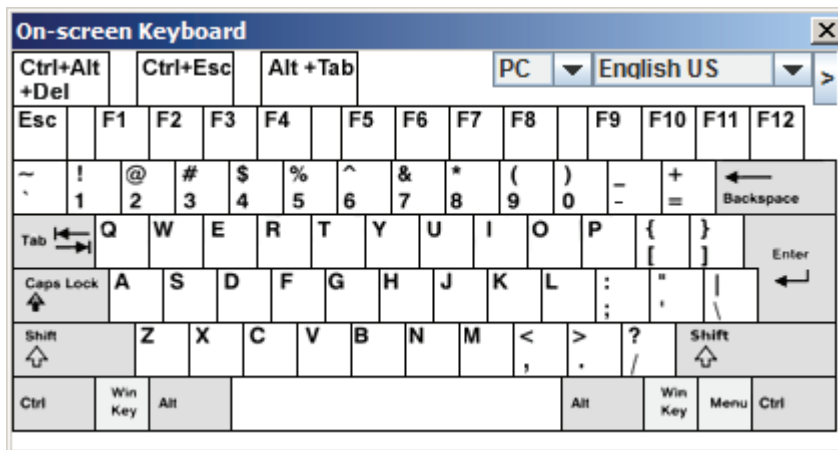

If the keyboard languages of the remote and local systems are not the same, the configuration settings for either system do not have to be changed. Open the on-screen keyboard, select the language used by the server being accessed, and use the on-screen keyboard to communicate with it. You must use your mouse to click on the keys. You cannot use your actual keyboard.

Changing Languages.

1. Click the **Down** arrow next to the currently selected language to open the language list.
2. Select the new language from the list.

Selecting Platforms. The On-screen Keyboard supports the Sun platform as well as the PC. To select the platform:

1. Click the **Down** arrow next to the currently selected platform to open the platform list.
2. Select the new platform from the list.

Expanded Keyboard. To display or hide the expanded keyboard keys, click the arrow to the right of the language list arrow.

Mouse Pointer Type

The KVM switch offers several mouse pointer options when working in the remote display. Click the icon to select from the available choices.



- Note:**
1. Before accessing a port, only Dual and Crosshairs are available for the Windows Viewers. Once the port is accessed, all four pointers are available.
 2. The Dot pointer is not available with the Java Applet Viewer or the Java Client AP.
 3. Selecting the Dot pointer has the same effect as the Toggle mouse display hotkey function (see “Toggle mouse display” on page 28 for details).
 4. The icon on the Control Panel changes to match your choice.

Mouse DynaSync Mode

Synchronization of the local and remote mouse pointers is accomplished either automatically or manually.

Automatic Mouse Synchronization (DynaSync). Mouse DynaSync provides automatic locked-in synching of the remote and local mouse pointers.



- Note:** This feature is only available for Windows and Mac systems (G4 and higher) whose adapter attribute OS setting is configured for Win or Mac (see “Port Properties” on page 39), which are connected to the switch with one of the specified Adapter Cables. All other configurations must use manual mouse synchronization.

The icon on the Control Panel indicates the synchronization mode status.

- The icon displays in gray to indicate that Mouse DynaSync is not available - you must use manual synching procedures. This is the default setting.
- The green check mark on this icon indicates that Mouse DynaSync is available and is enabled. This is the default setting when Mouse DynaSync is available.
- The red X on this icon indicates that Mouse DynaSync is available but is not enabled.

When Mouse DynaSync is available, clicking the icon toggles its status between enabled and disabled. If you choose to disable Mouse DynaSync mode, you must use the manual synching procedures.

Mac and Linux Considerations.

- For Mac OS versions 10.4.11 and higher, there is a second DynaSync setting to choose from. If the default Mouse DynaSync result is not satisfactory, try the Mac 2 setting. To select Mac 2, right click in the text area of the Control Panel and select Mouse Sync Mode > Automatic for Mac 2.
- Linux doesn't support DynaSync Mode, but there is a setting on the Mouse Sync Mode menu for Redhat AS3.0 systems. If you are using a USB Adapter Cable, with an AS3.0 system and the default mouse synchronization is not satisfactory, you can try the Redhat AS3.0 setting. In either case, you must perform the manual mouse synchronization procedures described in the next section.

Manual Mouse Synchronization. If the local mouse pointer goes out of sync with the remote system's mouse pointer there are several methods to bring them back into sync.

1. Perform a video and mouse auto sync by clicking the Video Settings icon on the Control Panel (see page 30).
2. Perform an Auto Sync with the Video Adjustment function (see “Video Settings” on page 30, for details).
3. Invoke the Adjust Mouse function with the Adjust Mouse hotkeys (see “Adjust mouse” on page 28, for details).
4. Move the pointer into all 4 corners of the screen (in any order).
5. Drag the Control Panel to a different position on the screen.
6. Set the mouse speed and acceleration for each problematic server attached to the switch. See “Additional Mouse Synchronization Procedures” on page 108, for instructions.

Control Panel Configuration

Click the Control Panel icon to open a dialog box. Configure the items and graphical settings on the Control Panel.

Item	Function
Customize Control Panel	Select which icons display in the Control Panel. Check the icons to be visible. Unchecked icons will not be displayed
Control Panel Style	Enabling Transparent makes the Control Panel semi-transparent so that the display underneath can be seen. When Enabled, the Control Panel displays as an icon until the mouse is moved over it, then the full panel opens.
Screen Options	<ul style="list-style-type: none"> • If Full Screen Mode is enabled, the remote display fills the entire screen. • If Full Screen Mode is not enabled, the remote display appears as a window on the local desktop. If the remote screen is larger than can fit in the window, move the mouse pointer to the screen border closest to the area you want to view and the screen will scroll. • If Keep Screen Size is enabled, the remote screen is not resized. • If the remote resolution is smaller than that of the local monitor, its display appears like a window centered on the screen. • If the remote resolution is larger than that of the local monitor, its display is centered on the screen. To access the areas that are off screen, move the mouse to the corner of the screen that is closest to the area you want to view and the screen will scroll. • If Keep Screen Size is not enabled, the remote screen is resized to fit the local monitor's resolution.
Scrolling Method	<p>If the remote screen display is larger than your monitor, you can choose how to scroll to the areas that are off-screen.</p> <ul style="list-style-type: none"> • Select Mouse Movement to scroll the screen when the mouse pointer is moved to the screen border. • Select Scroll Bars to open scroll bars around the screen borders that can be used to scroll to the off-screen areas.
Bus Info	If Bus Info is enabled, the number of the bus you are on, as well as the total number of users on the bus, displays on the bottom row center of the Control Panel (Bus No./Total Users).
Snapshot	<p>Configure the KVM switch's screen capture parameters.</p> <ul style="list-style-type: none"> • Path: The directory where captured screens will automatically get saved. Click Browse to navigate to the directory, then click OK. If a directory is not specified here, the snapshot is saved to your desktop. • Click a radio button to save the captured screen as a BMP or a JPEG (JPG) file. • With JPEG, the quality of the captured file can be adjusted with the slider bar. Higher quality will improve the appearance and increase the file size.
Keyboard Pass Through	When enabled, the Alt-Tab key press is passed to the remote server and affects that server. If it is not enabled, Alt-Tab acts on your local client computer.

The Java Control Panel

The Java Applet Viewer and Java Client AP Control Panel is similar to that used by the WinClient. The major differences are:

- In the Macros dialog box, Toggle Mouse Display is not available.
- The Dot mouse pointer type is not available.
- In the Message Board, there is no Show/Hide button for the user list. This function is achieved by clicking the arrows at the top of the bar that separates the User List panel from the Main panel.
- In Virtual Media, only ISO and Folder are supported.
- The Control Panel Lock LED icons are not in sync with your keyboard. When you first connect, the LED display may not be accurate. Click on the LED icons to set them.

Port Access

Overview

The Port Access page opens with the KVM switch's KVM Connections page displayed.

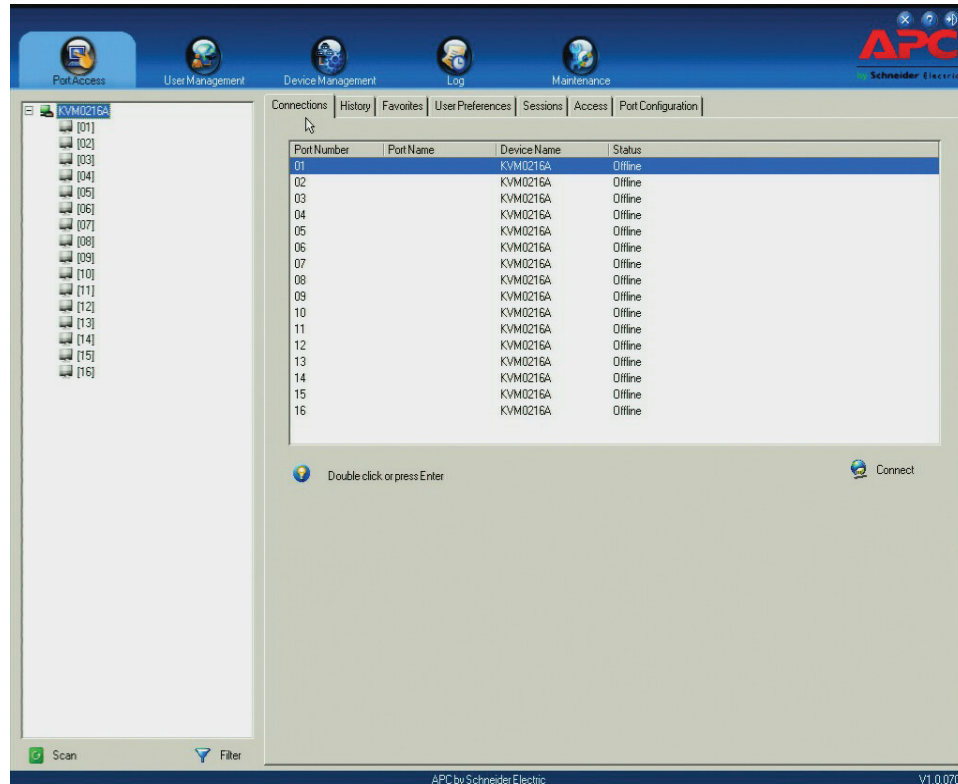

The Connections page is organized into several main areas. All the devices, ports, and outlets that a user is permitted to access are listed in the Sidebar at the left of the page. Any Rack PDU devices (Power Distribution Units) connected to the switches are listed separately below the switch listings. Blade Servers are listed below the PDU devices.

After selecting a device, port, or outlet in the Sidebar, clicking entries on the menu bar (Browser GUI) or tab bar (AP GUI) opens information and configuration pages related to the item.

The Sidebar

All KVM switches, PDU devices, and Blade Servers including, their ports and outlets, are listed in a tree structure in the Sidebar at the left of the screen.

The Sidebar Tree Structure

- Users only see the devices, ports, and outlets for which they have access permission.
- Ports, outlets, and child devices can be nested under their parent devices.
Click the + in front of a device to expand the tree and see the ports/outlets nested underneath it.
Click the - to collapse the tree and hide the nested ports/outlets.
- ID numbers of the ports and outlets are displayed in brackets next to the icon. Ports and outlets can also be named.
- Monitor screen icons are Green for on line switches and ports and Gray when offline.
- Outlet Icons are Amber when On and Gray when Off.
- To access and operate a port, double click its icon.



- Note:** 1. In the Browser page, you can open as many port viewers as there are ports, but the number of ports that you see depends on the number of buses that the switch supports.
2. In the AP GUI version only one port at a time can be accessed. To see two different ports, you have to log in two separate times.
3. PDU devices and Blade Servers do not appear in the Sidebar, (even if they are configured on the switch) if KVM Access Management is used.

Sidebar Utilities

In the AP GUI Port Access Connections page, right click an item in the Sidebar to open the options list.



Note: The items that appear in the options list depend on user permissions, or if you logged in remotely or from a Local Console.

Item	User Type	Description
Expand/ Collapse	Administrators Users	<ul style="list-style-type: none">• If the device's ports are nested (not displayed), the dialog box entry is Expand. Click Expand to display the nested ports.• If the device's ports are displayed, the dialog box entry is Collapse. Click Collapse to nest the ports. <p>Note: This item only appears for switches or ports that have child devices and has the same effect as clicking the + or - in the tree structure.</p>
Rename	Administrators Users	Administrators and users with port configuration permission can give each switch and port a name.
Copy	Administrators Users	This option is only available for ports. After selecting Copy, Paste the port into the Favorites page. See “Adding a Favorite” on page 49 for details.
Properties	Administrators	Administrators and users with port configuration permission can configure the properties for a switch or port. <ul style="list-style-type: none">• For switches, click to go to the Device Management page.• For ports, a dialog box opens where configuration settings for that port are made.
Mount/ Unmount	Administrators Users	Only available through a Local Console login. It appears when a USB device is plugged into the switch's USB port and allows the device to be mounted and made available to logged in users.

Port Properties. Select Properties from the popup menu to open a dialog box to enter configuration settings for the selected port.



Note: This is a quick setting method that performs similar port configuration functions to the ones performed in “Port Configuration” on page 55.

Field	Explanation
Port OS	Specifies the operating system that the server on the connected port is using. Choices are Win, Mac, Sun, and Other. The default is Win.
OS Language	Specifies the OS language being used by the server on the connected port. Select from the available choices in the drop down list. The default is English US.
Cable Length	Specifies the length of the Cat5e cable that is used to connect the server to the port. Choices are Short (less than 10 m), Medium (10-25 m), and Long (greater than 25 m). The default is Short. Note: Cable length can affect video quality. Shorter cables offer better quality. This setting is designed to compensate for longer or shorter cable lengths. Find the setting that best suits your connection.
Access Mode	Define how the port is to be accessed when multiple users have logged on. <ul style="list-style-type: none"> • Exclusive: The first user to switch to the port has exclusive control over the port. No other users can view the port. The Timeout function does not apply to ports with this setting. • Occupy: The first user to switch to the port has control over the port. However, additional users may view the port's video display. If the user who controls the port is inactive for longer than the time set in the Timeout box, port control is transferred to the first user to move the mouse or strike the keyboard. • Share: Users simultaneously share control of the port. Input from the users is placed in a queue and executed chronologically. Under these circumstances, users can take advantage of the Message Board, which allows users to communicate with each other regarding control of the keyboard and mouse or keyboard, mouse, and video.
Timeout	Set a time threshold for users on ports whose Access Mode has been set to Occupy. If there is no activity from the user occupying the port for the amount of time set here, the user is timed out and the port is released. The first user to send keyboard or mouse input after the port has been released gets to occupy the port. Enter a value from 0 to 255 seconds. The default is 3 seconds. A setting of 0 causes the port to be released the instant there is no input.

Make the configuration choices and click **Save** to close the dialog box.

Port and Outlet Naming

Administrators and users with port configuration permission, can give each port or outlet a name. To assign, modify or delete a name:

1. Click once on the item you want to edit, wait a second, then click again. After a second or two, the field opens a text input box.



Note: 1. This is not a double click. It involves two separate clicks. A double click will switch you to the device attached to the port.

2. In the AP GUI version you can right click on the port you want to edit, then select **Rename** in the popup box that appears, or you can highlight the port and press F2.

2. Enter a name for the item (or change or delete a previous name).
 - Any combination of letters, numbers, and symbols on the typewriter keys of PC US English layout can be used. The maximum number of characters allowed is 20.
 - Activate your local IME to input non-English characters. For languages that use 2 byte encoding, the maximum number of characters allowed is 9.
3. Press the [ENTER] key or click anywhere outside the input box to complete the operation.

Scan

Scan is located at the bottom of the AP GUI Sidebar and automatically switches among all the ports visible in the Sidebar at regular intervals, to monitor activity. See “Auto Scanning” on page 84 for details.



Note: Scan does not appear at the bottom of the Sidebar in the Browser version. Open it from the port's Toolbar.

Array

Array is located at the bottom of the AP GUI Sidebar and is another way of monitoring port activity. Your screen is divided into a grid of panels, with each panel showing the video display of a particular port. Only ports visible in the Sidebar and on line are displayed. All other ports are blank. See “Panel Array Mode” on page 88 for details.



Note: Array does not appear at the bottom of the Sidebar in the Browser version. Open it from the port's Toolbar.

Filter

Control the number and type of ports that display in the Sidebar, as well as which ports get scanned when Auto Scan and Array Modes are invoked. Click **Filter** to show the choices on the bottom of the panel:

Choices	Explanation
All	This is the default view. With no other filter options selected, all of the ports that are accessible to the user are listed in the Sidebar. When there are Favorites specified, select Favorites instead of All from the drop down list. In Favorites, only the items selected as Favorites display in the tree.
Powered On	If Powered On is enabled (by putting a check in the checkbox), only ports that have their attached devices powered on display in the tree.
Search	If you enter a search string and click Search, only port names that match the search string display in the tree. Wildcards (? for single characters; * for multiple characters) and keywords are supported, so that more than one port can appear in the list.
Exit	Clicking Exit closes the filter dialog.

KVM Devices and Ports - Connections Page

The Connections page displays port status information at the device level, and port connection configuration options at the port level for the KVM switches.

Device Level

When a KVM switch is selected in the Sidebar, the Connections page displays a list of ports for the device that the user is authorized to access or view.

The following attributes are listed for each device:

- Port Number - the port's number on the switch.
- Port Name - if a name has been assigned to a port, it displays here.
- Device Name - if a name has been assigned to the switch, it displays here.
- Status - the current status of the port, online or offline.



Note: Change the sort order of the information displayed by clicking the column headings.

Double click anywhere on the line entry to access a port or select the port and click **Connect** at the bottom right of the page.

Port Level

When a port is selected in the Sidebar, the Connections page displays the port connection and configuration options: The screen is divided into three panels.

Status. The current status information is displayed, including whether the port is online or offline, and if the port is mountable. Click the Connect button to view the port display from the switch's built-in Win Viewer, or Java Viewer.

Associated Links. Displays ports that have been associated with the currently selected port. Associations are configured on the Port Access > Port Configuration > Associated Links page.

Power Management. This page is used to connect a PDU power outlet with a port on the KVM switch. The power status of the device attached to the KVM port can be controlled from the Port Access page, rather than controlling the power status by opening a separate web session to the PDU device. The Power Management page is only available when a PDU device is connected to the switch.

The screenshot displays the APC KVM2132P web interface. The top navigation bar includes icons for Port Access, User Management, Device Management, Log, Maintenance, and Download. The main content area is divided into three panels:

- Status:** Shows "Port Status: Offline" and a "Connect" button.
- Associated Link:** Features a table with columns "Port Number" and "Port Name", and a "Connect" button.
- Power Management:** Contains a table with columns "Station", "Outlet", and "Status".

Station	Outlet	Status
[PDU1]Rack.PDU	01 Outlet 1	ON
[PDU1]Rack.PDU	02 Outlet 2	ON

Below the table are controls for "On", "Off", and "Reboot", along with checkboxes for "Synchronization" and "Select All".

The sidebar on the left shows a tree view of the KVM2132P switch, with ports [01] through [32] and a "Rack PDU" section containing outlets [01] through [05].

At the bottom of the interface, the text "APC by Schneider Electric" and "V1.0.070" are visible.

PDU Devices - Device Monitor Page

PDU devices connected to the switches are displayed below the KVM switches in the Sidebar. When a PDU device is selected in the Sidebar, the Device Monitor page opens.

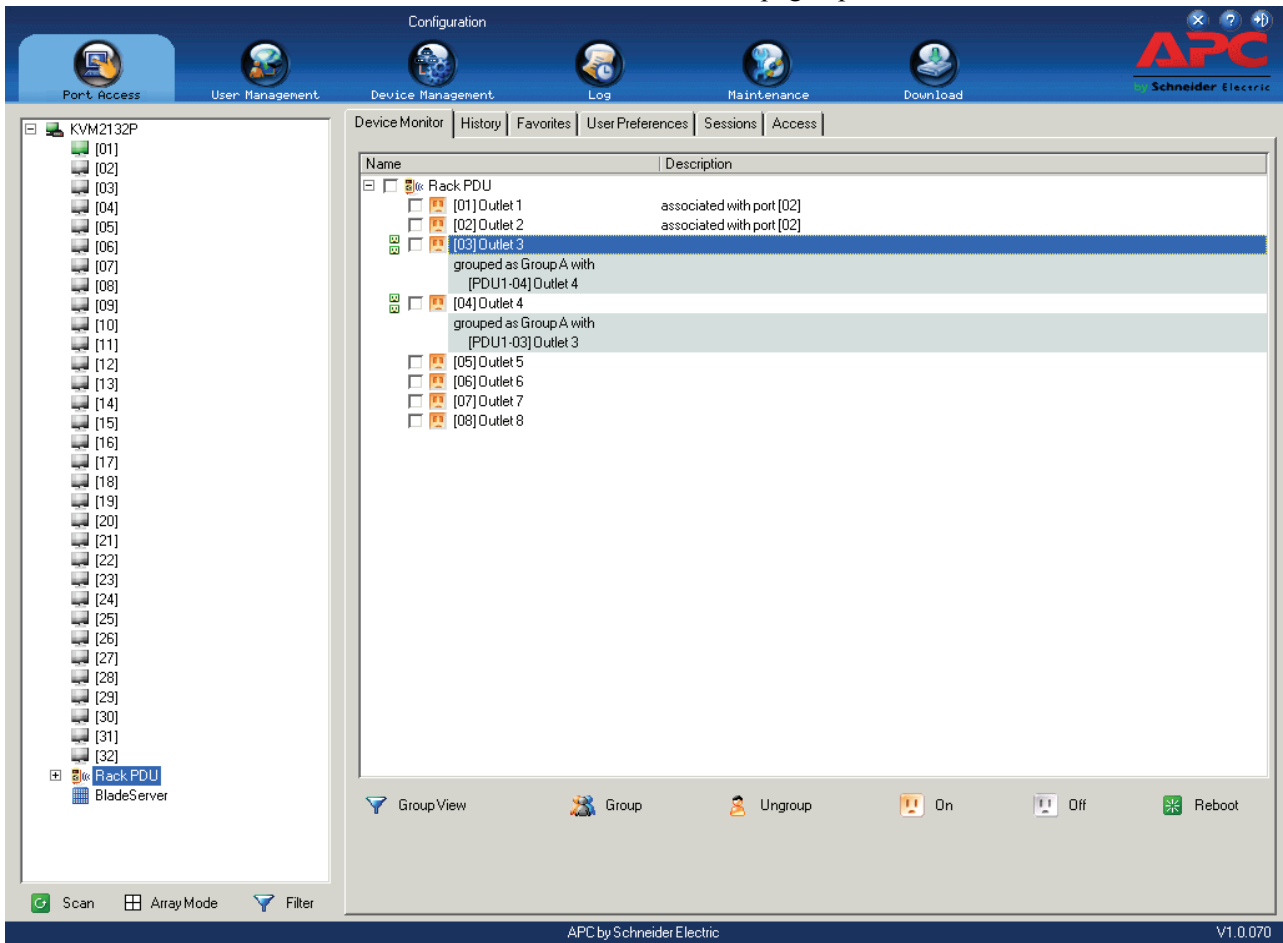

PDU View is the default page view, All PDU devices and outlets connected to the switch are listed under the Name column.

Outlets that are synchronized or that belong to groups have a green power outlet icon in front of their names. Click an outlet's green icon to display other outlets with which it synchronizes, or is grouped. Click the green outlet again to close the information display.

The Description column displays the KVM port associated with the outlet.

Action Buttons. The buttons are located at the bottom of the page.

Button	Action
Group View	Click to switch the display to Group View.
Group	Create a group of outlets.
Ungroup	Remove items from a group.
On	Sends a Power On signal to the selected outlet(s).
Off	Sends a Power Off signal to the selected outlet(s).
Reboot	Sends a Reboot signal to the selected outlet(s).

Outlet Groups. Group and Ungroup buttons are located at the bottom of the page's center section.

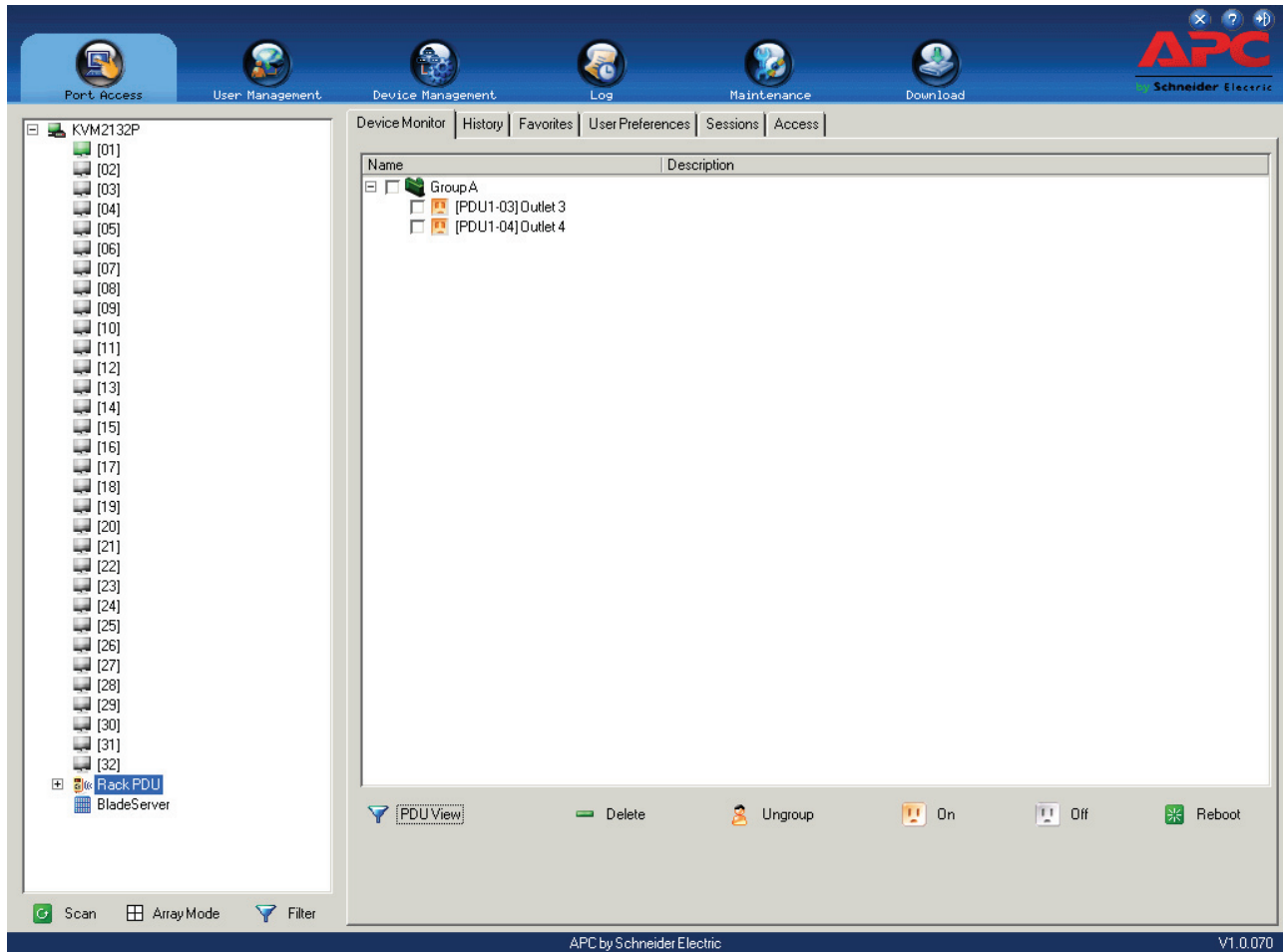

1. To create an outlet group, select the outlets to include in the group.
2. Click **Group** to open the Outlet Group dialog box.
3. Select the group.
 - a. If the outlets will belong to a new group, give it a name in the text field.
 - b. If the outlets will belong to an existing group, select the group in the central panel.
4. Click **Save**.
5. To remove outlets from groups select them in the main panel, then click **Ungroup**.

The Main Panel - Group View

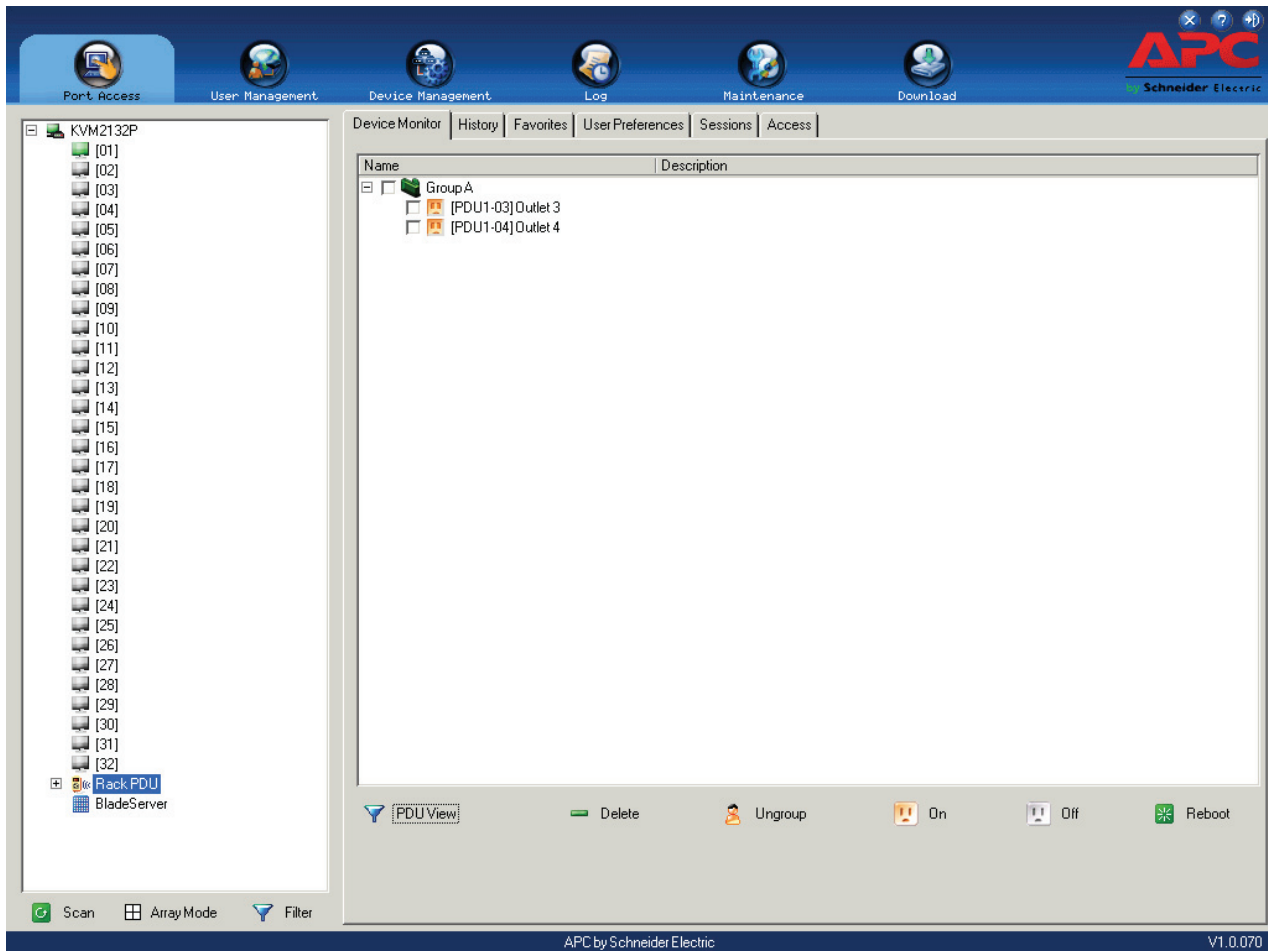

- Click the PDU View button to go to the PDU View page.
- To delete a group, select it in the main panel, then click **Delete** at the bottom of the page.
- Select a group in the main panel, then click **Ungroup**, to remove all outlets from that group. This is a shortcut to remove all outlets at once, rather than one by one from the PDU View page.
- To power manage a group of outlets, first select the group(s) in the main panel, then click the appropriate power button.

Outlet Settings

When an outlet is selected in the Port Access page Sidebar, the Outlet Settings page opens.

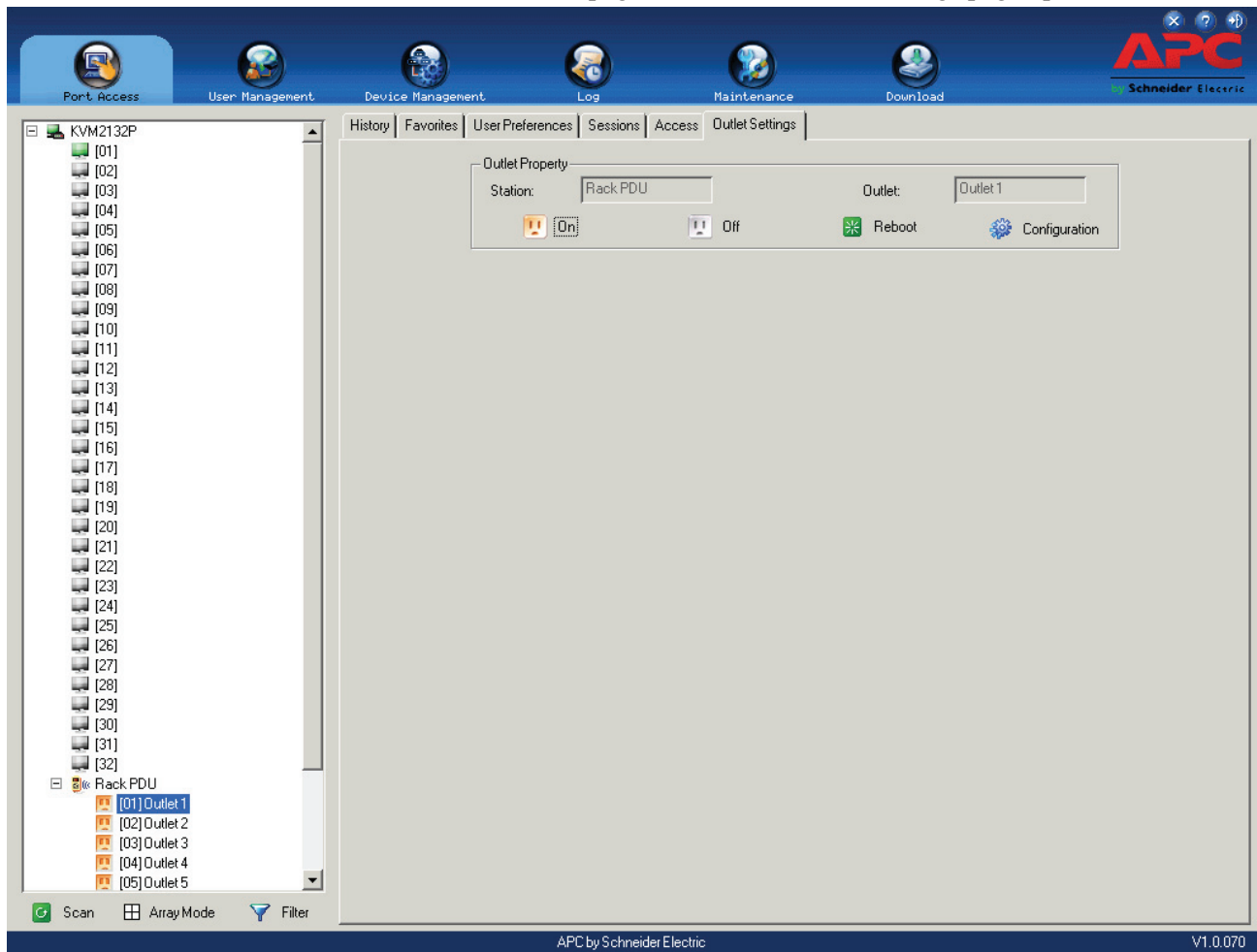

The Outlet Properties panel indicates the name of the PDU that the outlet belongs to and the outlet's name, as well as On, Off, and Reboot buttons to manually manage the outlet's power.

Adding a PDU in the KVM GUI main page

1. Go to the Device Management tab, select the PDU Devices and click **Add**.

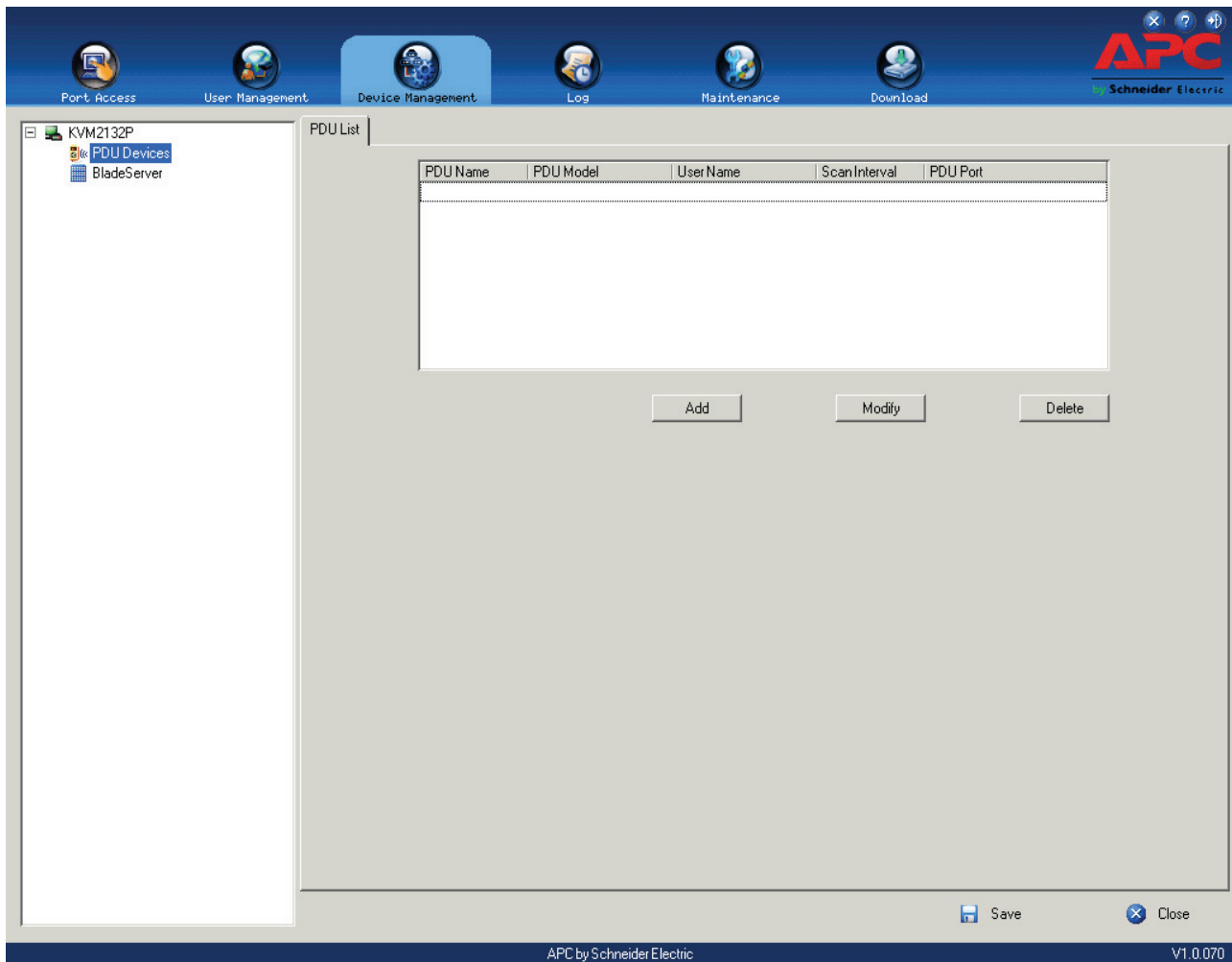

2. Select the PDU Model.
3. Assign a name to the PDU.
4. User Name - Enter the PDU administrator user name.
5. Password - Enter your password.
6. Set the Scan Interval - This is the amount of time which the KVM switch checks outlet status from the PDU (from 1 to 99 minutes). Short intervals are not recommended in order to minimize impact on Telnet/HTTP users accessing the PDU.

7. Enter the PDU Port - (1 or 2) The port on which the connection to the PDU is made.

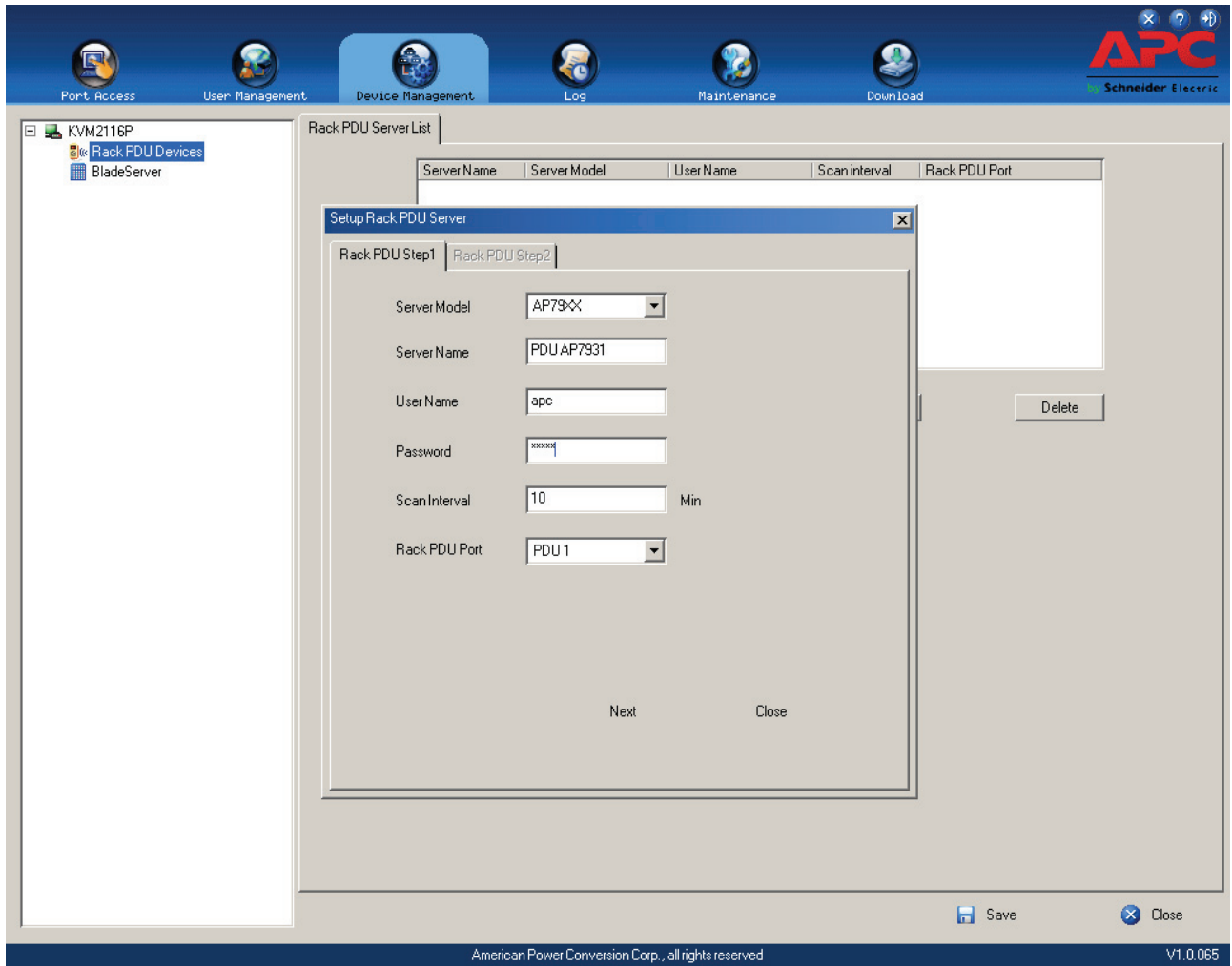

8. Click **Next** to save or close to cancel.

9. The PDU is added to the list.

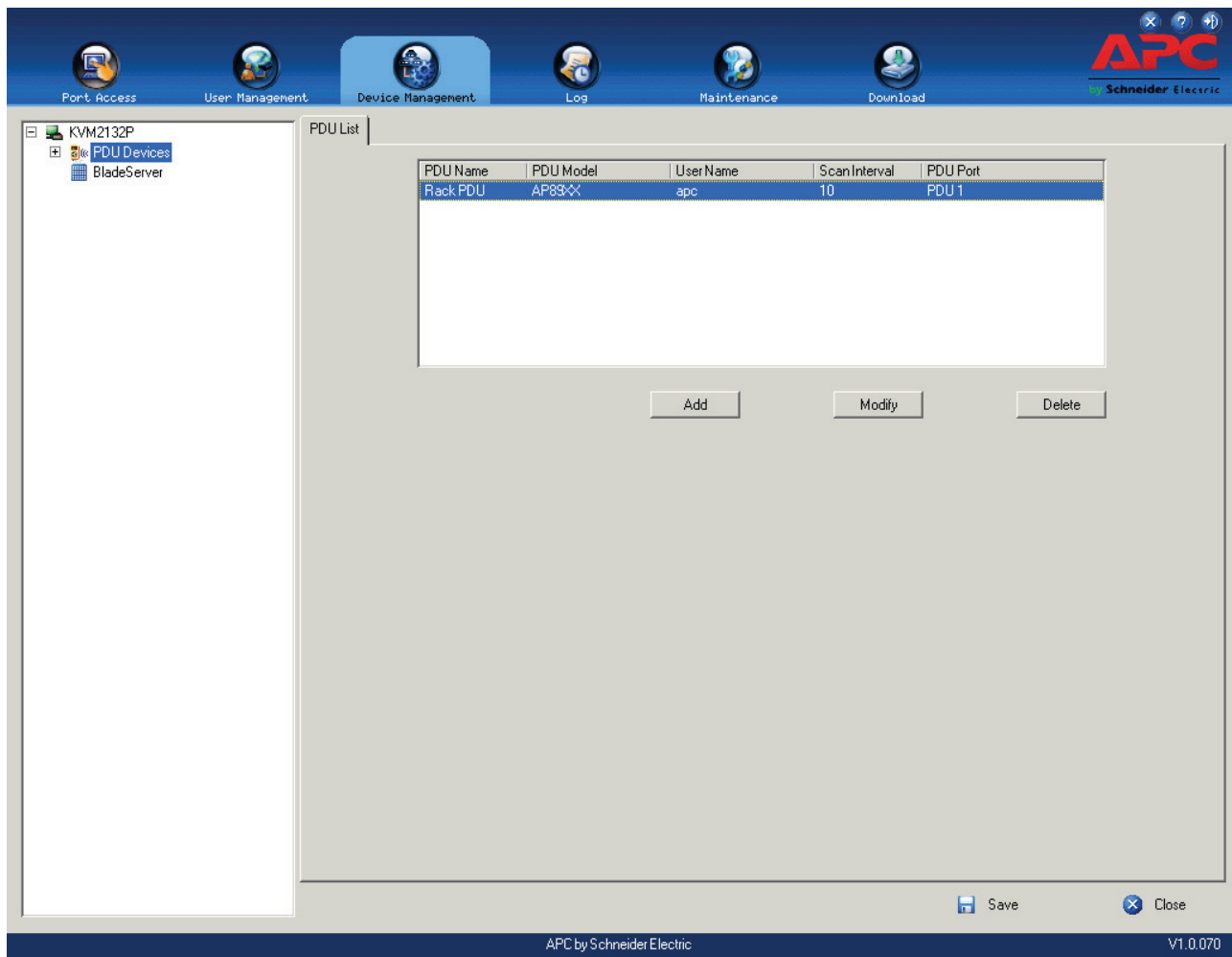

History

The History page provides a record of each time that a port was accessed. It provides quick access to the most recently used ports. You can access a port shown in the main panel by double clicking it.

- If there are more entries than room on the screen, a scroll bar opens to allow the entire record to be viewed.
- To clear the record and start over, click the **Clear History** button at the bottom right of the page.



Note: Click the column headings to change the sort order of the displayed information.

Device	Port	Time
KVM2132P	[09]	2000/02/12 13:00:35
KVM2132P	[01-06]	2000/02/26 01:35:01
KVM2132P	[04]	2000/02/26 01:44:45
KVM2132P	[24]	2000/03/03 00:07:14
KVM2132P	[01-05]	2000/02/26 02:04:28
KVM2132P	[03]	2000/03/03 11:11:31
KVM2132P	[02]	2000/03/03 11:54:49
KVM2132P	[01-01]	2011/07/19 14:55:22
KVM2132P	[18]	2011/08/09 08:22:38
KVM2132P	[17-03]	2011/07/19 15:17:36
KVM2132P	[17-01]	2011/07/19 15:17:46
KVM2132P	[16]	2011/07/21 12:33:23
KVM2132P	[32]	2011/07/21 14:03:15
KVM2132P	[20]	2011/08/08 09:33:55
KVM2132P	[01]	2011/08/15 15:39:45

Favorites

The Favorites page is similar to a bookmarks feature. Frequently accessed ports can be saved in a list. Favorites is a useful feature on large installations.

Adding a Favorite.

1. With the port selected in the Port Access sidebar.
Right click in the main panel of the Favorites page to see the **Add Favorite** box.
Click on it or click **Add** at the bottom of the main panel to open an **Untitled Favorite** entry page.
2. Enter a name. Click on any empty space in the main panel to close the box.

3. To add a port:
 - Drag it from the Sidebar and drop it onto the container,
 - or right click on it in the Sidebar, select **Copy**, right click on the container, and select **Paste**,
 - or select the container in the main panel, select the port in the Sidebar then click **Add to** at the bottom of the main panel.
4. The port's switch is added to the container. The selected port is appended under the switch.



Note: 1. To add multiple ports at the same time, hold the Shift or Ctrl key down while making your Sidebar selections then drag or copy the group to the Favorites panel.
 2. Favorites can be selected for filtering in the Sidebar. See “Filter” on page 40 for details.

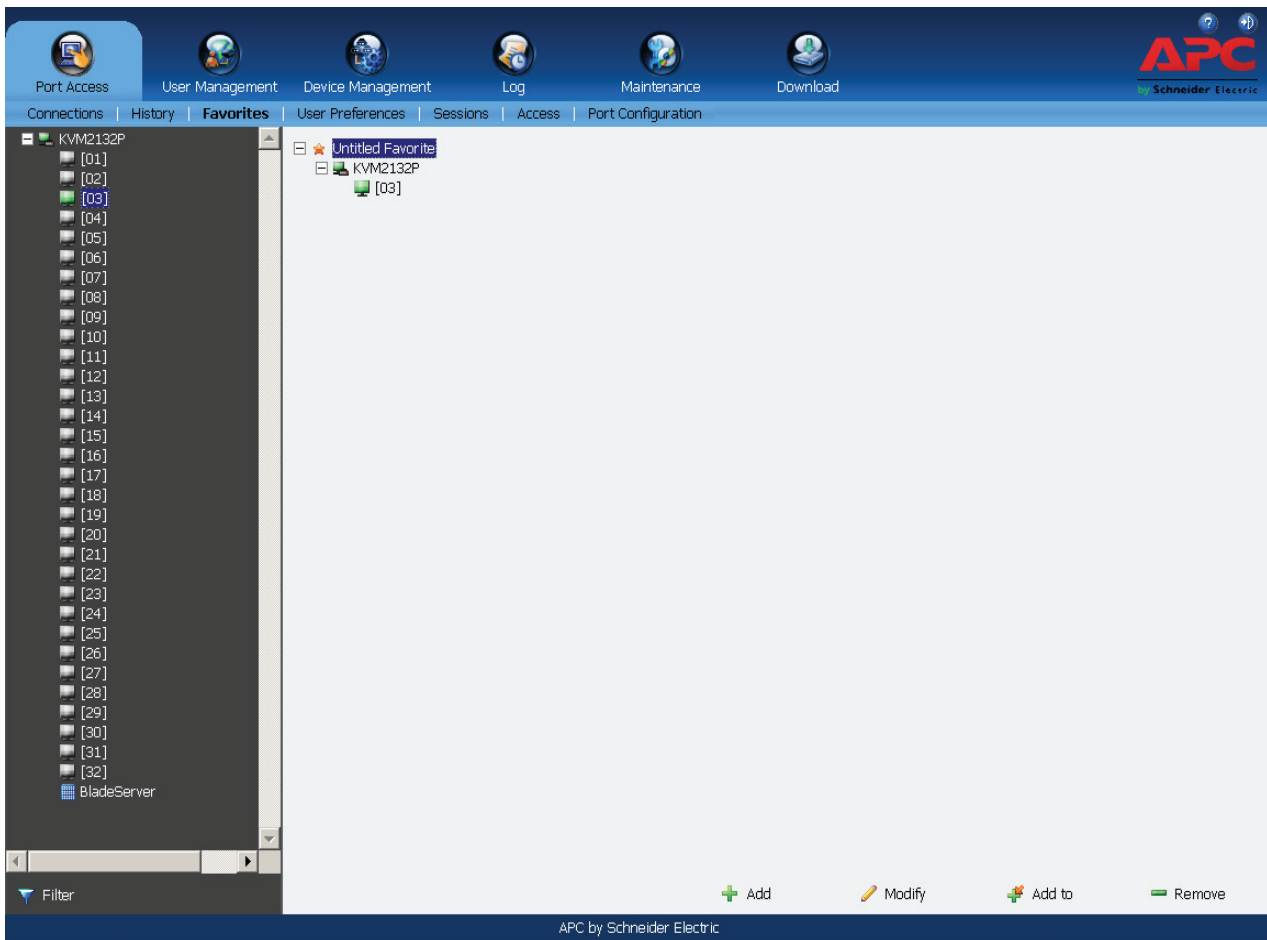

Modifying a Favorite.

- To modify a Favorite, or one of the items contained in it, right click on it, then select a choice from the popup menu.
- To edit a Favorite's name:
 - Click on it once, wait a second, then click again. Edit the name after the display opens a text input box (Port naming uses the same procedure),
 - or select the Favorite in the main panel, then click **Modify** at the bottom of the main panel.

User Preferences

Users may set up their own working environments. The switch stores a separate configuration record for each user profile according to the Username entered at Login.

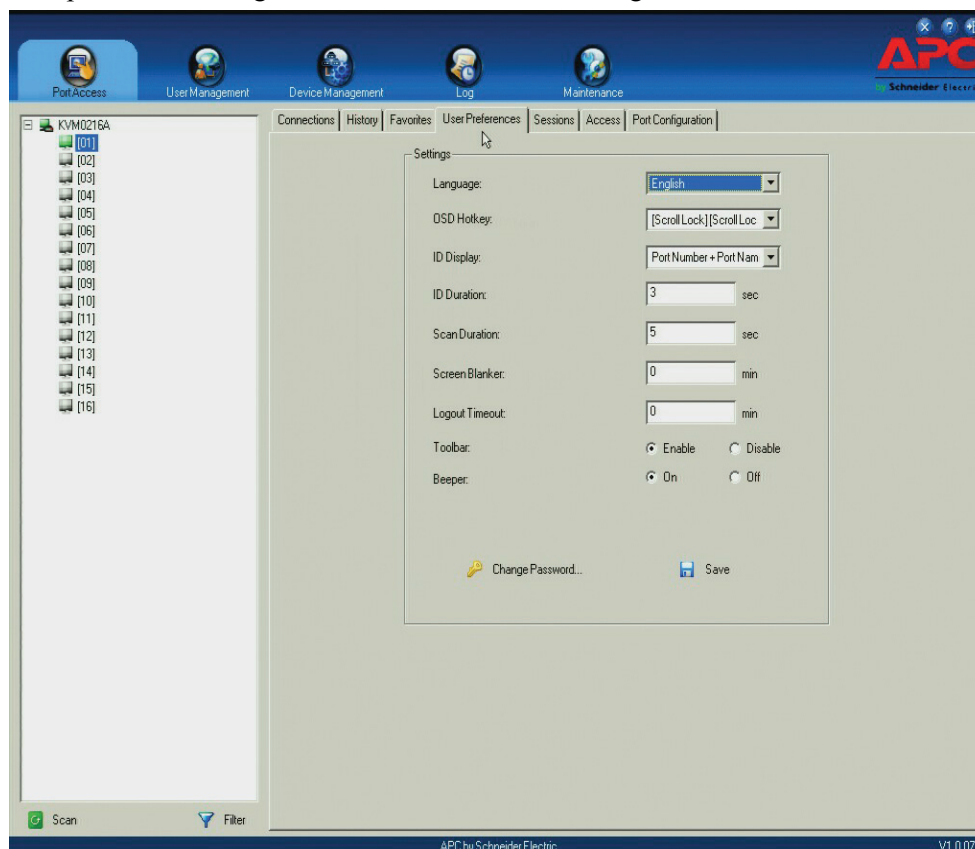

Setting	Function
Language	Select the language in which the interface displays.
OSD Hotkey	Select which Hotkey controls the GUI function: [Scroll Lock] [Scroll Lock] is the default. To select a different combination, click the arrow at the right of the box to open a list of choices.
ID Display	Select how the Port ID is displayed: the Port Number alone (PORT NUMBER), the Port Name alone (PORT NAME), or the Port Number plus the Port Name (PORT NUMBER + PORT NAME). The default is PORT NUMBER + PORT NAME.
ID Duration	Determine how long a Port ID displays on the monitor after a port change has taken place. Choose from 1-255 seconds. The default is 3 Seconds. Setting to 0 (zero) means the Port ID is always on.
Scan Duration	Determine how long the focus dwells on each port as it cycles through the selected ports in Auto Scan Mode (see “Auto Scanning” on page 84). Enter a value from 1-255 seconds. The default is 5 second. Stting to 0 disables the Scan function.
Screen Blanker	If there is no input from the console for the amount of time set here, the screen is blanked. Enter a value from 1-30 minutes. A setting of 0 disables this function. The default is 0. Note: This function can be set from the local console or remote login, but it only affects the local console monitor.
Logout Timeout	If there is no user input for the amount of time set with this function, the user is automatically logged out. Login is necessary before the KVM switch can be accessed again.
Toolbar	Select whether or not the Port Toolbar is enabled when a port is accessed. Since the Toolbar functions are also available from the GUI Control Panel (see “The Control Panel” on page 24), you may prefer to disable it here.
Viewer*	Choose which viewer is used when accessing a server: <ul style="list-style-type: none"> • Auto Detect will select the viewer based on the web browser used; WinClient for Windows Internet Explorer or Java Client for other web browsers (Firefox). • Java Client opens the Java based viewer regardless of the web browser used.

Welcome Message*	Hide or show the welcome message displayed in the submenu bar. The default is Disabled.
Save	Click Save to save any changes made to the User Preferences settings.
Changing a Password	In the Browser GUI, enter the old password and new password into the input boxes. Enter the new password into the Confirm input box, then click Change Password to apply. In the AP GUI version, click Change Password . Enter the old password and new password into the input boxes. Enter the new password into the Confirm input box, then click Save .
* This item is only available with the Browser version.	

Sessions

The administrator and users with User Management permissions can see which users are currently logged into the KVM switch, and their session information.



Note: 1. Only users with User Management permissions can see sessions of ordinary users.
2. User type, SA (Super Administrator), Admin (Administrator), or Normal user (User), is listed under Category.

The IP heading refers to the IP address from which the user has logged in.

The Device and Port headings show which device and port the user is currently accessing.

The Bus ID refers to the bus that the user is currently on (Bus 0 refers to the Local Console's bus).



Note: 1. Change the sort order of information displayed by clicking the column headings.
2. The Bus ID also displays on the control panel. See “Users and Buses” on page 89 for more information.

The administrator can force a user logout from this page by selecting the user and clicking **End Session** at the bottom of the main panel.

Username	IP	Login Time	Client	Category	Devices	Ports	Bus ID
apc		2011/08/29 12:16:48	Local	SA	KVM2132P	None	0
apc	10.218.184.102	2011/08/29 12:24:47	Browser	SA	None		
KVMUser	10.218.184.102	2011/08/29 12:46:04	Browser	Normal User	None		
ServerUser	10.218.184.102	2011/08/29 12:47:01	Browser	Normal User	None		

Access

Set user and group access and configuration rights for switches and ports. Only those with User Management permissions can view the Access page. Normal users do not have access.

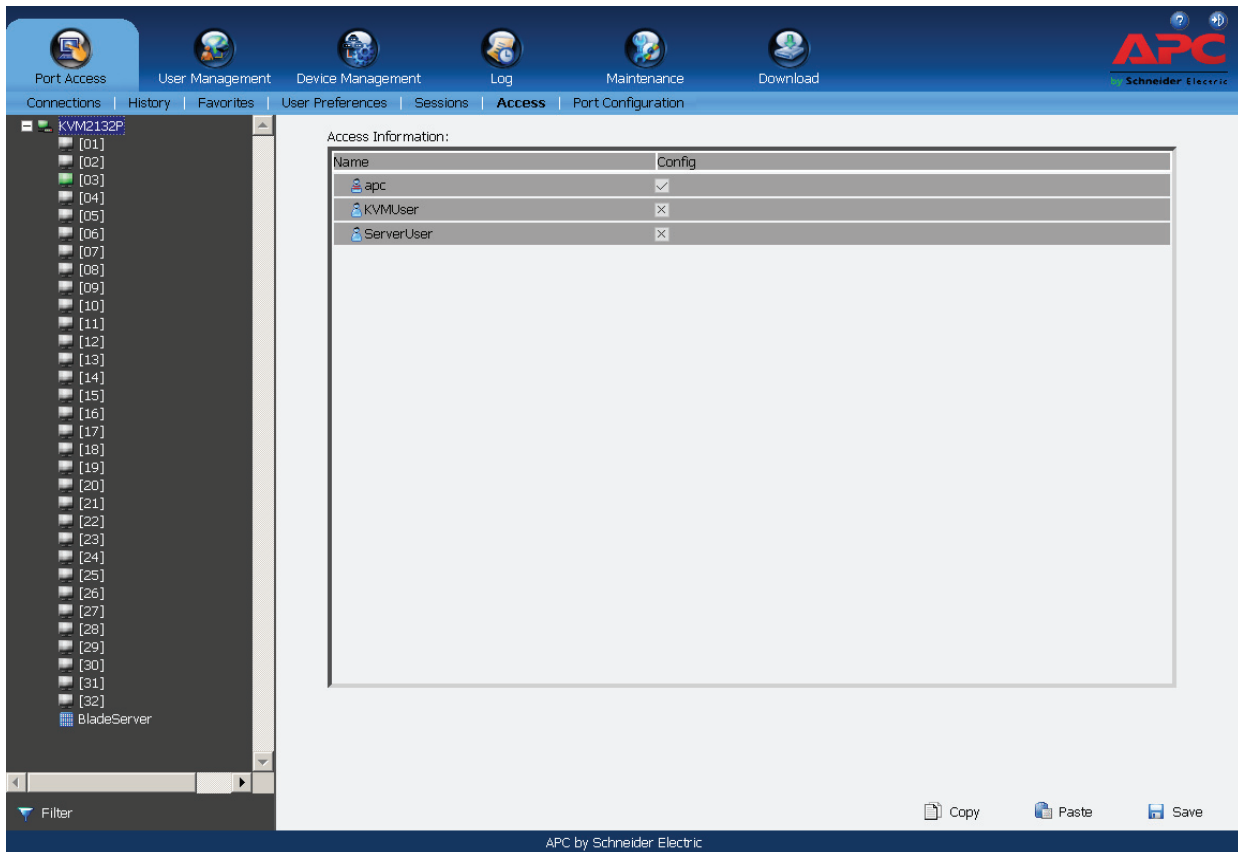

Device Level Browser GUI Interface

The main panel consists of two columns: Name, and Config:

- Name lists all the users and groups that have been created.
- Config indicates the users who have Configuration privileges. A check mark indicates that the user has permission to make changes to the switch configuration settings. An X means that the user is denied permission to make configuration changes. Click the icon to toggle permission for Administrators and Users. Super Administrators always have configuration privileges.
- The Copy and Paste buttons at the bottom of the main panel provide a shortcut method of assigning the permissions settings of one port to any of the other ports.
 - Select the port whose permissions you want to give to other port(s).
 - Click **Copy**.
 - Select the port that will receive the permissions.
 - Click **Paste**.
- Click the **Save** button to save the changes.

Port Level Browser GUI Interface

Port access settings:

Setting	Function	
Name	Each port accessible to the user is listed under the Names column.	
Access	Device access rights are set from the Access column. To see the choices, click the icon in the row that corresponds to the user you want to configure.	
	Full Access	The user can view the remote screen and can perform operations on the remote server from his keyboard and monitor.
	View Only	The user can only view the remote screen. He cannot perform any operations on it.
	No Access	No access rights - the Port will not appear on the User's list on the Main Screen.
Mount USB	Configure permissions to mount Virtual Media devices on remote servers. To see the choices, click the icon in the row that corresponds to the user you want to configure. The icons are the same as in the Access column. <ul style="list-style-type: none"> • Full Access: the user can mount, read, and write to the virtual media. • View Only: the user can view the contents of the virtual media. No operations can be performed. • No Access: the user will not see the virtual media even if it has been configured on the remote system. Note: The entry does not appear for switches that do not support the USB Virtual Media function.	
Config	Set or deny permission for the user to change a port's configuration settings. A check mark indicates that the user has permission. An X means the user does not have permission.	
PDU	Permit or restrict the configuration and power operation of ports that have PDU devices connected. A check mark shows that the user has permission. An X means the user does not have permission.	

Device Level AP GUI Interface

The page is the same as for the Browser GUI except that there are filters at the top of the columns to expand or limit the scope of the users and groups.

Filter	Description	
Name	To filter the User or Group name, enter the name, partial name, or partial name and wild card, then press Enter . Only the Users and Groups whose names correspond to the entry appear in the list. Wildcards (? for single characters, * for multiple characters) and the keyword "or" are supported. See page 59 for an example.	
Config	All	All Users and Groups appear in the list.
	Permitted	Only Users and Groups with configuration permissions appear in the list.
	Restricted	Only Users and Groups that do not have configuration permissions appear in the list.

Port Level AP GUI Interface

The page is the same as for the Browser GUI except that there are filters at the top of the columns to expand or limit the scope of the users and groups displayed.

Setting	Function	
Name	To filter the User or Group name, enter the name, partial name, or partial name and wild card (*) then press Enter. Only the Users and Groups whose names correspond to the entry appear in the list.	
Access	All	All Users and Groups appear in the list.
	Full Access	Only Users and Groups with Full Access permissions appear in the list.
	View Only	Only Users and Groups with View Only permissions appear in the list.
	No Access	Only Users and Groups with No Access permissions appear in the list.

Mount USB	All	All Users and Groups appear in the list.
	Full Access	Only Users and Groups with Full Access Mount USB permissions appear in the list.
	Read Only	Only Users and Groups with Read Only Mount USB permissions appear in the list.
	No Access	Only Users and Groups with No Access Mount USB permissions appear in the list.
Config	All	All Users and Groups appear in the list.
	Permitted	Only Users and Groups with Permitted Config permissions appear in the list.
	Restricted	Only Users and Groups with Restricted Config permissions appear in the list.
PDU	All	All Users and Groups appear in the list.
	Permitted	Only Users and Groups with Permitted PDU permissions appear in the list.
	Restricted	Only Users and Groups with Restricted PDU permissions appear in the list.

Saving Changes. Click the **Save** button at the lower right corner of the page to save any changes made on the Access page.

Port Configuration

Device Level

When a device is selected in the Sidebar, the only item available under Port Configuration is the Port Properties page with one field to configure: the Occupy Timeout setting.

The Occupy Timeout field sets a time threshold for users on ports whose Access Mode has been set to Occupy. If there is no activity from the user occupying the port for the amount of time set here, the user is timed out and the port is released. The first user to send keyboard or mouse input after the port has been released gets to occupy the port.

Input a value from 0 to 255 seconds. The default is 3 seconds. Setting to 0 causes the port to be released the instant there is no input (not recommended).

Port Level

Port Properties

When a port is selected in the Sidebar, the Port Properties page displays information related to the ports.

- Status panel: See if the port is online or offline, the Adapter cable type, and the Adapter's firmware level.
- Properties panel: Make configuration settings for a selected port.
- Exit Macro panel: contains a list of user created System macros. Select a macro from the list that will execute when exiting the remote server.

Click the **Save** button to save changes.

Associated Links

Associate other ports on the same switch to the selected port. This function is used when connecting both KVM and serial ports (using Server Module KVM-SERIAL) from a single server to the switch.

- To associate a port with the currently selected port, click **Add**. Enter the port's number in the dialog box, then click **OK**. The port's number and name now appear in the main panel.
- To remove an unwanted associated port, select it in the main panel, then click **Remove**.

Power Management

The Power Management page is used to associate a Rack PDU power outlet with a KVM port on the KVM switch. Once an association is made, the power status of the device attached to the KVM port can be controlled from the Port Access page, rather than opening a separate web session to the PDU device.

Station	Outlet	Status
[PDU1]Rack PDU	01 Outlet 1	ON
[PDU1]Rack PDU	02 Outlet 2	ON



Note: This page is only available when a PDU device is connected to the switch.

Adding and Removing Associations

The PDU Mapping dialog box opens with a list of all the outlets available for association.

- Check the outlet or outlets you want to associate with the port.
- Click **OK**.
- To disassociate an outlet from a port, select it in the main panel and click **Remove**.

Configuration

Configure an outlet's settings directly from this page by clicking the **Configuration** button to open the PDU Outlet Configuration dialog box.

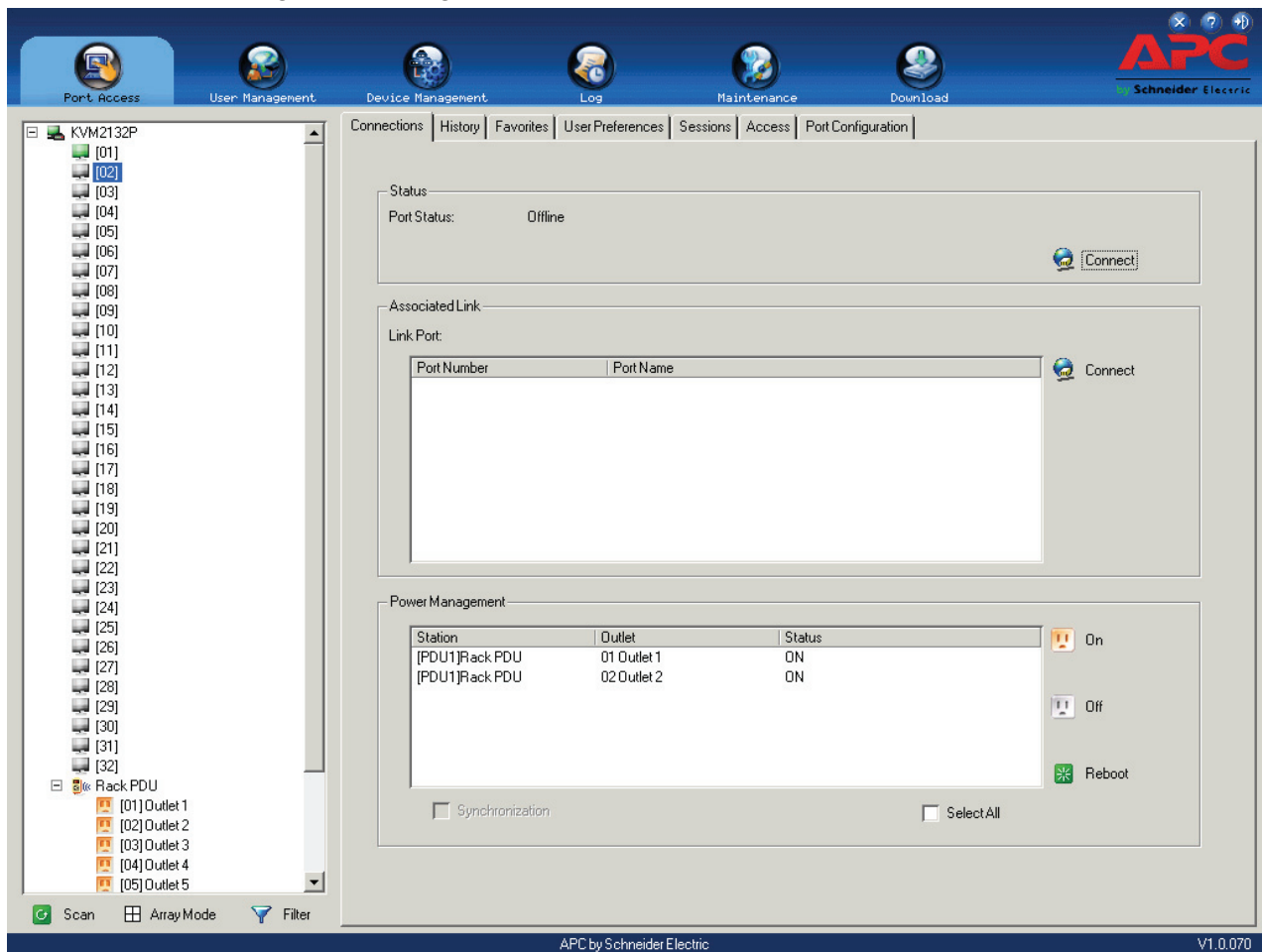

Configuration options.

Heading	Explanation
Station	The name of the device to which the outlet belongs.
Port	The outlet's current name.
Name	Enter a name for the outlet. The maximum number of characters is 15.
Power On Delay	Set the amount of time the PDU waits after the Power Button is clicked before turning on the computer attached to the corresponding outlet. The default delay time is 0 seconds. The maximum is 7200 seconds.
Power Off Delay	<ul style="list-style-type: none"> Set the amount of time the PDU device waits after the Power button is clicked before shutting down the computer attached to the corresponding outlet. The default delay time is 0 seconds. The maximum delay time is 7200 seconds.
Power Reboot Delay	<ul style="list-style-type: none"> Set the amount of time the PDU waits after the computer is shutdown before turning on the computer attached to the corresponding outlet. The default delay time is 5 seconds. The maximum delay time is 60 seconds.

Synchronization

If more than one outlet has been selected for association with a port, Synchronization can be used to standardize their configurations. Enabling Synchronization (by checking the checkbox), opens the PDU Outlet Configuration dialog box. See “Configuration” on page 57. The settings are applied to all outlets associated with the port so that their settings are all the same.

To perform power management on PDU outlets associated with a KVM port, select the outlet then click **On/Off/Reboot**.

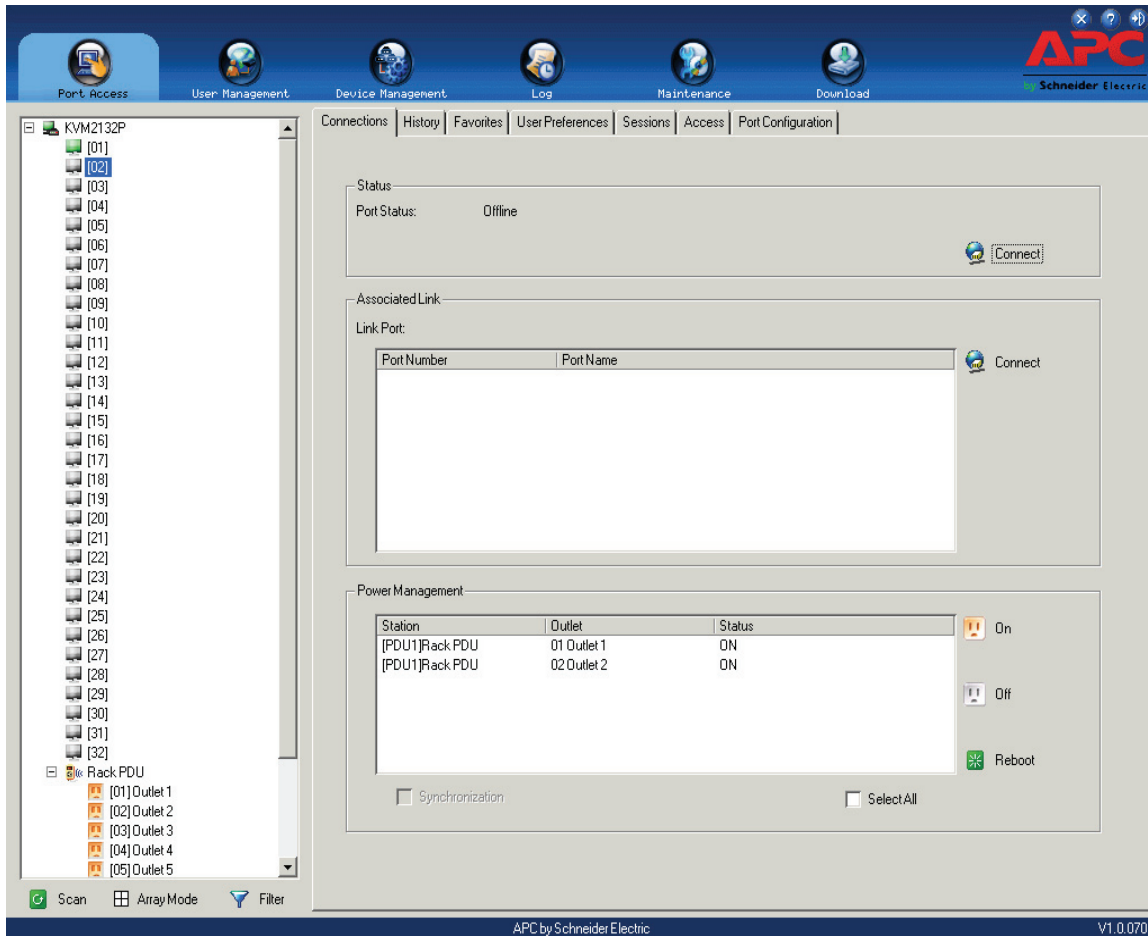

User Management

Overview

Click the User Management tab to open the User Management page. The page is organized into two main areas, the Sidebar at the left, and the large main panel at the right.

- Users and groups appear in the panel at the left of the page. The large panel at the right provides more detailed information for each.
 - The Browser GUI has separate menu bar entries for Accounts (Users) and Groups. Depending on the menu item selected, either Users or Groups are listed in the Sidebar.
 - The AP GUI does not have menu entries. Users and Groups are listed separately in the Sidebar.
- In the Browser GUI, change the sort order of the information displayed by clicking the main panel column headings.
- In the AP GUI, the section below the Sidebar list provides a filter for managing the list.
 - Click the arrow at the right of the list box to select to view only Users, only Groups, or both Users and Groups.
 - Click to put a check in the Active checkbox to filter out any users whose accounts are not active.
 - To select only Users or Groups that match a particular string, enter the string into the text box in front of the Go button, then click **Go**. Only Users or Groups that match the string will appear in the list.

Wildcards (? for single characters; * for multiple characters) and the keyword “**or**” are supported.

Example: h*ds would return hands and hoods;
h?nd would return hand and hind, but not hard;
h*ds or h*ks would return hands and hooks.

- The buttons below the main panel are used to manage users and groups.

Users

The KVM switch supports three types of user.

User Type	Role
Super Administrator	Access and manage ports and devices. Manage Users, and Groups. Configure the overall installation. Configure personal working environment.
Administrator	Access and manage authorized ports and devices. Manage Users and Groups. Configure personal working environment.
User	Access authorized ports and devices. Manage authorized ports and devices, configure personal working environment. Note: Users who have permission, may also manage other users.

Adding Users

1. Select Users on the menu bar (Browser GUI) or Select Users in the Sidebar (AP GUI).
2. Click **Add** at the bottom of the main panel. The User notebook opens, with the User tab selected:
3. Enter the required information in the fields.

Field	Description
Username	From 1 to 16 characters are allowed depending on the Account Policy settings. See “Account Policy” on page 76.
Password	From 0 to 16 characters are allowed depending on the Account Policy settings. See “Account Policy” on page 76.
Confirm Password	Enter the password again to confirm it is correct. The two entries must match.
Description	Additional information about the user that you may wish to include.
Role	<p>Three categories: Super Administrator, Administrator and User. No limit on the number of accounts created in each category.</p> <ul style="list-style-type: none"> • The Super Administrator is responsible for the overall installation configuration and maintenance; user management; and device and port assignments. The Super Administrator's permissions are system assigned and cannot be altered. • The default permissions for Administrators include everything except Force to Grayscale, but the permissions can be altered for each Administrator by checking or unchecking any of the permissions checkboxes. • The default permissions for Users include the Win, Java, and SSH clients. Permissions can be altered for each User by checking or unchecking any of the permissions checkboxes. <p>Note: Users who have User Management privileges cannot access or configure Groups.</p>
Permissions Note: For ordinary users, in addition to enabling Device Management, Port Configuration, and Maintenance permissions, the user must also be given those rights for each device and port that he will be allowed to manage. See “Device Assignment” on page 64 for details.	<ul style="list-style-type: none"> • Enabling Device Management allows a user to configure and control the settings for overall KVM switch operations (see “Device Management” on page 67). • Enabling Port Configuration allows a user to configure and control the settings for individual ports (see “Port Configuration” on page 55). • Enabling User Management allows a user to create, modify, and delete user and group accounts. • Enabling Maintenance allows a user to perform all the Maintenance operations available under the Maintenance tab (see “Maintenance” on page 92). • Enabling System Log allows a user to access the system log (see “Log” on page 90). • Enabling View Only limits users to only viewing the display of connected devices. • Enabling Windows Client allows a user to download the Windows Client AP software, and access the KVM switch with it, in addition to (or instead of) the browser access method. • Enabling Java Client allows a user to download the Java Client AP software, and access the KVM switch with it, in addition to (or instead of) the browser access method. • Enabling SSH Client allows a user to access the switch from an SSH session. • Enabling Telnet Client allows a user to access the switch from a Telnet session. • Force to Grayscale forces the user's remote display view to be in grayscale. This can speed up I/O transfer in low bandwidth situations.

Status	Control the user's account and access to the installation: <ul style="list-style-type: none"> • Disable Account: suspend a user's account without deleting it. • Select Account never expires if the account lifetime is unlimited. Select Account expires on and enter the expiration date to limit the account lifetime. • Select User must change password at next logon. The administrator can set a temporary first time log in password, and the user can set his password for future logins. • Select User cannot change password to make a password unchangeable. • Select Password never expires and users can keep their passwords indefinitely. Select Password expires after and enter the number of days until the password expires to force a new password to be set.
--------	--

4. Assign a new user to a group by selecting the Groups tab. The user's port access rights can be assigned in the Devices page (page 64).



Note: This step can be skipped now to add more users and create groups.

5. When the selections have been made click **Save**.
6. When the **Operation Succeeded** message appears, click **OK**.
7. Click **Users** in the Sidebar to return to the main screen. The new user appears in the Sidebar list and in the main panel.

The Sidebar Users list can expand and collapse. Click the minus symbol (-) next to the Users icon to collapse it. Click the plus symbol (+) to expand it.

The icon for super administrators has two black bands. The icon for administrators has one red band.

The large main panel shows the user's name, the description and if the account is currently active or has been disabled.

Modifying User Accounts

1. In the Sidebar User list, click the user's name, or in the main panel, select the user's name
2. Click **Modify** to open the dialog box.
3. Make your changes, then click **Save**.

Deleting User Accounts

1. In the main panel, select the user's name.
2. Click **Delete**.
3. Click **OK**.

Groups

Device access rights apply to any member of the group. Administrators set them once for the group instead of each user individually. Multiple groups allow some users access to specific devices while restricting other users.

Creating Groups

1. Select **Groups** on the menu bar (Browser GUI) or **Select Groups** in the Sidebar (AP GUI).
2. Click **Add** at the bottom of the main panel to open the Group notebook with the Group tab selected.
3. Enter the required information in the fields.

Field	Description
Group Name	A maximum of 16 characters is allowed.
Description	Additional information about the user. A maximum of 63 characters is allowed.
Permissions	Check the boxes to set permissions and restrictions for groups. These are the same permissions as the ones specified for Users. See page 60 for details.

4. Users can be assigned to the group by selecting the **Members** tab. The **Members** page is discussed on page 64. You can also assign the group's port access rights by selecting the **Devices** tab (page 65).



Note: Skip this step and come back later to add more groups and assign users now.

5. Click **Save** when finished.
6. When the **Operation Succeeded** message opens, click **OK**.
7. Click **Group** in the Sidebar to return to the main screen. The new group appears in the Sidebar Group list and in the main panel.
 - The Sidebar Group list can expand and collapse.
 - The large main panel shows the group's name and description (the Status column is inactive).



Note: Perform Step 7 before attempting to add another group, or the new group will replace the group you just created.

Modifying Groups

1. In the Sidebar Group list, click the group's name or in the main panel, select the group's name.
2. Click **Modify**.
3. Make changes in the Group notebook, then click **Save**.

Deleting Groups

1. In the Sidebar, click the **Groups** icon.
2. In the main panel, select the group's name.
3. Click **Delete**.
4. Click **OK**.

Users and Groups

Manage users and groups from the Users notebook and from the Group notebook.

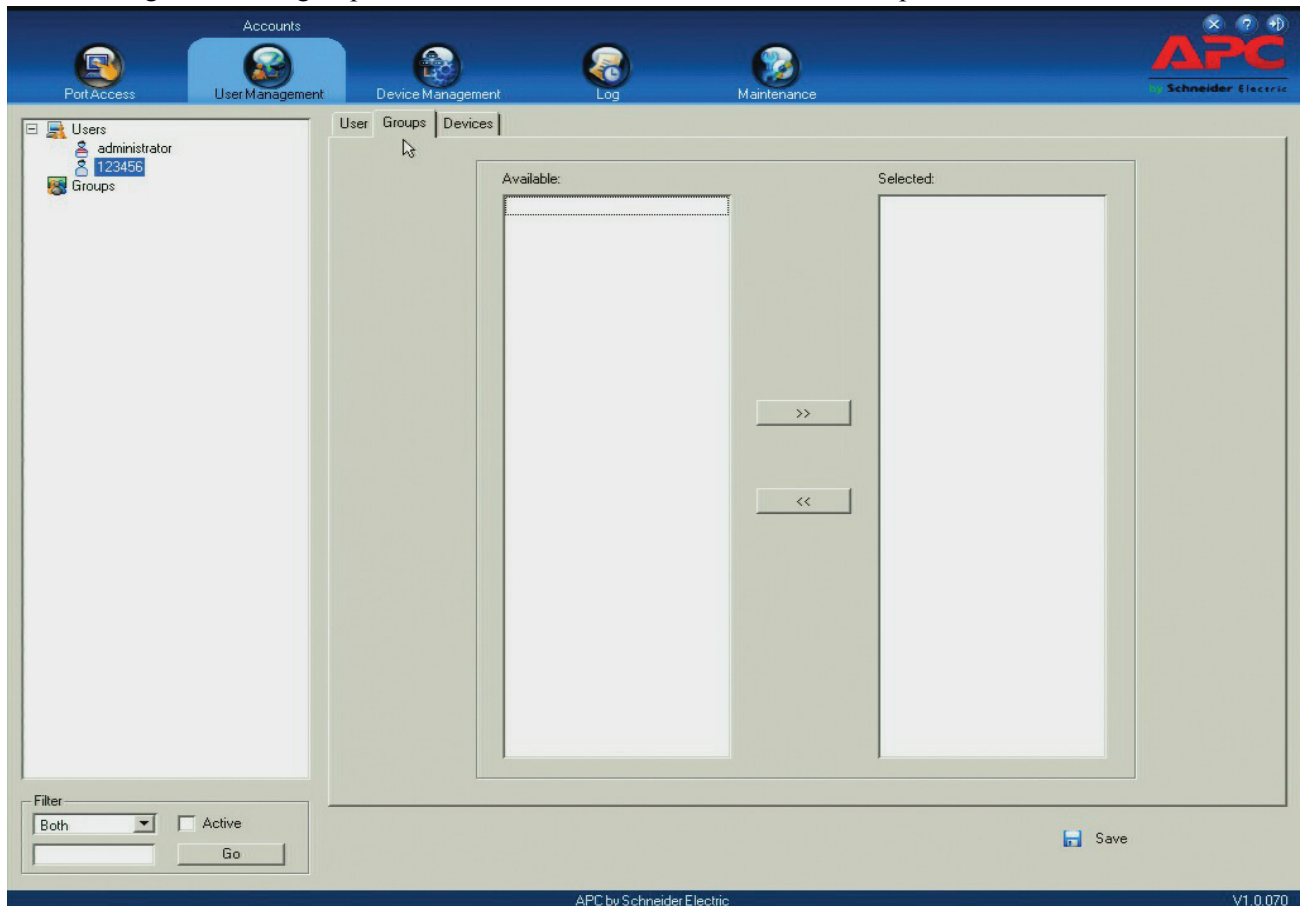

Note: Before you can assign users to groups, you must first create them. See “Adding Users” on page 60 for details.

Assigning Users to a Group From the User's Notebook

1. In the Sidebar User list, click the user's name or in the main panel, select the user's name
2. Click **Modify**.
3. Select the Groups tab in the User notebook.
4. In the Available column, select the group.
5. Click the **Right Arrow** to put the group's name into the Selected column.
6. Repeat the above for any other groups that the user will join.
7. Click **Save** to finish.



Note: If a user has permissions in addition to the ones assigned to the group, the user keeps those permissions in addition to the group ones.

Removing Users From a Group in the User's Notebook

1. In the Sidebar User list, click the user's name or select the user's name in the main panel.
2. Click **Modify**.
3. Select the Groups tab when the User notebook opens.
4. In the Selected column, select the group from which the user will be removed.
5. Click the **Left Arrow** to remove the group's name from the Selected column. (The group goes back into the Available column.)
6. Repeat the above for any other groups from which the user will be removed.
7. Click **Save** to finish.

Assigning Users to a Group From the Group's Notebook

1. In the Sidebar Group list, click the group's name or select the group's name in the main panel.
2. Click **Modify**.
3. In the Group notebook that comes up, select the **Members** tab.
4. In the Available column, select the user that will be added to the group.
5. Click the **Right Arrow** to put the user's name in the Selected column.
6. Repeat for any other users that will be added to the group.
7. Click **Save** when you are done.



Note: If a user has additional permissions to those assigned to the group, the user keeps those permissions in addition to the group permissions.

Removing Users From a Group From the Group's Notebook

1. In the Sidebar Group list, click the group's name or select the group's name in the main panel.
2. Click **Modify**.
3. In the Group notebook that opens, select the Members tab to open the screen.
4. In the Selected column, select the user that to be removed from the group.
5. Click the **Left Arrow** to remove the user's name from the Selected column. (It goes back into the Available column.)
6. Repeat for any other users to be removed from the group.
7. Click **Save** when finished.

Device Assignment



When a user logs in to the KVM switch, the Port Access page opens. All ports that the user is permitted to access are listed in the Sidebar at the left of the page. Access permissions for those ports and the devices connected to them are assigned on a port-by-port basis from the User or Group list on the Sidebar of the User Management page.

Assigning Device Permissions From the User's Notebook

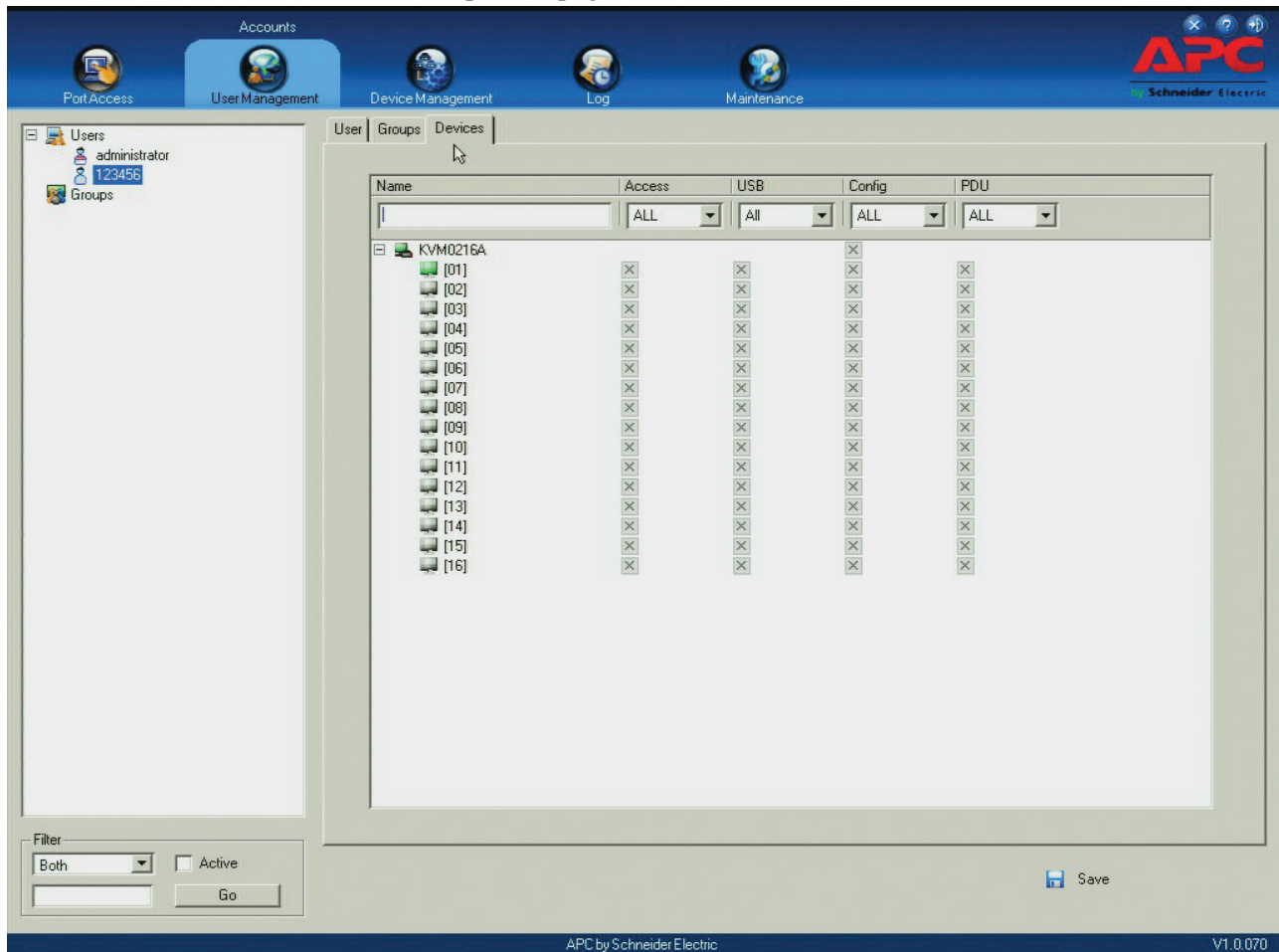
1. In the Sidebar User list, click the user's name or select the user's name in the main panel.
2. Click **Modify** to open the User notebook.
3. Select the **Devices** tab to open the page.



4. Make your permission settings for each port from the columns on the page.
 - **Name:** Each port accessible to the user is listed under the Names column.
 - **Access:** Set device access. Click the icon in the row of the port to be configured to view the choices.

Icon	Name	Description
	Full Access	The user can view the remote screen and can perform operations on the remote server from his keyboard and monitor.
	View Only	The user can only view the remote screen; he cannot perform any operations on it.
	No Access	No access rights - the Port will not show up on the User's list on the Main Screen.

- **USB:** Lists USB Virtual Media devices. (Does not appear for switches that do not support the USB Virtual Media function.) Click the icon in the row for the port you want to configure to view the choices.
 - Full Access means that the User can mount, read, and write the virtual media.
 - View Only means that the user can only read already mounted virtual media data.
- **Config:** Permit or restrict a user's permission to make changes to a port's configuration settings. Click the icon in the row for the port you want to configure to view the choices.
 - A check mark indicates that the user has permission to make changes to the port's configuration settings.
 - An X means that the user is denied permission to make configuration changes.
- **PDU:** Permit or restrict the configuration and power operation of ports that have PDU devices connected to them.
 - A check mark indicates that the user has permission.
 - An X means that the user does not have permission.

5. Click **Save** when finished. Click **OK** to confirm.



Note: Use Shift-Click or Ctrl-Click from any column to select a group of ports to configure. Clicking to see the choices on any one of the selected ports causes all of them to cycle in unison.

Filters. Expand or limit the scope of the ports that are displayed in the Name column using the five filters at the top of the columns.

Filter		Description
Name		To filter the port name, enter the name then press [ENTER]. Only ports whose names correspond to the entry appear in the list. Wildcards (? for single characters; * for multiple characters) and the keyword “ or ” are supported. See page 59 for an example.
Access	All	All ports appear in the list.
	Full Access	Only ports configured as Full Access ports appear in the list.
	View Only	Only ports configured as View Only ports appear in the list.
	No Access	Only ports configured as No Access ports appear in the list.
USB	All	All ports appear in the list.
	Full Access	Only ports configured as Full Access USB ports appear in the list.
	Read Only	Only ports configured as Read Only USB ports appear in the list.
	No Access	Only ports configured as No Access USB ports appear in the list.
Config	All	All ports appear in the list.
	Permitted	Only ports configured as Permitted appear in the list.
	Restricted	Only ports configured as Restricted appear in the list.
PDU	All	All ports appear in the list.
	Permitted	Only ports configured as Permitted appear in the list.
	Restricted	Only ports configured as Restricted appear in the list.

Assigning Device Permissions From the Groups' Notebook

1. In the Sidebar Groups list, click the group's name or select the group's name in the main panel.
2. Click **Modify** to open the Groups notebook.
3. Select the **Devices** tab to open a screen that looks the same as the one in the User's notebook. The settings here apply to all group members instead of just one user. Make device assignments according to the information described under “Assigning Device Permissions From the User's Notebook” on page 65.

Device Management

Device Information

The Device Management page opens with the top level (parent) KVM switch selected in the Sidebar and **Device Information** selected on the menu bar.

General

The General section of the Device Information page displays the name of the selected device, its firmware version, and information about its network configuration.



Note: The AP GUI version presents the same information as the Browser version. Scroll through the list to see additional entries.

Environment

The lower panel displays the device's environment information.

Item	Description
Power Supply Detection	Power Supply 1 and Power Supply 2 icons display in gray when there is no power to the power supply and in blue when power is present. When enabled (there is a check in the checkbox), if there is only one source of power, a constant warning beeps. A message displays asking for confirmation that having one power source is intentional. If one source of power is intended, to stop the beeping: <ul style="list-style-type: none">• Uncheck the checkbox to disable the function permanently.• Confirm your intention in the dialog box to disable the warning temporarily. The warning function will be back on after the next system reset. The default for this function is enabled.
Fan Warning Message	Place a check in the checkbox to enable a fan warning message. If enabled, when any fan stops spinning the system records the event in the system log. If it is not enabled, the event will not be recorded. The default for this function is enabled. Note: The warning does not mean that the fan has failed, since the fans stop when the temperature drops below the device's lower temperature setting.
Fan Speed	Displays fan speeds. See “Fan Location and Speed Information” on page 109.
Temperature Warning Message	Place a check in the checkbox to enable a temperature warning message. If enabled, when the device's temperature drops below the Low threshold setting, or exceeds the High threshold setting, the system records the event in the system log. If it is not enabled, the event will not be recorded. The default is enabled.
Temperature	Displays temperature readings from the switch's built-in sensors in Celsius or Fahrenheit. See “Temperature Sensor Location and Information” on page 109.

Operating Mode

Use the Operating Mode page to set working parameters.

- Force all to grayscale: Enable to change the remote displays of all devices connected to the KVM switch to grayscale. This can speed up I/O transfer in low bandwidth situations.
- Enable Device List: Enable for the switch to appear in the Server List of WinClient or Java Client AP. See “Windows Client AP Login” on page 20, and “Java Client AP Login” on page 21. The switch can still be connected, but its name will not appear in the Server List if the option is not enabled.

- Enable First Rider Transfer: Only the first user on a bus can switch ports when enabled. Other users on the bus cannot switch ports unless another bus is already connected to the port they would like to access, or there is a free bus available. See “Users and Buses” on page 89 for more information.
- Keyboard/Mouse Broadcast: Choose the setting from the drop down list.
 - Keyboard Broadcast: Keystrokes will be duplicated on all attached servers currently listed in the Sidebar when enabled.
 - Mouse Broadcast: Mouse movements and clicks will be duplicated on all attached servers currently listed in the Sidebar when enabled.



Note: 1. On a child KVM switch tiered from the parent or top level KVM switch, only one port can perform a Keyboard/Mouse broadcast at a time.
 2. For Mouse Broadcast, you and all the servers must be running the same OS, the monitors must have the same resolution, and screens must have an identical layout.

- Console Keyboard Language: Specify which keyboard mapping is being used by the Local Console keyboard from the drop down list.

Network

IP Installer. The IP Installer is an external Windows-based utility for assigning IP addresses to the KVM switch. Click one of the radio buttons to select Enable, View Only, or Disable for the IP Installer utility. See “IP Installer” on page 105 for details.



Note: If you select View Only, you can see the KVM switch in the IP Installer’s Device List, but you cannot change the IP address. For security, it is recommended to set this to **View Only** or **Disable** after each use.

Service Ports. As a security measure, if a firewall is being used, the Administrator can specify the port numbers that the firewall will allow. If a port other than the default is used, users must specify the port number as part of the IP address when they log in. If an invalid port number (or no port number) is specified, the KVM switch will not be found.

Field	Explanation
Program	This is the port number for connecting with the WinClient ActiveX Viewer, WinClient AP, Java Applet Viewer, Java Client AP, or via Virtual Media. The default is 9000.
HTTP	The port number for a browser login. The default is 80.
HTTPS	The port number for a secure browser login. The default is 443.
SSH	The port for SSH access. The default is 22.
Telnet	The port for Telnet access. The default is 23.



Note: 1. Valid entries for all Service Ports are from 1-65535.
 2. Service ports cannot have the same value. Set a different value for each port.
 3. If there is no firewall (on an Intranet, for example), these numbers will have no effect.

NIC Settings.

Redundant NIC

The KVM switch is designed with two network interfaces. If Redundant NIC is enabled (the default), both interfaces make use of the IP address of Network Adapter 1. The second interface is usually inactive. If there is a network failure on the first interface, the switch automatically switches to the second interface.

Redundant NIC Enabled - Single IP Address for Both Interfaces

1. Click to put a check in the Redundant NIC checkbox.
2. Network Adapter 1 is selected in the network adapter listbox, disabling the listbox. You cannot configure Network Adapter 2.
3. Configure the IP and DNS server addresses for Network Adapter 1 (see the sections below).

Redundant NIC Not Enabled - Two IP Addresses

If you choose not to enable the Redundant NIC function, the two NICs can be configured with separate interfaces. Users can log into the KVM switch with either IP address.

To set up the switch with this configuration:

1. If there is a check in the Redundant NIC checkbox, click to remove it.
2. In the network adapter listbox, select Network Adapter 1.
3. Configure the IP and DNS server addresses for Network Adapter 1.
4. Select Network Adapter 2 from the network adapter list.
5. Configure the IP and DNS server addresses for Network Adapter 2.

IPv4 Settings

IP Address:

IPv4 is the traditional method of specifying IP addresses. The KVM switch can either have its IP address assigned dynamically (DHCP), or it can be given a fixed IP address.

- For dynamic IP address assignment, select the **Obtain IP address automatically** radio button. (This is the default setting.)
- To specify a fixed IP address, select the **Set IP address manually** radio button and fill in the fields with values appropriate for your network.



- Note:** 1. If you choose Obtain IP address automatically, when the switch starts up it waits to get its IP address from the DHCP server. If it hasn't obtained the address after one minute, it automatically reverts to its factory default IP address (192.168.0.60.)
2. If the switch is on a network that uses DHCP to assign network addresses, and you need to ascertain its IP address, see "IP Address Determination" on page 105, for information.

DNS Server

- For automatic DNS Server address assignment, select the **Obtain DNS Server address automatically** radio button.
- To specify the DNS Server address manually, select the **Set DNS server address manually** radio button, and fill in the addresses for the Preferred and Alternate DNS servers with values appropriate for your network.



- Note:** Specifying the Alternate DNS Server address is optional.

IPv6 Settings

IP Address:

IPv6 is the new (128-bit) format for specifying IP addresses. (See “IPv6” on page 106 for further information.) The KVM switch can either have its IPv6 address assigned dynamically (DHCP), or it can be given a fixed IP address.

- For dynamic IP address assignment, select the **Obtain IP address automatically** radio button. (The default setting.)
- To specify a fixed IP address, select the **Set IP address manually** radio button and fill in the fields with values appropriate for your network.

DNS Server

- For automatic DNS Server address assignment, select the Obtain DNS Server address automatically radio button.
- To specify the DNS Server address manually, select the Set DNS server address manually radio button, and fill in the addresses for the Preferred and Alternate DNS servers with values appropriate for your network.



Note: Specifying the Alternate DNS Server address is optional.

Network Transfer Rate

This setting allows you to tailor the size of the data transfer stream to match network traffic conditions by setting the rate at which the KVM switch transfers data between itself and the client computers. The range is from 4-99999 Kilobytes per second (KBps).

Finishing

Be sure to enable **Reset on exit** on the Device Management > System Operation page (see “Reset on exit” on page 94), before logging out to allow network changes to take effect without powering the switch off and on.

ANMS

Use ANMS (Advanced Network Management Settings) to set up login authentication and authorization management from external sources. It is organized as a notebook with two tabs, each with a series of related panels.

Event Destination.

SMTP Settings

To have the KVM switch email reports from the SMTP server to you:

1. Enable the **Enable report from the following SMTP server**, and enter the IPv4 address, IPv6 address, or domain name of the SMTP server.
2. If your server requires a secure SSL connection, put a check in the **My server requires secure connection (SSL)** checkbox.
3. If your server requires authentication, put a check in the **My server requires authentication** checkbox, and enter the account information in the Account Name and Password fields.
4. Enter the email address where the report will be sent in the **From** field. Put only one email address in the **From** field. It cannot exceed 64 Bytes.
5. Enter the email address (addresses) where you want the SMTP reports sent in the **To** field.



Note: If the report will be sent to more than one email address, separate the addresses with a semicolon. The total cannot exceed 256 Bytes.

Log Server.

Important transactions that occur on the KVM switch, such as logins and internal status messages, are kept in an automatically generated log file. See “Log” on page 90, for details on setting up the log server.

- Specify the MAC address of the computer that the Log Server runs on in the MAC address field.
- Specify the port used by the computer that the Log Server runs on to listen for log details in the Port field. The valid port range is 1-65535. The default port number is 9001.



Note: The port number must be different than the one used for the Program port.

SNMP Server. Enable to be notified of SNMP trap events:

1. Check **Enable SNMP Agent**.
2. Enter the IPv4 address, IPv6 address, or domain name of the computer to be notified.
3. Enter the port number. The valid port range is 1-65535.



Note: The logs that are notified of SNMP trap events are configured on the Notification Settings page under the Log tab. See “Log Notification Settings” on page 91 for details.

Syslog Server.

To record all the events that take place on KVM switches and write them to a Syslog server:

1. Check **Enable**.
2. Enter the IPv4 address, IPv6 address, or domain name of the Syslog server.
3. Enter the port number. The valid port range is 1-65535.

Authentication

Disable Local Authentication.

Selecting this option disables login authentication on the KVM switch. The switch can only be accessed using LDAP, LDAPS, MS Active Directory, RADIUS or KVM Access Management Server authentication.

RADIUS Settings.

To allow authentication and authorization for the KVM switch through a RADIUS server:

1. Check **Enable**.
2. Enter the IP addresses and service port numbers for the Preferred and Alternate RADIUS servers. Use the IPv4 address, the IPv6 address or the domain name in the IP fields.
3. In the Timeout field, set the time in seconds that the KVM switch waits for a RADIUS server reply before it times out.
4. In the Retries field, set the number of allowed RADIUS retries.
5. In the Shared Secret field, key in the character string that you want to use for authentication between the KVM switch and the RADIUS Server. A minimum of 6 characters is required.
6. On the RADIUS server, Users can be authenticated with any of the following methods:
 - Set the entry for the user as su/xxxx. (xxxx represents the Username given to the user when the account was created on the KVM switch.)
 - Use the same Username on both the RADIUS server and the KVM switch.
 - Use the same Group name on both the RADIUS server and the KVM switch.
 - Use the same Username/Group name on both the RADIUS server and the KVM switch.

Assign the same user access rights that were assigned when the User or Group was created on the KVM switch. See “Adding Users” on page 60.

LDAP / LDAPS Authentication and Authorization Settings.

To allow authentication and authorization for the KVM switch via LDAP / LDAPS:

Item	Action
Enable	Put a check in the Enable checkbox to allow LDAP / LDAPS authentication and authorization.
Type	Click a radio button to specify whether to use LDAP or LDAPS.
LDAP Server IP and Port	Fill in the IP address and port number for the LDAP or LDAPS server. <ul style="list-style-type: none">• Use the IPv4 address, the IPv6 address or domain name in the LDAP Server field.• For LDAP, the default port number is 389; for LDAPS, the default port number is 636.
Admin DN	Consult the LDAP / LDAPS administrator to ascertain the appropriate entry for this field. For example, the entry might look like this: ou=kn4132,dc=aten,dc=com
Admin Name	Key in the LDAP administrator's username.
Password	Key in the LDAP administrator's password.
Search DN	Set the distinguished name of the search base. This is the domain name where the search starts for user names.
Timeout	Set the time in seconds that the KVM switch waits for an LDAP or LDAPS server reply before it times out.

On the LDAP / LDAPS server, Users can be authenticated with any of the following methods:

- With MS Active Directory schema.



Note: If this method is used, the LDAP schema for MS Active Directory must be extended. See “LDAP Server Configuration” on page 97, for details.

- Without schema - Only the Usernames used on the KVM switch are matched to the names on the LDAP / LDAPS server. User privileges are the same as the ones configured on the switch.
- Without schema - Only Groups in AD are matched. User privileges are the ones configured for the groups he belongs to on the switch.
- Without schema - Usernames and Groups in AD are matched. User privileges are the ones configured for the User and the Groups he belongs to on the switch.

To allow authorization for the KVM switch through a KVM Access server, check **Enable** and enter the Server's IP address and Service port in the appropriate fields. You can use the IPv4 address, the IPv6 address or the domain name in the Server IP field.



Note: If this function is enabled, PDU devices and Blade Servers do not appear in the Sidebar, even if they are configured on the switch because they are managed on the server.

OABC

In case the KVM switch cannot be accessed with the usual LAN-based methods, it can be accessed from the switch's modem port. A modem (customer supplied) is connected to the switch using an APC adapter cable (provided). To enable support for PPP (modem) operation, click to put a checkmark in the **Enable Out of Band Access** checkbox. See “PPP Modem Operation” on page 107, for PPP setup and operation.

When Out of Band Access is enabled, the Enable Dial Back, and Enable Dial Out functions become available.

Enable Dial Back. For security, if this function is enabled, the switch disconnects calls that dial in, and dials back to the selected option.

Item	Action
Enable Fixed Number Dial Back	If enabled, the KVM switch hangs up from an incoming call and dials back to the modem whose phone number is specified in the Phone Number field. Enter the phone number of the modem that you want the KVM switch to dial back to in the Phone Number field.
Enable Flexible Dial Back	If enabled, the modem that the KVM switch dials back does not have to be fixed. It can dial back to any modem that is convenient for the user: <ol style="list-style-type: none"> 1. Enter a password that the users must specify in the Password field. 2. When connecting to the KVM switch's modem, users specify the phone number of the modem that they want the KVM switch to dial back to as their Username, and specify the password set in the Password field for their password.

Enable Dial Out. For the dial out function, establish an account with an Internet Service Provider, and use a modem to dial up to your ISP account.

Item	Action
ISP Settings	Specify the telephone number, account name (username), and password that you use to connect to your ISP.
Dial Out Schedule	<p>Set the times for the KVM switch to dial out over the ISP connection.</p> <ul style="list-style-type: none"> • Every: Provides a listing of fixed times from every hour to every four hours. Example: Select Every two hours and the KVM switch will start dialing out every two hours beginning at 00:00. Select Never from the list if you don't want the KVM switch to dial out on a fixed schedule. • Daily at will dial out once a day at a specified time. Use the hh:mm time format. • PPP online time specifies how long the ISP connection lasts before terminating the session and hanging up the modem. A setting of zero means it is always on line.
Emergency Dial Out	<p>If the KVM switch gets disconnected from the network, or the network goes down, this function puts the switch on line via the ISP dial up connection.</p> <ul style="list-style-type: none"> • Choose PPP stays online until network recovery and the PPP connection to the ISP will last until the network comes back up or the switch is able to reconnect. • Choose PPP online time and the connection to the ISP will terminate after the time specified. A setting of zero means it is always on line.
Dial Out Mail Configuration	<p>Receive email notification of problems on the devices connected to the KVM switch's ports (see "SMTP Settings To have the KVM switch email reports from the SMTP server to you:" on page 70).</p> <p>Note: This email notification differs from the one configured under SMTP Settings. It uses the ISP mail server rather than the internal company's mail server.</p> <ul style="list-style-type: none"> • Enter the IPv4 address, IPv6 address, or domain name of your SMTP server in the SMTP Server IP Address field. • Enter the email address of the person responsible for the SMTP server (or another responsible administrator), in the Email From field. • Enter the email address (addresses) where the report will be sent in the To field. To send to more than one email address, separate the addresses with a comma or a semicolon. • If your server requires a secure SSL connection, put a check in the SMTP server requires secure connection (SSL) checkbox. • If your server requires authentication, put a check in the SMTP server requires authentication checkbox, enter the account name and password in the fields.

Click **Save** when finished.

Security

Login Failures

For increased security, administrators can set policies governing user log in failures. Check the Enable checkbox (the default is enabled).

Entry	Explanation
Allowed	Sets the number of consecutive failed login attempts permitted from a remote computer. The default is 5 times.
Timeout	Sets the amount of time a remote computer must wait before attempting to login again after exceeding the allowed failures. The default is 3 minutes.
Lock Client PC	If enabled, after the allowed failures have been exceeded, the computer attempting to log in is locked out. No logins from that computer will be accepted. The default is enabled. Note: If the client computer's IP is changed, the computer will no longer be locked out.
Lock Account	If enabled, after the allowed failures are exceeded, the user attempting to log in is automatically locked out. No logins from the failed username and password will be accepted. The default is enabled.



Note: If Login Failures is not enabled, users can attempt to log in an unlimited number of times with no restrictions. For security purposes, enable the function and lockout policies.

Filter

IP and MAC Filtering

Control access to the KVM switch based on the IP and/or MAC addresses of the client computers attempting to connect. A maximum of 100 IP filters and 100 MAC filters are allowed. If any filters have been configured, they appear in the IP Filter and/or MAC Filter list boxes.

To enable, click to put a check mark in the **IP Filter Enable and/or MAC Filter Enable** checkbox.

- If the **Include** button is checked, all the addresses within the filter range are allowed access; all other addresses are denied access.
- If the **Exclude** button is checked, all the addresses within the filter range are denied access; all other addresses are allowed access.

Adding Filters

To add an IP filter:

1. Click **Add** to open the dialog box.
2. Specify an IPv4 or IPv6 address.
3. Enter the address you want to filter in the **From:** field.
 - To filter a single IP address, click to put a check in the **Single IP** checkbox.
 - To filter a continuous range of addresses, enter the end number of the range in the **To:** field.



Note: This description is for the AP GUI. The Browser GUI does not offer an IPv4 or IPv6 choice. It only has From and To fields for IPv4 filtering and does not have a checkbox to specify a single IP address. To filter a single IPv4 address, enter the same address in both From and To fields.

4. After filling in the address, click **OK**.
5. Repeat the steps to filter additional IP addresses.

To add a MAC filter:

1. Click **Add** to open the dialog box.
2. Specify the MAC address, then click **OK**.
3. Repeat the steps to filter additional MAC addresses.

IP Filter / MAC Filter Conflict. If there is a conflict between an IP filter and a MAC filter (a computer's address is allowed by one filter but blocked by the other) then the blocking filter takes precedence (the computer's access is blocked).

Modifying Filters. To modify a filter, select it in the IP Filter or MAC Filter list boxes and click **Modify**. The Modify dialog box is similar to the Add dialog box. When it opens, delete the old address(es) and replace with the new address(es).

Deleting Filters. To delete a filter, select it in the IP Filter or MAC Filter list box and click **Delete**.

Login String. The Login String entry field lets the super administrator specify a login string (in addition to the IP address) that users must add to the IP address when they access the KVM switch with a browser. Example: if **192.168.0.126** were the IP address, and **abcdefg** were the login string, the user would have to enter: **192.168.0.126/abcdefg**



- Note:**
1. Users must place a forward slash between the IP address and the string.
 2. If no login string is specified, anyone can access the KVM switch login page using the IP address alone, making the installation less secure.

- The following characters are allowed in the string: 0-9 a-z A-Z ~ ! @ \$ & * () _ - = + [] , . |
- The following characters are not allowed: % ^ " : / ? # \ ' { } ; ' < > [Space]
- Compound characters (É Ç ñ ... etc.)

For security purposes, it is recommended that the string be changed occasionally.

Account Policy

System administrators can set policies governing usernames and passwords.

Entry	Explanation
Minimum Username Length	Sets the minimum number of characters required for a username. Acceptable values are from 1-16. The default is 3.
Minimum Password Length	Sets the minimum number of characters required for a password. Acceptable values are from 0-16. A setting of 0 means that no password is required. Users can login with only a Username. The default is 3.
Password Must Contain At Least	Checking any item in this section requires users to include at least one uppercase letter, one lowercase letter or one number in their password. Note: This policy only affects user accounts created after this policy has been enabled, and password changes to existing user accounts. Users accounts created before the policy is enabled, and existing passwords that have not been changed, are not affected.
Disable Duplicate Login	Check to prevent users from logging in with the same account at the same time.

Encryption

Flexible encryption alternatives for keyboard/mouse, video, and virtual media data let you choose any combination of DES; 3DES; AES; RC4; or a Random cycle of any or all of them. Enabling encryption affects system performance. No encryption offers the best performance. The greater the encryption the greater the adverse effect. If you enable encryption, performance considerations are:

- RC4 offers the least impact on performance; DES is next; then 3DES or AES.
- The RC4 + DES combination offers the least impact of any combination.

Mode

Item	Explanation
Enable ICMP	If ICMP is enabled, the KVM switch can be pinged. If it is not enabled, the device cannot be pinged. The default is Enabled.
Enable Multiuser Operation	Enabling Multiuser Operation permits up to 32 users to log in at the same time to share the remote bus. If not enabled, only one user can log in at a time. The default is Enabled.
Enable Virtual Media Write Operation	Enabling Virtual Media Write Operation allows redirected virtual media devices on a user's system to send data to a remote server, as well as being able to have data from the remote server written to them.
Enable Local Virtual Media	Enabling Local Virtual Media allows USB storage peripherals (CD/DVD, HD, flash drives, etc.) connected to the KVM switch to appear and act as if installed on a remote system.
Browser Service	Enabling allows the administrator to restrict browser access to the KVM switch. After checking Browser Service, select the degree of restriction from the list. <ul style="list-style-type: none">• Disable Browser: no browser access is permitted.• Disable HTTP: browser access is permitted, but the switch must be accessed with an HTTPS URL.• Disable HTTPS: browser access is permitted, but users must access the switch with an HTTP URL.
Disable Authentication	If checked, no authentication procedures check users attempting to log in. Users gain Administrator access to the KVM switch by entering their username and password. Note: Enabling this setting creates an extremely dangerous security condition, and should only be used under very special circumstances.

Private Certificate

When logging in over a secure (SSL) connection, a signed certificate is used to verify that the user is logging in to the intended site. For enhanced security, the Private Certificate section allows you to use your own private encryption key and signed certificate, rather than the default certificate.

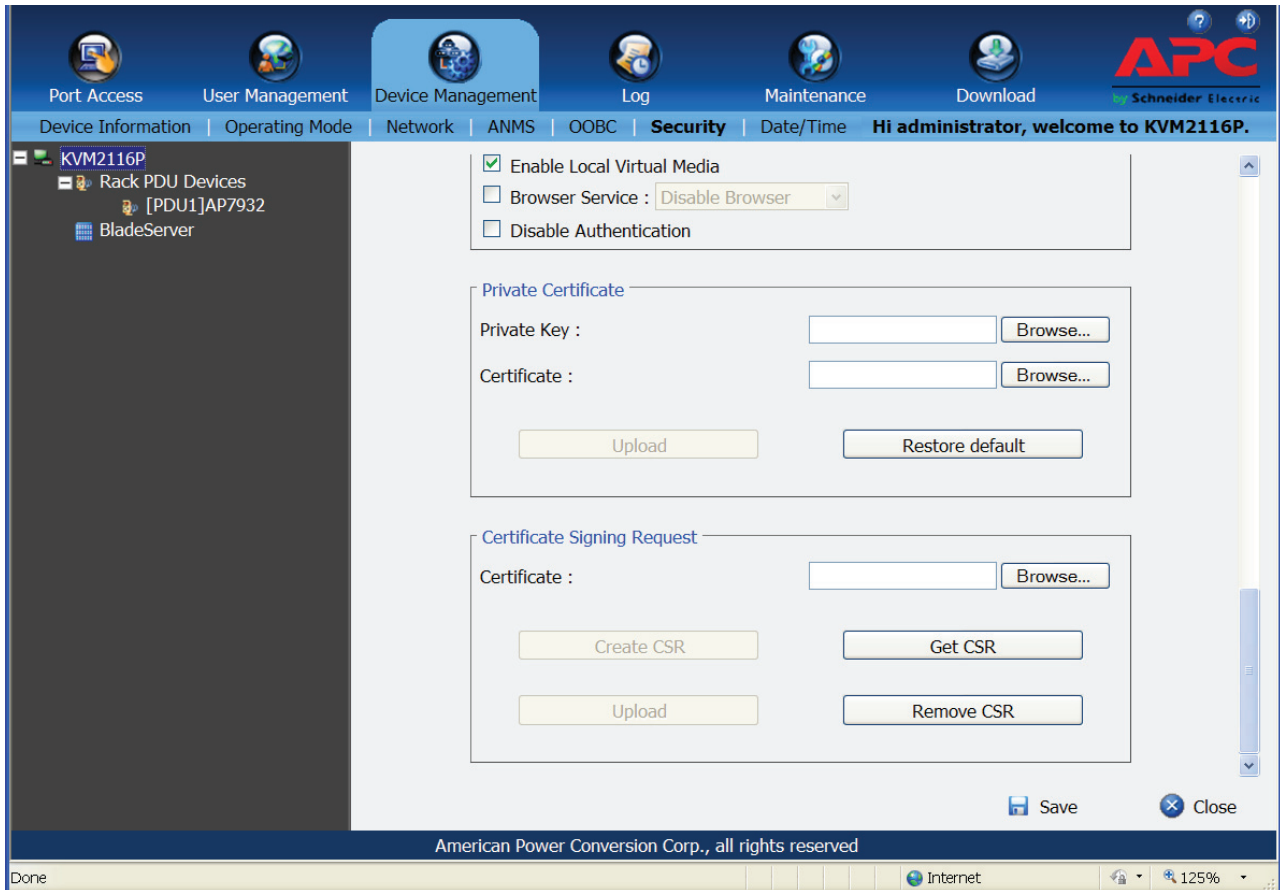

There are two methods for establishing your private certificate:

- **Generating a Self-Signed Certificate**
To create your own self-signed certificate, free utilities are available for download over the web. See “Self-Signed Private Certificates” on page 112 for more information.
- **Obtaining a CA Signed SSL Server Certificate**
For the greatest security, a third party certificate authority (CA) signed certificate is recommended. To obtain a third party signed certificate, go to a CA (Certificate Authority) website to apply for an SSL certificate. After the CA sends you the certificate and private encryption key, save them to a convenient location on your computer.
- **Importing the Private Certificate**
To import the private certificate:
 1. Click **Browse** to the right of Private Key, browse to the location of your private encryption key file and select it.
 2. Click **Browse** to the right of Certificate, browse to the location of your certificate file and select it.
 3. Click **Upload** to complete the procedure.



Note: 1. Click **Restore Default** to return the device to using the default certificate.
2. Both the private encryption key and the signed certificate must be imported at the same time.

Certificate Signing Request

The Certificate Signing Request (CSR) is located under Device Management >Security >Private Certification section. The Certificate Signing Request (CSR) section provides an automated way to obtain and install a CA signed SSL server certificate. The KVM switch supports 1024-bit certificates only in .cer format of x509 type.

To perform this operation:

1. Click **Create CSR** to open the dialog box.
2. Fill in the form with valid entries for your site. There are no unacceptable characters.

Information	Max Characters	Example
Country	2 letter code	US
State or Province	32	Missouri
Locality	32	St. Louis
Organization	64	Your Company, Ltd.
Unit	32	Techdoc Department
Common Name	32	mycompany.com Note: The domain name of the site must be exact for the certificate is to be valid. If the domain name is www.mycompany.com, and only mycompany.com is specified, the certificate will not be valid.
Email Address	64	administrator@yourcompany.com

3. Click **Create** when finished (all fields are required). A self-signed certificate based on the information just provided is now stored on the KVM switch.
4. Click **Get CSR**, and save the certificate file (csr.cer) to your computer. This is the file given to the third party CA to apply for their signed SSL certificate.
5. After the CA sends you the certificate, save it to a convenient location on your computer. Click **Browse** to locate the file; then click **Upload** to store it on the KVM switch.



Note: When the file is uploaded, the KVM switch checks the file to make sure the specified information still matches. If it does, the file is accepted, if not, it is rejected.

To remove the certificate (Example: replacing it due to a domain name change), click **Remove CSR**.

Date/Time

The Date/Time dialog page sets the KVM switch time parameters according to the information below.

Time Zone.

- Choose from the Time Zone list the city that corresponds to the location of the KVM switch.
- If your country or region employs Daylight Saving Time (Summer Time), check the corresponding checkbox.

Date.

- Select the month from the list.
- Click < or > to move backward or forward by one year increments.
- In the calendar, click on the day.
- To set the time, use the 24 hour HH:MM:SS format.
- Click **Set** to save your settings.

Network Time.

To automatically synchronize the time to a network time server:

1. Check the **Synchronize with NTP Server** checkbox.
2. Select your preferred time server from the list or check the Preferred custom server IP checkbox, and enter the IPv4 address, IPv6 address, or domain name of the time server.
3. If you want to configure an alternate time server, check the Alternate time server checkbox, and repeat step 2 for the alternate time server entries.
4. Enter the number of days between synchronization procedures.
5. If you want to synchronize immediately, click **Update Using NTP Now**.

PDU Devices

Configuration Page

Select a PDU device in the Sidebar to open its Configuration page.

The screenshot shows the APC Device Management web interface. The top navigation bar includes icons for Port Access, User Management, Device Management (selected), Log, Maintenance, and Download. The APC Schneider Electric logo is in the top right. On the left sidebar, a tree view shows 'KVM2132P' expanded to 'PDU Devices', with 'Rack PDU' selected. The main content area is titled 'Configuration' and 'Summary'. It contains a table with the following data:

Name	Status	Power On Delay	Power Off Delay	Power Reboot Delay
<input type="checkbox"/> Rack PDU				
<input type="checkbox"/> [01] Outlet 1		5	0	5
<input type="checkbox"/> [02] Outlet 2		5	0	5
<input type="checkbox"/> [03] Outlet 3		0	0	5
<input type="checkbox"/> [04] Outlet 4		0	0	5
<input type="checkbox"/> [05] Outlet 5		0	0	5
<input type="checkbox"/> [06] Outlet 6		0	0	5
<input type="checkbox"/> [07] Outlet 7		0	0	5
<input type="checkbox"/> [08] Outlet 8		0	0	5

At the bottom right of the configuration area are 'Save' and 'Close' buttons. The footer of the interface reads 'APC by Schneider Electric' and 'V1.0.070'.

Outlet Configuration

- Click on a PDU to open a list of choices.
- Click to put a check mark in front of the outlets to be configured. Change the setting for any of the selected outlets and each of the selected outlets gets the new setting.
- To select all of the outlets, check the box in front of the PDU's name. Change the setting for any of the outlets and all of the outlets get the new setting.

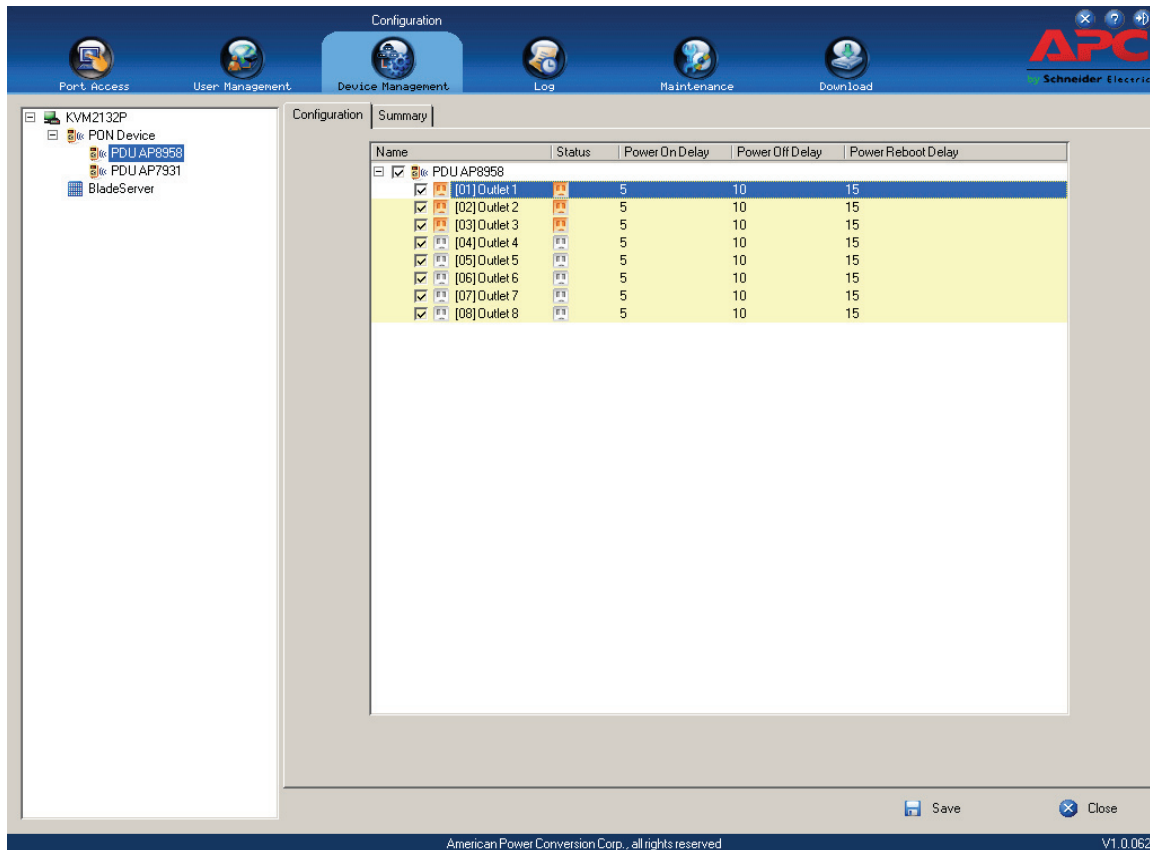

Configure Outlet Time Delay

1. In the Device Management page, select the PDU.
2. Change delay settings (seconds) by clicking on the numbers. Put check marks in the boxes in front of the outlets in the list to apply the same setting to all selected.

Port Operation

After logging in, the KVM switch opens to the Port Access tab's Connections page, with the first KVM switch selected in the sidebar.



Note: 1. The WinClient and Java Client AP programs have a hidden Control Panel at the upper center of the screen that becomes visible when you move the mouse over it. The Browser's Control Panel only appears after you switch to a port.

Connecting to a Port

All the devices, ports, and outlets that a user is permitted to access are listed in the Sidebar at the left of the page.

- To connect to a port when a device is selected in the Sidebar:
Double click its icon in the Sidebar, double click anywhere on its line entry in the main central panel, or select it in the main panel and click **Connect** at the bottom right of the page.
- To connect to a port when the port is selected in the Sidebar, click **Connect** at the right of the Status panel (see “Status” on page 41).

Once switched to a port, its screen displays on your monitor, and your keyboard and mouse input affects the remote server.

Port Toolbar

The switch provides a toolbar to help with port switching operations from within the captured port. To open the toolbar, tap the GUI Hotkey (Scroll Lock is the default), twice. The toolbar opens at the upper left corner of the screen.

Depending on the settings selected for ID Display, the Port Number and/or the Port Name display at the right of the toolbar.









When the toolbar displays, mouse input is confined to the toolbar area and keyboard input has no effect on the server connected to the port. To carry out server operations, close the toolbar by clicking its **X** icon.

To return to the Port Access Connections page, click the icon, or tap the GUI hotkey again.



Note: 1. Toolbar transparency can be adjusted (see “Video Settings” on page 30).
2. The toolbar functions and icons are also incorporated in the Control Panel. Functions enabled in the Control Panel can be disabled the Toolbar. To recall the Port Access Connections page when there is no Toolbar, tap the GUI hotkey twice.

Toolbar icons

Icon	Purpose
	Click to skip to the first accessible port on the entire installation without recalling the Port Access page.
	Click to skip to the first accessible port previous to the current one without recalling the Port Access page.
	Click to begin Auto Scan Mode. The KVM switch automatically switches among the ports selected for Auto Scanning with the Filter function. This allows activity monitor without switching among them manually.
	Click to skip from the current port to the next accessible one, without having to recall the Port Access page.
	Click to skip from the current port to the last accessible port on the entire installation without recalling the Port Access page.
	Click to recall the Port Access page.
	Click to close the toolbar.
	Click to invoke Panel Array Mode. Not available on KVM1116P at local console
	Click to cycle through the Adapter cable choices (Short, Medium, Long) used to connect the device to the switch. Choice depends on the length of Cat 5e cable used for the connection. The line length on the icon changes to indicate the selection.

Toolbar Hotkey Port Switching

When the toolbar is displayed, hotkeys can be used to provide KVM focus to a port directly from the keyboard.

- Go directly to a port by entering its port number and clicking **Enter**.
- Auto Scanning
- Skip Mode Switching

The hotkeys are A and P for Auto Scanning and the Arrow Keys for Skip Mode.



- Note:** 1. The toolbar must be visible for hotkey operations to work.
2. To use the keys designated as hotkeys for normal purposes, close the toolbar.

Auto Scanning

The Scan function switches at regular intervals among all ports accessible to the currently logged on user to automatically monitor activity. Users can also limit the number of ports scanned with the Filter function of the Sidebar. See “Scan” on page 40, and “Filter” on page 40, for more details.

- **Setting the Scan Interval:** The amount of time Auto Scan dwells on each port is set with the Scan Duration setting (page 51).
- **Invoking Auto Scan:** With the toolbar open, tap the A key. Auto Scan cycles through the ports in order, starting at the first port on the installation. An S appears in front of the Port ID Display to indicate that the port is being accessed under Auto Scan Mode.

- **Pausing Auto Scan:** Pause scanning to focus on a particular server by pressing P. While Auto Scanning is paused, the S in front of the Port ID blinks On and Off. Pausing to keep the focus on a particular server can be more convenient than exiting Auto Scan Mode because when scanning resumes, it starts where it left off. If you exit and then restart Auto Scan Mode, the scanning starts over from the very first server on the installation. To Resume Auto Scanning after a pause, press any key except [ESC] or the [SPACEBAR].
- **Exiting Auto Scan:** While Auto Scan Mode is running, ordinary keyboard functions are suspended. Exit Auto Scan Mode in order to regain normal control of the keyboard. To exit Auto Scan Mode press [ESC] or the [SPACEBAR]. Auto Scanning stops when you exit Auto Scan Mode.

Skip Mode

Switch ports in order to monitor the servers manually. Dwell on a particular port for as long as needed as opposed to Auto Scanning, which automatically switches after a fixed interval. The Skip Mode hotkeys are the four Arrow keys. Their operation is explained in the table below:

Icon	Purpose
Left	Skips from the current port to the first accessible port previous to it.
Right	Skips from the current port to the first accessible port that comes after it.
Up	Skips from the current port to the very first accessible port on the installation.
Down	Skips from the current port to the very last accessible port on the installation.

Recalling the Port Access Page

To dismiss the toolbar and bring back the Port Access page:

- Tap the GUI Hotkey once.
- From the toolbar, click the icon that recalls the Port Access page (see “Toolbar icons” on page 84).

When the toolbar closes, the Port Access Page opens.

GUI Hotkey Summary Table









The table presents a summary of GUI Hotkey actions after you have accessed a port. See “User Preferences” on page 51 to set the GUI Hotkey.

To	Do This	
Open the Toolbar	Click the GUI Hotkey twice	
Open the Port Access Page	The Toolbar is open	Click the GUI Hotkey once
	The Toolbar is not open	Click the GUI Hotkey three times

Keyboard Emulation

Mac Keyboard

The PC compatible (101/104 key) keyboard can emulate the functions of the Mac keyboard. The emulation mappings are listed in the table below.







PC Keyboard	Mac Keyboard
[SHIFT]	Shift
[CTRL]	Ctrl
	
[CTRL] [1]	
[CTRL] [2]	
[CTRL] [3]	
[CTRL] [4]	
[ALT]	Alt
[PRINT SCREEN]	F13
[SCROLL LOCK]	F14
	=
[ENTER]	Return
[BACKSPACE]	Delete
[INSERT]	Help
[CTRL] 	F15

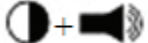

Note: When using key combinations, press and release the first key (CTRL), then press and release the activation key.

Sun Keyboard

The PC compatible (101/104 key) keyboard can emulate the functions of the Sun keyboard when the Control key [Ctrl] is used in conjunction with other keys. The corresponding functions are shown below.

PC Keyboard	Sun Keyboard
[CTRL] [T]	Stop
[CTRL] [F2]	Again
[CTRL] [F3]	Props
[CTRL] [F4]	Undo
[CTRL] [F5]	Front
[CTRL] [F6]	Copy
[CTRL] [F7]	Open
[CTRL] [F8]	Paste
[CTRL] [F9]	Find
[CTRL] [F10]	Cut
[CTRL] [1]	
[CTRL] [2]	
[CTRL] [3]	
[CTRL] [4]	
[CTRL] [H]	Help
	Compose
	Meta



Note: When using key combinations, press and release the first key (CTRL), then press and release the activation key.











Panel Array Mode

Click the **Panel** icon on the toolbar to start Panel Array Mode. The screen is divided into up to 42 panels:

- Each panel represents one of the switch's ports beginning with Port 1 at the upper left, and going from left to right; top to bottom.
- Click **Show More Ports**, and **Show Fewer Ports** symbols on the panel array toolbar to select the number of panels in the array.
- Panel Array scans each of the ports previously selected with the Filter function (see “Filter” on page 40). The panel’s border is highlighted while that port is the focus of the scan.
- Only ports accessible to the user are displayed. Blank panels display for ports that are not accessible.
- If the server connected to a port is on line the screen displays in the panel, otherwise the panel is blank.
- Move the mouse over a panel to display information about the port (port name, online status, port access status, and resolution).
- Access a server connected to a port by moving the mouse pointer over its panel and clicking. You switch to the server exactly as if you had selected it from the Port Access page.

Panel Array Toolbar

The panel array toolbar provides shortcut navigation and control of the panel array. The toolbar can be dragged anywhere on the screen. Move the mouse over an icon to show a "tooltip" (a short description of the icon's function).

Icon	Purpose
	Click and drag to move the toolbar. Note: This icon is only available with the Windows Clients. To move the Java Client toolbars, click on any empty space and drag.
	Pause panel scanning, leaving the focus on the panel that currently has it.
	Move back four panels.
	Move to the previous panel.
	Move to the next panel.
	Move ahead four panels.
	Show More Ports: Increase the number of panels in the array.
	Show Fewer Ports: Decrease the number of panels in the array.
	Toggle 4/3 aspect ratio.
	Exit Panel Array mode.

Multiuser Operation

The KVM switch supports multiuser operation. When multiple users simultaneously access the switch from client computers, the rules of precedence that apply are shown in the following table:

Operation	Rule
General	Each bus is independent. Each user can open his own independent GUI Main Page.
Auto Scan Mode	<ul style="list-style-type: none">• If a user has invoked Auto Scan Mode, and another user logs on and is assigned to the same bus, at first the new user sees the GUI Main Page but, as soon as he accesses any port, he automatically enters Auto Scan Mode (since he is sharing the bus with the original user).• Any user on the bus can halt Auto Scan Mode by recalling the GUI Main Page. When this occurs, Auto Scan Mode stops and all other users on the bus are switched to the port that was being accessed when Auto Scan Mode stopped.
Panel Array Mode	<ul style="list-style-type: none">• If a user has invoked Panel Array Mode (see page 88), and another user logs on and is assigned to the same bus as the first user, the new user sees the GUI Main Page. As soon as he accesses any port, he enters Panel Array Mode (since he is sharing the bus with the original user).• Panel Array Mode continues until the original user stops it. (Administrators can override Panel Array Mode.)• Only the user who starts Panel Array Mode can use Skip Mode (see page 85).• Only the user who starts Panel Array Mode can switch ports. Other users automatically switch to the ports that the original user selects. If a user does not have access rights to the port that the original user has switched to, that user will not be able to view the port.• Users can increase or decrease the number of panels they wish to view in Panel Array Mode; however, the picture quality may decrease as the number of panels increases.

Users and Buses

KVM2132P / KVM2116P / KVM1116P switches support independent bus switching. With independent bus switching, if a user switches to a port that is being utilized by someone on a different bus, only the user that switched ports goes to the new port and the new bus. The other users on the original bus remain on the original port and original bus.



- Note:** 1. Independent bus switching does not work when Auto Scan Mode or Panel Array Mode is being used by one of the members of the bus.
2. If Enable First Rider Transfer is enabled (see page 68), only the first user on a bus can switch to an unaccessed port. Other users on the bus cannot switch ports unless there is a bus already connected to the port they want to access, or there is a free bus available.

Panel Array Mode should be set to display at least four panels or other users may only receive part of the picture.

Log

Log Information

The Log Information page displays events and provides the time, severity, user, and description of each event. The sort order can be changed by clicking on the column headings. The log file tracks a maximum of 512 events. When the limit is reached, the oldest events are discarded as new events arrive.

Button	Explanation
Pause	Clicking Pause stops the display of new events. When the display is paused the button changes to Resume. Click Resume to start displaying events again.
Clear Log	Clicking Clear Log clears the log file.
Export Log	Clicking Export Log lets you save the contents of the log to a file on your computer.
Filter	Clicking Filter allows you to search for particular events by date or by specific words or strings, as described in the next section.

Filter.

Narrow the log event display to events that occurred at specific times, contain specific words or strings, or involve specific users. When this function is accessed, the log filter dialog box appears at the bottom of the page.

Item	Description
Time	Filter for events that occurred at specific times: <ul style="list-style-type: none">• Today Only: Only the events for the current day are displayed.• Start Date/Time: Filters for events from a specific date and time to the present. Check the checkbox to open a calendar. Set the date and time for the filtering to start. All events from the Start date/time to the present are displayed.• For the Web Browser interface, check the Start Date/Time, click inside the text box to open the calendar. After calendar choices are made, click the A icon at the lower right of the calendar panel.• End Date/Time: Filters for events from a specific date and time to a specific date and time. Select the Start Date/Time, check End Date/Time to set the ending date and time.• For the Web Browser interface, Check End Date/Time, then click inside the text box to open the calendar. After calendar choices are made, click the A icon at the lower right of the calendar panel.
Information*	Filters for a particular word or string. Enter word or string into the Information text box. Only events containing that word or string are displayed. Wildcards (? for single characters and * for multiple characters) and the keyword “or” are supported.
User	Filters for specific users. Check the User checkbox, enter the user's Username, then click Apply . Only events containing that Username are displayed. Note: If the User checkbox is not checked in the Filter panel, the entire User column does not appear in the main panel.
Severity	Filters based on the severity rating of the event. Least events appear in black, Less events appear in blue, Most events appear in red. Put a check in the Severity checkbox, then check the severity options to filter. Only events that match the severity ratings specified appear in the display. Note: If the Severity checkbox is not checked in the Filter panel, the entire Severity column does not appear in the main panel.
Apply	Click to apply the filter choices.
Reset	Click to clear the entries in the dialog box and start with a clean slate.
Exit	Click to exit the log filter function.
* See page 59 for an example.	

Log Notification Settings

Select which events trigger a notification and how the notification are sent out. Notifications can be sent via SNMP trap, SMTP email, written to the SysLog file, or any combination of the three. A check mark indicates that notification of the event is enabled for the method specified in the column heading, an X indicates that notification is not enabled.



Note: In any of the columns, Shift-Click or Ctrl-Click to select a group of events. Clicking to enable/disable any one of them causes all of them to change in unison.

Maintenance

Upgrade firmware, backup and restore configuration and account information, ping network devices, and restore default values.

Main Firmware Upgrade

Upgrade the KVM switch's main firmware and upgrade any PDU units and Blade Servers deployed on the installation. New versions of the firmware can be downloaded from the website as they become available. Check the website regularly to find the latest information and packages.

To upgrade the main firmware:

1. Download the new firmware file (switch, PDU or blade server module) to your computer.
2. Log in to the KVM switch and click the **Maintenance** tab to open the Upgrade Main Firmware page.
3. Click **Browse**, navigate to the new firmware file, and select the file.
4. Click **Upgrade Firmware**.
 - If you enabled **Check Main Firmware Version** the current firmware level is compared with that of the upgrade file. If the current version is equal to or higher than the upgrade version, a popup message appears to inform you and the upgrade procedure stops.
 - If you did not enable **Check Main Firmware Version**, the upgrade file is installed without checking the level.
 - As the upgrade proceeds, progress information is shown in the Progress bar.
 - Following successful completion, the switch resets itself.
5. Log in again, and check that the new firmware version is installed.

Adapter Firmware Upgrade

1. Log in to the KVM switch, click the **Maintenance** tab, and select Upgrade Adapters.
2. Click **Adapter Firmware Info** to open a list of adapter firmware versions. If the main firmware has been upgraded, newer versions than what is on the adapters may be listed.
3. Compare the versions stored in the main firmware with the versions listed in the F/W Version column of the Main Panel. If the versions stored in the firmware are newer than the versions on the adapters, perform the upgrade.
4. In the Name column of the Main Panel, check the ports whose adapters you want to upgrade.
5. Click **Upgrade Adapters** to start the upgrade.
 - If **Check Adapter Firmware Version** was enabled, the current firmware level(s) are compared to the upgrade versions. If the current version is equal to, or higher than the upgrade version, a message appears in the adapter's Progress column to announce that no upgrade is available and the upgrade stops.
 - If **Check Adapter Firmware Version** is not enabled, the upgrade installs without checking the level.
 - The new adapter firmware version displays when the upgrade is finished.



Note: 1. For optimum compatibility, upgrade Adapter Cable firmware to that stored with the switch's Main firmware.
2. Perform the upgrade when an adapter is added to the installation to ensure the latest firmware version is used.

Update Adapter Display Info. Read display information (ex: brand/type/EDID) for monitor. Write display information to server modules so that computers can identify the monitor connected at console ports. This is only necessary to set to unique resolution level provided by the monitor.

Firmware Upgrade Recovery

If the switch's main firmware upgrade procedure fails, and the switch becomes unusable:

1. Power off the switch.
2. Press and hold the **Reset Switch** in (see page 7).
3. While holding the **Reset Switch** in, power the switch back on.

The switch reverts to the original factory installed main firmware version. Once the switch is operational, try the upgrade again.

Adapter Firmware Upgrade Recovery

If the adapter firmware upgrade procedure fails for one of the KVM Adapter Cables and the adapter becomes unusable:

1. Unplug the Adapter from the server it is connected to.
2. Slide its Firmware Upgrade Recovery Switch (located next to the Cat 5e connector) to the **RECOVER** position.
3. Plug the Adapter back into the server.
4. Repeat the Adapter upgrade procedure.
5. After the Adapter has been successfully upgraded, unplug the Adapter from the server. Slide the Firmware Upgrade Recovery Switch back to the **NORMAL** position. Plug the Adapter back into the server.

Backup/Restore

Backup

1. Enter a password for the file in the Password field.



Note: 1. A password is optional. If one has not been set, the file can be restored without specifying a password.

2. If a password is set, make a note of it. It is necessary to restore the file.

2. Click **Backup**.
3. When the browser asks what to do with the file, select **Save to disk**. (Save in a convenient location.)

Restore

1. Click **Browse**, navigate to the file, and select it.



Note: If you renamed the file, there is no need to return it to its original name.

2. If you set a password when you created the file, enter it.
3. Select the options to restore.
4. Click **Restore**.
After the file is restored, a message appears to inform you that the procedure succeeded.

Ping

Check the network status of devices on the KVM switch installation with Ping.

1. Enter the IP Address or Host Name of the switch into the text entry box.
2. Click **OK**.

The ping results display in the Result panel.

Restore Values

Restore configuration changes made to the KVM switch to their original factory default values.

Clear Port Names. Removes names that have been assigned to the ports

Restore Default Values. Removes all changes made to the KVM switch (except for the Port Names), including the Network Transfer Rate (on the Network page). The parameters return to the original factory default settings.

Reset on exit

Place a check in the checkbox and click **Apply** to have the KVM switch reset itself and implement all the new settings when you log out. (Wait approximately 30 to 60 seconds before logging back in.) If the switch's IP Address is changed, the checkbox is automatically checked and the KVM switch will reset when you log out. If the check mark is cleared before logging out, the changed IP settings will be ignored and the original IP address settings will remain in effect.



Note: If the check mark was cleared, the changed IP settings are ignored, but still remain in the network settings fields. The **Reset on exit** checkbox will automatically be enabled the next time the page is opened. When the switch resets, the discarded IP settings will be used by the switch. To avoid a problem, go to the network settings page and see that the correct IP settings are in the fields.

The Download Tab

To download stand-alone AP versions of the Windows Client, the Java Client, and the Log Server to your computer's hard drive:

Port Number	Port Name	Device Name	Status
01		I2116P	Offline
02		I2116P	Offline
03		I2116P	Offline
04		I2116P	Offline
05		I2116P	Offline
06		I2116P	Offline
07		KVM2116P	Offline
08		KVM2116P	Offline
09		KVM2116P	Offline
10		KVM2116P	Offline
11		KVM2116P	Offline
12		KVM2116P	Offline

The Log Server

The Windows-based Log Server is an administrative utility that records all the events that take place on selected KVM switches and writes them to a searchable database.

Installation

1. Log into the KVM switch (see page 17).
2. Click the **Download** tab and download the Log Server AP program to your computer.
3. Go to the location on your hard drive and double click LogSetup.exe to open the Windows Client Connection Screen.
4. When the Log Server installation screen opens, click **Next**. Then follow the on-screen instructions to complete the installation and place the Log Server program icon on your desktop.

Starting Up

To start the Log Server, double click the program icon, or enter the full path to the program on the command line.



- Note:** 1. The MAC address of the Log Server computer must be specified in the ANMS settings.
2. The Log Server requires the Microsoft Jet OLEDB 4.0 driver. See Log Server in the Troubleshooting section on page 119 if the program doesn't start.

The screen is divided into three components.

- A Menu Bar at the top
- A panel containing a list of KVM switches in the middle.
- A panel containing an Events List at the bottom

The Menu Bar



Note: If the Menu Bar appears to be disabled, click in the List window to enable it.

Configure. The Configure menu contains three items: Add; Edit; and Delete. They are used to add new units to the List, edit the information for units already on the list, or delete units from the list.

- To add a unit to the list, click **Add**.
- To edit or delete a listed unit, first select the target in the List window, then open the menu and click **Edit** or **Delete**.

Choose **Add** or **Edit** to open a dialog box. Fill in or modify the fields, then click **OK** to finish.

Field	Explanation
Address	The IP address of the computer on which the Log Server is running, or its DNS name.
Port	The port number that was assigned to the Log Server under Device Management (see “Log Server” on page 71).
Description	Enter a descriptive reference for the unit to help identify it.
Limit	Specify the number of days an event should be kept in the Log Server's database. Events that exceed the amount of time specified can be removed (see “Maintenance” on page 92).

Events.

The Events Menu has two items: Search and Maintenance.

Search: Search for events containing specific words or strings.

Item	Description
New search	One of three radio buttons that define the scope of the search. Select to search all events in the database for the selected unit.
Search last results	A secondary search performed on the results of the previous search.
Search excluding last results	Perform a secondary search of all events in the database for the selected unit excluding the results of the previous search.
Server List	KVM switches are listed according to their IP address. Select the unit to search from this list. More than one unit can be selected. If no units are selected, the search is performed on all of them.
Priority	Set the level of detail for the search results display. Least is the most general; Most is the most specific. Least results appear in black; Less results appear in blue; Most results appear in red.
Start Date	Select the start date of the search. The format follows the YYYY/MM/DD convention (Example: 2011/11/04).
Start Time	Select the start time of the search. The format follows the HH:MM:SS convention.
End Date	Select the end date of the search.
End Time	Select the end time of the search.
Pattern	Enter the pattern you are searching for here. The multiple character wildcard (%) is supported.
Results	Lists the events that matched the search.
Search	Click to start the search.
Print	Click to print the search results.
Export	Click to save the search results to file.
Exit	Click to exit the Log Server.

Maintenance. Allows the administrator to perform manual maintenance of the database, such as erasing specified records before their expiration time is up.

Options. Network Retry: Set the amount of time that the Log Server should wait before attempting to reconnect following a failed attempt. Click to open the dialog box. Enter the number of seconds. Click OK to finish.

Help. From the Help menu, click **Contents** to access the online Windows Help file. The help file contains instructions for setup, operation, and troubleshooting of the Log Server.

The Log Server Main Screen

Overview. The Log Server Main Screen is divided into two main panels.

- The upper (List) panel lists all of the switches that have been selected for the Log Server to track (see “Log” on page 90).
- The lower (Event) panel displays the event information for the currently selected unit. (If there are multiple switches, the selected switch is highlighted).
- Click on a unit in the list to select.

The List Panel. The List panel contains six fields:

Field	Explanation
Recording	Put a check in the checkbox if you want the Log Server to record events for this unit. If the Recording checkbox is checked, the field displays Recording . If the Recording checkbox is not checked, the field displays Paused and events are not recorded. Note: Even if a unit is not the currently selected one, if its Recording checkbox is checked, the Log Server will still record its events.
Address	The IP Address or DNS name that was given to the unit when it was added to the Log Server. (See “Configure” on page 95.)
Port	The Access Port number assigned to the unit.
Connection	<ul style="list-style-type: none"> • If the Log Server is connected to the unit, this field displays Connected. • If the Log Server is not connected, this field displays Waiting. The Log Server's MAC address has not been set properly. Set it on the Device Management Date/Time page on page 67.
Days	The number of days that the unit's log events are kept in the Log Server's database before expiration.
Description	Display the descriptive information given for the unit when it was added to the Log Server.

The Event Panel. The lower panel displays log events for the currently selected unit. Multiple units may be recording if their checkbox is checked even when they aren't currently selected for display. The Log Server records their events and keeps them in its database.

LDAP Server Configuration

Introduction

The KVM switch allows log in authentication and authorization through external programs. To allow authentication and authorization via LDAP or LDAPS, the Active Directory's LDAP Schema must be extended so that an extended attribute name for the KVM switch (Example: iKVM2132P- uuserprofile-) is added as an optional attribute to the person class.



Note: Authentication refers to determining the authenticity of the person logging in. Authorization refers to assigning permission to use the device's various functions.

In order to configure the LDAP server, you will have to complete the following procedures:

1. Install the Windows Server Support Tools
2. Install the Active Directory Schema Snap-in and
3. Extend and Update the Active Directory Schema

Configuring LDAP under Windows 2003 Server.

Install the Windows 2003 Support Tools. To install the Windows 2003 Support Tools:

1. On your Windows Server CD, open the Support >Tools folder.
2. In the right panel of the dialog box that opens, double click **SupTools.msi**.
3. Follow the Installation Wizard to complete the procedure.

Install the Active Directory Schema Snap-in.

1. Open a Command Prompt.
2. Enter: **regsvr32 schmmgmt.dll to register schmmgmt.dll** on your Active Directory computer.
3. Open the Start menu;
Click **Run**.
Enter: **mmc /a**
Click **OK**.
4. On the File menu of the screen that appears, click **Add/Remove Snap-in**; then click **Add**.
5. Under Available Standalone Snap-ins, double click **Active Directory Schema**.
Click **Close**.
Click **OK**.
6. On the screen you are in, open the File menu and click **Save**.
7. For Save in, specify the **C:\Windows\system32** directory.
8. For File name, enter **schmmgmt.msc**.
9. Click **Save** to finish.

Create a Start Menu Shortcut Entry.

1. Right click **Start**. Select Open all Users > Programs > Administrative Tools.
2. On the File menu, select New > Shortcut.
3. In the dialog box that opens, browse to, or enter the path to schmmgmt.msc (C:\Windows\system32\schmmgmt.msc), then click **Next**.
4. In the dialog box that opens, enter **Active Directory Schema** as the name for the shortcut, then click **Finish**.

Extend and Update the Active Directory Schema.

1. Create a new attribute.
2. Extend the object class with the new attribute.
3. Edit the active directory users with the extended schema.

Creating a New Attribute.

1. From the Start menu, open Administrative Tools > Active Directory Schema.
2. In the left panel of the screen that opens, right-click **Attributes**.
3. Select New > Attribute.
4. In the warning message that opens, click **Continue** to open the Create New Attribute dialog box.
5. Fill in the dialog box to match the entries for Description and Common Name shown below, then click **OK** to complete the procedure.



Note: The Unique X500 Object ID uses periods, not commas.

Create New Attribute

Create a New Attribute Object

Identification

Common Name: userprofile

LDAP Display Name: userprofile

Unique X500 Object ID:

Description:

Syntax and Range

Syntax: Unicode String

Minimum: 1

Maximum: 255

Multi-Valued

OK Cancel

Extend the Object Class With the New Attribute.

1. Open the Control Panel > Administrative Tools > Active Directory Schema.
2. In the left panel of the screen that opens, select **Classes**.
3. In the right panel, right-click **person**.
4. Select **Properties**. The person Properties dialog box opens with the General page displayed. Click the **Attributes** tab.
5. On the Attributes page, click **Add**.
6. In the list that opens, select **iKVM2132P-userprofile**, then click **OK** to finish.

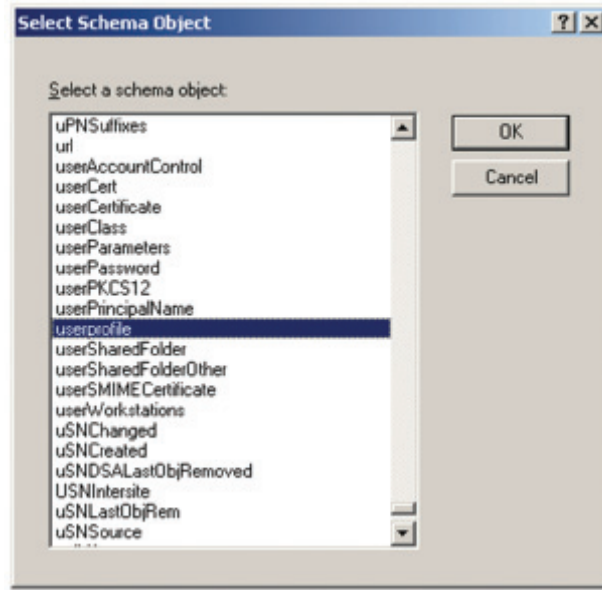

Editing Active Directory Users. To edit Active Directory Users With the Extended Schema:

1. Run ADSI Edit. (Installed as part of the Support Tools.)
2. In the left panel, open Domain, and navigate to the DC=aten,DC=com CN=Users node.
3. In the right panel, locate the user you wish to edit.
4. Right-click on the user's name and select properties.
5. On the Attribute Editor page of the dialog box, select **iKVM4140-userprofile** from the list.

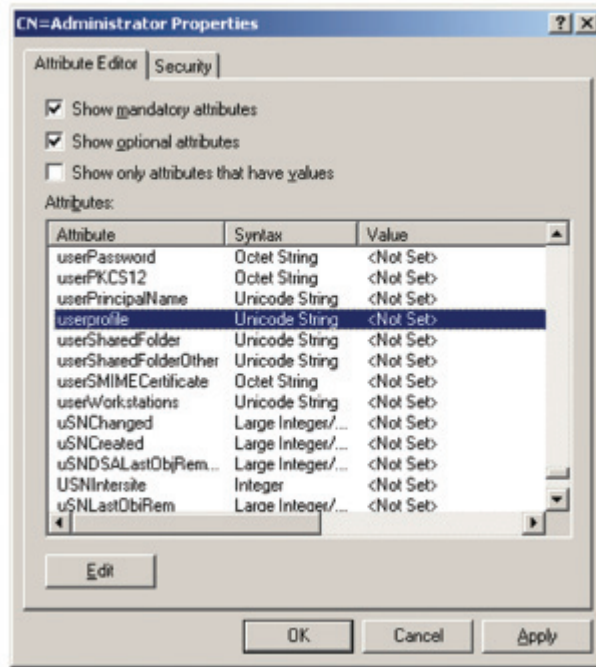

6. Click **Edit** to open the String Attribute Editor:
7. Enter the KVM permission attribute values.



Note: **User** represents the Username of a KVM user whose permissions reflect the permissions you want the new user to have (see “Users” on page 59).

8. Click **OK**. Return to the Attribute Editor page. The **iKVM4140-userprofile** entry now reflects the new permissions. Click **Apply** to save the change and complete the procedure. The new user now has the same permissions as **user**. Repeat to add other users.

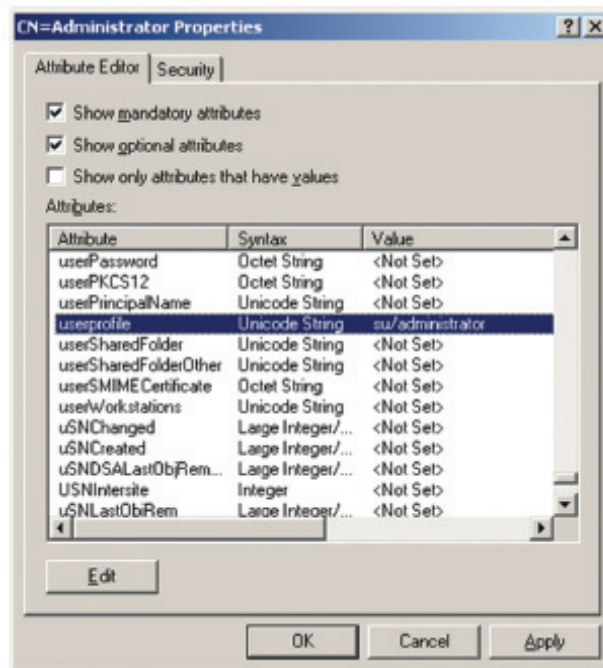

OpenLDAP

OpenLDAP is an Open source LDAP server designed for Unix platforms.

OpenLDAP Server Installation. Download and install the program. The default directory is: c:\Program Files\OpenLDAP.

Select install BDB-tools and install OpenLDAP-slapd as NT service.

OpenLDAP Server Configuration. Customize the main OpenLDAP configuration file, slapd.conf, (in the /OpenLdap directory) before launching the server. Modifications to the configuration file are necessary in order for it to be used with the KVM switch.

- Specify the Unicode data directory. The default is ./ucdata.
- Choose the required LDAP schemas. The core schema is mandatory.
- Configure the path for the OpenLDAP pid and args start up files. The first contains the server pid, the second includes command line arguments.
- Choose the database type. The default is bdb (Berkeley DB).
- Specify the server suffix. All entries in the directory will have this suffix, which represents the root of the directory tree. For example, with suffix dc=apc,dc=com, the fully qualified name of all entries in the database will end with dc=apc,dc=com.
- Define the name of the administrator entry for the server (rootdn), along with its password (rootpw). This is the server's super user. The rootdn name must match the suffix defined above. (Since all entry names must end with the defined suffix, and the rootdn is an entry.)

Starting the OpenLDAP Server. To start the OpenLDAP Server, run slapd (the OpenLDAP Server executable file) from the command line. slapd supports a number of command line options, the most important option is the d switch that triggers debug information. For example, a command of `slapd -d 256` would start OpenLDAP with a debug level of 256.

Customizing the OpenLDAP Schema. The schema that slapd uses may be extended to support additional syntaxes, matching rules, attribute types, and object classes. The User class and the permission attribute are extended to define a new schema to work with the KVM switch.

LDAP DIT Design and LDIF File. LDAP Data Structure. An LDAP Directory stores information in a tree structure known as the Directory Information Tree (DIT). The nodes in the tree are directory entries, and each entry contains information in attribute-value form. The LDAP Data Interchange Format (LDIF) is used to represent LDAP entries in a simple text format. The name of the file is init.ldif and you create it in the /OpenLDAP directory.

Using the New Schema.

1. Save the new schema file in the /OpenLDAP/schema/ directory.
2. Add the new schema to the slapd.conf file (in the /OpenLDAP directory).
3. Restart the LDAP server.
4. Write the LDIF file and create the database entries in init.ldif with the ldapadd command.
Example: ldapadd -f init.ldif -x -D "cn=ldapadmin,dc=aten,dc=com"-w password

Factory Default Settings

Setting	Default
Language	English
GUI Hotkey	[Scroll Lock] [Scroll Lock]
Port ID Display	Port Number + Name
Port ID Display Duration	3 Seconds
Scan Duration	5 Seconds
Screen Blanker	0 Minutes (disabled)
Beeper	On
Viewer	Auto Detect
Welcome Message	Hide
Accessible Ports	<ul style="list-style-type: none">• Super Administrators - Full for all ports• All other users - None for all ports.

Serial Adapter Pin Assignments

KVM KVM2132P / KVM2116P / KVM1116P

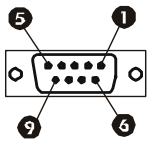
RJ45-F to DB9-M (Black Connector)			DTE to DCE	
(RJ45)	Pins (8)	<----->	Modem/Device (DB9)	
RTS	1	<----->	7	
DTR	2	<----->	4	
TXD	3	<----->	3	
CTS	4	<----->	8	
GND	5	<----->	5	
RXD	6	<----->	2	
DCD	7	<----->	1	
DSR	8	<----->	6	
			9 NC not used	

Supported KVM Switches

Supported KVM switches that can be used in a tiered installation:

- KVM2132P / KVM2116P
 - KVM0216A
- KVM1116P
 - KVM0108A / KVM0116A



Note: 1. Some of the KVM switch's features may not be supported, depending on the functionality of the tiered KVM switch. (For example, KVM0108A / KVM0116A switches do not support virtual media.)

Supported PDUs

KVM2132P / KVM2116P only

Supported PDUs that can be connected to the KVM switch:

- AP79xx
- AP89xx
- AP86xx

Virtual Media Support

WinClient ActiveX Viewer / WinClient AP

- IDE CDROM/DVD-ROM Drives - Read Only
- IDE Hard Drives - Read Only
- USB CDROM/DVD-ROM Drives - Read Only
- USB Hard Drives - Read/Write*
- USB Flash Drives - Read/Write*
- USB Floppy Drives - Read/Write

* These drives can be mounted either as a Drive or as a Removable Disk (see “Virtual Media” on page 32). Removable disks allow the user to boot the remote server if the disk contains a bootable OS. If the disk contains more than one partition, the remote server can access all the partitions.

- ISO Files - Read Only
- Folders - Read/Write

Java Applet Viewer / Java Client AP

- ISO Files - Read Only
- Folders - Read/Write

IP Address Determination

Log in to the KVM switch as administrator the first time and give it an IP address for connection by users. Your client computer must be on the same network segment as the KVM switch. Connect and log in to give the KVM switch its fixed network address.

The Local Console. The easiest way to assign an IP address is from the local console. Refer to “First Time Setup” on page 17, for details on the procedure involved.

IP Installer

For client computers running Windows, an IP address can be assigned with the IP Installer utility. The utility can be obtained from the www.apc.com. Download the utility to your client computer.

1. Unzip the contents of **IPInstaller.zip** to a directory on your hard drive.
2. Go to the directory where you saved the IP Installer program to and run **IPInstaller.exe**. A dialog box will open.
3. Select the KVM switch in the Device List.



Note: 1. If the list is empty, or your device doesn't appear, click **Enumerate** to refresh the Device List.

2. If there is more than one device in the list, use the MAC address to pick the one you want. The KVM switch's MAC address is located on its bottom panel.

4. Select either Obtain an IP address automatically (DHCP), or Specify an IP address. If you chose the latter, fill the IP Address, Subnet Mask, and Gateway fields with the information appropriate to your network.
5. Click **Set IP**.
6. After the IP address shows up in the Device List, click **Exit**.

Browser

1. Set your client computer's IP address to 192.168.0.XXX where XXX represents any number or numbers except 60. (192.168.0.60 is the default address of the KVM switch.)
2. Specify the switch's default IP address (192.168.0.60) in your browser to be able to connect.
3. Assign a fixed IP address for the KVM switch that is suitable for the network segment on which it resides.
4. After logging out, reset your client computer's IP address to its original value.

IPv6

The KVM switch supports three IPv6 address protocols: Link Local IPv6 Address, IPv6 Stateless Autoconfiguration, and Stateful Autoconfiguration (DHCPv6).

Link Local IPv6 Address. The KVM switch is automatically configured with a Link Local IPv6 Address (for example, fe80::210:74ff:fe61:1ef). To find out what the Link Local IPv6 Address is, log in with the KVM switch's IPv4 address and open the Device Management > Device Information page. The address is displayed in the General list box.

Once the IPv6 address has been determined, it can be used when logging in from a browser or the Win and Java Client AP programs. For example: If you are logging in from a browser, enter http://[fe80::2001:74ff:fe6e:59%5] for the URL bar. If you are logging in with the AP program, enter: fe80::2001:74ff:fe6e:59%5 for the IP field of the Server panel.



- Note:**
1. To log in with the Link Local IPv6 Address, the client computer must be on the same local network segment as the KVM switch.
 2. The %5 is the %interface used by the client computer. To see your client computer's IPv6 address: from the command line issue the following command: ipconfig /all. The % value appears at the end of the IPv6 address.

IPv6 Stateless Autoconfiguration. If the KVM switch's network environment contains a device (such as a router) that supports the IPv6 Stateless Autoconfiguration function, the KVM switch can obtain its prefix information from that device in order to generate its IPv6 address. For example, 2001::74ff:fe6e:59.

The address is displayed in the General list box of the Device Management > Device Information page. Once the IPv6 address has been determined, it can be used when logging in from a browser or the Win and Java Client AP programs. For example: If you are logging in from a browser, enter http://[2001::74ff:fe6e:59] for the URL bar. If you are logging in with the AP program, you would enter: 2001::74ff:fe6e:59 for the IP field of the Server panel (see “Windows Client AP Login” on page 20).

Port Forwarding

For devices located behind a router, port forwarding allows the router to pass data coming in over a specific port to a specific device. By setting the port forwarding parameters, you tell the router to which device the data that comes in over a particular port is sent.

For example, if the KVM switch has an IP address of 192.168.1.180, log into your router's setup program and access the Port Forwarding (sometimes referred to as Virtual Server) configuration page. Specify 192.168.1.180 for the IP address and the port number you want opened for it (9000 for internet access, for example).

Configuration setup can vary. Refer to the router's User Manual for specific information on configuring port forwarding.

PPP Modem Operation

An external modem (customer supplied) is used with the KVM switch. An APC serial adapter (provided) connects the switch to the modem.

Basic Setup. The KVM switch can be accessed through its RS-232 port using a PPP dial-in connection:

1. Set up your hardware configuration to match the diagram:

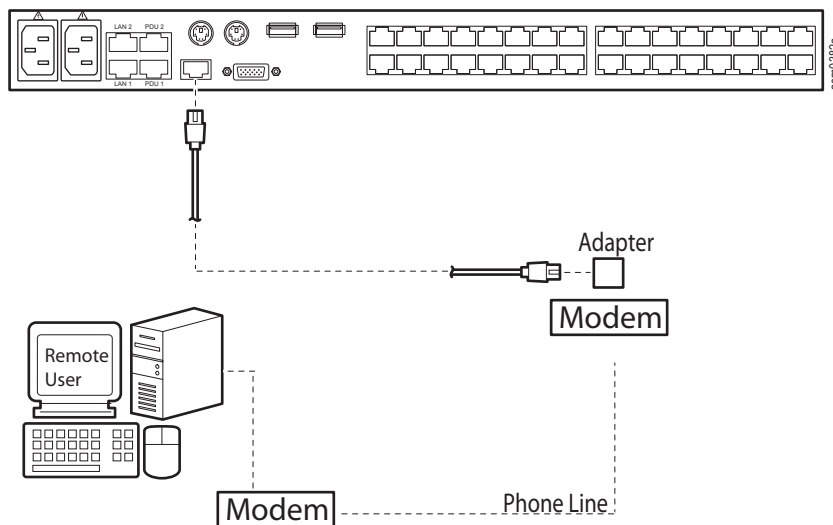

2. From your client computer, use your modem dial-in program to dial into the KVM switch's modem.



Note: If you don't know the KVM switch modem's serial parameters, get them from the KVM administrator.

3. Once a connection is established, open your browser, and specify 192.168.192.1 in the URL box.
4. The default username and password are blank.
5. For the modem session, the KVM switch has an IP address of 192.168.192.1; the user side has an IP address of 192.168.192.101.
6. From here, operation is the same as if you had logged in from a browser or with the AP programs.

Connection Setup Example (Windows XP)

To set up a dial-in connection to the KVM switch under Windows XP:

1. From the Start menu, select Control Panel > Network Connections > Create a New Connection.
2. When the Welcome to the New Connection Wizard dialog box opens, click **Next**.
3. In the Network Connection Type dialog box, select **Connect to the network at my workplace**, then click **Next**.
4. In the Network Connection dialog box, select Dial-up connection, then click **Next**.
5. In the Connection Name dialog box, key in a name for the connection (Example: TPE-KVM2132P-01), then click **Next**.
6. In the Connection Availability dialog box, select **Anyone's use** or **My use only**, then click **Next**. If you are the only user on this client computer, this dialog box will not appear.
7. In the Phone Number to dial dialog box, enter the phone number of the modem connected to the KVM switch (include country and area codes, if necessary), then click **Next**.
8. In the Completing the New Connection Wizard dialog box, check **Add a shortcut** to this connection on my desktop, then click **Finish**. This completes the connection setup. Double click the desktop shortcut icon to make a PPP connection to the KVM switch.

Additional Mouse Synchronization Procedures

To use Manual Mouse Synchronization, perform the following operations on the servers that connect to the switch.



- Note:** 1. These procedures are performed on the servers attached to the switch's ports, not on the client computer you are using to access the KVM switch.
2. In order for the local and remote mice to synchronize, use the generic mouse driver supplied with the Windows operating system. Third party drivers (supplied by the mouse manufacturer) must be removed.

Windows.

1. Windows 2000:
 - a. Open the Mouse Properties dialog box (Control Panel > Mouse > Mouse Properties)
 - b. Click the **Motion** tab
 - c. Set the mouse speed to the middle position (6 units in from the left)
 - d. Set the mouse acceleration to **None**
2. Windows XP / Windows Server 2003:
 - a. Open the Mouse Properties dialog box (Control Panel > Mouse).
 - b. Click the **Pointer Options** tab.
 - c. Set the mouse speed to the middle position (6 units in from the left).
 - d. Disable **Enhance Pointer Precision**.
3. Windows ME: Set the mouse speed to the middle position; disable mouse acceleration (click **Advanced** to open the dialog box).
4. Windows NT / Windows 98 / Windows 95: Set the mouse speed to the slowest position.

Sun / Linux. Open a terminal session and issue the following command:

Sun: **xset m 1**

Linux: **xset m 0** or **xset m 1** (If one doesn't help, try the other.)

Linux using the Redhat AS3.0 mouse mode: **xset m 1**

Fan Location and Speed Information

KVM2132P / KVM2116P only

Fan Location

The KVM switch has 4 fans that feed realtime fan speed information to the WinClient / Java Client Device Management page. The fan speed is shown on the Device Information web page.

Fan Speed

Fan speed automatically adjusts according to temperature as follows:

- If any sensor senses that the temperature is greater than 32° C, all fans spin at half speed .
- If any sensor senses that the temperature is greater than 45° C, all fans spin at full speed.
- When all four sensors sense that the temperature is less than 40° C, all fans return to half speed.
- When all four sensors sense that the temperature is less than 30° C, all fans turn off.



Note: Fan half speed equals 2500 rpm. Fan full speed equals 5000 rpm.

Temperature Sensor Location and Information

KVM2132P / KVM2116P only

The KVM switch has 4 temperature sensors on its mainboard that feed realtime temperature updates to the WinClient / Java Client Device Management page. See Device Information, Temperature on page 67 for more information.



Note: The temperature inside the case can be higher than the ambient temperature (0-50° C). IC chips can tolerate temperatures of up to 105°C. If the temperature reading rises past 85° C, make the ambient temperature cooler or, shut the switch down until it cools off.

KVM-SERIAL Server Module Configuration and Operation

The KVM-SERIAL cable connects a serial device to the KVM switch.

Configuration

To configure the KVM-SERIAL Server Module to interact with the connected device, set its serial parameters to match the parameters of the device:

1. In the Port Access page Sidebar, select the port to which the KVM-SERIAL Server Module is connected.
2. Select **Port Configuration** on the menu bar. The page opens with the Port Properties tab selected.

3. In the Properties section, select the port property values that match those used by the connected serial console device.

The Module supports these port property settings:

Setting	Meaning
Bits per second (Baud Rate)	Sets the port's data transfer speed. Choices are from 300-38400 (drop down the list to see them all). Set this to match the baud rate setting of the serial console device. Default is 9600 (which is a basic setting for many serial console devices).
Data Bits	Sets the number of bits used to transmit one character of data. Choices are: 7 and 8. Set this to match the data bit setting of the serial console device. Default is 8 (which is the default for the majority of serial console devices).
Parity	Checks the integrity of the transmitted data. Choices are: None; Odd; Even. Set this to match the parity setting of the serial console device. Default is Odd.
Stop Bits	Indicates that a character has been transmitted. Set this to match the stop bit setting of the serial console device. Choices are: 1 and 2. Default is 1 (which is the default for the majority of serial console devices).
Flow Control	Choose how the data flow will be controlled. Choices are: None, Hardware, and XON/XOFF. Set this to match the flow control setting of the serial console device. Default is None. Note: None is only supported for baud rates of 9600 and lower. For baud rates greater than 9600, you must choose Hardware or XON/XOFF.
Access Mode	Set the serial console device's access mode. Choices are: Share, Occupy, and Exclusive. Default is Share. See "Access Mode" on page 39 for information regarding this function.

4. When you have finished making your selections, click **Save**.

Operation

To operate the device connected to the port, in the Port Access page double click the port to establish a serial connection to the device.

Internal Serial Interface Configuration

To configure an attached device's serial interface parameters from within any accessed server.

1. From the accessed server, open a command line (terminal) session or third party serial application such as HypterTerminal or PuTTY.
2. Telnet or SSH to the KVM switch's IP address.
3. Log in with your usual Username and Password to bring up the access screen.

Navigation

The left panel shows the KVM switch at the top, and all the serial interface devices connected to it listed below. The right panel shows the configuration parameters at the top, with the configuration settings in the area below.

Use the **Left** and **Right Arrow** keys to move the highlight bar between the right and left panels and to select the parameter to configure.

Use the **Up** and **Down Arrow** keys to select among the switch and the serial devices in the left panel and to select the configuration items in the right panel.

Operation

Use the **Up** and **Down Arrow** keys to highlight a device in the left panel, then press [ENTER] to open a command line (terminal) session on the accessed device.

When you have finished with your session, press the hotkey (see page 111) that brings you back to the access page.

To finish with this function, move the highlight bar to Logout in the right panel of the access page; Press the **Down Arrow** key to highlight **Exit**, then press [ENTER].

Switch Level Configuration

The configuration settings that are available when the KVM switch is selected in the left panel are:

Setting	Description
Port Configuration	When Port Configuration is selected, press the Down Arrow key to highlight the current timeout setting. Enter a new timeout number to overwrite the current one. Note: There is no way to erase the number entered. To change it, use the Up Arrow key to leave the field then use the Down Arrow to come back to it. After you come back, enter the new number. When you have finished, use the Down Arrow to highlight Save , then press [ENTER].
User Preference	Set a hotkey that brings you back to the access screen from the session you are working in. When User Preferences is selected, press the Down Arrow key to highlight the current hotkey letter. Enter the new letter to overwrite the current one. When you have finished, use the Down Arrow to highlight Save , then press [ENTER].
Logout	When Logout is selected, press the Down Arrow key to highlight Exit , then press [ENTER].

Port Level Configuration

The configuration settings that can be made when a serial interface device is selected:

Setting	Description
Port Configuration	To configure the serial parameters: 1. Use the Up and Down Arrow keys to highlight the target item. 2. Press [ENTER] to open the list of choices. 3. Use the Up and Down Arrow keys to highlight your choice, then press [ENTER]. When you have finished, press the Down Arrow key to highlight Save , then press [ENTER].
User Preference	Set a hotkey that brings you back to the access screen from the session you are working in. When User Preferences is selected, press the Down Arrow key to highlight the current hotkey letter. Enter the new letter to overwrite the current one. When you have finished, use the Down Arrow to highlight Save , then press [ENTER].
Logout	When Logout is selected, press the Down Arrow key to highlight Exit , then press [ENTER].

Trusted Certificates

Overview

When you try to log in to the device from your browser, a Security Alert message appears to inform you that the device's certificate is not trusted, and asks if you want to proceed.

The certificate can be trusted, but the alert is triggered because the certificate's name is not found on the Microsoft list of Trusted Authorities. You have two options. You can ignore the warning and click **Yes** to go on or you can install the certificate and have it be recognized as trusted.

If you are working on a client computer at another location, accept the certificate for just this session by clicking **Yes**.

If you are working at your own client computer, install the certificate on your client computer. After the certificate is installed, it will be recognized as trusted.

Installing the Certificate

1. In the Security Alert dialog box, click **View Certificate** to open the Certificate Information dialog box.



Note: There is a red and white X logo over the certificate to indicate that it is not trusted.

2. Click **Install Certificate**.
3. Follow the Installation Wizard to complete the installation. Unless you have a specific reason to choose otherwise, accept the default options.
4. When the Wizard presents a caution screen, click **Yes**.
5. Click **Finish** to complete the installation, then click **OK** to close the dialog box

Certificate Trusted. Click **View Certificate**, to see that the red and white X logo is no longer present.

Mismatch Considerations. If the site name or IP address used for generating the certificate no longer matches the current address of the switch a mismatch warning opens. Click **Yes** to go on, or disable mismatch checking. To disable mismatch checking:

1. After the page you are logging in to comes up, open the browser's Tools menu. Select Internet Options > Advanced.
2. Scroll to the bottom of the list and uncheck **Warn about trusted certificates**.
3. Click **OK**. The next time the browser is opened, the change will be in effect.

Self-Signed Private Certificates

To create your private key and certificate:

1. To create a self signed certificate, you will first need to create a Certificate Signing Request (CSR). See "Certificate Signing Request" on page 79 for details.
2. Downloaded openssl.exe and save it to \OpenSSL\bin on your hard drive.
 - Create the SSL certificate using OpenSSL. OpenSSL 1.0.0d was tested and is available from <http://www.openssl.org> for Unix based systems. A Windows based version is located at the following website: <http://www.openssl.org/related/binaries.html>. No other programs I work for creating SSL certificates for the KVM Switches.

3. Save the CSR from the KVM. (Save the csr.cer into the OpenSSL installation folder \OpenSSL\bin)
4. Move the directory "demoCA" into "bin" within the OpenSSL installation directory and add directory "newcerts" in "demoCA"
5. Under the command prompt window, change the directory to \OpenSSL\bin and execute the following commands in the command prompt:
 - a. openssl req -new -newkey rsa:1024 -days 3365 -nodes -x509 -keyout ca.key -out ca.cer
 - b. openssl.exe ca -policy policy_anything -config openssl.cfg -cert ca.cer -in csr.cer -keyfile ca.key -days 360 -out new.cer



- Note:** 1. Commands should be entered all on one line. (Do not press [ENTER] until all the parameters have been entered).
2. If there are spaces in the input, surround the entry in quotes. Example: (apc by schneider-electric).

To avoid having to input information during key generation the following additional parameters can be used: /C /ST /L /O /OU /CN /emailAddress.

Parameter	Definition	Max characters	Example
/C	Country:	2	US
/ST	State or Province	32	Missouri
/L	Locality	32	St. Louis
/O	Organization:	64	Your Company, Ltd.
/OU	Unit:	32	Techdoc Department
/CN	Common Name:	32	mycompany.com Note: This must be the exact domain name of the site that you want the certificate to be valid for. If the site's domain name is www.mycompany.com, and you only specify mycompany.com, the certificate will not be valid.
/emailAddress	Email Address:	64	administrator@yourcompany.com

Importing the Files. After the openssl.exe program completes, two files, CA.key (the private key) and CA.cer (the self-signed SSL certificate), are created in the directory. These are the files that you upload in the Private Certificate panel of the Security page (see "Security" on page 75, and "Private Certificate" on page 78).

If you encounter "Failed to update database, TXT_DB error number 2," you will need to edit a text file in the OpenSSL program directory before continuing. The file "index.txt.attr" in the "demoCA" directory will be generated after you run command "b" from step 4 above for the first time. Please edit it to "unique_subject = no". The error should be solved. You should be able to run command "b" over and over again with the certificate logged in "index.txt" for the same subject.

In order to upload the self signed certificate to the KVM switch, login to the KVM Switch and navigate to Device Management->Security->Private Certificate section and click "Browse" next to private key. Browse to the OpenSSL program directory and within the "bin" folder, choose "ca.key." Click "Browse" next to Certificate and find "ca.cer." Press Open and then Upload. You should receive a message saying Operation Succeeded.

Troubleshooting

General Operation

Problem	Resolution
Erratic Operation	Start the KVM switch before any tiered switches. 1. Power it on before powering on tiered switches. 2. If the tiered switch was started before the KVM switch, reset or restart the tiered switch. Press and release the Reset switch (see “Reset Switch” on page 7).
I have been given an account but I am unable to log in.	1. Make sure your Username and Password are correctly specified. 2. Make sure that you have the necessary permission to access the switch. 3. Ask if the switch is under KVM Access management. If it is, the administrator will have to disable KVM Access management on the switch (page 70), or deselect it on the KVM Access server (see the KVM Access User Manual for details).
I can't access the switch, even though I have specified the IP address and port number correctly.	If the switch is behind a router, the router's Port Forwarding (also referred to as Virtual Server) feature must be configured. See “Port Forwarding” on page 106 for details.
When logging in from a browser, the following message appears: 404 Object Not Found.	If a login string has been set, make sure to include the forward slash and correct login string when you specify the KVM switch's IP address. (See “Login String” on page 76.)
Sudden loss of network connection.	Close your connection to the KVM switch. Wait about 30 seconds, and log in again.
No remote server video display on the client computer.	Check that your KVM Adapter Cable's firmware version is the same as the version stored in the switch's Main firmware. See “Adapter Firmware Upgrade” on page 92 for details. Set the remote server resolution to 1280 x 1024 or less.
No remote server video display on the client computer, but mouse movements appear on the local console and mouse clicks have no effect	Press and release the left Alt key, then press and release the right Alt key
The display on the client computer is distorted and performing an Autosync doesn't resolve the problem.	Switch ports to a port with a different resolution, then switch back. If that does not resolve the problem, change the resolution and refresh rate for the system running on the port. Afterward, you can run at the new resolution, or switch back to the original resolution.
The Lock Key LEDs on the Control Panel don't accurately reflect the actual locked status of my keyboard input.	Click the LEDs on the Control Panel until they match your keyboard. Afterward, when you change them from the keyboard they will change on the Control Panel.
When I log in, the browser generates a CA Root certificate is not trusted, or a Certificate Error response.	The certificate's name is not found on Microsoft's list of Trusted Authorities. The certificate can be trusted. See “Trusted Certificates” on page 112 for more information.
In multiuser operation I had exclusive (or occupy) rights on the port I was viewing. After I recalled the Port Access page and came back to the port I was occupying, it had been taken over by another user. Why did this happen?	If you try to return to the port by selecting again in the tree, the switch acts as if you are accessing the port for the first time. If another user was waiting on the port, he takes precedence and gets the port. The correct way to return to the port is to click the Close icon at the top right of the Port Access page.

Mouse Problems

Problem	Resolution
Mouse and/or Keyboard not responding	Check that your KVM Adapter Cable's firmware version is the same as the version stored in the switch's Main firmware. See "Adapter Firmware Upgrade" on page 92 for details Unplug the cable(s) from the console port(s), then plug it/ them back in.
Mouse movement extremely slow	There is too much data being transferred for your connection to keep up with. Lower the video quality (see "Video Settings" on page 30) so that less video data is transmitted.
There are two mouse pointers after the remote server is accessed.	You can select another pointer type. See "Mouse Pointer Type" on page 34 for details
When the mouse pointer is in Single Pointer mode, I can't access the Control Panel.	Recall the Control Panel and immediately change the pointer to Dual mode.
Why is there a Dual Pointer mode?	When you are not in Mouse DynaSync Mode, you need the two pointers so that you know the remote server pointer is actually at the location you think it is at. Otherwise, you might perform a mouse operation and because of net lag the remote server pointer may not be at the location that your client computer pointer is at.
Mouse pointer confusion	If you find the display of two mouse pointers (local and remote) to be confusing or annoying, you can use the Toggle Mouse Display function to shrink the non-functioning pointer. See "Toggle mouse display" on page 28, and "Mouse Pointer Type" on page 34.
When I log in with my Windows system, the local and remote mouse pointers do not sync.	<ol style="list-style-type: none"> 1. Check the status of the Mouse Sync Mode setting (see "Mouse DynaSync Mode" on page 34). If it is set to Automatic, change the setting to Manual and refer to the information for "Manual Mouse Synchronization" on page 35. 2. If you are in Manual mode, use the AutoSync feature (see "Video Settings" on page 30), to sync the local and remote monitors. 3. If that doesn't resolve the problem, use the Adjust Mouse feature (page 28) to bring the pointers back in step. 4. If the above fails to resolve the problem, refer to "Additional Mouse Synchronization Procedures" on page 108, for further details.
When I log in with my Mac system, the local and remote mouse pointers do not sync.	There are two automatic Mouse DynaSync settings: the default, and Mac2. If mouse synchronization is not satisfactory with the default, try the Mac 2 setting.
When I log in with my Sun system, the local and remote mouse pointers do not sync	Automatic Mouse DynaSync sync only supports USB mice on Windows and Mac (G4 or higher) systems. You must sync the pointers manually. See "Mouse DynaSync Mode" on page 34, and "Manual Mouse Synchronization" on page 35 for further details. After doing the above, refer to Sun / Linux, page 108.
When I log in with my Linux system, the local and remote mouse pointers do not sync.	Automatic Mouse DynaSync sync only supports USB mice on Windows and Mac (G4 or higher) systems. You must sync the pointers manually. See "Mouse DynaSync Mode" on page 34, "Manual Mouse Synchronization" on page 35, and Mac and Linux Considerations, page 35, for further details. After doing the above, refer to Sun / Linux, page 108, (under Additional Mouse Synchronization Procedures), for further details.

Virtual Media

Problem	Resolution
Virtual Media doesn't work.	The remote server's mainboard does not support USB. If there is a newer firmware and BIOS version for the remote server's mainboard - one that supports USB - get it from the manufacturer and upgrade the server's mainboard firmware and BIOS.
There is no Virtual Media icon on my Control Panel.	1. Virtual Media only supports devices connected with KVM-USBVM, KVM-USBVMCAC, KVM-PS2VMKA7175 or KA7176 KVM Adapter Cable Server Modules. 2. You must be have Administrator privileges on your client computer. (This is a Windows limitation.)
I can't boot my remote server from my Virtual Media drive.	Your remote server's BIOS doesn't support booting from a USB drive. Get the latest firmware and BIOS version for your mainboard from the manufacturer and upgrade your mainboard BIOS.
If I connect a USB floppy drive to a remote server, it can boot the remote server. But, if I map it to the remote server as a Virtual Media drive, it cannot boot the remote server.	USB floppy drives have two types of format: UFI and CBI. Both can be used for OS level virtual media functions, but currently only UFI is supported for BIOS level (such as boot) functions.
I cannot mount a Folder as a Virtual Media device.	If the actual Folder is formatted with the FAT16 file system, it cannot be mounted if its size exceeds 2GB.

Web Browser

Problem	Resolution
After upgrading the firmware, after logging in with my web browser, the switch appears to still be using the old firmware version.	The switch is using the new firmware version but the browser is displaying a page that is stored in its cache. Log out and clear your browser's cache. <ul style="list-style-type: none"> • IE: Tools > Internet Options > Temporary Internet Files > Delete Files • Firefox: Tools > Clear Private Data
Firefox only opens the Java Applet Viewer. It doesn't open the WinClient ActiveX Viewer.	The WinClient ActiveX Viewer requires ActiveX. Since Firefox doesn't support ActiveX only the Java Applet Viewer is available.

The WinClient ActiveX Viewer and the WinClient AP

Problem	Resolution
My KVM switches don't show up in the Server List window when I start the WinClient AP program.	Only units whose Access Port settings for Program (see page 151) match the number specified for Port in the Server area of this dialog box appear in the Server List window. Make sure that your entry for Port matches the entry you have specified for Program on the Device Management Network page.
The WinClient ActiveX Viewer and the WinClient AP won't connect to the KVM switch.	DirectX 8.0 or higher must be installed on your client computer.
After upgrading the firmware, the WinClient ActiveX Viewer or WinClient AP do not run.	The old version of your .ocx file was not deleted. You must delete the old file. There are two methods to delete the file. <ol style="list-style-type: none"> 1. For the ActiveX Viewer: Open IE >Tools > Manage Add-ons. Delete or disable all occurrences of WinClient. 2. For the WinClient AP: Open Explorer and search for WinClient.ocx. Delete all occurrences.

Part of the remote window is off my monitor	<ol style="list-style-type: none"> 1. Perform an Auto Sync (see “WinClient Control Panel Functions” on page 26 for details). 2. If Keep Screen Size is not enabled (see “Screen Options” on page 35), use the AutoSync feature (see “Video Settings” on page 30), to sync the local and remote monitors. 3. If Keep Screen Size is enabled, you can scroll to the areas that are off screen.
The remote screen is rotated 90 degrees.	Enable Keep Screen Size (see “Control Panel Configuration” on page 35).
I cannot run Net Meeting when the WinClient is running.	Enable Keep Screen Size (see “Control Panel Configuration” on page 35).
After logging in I can't open the WinClient ActiveX viewer.	<ol style="list-style-type: none"> 1. You don't have the authority to install the WinClient Control add-on on your client computer. Have the administrator run the program the first time to get it installed. It will open for you after that. 2. Under Vista, you must also add the switch's URL Options>Security>Trusted Sites>Sites.
Under Vista, after I open viewer and try to mount an open driver or removable disk, I get a “Driver not ready” message.	<p>This is a result of Vista's UAC (User Account Control).</p> <ol style="list-style-type: none"> 1. If you are your client computer's administrator, right click the browser icon and choose Run as. Then, choose to run the browser with the administrator account. 2. If you are not your client computer's administrator, you must ask the administrator to disable UAC.

The Java Applet and Java Client AP

Problem	Resolution
I can't connect to the KVM switch.	<ol style="list-style-type: none"> 1. The latest Java version must be installed on your client computer. 2. Check if you need to specify the Program port along with the IP address. See "Java Client AP Login" on page 21 for details 3. Close Java reopen it, and try again.
I have installed the latest Java JRE, but I am having performance and stability problems.	There may be issues with the latest version because it is so new. Try using a Java version that is one or two versions earlier than the latest one.
After upgrading the firmware, after logging in with the Java Applet Viewer or the Java Client AP, the switch appears to still be using the old firmware version.	<p>Log out. Delete your Java temporary internet files as follows:</p> <ul style="list-style-type: none"> • 1. Open Control Panel > Java. • 2. In the Temporary Internet Files section, click Settings. • 3. In the Disk Space section, click Delete Files. • 4. In the dialog box that comes up, click OK.
The national language characters that I input do not appear.	Change the keyboard language of your client computer to English-UK. Use the KVM switch's On-Screen Keyboard and set the on-screen keyboard to the same language that the other system is using.
Java performance deteriorates.	Exit the program and start again.
Pressing the Windows Menu key has no effect.	Java doesn't support the Windows Menu key.
When I try to add a folder to be mounted as a virtual media drive, I can't select the folder. My only choice is Desktop.	In the folder selection entry field, enter the root directory of the folder you want to add. After that, the folders contained under the root directory will display. You can now navigate to the folder you want.

Sun Systems

Problem	Resolution
Video display problems with interface systems(e.g. Sun Blade 1000servers).*	<p>The display resolution should be set to 1024 x 768 @60Hz:HDB15</p> <p>Under Text Mode: Go to OK mode and issue the following command: setenv output-device screen:r1024x768x60reset-all</p> <p>Under XWindow:</p> <ol style="list-style-type: none"> 1. Open a console and issue the following command: m64config -res 1024x768x60 2. Log out 3. Log in
Video display problems with interface systems(e.g. Sun Ultra servers).*	<p>The display resolution should be set to 1024 x 768 @ 13W3 60Hz:</p> <p>Under Text Mode: Go to OK mode and issue the following command:setenv output-device screen:r1024x768x60reset-all</p> <p>Under XWindow:</p> <ol style="list-style-type: none"> 1. Open a console and issue the following command: fbconfig -res 1024x768x60 2. Log out 3. Log in
* These solutions work for most common Sun VGA cards. If using them fails to resolve the problem, consult the Sun VGA card's manual.	

Mac Systems

Problem	Resolution
When I log in to the KVM switch with my Safari browser, it hangs when I use the Snapshot feature.	Force close Safari, then reopen it. Don't use the Snapshot feature until you upgrade to Mac OS 10.4.11 and Safari 3.0.4.

Redhat Systems

Problem	Resolution
With Redhat 9.0 (2.4.20-8) installed as server, the keyboard and mouse aren't working normally with the console modules.	Choose the AS3.0 setting for your mouse synchronization mode. See Mac and Linux Considerations, page 80 for details
With Redhat 9.0 (2.4.20-8) installed a desktop system, the keyboard and mouse aren't working normally with the console modules.	First, plug your keyboard and mouse into a USB 2.0 hub, then plug the hub into the Redhat 9.0 server.

The Log Server

Problem	Resolution
The Log Server program does not run.	<ul style="list-style-type: none">• The Log Server requires the Microsoft Jet OLEDB 4.0 driver in order to access the database. This driver is automatically installed with Windows ME, 2000 and XP.• For Windows 98 or NT, go to the Microsoft download site: http://www.microsoft.com and search for MDAC to retrieve the driver file: MDAC 2.7 RTM Refresh (2.70.9001.0)• Since this driver is used in Windows Office Suite, an alternate method of obtaining it is to install Windows Office Suite. Once the driver file or Suite has been installed, the Log Server will run.

Panel-Array Mode

Problem	Resolution
Low resolution video - the screens don't display clearly.	This can occur due to the screens being scaled to fit in the panels. Decrease the number of panels that are displayed.
When multiple remote users are logged in, some of them only receive a partial image.	The first user to invoke Panel Array Mode should set it to display at least four panels.
When I try to move forward or backward one port, the display sometimes moves forward two ports or remains on the original port.	<ul style="list-style-type: none">• This can occur due to a net lag problem. The array automatically moves through the ports at a pre-selected time. By the time it gets your input, it has already moved forward a port on its own - but that hasn't shown up on your display as yet. When it moves ahead or back due to your input, it appears to have moved two ports (from its own movement plus your "forward one port" command), or remains on the original port (from its own forward movement plus your "back one port" command).

Specifications

KVM2132P / KVM2116P / KVM1116A

Function		KVM2132P	KVM2116P	KVM1116A	
Computer Connections	Direct	32	16	16	
	Max	8192	4096	256	
	Local	1	1	1	
	Remote	2	2	1	
Connectors	Console Port	Keyboard	1 x 6-pin Mini-DIN Female (Purple) 1 x USB Type A Female (Black)	1 x 6-pin Mini-DIN Female (Purple) 1 x USB Type A Female (Black)	1 x 6-pin Mini-DIN Female (Purple) 1 x USB Type A Female (Black)
		Video	1 x HDB 15 Female (Blue)	1 x HDB 15 Female (Blue)	1 x HDB 15 Female (Blue)
		Mouse	1 x 6-pin Mini-DIN Female (Green) 1 x USB Type A Female (Black)	1 x 6-pin Mini-DIN Female (Green) 1 x USB Type A Female (Black)	1 x 6-pin Mini-DIN Female (Green) 1 x USB Type A Female (Black)
	KVM Port		32 x RJ-45 Female (Black)	16 x RJ-45 Female (Black)	16 x RJ-45 Female (Black)
	Power		2 x IEC C14	2 x IEC C14	1 x IEC C14
	PDU		2 x RJ-45 Female (Black)	2 x RJ-45 Female (Black)	1 x RJ-45 Female (Black)
	LAN		2 x RJ-45 Female (Black)	2 x RJ-45 Female (Black)	2 x RJ-45 Female (Black)
	Virtual Media USB		3 x USB Type A Female (Black)	3 x USB Type A Female (Black)	3 x USB Type A Female (Black)
Switches	Reset	1 x recessed Pushbutton	1 x recessed Pushbutton	1 x recessed Pushbutton	
LEDs	Port	32 (Green/Red/Orange)	16 (Green/Red/Orange)	16 (Green/Red/Orange)	
	Power	1 (Blue)	1 (Blue)	1 (Blue)	
	LAN	2 (Green/Red/Orange)	2 (Green/Red/Orange)	1 (Green/Red/Orange)	
Emulation	Keyboard/Mouse	PS/2 / USB / Serial	PS/2 / USB / Serial	PS/2 / USB / Serial	
Video		1600x1200 @ 60Hz	1600x1200 @ 60Hz	1600x1200 @ 60Hz	
Scan Interval		1-255 secs	1-255 secs	1-255 secs	
I/P Rating		100-240VAC; 50-60Hz; 1.0A	100-240VAC; 50-60Hz; 1.0A	100-240VAC; 50-60Hz; 1.0A	
Power Consumption		25.9W	25.9W	15.6W	
Environment	Operating Temp.	32°F - 122°F (0 - 50°C)	32°F - 122°F (0 - 50°C)	32°F - 122°F (0 - 50°C)	
	Storage Temp.	-4°F - 140°F (-20°C to 60°C)	-4°F - 140°F (-20°C to 60°C)	-4°F - 140°F (-20°C to 60°C)	
	Humidity	0 - 80% RH, Non-condensing	0 - 80% RH, Non-condensing	0 - 80% RH, Non-condensing	
Physical Properties	Housing	Metal	Metal	Metal	
	Weight/Shipping Weight	3.6 kg/5.1 kg	3.6 kg/5.1 kg	2.6 kg/4 kg	
	Dimensions L x W x H	42.4 x 23.8 x 4.25 cm (19" 1U)	42.4 x 23.8 x 4.25 cm (19" 1U)	42.4 x 18.8 x 4.25 cm (19" 1U)	

Radio Frequency Interference



Changes or modifications to this unit not expressly approved by the party responsible for compliance could void the user's authority to operate this equipment.

USA—FCC

This equipment has been tested and found to comply with the limits for a Class A digital device, pursuant to part 15 of the FCC Rules. These limits are designed to provide reasonable protection against harmful interference when the equipment is operated in a commercial environment. This equipment generates, uses, and can radiate radio frequency energy and, if not installed and used in accordance with this user manual, may cause harmful interference to radio communications. Operation of this equipment in a residential area is likely to cause harmful interference. The user will bear sole responsibility for correcting such interference.

Canada—ICES

This Class A digital apparatus complies with Canadian ICES-003.

Cet appareil numérique de la classe A est conforme à la norme NMB-003 du Canada.

Japan—VCCI

This is a Class A product based on the standard of the Voluntary Control Council for Interference by Information Technology Equipment (VCCI). If this equipment is used in a domestic environment, radio disturbance may occur, in which case, the user may be required to take corrective actions.

この装置は、情報処理装置等電波障害自主規制協議会（VCCI）の基準に基づくクラス A 情報技術装置です。この装置を家庭環境で使用すると、電波妨害を引き起こすことがあります。この場合には、使用者が適切な対策を講ずるよう要求されることがあります。

Taiwan—BSMI

警告使用者：
這是甲類的資訊產品，在居住的環境中使用時，可能會造成射頻干擾，在這種情況下，使用者會被要求採取某些適當的對策。

APC Worldwide Customer Support

Customer support for this or any other APC product is available at no charge in any of the following ways:

- Visit the APC Web site to access documents in the APC Knowledge Base and to submit customer support requests.
 - **www.apc.com** (Corporate Headquarters)
Connect to localized APC Web sites for specific countries, each of which provides customer support information.
 - **www.apc.com/support/**
Global support searching APC Knowledge Base and using e-support.
- Contact the APC Customer Support Center by telephone or e-mail.
 - Local, country-specific centers: go to **www.apc.com/support/contact** for contact information.

For information on how to obtain local customer support, contact the APC representative or other distributors from whom you purchased your APC product.

© 2011 APC by Schneider Electric. APC, and the APC logo are owned by Schneider Electric Industries S.A.S., American Power Conversion Corporation, or their affiliated companies. All other trademarks are property of their respective owners.

Free Manuals Download Website

<http://myh66.com>

<http://usermanuals.us>

<http://www.somanuals.com>

<http://www.4manuals.cc>

<http://www.manual-lib.com>

<http://www.404manual.com>

<http://www.luxmanual.com>

<http://aubethermostatmanual.com>

Golf course search by state

<http://golfingnear.com>

Email search by domain

<http://emailbydomain.com>

Auto manuals search

<http://auto.somanuals.com>

TV manuals search

<http://tv.somanuals.com>