

Schwinn®

hope™



**Gas-powered Scooter
Model 50CA06PK**

⚠ WARNING

- **READ ALL WARNINGS AND ASSEMBLY/USE INSTRUCTIONS. KEEP THIS MANUAL WITH THE SCOOTER FOR FUTURE REFERENCE.**
- **SEVERE INJURY OR DEATH** can result if you do not follow the instructions in this manual.
- **Age range for use: 16 years and up. Maximum loading: 225 lbs. (102 kg).**
- **ALWAYS** wear a Department of Transportation (DOT) approved motorcycle helmet when operating this scooter.
- **This scooter is designed to hold only the driver. NEVER** carry a passenger on the scooter.
- **THIS SCOOTER HAS A 4-STROKE ENGINE AND REQUIRES UNLEADED 90 OCTANE OR HIGHER GASOLINE, WITHOUT METHANOL ADDITIVES.**



www.schwinn scooters.com

Table of Contents

Introduction	1
Specifications	1
Vehicle Record.....	1
Safety Precautions.....	1-3
Features	4-5
Description of Features	6
Key, Ignition Switch and Steering Lock.....	6
Engine Stop Switch and Starter Button.....	6
Headlight and Turn Signal	6
Throttle.....	6
Helmet Storage Hook	6
Brakes	7
Kick Starter.....	7
Center Stand.....	7
Luggage Rack	7
VIN Badge and Access Plate.....	7
Automatic Transmission	7
Before Every Ride	8
Check the Fuel Level	8
Check the Brakes	8
Check the Turn Signals, Brake Lights and Horn	8
Check the Tires	8
Check the Rear View Mirrors.....	8
Starting the Scooter.....	8
Automatic Choke	9
Kick Start.....	9
Electric Start.....	9
Breaking In the Scooter.....	10
Riding the Scooter	10
Entering Roadways	10
Acceleration and Deceleration	10
Braking	10
Parking.....	10
Routine Care and Maintenance	11
Refueling.....	11
Tire Maintenance	11
Front and Rear Brake Adjustment	12
Check Brake Effectiveness	12
Check Drum Brake Shoe Wear.....	12
Adding Engine Oil	13
Changing Engine Oil	13
Adding Transmission Oil	13
Changing Transmission Oil	13
Battery Maintenance.....	14
Inspecting the Battery Terminals.....	14
Replacing the Battery.....	14
Battery Disposal	14
Replacing the Fuse.....	15
Cleaning or Replacing the Air Filter	15
Replacing the Spark Plug	15
Cleaning	16
Troubleshooting	16
Reporting Safety Defects.....	16
Professional Maintenance Schedule	17
Limited Warranty	18
Emissions Performance Warranty	18

Introduction

■ KEEP THIS MANUAL WITH THE SCOOTER

This manual should be kept with the vehicle and should remain with the scooter when resold or otherwise transferred to a new owner or operator. This manual contains important safety information and instructions which should be read carefully and thoroughly before the rider operates the scooter.

■ LICENSES, REGISTRATION AND INSURANCE

Although this scooter is equipped for legal operation in the United States, prior to operation of this scooter you must consult your state and local government ordinances concerning driver's license requirements, license plates and proper registration. Before operating this scooter, consult your agent concerning proper insurance coverage in your state.

Specifications

Engine4-Stroke Air Cooled
Displacement.....49.5 cc
Cylinders1
StarterElectric and Kick
TransmissionAutomatic CVT
Transmission Oil.....Multi-weight SAE 85/90
Transmission Oil Capacity4.1 oz (0.12 liter)
Front and Rear Tires.....3.50" x 10"
Tire Pressure.....26 psi Front/29 psi Rear
Front and Rear Brakes.....Drum
Suspension Front.....Link
Suspension RearDamping Shock
Fuel Capacity1.45 gal (5.5 liter)
Fuel TypeUnleaded 90 Octane or Better
Gas Mileage*117 mpg (50 km/liter)
Driving Range*170 miles (275 km)

Engine Oil.....Multi-weight SAE 15W-40
Engine Oil Capacity.....0.8 qt (0.75 liter)
Maximum Speed on Flat29.8 mph (48 km/h)
Seat Storage0.64 cu ft (18 liter)
Luggage Rack Load Capacity10 lbs (4.5 kg)
Helmet Storage Hook Load Capacity 6.6 lbs (3 kg)
Length68.4 in (1738 mm)
Width**24.9 in (632 mm)
Height**41.9 in (1064 mm)
Dry Weight163.4 lb (74.1 kg)

* Estimate for 180 lb (81.8 kg) load on level ground

** Not including mirrors

All specifications are subject to change without notice.

Vehicle Record

- Write the Vehicle Identification Number (VIN) of your scooter here for future reference. When speaking to your dealer, you may need to provide the model number and the VIN, found on the VIN badge located on the back side of the front fairing. Find your model number on the Certificate of Origin that came with your scooter.

Model Number: 50CA06PK VIN number _____

- If you experience problems, are missing parts, or need service or repairs for your scooter, contact your local dealer.

Safety Precautions

WARNING

- The engine exhaust from this product contains chemicals known to the State of California to cause cancer, birth defects or other reproductive harm.

Safety Precautions, continued

WARNING

SEVERE INJURY OR DEATH CAN RESULT IF YOU DO NOT FOLLOW THE INSTRUCTIONS IN THIS MANUAL.

- **DO NOT** attempt to ride the scooter until you have read and understood the purpose and operation of all the controls described in this manual.
- **ALWAYS** wear a Department of Transportation (DOT) approved motorcycle helmet when operating this scooter.
- **NEVER** exceed maximum load capacity for the scooter. Combined weight of the rider, gear and any accessories must never exceed maximum load capacity of 225 lbs. (102 kg). **Overloading can impair the stability and performance of the scooter, possibly causing an accident.**
- **NEVER** use headphones or personal radios while riding the scooter.
- **ALWAYS** keep both hands on the handlebars and both feet on the footrests of the scooter while moving. **ALWAYS** wear shoes.
- **This scooter is designed to hold only the driver. NEVER** carry a passenger on the scooter.
- **ALWAYS** observe local and state laws for operating gas-powered vehicles on public roads.
- **NEVER** exceed speed limits. **ALWAYS** use turn signals to indicate your intention to turn. Follow your state's driver safety guidelines for turn signal use.
- **ALWAYS** keep a safe distance from other vehicles on the road.
- **ALWAYS** drive at a speed that is appropriate for the terrain, conditions and your experience.
- **NEVER** attempt wheelies, jumps or other stunts.
- **NEVER** drive the scooter under the influence of alcohol or drugs.
- **ALWAYS** inspect the scooter before riding to make sure it is in safe operating condition. Refer to "Before Every Ride" on page 8 and "Routine Care and Maintenance" on page 11.
- **NEVER** leave the key in the ignition after riding the scooter. Keep the key in a safe place to prevent unauthorized use of the scooter.
- **NEVER** modify the scooter. Modification of this scooter could lead to an accident resulting in **SERIOUS INJURY OR DEATH**. Any modification to the scooter, including the use of performance parts, voids all warranties.
- The exhaust system can become very hot and cause burns. Allow the muffler and other hot parts to cool before touching.

WARNING

GASOLINE AND ITS VAPORS ARE EXTREMELY FLAMMABLE AND EXPLOSIVE AND CAN CAUSE SEVERE BURNS OR DEATH.

- **ALWAYS** fill the fuel tank outdoors. **NEVER** fill the fuel tank indoors.
- If gas spills, **DO NOT** start the engine until all the spilled gas has evaporated and vapors have dissipated.
- Keep gasoline away from open flames, sparks, pilot lights or other sources of ignition.
- **NEVER** smoke while refueling the scooter.
- Make sure the fuel lines, tank and cap do not have cracks or leaks.
- Make sure the fuel cap is securely in place before starting the engine.
- **NEVER** start or operate the scooter near any open containers of gasoline, paint thinner or any other flammable liquids. Vapors could ignite causing a fire or explosion.

WARNING

GASOLINE ENGINES GIVE OFF CARBON MONOXIDE, AN ODORLESS, COLORLESS, POISONOUS GAS. BREATHING CARBON MONOXIDE CAN CAUSE NAUSEA, FAINTING, OR DEATH.

- **ALWAYS** start and operate the scooter outdoors. **NEVER** start or operate the engine in an enclosed area, even if the doors and/or windows are open.

Safety Precautions, continued

■ WEAR A DEPARTMENT OF TRANSPORTATION (DOT) APPROVED MOTORCYCLE HELMET

- Most serious motorcycle injuries and fatalities are due to head injuries. **ALWAYS** wear a Department of Transportation (DOT) approved motorcycle helmet when riding the scooter. Look for labels from the Safety Helmet Council of America, the American National Standard Institute (ANSI) or the Snell Memorial Foundation.
- Your helmet must fit snugly on your head and have no cracks, frayed straps or broken fasteners.

■ WEAR EYE AND FACE PROTECTION

- **ALWAYS** wear approved protective eye wear when operating the scooter.

■ WEAR PROTECTIVE CLOTHING

- **ALWAYS** wear shoes when driving the scooter.
- Wear long sleeves and pants to cover arms and legs for protection.
- Avoid loose clothing that could get caught in the scooter.
- Use gloves designed for use on motorcycles. They will offer protection to your hands and allow the full use of all controls.

■ STAY VISIBLE ON THE ROAD

- **ALWAYS** be aware of other vehicles on public roads. Many accidents are caused when drivers of cars do not see scooters who share the road.
- Wear bright or reflective clothing to increase your visibility to other motorists.
- **ALWAYS** use turn signals to indicate your intention to turn. Follow your state's driver safety guidelines for turn signal use.
- Stay out of the blind spots of other drivers.
- For safety and increased visibility, the headlight is always on when operating the scooter. Use the low beam whenever there is oncoming traffic.

Features

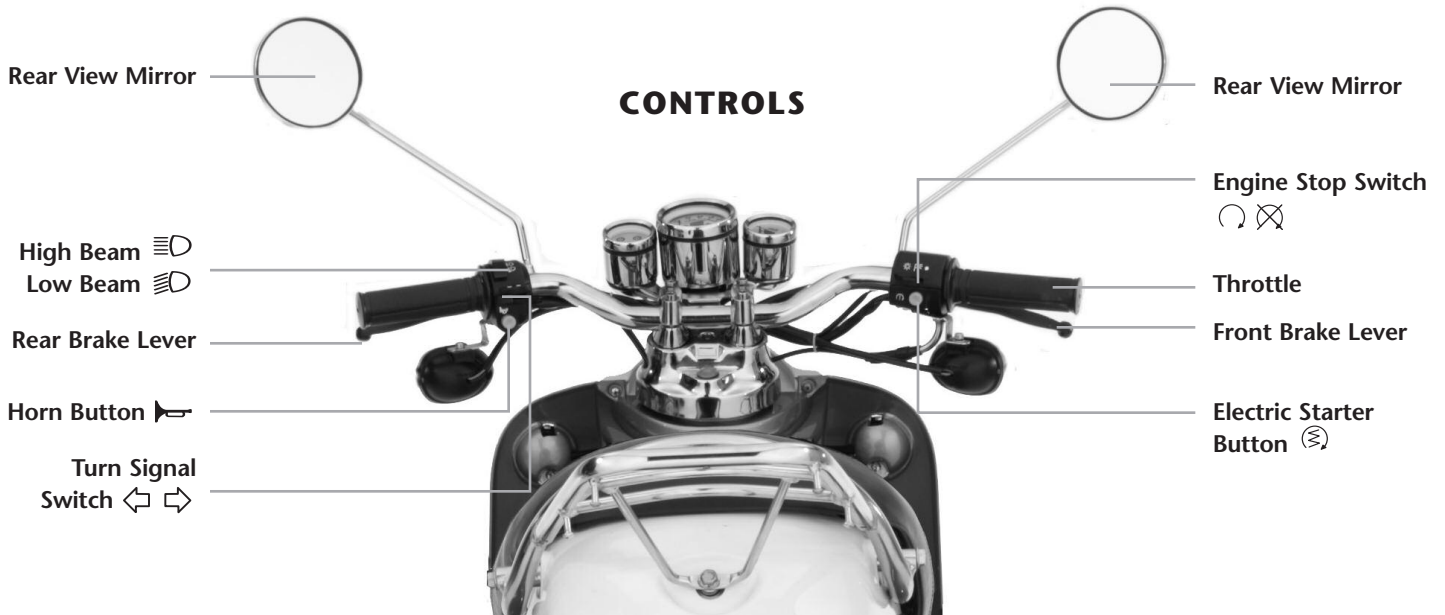
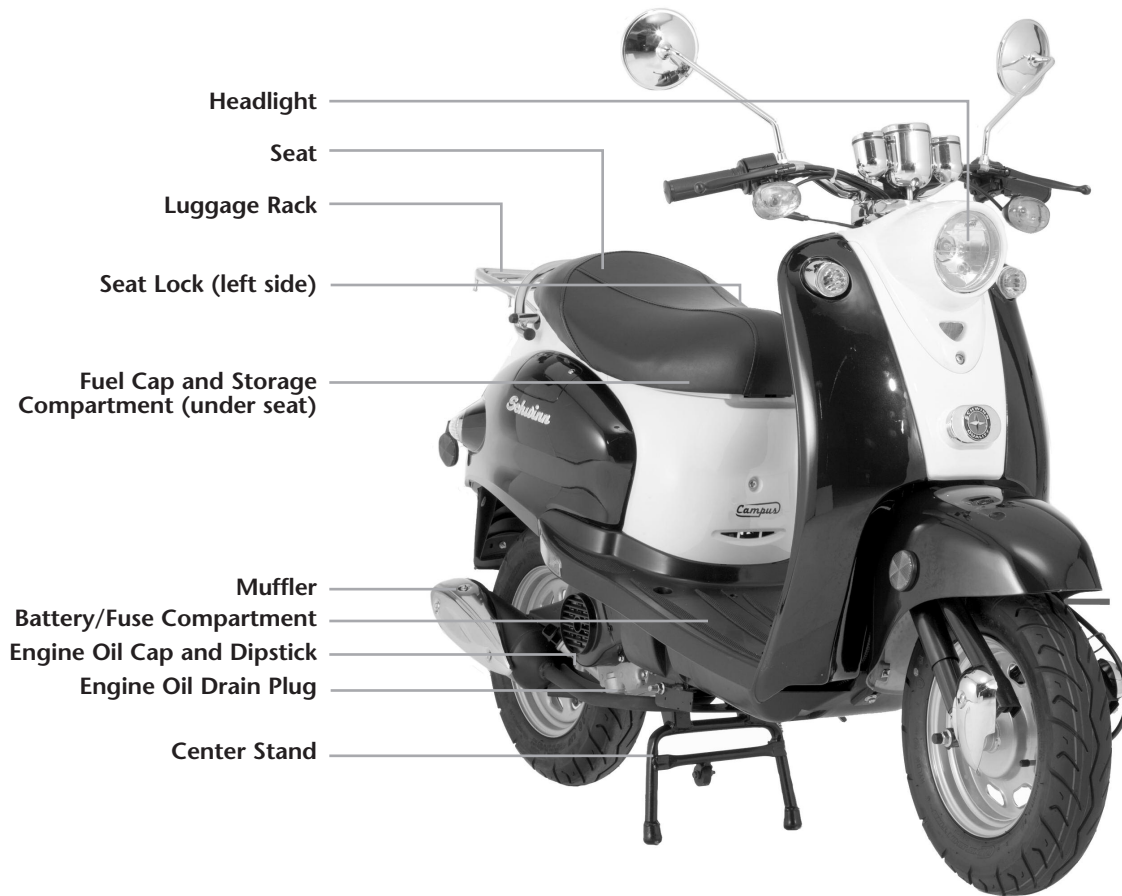

Features, continued

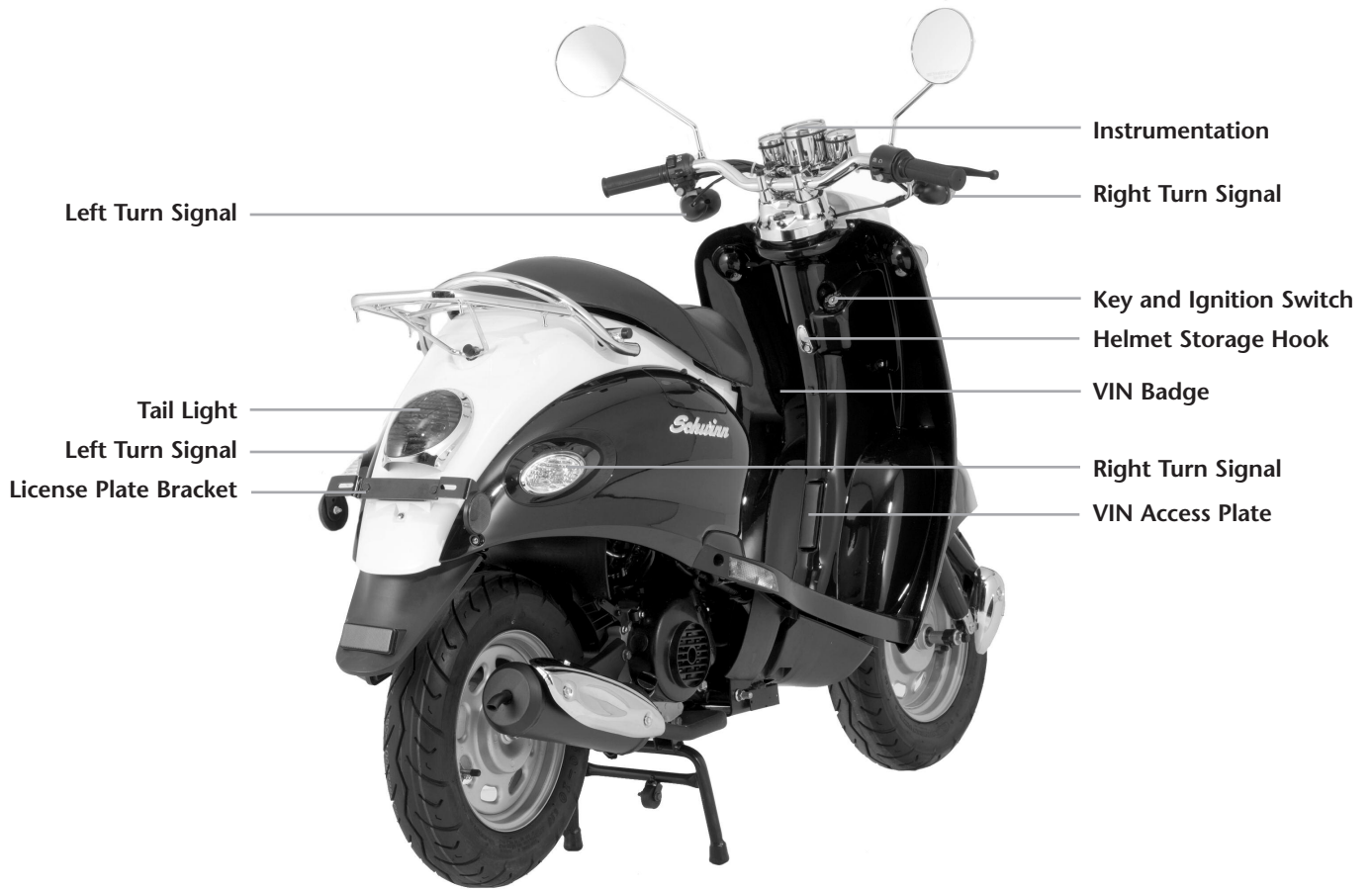

LEFT SIDE OF SCOOTER

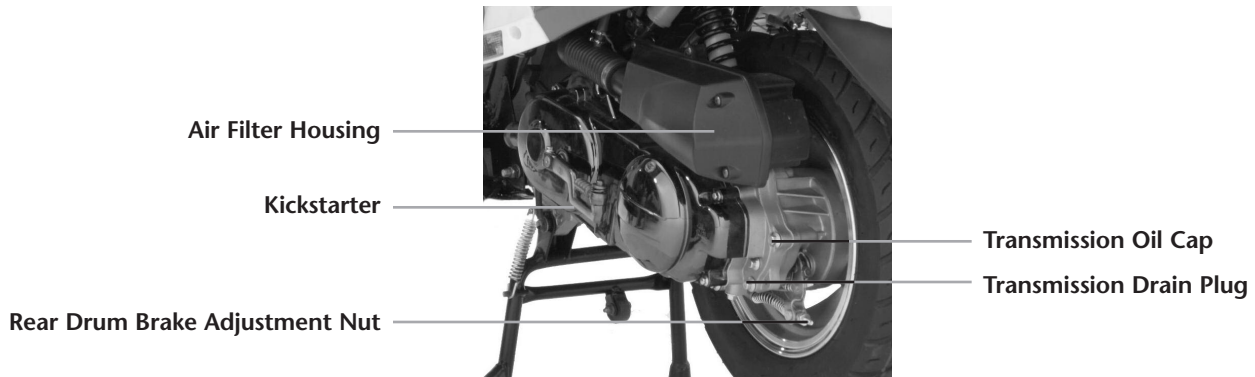



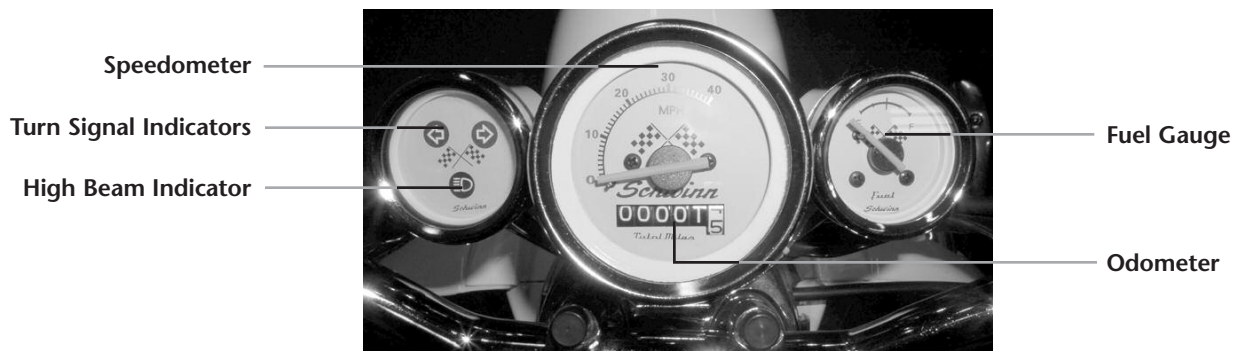



INSTRUMENTATION



Description of Features

■ KEY, IGNITION SWITCH, STEERING LOCK AND SEAT LOCK







- Your scooter comes with two keys. Keep the spare key in a safe place in case one key is lost. The key can be duplicated if necessary. **DO NOT** use anything other than the Schwinn Campus key in the ignition.
- The key turns the scooter on and off, engages the steering lock and opens the seat/storage compartment. **NOTE: DO NOT** turn the key in the ignition while the scooter is in motion. Turn the key **ONLY** when the scooter is at a complete stop.
- **TO TURN THE POWER ON**, place the key in the ignition and turn to the ON  position. Refer to “Starting the Scooter” on pages 8 and 9 for detailed instructions. The key cannot be removed in the ON  position. **Do not leave the key in the ON  position if the scooter is not running. The battery will drain.**
- **TO TURN THE POWER OFF**, turn the key to the OFF  position. The key can be removed in the OFF  position.
- **TO ENGAGE THE STEERING LOCK**, turn the handlebars all the way to the left. Turn the key to the OFF  position to turn the power off. Push the key in and turn to the LOCK  position. Remove the key. Test the lock by trying to turn the handlebars to the left and the right. If properly locked, the handlebars will not move. To help prevent theft, **ALWAYS** lock the scooter when left unattended.
- **TO ACCESS THE STORAGE COMPARTMENT UNDER THE SEAT**, insert the ignition key into the lock on the left side of the seat.
- **TO CLOSE THE SEAT, PRESS DOWN FIRMLY TO LOCK.** Remove the key.

WARNING

- **Storage area under the seat is 0.64 cubic feet (18 liters). NEVER exceed maximum load capacity for the scooter. Combined weight of the rider, gear and any accessories must never exceed maximum load capacity of 225 lbs. (102 kg). Overloading can impair the stability and performance of the scooter, possibly causing an accident.**
- **Do not carry oil, fuel or pressurized items in the storage compartment as they could overheat and explode, causing serious injury or death.**





- Do not place fragile, valuable or heat-sensitive items in the storage compartment.
- The storage compartment is not waterproof.
- The **FUEL CAP** is under the seat. See “Refueling” on page 11 for detailed instructions.

■ ENGINE STOP SWITCH AND STARTER BUTTON (RIGHT HANDLEBAR)

- **ON **: Move the switch to the ON  position to allow the engine to start. The engine will not start in the OFF  position.
- **OFF **: Move the switch to the OFF  position to shut down power to the electrical system. Use this feature only when other attempts to stop the scooter have failed. For example, if the throttle is stuck or malfunctioning, or if the scooter falls over.
- **ELECTRIC STARTER BUTTON **: With one brake lever pulled, press the starter button to start the scooter with battery power. Refer to “Starting the Scooter”, pages 8 and 9 for detailed instructions.

NOTE: The scooter can also be started with the kick starter. Refer to “Starting the Scooter” on pages 8 and 9 for instructions.

■ HEADLIGHT AND TURN SIGNAL (LEFT HANDLEBAR)

- For safety and increased visibility, the headlight is always on when operating the scooter. Use the low beam whenever there is oncoming traffic.
- **LOW BEAM **: Use the low beam when traveling in traffic and during the day.
- **HIGH BEAM **: Use the high beam to see further at night. Do not use the high beam when traveling behind another vehicle or if there is oncoming traffic.
- **TURN SIGNAL **: Push the switch to the LEFT  when turning left, and push the switch to the RIGHT  when turning right. The center position is OFF.

Description of Features, continued

■ THROTTLE (RIGHT HANDLEBAR GRIP)

- **ACCELERATE:** Twist the throttle toward you.
- **DECELERATE:** Twist the throttle away from you or loosen your grip and the throttle will automatically return to the idle position.

■ HELMET STORAGE HOOK

- Use the hook to store your helmet when not in use. Maximum weight for the helmet storage hook: 6.6 lbs. (3 kg).

■ BRAKES

- **FRONT BRAKE LEVER:** The FRONT brake lever is attached to the RIGHT handlebar.
- **REAR BRAKE LEVER:** The REAR brake lever is attached to the LEFT handlebar.
- For more information about using the brakes, see "Riding the Scooter", page 10. To adjust brakes, see "Front and Rear Brake Adjustment" on page 12.

■ KICK STARTER

- Use the kick starter to start the scooter or prime the engine in the following situations:
 - If the scooter has been driven less than 100 miles (160 kilometers).
 - In cold or wet weather.
 - If the fuel tank has run completely dry (and more fuel has been added).
 - If the scooter has been stored for more than two weeks.
 - If the scooter fails to start using the electric starter button.
 - If the battery is discharged.
- The kick starter can be used to "prime" the fuel system prior to using the electric start button. See "Starting the Scooter", pages 8 and 9 for detailed instructions on using the kick starter.

■ CENTER STAND

- Always use the center stand on level ground.
- To extend the center stand and park the scooter, grasp the left handlebar grip and the luggage rack with your right hand. Place your right foot on the foot peg of the center stand and push straight down. The rear wheel will raise slightly as the scooter comes to rest on the center stand.
- To retract the center stand, grasp both handlebar grips and push the scooter forward. **NOTE:** Be sure your feet and legs are clear of the center stand. The center stand has a strong spring and will retract under the scooter very quickly.

■ LUGGAGE RACK

WARNING

• **Maximum load for the luggage rack is 10 lbs. (4.5 kg). NEVER exceed maximum load capacity for the scooter. Combined weight of the rider, gear and any accessories must never exceed maximum load capacity of 225 lbs. (102 kg). Overloading can impair the stability and performance of the scooter, possibly causing an accident.**

- Evenly distribute the load on the luggage rack and secure with straps.
- Do not attach anything to the handlebars, fenders or footrests.

■ VIN BADGE AND ACCESS PLATE

- You will need your Vehicle Identification Number when registering your scooter with your local government or contacting your dealer. The VIN appears in two places: on the VIN badge, located on the back side of the front fairing, and under the VIN access plate.

■ AUTOMATIC TRANSMISSION

- Your new scooter has an automatic transmission that does not require the use of a clutch or gear shift.

Before Every Ride

For your safety and to keep the scooter in good working order, **ALWAYS** perform the following checklist before every ride. If you find any damaged or worn parts, **DO NOT** use the scooter. Contact your dealer for repairs.





■ CHECK THE FUEL LEVEL

- Check the fuel gauge. Add fuel if necessary.

■ CHECK THE BRAKES

- Apply the front and rear brakes to make sure they are working correctly. Refer to “Front and Rear Brake Adjustment” on page 12.

■ CHECK THE TURN SIGNALS, BRAKE LIGHTS AND HORN

- Turn the ignition key to the ON  position to provide power to the scooter. Move the turn signal to the LEFT  and RIGHT  positions and make sure turn the signal lights and the turn indicator lights on the speedometer are functioning properly.
- Apply the front brake and make sure the brake light is functioning properly. Repeat this test for the rear brake.
- Push the horn button  to make sure horn is functioning properly.

■ CHECK THE TIRES

- Make sure the tires are inflated to the proper pressures: the front tire should be inflated to 26 PSI and the rear tire should be inflated to 29 PSI. Make sure there are no cuts, punctures or excessively worn tread on the tires. Refer to “Tire Maintenance” on page 11 for details.

■ CHECK THE REAR VIEW MIRRORS

- Make sure the mirrors are clean, secured and adjusted properly so you can have a clear view of vehicles behind the scooter.

Starting the Scooter

WARNING

- **DO NOT attempt to ride the scooter until you have read and understood the purpose and operation of all the controls described earlier in this manual.**
- **Maximum combined weight of rider and cargo must not exceed 225 lbs. (102 kg).**
- **ALWAYS wear an approved Department of Transportation (DOT) motorcycle helmet when operating this scooter.**

WARNING

GASOLINE ENGINES GIVE OFF CARBON MONOXIDE, AN ODORLESS, COLORLESS, POISONOUS GAS. BREATHING CARBON MONOXIDE CAN CAUSE NAUSEA, FAINTING, OR DEATH.

- **ALWAYS start and operate the scooter outdoors. NEVER start or run the engine in an enclosed area, even if the doors and/or windows are open.**

WARNING



- **The engine exhaust from this product contains chemicals known to the State of California to cause cancer, birth defects or other reproductive harm.**

Starting the Scooter, continued



■ AUTOMATIC CHOKE

NOTE: Your new scooter is equipped with an Automatic Choke. There is no manual choke and no need to apply the throttle while starting.

■ KICK START

- For the first 100 miles (160 kilometers) it is recommended that you kick start the scooter, or use the kick starter to “prime” the engine (force fuel into the carburetor) prior to using the electric starter. This preserves battery life and reduces wear to the electrical starter (⊗) during the break-in period.
- The center stand must be down in order to use the kick starter. **NOTE:** Do not attempt to sit on the seat and start the scooter with the center stand down.
- Place the key in the ignition and turn it to the ON  position.
- Move the engine stop switch to the ON  position. **NOTE:** The scooter will not start when the engine stop switch is in the OFF  position.
- Stand to the left of the scooter. Grasp the handlebar grip with your left hand and the luggage rack with your right hand.
- Pull either brake lever. **NOTE:** The scooter will not start unless one brake is applied while starting.
- Extend the kick starter foot peg.
- “Kick” down on the kick starter quickly, then allow it to spring back into position. Repeat this procedure until the engine starts. **NOTE:** You are forcing fuel up into the carburetor with each “kick”. It may take many “kicks” to start the engine for the first time.
- When the engine starts, apply enough throttle to idle the engine for 20 to 30 seconds. **NOTE: DO NOT** open the throttle *while* kick starting. Open the throttle only *after the* engine has started.
NOTE: To prolong engine life, allow the engine to reach normal operating temperature before driving. This usually takes about 2 to 3 minutes.
- Retract the kick starter foot peg to its original position before driving.
- Grasp both handlebar grips and push the scooter forward to retract the center stand under the scooter. Mount the scooter.
- **Use the kick starter to start the scooter or prime the engine in the following situations:**
 - If the scooter has been driven less than 100 miles (160 kilometers).
 - In cold or wet weather.
 - If the fuel tank has run completely dry (and more fuel has been added).
 - If the scooter has been stored for more than two weeks.
 - If the scooter fails to start using the electric starter button.
 - If the battery is discharged.

■ ELECTRIC START

- Retract the center stand and sit on the seat with both feet on ground.
- Place the key in the ignition and turn it to the ON  position.
- Move the engine stop switch to the ON  position. **NOTE:** The scooter will not start when the engine stop switch is in the OFF  position.
- Pull either brake lever. **NOTE:** The scooter will not start unless one brake is applied while starting.
- Press the electric starter button (⊗) for no more than five (5) seconds until the engine starts. Release the button as soon as the engine starts. **NOTE: DO NOT** press the electric starter button continuously for more than five seconds. Damage to the starter could occur.
- If engine doesn't start, wait ten (10) seconds and repeat the starting procedure.
- If repeated attempts fail, use the kick starter to start the scooter or prime the engine. See “Kick Start” section above.
- When the engine starts, apply enough throttle to idle the engine for 20 to 30 seconds. **NOTE: DO NOT** open the throttle *while* starting. Open the throttle only *after the* engine has started.
- **NOTE:** To prolong engine life, allow the engine to reach normal operating temperature before driving. This usually takes about 2 to 3 minutes.

Breaking In the Scooter

- For the first 100 miles (160 kilometers) it is recommended that you kick start the scooter, or use the kick starter to “prime” the engine (force fuel into the carburetor) prior to using the electric starter. This preserves battery life and reduces wear to the electric starter during the break-in period.
- **ALWAYS** allow the engine to warm up for 2 to 3 minutes before driving.
- Do not drive the scooter at a constant speed for long periods of time during the break-in period. Avoid overheating the engine.

Riding the Scooter

■ ENTERING ROADWAYS

- Apply the turn signal if needed.
- Make sure there is no oncoming traffic. **ALWAYS** be aware of other vehicles on public roads. Many accidents are caused when drivers of cars do not see scooters who share the road.
- Release the brake and gradually advance the throttle for smooth acceleration.

■ ACCELERATION AND DECELERATION

- Adjust speed by twisting the throttle. Twist the throttle toward you to accelerate. Twist the throttle away from you to decelerate. **NOTE:** Your new scooter has an automatic transmission, so there is no clutch and no need to shift gears.
- **ALWAYS** allow the engine to warm up thoroughly before hard acceleration, or damage to the engine could occur.



■ BRAKING

WARNING

- **ALWAYS** apply the front and rear brakes simultaneously to slow down or come to a stop.
- **BE CAUTIOUS** when using the front brake. Loss of front wheel traction can make both steering and braking ineffective. Using the front brake on loose gravel or wet road conditions can result in loss of traction.
- **DO NOT** continually engage the brakes for an extended period of time. This causes excessive wear and can overheat the brakes, causing brake failure which could result in serious injury or death.
- **In wet driving conditions, be aware that normal stopping distances are increased.**

■ PARKING

NOTE: Always park on smooth, level ground.

- Turn the ignition key to the OFF  position. Remove the key.
- Move the engine stop switch to the OFF  position.
- Dismount the scooter and engage the center stand.
- **DO NOT** park on a slope or on soft surfaces. The scooter could tip over.
- **DO NOT** park near flammable materials.
- Engage the steering lock to prevent theft (see instructions on page 6).

Routine Care and Maintenance

WARNING

- When performing routine maintenance on the scooter, **NEVER** start or run the engine in an enclosed area, even if the doors and/or windows are open. **ALWAYS** start and operate the scooter outdoors.
- Allow the engine, muffler and other hot parts to cool before touching.
- Conduct cleaning and maintenance using the center stand (see page 7) on a smooth, flat, hard surface.

WARNING

GASOLINE AND ITS VAPORS ARE EXTREMELY FLAMMABLE AND EXPLOSIVE AND CAN CAUSE SEVERE BURNS OR DEATH.

- Keep gasoline away from open flames, sparks, pilot lights or other sources of ignition.
- **NEVER** smoke while refueling the scooter.
- Fill fuel tank outdoors or in a well-ventilated area.
- If fuel spills, **DO NOT** start engine until the spilled fuel has evaporated and vapors have dissipated.
- Make sure the fuel lines, tank and cap do not have cracks or leaks.
- **NEVER** start or operate the scooter near gasoline, paint thinner, or any other flammable liquids. Vapors could ignite causing a fire or explosion.
- If you swallow gasoline, **DO NOT INDUCE VOMITING**. If you inhale gasoline vapor and feel ill, or spill gasoline into your eyes, see a physician immediately.
- If you spill gasoline on your skin or clothing, change clothing and wash your skin with soap and water.

■ **REFUELING**

THIS SCOOTER HAS A 4-STROKE ENGINE AND REQUIRES UNLEADED 90 OCTANE OR HIGHER GASOLINE, WITHOUT METHANOL ADDITIVES.

- Turn the engine OFF  and allow the engine to cool at least two (2) minutes before removing the fuel cap.
- The fuel cap is located under the seat. Unlock the storage compartment by inserting the ignition key into the lock on the left side of the seat. Turn the key to the right (clockwise) to unlock. Lift the seat.
- Use UNLEADED 90 octane or higher gasoline without Methanol additives only. The tank holds 1.45 gallons (5.5 liters) of fuel.
- **DO NOT** overfill the fuel tank. Fill tank to about 1.5 inches below the top of the tank to allow for fuel expansion.
- Wipe up spills immediately. Gasoline may damage paint and plastic parts. Do not start the engine until the spilled fuel evaporates and the vapors have dissipated.
- **NEVER** add anything to the gasoline in the fuel tank.
- Replace the fuel cap securely. To close the seat, press down firmly to lock. Remove the key.

■ **TIRE MAINTENANCE**

WARNING

- **Always maintain proper tire inflation pressure. Failure to do so may cause tire damage or unstable handling, which could result in serious injury or death.**

- To check the tire pressure, remove the cap from the valve stem and set aside. Use a tire pressure gauge to measure the air pressure in the tires. **The correct pressure for the front tire is 26 PSI, and for the rear tire is 29 PSI.**
- Inspect the rims. If the rims are cracked or bent do not ride the scooter. They must be replaced.
- Check the tires for wear and damage. If you notice cuts, punctures or excessively worn tread, the tire needs to be replaced. Contact your dealer for replacement parts and service.

Routine Care and Maintenance, continued

FRONT AND REAR BRAKE ADJUSTMENT

- Test the brake lever free play. Apply light pressure each brake lever until you feel the brake engage. There should be very little free play between the "at rest" position of the brake lever and the applied position of the brake lever. Acceptable free play is between 3/8" and 3/4" (Fig. 1). Keep the brake cable adjusted to maintain acceptable free play.
- Use a wrench to adjust the brake adjustment nut on the rear wheel (Fig. 2). Tighten as necessary until the correct freeplay is established.

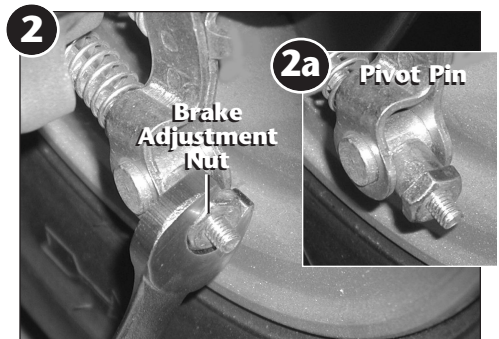
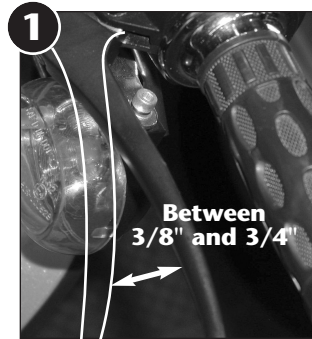

NOTE: If you tighten the nut too much, the wheel will "drag", even if the brake is not applied.

- Make sure the brake adjustment nut is in the correct position after adjusting. The curved side of the nut must rest snugly against the pivot pin (Fig 2a). Check brake operation.

CHECK FRONT AND REAR DRUM BRAKE SHOE WEAR

- As the drum brake shoe linings wear, freeplay in the brake lever will increase. Each time the brake adjustment nut is tightened to decrease freeplay in the brake lever, the brake wear indicator will move to a position closer to the minus (-) sign (Figs. 3 and 4).
- **The indicator should never reach the minus sign.** Brake shoes should be inspected and replaced by a QUALIFIED MECHANIC before the indicator reaches the minus sign. The brake shoe must be replaced before the lining reaches the minimum allowed thickness of 0.06" (1.5 mm). The brake drum must never measure larger than 3.892" (99.0 mm) in diameter.

⚠ WARNING

- Never allow the front or rear drum brake pad indicator to reach the minus sign.
- Even if working properly, the brakes should be inspected by your dealer at the intervals listed in the Professional Maintenance Schedule on page 17.

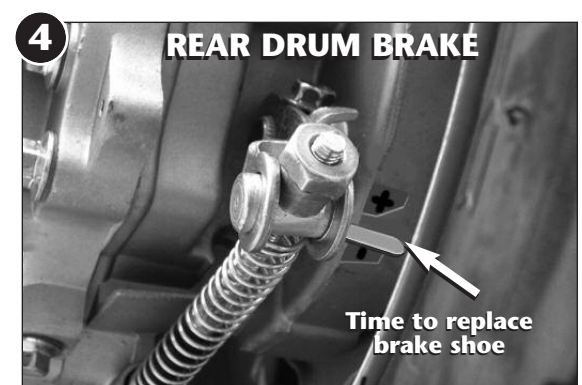
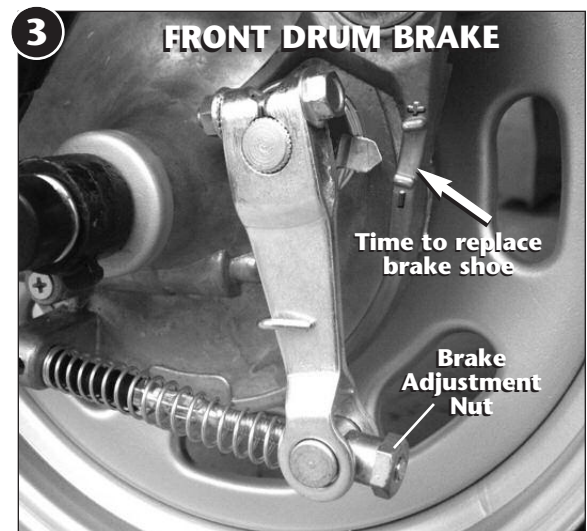

Routine Care and Maintenance, continued

CAUTION

- Always allow the engine to cool before performing any routine maintenance. When hot, scooter parts can cause severe burns.

■ ADDING ENGINE OIL

- Oil should be checked every 300 miles (480 kilometers).
- Stop on smooth, level ground, turn the ignition OFF \otimes and remove the key.
- Use the center stand to park the scooter and allow the engine to cool.
- Unscrew the dipstick (Fig. 1), found on the right side of the scooter (see photo on page 4). Wipe the dipstick clean with a cloth and dip it back into the oil reservoir (do not screw it back in).
- Pull the dipstick out and read the oil level. Oil level should fall within the diamond pattern (Fig. 1).
- If oil level reaches the ADD point (Fig. 1), add oil. Use enough multi-weight SAE 15/40 lubricating oil to keep the level between between FULL and ADD. **IMPORTANT: DO NOT overfill.**
- Replace the dipstick and tighten firmly by hand.

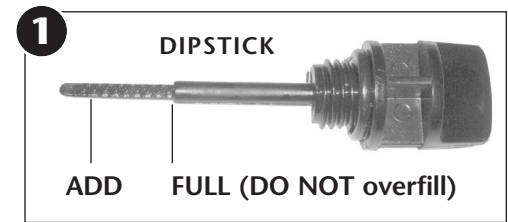

■ CHANGING THE ENGINE OIL

- Change the engine oil after the first 200 miles (320 kilometers), and every 2,500 miles (4,000 kilometers) or six (6) months, whichever comes first.
- Locate the drain plug found under the crank case (refer to photo on page 4).
- Place an oil pan under the drain plug. Use a wrench to unscrew the plug and allow the oil to drain out. Replace the plug and tighten firmly using the wrench. **DO NOT** overtighten.
- Unscrew the dipstick (Fig. 1), found on the right side of the scooter (see photo on page 4).
- Use a funnel to pour 0.8 qt. (0.75 liter) multi-weight SAE 15/40 lubricating oil into the engine oil reservoir.
- Re-check the oil level with the dipstick.
- Replace the dipstick and tighten firmly by hand.
- Consult your local authorities for instructions on the proper disposal of used oil.

■ ADDING TRANSMISSION OIL

- Inspect the rear drive area for signs of oil leakage. If you suspect the level is low, you may need to add transmission oil.
- Using a wrench, unscrew the transmission oil cap, found on top of rear drive assembly, beside the rear wheel (refer to photo on page 5).
- There is no gauge or dip stick to measure the transmission oil level. The transmission oil is full when the fluid level is even with the bottom edge of the fill hole.
- Using a funnel, pour enough multi-weight SAE 85/90 oil into the transmission oil reservoir to top off.
- Replace the transmission oil cap and tighten firmly with a wrench. **DO NOT** overtighten.

■ CHANGING TRANSMISSION OIL

- Change the transmission oil after the first 200 miles (320 kilometers), and every 2,500 miles (4,000 kilometers) or six (6) months, whichever comes first.
- Locate the drain plug, found on the left side of the scooter, near the rear wheel, underneath the rear drive assembly (refer to photo on page 5).
- Place an oil pan under the drain plug. Use a wrench to open the plug and allow the remaining oil to drain out. Replace the plug and tighten firmly with a wrench. **DO NOT** overtighten.
- Locate the oil cap, found on top of rear drive assembly, beside the rear wheel (refer to photo on page 5).
- Use a funnel to pour 4.1 oz. (120 cc) multi-weight SAE 85/90 oil into the transmission oil reservoir.
- Replace the transmission oil cap and tighten firmly with a wrench. **DO NOT** overtighten.
- Consult your local authorities for instructions on the proper disposal of used oil.

Routine Care and Maintenance, continued

■ BATTERY MAINTENANCE

- The battery is sealed and does not require electrolyte replacement.
- To help preserve the life of the battery, use the kick starter method to start your scooter for short trips (see page 9).
- The battery charge is maintained with current from the alternator.
- Batteries discharge during long periods of storage. When storing your scooter for periods longer than 2-4 weeks, maintain the battery by using a low amperage battery maintenance charger designed specifically for motorcycle and scooter batteries.

■ INSPECTING THE BATTERY TERMINALS

- **ALWAYS** turn the scooter off and remove the key before inspecting the battery.
- Periodically check the battery for leakage or corrosion. Using a Phillips screwdriver, remove the screws from the battery door in the floor board. Set aside the hardware. Open the battery door.
- Visually inspect the battery, its cables and terminals for damage.
- If you see corrosion on the battery terminals, they will need to be cleaned.
- **NEVER** pick up the battery by its cables or connectors.
- Pull the terminal covers back to expose both battery terminals. Using a Phillips screwdriver or wrench, disconnect the negative (black) cable from the battery terminal first, then disconnect the positive (red) cable from the battery terminal (Fig 1). When removing the cables from the battery, make sure they do not come in contact with each other.
- Lift the battery up and out of the compartment. Handle the battery carefully.
- Gently clean the posts with a wire brush.
- Wipe the posts clean with a damp cloth (a dry cloth may cause static electricity).
- Lower the battery into the compartment.
- Reconnect the positive (red) cable to the positive terminal. Reconnect the negative (black) cable to the negative terminal. When re-connecting the cables to the battery, make sure they do not come in contact with each other.
- Replace the terminal covers.
- Replace the battery door, and secure it with the screws.

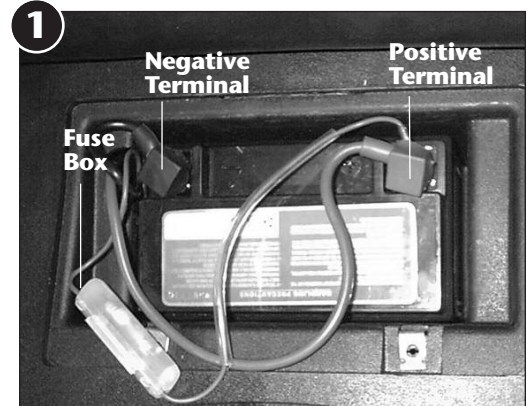

■ REPLACING THE BATTERY

- The scooter battery will need to be replaced if:
 - The battery has completely discharged.
 - The battery has leaked.
 - The battery casing is cracked or damaged.
- Contact your dealer to purchase a new battery. Use of an unauthorized battery will void the warranty.
- Follow the instructions above for accessing and removing the battery.
- Lower the new battery into the compartment.
- Reconnect the positive (red) cable to the positive terminal. Reconnect the negative (black) cable to the negative terminal.
- Replace the battery door, and secure it with the screws.

■ BATTERY DISPOSAL

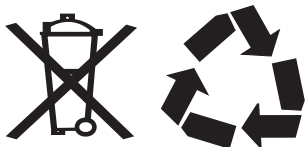

- **NEVER** throw the battery away in the trash or burn it in a fire. In most areas, it is illegal to burn lead acid batteries or put them in a landfill.
- Take the exhausted battery to an approved lead acid battery recycle center, such as an auto parts store or battery retailer.
- Call your waste collection service to find out if they offer disposal of lead acid batteries. Do not dispose of the battery or battery acid in any unapproved place. Follow your state guidelines for proper disposal procedure.

Routine Care and Maintenance, continued

■ REPLACING THE FUSE

- If the electrical system is not working properly, a fuse may have blown.
- Turn the ignition OFF \otimes .
- Using a Phillips screwdriver, remove the screws from the battery door found in the floor board. Set aside the hardware. Open the battery door.
- Locate and open the fuse case. You will see two fuses, one is in use, and the other is a spare.
- Inspect the fuse for broken wires.
- If you find a blown fuse, remove it. Insert a new fuse, making sure it fits snugly into the socket. A loose connection will cause electrical problems, and possibly overheat the fuse contacts.
- **ALWAYS** replace the fuse with a new fuse of the same amperage rating. **DO NOT** replace it with a fuse of higher amperage rating. Extensive damage to the electrical system could occur.
- Close the fuse case and place the fuse and battery cables completely inside the battery compartment. Make sure the terminal covers are in place. Replace the battery door and secure it with the screws.
- If the new fuse blows out immediately, contact your dealer for repairs.

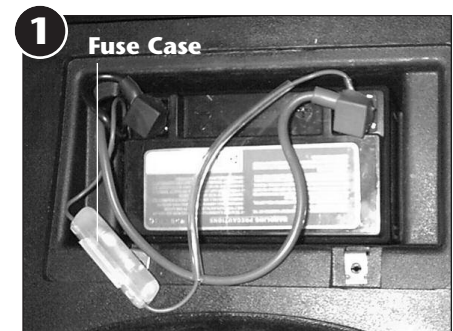

■ CLEANING OR REPLACING THE AIR FILTER

- Check the air filter after 600 miles (960 kilometers); then again every 2,500 miles (4,000 kilometers) or 6 months.
- The air filter may become clogged with dirt and dust, causing a decrease in engine power. Keep the air filter clean for optimal scooter performance.
NOTE: If you live in a coastal or arid area or drive on dirt or gravel roads, you may need to clean or replace the air filter more frequently.
- Look on the left side of the scooter and locate the air filter cover. Using a Phillips screwdriver, remove the filter cover screws (Fig. 2) and set aside.
- Remove the cover (Fig. 3) to expose the air filter. Gently remove the air filter; be careful not to tear it.
- Shake the air filter vigorously to remove dust and debris. **NEVER** use water to clean the air filter.
- Inspect the air filter. If it is damaged, it must be replaced. Contact your dealer to obtain a new filter.
- If the air filter is clean and reusable, carefully press the air filter back into place. Replace the cover and secure the filter cover screws. **NOTE:** Make sure the filter and cover fit together properly before tightening the screws. Gaps may cause the engine to run improperly.



■ REPLACING THE SPARK PLUG

- If the scooter is hard to start, it may be necessary to clean or replace the spark plug or adjust the electrode gap. Replace it with an A7RTC spark plug only. **NOTE:** Correct gap for the spark plug is 0.024" to .032" (0.6 to 0.8 mm). Incorrect gap can cause damage to the scooter's engine.
- Allow the engine to cool before changing the spark plug.
- The spark plug can be accessed from the right side of the scooter (Fig. 4).
- Pull the spark plug cover off the spark plug (Figs. 5 and 6). Use a spark plug socket wrench to remove the spark plug from the cylinder (Fig. 7).
- Insert the new spark plug into the cylinder and tighten firmly by hand. Use the spark plug socket wrench and tighten another 1/2 to 3/4 turn.
- Replace the spark plug cover securely over the spark plug.

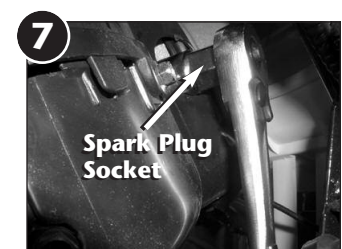

Routine Care and Maintenance, continued

■ CLEANING

Keep your scooter clean so it will look good and perform well. Before washing, remove the contents of the storage compartment.



WARNING

- **DO NOT allow water to come in contact with the ignition, battery, fuse compartment or other electrical parts.**
- **DO NOT use high-pressure washers, as they can cause damage to the scooter's body, mechanical and electrical parts.**

- Hand wash with mild soap and water using a soft rag or mitt. **DO NOT** use a brush that could scratch the finish. **DO NOT** use abrasive cleansers.
- Rinse thoroughly with clean water. **DO NOT** allow water to come in contact with any electrical components. Dry with a chamois or soft, absorbent cloth.

Troubleshooting

Scooter will not start.

1. Make sure you have fuel in the fuel tank.
2. Make sure you are squeezing one brake lever while starting the scooter. The scooter will not start if a brake is not applied.
3. Make sure the engine stop switch is in the ON  position.
4. Make sure the key is in the ignition and turned to the ON  position.
5. The spark plug may need replacing (see "Replacing the Spark Plug", page 15).
6. The fuse may have blown. Check the fuse (see "Replacing the Fuse", page 15).
7. The engine may be overheated. Allow it to cool before attempting to restart the scooter.
8. The battery may be discharged. Use the kick starter (see "Starting the Scooter", page 9), or charge or replace the battery, (see "Replacing the Battery", page 14).

Poor engine power or poor fuel economy.

1. The air filter may be dirty (see "Cleaning or Replacing the Air Filter", page 15).
2. The spark plug may need to be adjusted or replaced (see "Replacing the Spark Plug", page 15).
3. The tires may be over-inflated or under-inflated. Check tire pressure (see "Tire Maintenance", page 11).

Pacific Cycle, Inc., 4902 Hammersley Road, Madison, WI 53711

Reporting Safety Defects

If you believe that your vehicle has a defect which could cause a crash or could cause injury or death, you should immediately inform the National Highway Traffic Safety Administration (NHTSA) in addition to notifying Pacific Cycle, Inc.

If NHTSA receives similar complaints, it may open an investigation, and if it finds that a safety defect exists in a group of vehicles, it may order a recall and remedy campaign. However, NHTSA cannot become involved in any individual problems between you, your dealer, or Pacific Cycle, Inc.

To contact NHTSA you may either call the Auto Safety Hotline toll-free at 1-800-424-9393 (366-0123 in Washington, DC area) or write to:

NHTSA
U.S. DEPARTMENT of TRANSPORTATION
400 7th Street SW, (NSA-11)
Washington, DC 20590

You can also obtain other information about motor vehicle safety from the Hotline.

Professional Maintenance Schedule

Contact your dealer for all inspections, repairs and major routine maintenance of the following items at the recommended intervals. Failure to follow the maintenance schedule voids all warranties.

Item	Initial 200 miles (320 km)	600 miles (960 km)	At 2,500 miles (4,000 km) or 6 months	At 5,000 miles (8,000 km) or 6 months
Fuel Line		X	X	X
Fuel Filter			X	X
Valve Gap	X	X	X	X
Oil Filter Screen Cap		X	X	X
Cooling Fan	X	X	X	X
Drive Belt	Every 12 months			
Transmission Oil	X		X	X
Braking System	X	X	X	X
Wheels/Rims		X	X	X
Tires	X	X	X	X
Wheel Bearings		X	X	X
Steering Bearings	X	X	X	X
Rear Shock Absorber		X	X	X
Chassis Fasteners	X	X	X	X
Speedometer Cable		X	X	X
Throttle Grip and Cable		X	X	X
Turn Signal		X	X	X
Brake Light		X	X	X
Headlight		X	X	X
Nuts, Bolts and Screws		X	X	X

EMISSION CONTROL DEVICES AND SYSTEMS: Contact your dealer for all inspections, repairs and major routine maintenance of the following items at the recommended intervals.

Item	600 miles (960 km)	At 2,500 miles (4,000 km) or 6 months	At 5,000 miles (8,000 km) or 6 months
Fuel System			
Carburetor Assembly	X	X	X
Intake System			
Air Filter	X	X	X
Intake Manifold	X	X	X
Ignition System			
Spark Plug	X	X	X
Ignition Coil	X	X	X
CDI	X	X	X
After Treatment System			
Catalyst/Muffler	X	X	X

Limited Warranty

THE EXPRESS WARRANTIES AS CONTAINED HEREIN ARE EXCLUSIVE AND IN LIEU OF ALL OTHER WARRANTIES, EXPRESS OR IMPLIED, INCLUDING IMPLIED WARRANTIES OF MERCHANTABILITY AND FITNESS FOR A PARTICULAR PURPOSE. THERE ARE NO WARRANTIES THAT EXTEND BEYOND THE DESCRIPTION IN THIS LIMITED WARRANTY.

Pacific Cycle extends the following LIMITED WARRANTY to the original purchaser of the Schwinn® scooter:

Warranty coverage is limited to the original purchaser for personal non-commercial use only and is not assignable or transferable.

Limited Warranty – If a part is defective in material or workmanship, Pacific Cycle, at its option, will authorize the repair or replacement of the defective part for up to one year from the date of original purchase.

Exceptions, Exclusions, and Conditions – Warranty does not cover wear and tear, abuse, misuse, alteration or modification of the equipment, improper maintenance or repair, improper assembly, accident, personal injury or other damage resulting from use of the equipment, or conditions or occurrences beyond the control of Pacific Cycle including damage from transportation, fire, flood, or other Acts of God. Pacific Cycle is not responsible for economic loss, lost profits, inconvenience, loss or damage to personal property, direct, indirect, or consequential damages. Failure to follow the maintenance schedule voids all warranties.

The obligation of Pacific Cycle under this warranty is limited solely to the repair or replacement of parts covered by this warranty. Any modification to the scooter, including the use of performance parts, voids all warranties. All other costs including shipping for warranty repairs are the obligation of the owner. Pacific Cycle is not responsible for any damage incurred during transport. Any questions should be directed to Customer Service and must include: model number, date of purchase, name of store where purchased and original sales receipt or proof of purchase.

This warranty gives you specific legal rights. You may have other rights which may vary from state to state.

Emissions Performance Warranty

For a period of five years from the date of purchase, Pacific Cycle, Inc. warrants to the purchaser and each subsequent purchaser of the scooter that the vehicle is designed, built and equipped to conform at the time of sale with all United States emissions standards and that it is free from defects in materials and workmanship. Failure resulting from owner abuse and/or lack of proper maintenance are not covered by this warranty. Maintenance, replacement or repair of the emission control devices and systems may be performed by any automotive repair establishment or individual using any certified part. The owner may bring a claim under the emissions performance warranty through an authorized Schwinn Motor Scooters dealer. The owner of the scooter may obtain further information concerning the emission performance warranty or may report violations of the terms of the emission performance warranty by contacting the Director, Field Operations and Support Division (6406J), Environmental Protection Agency, 405 "M" Street, SW, Washington, D. C. 20460 (Attention: Warranty Claim).

Scooter Noise Regulation

TAMPERING WITH THE NOISE CONTROL SYSTEM IS PROHIBITED

Federal law prohibits the following acts or the causing thereof: (1) The removal or rendering inoperative by any person other than for purposes of maintenance, repair, or replacement of any device or element of design incorporated into any new vehicle for the purpose of noise control prior to its sale or delivery to the ultimate purchase or while it is in use or (2) the use of the vehicle after such device or element of design has been removed or rendered inoperative by any person. "AMONG THOSE ACTS PRESUMED TO CONSTITUTE TAMPERING ARE THE ACTS LISTED BELOW." These acts include tampering with the following systems; i.e., modification, removal, etc.

Exhaust system

- Muffler/Catalyst

Intake System

- Air Filter Case
- Air Filter Element



Manufactured for Pacific Cycle, Inc. (A Division of Dorel Industries)
Pacific Cycle, Inc., 4902 Hammersley Road, Madison, WI 53711

©2006 Pacific Cycle, Inc. • Made in China • Printed March 2006
Schwinn® is a registered trade mark of Pacific Cycle, Inc.
www.schwinn scooters.com

Free Manuals Download Website

<http://myh66.com>

<http://usermanuals.us>

<http://www.somanuals.com>

<http://www.4manuals.cc>

<http://www.manual-lib.com>

<http://www.404manual.com>

<http://www.luxmanual.com>

<http://aubethermostatmanual.com>

Golf course search by state

<http://golfingnear.com>

Email search by domain

<http://emailbydomain.com>

Auto manuals search

<http://auto.somanuals.com>

TV manuals search

<http://tv.somanuals.com>