

COM 190

Gebrauchsanleitung
Instructions for use
Notices d'emploi
Istruzioni per l'uso
Instrucciones para el uso
gebruiksaanwijzing

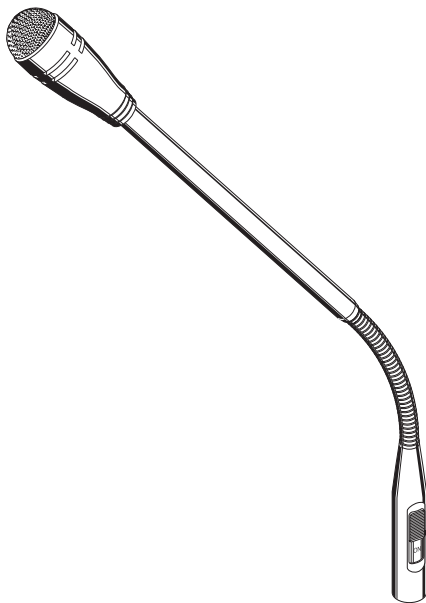

COM 190 Dynamisches Mikrofon

Dynamisches Mikrofon
mit Nierencharakteristik.
Integrierter Schwannenhals
mit Schalter und XLR-Stecker.



Merkmale

- Gute Richtwirkung
- kleine und unauffällige Bauform
- sehr rückkopplungsarm

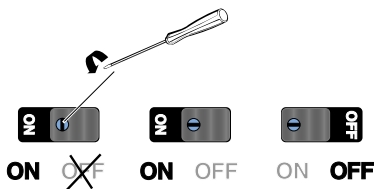

Technische Daten

Akustische Arbeitsweise	Druckgradientenempfänger
Übertragungsbereich	40 - 18.000 Hz
Richtcharakteristik	Niere
Feldleerlauf- Übertragungsfaktor bei 1 kHz	1,8 mV/ Pa \pm 3 dB (= - 55 dBV)
Nennimpedanz bei 1 kHz	350 Ω
Min. Abschlußimpedanz	1000 Ω
Stecker	XLR-3
Maße	\varnothing 33 mm, Länge 400 mm
Gewicht	60 g
Lieferumfang	1 Mikrofon

Änderungen vorbehalten

COM 190 Dynamic Microphone

Dynamic microphone with cardioid characteristic. Integrated swan-neck with switch and XLR plug.

Features

- Good directivity
- Small and inconspicuous design
- Extremely low feedback

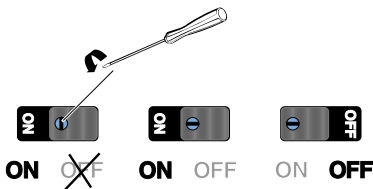

Technical Data

Acoustic operating mode	Pressure-gradient receiver
Transmission range	40 - 18.000 Hz
Directivity characteristic	Cardioid
Field open-circuit sensitivity at 1 kHz	1.8 mV/ Pa \pm 3 dB (= - 55 dBV)
Nominal impedance at 1 kHz	350 Ω
Min. terminating impedance	1000 Ω
Plug	XLR-3
Dimensions	33 mm \varnothing , 400 mm long
Weight	60 g
Product package includes	1 microphone

Subject to alterations

Microphone dynamique COM 190

Microphone dynamique à caractéristique cardioïde. Pour montage sur col de cygne à connecteur XLR-3, à interrupteur intégré.

Caractéristiques

- Bonne directivité
- Forme réduite et discrète
- Très faible rétroaction

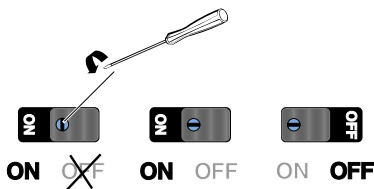

Caractéristiques techniques

Procédé acoustique	microphone de vitesse
Bande passante	40 - 18.000 Hz
Directivité	cardioïde
Facteur de transmission à vide pour 1 kHz	1,8 mV/ Pa \pm 3 dB (= - 55 dBV)
Impédance pour 1 kHz	350 Ω
Impédance terminale max.	1000 Ω
Connecteur	XLR 3
Dimensions	\varnothing 33 mm, longueur 400 mm
Poids	60 g
Fourniture	1 microphone

Sous réserve de modifications

Microfono dinamico COM 190

Microfono dinamico con caratteristica cardioide per il montaggio su un condotto flessibile con collegamento a spina XLR-3.

Caratteristiche

- Buona direttività
- Costruzione piccola e non appariscente
- Feedback minimo

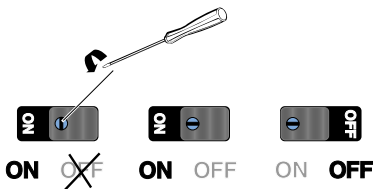

Dati tecnici

Funzionamento acustico	Ricevitore a gradiente di pressione
Gamma di trasmissione	40 - 18.000 Hz
Caratteristica di direzionalità	Cardioide
Fattore di trasmissione a vuoto a 1 kHz	1,8 mV/ Pa ± 3 dB (= - 55 dBV)
Impedenza elettrica a 1 kHz	350 Ω
Impedenza terminale min.	1000 Ω
Spina	XLR-3
Dimensioni	\varnothing 33 mm, lunghezza 400 mm
Peso	60 g
Fornitura	1 microfono

Con riserva di modifiche

Microfono dinámico COM 190

Microfono dinámico con característica reniforme para montaje sobre un soporte en forma de cuello de cisne con interruptor y enchufe XLR-3.

Características

- Buena característica direccional
- Tamaño pequeño y discreto
- Muy baja realimentación acústica

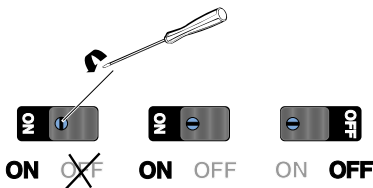
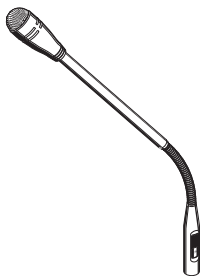

Datos técnicos

Funcionamiento acústico	Receptor por caída de presión
Gama de transmisión	40 - 18.000 Hz
Característica direccional	Reniforme
Factor de transmisión de campo en circuito abierto a 1 kHz	1,8 mV/ Pa \pm 3 dB (= - 55 dBV)
Impedancia eléctrica a 1 kHz	350 Ω
Impedancia terminal mínima	1000 Ω
Enchufe	XLR-3
Medidas	\varnothing 33 mm, longitud 400 mm
Peso	60 g
El suministro incluye	1 micrófono

Reserva de modificaciones

COM 190 Dynamische Microfoon

Dynamische microfoon met nierenkarakteristiek. Geëntegreede zwanehals met schakelaar en XLR-3-steekverbinding.

Kenmerken

- Goede richtwerking
- kleine en onopvallende bouwwijze
- vrijwel zonder terugwerking

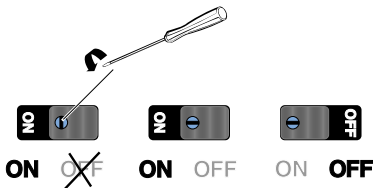

Technische Gegevens

Akoestische werkwijze	Gradientdrukontvanger
Overdrachtsbereik	40 - 18.000 Hz
Richtkarakteristiek	nieren
Overdrachtsfactor bij 1 kHz bij bij onbelaste werking van veld	1,8 mV/ Pa \pm 3 dB (= - 55 dBV)
Elektrische impedantie bij 1 kHz	350 Ω
Minimum afsluitimpedantie	1000 Ω
Stekker	3-polige XLR-3-stekker (Canon)
Afmetingen	\varnothing 33 mm, lengte 400 mm
Gewicht	60 g
Omvang van de levering	1 microfoon

Wijzigingen voorbehouden

Soll-Frequenzgang / Polardiagramm
 Nominal frequency response / Pick-up pattern
 Réponse en fréquence / Diagramme de la directivité
 Risposta in frequenza / Diagramma polare
 Respuesta en frecuencia / Diagrama de la directividad
 Ingestelde frequentiekarakteristiek / Pooldiagrammen

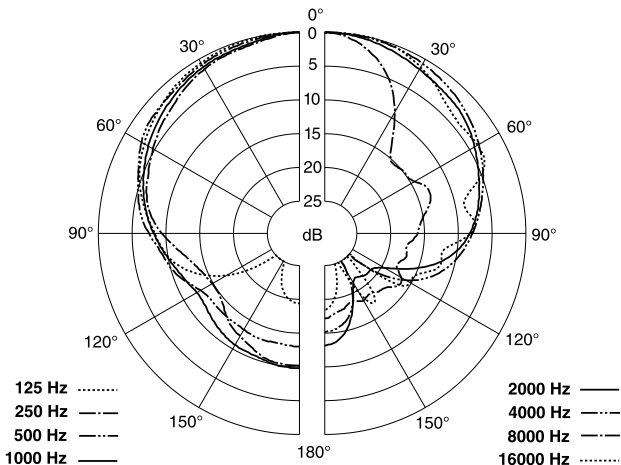
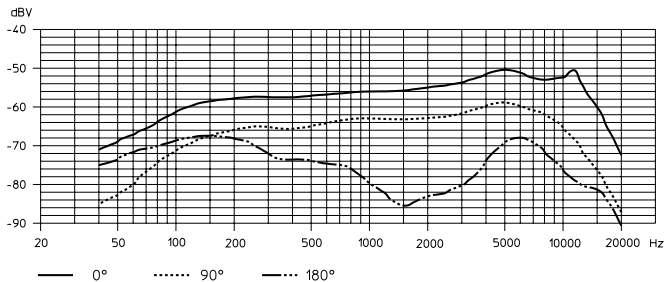

Free Manuals Download Website

<http://myh66.com>

<http://usermanuals.us>

<http://www.somanuals.com>

<http://www.4manuals.cc>

<http://www.manual-lib.com>

<http://www.404manual.com>

<http://www.luxmanual.com>

<http://aubethermostatmanual.com>

Golf course search by state

<http://golfingnear.com>

Email search by domain

<http://emailbydomain.com>

Auto manuals search

<http://auto.somanuals.com>

TV manuals search

<http://tv.somanuals.com>