

# EM 3731 EM 3732 EM 3732 Command

Instructions for use

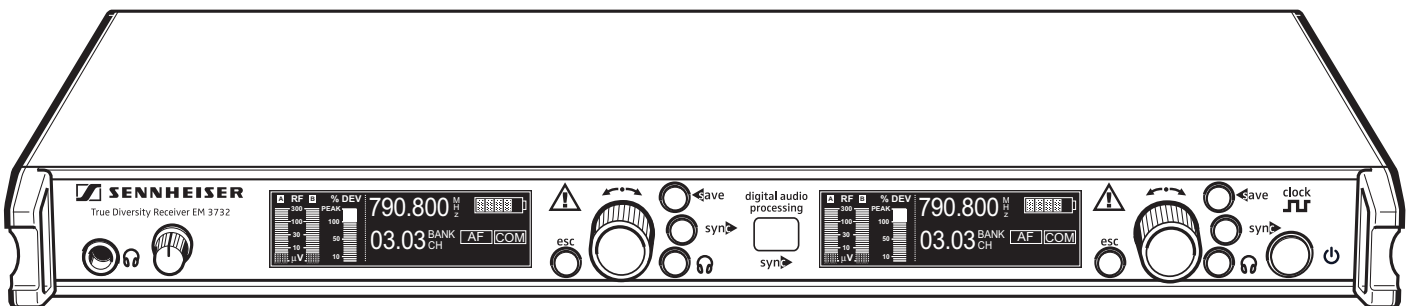



# Contents

Important safety instructions .....	2
Delivery includes .....	4
The EM 3731/3732 receiver family .....	5
The frequency bank system .....	5
Overview of operating controls .....	7
Overview of the display .....	8
Brightness control .....	8
Indications and displays .....	9
Reception display .....	9
Status display .....	10
Putting the receiver into operation .....	13
Fitting the device feet .....	13
Rack mounting .....	13
Connecting the antennas .....	14
Daisy chaining up to eight twin receivers .....	16
Connecting the receiver to the mains/disconnecting the receiver from the mains .....	17
Connecting the amplifier/mixing console .....	17
Connecting devices with AES3 digital input .....	17
Connecting an external word clock generator .....	18
Connecting the receivers to a PC via Ethernet .....	18
Using the receiver .....	19
Switching the receiver on/off .....	19
Connecting the headphones/adjusting the volume .....	20
Deactivating the lock mode .....	20
Synchronizing the transmitter with the receiver frequency .....	21
The operating menu .....	22
Overview of menus .....	22
Working with the operating menu .....	23
Operating menu of the receivers .....	24
Adjustment tips for the operating menu .....	28
Additional information .....	38
HiDyn plus™ (HDP) noise reduction .....	38
Squelch .....	38
Diversity reception .....	39
If a problem occurs ... ..	40
Specifications .....	41
Accessories/spare parts .....	43
Manufacturer Declarations .....	44

Thank you for choosing Sennheiser!

We have designed this product to give you reliable operation over many years. Over 60 years of accumulated expertise in the design and manufacture of high-quality electro-acoustic equipment have made Sennheiser a world-leading company in this field.

Please take a few moments to read these instructions carefully, as we want you to enjoy your new Sennheiser products quickly and to the fullest.

## Important safety instructions

1. Read these instructions.
2. Keep these instructions.
3. Heed all warnings.
4. Follow all instructions.
5. Do not use this apparatus near water.
6. Clean only with dry cloth.
7. Do not block any ventilation openings. Install in accordance with the manufacturer's instructions.
8. Do not install near any heat sources such as radiators, heat registers, stoves, or other apparatus (including amplifiers) that produce heat.
9. Do not defeat the safety purpose of the polarized or grounding-type plug. A polarized plug has two blades with one wider than the other. A grounding type plug has two blades and a third grounding prong. The wide blade or the third prong are provided for your safety. If the provided plug does not fit into your outlet, consult an electrician for replacement of the obsolete outlet.
10. Protect the power cord from being walked on or pinched, particularly at plugs, convenience receptacles, and the point where they exit from the apparatus.
11. Only use attachments/accessories specified by the manufacturer.
12. Use only with the cart, stand, tripod, bracket, or table specified by the manufacturer, or sold with the apparatus. When a cart is used, use caution when moving the cart/apparatus combination to avoid injury from tip-over.
13. Unplug this apparatus during lightning storms or when unused for long periods of time.
14. Refer all servicing to qualified service personnel. Servicing is required when the apparatus has been damaged in any way, such as power supply cord or plug is damaged, liquid has been spilled or objects have fallen into the apparatus, when the apparatus has been exposed to rain or moisture, does not operate normally, or has been dropped.
15. To completely disconnect this apparatus from the AC mains, disconnect the power supply cord plug from the AC receptacle.
16. **WARNING:** To reduce the risk of fire or electric-shock, do not expose this apparatus to rain or moisture.
17. Do not expose this equipment to dripping or splashing and ensure that no objects filled with liquids, such as vases, are placed on the equipment.
18. The mains plug of the power supply cord shall remain readily operable.





### Hazard warnings on the rear of the receiver

The label shown on the left is attached to the rear of the device. The symbols on this label have the following meaning:

This symbol is intended to alert the user to the presence of uninsulated dangerous voltage within the device's enclosure that may be of sufficient magnitude to constitute risk of fire or electric shock.

This symbol is intended to alert the user to the risk of electric shock if the device is opened. There are no user serviceable parts inside. Refer servicing to qualified personnel only.

This symbol is intended to alert the user to the presence of important operating and maintenance instructions in the literature accompanying this device.

### Power source

This device should be operated only from the type of power source indicated on the type plate. If you are not sure of the type of power supply to your building, consult your dealer or local power company.

### Overloading

Do not overload wall outlets and extension cords as this may result in fire and electric shock.

### Replacement parts

When replacement parts are required, be sure the service technician has used replacement parts specified by the manufacturer or those having the same characteristics as the original part. Unauthorized substitutions may result in fire, electric shock, or other hazards.

### Safety check

Upon completion of any service or repairs to this device, ask the service technician to perform safety checks to determine that the device is in safe operating order.

### Danger of hearing damage due to high volumes

This is a professional receiver. Commercial use is subject to the rules and regulations of the trade association responsible. Sennheiser, as the manufacturer, is therefore obliged to expressly point out possible health risks arising from use.

This receiver is capable of producing sound pressure exceeding 85 dB(A). 85 dB(A) is the sound pressure corresponding to the maximum permissible volume which is by law (in some countries) allowed to affect your hearing for the duration of a working day. It is used as a basis according to the specifications of industrial medicine. Higher volumes or longer durations can damage your hearing. At higher volumes, the duration must be shortened in order to prevent hearing damage. The following are sure signs that you have been subjected to excessive noise for too long a time:

- You can hear ringing or whistling sounds in your ears.
- You have the impression (even for a short time only) that you can no longer hear high notes.

### Intended use of the receiver

Intended use of the EM 3731 single receiver or the EM 3732 and EM 3732 Command twin receivers includes:

- using the device for professional purposes,
- having read these instructions, especially the chapter "Important safety instructions" on page 2,
- using the device within the operating conditions and limitations described in this instruction manual.

"Improper use" means using the receiver other than as described in these instructions, or under operating conditions which differ from those described herein.

## Delivery includes

Delivery of the receiver includes:

- 1 EM 3732 Command twin receiver or  
1 EM 3732 twin receiver or  
1 EM 3731 single receiver
- 3 mains cables (with EU, UK and US plug)
- 2 BNC antenna daisy chain cable (50  $\Omega$ )
- 1 BNC word clock daisy chain cable (75  $\Omega$ )
- 4 device feet
- 1 RJ 45 Ethernet cable
- 2 antennas
- 1 instruction manual
- 1 CD ROM with:
  - the "Wireless Systems Manager" (WSM) PC software
  - the instruction manual of the "Wireless Systems Manager" software

## The EM 3731/3732 receiver family

The receivers of the EM 3731/3732 receiver family ensure highest reception reliability and offer unmatched ease of use. Due to their large switching bandwidth and numerous connection options, these receivers provide maximum flexibility in daily operation.

The EM 3731/3732 receiver family is comprised of the following models:

- EM 3732 Command twin receiver
- EM 3732 twin receiver
- EM 3731 single receiver

All EM 3731/3732 receivers have the following features:

- 90 MHz switching bandwidth
- Scan function
- Frequencies tunable in steps of 5 kHz
- True diversity reception
- Integrated antenna splitter for daisy chaining up to eight receivers
- DSP-based audio expander, HiDyn *plus*<sup>™</sup> (HDP)
- AES3 digital audio output
- External word clock synchronization of the digital audio output
- Audio output level can be set in increments of 1 dB
- Transformer balanced audio outputs
- Command audio output (EM 3732 Command receiver only)
- Ethernet socket for connection to a PC
- Receivers can be monitored and remote controlled using the supplied Sennheiser WSM PC software
- Operation via jog dial
- Hot keys for storing, synchronization, headphone selection and escape function
- Intuitive, icon-based operating menu
- Display with high contrast and intensity
- LEDs for indicating warning states
- Infra-red synchronization of receiver settings to suitable transmitters
- Both receivers of a twin receiver can be monitored – individually or simultaneously – via headphones

### The frequency bank system

The receivers with their 90 MHz switching bandwidth are available in nine UHF frequency ranges. Please note: Frequency usage is different for each country. Your Sennheiser agent will have all the necessary details on the available legal frequencies for your area.

Range A:	470 to 560 MHz	Range F:	708 to 798 MHz
Range B:	518 to 608 MHz	Range G:	776 to 866 MHz
Range C:	548 to 638 MHz	Range H:	814 to 904 MHz
Range D:	614 to 704 MHz	Range I:	870 to 960 MHz
Range E:	678 to 768 MHz		

The receivers have seven frequency banks.

Channel	Frequency bank						U
	1	2	3	4	5	6	
	Optimized for the maximum number of channels			Optimized for maximum transmission reliability			
1	The receiving frequencies are factory-preset (see enclosed frequency table) and cannot be changed.						The receiving frequencies can be freely selected within the switching bandwidth.
2							
...							
max. 60							

**CAUTION! Risk of reception interference!**



If – within the receiver’s frequency range – transmitters transmit on channels from different frequency banks, reception can be subject to interference and inter-modulation. Only the factory-preset frequencies within the frequency banks “1” to “6” are interference and inter-modulation free.

- ▶ Set all transmitters of a multi-channel system to different channels within the same frequency bank.

Distribution of the receiving frequencies within the frequency banks 1 to 6:

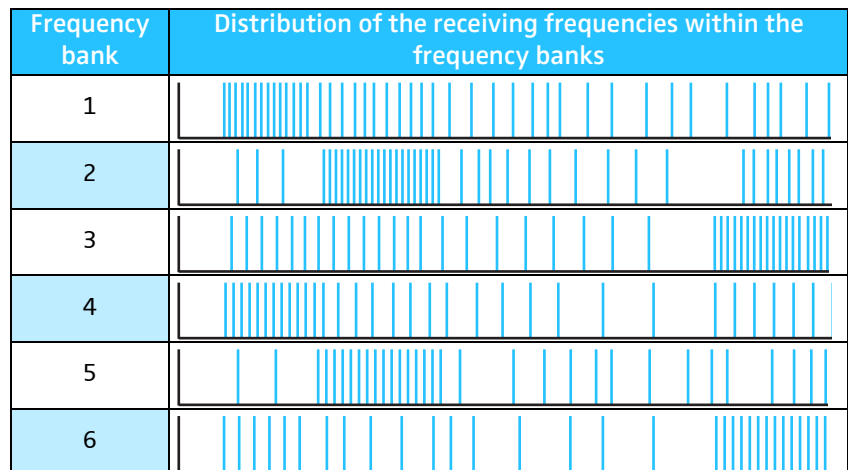

The varying accumulation of frequencies within the frequency banks allows you to use as many channels as possible in a crowded frequency band.



# Overview of operating controls

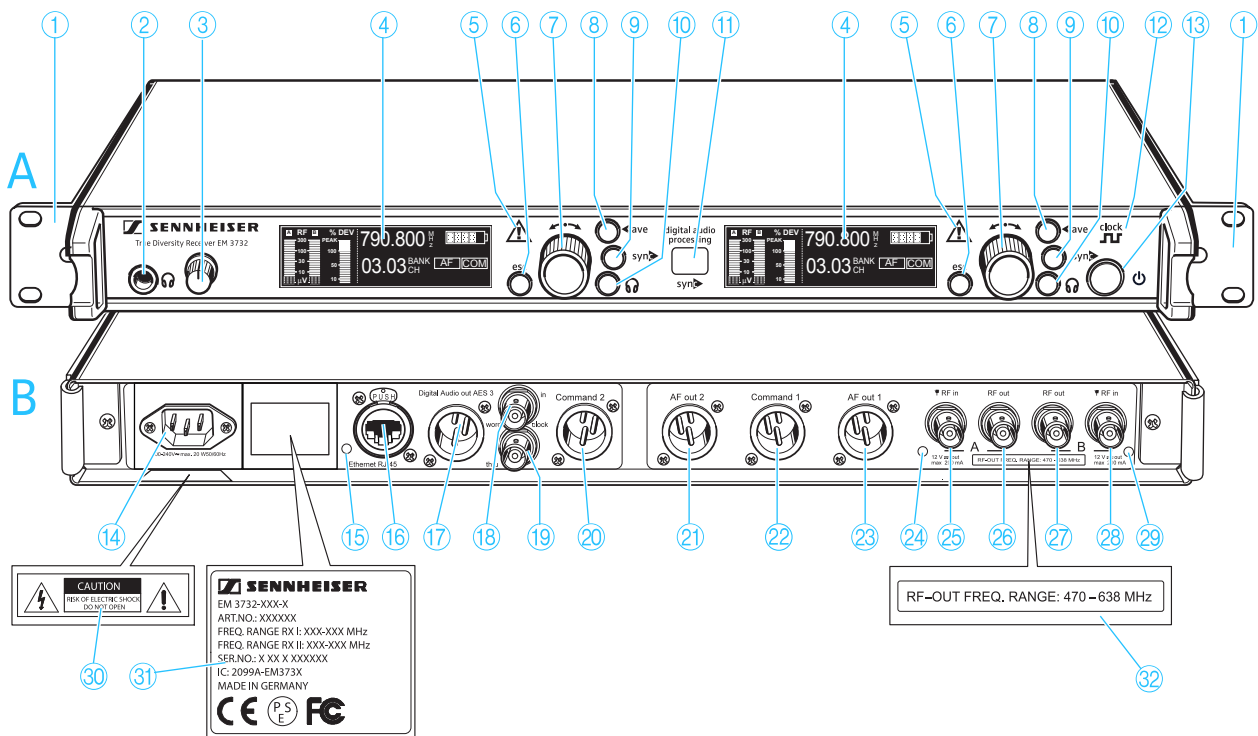

## A Front panel

- ① Rack mount "ears"
- ② Headphone output, 1/4" (6.3 mm) jack socket
- ③ Headphone volume control
- ④ Display (see next page)
- ⑤ Warning triangle indicating error states
- ⑥ **esc** button, backlit
- ⑦ Jog dial
- ⑧ **save** button, backlit
- ⑨ **sync** button, backlit
- ⑩ Headphone button, backlit (except EM 3731 single receiver)
- ⑪ Infra-red interface
- ⑫ Display for external word clock synchronization
- ⑬ **⏻** button, backlit

## B Rear panel

- ⑭ 3-pin mains socket
- ⑮ LED for LAN data transmission
- ⑯ RJ 45 socket for LAN connection
- ⑰ XLR-3 socket (male) for digital audio output, digital balanced, AES3
- ⑱ BNC socket for word clock input (75 Ω)

- ⑲ BNC socket for word clock daisy chain output (75 Ω)
- ⑳ XLR-3 socket (male) for Command output 2\*, balanced (EM 3732 Command twin receiver only)
- ㉑ XLR-3 socket (male) for audio output AF out 2\*, balanced (except EM 3731 single receiver)
- ㉒ XLR-3 socket (male) for Command output 1\*, balanced (EM 3732 Command twin receiver only)
- ㉓ XLR-3 socket (male) for audio output AF out 1\*, balanced
- ㉔ LED for booster supply of antenna input A
- ㉕ BNC socket, antenna input A (ANT A – RF in, DC OUT, 50 Ω)
- ㉖ BNC socket, daisy chain output A (ANT A – RF out)
- ㉗ BNC socket, daisy chain output B (ANT B – RF out)
- ㉘ BNC socket, antenna input B (ANT B – RF in, DC OUT, 50 Ω)
- ㉙ LED for booster supply of antenna input B
- ㉚ Label with hazard warnings
- ㉛ Type plate
- ㉜ Label with frequency range for daisy chaining

\*) The audio outputs marked with the number "1" output the audio signal of the left receiver of the twin receiver (as viewed from the front); the audio outputs marked with the number "2" output the audio signal of the right receiver.

## Overview of the display

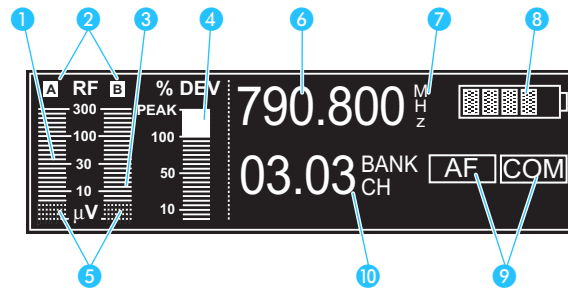

### Reception display

- 1 RF level display "RF" for antenna A
- 2 Diversity display (antenna A or antenna B active)
- 3 RF level display "RF" for antenna B
- 4 Audio level display "Dev"
- 5 Display of the squelch threshold

For additional information see pages 9 and 10.

### Status display

- 6 Frequency display
- 7 "MHz" – appears when the frequency is displayed
- 8 6-step transmitter battery status display
- 9 Command display (status display of the audio outputs AF and COM) (EM 3732 Command twin receiver only)
- 10 Display for the current frequency bank and channel or the name

For additional information see pages 10 and 11.

### Brightness control

The display has an automatic brightness control. The brightness is dimmed after the last key stroke. With each new button press, the display lights up with full brightness.

Triggers for dimming	after	Behavior of the display
No service	60 s	Display is slightly dimmed
Squelch not reached	20 min	Display turned off

## Indications and displays

The displays provide information on the operating states of the corresponding receiver and those of the received transmitter.

### Reception display

The reception display is permanently displayed. If you do not press a button on the transmitter, the display will dim after 60 seconds (see page 8).

#### RF level display "RF" for the antennas

The left bargraph **1** shows the strength of the received RF signal for antenna A; the right bargraph **3** shows the strength of the received RF signal for antenna B.

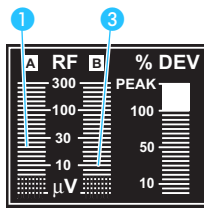

When the RF signal of the received transmitter is too weak on both antennas:

- the text "Mute" flashes in alternation with the status display,
- the warning triangle for indicating error states **5** lights up red,
- the receiver is automatically muted to suppress hissing noise.

#### Display of the squelch threshold

The top edge of the rastered area **5** shows the adjusted squelch threshold. The squelch threshold can be adjusted in the "Squelch" menu (see "Adjusting the squelch threshold" on page 30).

If the squelch threshold is not reached for 20 minutes, the display dims. (see page 8).

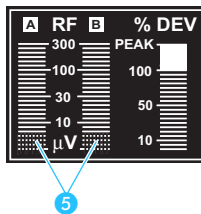

#### Diversity display

The receivers operate on the true diversity principle (see "Diversity reception" on page 39). The diversity display **2** indicates whether diversity section A (i.e. antenna A) or diversity section B (i.e. antenna B) is active. The letter of the active diversity section appears backlit.

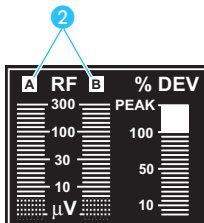

### Audio level display "Dev"

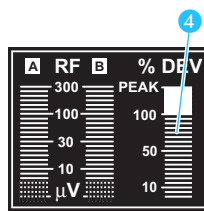

The audio level display "Dev" ④ shows the modulation of the received transmitter.

When the transmitter's audio input level is excessively high, the receiver's audio level display "Dev" ④ shows more than 100 %.



When the transmitter is overmodulated frequently or for an extended period of time, the text "AF Peak" appears and the warning triangle for indicating error states ⑤ lights up red.

### Status display

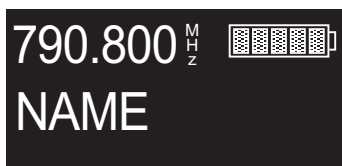

The status shows the receiving frequency, the transmitter battery status and – depending on the selection made in the "Display" menu – either the frequency bank and the channel number or the name of the receiver. With the EM 3732 Command receiver, the command display can also be displayed within the status display. The contents of the status display can be changed in the "Display" menu (see page 36).

When pressing the jog dial ⑦, the status display is replaced by the operating menu (see "Working with the operating menu" on page 23).

When in the operating menu, you can return to the status display by pressing the `esc` button ⑥ one or several times.

### Frequency display



The frequency display ⑥ shows the current receiving frequency in MHz.

### Display for the current frequency bank and channel or the name



The display for the current frequency bank and channel or the name ⑩ shows – depending on the selection made in the "Display" menu – the following:

- Frequency bank "1 ... 6, U" and channel number "1 ... 60"
- Name

### Transmitter battery status display



The 6-step transmitter battery status display <sup>8</sup> provides information on the transmitter's remaining battery/accupack capacity:

Number of segments	Capacity	
	Accupack	Battery
	approx. 100 %	full
	approx. 80 %	-
	approx. 60 %	half-full
	approx. 40 %	-
	approx. 20 %	-
(Low Batt)	approx. 0 %	almost empty

**Note:**

If no battery/accupack status signal is received, the battery status display is not shown.



When the battery/accupack is almost empty, text "Low Batt" flashes in alternation with the status display. In addition, the warning triangle for indicating error states <sup>5</sup> lights up red.

### Command display (status display of the audio outputs AF and COM)



The command display is only available with the EM 3732 Command twin receiver.

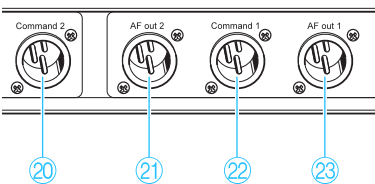

Besides the two audio outputs <sup>21</sup> and <sup>23</sup>, the EM 3732 Command twin receiver also features two command outputs <sup>20</sup> and <sup>22</sup>.

Via the "Command" menu, you can configure the receiver so that – with the command button of the transmitter pressed – the audio signal is available at only one of the outputs or at both (see "Configuring the audio outputs of the EM 3732 Command twin receiver" on page 32).

The command display <sup>9</sup> shows the audio output at which the transmitter's audio signal is available.



When "AF" lights up brightly, the audio signal is available at the audio output <sup>21</sup> or <sup>23</sup>.



If the "AF" symbol does not appear, the audio signal is **not** issued on the audio output <sup>21</sup> or <sup>23</sup>.



When "COM" lights up brightly, the audio signal is available at the command output <sup>20</sup> or <sup>22</sup>.



If the "COM" symbol does not appear, the audio signal is **not** issued on the command output <sup>20</sup> or <sup>22</sup>.

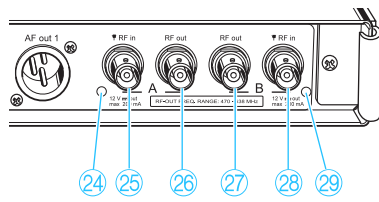

### LEDs for booster supply of antenna inputs

The LEDs for booster supply of antenna input A ②④ or B ②⑨ **light up** when

- the booster supply voltage is applied to the corresponding antenna input A ②⑤ or B ②⑧.

The LEDs for booster supply of antenna input A ②④ or B ②⑨ **go off** when

- the booster supply voltage for the corresponding antenna input A ②⑤ or B ②⑧ is switched off or
- the booster supply voltage is short-circuited or overloaded.

## Putting the receiver into operation

### Fitting the device feet

When the receiver is not installed in a rack, avoid the receiver sliding around and reduce the chance of damage to the receiver and to any surface on which it is placed by fixing the four soft rubber self adhesive feet to the base of the receiver in the positions indicated.

**Note:**

Do not fit the rubber feet when rack mounting the receiver.

---

**CAUTION! Risk of staining of furniture surfaces!**



Some furniture surfaces have been treated with varnish, polish or synthetics which might cause stains when they come into contact with other synthetics. Despite a thorough testing of the synthetics used by us, we cannot rule out the possibility of staining.

- ▶ Do not place the receiver on delicate surfaces.

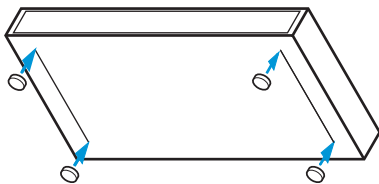

- 
- ▶ Ensure that the base of the receiver is clean and free from grease before fitting the rubber feet.
  - ▶ Fix the rubber feet to the base of the receiver by peeling off the backing paper and fitting them as shown in the diagram on the left.

### Rack mounting

---

**CAUTION! Risks when rack mounting the receiver!**



When installing the device in a closed or multi-rack assembly, please consider that, during operation, the ambient temperature within the rack may significantly rise above room temperature.

- ▶ The ambient temperature within the rack must not exceed the temperature limit specified in the specifications.
  - ▶ When installing the device in a rack, take good care not to affect the ventilation required for safe operation or provide additional ventilation.
  - ▶ Make sure the mechanical loading of the rack is even to avoid a hazardous condition such as a severely unbalanced rack.
  - ▶ When connecting the device to the power supply, observe the information indicated on the type plate. Avoid circuit overloading. If necessary, provide overcurrent protection.
  - ▶ Ensure a reliable mains ground connection of the device by taking appropriate measures.
  - ▶ When installing the device in a closed or multi-rack assembly, please note that intrinsically harmless leakage currents of the individual devices may accumulate, thereby exceeding the allowable limit value. As a remedy, ground the rack via an additional ground connection.
-

The rack mount "ears" are already attached to the receiver at the factory. To mount the device into a 19" rack:

- ▶ Slide the receiver into the 19" rack.
- ▶ Secure the rack mount "ears" ① to the rack using four screws (not included).

## Connecting the antennas

### CAUTION! Danger of short-circuit due to uninsulated antennas!



If you switch the booster supply voltage on, a 12 V DC voltage is applied to the antennas – **even when you switch the receiver off!** If uninsulated antennas come into contact with objects which conduct electricity, this voltage can produce sparking and audio interference.

- ▶ Either use insulated antennas or
- ▶ always mount uninsulated antennas so that they cannot come into contact with objects which conduct electricity.

The two antenna inputs ②⑧ and ②⑤ allow you to connect either:

- the two supplied telescopic antennas to the rear of the receiver (see next section) or
- the two supplied telescopic antennas to the front of the receiver (see "Mounting the antennas to the front of the rack" on page 15) or
- two remote antennas to the rear of the receiver (see "Mounting and connecting remote antennas" on page 16).

In addition, the receiver has two daisy chain outputs ②⑦ and ②⑥ for supplying the antenna signals to further receivers (see "Daisy chaining receivers" on page 16).

### Connecting the antennas to the rear of the receiver

The telescopic antenna can be mounted quickly and easily and are suitable for all applications where – good reception conditions provided – a wireless transmission system is to be used without a large amount of installation work.

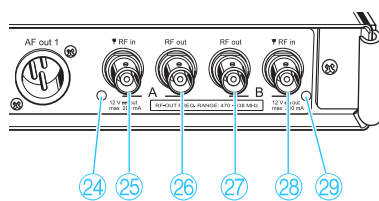

- ▶ Connect the telescopic antennas to the BNC sockets ②⑤ and ②⑧ at the rear of the receiver.
- ▶ Align the telescopic antennas upwards in a V-shape.



### Mounting the antennas to the front of the rack

When rack mounting the receiver, you require the GA 3030 AM antenna mount (available as an accessory) to mount the antenna connections to the front of the rack. The GA 3030 AM antenna mount consists of:

- 2 BNC extension cables (screw-in BNC socket 33 to BNC connector 37)
- 2 antenna holders 36
- 4 screws
- 2 washers 35
- 2 nuts 34

- ▶ Unsecure the rack mount "ears" 1 from the rack.
- ▶ Guide the BNC cables through the holes in the rack mount "ears" as shown in the diagram on the left.

- ▶ Screw the antenna holders 36 to the BNC sockets 35 using the supplied washers 34 and nuts 33.

- ▶ Secure the antenna holders 36 to the handles of the receiver using two of the supplied screws respectively.

- ▶ Connect the two BNC connectors 37 to the BNC sockets 25 and 28 at the rear of the receiver.

- ▶ Slide the receiver into the 19" rack.
- ▶ Resecure the rack mount "ears" 1 to the rack.
- ▶ Connect the antennas 38 to the BNC sockets 33.
- ▶ Align the antennas upwards in a V-shape.

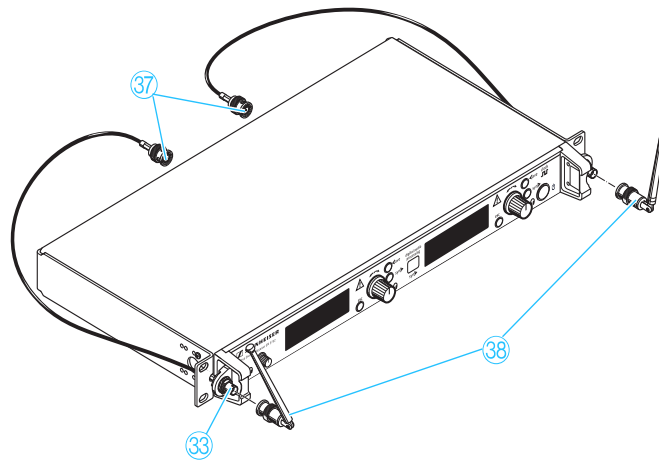
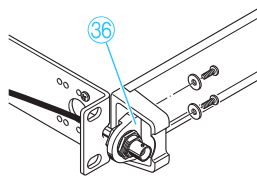
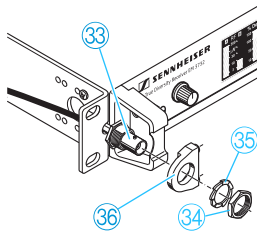
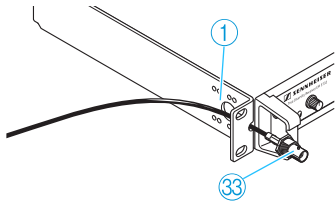
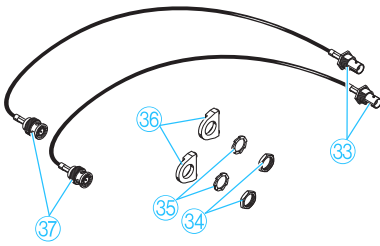

### Mounting and connecting remote antennas

Use a remote antenna (available as accessories) when the receiver position is not the best antenna position for optimum reception.

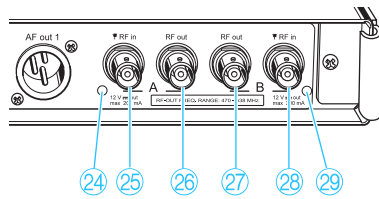

- ▶ Connect the remote antennas to the BNC sockets 25 and 28 at the rear of the receiver using a low-attenuation 50-Ω coaxial cable.

**Note:**

Ready-made antenna cables from Sennheiser are available as accessories with length of 1 m, 5 m and 10 m (see "Accessories/spare parts" on page 43).

- ▶ If you connect active antennas (e.g. A 3700, AD 3700) or antenna boosters (e.g. AB 3700), switch the DC supply voltage for external active antennas and antenna boosters on (see page 30) so that the LEDs 24 and 29 light up; if you do not connect active antennas or antenna boosters, switch the booster supply voltage off so that the LEDs 24 and 29 do not light up.

**Note:**

If the booster supply voltage is switched on (see page 30), it remains switched on even when the receiver is switched off.

- ▶ Position antennas in the same room in which the transmission takes place! Maintain a minimum distance of 1 m between antennas and a minimum distance of 50 cm between antennas and metal objects (including reinforced concrete walls)!

### Daisy chaining receivers

The receivers feature an integrated antenna splitter so that up to eight receivers can be daisy chained using the supplied short antenna daisy chain cables. The label 32 indicates the daisy chained frequency range.

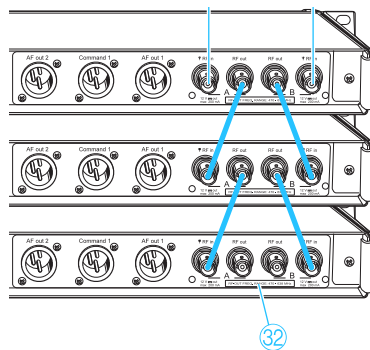

- ▶ Connect the two supplied telescopic antennas or two remote antennas (available as accessories) to the BNC sockets 25 and 28 at the rear of the first receiver.
- ▶ Use the supplied 50 Ω antenna cables to daisy chain the receivers as shown in the diagram on the left.

**Note:**

The antenna signals are also daisy chained when a receiver is switched off. If the booster supply voltage is switched on (see page 28), it remains switched on even when the receiver is switched off.

## Connecting the receiver to the mains/disconnecting the receiver from the mains

### CAUTION! Damage due to electric current!



If you connect the receiver to an unsuitable power supply, this can cause damage to the device.

- ▶ Use the supplied mains cable to connect the receiver to the mains (100 to 240 V AC, 50 or 60 Hz).
- ▶ Ensure a reliable mains ground connection of the receiver – especially when you are using multi-outlet power strips or extension cables.

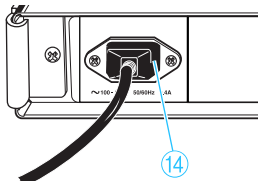

The receiver has no mains switch. To connect the receiver to the mains:

- ▶ Connect the supplied mains cable to the 3-pin mains socket (14).
- ▶ Plug the mains connector into the wall socket.

To disconnect the receiver from the mains:

- ▶ Pull out the mains connector from the wall socket. All daisy chained signals are interrupted, i.e.:
  - the antenna signals at the daisy chain outputs (27) and (26),
  - the booster supply voltage,
  - the signals of the external word clock generator.

## Connecting the amplifier/mixing console

The receiver has transformer balanced audio outputs.

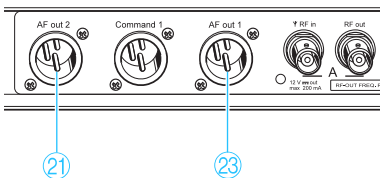

- ▶ Connect the amplifier/mixing console to the XLR-3 socket AF out 1 (23) (left receiver) or to the XLR-3 socket AF out 2 (21) (right receiver).
- ▶ Via the operating menu of the corresponding receiver, adjust the level of the audio output to the input of the amplifier or mixing console (see "Adjusting the audio output level" on page 31).

## Connecting devices with AES3 digital input

The digital balanced XLR-3M audio output (17) outputs the signals of both receivers in AES3 format.

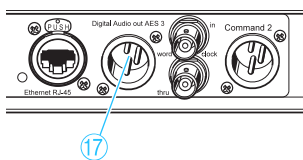

- ▶ Use a special double-shielded 110 Ω AES3 cable to connect the device with AES3 digital input to the digital balanced XLR-3M audio output (17). This ensures that the digital data transmission interferes with the RF reception.

### Note:

A ready-made AES3 cable from Sennheiser is available as an accessory with a length of 10 m (see "Accessories/spare parts" on page 43).

- ▶ Via the "Clock" menu, select the desired sampling rate (see "Selecting the sampling rate for digitalization" on page 31).

## Connecting an external word clock generator

The receiver can digitalize the audio signal and output it via the digital balanced XLR-3M audio output (17). The built-in A/D converter supports sampling rates of 44.1 kHz, 48 kHz, 88.2 kHz and 96 kHz.

If you want to connect an external word clock generator instead, proceed as follows:

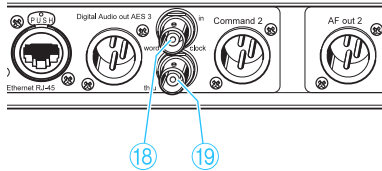

- ▶ Use a shielded 75 Ω coaxial BNC cable to connect the external word clock generator to the BNC socket (18).

- ▶ Select "Ext." in the "Clock" menu (see "Selecting the sampling rate for digitalization" on page 31).

The display for external word clock synchronization (12):

- lights up permanently when the digital audio output of the receiver is synchronized with the external word clock generator,
- flashes when "Ext." is selected in the "Clock" menu but no external word clock generator is connected,
- flashes when the signal of the external word clock generator is available but has not synchronized the digital audio output of the receiver
- is off when the receiver's internal word clock generator is used.

### Notes:

- Both receivers of a twin receiver use the same word clock signal.
- The receiver has a BNC socket for word clock daisy chain output (19) for supplying the word clock signal to further daisy chained receivers using the supplied BNC word clock daisy chain cable. The word clock signal is also daisy chained when a receiver is switched off.

## Connecting the receivers to a PC via Ethernet

The receivers can be centrally configured and monitored via a PC and the supplied "Wireless Systems Manager" software. Additionally, you can update the firmware in the receivers.

To connect the receivers to a PC:

### Note:

If you want to connect several receivers to the same Ethernet socket of your network, you require a standard 100Base-T Ethernet switch.

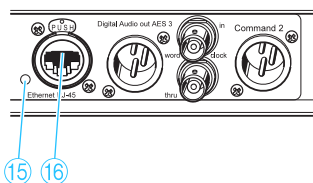

- ▶ Connect the supplied RJ 45 Ethernet cable to the RJ 45 socket for LAN connection (16) and to your switch or network.

- ▶ Install the "Wireless Systems Manager" software on your PC.

- ▶ Continue as described in the instruction manual of the "Wireless Systems Manager" software.

The LED for LAN data transmission (15) lights up when data is transmitted.



When you are working with the “Wireless Systems Manager” software, you can use the “Spectrum Analyzer” tool to perform a continuous frequency scan. The “Spectrum Analyzer” tool uses the receiver that you select to check the relevant frequency range for signals and records the corresponding measured values. For detailed information, please refer to the chapter “The ‘RF Spectrum Analyzer’ tool” of the “Wireless Systems Manager” manual.

When selecting this receiver in the “Spectrum Analyzer”, please note that during the frequency scan:

- you **cannot** use the selected receiver for its normal purpose,
- the text “Scanning” is displayed and
- the receiver is automatically muted.

## Using the receiver

### Switching the receiver on/off

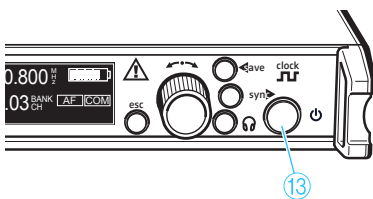

The EM 3731 single receiver is switched on and off with the ⏻-button 13. The two receivers of the EM 3732 or EM 3732 Command twin receiver are commonly switched on and off with the ⏻-button 13. The ⏻-button 13 is not a mains switch.

#### Note:

If you only want to use one of the two receivers of the EM 3732 or EM 3732 Command, you can set the second receiver to standby mode (see “Setting a receiver to standby mode” on page 37).

To switch the receiver on:

- ▶ Press the ⏻-button 13. The display shows the product name (e.g. EM 3731) and the serial number of the current firmware behind “Software”. The status display appears after several seconds.

To switch the receiver off:

- ▶ Press the ⏻-button 13 for approx 2 seconds until the display goes off. The receiver is switched off but daisy chained signals continue to be output. This means that:
  - the daisy chain outputs 27 and 26 output the antenna signals,
  - if the booster supply voltage is switched on (see page 30), it remains switched on,
  - the signal of the external word clock generator is looped through to the word clock daisy chain output 19.

## Connecting the headphones/adjusting the volume

### CAUTION! Danger of hearing damage!



Listening at high volume levels for long periods can lead to permanent hearing defects.

- ▶ Set the volume for the connected headphones to the minimum before putting the headphones on.

The EM 3731 single receiver features a headphone output ②. The two receivers of the EM 3732 or EM 3732 Command twin receiver have a common headphone output ②. This common headphone output ② allows you to either monitor the audio signal of one receiver or to simultaneously monitor the audio signals of both receivers.

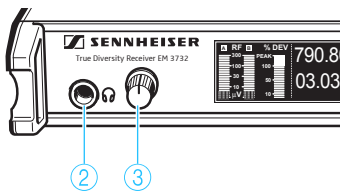

- ▶ Set the headphone volume control ③ to the lowest volume by turning it to the left as far as possible.
- ▶ Connect headphones with a 1/4" (6.3 mm) stereo jack plug to the headphone output ②.

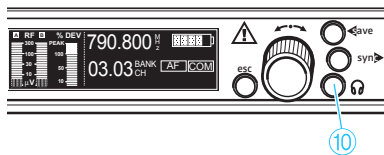

To monitor the audio signals of one of the two receivers of a twin receiver:

- ▶ Press the headphone button ⑩ of the receiver whose audio signals you want to monitor.

To simultaneously monitor the audio signals of both receivers of a twin receiver:

- ▶ Simultaneously press the headphone buttons ⑩ of both receivers. The audio signals of the left receiver are output via the left headphone channel, the audio signals of the right receiver are output via the right headphone channel.
- ▶ Increase the volume gradually.

To switch the headphone output off:

- ▶ Press the headphone button ⑩ of the receiver whose headphone output you want to switch off.

## Deactivating the lock mode

When the receivers are remote controlled via a PC and the supplied "Wireless Systems Manager" software, their buttons can be locked via the "Wireless Systems Manager" software.

To deactivate the lock mode:

- ▶ Press the `esc` button ⑥ until the progress bar is complete and the status display appears. The lock mode is deactivated and the settings can be made manually.



## Synchronizing the transmitter with the receiver frequency

Via its infra-red interface, the receiver can transfer the frequency and the name to suitable transmitters (e.g. SK 5212, SKM 5200 or SKP 3000).

### Note:

The transmitter must be from the same frequency range ("A" to "I", see page 5) and be equipped with the same compander system (HDP, see page 38) as the receiver!

- ▶ Set the receiver to the desired receiving frequency (see "Setting the receiving frequency" on page 28 and "Selecting a frequency bank and a channel" on page 28) and enter the desired name (see "Entering a name" on page 29).

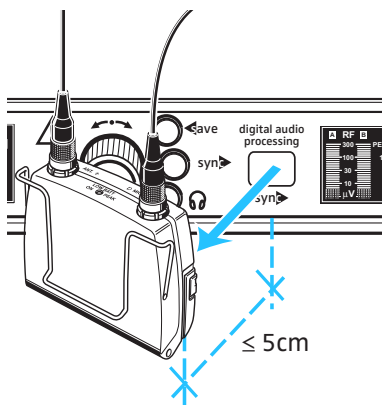
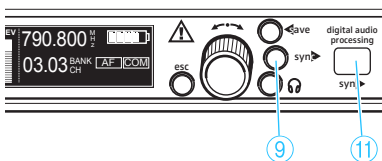

- ▶ Press the **sync** button (9).  
The two blue LEDs in the infra-red interface (sync) (11) flash and the backlighting of the **sync** button (9) flashes red. The receiver is ready for synchronization.

- ▶ Position the transmitter's infra-red interface at a max. distance of 5 cm in front of the infra-red interface (sync) (11).  
The transfer starts automatically. During the transfer, the two blue LEDs in the infra-red interface (sync) (11) flash and the backlighting of the **sync** button (9) flashes green.

- After successful completion of the synchronization, the two blue LEDs in the infra-red interface (sync) (11) stop flashing and the **sync** button (9) is backlit in **green**. The receiver's frequency and name are now also set on the transmitter and the transmission link is ready for operation.
- If an error occurred during synchronization (e.g. the transmitter is too far away from the receiver), the two blue LEDs in the infra-red interface (sync) (11) stop flashing and the **sync** button (9) is backlit in **red**.

### Note on the SKM 5200 hand-held transmitter:

The infra-red interface of the SKM 5200 hand-held transmitter is located at the left-hand margin of the display. Position the transmitter's infra-red interface precisely in front of the infra-red interface (sync) (11) of the receiver.



# The operating menu

## Overview of menus

Menu level	Display	Function of the menu
Uppermost menu level	Tune	Setting a receiving frequency (this frequency is automatically stored in channel "01" of the frequency bank "U" (user bank)).
	Bank.Ch	Switching between the frequency banks and between the channels of a frequency bank
	Name	Entering a name
	Squelch	Adjusting the squelch threshold
	Booster	Switching the booster supply voltage on/off
	AF Out	Adjusting the audio output level
	Clock	Adjusting the sampling rate of the digital audio output
	Command	(EM 3732 Command receiver only) Configuring the audio and command outputs
	More	Changing to the extended menu
Extended menu	Scan	Scanning the frequency banks for free frequencies
	Display	Selecting the status display
	IP-Addr	Adjusting the IP address of the receiver
	MAC	Displaying the MAC address
	Standby	Setting the receiver to standby mode
	Reset	Loading the factory-preset default settings



## Working with the operating menu

By way of example of the “Tune” menu, this section describes how to use the operating menu.

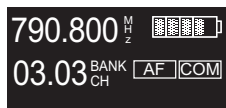

After switching the receiver on, the status display is shown on the display panel.

### Getting into the operating menu

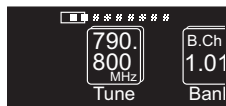

- ▶ Press the jog dial. The status display is replaced by the operating menu. The “Tune” menu is displayed together with its current setting. The position of a menu within the operating menu is illustrated by a graphic in the upper display margin (the “Tune” menu is on the very left of the operating menu).

### Selecting a menu

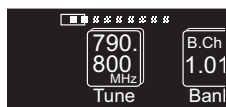

- ▶ Turn the jog dial ⑦ until the icon of the desired menu is in the center of the display.

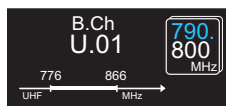

- ▶ Press the jog dial ⑦ to get into the setting mode of the selected menu. The icon of the menu is displayed and the current setting starts flashing. In addition, the green backlighting of the save button ⑧ flashes.

### Adjusting a setting



- ▶ Turn the jog dial ⑦ until the desired setting appears.
- ▶ Press the jog dial ⑦ to confirm the selected setting. Depending on the selected menu, it is possible that the next setting that can be changed and confirmed by turning and pressing the jog dial ⑦ can start flashing.

### Storing a setting



- ▶ Press the save button ⑧ to store the setting. An animation appears on the display, indicating that the setting has been stored. The display then changes to the selection mode of the operating menu.

### Exiting the operating menu/cancelling an entry

You can exit the operating menu or cancel an entry at any time.

- ▶ Press the esc button ⑥. An animation appears. The display then returns to the previous menu level. To return to status display, you may have to press the esc button ⑥ several times in succession.

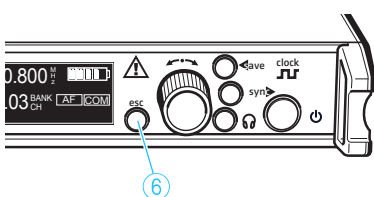

## Operating menu of the receivers

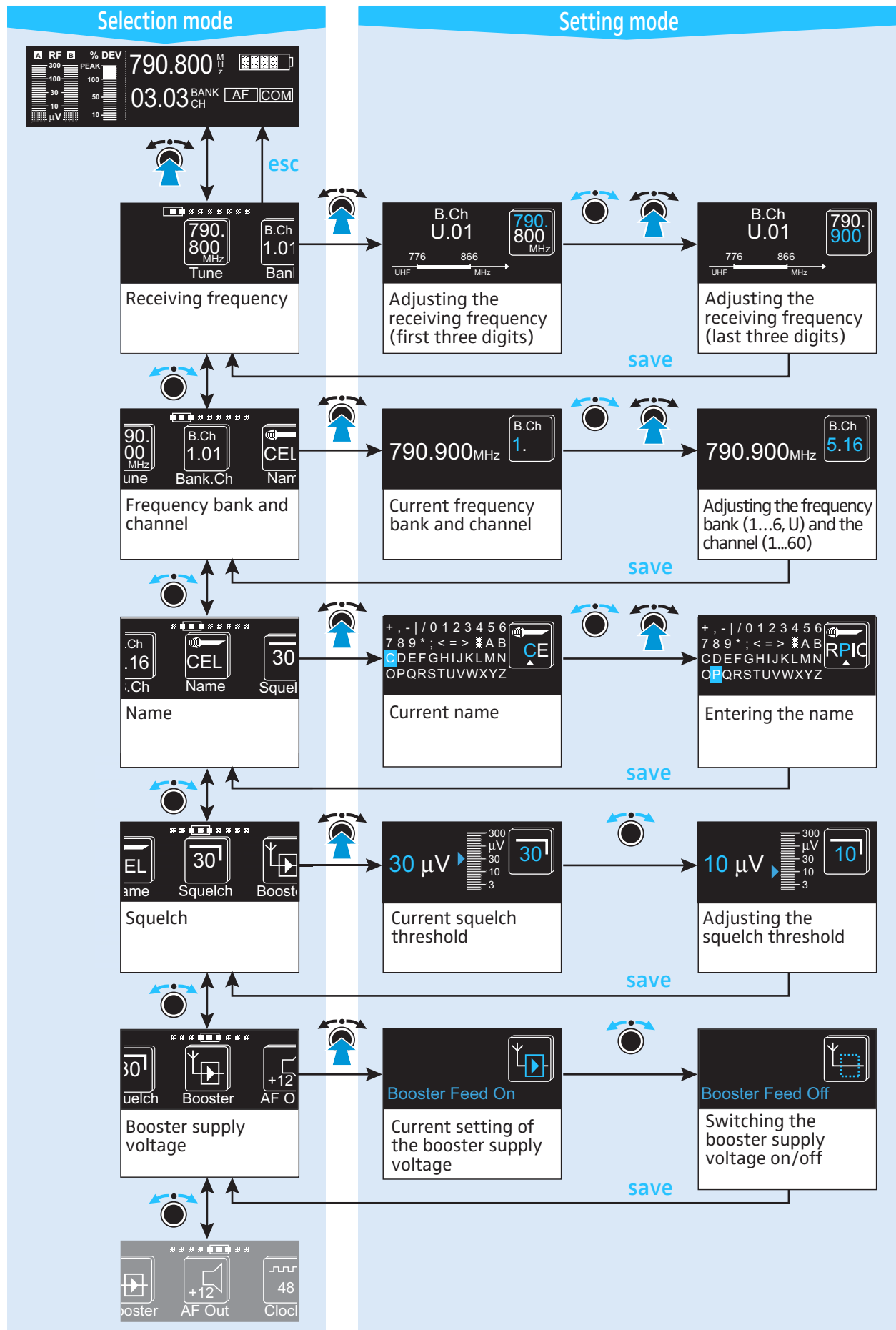

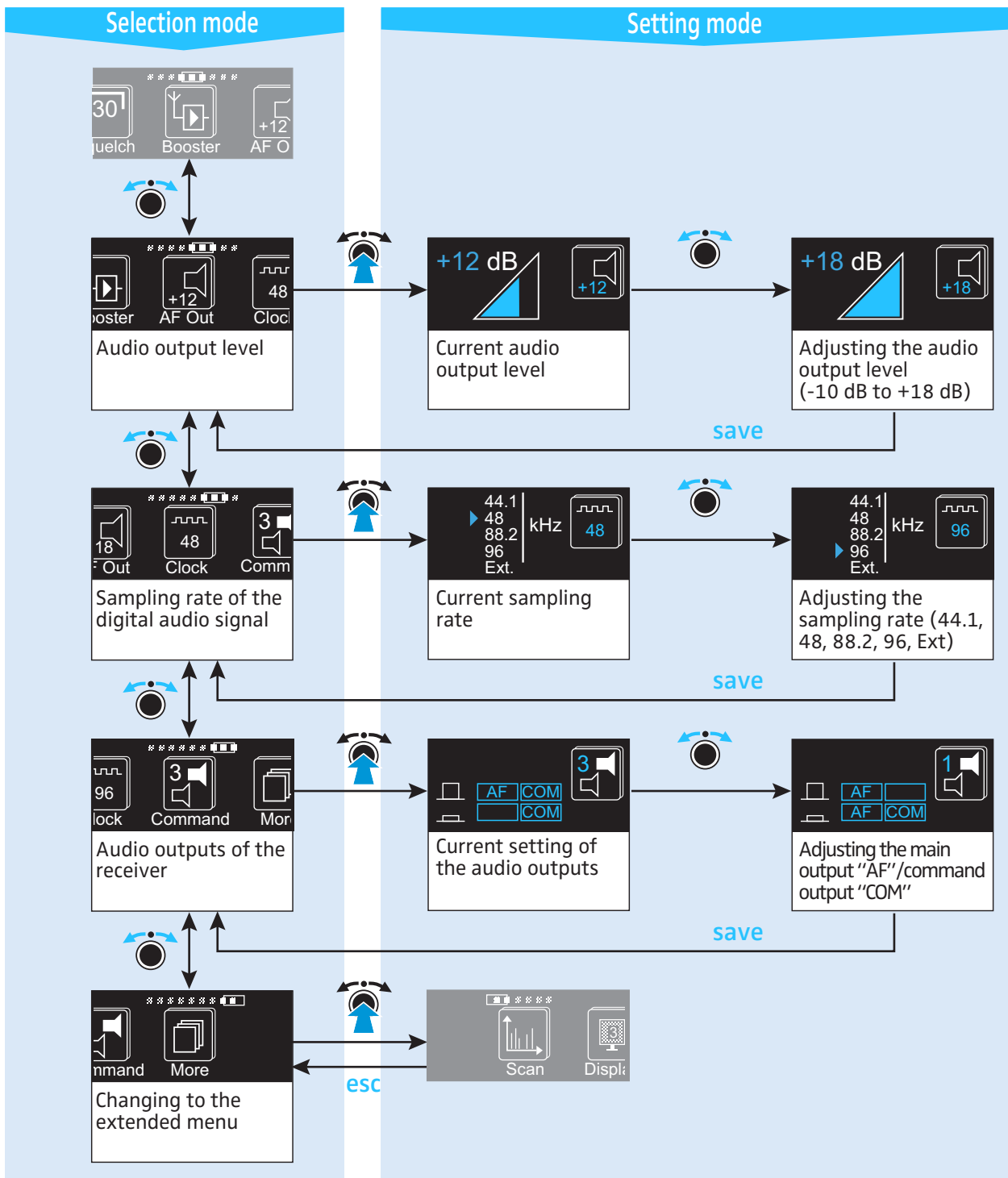

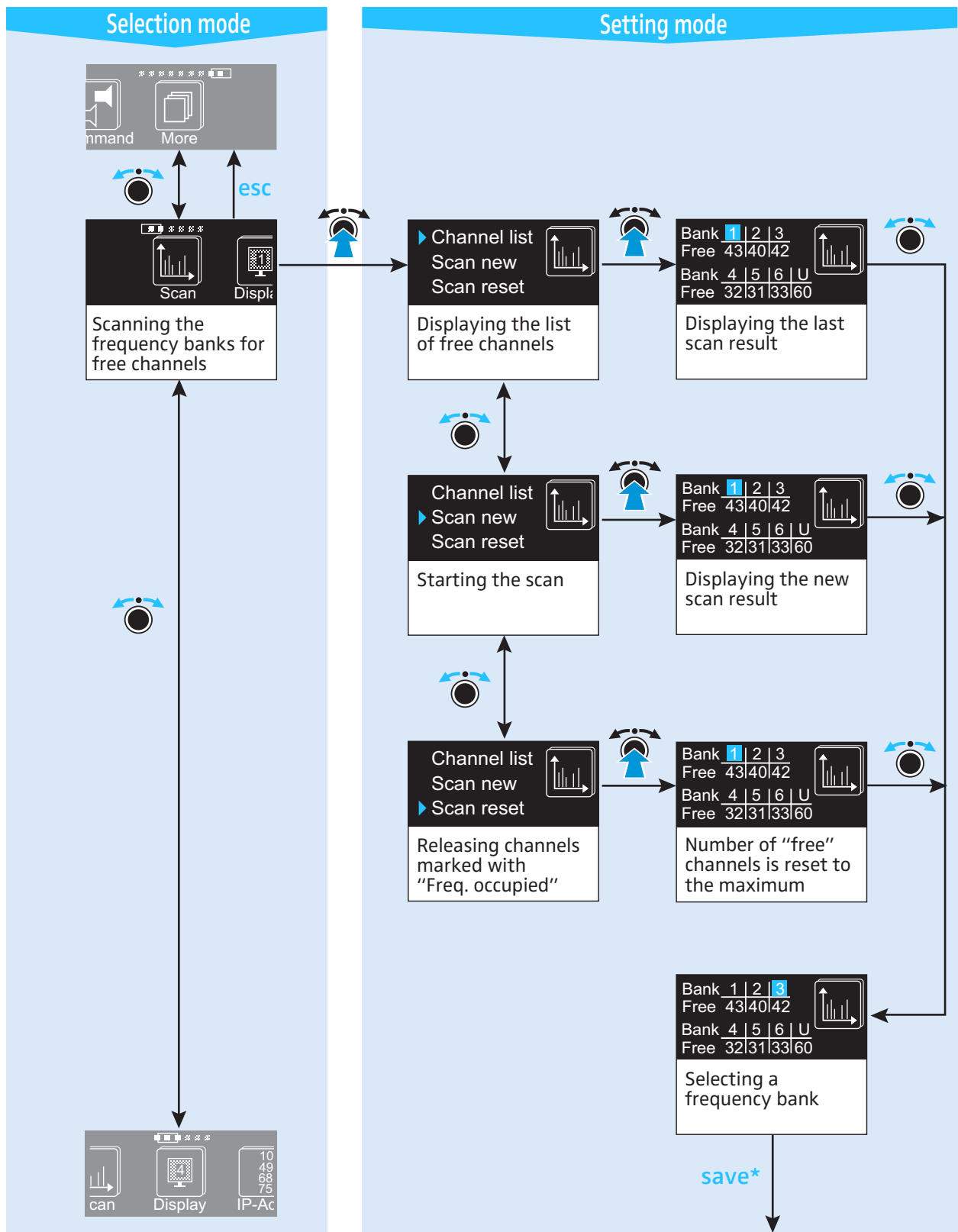

\* After pressing the **save** button (Ⓢ), the display automatically changes to the "B.Ch" menu (see page 24) – i.e. to the selected frequency bank.

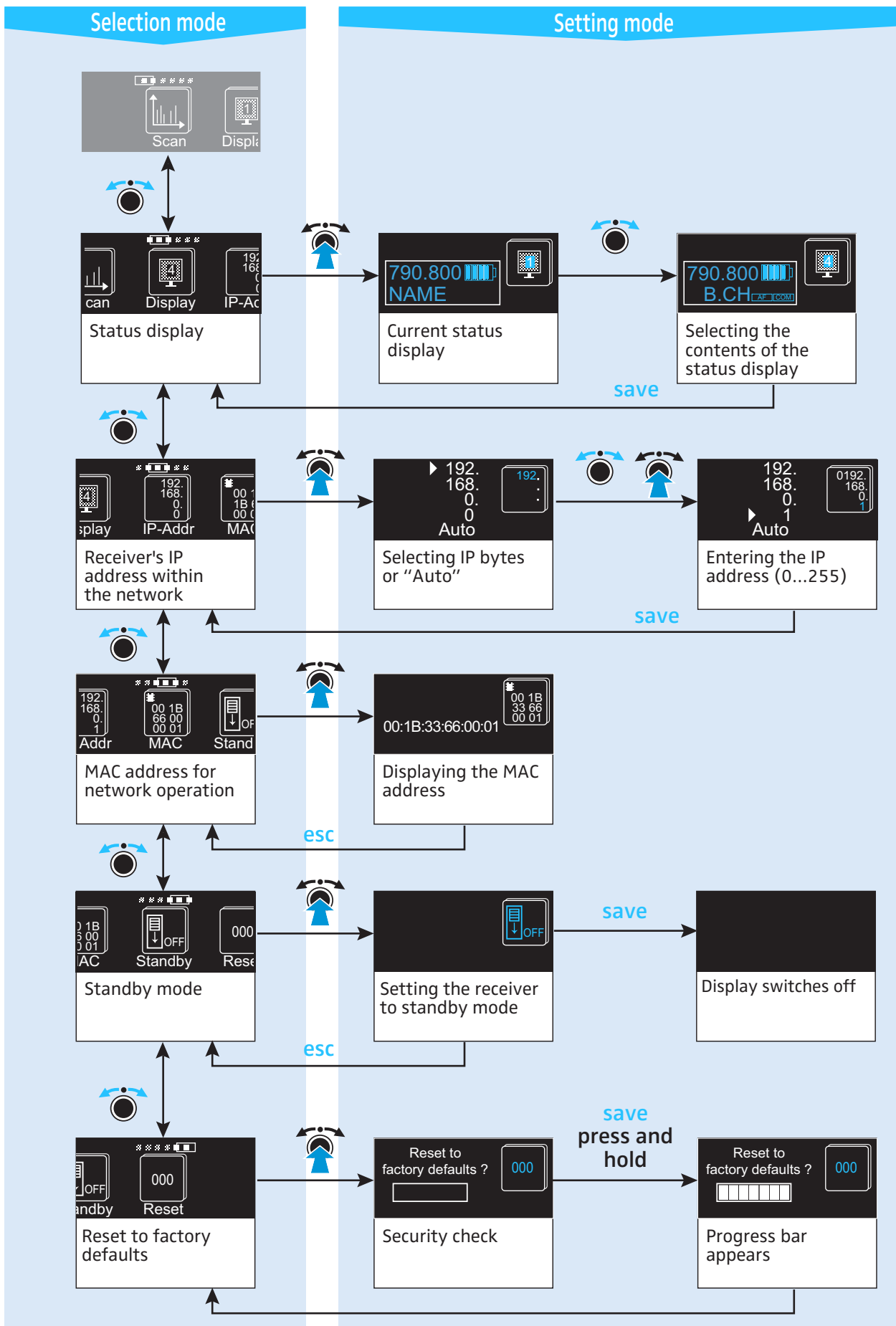

## Adjustment tips for the operating menu

The following adjustment tips apply to the operating menus of all receivers of the EM 3731/3732 receiver family.

### Setting the receiving frequency

**Tune** Via the "Tune" menu, you can:

- set the receiver to a receiving frequency that can be freely selected within the preset frequency range. The receiving frequencies are tunable in 5-kHz increments within the switching bandwidth of 90 MHz max. If you want to use a receiving frequency from the enclosed frequency tables instead, see "Selecting a frequency bank and a channel" on page 28.
- change and store the receiving frequencies in the 60 channels of the frequency bank "U" (see page 29)

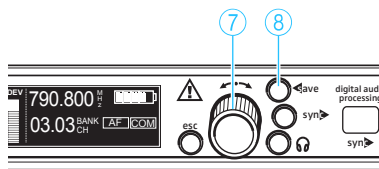
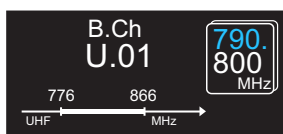

- ▶ Change to the setting mode of the "Tune" menu. The first three digits of the receiving frequency start flashing.
- ▶ Change the first three digits of the receiving frequency by turning the jog dial ⑦.
- ▶ Confirm the first three digits of the receiving frequency by pressing the jog dial ⑦. The last three digits of the receiving frequency start flashing.
- ▶ Change the last three digits of the receiving frequency by turning the jog dial ⑦.
- ▶ After you have selected the six digits of the receiving frequency, press the **save** button ⑧. The selected receiving frequency is set and automatically stored on the channel "01" of the frequency bank "U", i.e. the previously stored frequency is overwritten. The display changes to the selection mode of the operating menu.

### Selecting a frequency bank and a channel

**B.Ch** Via the "B.Ch" menu, you can select a frequency bank and a channel from the enclosed frequency tables.

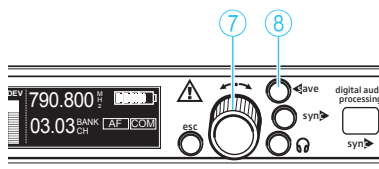
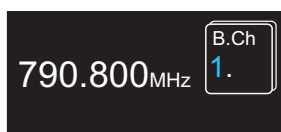

- ▶ Change to the setting mode of the "B.Ch" menu. The number of the frequency bank starts flashing.
- ▶ Select the desired frequency bank by turning the jog dial ⑦.
- ▶ Confirm the frequency bank by pressing the jog dial ⑦. The number of the channel starts flashing.
- ▶ Select the desired channel by turning the jog dial ⑦.

#### Note:

If during the last scan channels were detected that were occupied or subject to interference, these channels are marked with a warning triangle and the text "Freq. occupied" in the "Tune" menu.

- ▶ After you have selected the frequency bank and the channel, press the **save** button ⑧.

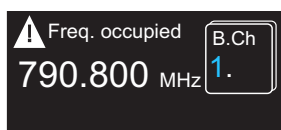

The selected frequency bank and the selected channel are set. The display changes to the selection mode of the operating menu.

### Changing the receiving frequency for a selected channel in the frequency bank "U"

**Tune** Each receiver has seven frequency banks. The frequency banks "1" to "6" have up to 60 channels that are factory-preset to a receiving frequency (see enclosed frequency tables). The frequency bank "U" (user bank) has 60 channels to store your selection of receiving frequencies that can be freely selected in 5-kHz increments within the switching bandwidth. Via the "Tune" menu, you can freely select the frequencies to be stored in the frequency bank "U".

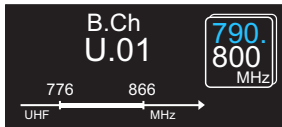

- ▶ Change to the setting mode of the "B.Ch" menu and select the frequency bank "U" and one of the channels "01" to "60" whose frequency you want to change and store (see "Selecting a frequency bank and a channel" on page 28).

#### Note:

The receiving frequencies of the channels in the frequency banks "1" to "6" cannot be changed. When you have selected one of the frequency banks "1" to "6" and then select the "Tune" menu, the receiver automatically switches to channel "01" of the frequency bank "U".

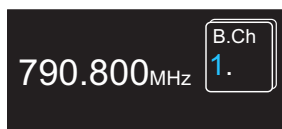

- ▶ Change to the setting mode of the "Tune" menu and select the receiving frequency you want to store (see "Setting the receiving frequency" on page 28).

The selected receiving frequency is set and stored on the selected channel of the frequency bank "U", i.e. the previously stored frequency is overwritten. The display changes to the selection mode of the operating menu.

### Entering a name

**Name** Via the "Name" menu, you can enter a freely selectable name for the receiver. The name can be displayed on the status display and can consist of up to six characters such as:

- letters (without pronunciation marks),
- number from 0 to 9,
- special characters and spaces.

- ▶ Change to the setting mode of the "Name" menu.

The first character of the name starts flashing.



- ▶ Select a different character by turning the jog dial ⑦. The selected character starts flashing.

- ▶ Confirm the selected character by pressing the jog dial ⑦.

The first character is accepted and stops flashing. The next character starts flashing.

- ▶ Repeat the last two steps to enter the remaining characters.

- ▶ After you have entered the six characters of the name, press the **save** button ⑧.

The name is stored. The display changes to the selection mode of the operating menu.

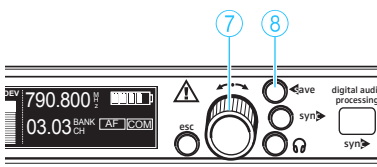

In order that the name is displayed on the status display, you may have to change the contents of status display (see "Selecting the status display" on page 36).

## Adjusting the squelch threshold

**Squelch** Both receivers are equipped with a squelch that can be adjusted via the “Squelch” menu. The squelch eliminates annoying noise when the transmitter is switched off. It also suppresses sudden noise when there is no longer sufficient transmitter power received by the receiver.

The squelch can be adjusted in 13 steps from 0 to 30  $\mu\text{V}$ . Selecting a smaller value reduces the squelch threshold, selecting a higher value increases the squelch threshold. Adjust the squelch threshold – with the transmitter switched off – to the lowest possible value that suppresses hissing noise.

### Notes:

- If the squelch threshold is adjusted too high, the transmission range will be reduced. Therefore, always adjust the squelch threshold to the lowest possible setting.
- If you adjust the squelch threshold to “0”, the squelch is switched off. If no RF signal is being received, hissing noise will occur. This setting is for test purposes only.

To adjust the squelch threshold:

- ▶ Before adjusting the squelch threshold to a different setting, set the volume on a connected amplifier to the minimum.
- ▶ Change to the setting mode of the “Squelch” menu. The current setting starts flashing.
- ▶ Change the squelch threshold by turning the jog dial ⑦. The new setting becomes effective immediately.
- ▶ After you have adjusted the desired squelch threshold, press the save button ⑧. The squelch threshold is stored. The display changes to the selection mode of the operating menu.

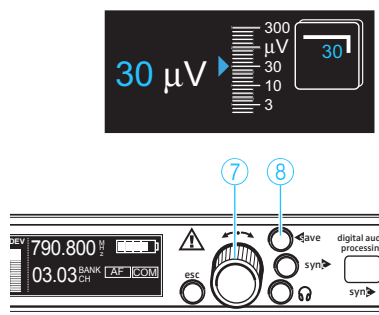

## Switching the booster supply voltage on/off

**Booster** If you connect antenna boosters (e.g. AB 3700) or active antennas (e.g. A 3700, AD 3700), select “Booster Feed On” in the “Booster” menu so that the LEDs ②④ and ②⑨ light up; if you do not connect antenna boosters or active antennas, select “Booster Feed Off” in the “Booster” menu so that the LEDs ②④ and ②⑨ do not light up.

### Notes:

- The booster supply voltage is short-circuit proof.
- If you connect active antennas or antenna boosters, the current consumption of the overall device is increased.
- If the booster supply voltage is switched on, it remains switched on even when the receiver is switched off or muted.
- ▶ Change to the setting mode of the “Booster” menu. The current setting starts flashing.





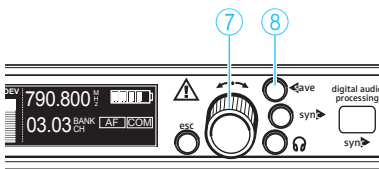

- ▶ Change the setting to “Booster Feed On” or “Booster Feed Off” by turning the jog dial (7).
- ▶ Press the **save** button (8).  
The selected setting is stored. When the booster supply voltage is switched on, the two LEDs (24) and (29) light up. The display changes to the selection mode of the operating menu.

### Adjusting the audio output level

**AF Out** Via the “AF Out” menu, you can adjust the maximum output level of the audio outputs (AF out and Command).

With the EM 3732 Command, the audio level of the Command output 1 (22) corresponds to the level of the audio output 1 (23) and the audio level of the Command output 2 (20) corresponds to the level of the audio output 2 (21).

The following figures are a guide to the best settings:

- Line input level: +5 to +18 dB
- Microphone input level: -10 to +4 dB

To obtain the best signal-to-noise ration, adjust the respective maximum audio level to the settings shown above.



- ▶ Change to the setting mode of the “AF Out” menu.  
The current setting starts flashing.

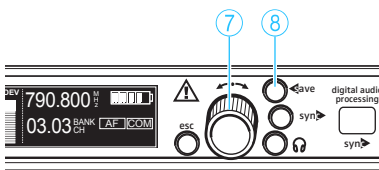

- ▶ Adjust the audio output level by turning the jog dial (7).  
The display shows the selected audio output level.
- ▶ Press the **save** button (8).  
The selected setting is stored. The display changes to the selection mode of the operating menu.

### Selecting the sampling rate for digitalization

**Clock** Via the “Clock” menu, you can select the sampling rate with which the analog signal is digitalized and output via the digital balanced XLR-3M audio output (17). You can choose between the sampling rates “44.1 kHz”, “48 kHz”, “88.2 kHz”, “96 kHz” and “Ext.”. “Ext.” means that the receiver will use one of above sampling rates from the external word clock generator. In this case, you first have to connect an external word clock generator to the BNC socket (18) (see “Connecting an external word clock generator” on page 18) and switch it on.

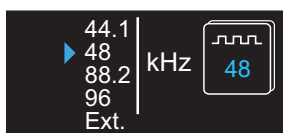

- ▶ Change to the setting mode of the “Clock” menu.  
The current setting starts flashing.

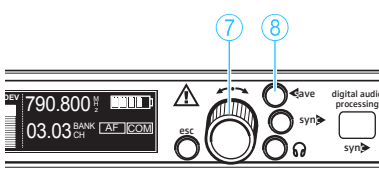

- ▶ Select the desired sampling rate by turning the jog dial (7).
- ▶ Press the **save** button (8).  
The selected sampling rate is stored. The display changes to the selection mode of the operating menu.

#### Note:

If you select “Ext.” even though no external word clock signal is available at the BNC socket for word clock input (18) (e.g. because the

external word clock generator is not connected or switched off), the display for external word clock synchronization ⑫ starts flashing and the last set sampling rate remains active.

The receiver’s audio outputs have a latency which depends on the sampling rate set in the “Clock” menu. The below table shows these latency times as well the the distances to which they approximately correspond.

Audio output	Sampling rate kHz	Latency ms	Corresponds to a distance of approx. ... cm
analog	44.1 / 88.2	1.8	60
analog	48 / 96	1.7	55
digital	44.1	1.9	65
digital	48	1.7	55
digital	88.2	1.8	60
digital	96	1.7	55

### Configuring the audio outputs of the EM 3732 Command twin receiver

**Command** The EM 3732 Command twin receiver has two audio outputs per receiver:

1. the audio outputs AF out 1 ⑳ and AF out 2 ㉑,
2. the command outputs Command 1 ㉒ and Command 2 ㉓.

These audio outputs can be switched on and off via a button on the transmitter – provided that the transmitter is also equipped with the command function (a separate power pack with command button is available for the SKM 5200 transmitter).

Via the “Command” menu, you can determine which of the audio and command outputs are switched on and off when the command button on the transmitter is pressed. There are four configuration options:

If the “Command” menu of the receiver is configured as shown below ...	... AND the command button on the transmitter is ...	... THEN the receiver’s audio outputs are switched ...
	<input type="checkbox"/> not pressed	AF out: on Command: off
	<input checked="" type="checkbox"/> pressed	AF out: on Command: on
	<input type="checkbox"/> not pressed	AF out: on Command: off
	<input checked="" type="checkbox"/> pressed	AF out: off Command: on
	<input type="checkbox"/> not pressed	AF out: on Command: on
	<input checked="" type="checkbox"/> pressed	AF out: off Command: on
	<input type="checkbox"/> not pressed	AF out: on Command: on
	<input checked="" type="checkbox"/> pressed	AF out: on Command: on

The active output lights up in the command display; muted outputs are not displayed (see “Command display (status display of the audio outputs AF and COM)” on page 11).

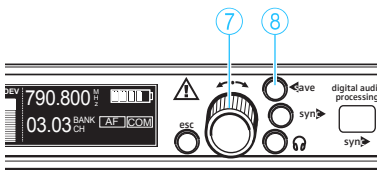

- ▶ Change to the setting mode of the “Command” menu. The current configuration starts flashing.

- ▶ Select one of the four configurations by turning the jog dial (7).

**Note:**

If you do not want to use the command function, select the configuration “4”.

- ▶ Press the save button (8). The selected configuration is stored. The display changes to the selection mode of the operating menu.

**Changing to the extended menu**

**More** Via the “More” menu, you can change to the extended menu with the submenus “Scan”, “Display”, “IP-Addr”, “MAC”, “Standby” and “Reset”.

**Scanning the frequency banks for interference-free channels**

**Scan** Via the “Scan” menu, you can scan all frequency banks for free channels.

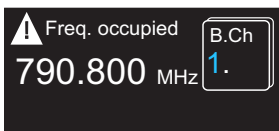
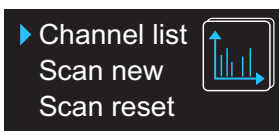

- ▶ Change to the setting mode of the “Scan” menu. The following menu items appear:
  - “Channel list” displays the number of free channels for each frequency bank from the last scan.
  - “Scan new” scans all frequency banks and displays the number of free channels for each frequency bank.
  - “Scan reset” releases channels that were occupied or subject to interference during the last scan (these channels are marked with a warning triangle and the text “Freq. occupied” in the “Tune” menu).

**Displaying a list of all free channels**

**Channel list** Via the “Channel list” menu, you can display the last scan result. You can then select a suitable frequency bank and a channel.

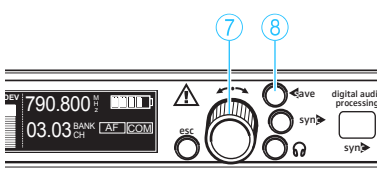
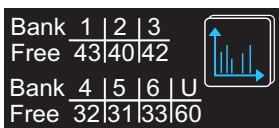
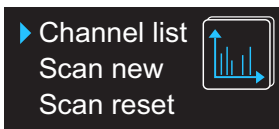

- ▶ Turn the jog dial (7) until the arrow points to “Channel list”.
- ▶ Press the jog dial (7). A table displays the number of free channels for each frequency bank.
- ▶ Turn the jog dial (7) to select a frequency bank with a sufficient number of free channels.
- ▶ Press the save button (8). The selected frequency bank is automatically called up in the “B.Ch” menu.
- ▶ Select a channel from this frequency bank (see “Selecting a frequency bank and a channel” on page 28).

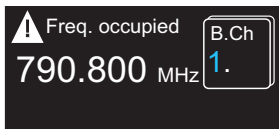

**Note:**

After the scan, the channels that are occupied or subject to interference are marked with a warning triangle and the text "Freq. occupied" in the "Tune" menu.

**Starting the scan**

**Scan new**

Via the "Scan new" menu, you can scan all frequency banks for free channels. The last scan result is overwritten.

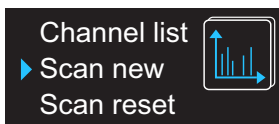

- ▶ Before starting the scan, switch all transmitters of your system off, since channels used by switched-on transmitters will not be displayed as "free channels".
- ▶ Turn the jog dial (7) until the arrow points to "Scan new".
- ▶ Press the jog dial (7) to start the scan. The receiver scans the frequency banks one after the other for free channels. This can take several minutes. After the scan, a table displays the number of free channels for each frequency bank and the green backlighting of the save button (8) flashes.

**Note:**

You can cancel the scan at any time by pressing the esc button (6). The display changes to the setting mode of the "Scan" menu and the last scan result is restored.

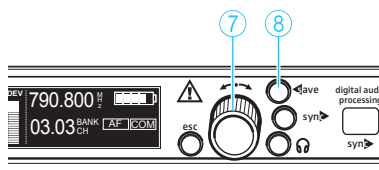

- ▶ Turn the jog dial (7) to select a frequency bank with a sufficient number of free channels.
- ▶ Press the save button (8). The selected frequency bank is automatically called up in the "B.Ch" menu.
- ▶ Select a channel from this frequency bank (see "Selecting a frequency bank and a channel" on page 28).

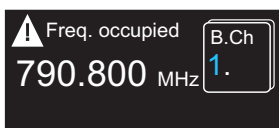

**Note:**

After the scan, the channels that are occupied or subject to interference are marked with a warning triangle and the text "Freq. occupied" in the "Tune" menu.

### Scan reset

#### Releasing channels that are used or subject to interference

After the scan, the channels that are occupied or subject to interference are marked with a warning triangle and the text "Freq. occupied" in the "Tune" menu. Via the "Scan reset" menu, you can unmark these channels. The last scan result is deleted.

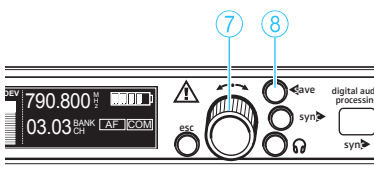
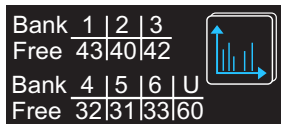
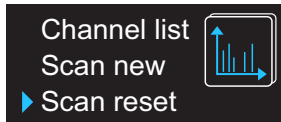

- ▶ Turn the jog dial ⑦ until the arrow points to "Scan reset".
- ▶ Press the jog dial ⑦.  
The number of free channels is reset to the maximum for all frequency banks.
- ▶ Turn the jog dial ⑦ to select a frequency bank.
- ▶ Press the **save** button ⑧.  
The selected frequency bank is automatically called up in the "B.Ch" menu.

#### Multi-channel operation

Combined with Sennheiser 3000 and 5000 series transmitters, the receivers can form transmission links that are suitable for multi-channel operation.

#### CAUTION! Risk of reception interference!



If – within the receiver's frequency range – transmitters transmit on channels from different frequency banks, reception can be subject to interference and inter-modulation. Only the factory-preset frequencies within the frequency banks "1" to "6" are interference and inter-modulation free.

- ▶ Set all transmitters of a multi-channel system to different channels within the same frequency bank.

Before putting the transmission links into operation, we recommend that you perform a scan in order to find a frequency bank with a sufficient number of free channels:

- ▶ Switch all transmitters off.
- ▶ Use a receiver to scan all frequency banks for free channels (see "Scanning the frequency banks for interference-free channels" on page 33).
- ▶ Select a frequency bank with a sufficient number of free channels (see "Selecting a frequency bank and a channel" on page 28).
- ▶ Set each transmitter/receiver pair in your multi-channel system to a different free channel within this frequency bank.

### Selecting the status display

**Display** Via the "Display" menu, you can select the status display:

Selectable status display	Contents of the display
1. "Name" displays the freely selectable name	790.800 MHz NAME
2. "Bank/Channel" displays the frequency bank and the channel number	790.800 MHz 03.03 BANK CH
3. "Name/Command" displays the freely selectable name and the command display (EM 3732 Command receiver only)	790.800 MHz NAME [AF] [COM]
4. "Bank/Channel/Command" displays the frequency bank, the channel number and the command display (EM 3732 Command receiver only)	790.800 MHz 03.03 BANK CH [AF] [COM]

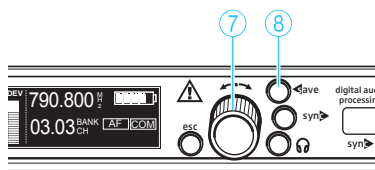

- ▶ Change to the setting mode of the "Display" menu.  
The current status display starts flashing.
- ▶ Select one of the four status displays by turning the jog dial ⑦.
- ▶ Press the save button ⑧.  
The selected status display becomes effective. The display changes to the selection mode of the operating menu.

### Changing the IP address

**IP-Addr** Via the "IP-Addr" menu, you can display and change the receiver's IP address. The IP address consists of four bytes and each byte consists of up to three digits (from 0 to 255). The receiver is factory-preset to dynamic IP addressing ("Auto").

To manually assign an IP address:

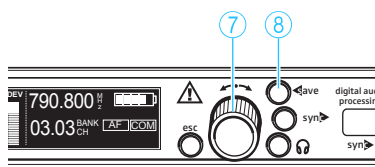
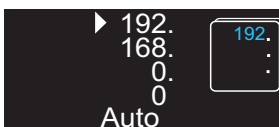

- ▶ Change to the setting mode of the "IP-Addr" menu.  
The first byte starts flashing.
- ▶ Select a value between 0 and 255 by turning the jog dial ⑦.
- ▶ Press the jog dial ⑦ to confirm the first byte and change to the next byte.
- ▶ Repeat the last two steps to select all four bytes.
- ▶ After you have selected the complete IP address, press the save button ⑧.
- ▶ Switch the receiver off and on again (see "Switching the receiver on/off" on page 19).  
The new IP address becomes effective.

To **automatically** obtain an IP address (dynamic IP addressing):

- ▶ Change to the setting mode of the “IP-Addr” menu. The first byte starts flashing.
- ▶ Press the jog dial ⑦ several times until the arrow points to “Auto”.
- ▶ Press the **save** button ⑧.
- ▶ Switch the receiver off and on again (see “Switching the receiver on/off” on page 19). The new IP address becomes effective.

### Displaying the network address (MAC address)

**MAC** Via the “MAC” menu, you can display the Media Access Control (MAC) address of the Ethernet interface. The MAC address is fixedly stored in each receiver and cannot be changed.

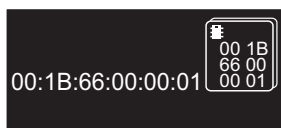

- ▶ Change to the setting mode of the “MAC” menu. The 12-digit MAC address is displayed.

### Setting a receiver to standby mode

#### Standby

You can set a receiver to standby mode and mute it. To do so, proceed as follows:

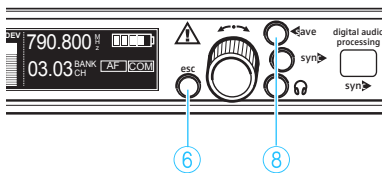

- ▶ Change to the setting mode of the “Standby” menu. The icon and the green backlighting of the **save** button ⑧ flash.
- ▶ Press the **save** button ⑧. The **esc** button ⑥ is backlit in red. The receiver is set to standby mode and the display is switched off.

#### Note:

The standby mode remains active even when you switch the receiver off and on again.

To end the standby mode:

- ▶ Press the jog dial ⑦ or the **esc** button ⑥. The display is switched on.

### Loading the factory-preset default settings

#### Reset

Via the “Reset” menu, you can reset the current settings to the factory-preset default settings.

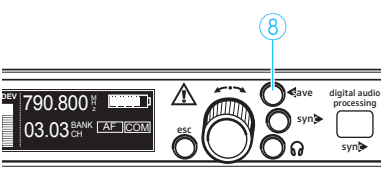
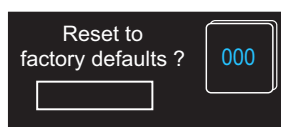

- ▶ Change to the setting mode of the “Reset” menu. The question “Reset to factory defaults?” appears. The green backlighting of the **save** button ⑧ flashes.
- ▶ Press the **save** button ⑧ until the progress bar is complete. All settings except for the booster supply voltage, the sampling rate at the digital output and the network address are reset to the factory-preset default settings. The display changes to the selection mode of the operating menu.

## Additional information

### HiDyn plus™ (HDP) noise reduction

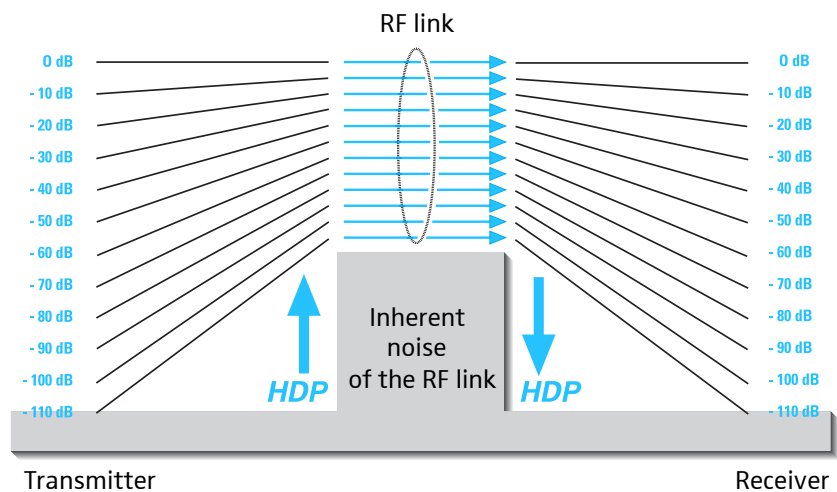

The EM 3731/3732 receivers are equipped with HDP, the Sennheiser noise reduction system that reduces RF interference. It increases the signal-to-noise ratio in wireless audio transmission to more than 110 dB. HDP is a wideband compander system which compresses the audio signal in the transmitter in a 2:1 ratio (related to dB) to lift it above the inherent noise floor of the RF link. In the receiver the signal is expanded in an identical and opposite way in a 1:2 ratio to restore the original signal, at the same time reducing the RF noise to below the noise floor of the receiver.

HDP has been specially developed for high quality radiomicrophone systems.

The EM3731/3732 receivers feature a AES3 digital audio output for digital mixing consoles. In the receiver the audio signal is digitalized as early as possible so that the noise reduction (compander) can be realized digitally.

#### Note:

Only transmitters and receivers that are equipped with HDP can work correctly with each other. If non HDP equipment was mixed with HDP, the dynamic range would be drastically reduced and the transmission would sound blunt and flat. HDP is permanently active and cannot be switched off.

### Squelch

Depending on the strength of the received RF signal, the receiver's audio output is opened or muted. Via the "Squelch" menu, the squelch threshold can be adjusted in 15 steps from 0 to 30  $\mu$ V.



## Diversity reception

The receivers operate on the “true diversity” principle:

A receiving antenna receives not only the electromagnetic waves which reach it by a direct path, but also the reflections of these waves which are created in the room by walls, windows, ceilings and fittings. When these waves are superimposed, destructive interference occurs, which can also be called “field strength gaps”. Repositioning the receiving antenna can bring a solution. With mobile transmitters, however (which all radiomicrophones are), the “field strength gap” will then occur with a different transmitter position. These “field strength gaps” can only be eliminated with true diversity receivers.

In true diversity, instead of one antenna and one receiver there are now two antennas and two receiver sections. The antennas are spatially separated. By means of a comparison circuit, the receiver section with the strongest RF signal is always switched to the common AF output. The risk of the occurrence of “field strength gaps” in both antennas at the same time is virtually nonexistent.

The receiver display panel shows the active diversity section (A or B) (see “Diversity display” on page 9).

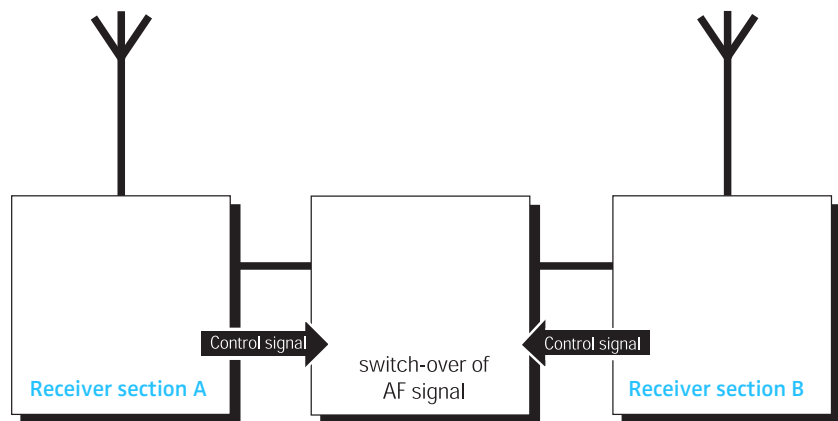

## If a problem occurs ...

Problem	Possible cause	Possible solution
No operation indication	No mains connection	Check the connections of the mains cable
No RF signal	Transmitter and receiver are not on the same channel	Set transmitter and receiver to the same channel (see "Selecting a frequency bank and a channel" on page 28 and "Synchronizing the transmitter with the receiver frequency" on page 21)
	The transmitter is out of range	<ul style="list-style-type: none"> <li>Reduce the distance between transmitter and receiver</li> <li>Check the squelch threshold setting (see page 30)</li> </ul>
It is not possible to transfer the frequency to the transmitter	The transmitter is not within the range of the infra-red interface	Place the transmitter at a distance of approx. 5 cm in front of the infra-red interface (see page 21)
	The infra-red interface of the receiver is not yet ready for transferring the frequency; the receiver is still in scan mode	Press the <b>esc</b> button (6) to stop the scan
	The transmitter is from a different frequency range	Use a transmitter that matches the frequency range of the receiver
The audio signal has a high level of background noise	The transmitter sensitivity is adjusted too low	Adjust the transmitter sensitivity correctly
	The receiver's AF output level is adjusted too low	See "Adjusting the audio output level" on page 31
The audio signal is distorted	The transmitter sensitivity is adjusted too high	Adjust the transmitter sensitivity correctly
	The receiver's AF output level is adjusted too high	See "Adjusting the audio output level" on page 31
The display does not switch on	The receiver is in standby mode	Press the jog dial (7) (see "Setting a receiver to standby mode" on page 37)
"Mute" is permanently displayed	One of the two receivers is not used or the transmitter is switched off or out of range	Set the receiver to standby mode (see page 37)

If a problem occurs that is not listed in the above table or if the problem cannot be solved with the proposed solution(s), please contact your local Sennheiser agent for assistance.

# Specifications



## RF characteristics

Modulation	wideband FM
Frequency ranges	470–560 MHz 518–608 MHz 548–638 MHz 614–704 MHz 678–768 MHz 708–798 MHz 776–866 MHz 814–904 MHz 870–960 MHz
Receiving frequencies (per receiver RX 1 or RX 2)	6 frequency banks with up to 60 factory-preset frequencies each, 1 frequency bank with up to 60 freely selectable frequencies (tunable in 5-kHz increments)
Switching bandwidth	90 MHz
Frequency stability	$\leq \pm 2.5$ ppm
Receiver principle	true diversity
Sensitivity (with HDP, peak deviation)	typ. 1.5 $\mu$ V at 52 dB(A)rms S/N typ. 15 $\mu$ V at 115 dB(A)rms S/N
Adjacent channel rejection/ spacing	typ. 75 dB/ $\pm 400$ kHz typ. 80 dB/ $\pm 800$ kHz
Intermodulation attenuation	$\geq 80$ dB
Blocking	$\geq 80$ dB
Squelch	13 steps (0 ... 30 $\mu$ V)
Antenna inputs	2 BNC sockets (50 $\Omega$ )
Daisy chain outputs	2 BNC sockets (50 $\Omega$ ) amplification: 0 dB $\pm 0.5$ dB (related to the antenna inputs) 180 MHz typ. bandwidth (range)

## AF characteristics

Compander system	Sennheiser HiDyn <i>plus</i> <sup>™</sup> , DSP-emulated
AF bandwidth	40–20,000 Hz
Latency	$\leq 1.9$ ms
Nominal/peak deviation	$\pm 40$ kHz/ $\pm 56$ kHz
Signal-to-noise ratio (1 mV, peak deviation)	$\geq 118$ dB(A) at +18 dB <sub>u</sub> /+4 dB <sub>u</sub> (AF out)
THD (nominal deviation, 1 kHz)	$\leq 0.3$ %
AF output voltage (peak deviation, 1 kHz <sub>AF</sub> )	+18 dB <sub>u</sub> to –10 dB <sub>u</sub> , adjustable in 1-dB increments (transformer balanced)
AF output sockets	1 XLR-3 socket per receiver, 2 XLR-3 sockets per EM 3732 Command receiver
Headphone output	2 x 100 mW at 32 $\Omega$ 10 $\Omega$ internal impedance short-circuit proof

**Overall device**

Ambient temperature	-10 °C to +55 °C
Relative humidity	max. 85 %
Power supply	100–240 V AC, 50/60 Hz
Current consumption	max. 0.4 A
Power consumption	with receiver switched on: max. 20 W (50 VA) with receiver switched off, booster supply voltage switched on: max. 9.5 W with receiver and booster supply voltage switched off: max. 4 W
Mains connector	3-pin, protection class I, as per IEC/EN 60320-1
Dimensions W x D x H [mm]	436 x 215 x 44 (without rack mount "ears")
Weight	approx. 4080 g (incl. rack mount "ears") approx. 3600 g (without rack mount "ears")
Booster supply	12 V DC via antenna socket max. 200 mA each, short-circuit proof, switchable
Ethernet	IEEE 802.3-2002, shielded RJ 45 socket with optional locking facility
Digital output	AES3-2003, XLR-3, 44.1, 48, 88.2 or 96 kHz SR, 24 bits, externally synchronizable
Word clock connection	2 BNC sockets (75 Ω), daisy chain output
Accepted sampling rates	44.1 kHz, 48 kHz, 88.2 kHz, 96 kHz
Word clock input	75 Ω, transformer balanced, AC-coupled input voltage range 200 mV ... 5 Vpp max. input voltage 15 V (DC + AC)
Word clock output	75 Ω, transformer balanced, AC-coupled output voltage 2.5 V± 250 mV at 75 Ω source impedance
In compliance with	 EMC EN 301489-1/-9 Radio EN 300422-1/-2 Safety EN 60065  47 CFR 15 subpart B
Type approval	Industry Canada RSS 210, IC: 2099A-EM 373x  Certified with Class 222651 and 222681 - Commercial Audio Equipment CAN/CSA 60065-03 incl. AM1, UL Std No. 60065-2006

## Accessories/spare parts

The following accessories are available from your authorized dealer:

Cat. No.	Accessory	Cat. No.	Accessory
502195	A 3700 active broadband antenna	004368	GA 3030 AM antenna mount
502197	AD 3700 active broadband directional antenna	087969	Antenna daisy chain cable, 50 $\Omega$ , BNC, 0.25 m
502196	AB 3700 antenna booster	087972	Word clock daisy chain cable, 75 $\Omega$ , BNC, 0.25 m
500887	A 5000 CP circularly polarized broadband antenna, passive	502432	GZL AES 10 AES3 cable, 10 m, 110 $\Omega$ , double-shielded
004645	A 1031 broadband remote antenna, passive	002324	GZL 1019-A1 coaxial cable, type RG 58, BNC to BNC, 1 m
003658	A 2003 broadband directional antenna, passive	002325	GZL 1019-A5 coaxial cable, type RG 58, BNC to BNC, 5 m
009423	ASA 3000-EU antenna splitter	002326	GZL 1019-A10 coaxial cable, type RG 58, BNC to BNC, 10 m
009407	ASA 3000-US antenna splitter		
009408	ASA 3000-UK antenna splitter		

# Manufacturer Declarations

## Warranty regulations

The guarantee period for this Sennheiser product is 24 months from the date of purchase. Excluded are accessory items, rechargeable or disposable batteries that are delivered with the product; due to their characteristics these products have a shorter service life that is principally dependent on the individual frequency of use.

The guarantee period starts from the date of original purchase. For this reason, we recommend that the sales receipt be retained as proof of purchase. Without this proof (which is checked by the responsible Sennheiser service partner) you will not be reimbursed for any repairs that are carried out.

Depending on our choice, guarantee service comprises, free of charge, the removal of material and manufacturing defects through repair or replacement of either individual parts or the entire device. Inappropriate usage (e.g. operating faults, mechanical damages, incorrect operating voltage), wear and tear, force majeure and defects which were known at the time of purchase are excluded from guarantee claims. The guarantee is void if the product is manipulated by non-authorised persons or repair stations.

In the case of a claim under the terms of this guarantee, send the device, including accessories and sales receipt, to the responsible service partner. To minimise the risk of transport damage, we recommend that the original packaging is used.

Your legal rights against the seller, resulting from the contract of sale, are not affected by this guarantee. The guarantee can be claimed in all countries outside the U.S. provided that no national law limits our terms of guarantee.

## CE Declaration of Conformity



This equipment is in compliance with the essential requirements and other relevant provisions of Directives 1999/5/EC and 2006/95/EC. The declaration is available on the internet site at [www.sennheiser.com](http://www.sennheiser.com).

Before putting the device into operation, please observe the respective country-specific regulations!

## Statements regarding FCC and industry Canada

This equipment has been tested and found to comply with the limits for a Class B digital device, pursuant to Part 15 of the FCC Rules. These limits are designed to provide reasonable protection against harmful interference in a residential installation. This equipment generates, uses and can radiate radio frequency energy and, if not installed and used in accordance with the instructions, may cause harmful interference to radio communications. However, there is no guarantee that interference will not occur in a particular installation. If this equipment does cause harmful interference to radio or television reception, which can be determined by turning the equipment off and on, the user is encouraged to try to correct the interference by one or more of the following measures:

1. Reorient or relocate the receiving antenna.
2. Increase the separation between the equipment and receiver.
3. Connect the equipment into an outlet on a circuit different from that to which the receiver is connected.
4. Consult the dealer or an experienced radio/TV technician for help.

This class B digital apparatus complies with the Canadian ICES-003.

Warning: Changes or modifications made to this equipment not expressly approved by Sennheiser electronic Corp. may void the FCC authorization to operate this equipment.

This device complies with Part 15 of the FCC Rules and with RSS-210 of Industry Canada. Operation is subject to the following two conditions: (1) this device may not cause harmful interference, and (2) this device must accept any interference received, including interference that may cause undesired operation.

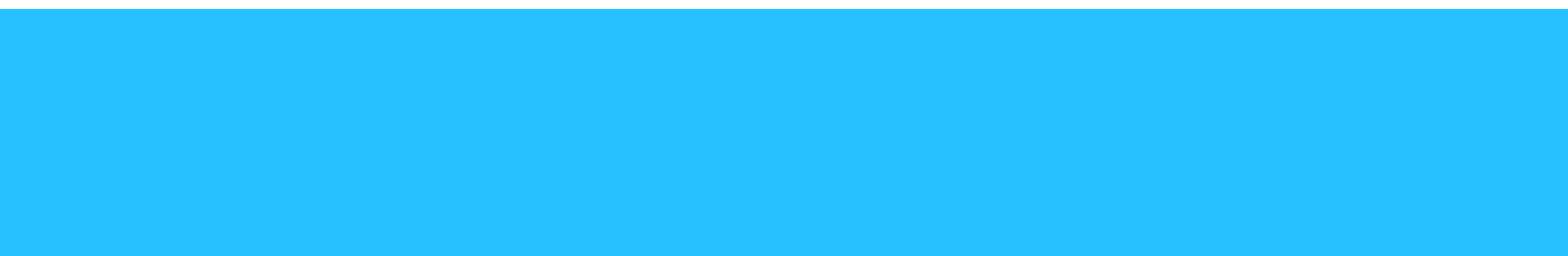

Sennheiser electronic GmbH & Co. KG  
Am Labor 1  
30900 Wedemark, Germany  
Phone +49 (5130) 600 0  
Fax +49 (5130) 600 300  
[www.sennheiser.com](http://www.sennheiser.com)

Printed in Germany  
Publ. 01/08  
516551/A01

## Free Manuals Download Website

<http://myh66.com>

<http://usermanuals.us>

<http://www.somanuals.com>

<http://www.4manuals.cc>

<http://www.manual-lib.com>

<http://www.404manual.com>

<http://www.luxmanual.com>

<http://aubethermostatmanual.com>

Golf course search by state

<http://golfingnear.com>

Email search by domain

<http://emailbydomain.com>

Auto manuals search

<http://auto.somanuals.com>

TV manuals search

<http://tv.somanuals.com>