

MKE *platinum-C*

Bedienungsanleitung
Instructions for use
Notice d'emploi
Istruzioni per l'uso
Instrucciones para el uso
Gebruiksaanwijzing

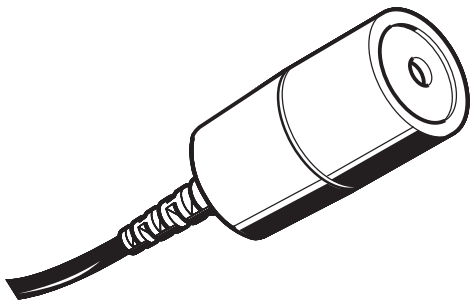

MKE platinum-C

The MKE platinum-C is a high-quality, sub-miniature, sweat-resistant clip-on condenser microphone designed for all areas of live work. It features excellent sound quality and rugged design. The MKE platinum-C is fitted with a very thin (only 1 mm) yet rugged cable, making this microphone an ideal partner for all live sound applications.

Characteristics

- Sub-miniature microphone ideal for unobtrusive attachment to clothing or directly to the head or body.
- High maximum sound pressure level.
- Wide frequency response with treble response adapted to the requirements of live stage work
- Thin (only 1 mm), flexible and rugged cable, low in handling noise.
- Largely insensitive to penetration of sweat due to the patented Umbrella Diaphragm™. This design comprises two individual diaphragms installed on both sides of the diaphragm ring.

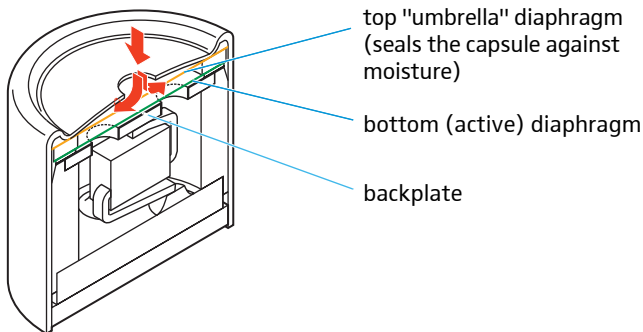

The bottom diaphragm is electrically active and forms the capacitive electroacoustic transducer together with the back plate. The top diaphragm is passive and seals the microphone against sweat and moisture. Robust sealing of the housing is ensured by a silicone ring. Since the diaphragms are extremely small and thin (less than 1 μm), the fact that they are made of different materials does not influence their acoustic properties – over a wide frequency range, these diaphragms oscillate in tandem.

High-note emphasis

Your microphone is delivered with two slip-on caps of different lengths. You may use these caps for high-note emphasis.

Slip the cap on the head of the microphone until it locks into place.

Please refer to the frequency diagrams on the page 39.

- Short slip-on cap: MZC platinum-1
- Long slip-on cap: MZC platinum-2

Makeup protection

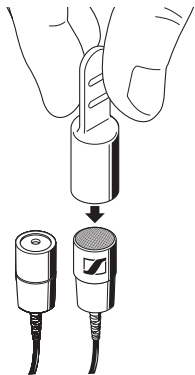

Please protect your MKE platinum-C by means of the makeup protection, if you attach your MKE platinum-C to your body and want to put on makeup. The makeup protection is easy to install: just slip it on the microphone (with or without slip-on cap). The makeup protection prevents makeup from penetrating into the gauze. Remove the makeup protection shortly before you enter the stage.

The makeup protection is available as accessory.

Attachment of the microphone

Depending on the field of application, you may attach the MKE platinum-C in different ways to either articles of clothing or your body.

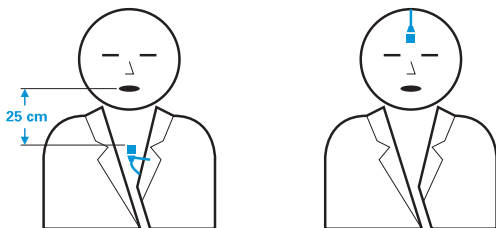

Attachment to articles of clothing

You may use the MZQ 02 clip to attach the microphone to your lapel, tie, collar, a button hole, etc. For better attachment of the cable, snap the cable tube into the microphone holder. You may rotate the microphone holder in the clip in steps of 90°.

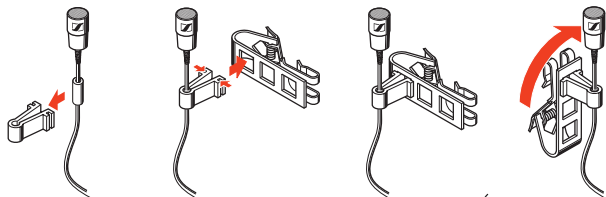

For thin clothes (e.g. silk), please use the outer hole where the clip's contact pressure is the highest.

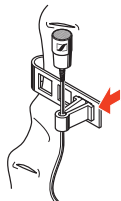

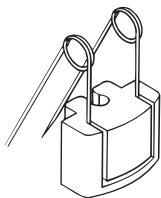

You may also use the ZH 102 pin to attach the microphone to articles of clothing made of fabric that will not be damaged by the pin. The pin attachment withstands high mechanical loads and is also a very convenient solution, if the articles of clothing do not have collars or edges to which the MZQ 02 clip can be attached.



The MZM 10 and MZM 2 magnetic clips can be used for unobtrusive attachment of the microphone to articles of clothing. The frictional force between the microphone and the fabric is often sufficient to ensure that the microphone is not displaced. For smooth and soft clothes, the neckstrap (included) ensures that the microphone is not displaced from its proper position.

Examples of use

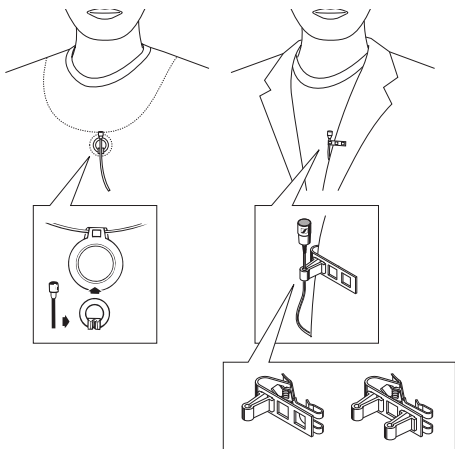

Wind-shields

Wind noise impairs the quality of outdoor recording and close-up miking. The MZW 2 and MZW 02 wind-shields considerably reduce the wind noise.



Please install the MZW 2 wind-shield, first. This wind-shield reduces the wind noise by a maximum of 20 dB.

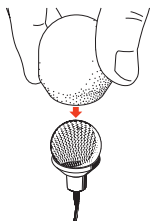

You may further reduce the wind noise by 10 dB by means of the additional MZW 02 foam-net wind-shield.

MZW 2 and MZW 02 are available as accessories.

Freefield frequency-response free

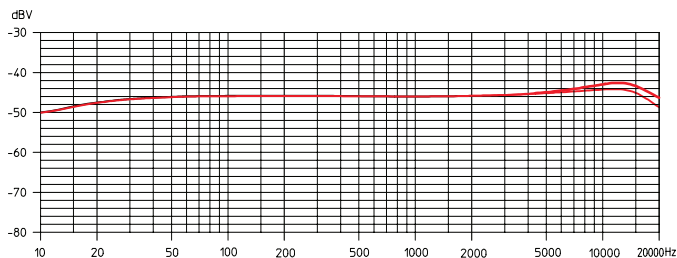

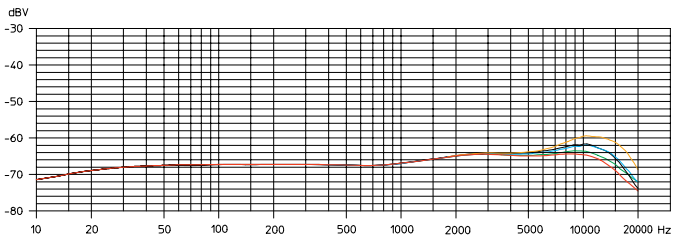

Microphone placed in the middle of the forehead

- capsule only — with MZC2-1 — with MZC2-2
- with MZW2 — with MZC2 and MZW02

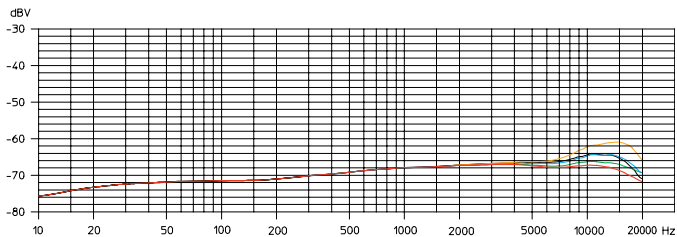
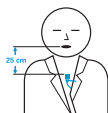

Microphone placed on the chest, distance to the mouth 25 cm

- capsule only — with MZC2-1 — with MZC2-2
- with MZW2 — with MZW2 and MZW02

MKE platinum-C - Technical data

MKE platinum	-4	-4-3	-5	-5-3
Directional-characteristic		omni-directional		
Transmission range		20-20000 Hz \pm 2.5 dB		
Freefield-open-Circuit sensitiv (1kHz)		6.3 mV/Pa \pm 2.5 dB		
Rated impedance		1000 Ω		
Min. terminating-impedance		4.7 K Ω		
Equivalent noise level				
A-weighted (DIN IEC 651)		26 dB		
CCIR-weighted (CCIR 468-1)		39 dB		
Sound pressure level limit		142 dB		
Feed	via SK 50, SK 5012 transmitter		–	–
Plug	3-pin special connetcor			open-ended cable
Colour	anthracite	beige	anthracite	beige
Cable length	1.6 m	1.6 m	4 m	4 m
Diameter of the microphone		4.8 mm		
Weight (without plug+cable)		1 g		
Delivery includes				
MZC platinum-1 slip-on cap		1		
MZC platinum-2 slip-on cap		1		
Instructions for use		1		

Manufacturer declarations

Warranty

2 years

Approval



Sennheiser electronic GmbH & Co. KG declare that this device is in compliance with the applicable CE standards and regulations.

WEEE Declaration



Please dispose of this product at the end of its operational lifetime by bringing it to your local collection point or recycling centre for such equipment.



Sennheiser electronic GmbH & Co. KG
30900 Wedemark, Germany
Phone +49 (5130) 600 0
Fax +49 (5130) 600 300
www.sennheiser.com

Printed in Germany

Publ. 03/07

086046 / A03

Free Manuals Download Website

<http://myh66.com>

<http://usermanuals.us>

<http://www.somanuals.com>

<http://www.4manuals.cc>

<http://www.manual-lib.com>

<http://www.404manual.com>

<http://www.luxmanual.com>

<http://aubethermostatmanual.com>

Golf course search by state

<http://golfingnear.com>

Email search by domain

<http://emailbydomain.com>

Auto manuals search

<http://auto.somanuals.com>

TV manuals search

<http://tv.somanuals.com>