



D 10 series

Wireless DECT
headset system

Instruction manual

 **SENNHEISER**

Contents

- Important safety information 2**
- Scope of delivery 4**
 - Base stations with components 4
 - Headset with components 4
- Product overview 5**
 - Product overview of the base station 5
 - Product overview of the headset 6
 - Overview of the buttons 7
 - Overview of the LEDs 8
- Setting up and connecting the base station 9**
 - Setting up the base station 9
 - Connecting the base station to the mains power supply 9
 - Connecting the base station to a fixed line phone 10
 - Connecting the base station to an optional electronic hook switch control (EHS) 12
 - Connecting the base station to a computer 13
 - Charging the headset before first use 13
- Individually adjusting the headset 14**
 - Using the headset with the ear hook 14
 - Using the headset with the headband 15
- Configuring the headset system 16**
 - Adjusting the headset system using the DIP switches 16
 - Adjusting the audio signal by means of the dial tone 18
 - Adjusting the volume of the transmission 19
 - Adjusting the volume of the ring tone 19
 - Adjusting the automatic audio transmission "Auto Audio" 20
- Making calls using the headset 21**
 - Adjusting the volume 21
 - Muting the headset's microphone 22
 - If you leave the DECT range 22
 - Calling via the fixed line phone using the headset 23
 - Calling via the computer using the headset 25
 - Making a conference call 27
- Charging the headset and storing the headset system 29**
 - Charging the headset 29
 - Switching the headset system off during extended non-use 31
- Sharing a workplace 32**
- Cleaning and maintaining the headset system 33**
 - Replacing the ear pads 34
 - Replacing the headset's rechargeable battery 35
- If a problem occurs 36**
- Specifications 37**
- Manufacturer Declarations 39**



Important safety information

- ▶ Please read this instruction manual carefully and completely before using the product.
- ▶ Always include this instruction manual when passing the product on to third parties.
- ▶ Do not use an obviously defective product.

Preventing damage to health and accidents

- ▶ Do not listen at high volume levels for long periods of time to prevent hearing damage.
- ▶ Always maintain a distance of at least 3.94" (10 cm) between the ear cups and the cardiac pacemaker or implanted defibrillator since the product generates permanent magnetic fields.
- ▶ Keep the product, accessories and packaging parts out of reach of children and pets to prevent accidents and choking hazards.
- ▶ Do not use the product in situations which require special attention (e.g. in traffic).

Preventing damage to the product and malfunctions

- ▶ Always keep the product dry and do not expose it to extreme temperatures (hairdryer, heater, extended exposure to sunlight, etc.) to avoid corrosion or deformation.
- ▶ Only use attachments/accessories supplied or recommended by Sennheiser.
- ▶ Only clean the product with a soft, dry cloth.
- ▶ Unplug the power supply unit from the wall socket to completely disconnect the product from the mains power supply.
- ▶ Do not short-circuit the contacts of the product. Make sure that no metal objects (e.g. paper clips, hair pins, earrings) come into contact with the interfaces and contacts.
- ▶ Only use the base station or the CH 10 charger for charging D 10 series headsets.

Intended use/Liability

The headset system can be used for calling and – together with a computer (VoIP) and/or a telephone – for audio input/output and is intended for professional office or call center use.

It is considered improper use when this product is used for any application not named in this instruction manual.

Sennheiser does not accept liability for damage arising from abuse or misuse of this product and its attachments/accessories. The risk is to be borne by the user.

Sennheiser is not liable for damages to USB devices that are not consistent with the USB specifications.

Sennheiser is not liable for damages resulting from the loss of connection due to flat or overaged rechargeable batteries or exceeding the DECT transmission range.

Safety instructions for Lithium-Polymer rechargeable batteries

In extreme cases, abuse or misuse of rechargeable batteries can lead to:



WARNING

- explosion,
- fire development,
- heat generation or
- smoke/gas development.

	<p>Only charge rechargeable batteries at ambient temperatures between 10°C/50°F and 40°C/104°F.</p>		<p>Do not heat above 70°C/158°F, e.g. do not expose to sunlight or throw into a fire.</p>
	<p>Dispose of defective products with built-in rechargeable batteries at special collection points or return them to your specialist dealer.</p>		<p>When not using rechargeable batteries for extended periods of time, charge them regularly (about every 3 months).</p>
	<p>Only use rechargeable batteries recommended by Sennheiser and the appropriate chargers.</p>		<p>Switch battery pack-powered products off after use.</p>

Scope of delivery



The D 10 series base stations marked with **ML** in their name are optimized for Microsoft® Lync™.

Base stations with components

- D 10 BS USB** for computer
- D 10 BS USB ML** for computer, optimized for Microsoft Lync
- D 10 BS Phone** for fixed line phone

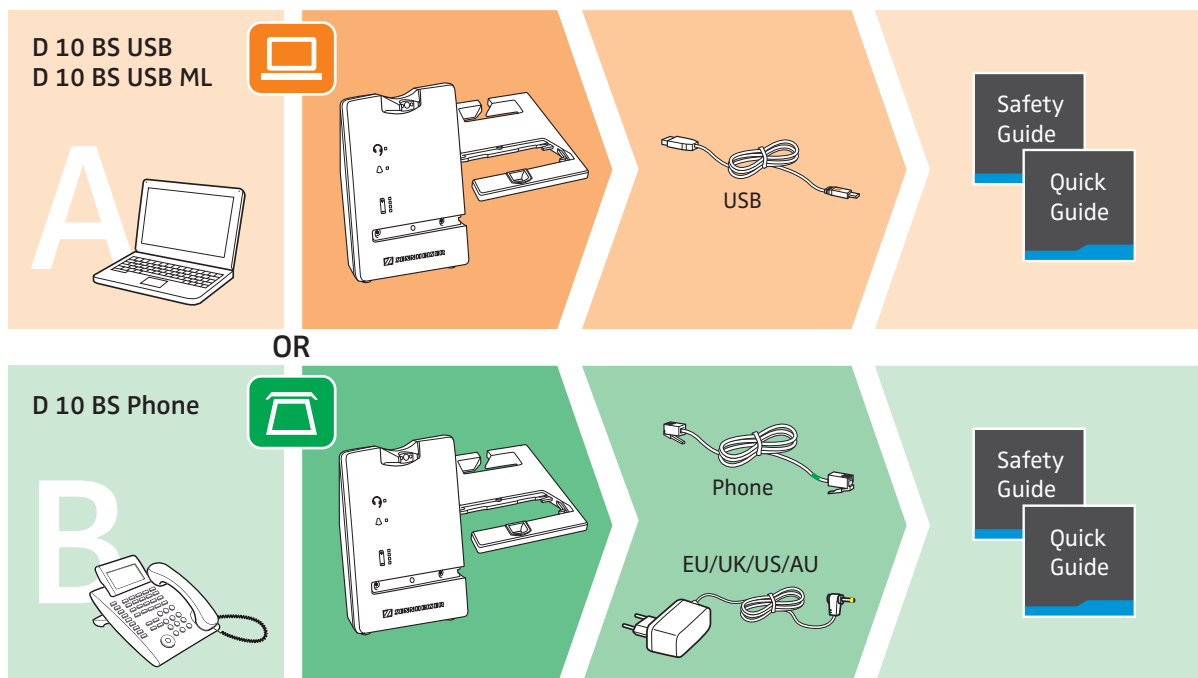

The scope of delivery includes – depending on the product purchased – a base station and/or a headset with corresponding components.

Headset with components

- D 10 HS** monaural, with different wearing styles

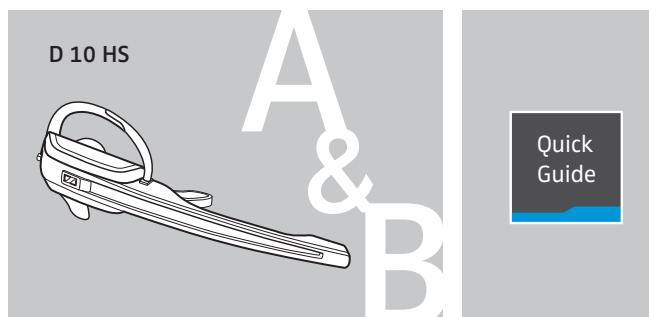

Product overview

Product overview of the base station

Overview of the front

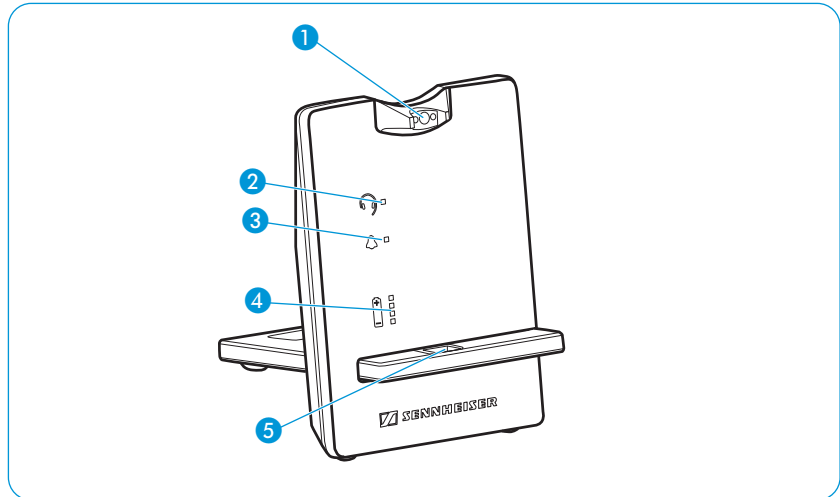

- 1 Magnetic holder with charging contacts
- 2 Link LED
- 3 Incoming call LED
- 4 Charge status LED
- 5 Headset holder

Overview of the rear – Phone version

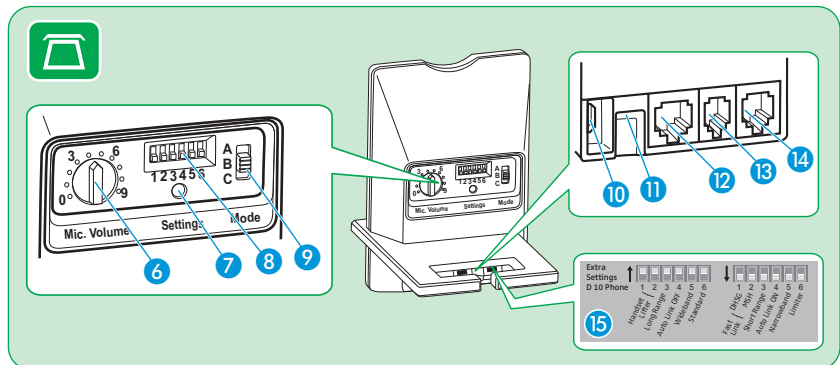

- 6 Microphone volume control
- 7 Set button
- 8 DIP switch row 1 to 6
- 9 ABC switch
- 10 PC socket (USB)
- 11 DC IN socket
- 12 Phone socket
- 13 Handset socket
- 14 ACC socket
- 15 Sticker for DIP switches (located underneath the headset holder)

Overview of the rear – USB version

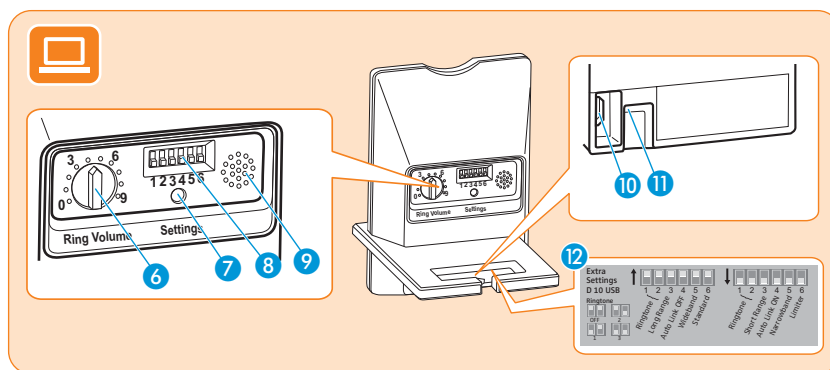

- 6 Ring tone volume control
- 7 Set button
- 8 DIP switch row 1 to 6
- 9 Loudspeaker
- 10 PC socket (USB)
- 11 DC IN socket
- 12 Sticker for DIP switches (located underneath the headset holder)

Product overview of the headset

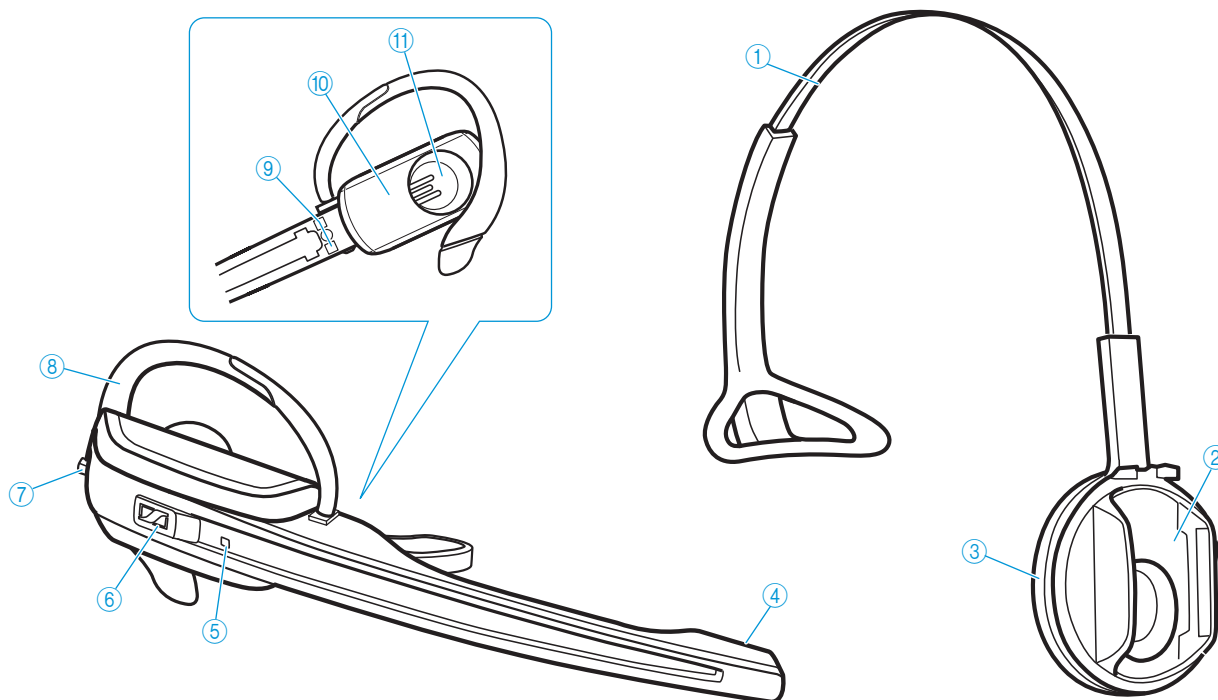

- 1 Headband
- 2 Headset holder
- 3 Ear pad
- 4 Microphone
- 5 Headset LED
- 6 Link button
- 7 Audio button: volume +/-, mute
- 8 Ear hook, adjustable
- 9 Charging contacts
- 10 Battery compartment
- 11 Ear piece

Overview of the buttons

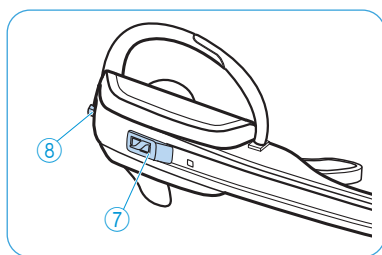

Action	Functions	Page
▶ Press the Link button ⑦	Establishes/disconnects the link between headset and base station	23
	Accepts/ends a call	23/25
▶ Press and hold the Link button ⑦ for 5 seconds	Switches the headset on/off	31
▶ Push the Audio button ⑧ upwards/downwards	Adjusts the ring tone volume and the volume of the acoustic signals or the audio volume	21
▶ Press the Audio button ⑧	Mutes the microphone/unmutes the microphone	22
▶ Press and hold the Link button ⑦ and the Audio button ⑧ for 5 seconds	Changes the direction of the volume up/down function of the Audio button ⑨	21
	Special pairing mode (GAP)	32

Overview of the LEDs

Overview of the LEDs of the base station

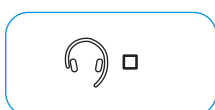
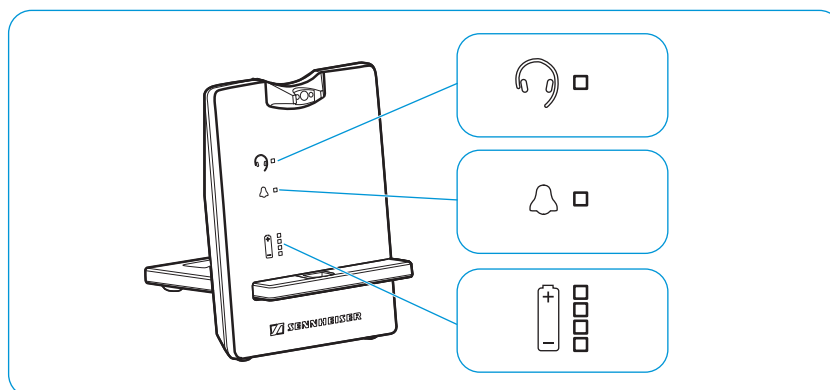



Link LED	Meaning
lights up blue	Active link to the headset
lights up red	No link to the headset
flashes red	Headset is muted
is off	Standby mode, headset is within the range of the base station, but no audio link

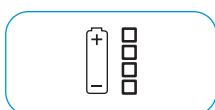

Incoming call LED	Meaning
flashes	Incoming call



Charge status LED (white = lit)	Meaning
 LED segment 1 flashes	Rechargeable battery is almost flat
 LED segments 1 – 4 are lit	Rechargeable battery is charged

Overview of the LEDs of the headset

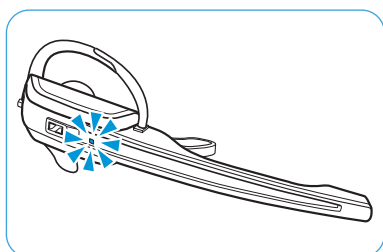

Headset LED	Meaning
lights up blue	Headset is being charged in the base station
flashes blue slowly	Active link to the base station
flashes red 3 times	Rechargeable battery is almost flat
is off	Standby mode or headset is switched off/ headset's rechargeable battery is fully charged
flashes blue/red	Special pairing mode/direction of the volume up/down function of the Audio button is being changed
	Pairing of an additional headset with the base station/conference call

Setting up and connecting the base station

D 10 USB

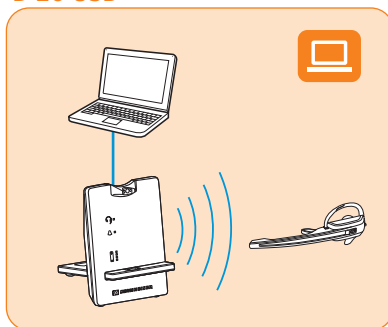

D 10 Phone

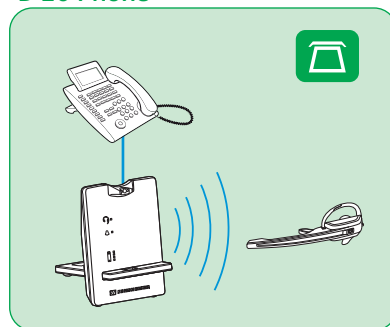

Setting up the base station

- ▶ Insert the headset holder into the recess of the base station.
- ▶ Place the base station at a minimum distance of 15 cm from the fixed line phone.

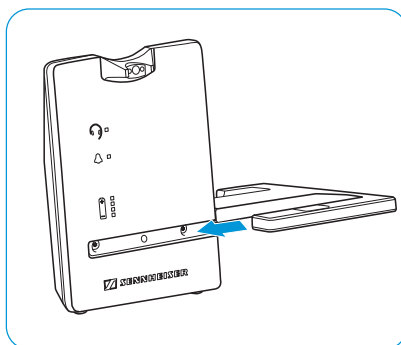

Connecting the base station to the mains power supply



- 1 Connect the plug of the power supply unit to the **DC IN** socket (marked yellow). Connect the power supply unit to a wall socket.
- 2 The Link LED  lights up red.

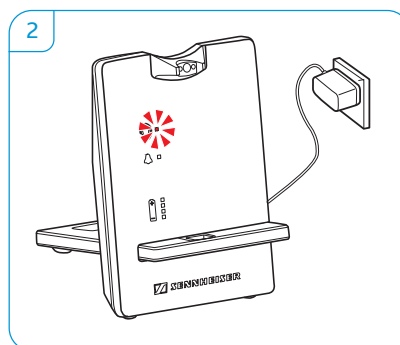
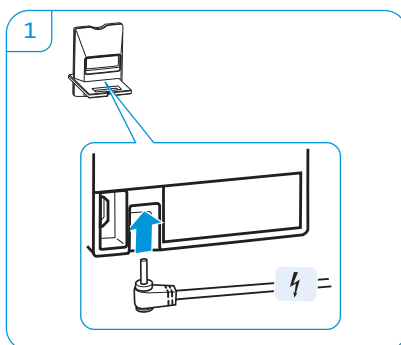

Disconnecting the base station from the mains power supply

- ▶ If the product is not used for extended periods of time, unplug the power supply unit from the wall socket.

Connecting the base station to a fixed line phone



- ▶ Check which connection possibility is best suited for your telephone.
- ▶ Follow the instructions in the corresponding chapter.

Connection possibilities		Page
I	Connection to a fixed line phone without headset socket	10
II	Connection to a fixed line phone with headset socket	11
III	Connection to an optional mechanical handset lifter	11



Connecting the base station to a fixed line phone without headset socket

- 1 Disconnect the handset cable from the telephone and connect it to the **Handset** socket (marked gray) on the base station.
- 2 Connect the telephone cable to the handset socket on the telephone and to the **Phone** socket (marked green) on the base station.
- 3 Use a pointed object (e.g. a ball pen) to set the DIP switches **1** and **2** to the position shown.

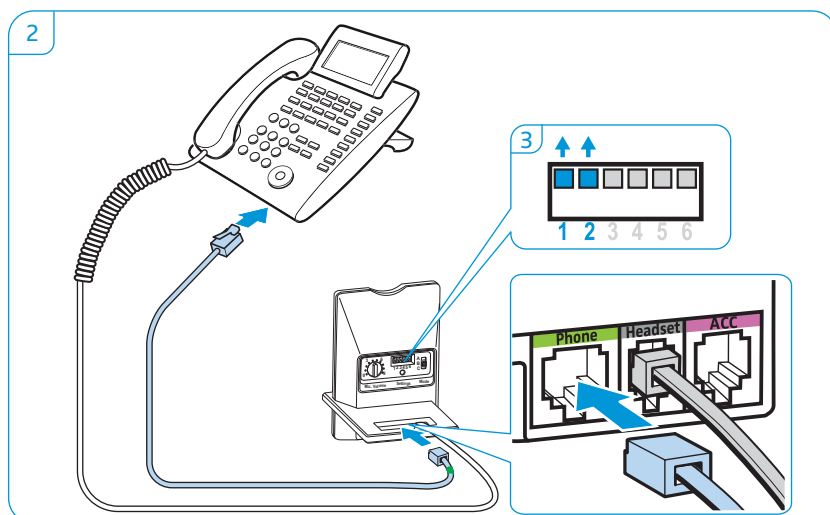
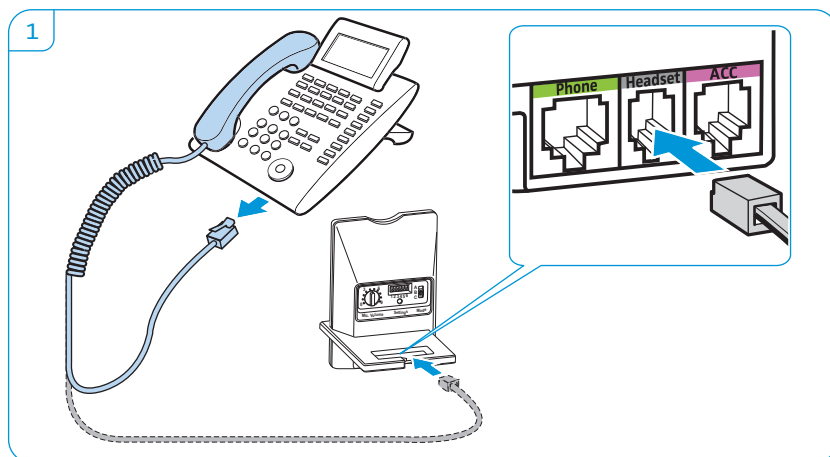

II

Connecting the base station to a fixed line phone with headset socket

- 1 Connect the telephone cable to the headset socket on the telephone and to the **Phone** socket (marked green) on the base station.
- 2 Use a pointed object (e.g. a ball pen) to set the DIP switches 1 and 2 to the position shown.

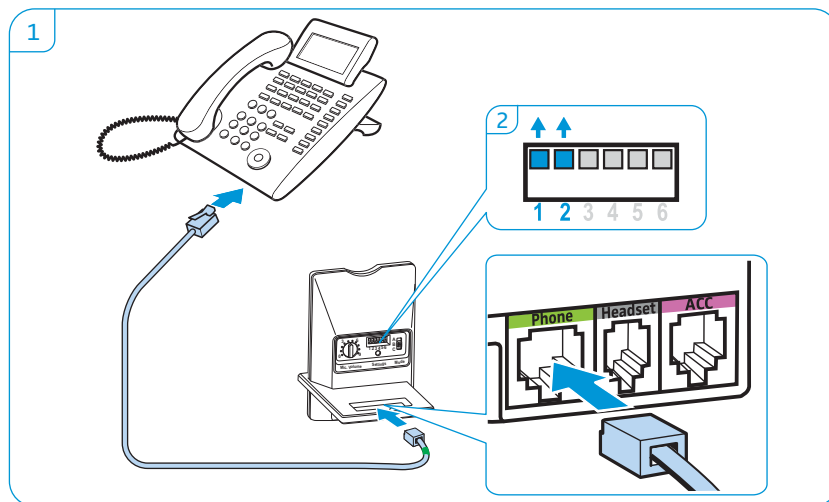

III

Connecting the base station to an optional mechanical handset lifter

The Sennheiser HSL 10 mechanical handset lifter is an optional accessory available from your Sennheiser partner. The handset lifter allows you to answer calls even when you are away from your desk.

- ▶ Connect the base station to the fixed line phone as described in chapter I or II.
- ▶ Connect the handset lifter to the **ACC** socket on the base station.
- ▶ Connect the handset lifter to the fixed line phone. For more information, refer to the instruction manual of the HSL 10 handset lifter.

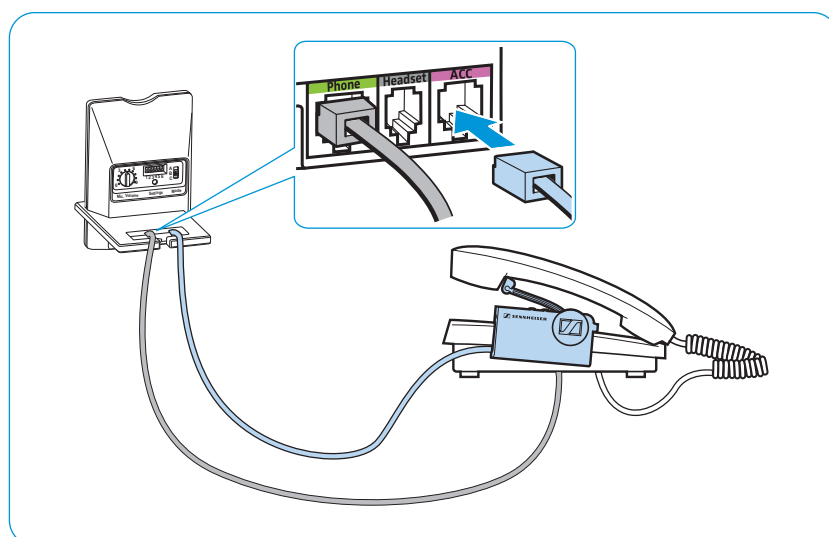

Connecting the base station to an optional electronic hook switch control (EHS)



The necessary EHS connection cables as well as adapter cables for manufacturer specific standards are available as optional accessories from your Sennheiser partner. The corresponding quick guides are supplied with the cables or can be found on the product page on our website at www.sennheiser.com/cco.

By way of example of a Siemens and an Alcatel adapter cable, the following describes how to connect the base station to an electronic hook switch.

- 1 Connect the base station to the fixed line phone.
- 2 Use a pointed object (e.g. a ball pen) to set the DIP switch to the position shown.

Siemens, Agfeo, Aastra, Auerswald, etc.

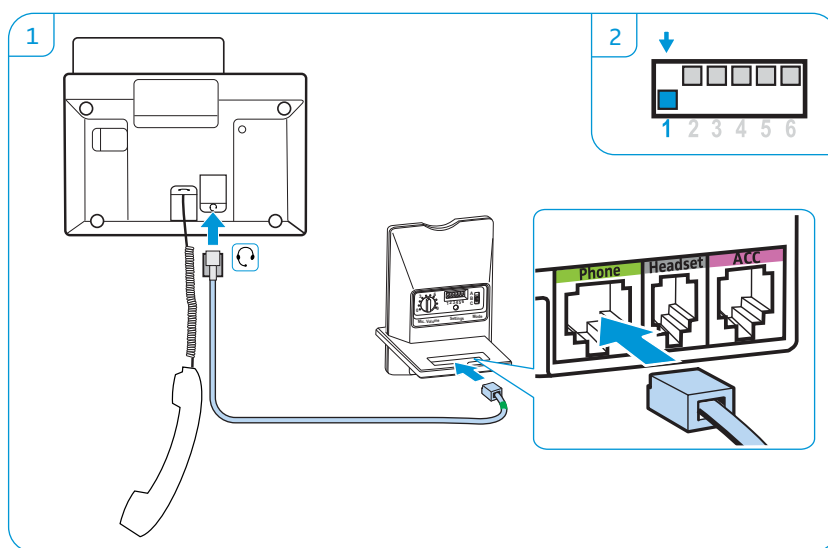

Alcatel

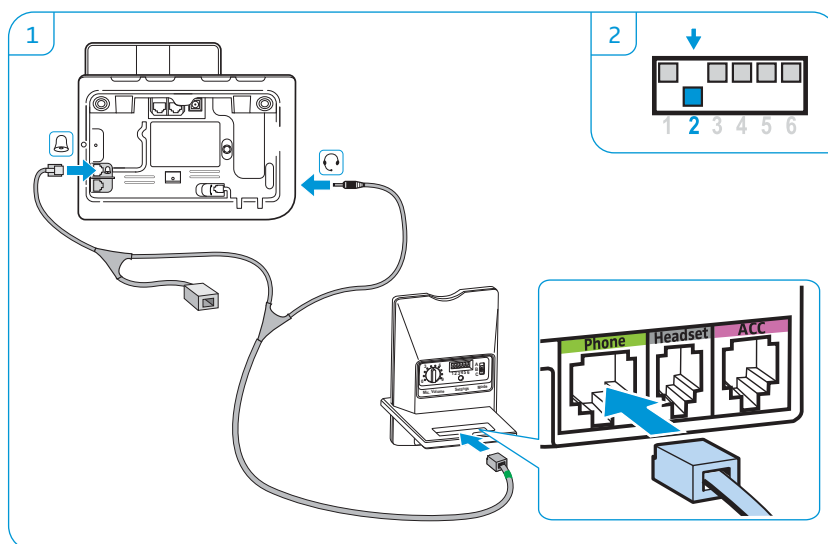

i For an overview of the available connection and adapter cables, visit the D 10 series product page on our website at www.sennheiser.com/cco or contact your Sennheiser partner.

Connecting the base station to a computer



- ▶ Connect the USB cable to the PC socket (marked orange) on the base station and to a USB socket of your computer. The operating system detects the USB audio device "Sennheiser D 10" and installs the necessary drivers.

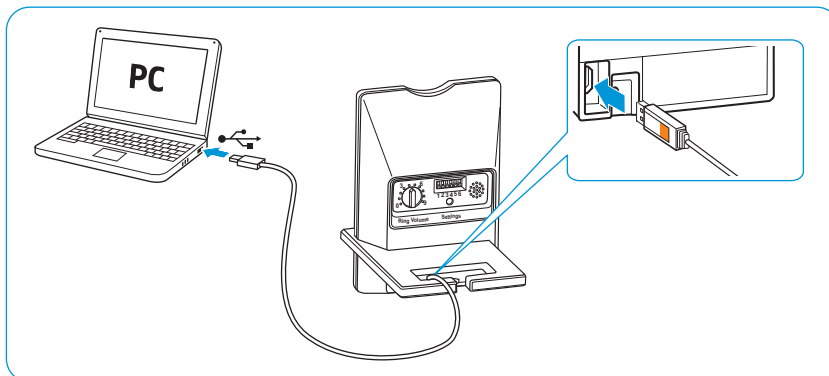

Sennheiser PC software



The free Sennheiser PC software allows you to add value to your Sennheiser products. The Sennheiser Updater, for example, facilitates easy updating of products with new software. For more information, visit our website at www.sennheiser.com/cco/software.

Charging the headset before first use

Charge the rechargeable battery for at least 20 minutes without interruption before using it for the first time. A complete charging process takes about 60 minutes (see page 29).

During the first charging process, it may take up to 5 minutes until the Headset LED lights up blue.

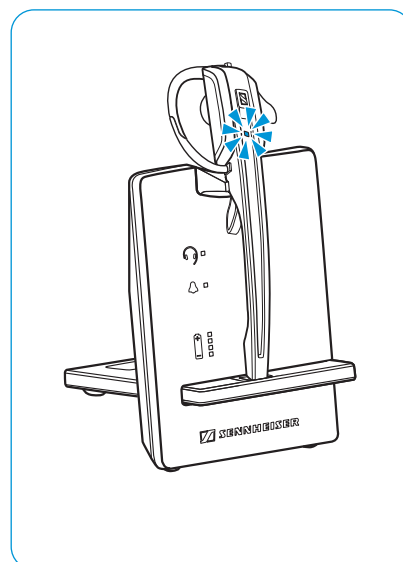
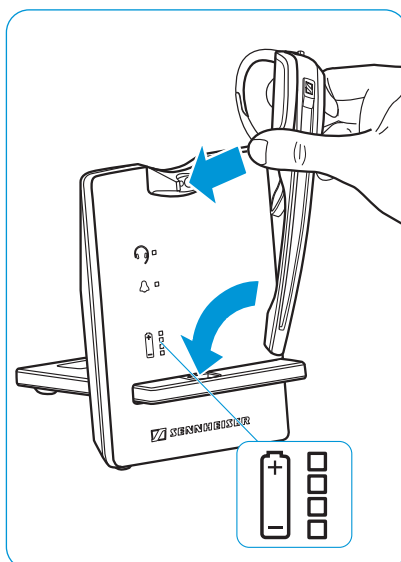

Individually adjusting the headset

Using the headset with the ear hook

- 1 Insert the ear hook into the ear hook slot.
- 2 Pre-shape the ear hook by bending it slightly.
- 3 Place the ear hook around your ear.
- 4 Bend the flexible ear hook so that the headset sits comfortably and securely on your ear.

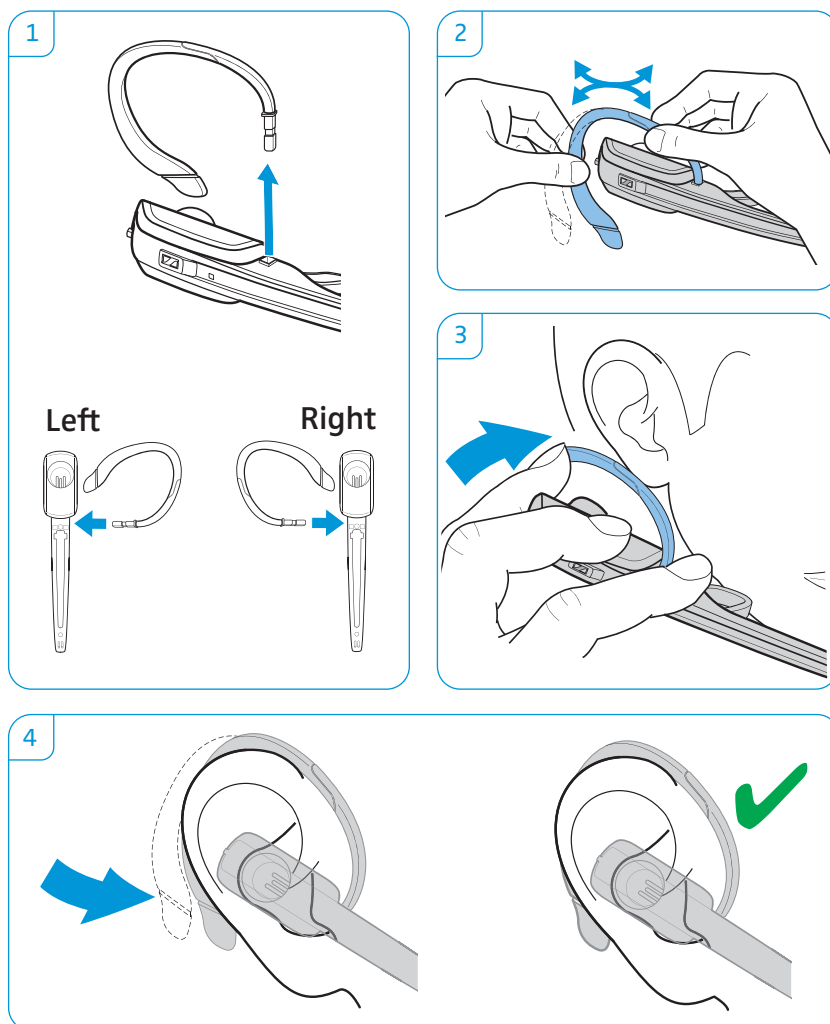

Using the headset with the headband

- 1 Remove the ear hook by carefully pulling it upwards.
- 2 Attach the headset to the headset holder of the headband.
- 3 Rotate the microphone boom and adjust the headset so that the ear pad rests comfortably on your right or left ear.

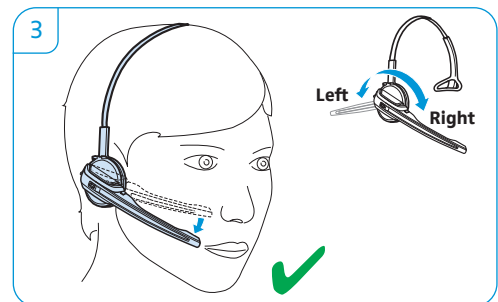
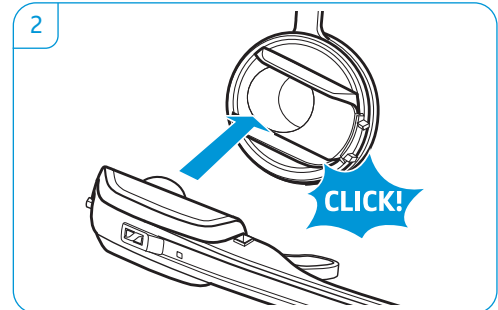
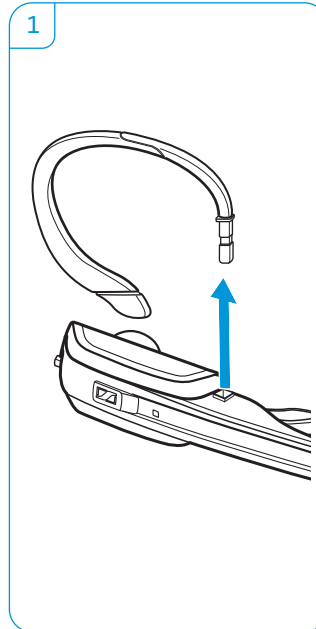

Configuring the headset system

Adjusting the headset system using the DIP switches

- ▶ Use a pointed object (e.g. a ball pen) to set the DIP switches to the desired position.

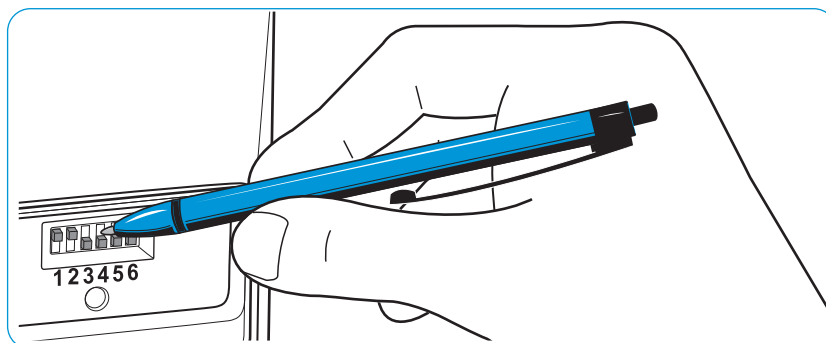

Configuring the handset lifter/hook switch – DIP switches 1 and 2



Switch position	Function
<p>1 2 3 4 5 6</p>	Manual operation Lifts/hangs up the handset manually or using the handset lifter (Sennheiser HSL 10).
<p>1 2 3 4 5 6</p>	Electronic hook switch (DHS standard) Call control via the headset system. For faster link establishment, see Fast Link.
<p>1 2 3 4 5 6</p>	Electronic hook switch (MSH standard) Call control via the headset system.
<p>1 2 3 4 5 6</p>	Fast Link for DHS standard and HSL 10 handset lifter Recommended for frequent callers. Shorter battery life. Fast link establishment without delay due to hidden link to the base station.

Adjusting the ring tones of the base station – DIP switches 1 and 2



Switch position	Function
<p>1 2 3 4 5 6</p>	Ring tone is off.
<p>1 2 3 4 5 6</p>	Ring tone 1 is activated.
<p>1 2 3 4 5 6</p>	Ring tone 2 is activated.
<p>1 2 3 4 5 6</p>	Ring tone 3 is activated.



Adjusting the radio range – DIP switch 3

If many DECT systems are operated in a confined space, interference can occur. In this case, you should change the radio range.

Switch position	Function
<p>1 2 3 4 5 6</p>	Standard radio range
<p>1 2 3 4 5 6</p>	Reduced radio range Use this setting in order to avoid interference with other DECT systems Range of approx. 10 m indoors

Automatically establishing the wireless link between headset and base station (Auto Link) – DIP switch 4

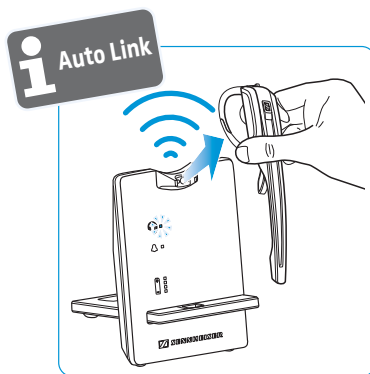

Switch position	Function
<p>1 2 3 4 5 6</p>	Manual link establishment When taking the headset out of the base station, you have to manually establish the wireless link between headset and base station.
<p>1 2 3 4 5 6</p>	Automatic link establishment – Auto Link When taking the headset out of the base station, a wireless link is automatically established between headset and base station.

Switching between wideband and narrowband audio transmission – DIP switch 5

Switch position	Function
<p>1 2 3 4 5 6</p>	Wideband audio transmission Automatic frequency adjustment of wideband and narrowband calls. Wideband audio transmission is e.g. supported by Skype and gives high speech quality. Battery life: 8 hours
<p>1 2 3 4 5 6</p>	Narrowband audio transmission Battery life: 12 hours

Limiting the volume – DIP switch 6

Switch position	Function
<p>1 2 3 4 5 6</p>	Standard limitation
<p>1 2 3 4 5 6</p>	Limited volume (country specific) <ul style="list-style-type: none"> AU version: in compliance with Directive AS/ACIF G616:2006 EU and US version: in compliance with Directive 2003/10/EC

Adjusting the audio signal by means of the dial tone



- 1 Put on the headset.
- 2 Press the Link button on the headset. The Link LED  on the base station lights up blue.
- 3 Lift the handset. You hear a dial tone.
- 4 Set the ABC switch to the position A, B or C so that you can hear a clear dial tone in the headset.

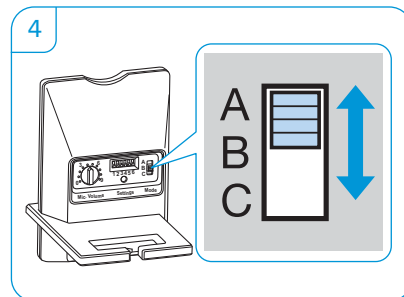
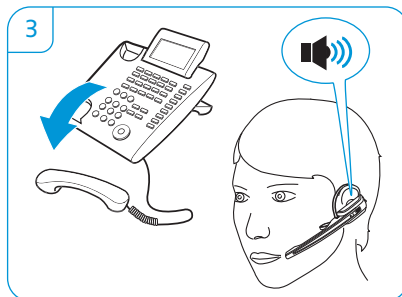
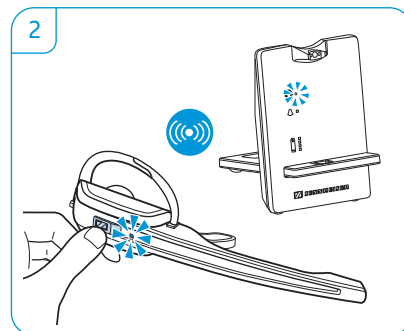
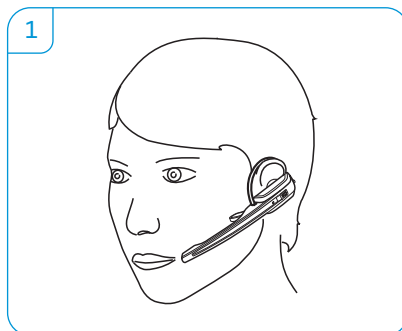

Adjusting the volume of the transmission



Adjusting the microphone volume of the call transmission

By default, the microphone volume control is set to position 4. This setting is suitable for most telephones.

- ▶ Make a call to someone who will help you find the correct sensitivity setting for your microphone.
- ▶ Turn the microphone volume control so that the other party can hear you at a comfortable level.

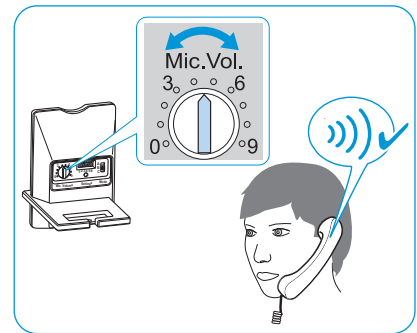

Adjusting the microphone volume of the USB transmission

Some softphones adjust the microphone sensitivity automatically.

- ▶ Activate this function in order to be able to optimally use the microphone and, via your operating system, adjust the microphone sensitivity so that the other party can hear you at a comfortable level (see the Help function of your operating system).



Adjusting the volume of the ring tone

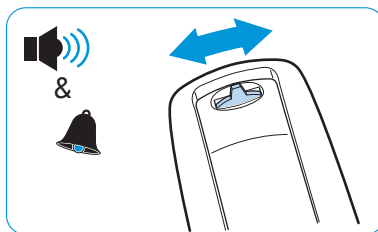

Adjusting the headset's ring tone volume and the volume of the acoustic signals

- ▶ Make sure that the headset is in standby mode (the Link LED  on the base station is off). If necessary, press the Link button on the headset.
- ▶ To adjust the volume, move the Audio button as shown in the diagram. When the minimum or maximum volume is reached, you hear a double beep in the headset.



Adjusting the ring tone volume of the base station

- ▶ Turn the volume control to reduce or increase the ring tone volume.

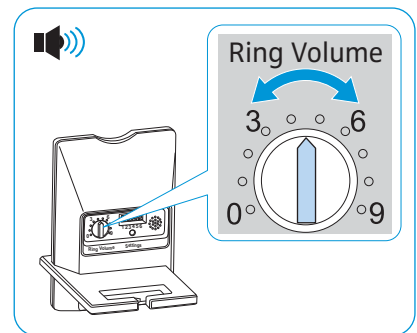
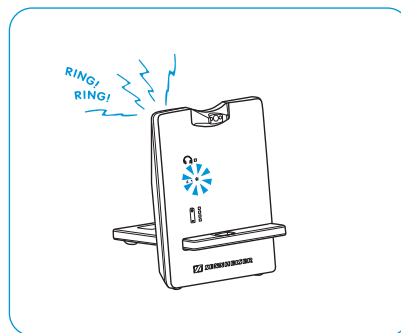



Adjusting the automatic audio transmission “Auto Audio”

With the “Auto Audio” function activated and in the case of a USB connection, the audio signals – e.g. from Windows® Media Player® or iTunes® – are automatically transmitted to the headset.

When you receive a call or when a connection to Skype™ or HeadSetup is established, the audio transmission stops and you hear for example the ring tone. The “Auto Audio” function is activated by default.

Deactivating the “Auto Audio” function

- ▶ Use a pointed object to press the Set button for approx. 5 seconds. The Link LED  rapidly flashes red several times.

Activating the “Auto Audio” function

- ▶ Use a pointed object to press the Set button for approx. 5 seconds. The Link LED  rapidly flashes blue several times.

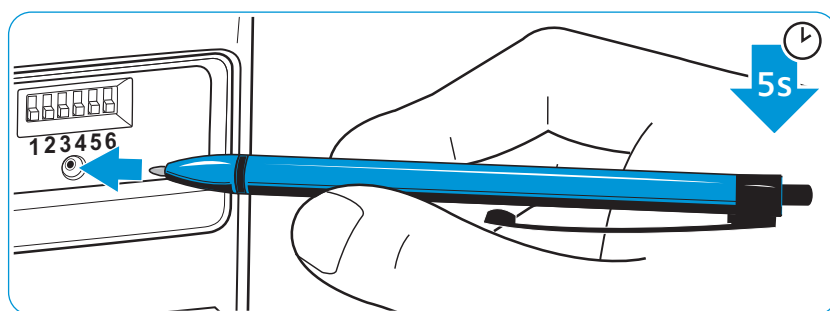

Making calls using the headset

Adjusting the volume



WARNING

Hearing damage due to high volumes!

Listening at high volume levels for long periods can lead to permanent hearing defects.

- ▶ Set the volume to a low level before putting on the headset.
- ▶ Do not continuously expose yourself to high volumes.

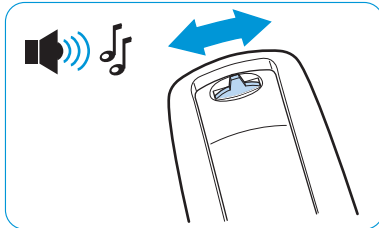

Adjusting the volume of the audio signal

You can adjust the volume of the audio signal by means of the dial tone or during a call.

- ▶ Make sure that a link is established between headset and base station (the Link LED  on the base station lights up blue). If necessary, press the Link button on the headset.
- ▶ To adjust the volume, move the Audio button as shown in the diagram. When the minimum or maximum volume is reached, you hear a double beep in the headset.

Swapping the direction of the volume buttons

- ▶ On the Audio button, check which direction is assigned "volume down".
- ▶ Simultaneously press and hold the Link button and the Audio button for 5 seconds. The Headset LED alternately flashes blue/red.
- ▶ Push the Audio button in the direction "volume down" until the Headset LED goes off. The direction of the volume up/down function of the Audio button is changed. The headset switches to standby mode.

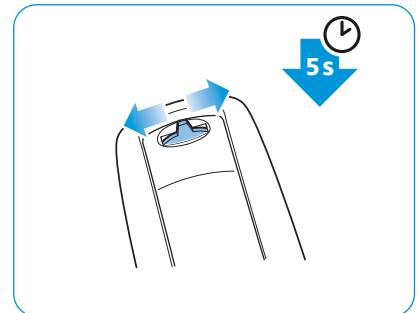
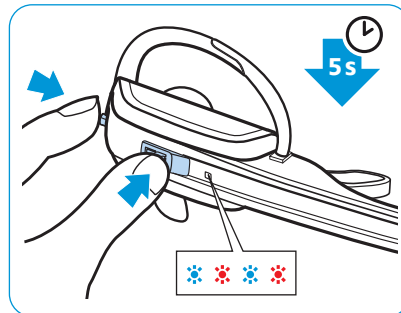

Muting the headset's microphone



- ▶ Press the Audio button.
The microphone is muted. While the microphone is muted, the Link LED  on the base station flashes red.

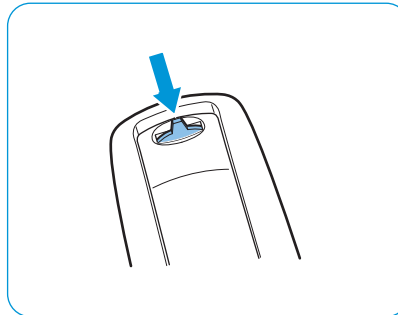

Unmuting the headset's microphone

- ▶ Press the Audio button.
You hear a beep in the headset. The muting is canceled and the Link LED  on the base station lights up blue.

If you leave the DECT range

In normal office buildings, the range between headset and base station is up to 55 m. If, during a call, the audio quality deteriorates or the link breaks down completely, you hear a descending sequence of beeps in the headset. The Link LED  on the base station lights up red.

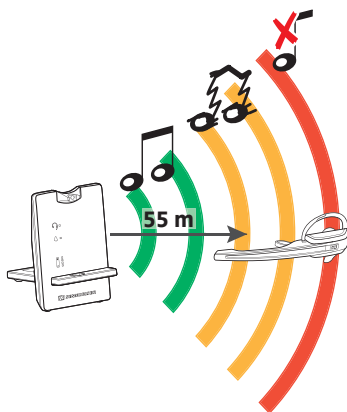

- ▶ Re-enter the DECT range of the base station within 60 seconds.
You hear a ring tone in the headset.
- ▶ Press the Link button on the headset to resume the call.
If your softphone supports call control, the call will automatically be ended 60 seconds after leaving the DECT range.

Calling via the fixed line phone using the headset



Establishing/disconnecting a wireless link

If you want to use the headset to accept, make or end calls, you have to establish a wireless link between headset and base station. You can choose between manual and automatic link establishment (see "Auto Link" on page 17).

- ▶ Press the Link button on the headset.
 - The link is established. The Link LED (🔊) on the base station lights up blue and the Headset LED flashes blue slowly.
- OR
- The link is disconnected. The Link LED (🔊) on the base station and the Headset LED go off. The headset is in standby mode.

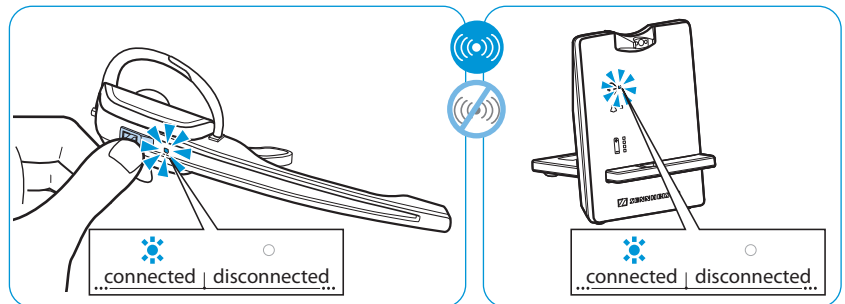

i If your telephone has a built-in electronic hook switch supporting the MSH standard, you can only disconnect the wireless link between headset and base station by placing the headset into the base station.

Managing calls without using a call control functionality

Accepting a call: You hear the ring tone of the fixed line phone. Press the Link button on the headset. Lift the handset or press the "accept call" button on your fixed line phone.

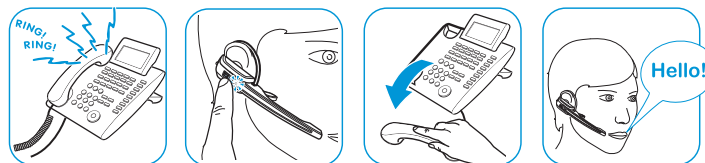
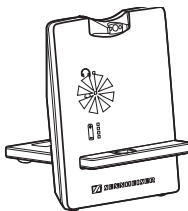

Making a call: Press the Link button on the headset to establish a link between base station and headset. Lift the handset and dial the desired number. The phone connection is established.



Ending a call: Hang up the handset or press the "end call" button on your fixed line phone.



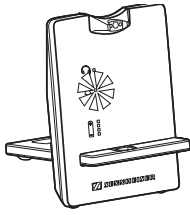

Managing calls using a call control functionality (EHS, HSL 10)

Accepting a call: You hear a ring tone in the headset. Press the Link button on the headset to accept the call. The handset lifter/electronic hook switch lifts the handset.

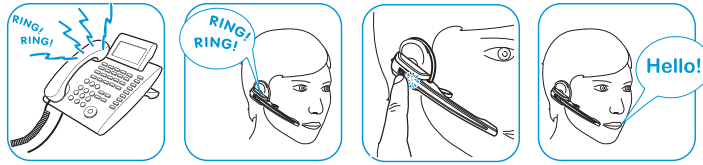

Making a call: Dial the desired number. Press the Link button on the headset to establish a link between base station and headset. The phone connection is established automatically.

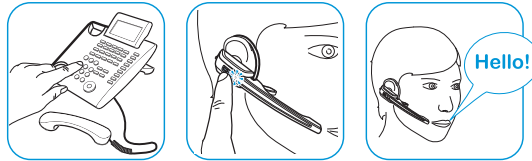

Ending a call: Press the Link button. If the other party hangs up, your telephone and your headset become automatically ready to receive the next call.



Frequent callers who use an electronic hook switch with DHSG capability are recommended to activate the "Fast Link" function for faster link establishment (see page 15)

Switch position	Function
<p>1 2 3 4 5 6</p>	<p>Fast Link (only when DHSG standard is used) Recommended for frequent callers. Shorter battery life. Fast link establishment without delay due to hidden link to the base station.</p>

Switching a call between headset and fixed line phone

- ▶ Press the Link button on the headset to switch between headset and handset of the fixed line phone during an ongoing call.

i In case of a fixed line phone with a handset lifter/an electronic hook switch, this switching can only be done on the fixed line phone.

Calling via the computer using the headset



Establishing/disconnecting a wireless link

If you want to use the headset to accept, make or end calls, you have to establish a wireless link between headset and base station. You can choose between manual and automatic link establishment (see "Auto Link" on page 17).

- ▶ Press the Link button on the headset.
 - The link is established. The Link LED (🔊) on the base station lights up blue and the Headset LED flashes blue slowly.
 - OR
 - The link is disconnected. The Link LED (🔊) on the base station and the Headset LED go off. The headset is in standby mode.

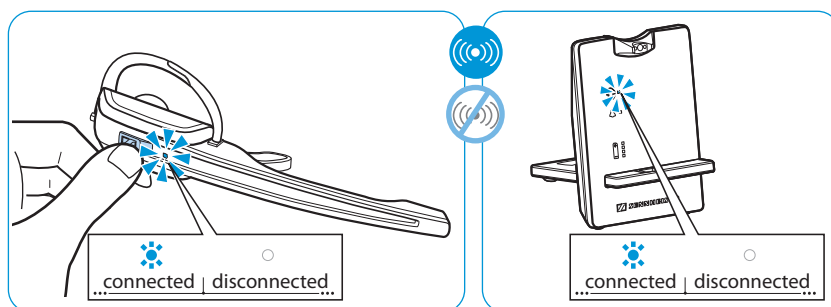

Managing calls via the softphone

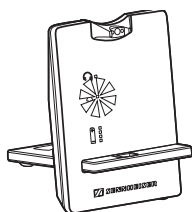

Accepting a call: The softphone signals that you are receiving a call. You hear a ring tone in the headset. Click on "Accept call" on your softphone.

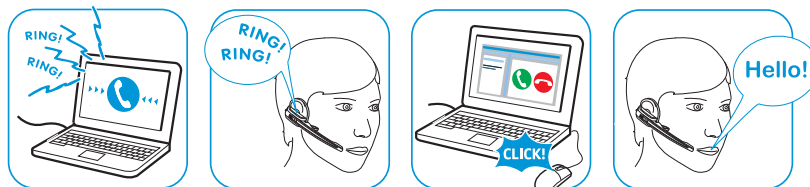

Making a call: Press the Link button on the headset to establish a link between base station and headset. If the "Auto Audio" function is activated, this step is not necessary (see page 20). Start the call using your softphone.



Ending a call: End the call using your softphone.



Managing calls via the headset

The Microsoft® Lync™ softphone supports this function automatically. If you use another softphone, please visit our website at www.sennheiser.com and check whether and which free Sennheiser software you additionally require. If necessary, install the software in order to manage calls directly via the headset.

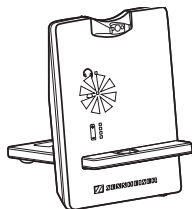

Accepting a call: The softphone signals that you are receiving a call. You hear a ring tone in the headset. Press the Link button on the headset to accept the call.

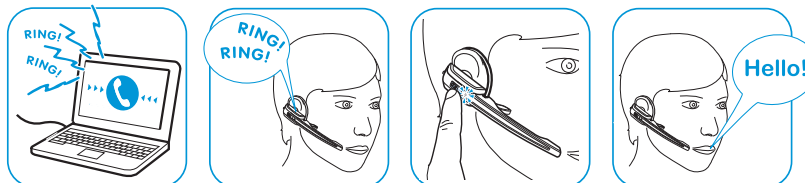

Making a call: Start the call using your softphone, the audio signal is automatically transmitted to the headset.



Ending a call: Press the Link button. If the other party hangs up, your softphone and your headset become automatically ready to receive the next call.

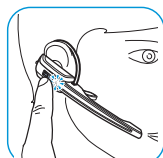

Making a conference call

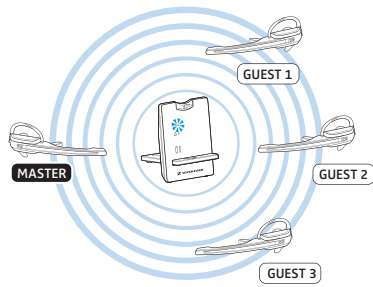

The headset system allows you to make a conference call with up to 4 D 10 series headsets. The first headset paired (master) is used control the call establishment and end of conversation.

Pairing the MASTER headset with the base station

The Link LED (📶) on the base station is off (headset is disconnected) or lights up red (no headset paired).

- ▶ Place the master headset into the base station. The Headset LED alternately flashes blue/red until a link to the base station is established. The Headset LED flashes blue 3 times.
- ▶ Take the headset out of the base station and press the Link button to connect the headset with the base station. The Link LED (📶) on the base station lights up blue.

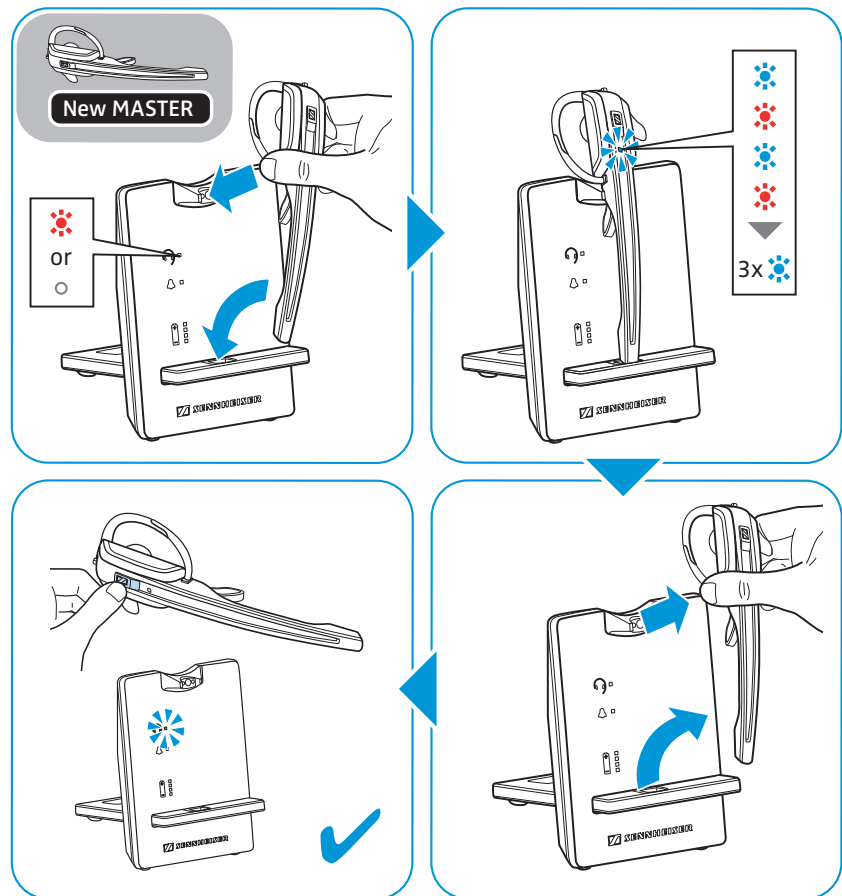

Adding a GUEST headset to a conference call

- ▶ Press and hold the Audio button while placing the guest headset into the base station of the master headset. The Headset LED alternately flashes blue/red until a link to the base station is established. The Headset LED flashes blue 3 times.
- ▶ Take the guest headset out of the base station. You hear a beep in the master headset.
- ▶ To add the guest headset to the conference call, press the Link button on the master headset within 15 seconds.
- ▶ Repeat this procedure to add additional guest headsets to the conference call.

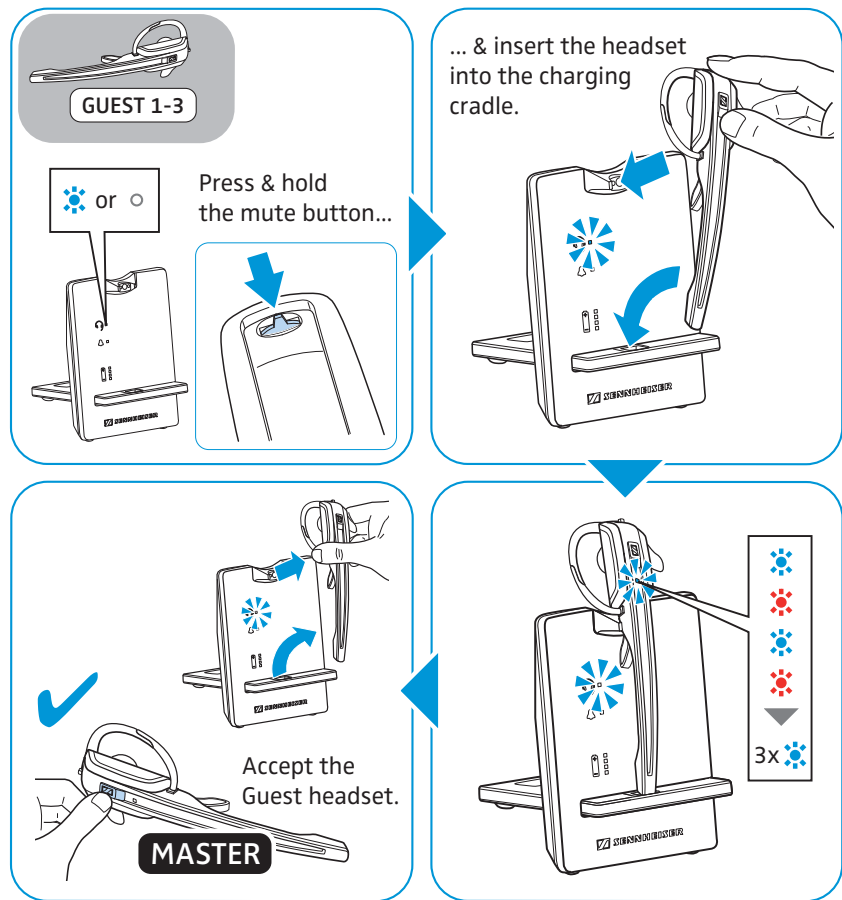

- ▶ Call the other party. The Link LED on the base station flashes blue.

Dropping a GUEST headset from the conference call

- ▶ Press the Link button on the guest headset. The guest headset is dropped from the conference call.

i "easy pairing" To subsequently use the guest headset with other base stations, place the guest headsets into the other base stations. The Headset LED alternately flashes blue/red until a link is established.

Ending a conference call

- ▶ Place the master headset into the magnetic holder of the base station to end the conference call and to drop the guest headsets from the conference call.

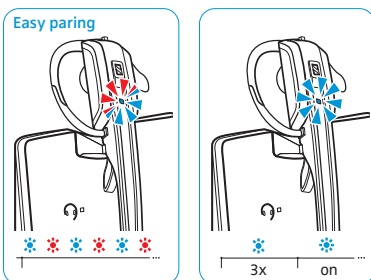

Charging the headset and storing the headset system

Charging the headset

Always store the headset in the base station to ensure that it is fully charged when needed. The intelligent battery charging technology prevents over-charging.

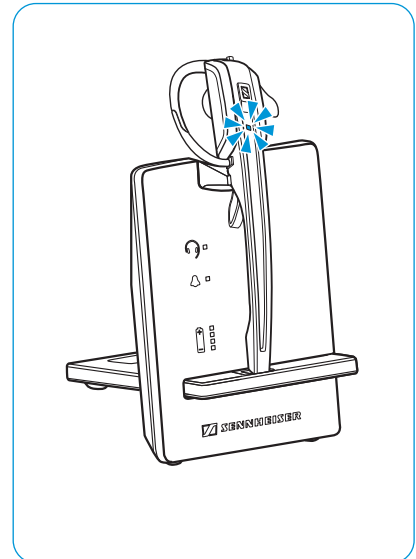
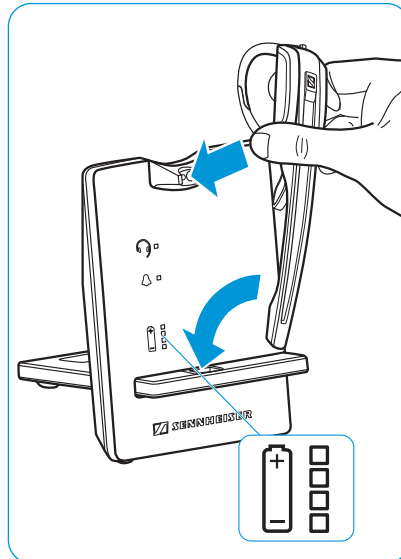

- ▶ Place the headset into the magnetic holder of the base station. The Headset LED lights up blue and the rechargeable battery is being charged. The Charge status LED on the base station indicates the charge status:

LED segment (white = lit up)	Required charging time	Corresponds to a talk time of	
		Wideband	Narrowband
	approx. 10 min.	approx. 2 hrs	approx. 3 hrs
	approx. 20 min.	approx. 4 hrs	approx. 6 hrs
	approx. 40 min.	approx. 6 hrs	approx. 9 hrs
	approx. 60 min.	approx. 8 hrs	approx. 12 hrs

Shortly before the rechargeable battery is about to run flat, only one LED segment lights up weakly. The Headset LED flashes red and you hear three beeps. You have several minutes of battery reserve. When the rechargeable battery is flat, the headset switches off.

- i** f the headset is outside the range of the base station, it will switch off after 30 minutes in order to conserve battery power.

Charging the headset using the optional CH 10 headset charger

The CH 10 headset charger is an optional accessory available from your Sennheiser partner. The CH 10 allows you to charge additional D 10 series headsets, e.g. for sharing the same base station when working shifts.

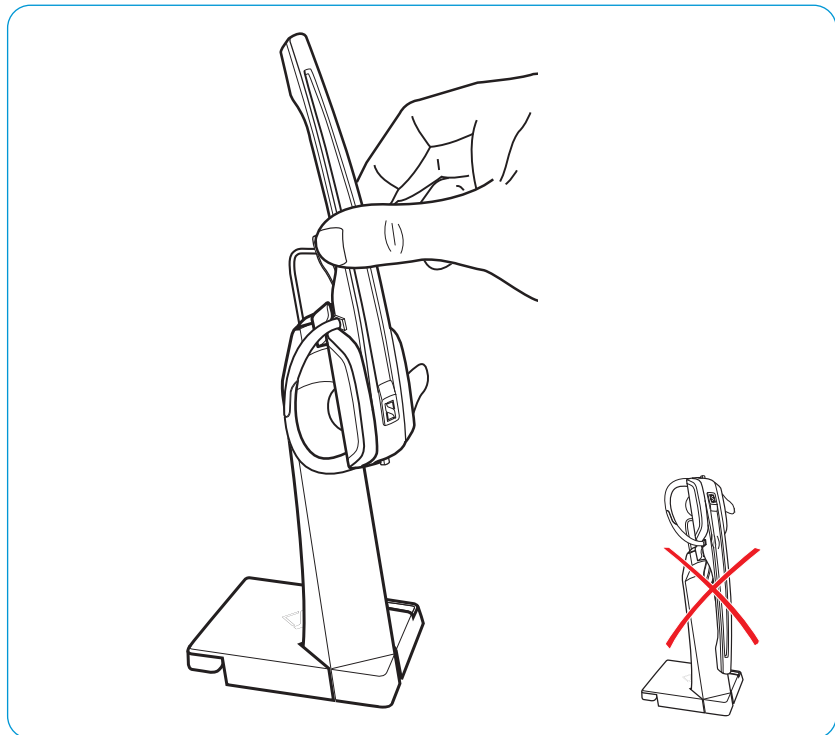

► Refer to the instruction manual of the CH 10 for more information.

Charging several headsets simultaneously

The MCH 7 multi USB power source is an optional accessory available from your Sennheiser partner. Together with the CH 10 USB, the MCH 7 allows you to charge up to 7 headsets simultaneously.

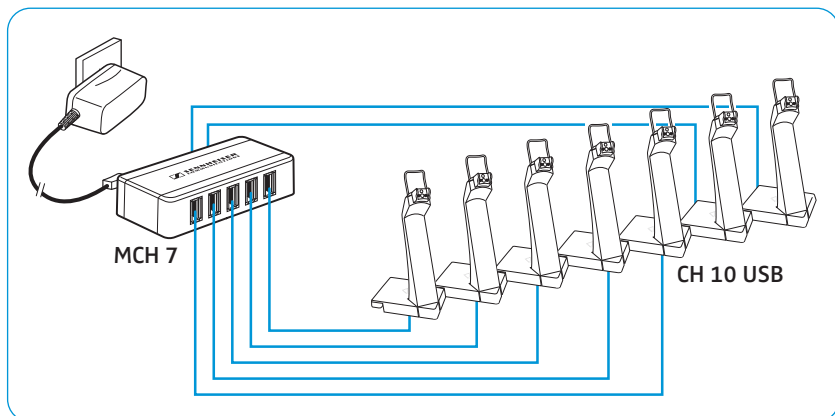

► Refer to the instruction manual of the MCH 7 for more information.

Switching the headset system off during extended non-use

You can switch off the headset system (1) or the headset (2) when not using the products for extended periods of time (e.g. when you are on holiday).

Switching the headset system off

- 1 Disconnect the base station from the mains power supply. The base station switches off immediately, the headset switches off about 30 minutes later.
- 2 Press and hold the Link button for 5 seconds to switch off the headset immediately. The Headset LED flashes red 3 times, the headset is switched off completely. The Link LED  on the base station lights up red after a short time, the Charge status LED on the base station goes off.

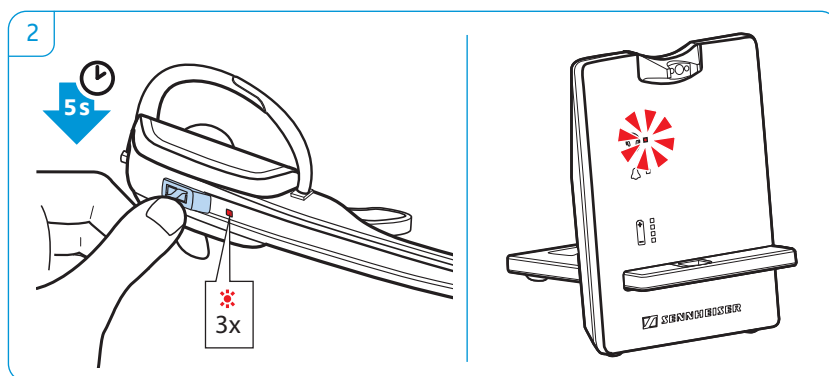
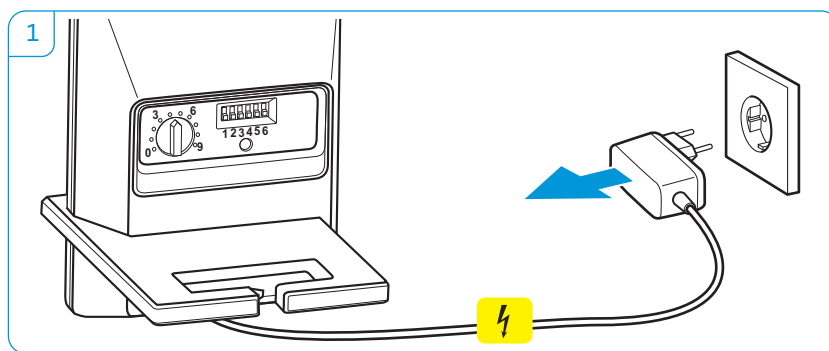

Switching the headset system on and pairing the components

- ▶ Plug the power supply unit into a wall socket. The base station is switched on.
- ▶ Place the headset into the magnetic holder of the base station. The Headset LED flashes blue 3 times and then lights up blue. The base station and the headset are paired.

Sharing a workplace

The headsets and base stations of the D 10 series are compatible with each other. If, for example, you share a workplace, you can use one base station with different headsets. The last headset paired with the base station can be used without more ado.

- ▶ Place the headset to be used into the magnetic holder of the base station.
The Headset LED alternately flashes blue/red until the headset is successfully paired with the base station. The Headset LED flashes 3 times blue and then goes off. You can now use the newly paired headset.

If pairing has failed, the Link LED  on the base station lights up red or is off. Repeat the procedure.

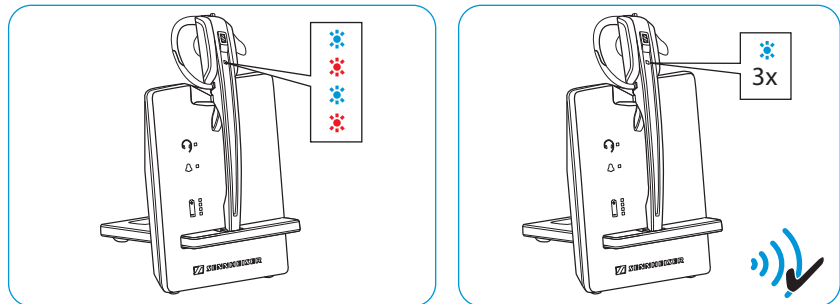

Using the headset with a third party base station (DECT-GAP telephone)

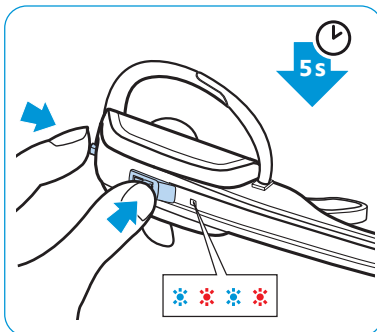

- ▶ Place the headset at a maximum distance of 1 m from the third party base station.
- ▶ Simultaneously press and hold the headset's Link button and Audio button for 5 seconds.
The headset switches to a special pairing mode and the Headset LED alternately flashes blue/red.
- ▶ Set the third party base station to a special pairing mode (see the instruction manual of the third party base station). The default code for the headset is "0000".
The headset pairs with the third party base station. If pairing is successful, the Headset LED goes off.

If pairing is not successful within 60 seconds, the headset switches back to standby mode.

To pair the headset again with a D 10 series base station:

- ▶ Simultaneously press and hold the headset's Link button and Audio button for 5 seconds.
The headset switches to a special pairing mode and the Headset LED alternately flashes blue/red.
- ▶ Place the headset into the magnetic holder of the base station. The Headset LED flashes blue 3 times and then lights up blue. The base station and the headset are paired.

Cleaning and maintaining the headset system

CAUTION

Liquids can damage the electronics of the product!

Liquids entering the housing of the product can short-circuit the electronics.

- ▶ Keep all liquids far away from the product.
 - ▶ Do not use any solvents or cleansing agents.
-
- ▶ Before cleaning, disconnect the base station from the mains power supply.
 - ▶ Only use a dry and soft cloth to clean the product.
 - ▶ Clean the charging contacts of the base station and the charging contacts of the headset from time to time using e.g. a cotton swab.

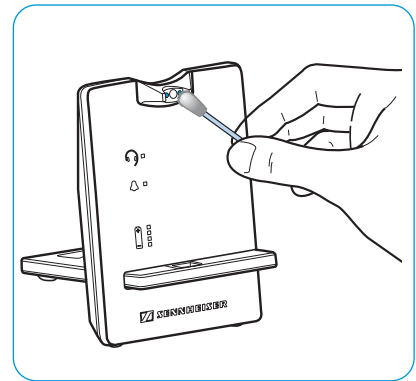
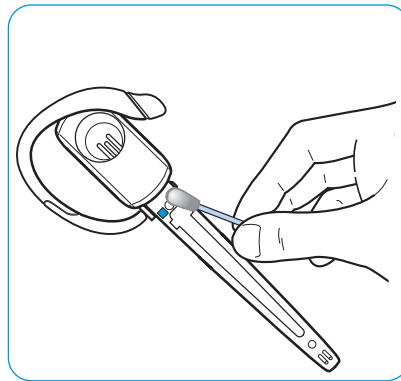

Replacing the ear pads

For reasons of hygiene, you should replace the ear pads from time to time. Spare ear pads are available from your Sennheiser partner.

- 1 Carefully remove the old ear pad from the ear cup. Make sure that the fastening ring of the old ear pad is also removed from the ear cup.
- 2 Pull the collar **B** of the ear pad over the notch **A** of the headband.
- 3 Turn the ear pad counter-clockwise over the notch until the collar completely surrounds the ear cup.

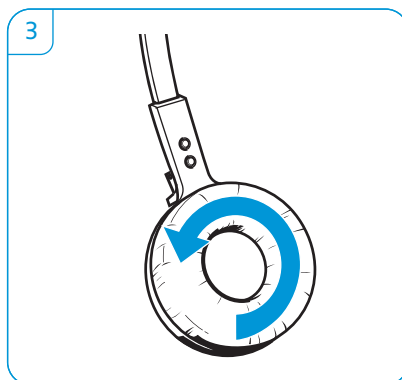
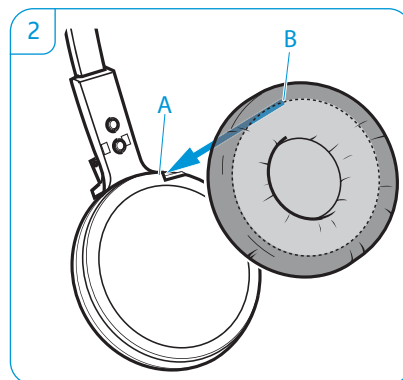
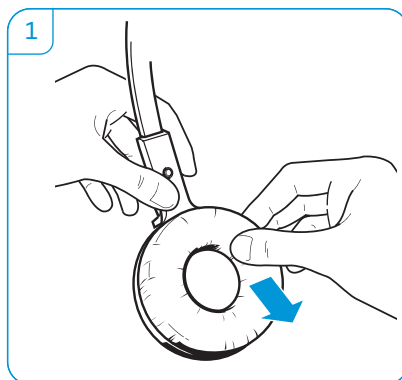

Replacing the headset's rechargeable battery

CAUTION

Damage to the product due to improper handling

The cables can be kinked or damaged if you open the battery compartment too jerkily.

- ▶ Carefully open the battery compartment and loosen the connector plug of the rechargeable battery.

Spare rechargeable batteries are available from your Sennheiser partner. Only use spare rechargeable batteries recommended by Sennheiser.

- 1 Remove the ear hook or the headband (see page 14) and open the battery compartment.

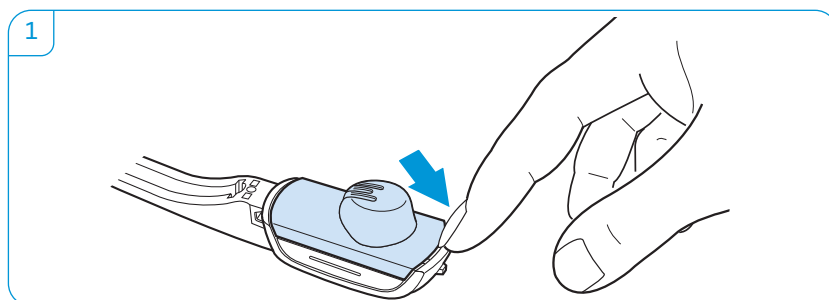

- 2 Carefully move the battery compartment cover in the direction of the arrow until you overcome a slight resistance. Remove the rechargeable battery and carefully loosen the connector plug of it.
- 3 Insert the connector plug of the new rechargeable battery into the connection socket. Observe correct orientation of the connector plug.
- 4 Close the battery compartment.

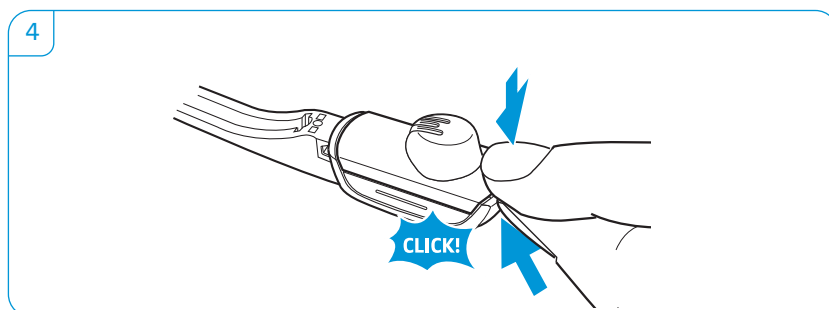
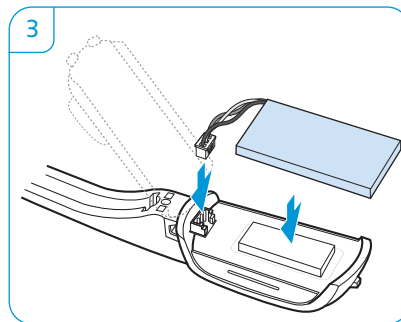
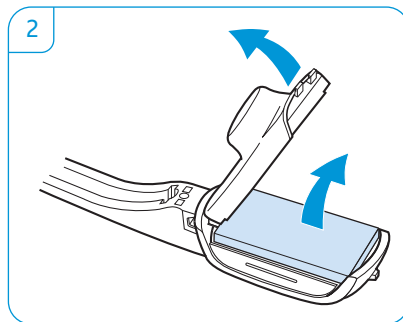

If a problem occurs

Problem	Possible cause	Possible solution	Page
The headset is placed into the base station but the Charge status LED is off	Base station is not connected to the mains power supply	Connect the base station to the mains power supply.	9
	Rechargeable battery is deep discharged	Wait several minutes until the Charge status LED lights up.	29
		For quick-charging the headset: Briefly press the Set button at the rear of the base station.	5
Link between headset and base station cannot be established	Headset is not paired with the base station, the Link LED  lights up red	Place the headset into the base station.	23
	Base station is only connected via the USB cable	Connect the base station to the mains power supply.	9
Bad radio link between headset and base station	Transmission range is exceeded	Reduce the distance between headset and base station.	–
		Adjust the radio range.	17
Noise interference and connection loss	Microphone rubs on the cheek or perhaps the beard	Bend the microphone boom so that the microphone is about 0.8 - 1.2" (2 - 3 cm) from the corner of your mouth.	14
		Reduce the radio range.	17
	Too many DECT systems within the radio range	Set the base station to narrowband transmission.	17
		Distance between base station and fixed line phone is so small that interference occurs	Increase the distance between base station and fixed line phone.
The rechargeable battery cannot be charged	Charging contacts of the headset or the base station are dirty	Clean the charging contacts on the headset and on the base station.	33
	Rechargeable battery is defective	Replace the defective rechargeable battery with a new one.	35
	Headset is not properly placed into the magnetic holder of the base station	Check if the headset is properly placed into the magnetic holder.	29
The rechargeable battery is quickly depleted even after charging	Overaged rechargeable battery	Replace the overaged rechargeable battery with a new one.	35
Bad audio quality, the other party sounds too low or too loud	Microphone sensitivity is not correctly adjusted	Adjust the microphone sensitivity.	19
The sound from the fixed line phone is distorted and disturbed	Base station is not adjusted to the fixed line phone.	Use the ABC switch to adjust the base station to your fixed line phone.	19

For more information and an FAQ list, please visit our website at www.sennheiser.com.

If a problem occurs that is not listed in the above table or if the problem cannot be solved with the proposed solutions, please contact your local Sennheiser partner for assistance.

To find a Sennheiser partner in your country, search at www.sennheiser.com under "Service & Support".

Specifications

Base station

D 10 BS USB/D 10 BS USB ML/D 10 BS Phone

Dimensions	88 x 119 x 100 mm (W x H x D)
Weight	
D 10 BS Phone	approx. 352 g
D 10 BS USB	approx. 328 g
Operating temperature range	+5 °C to +45 °C (+41 °F to +113 °F)
Storage temperature range	-20 °C to +70 °C (-4 °F to +158 °F)

Headset

D 10 HS

Dimensions	140 x 24 x 22 mm (W x H x D)
Weight	with ear hook: approx. 22 g with headband: approx. 45 g
Talk time	narrowband: up to 12 hours wideband: up to 8 hours
Charging time	50%: approx. 20 min 100%: approx. 1 hour
Range (environment dependent)	free line of sight: up to 180 m in office buildings: up to 55 m
Rechargeable battery (built-in)	Lithium Polymer 3.7 V; 215 mAh
Output power	EU/AUS: 24 dbm/250 mW USA/CAN: 20.4 dbm/100 mW
Speaker type	dynamic, neodymium magnet
Microphone type	electret microphone, noise canceling
Operating temperature range	+5 °C to +45 °C (+41 °F to +113 °F)
Storage temperature range	-20 °C to +70 °C (-4 °F to +158 °F)

Power supply unit – PSAA05E/K/S/A

Nominal input voltage	100 – 240 V~
Nominal input current	max. 0.2 A
Mains frequency	50 – 60 Hz
Nominal output voltage	5.9 V ---
Nominal output current	max. 850 mA
Operating temperature range	+5 °C to +45 °C (+41 °F to +113 °F)
Storage temperature range	-20 °C to +70 °C (-4 °F to +158 °F)
Relative humidity	operation: 20 to 85% storage: 20 to 95%
Weight	approx. 75 g

DECT

	EU, UK, AU: CAT IQ 1.0	US version: DECT 6.0
Frequency	1880 to 1900 MHz	1920 to 1930 MHz
SAR value of D 10 HS	Ear hook: 0.029W/kg Headband: 0.050 W/kg	0.048W/kg

In compliance with

Europe:	EMC	EN 301489-6
	Radio	EN 301406
	Safety	EN 60950-1
	SAR	EN 50360 ref EN 62209-1 (headset)

USA & Canada:
This product meets the safety requirements of CSA No. 231437



Canada:	IC: 2099A-D10BSPHONE (D 10 BS Phone-US, D 10 BS USB-US, D 10 BS USB ML-US) IC: 2099A-D10HS (D 10 HS)
USA:	FCC ID: DMOCBDDGG (D 10 BS Phone-US, D 10 BS USB-US, D 10 BS USB ML-US) FCC ID: DM OCDHDGG (D 10 HS)

Manufacturer Declarations

Warranty

Sennheiser Communications A/S gives a warranty of 24 months on this product. For the current warranty conditions, please visit our website at www.sennheiser.com or contact your Sennheiser partner.

In compliance with the following requirements



- WEEE Directive (2012/19/EU)

Please dispose of this product by taking it to your local collection point or recycling center for such equipment. This will help to protect the environment in which we all live.



- Battery Directive (2013/56/EU)

The product's built-in rechargeable batteries can be recycled. In order to protect the environment, please dispose of defective products with their rechargeable batteries as special waste or return them to your specialist dealer.

CE Conformity

CE 1321

- R&TTE Directive (1999/5/EC)
- EMC Directive (2014/30/EU)
- Low Voltage Directive (2014/35/EU)
- ErP Directive (2009/125/EC)
- RoHS Directive (2011/65/EU)

The declaration is available at www.sennheiser.com.

Before putting the product into operation, please observe the respective country-specific regulations!

Statement regarding FCC

FCC Declaration of Conformity (DoC)	
We,	 SENNHEISER Model No: D 10 BS Phone-US, D 10 BS USB-US, D 10 BS USB ML-US
	Sennheiser Electronic Corporation One Enterprise Drive • Old Lyme • CT 06371 • USA Tel: +1 (860) 434 9190, ext. 144 Fax: +1 (860) 434 1759
declare the above device comply with the requirements of Federal Communications Commission.	
This device complies with Part 15 of the FCC rules. Operation is subjected to the following two conditions:	
1) This device may not cause harmful interference, and 2) This device must accept any interference received, including interference that may cause undesired operation.	
Responsible Party: Greg Beebe	

This equipment has been tested and found to comply with the limits for a Class B digital device of the FCC Rules, pursuant to part 15 of the FCC Rules. These limits are designed to provide reasonable protection against harmful interference in a residential installation.

This equipment generates, uses and can radiate radio frequency energy and, if not installed and used in accordance with the instructions, may cause harmful interference to radio communications. However, there is no guarantee that interference will not occur in a particular installation. If this equipment does cause harmful interference to radio or television reception, which can be determined by turning the equipment off and on, the user is encouraged to try to correct the interference by one or more of the following measures:

- Reorient or relocate the receiving antenna.
- Increase the separation between the equipment and receiver.
- Connect the equipment into an outlet on a circuit different from that to which the receiver is connected.
- Consult the dealer or an experienced radio/TV technician for help.

Changes or modifications made to this equipment not expressly approved by Sennheiser electronic Corp. may void the FCC authorization to operate this equipment.

The headset D 10 HS complies with FCC RF radiation exposure limits for devices used by the general public. It has been tested for SAR and has complied with Industry Canada SAR limits for devices used by the general public.

Statement regarding Industry Canada

This device complies with RSS-213 Issue 2 of the Industry Canada Rules. Operation is subject to the following two conditions: (1) This device may not cause harmful interference, and (2) this device must accept any interference received, including interference that may cause undesired operation.

The headset D 10 HS complies with Industry Canada RF radiation exposure limits for devices used by the general public. It has been tested for SAR and has complied with Industry Canada SAR limits for devices used by the general public.

Trademarks

Sennheiser is a registered trademark of Sennheiser electronic GmbH & Co. KG. Other product and company names mentioned in this instruction manual may be the trademarks or registered trademarks of their respective owners.



Sennheiser Communications A/S
Industriparken 27, DK-2750 Ballerup, Denmark
www.sennheiser.com

Publ. 01/15, A02

Free Manuals Download Website

<http://myh66.com>

<http://usermanuals.us>

<http://www.somanuals.com>

<http://www.4manuals.cc>

<http://www.manual-lib.com>

<http://www.404manual.com>

<http://www.luxmanual.com>

<http://aubethermostatmanual.com>

Golf course search by state

<http://golfingnear.com>

Email search by domain

<http://emailbydomain.com>

Auto manuals search

<http://auto.somanuals.com>

TV manuals search

<http://tv.somanuals.com>