



INFLATABLE BOATS

Including the following Model Series:
Fish Hunter™, Super Caravelle, Caravelle,
Colossus™ and HUI

READ THE FOLLOWING INSTRUCTIONS AND WARNINGS TO AVOID DROWNING OR SERIOUS INJURY



WARNING:

- Not a life saving device.
- Not for use by children without adult supervision.
- Always wear an approved Personal Flotation Device (Life Preserver).
- Do not overload.
- Never tow from another boat or vehicle.
- Use only in water away from debris and obstructions.
- Do not use in high wind, strong currents, open water or dangerous tides.
- Be familiar with the area you intend to use the boat.
- Never allow diving into or from these boats.
- Never leave in or near water when not in use.
- Know and follow local water safety rules and boating regulations.
- Use only in protected waters.
- Do not use this product under the influence of alcohol or drugs.
- Do not over inflate.
- Follow inflation sequence on the product.

IMPORTANT INFORMATION

The warnings below relate to various situations. Please observe them.

CAUTION!

Denotes a imminent hazard which will result in severe injury if you do not comply with the instructions.

WARNING!

Reminds you of safety measures which must be observed. Also denotes unsafe practices which could result in personal injury or damage to the product or property, if you do not comply with the instructions.

CAUTION!

It is the owner's responsibility to make sure all users carefully read and follow the instructions for safe operation of this product. Observe all local and national laws. Always wear a Personal Flotation Device approved by the proper authorities. Please carefully observe the Capacity Plate information which is printed on the product.

WARNING!

These boats are not meant for towing because the extreme pressure of the water while towing can tear the eyelets and/or handles. These boats are not meant to be used in whitewater.

These boats are made of the highest quality materials and comply with NMMA (National Marine Manufacturers Association) regulations.

CAUTION!

Altering the construction of these boats could jeopardize the safety of the occupants and will void the limited warranty.

CAUTION!

Keep boat away from gasoline, battery acid, solvents, etc., as they can damage the boat.

INFLATION INSTRUCTIONS

⚠ CAUTION!

Do not over inflate. Pressurize product to "Inflation Pressure" stated in the chart for your specific product.

⚠ WARNING!

Never use a compressor, CO₂ or compressed air to inflate the boat. Do not let your boat come into contact with sharp, pointed objects.

To inflate using any Sevylor® QuickPump™ unit:

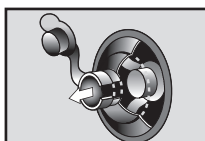

To begin inflation, open external stopper and pull to extend out.

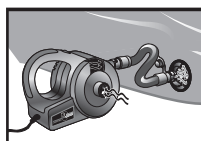

Attach adapter hose to inflation end of QuickPump™ unit. Insert hose and turn on.

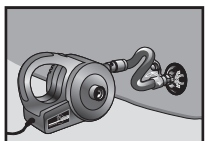

When fully inflated, seal valve by pushing in the pump nozzle to maintain seal. Gently back pump out of valve.



Fully remove adapter and close external stopper. Valve should appear depressed into itself.

To inflate using the Sevylor® Dual Action Hand Pump or other inflation device:

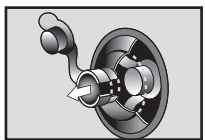

To begin inflation, open external stopper and pull to extend out.



Insert nozzle of inflation device into the extended valve and turn on or begin pumping.



To close valve: Push in with inflation device until stopper has been depressed, sealing internal stopper.

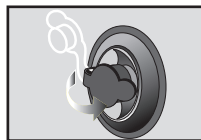

Fully remove adapter and close external stopper. Valve should appear depressed into itself.

IMPORTANT! Inflate the boat chambers in the following order:

1. Inflate the inside all-around safety chamber.
2. Inflate the floor chamber(s).
3. Inflate the bottom tunnel chambers. (These tubular chambers are only found on Super Caravelle and Fish Hunter™ models.)
4. Inflate the bustle chamber. (This support chamber positioned at the stern is found only on the large Super Caravelle models.)
5. Inflate the outside main chamber.

The chambers on the boat will be numbered to indicate order of inflation also. This order of inflation will ensure the proper volume and buoyancy of the safety chamber.

Note: To inflate the mini double lock valve, which is used on some of the Sevylor boat floors and seat bottoms, follow the same inflation instructions above, using the mini double lock valve adapter. The mini Double Lock™ valve adapter is included with all Sevylor® pumps. The adapter can be purchased from Customer Service by calling 1-800-835-3278 (Part Number 5010000707).

⚠ CAUTION!

Water temperature and weather does affect the pressure in inflatable products. In cold weather your product will lose some pressure due to the fact the air will contract. If this occurs, you may want to add a little air to improve your products performance. However, in hot weather, the air will expand. You must let some air out to prevent your product from failing due to overpressure. You should avoid exposing your product to extreme temperatures (hot or cold).

DEFLATION INSTRUCTIONS

Deflation instructions using any Sevylor® QuickPump™ unit:

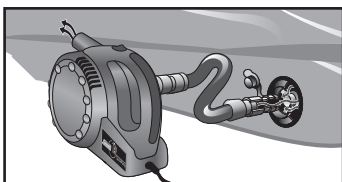

Remove adapter hose from inflation end and attach to opposite deflation end of pump. Repeat same steps as inflation. This will draw the air out quickly.

Deflation instructions using the Sevylor® Dual Action Hand Pump:

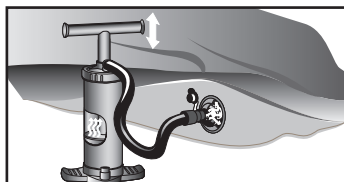

Remove adapter hose from inflation port and attach to deflation port on pump handle. Repeat same steps as inflation. This will draw the air out quickly.

Your boat is NMMA certified using the ABYC standard.



⚠ WARNING!

Do not exceed the certified maximum capacities under any circumstances!

NMMA (ABYC Standard)	Persons Capacity	Maximum Payload Capacity	Engine	Inflation Pressure	Inflation Pressure
Model #	Persons Only	Persons, Gear, Motor (if applicable)	Max. HP Engine	Main Chamber(s)	Floor Chamber(s)
HUI 100	1 Pers. or 190 lbs.	190 lbs.	N/A	0.4 PSI	0.4 PSI
HUI 200	2 Pers. or 370 lbs.	370 lbs.	N/A	0.4 PSI	0.4 PSI
HUI 400	4 Pers. or 650 lbs.	650 lbs.	N/A	0.4 PSI	0.4 PSI

⚠ WARNING!

Do not exceed the certified maximum capacities under any circumstances!

NMMA (ABYC Standard)	Persons Capacity	Maximum Payload Capacity	Engine	Inflation Pressure	Inflation Pressure
Model #	Persons Only	Persons, Gear, Motor (if applicable)	Max. HP Engine	Main Chamber(s)	Floor Chamber(s)
Colossus™ 2 Person Boat	2 Pers. or 435 lbs.	435 lbs.	N/A	0.5 PSI	0.5 PSI
Colossus™ 3 Person Boat	3 Pers. or 680 lbs.	680 lbs.	N/A	0.5 PSI	0.5 PSI
Colossus™ 4 Person Boat	4 Pers. or 840 lbs.	840 lbs.	N/A	0.5 PSI	0.5 PSI

⚠ WARNING!

Do not exceed the certified maximum capacities under any circumstances!

NMMA (ABYC Standard)	Persons Capacity	Maximum Payload Capacity	Engine	Inflation Pressure	Inflation Pressure
Model #	Persons Only	Persons, Gear, Motor (if applicable)	Max. HP Engine	Main Chamber(s)	Floor Chamber(s)
Caravelle 2 Person Boat	2 Pers. or 300 lbs.	360 lbs.	N/A	0.9 PSI	0.9 PSI
Caravelle 3 Person Boat	3 Pers. or 550 lbs.	600 lbs.	12V Electric Motor (Sevylor 2000004144)	0.9 PSI	0.9 PSI
Caravelle 4 Person Boat	4 Pers. or 600 lbs.	700 lbs.	3.0 *	0.9 PSI	0.9 PSI
Caravelle 5 Person Boat	5 Pers. or 800 lbs.	900 lbs.	3.0 *	0.9 PSI	0.9 PSI

* Requires 2000004146 Motor Mount Kit (sold separately) for motors other than Sevylor 12 Volt Motor, Model 2000004144

⚠ WARNING!

Do not exceed the certified maximum capacities under any circumstances!

NMMA (ABYC Standard)	Persons Capacity	Maximum Payload Capacity	Engine	Inflation Pressure	Inflation Pressure
Model #	Persons Only	Persons, Gear, Motor (if applicable)	Max. HP Engine	Main Chamber(s)	Floor Chamber(s)
Fish Hunter™ 3 Person Boat	3 Pers. or 450 lbs.	600 lbs.	2.0 *	0.9 PSI	0.9 PSI
Fish Hunter™ 4 Person Boat	4 Pers. or 650 lbs.	700 lbs.	4.0 *	0.9 PSI	0.9 PSI
Fish Hunter™ 6 Person Boat	6 Pers. or 900 lbs.	1200 lbs.	3.0 *	0.9 PSI	0.9 PSI
Fish Master™ 4 Person Boat	4 Pers. or 800 lbs.	900 lbs.	3.0 *	1.5 PSI	N / A

* Requires 2000004146 Motor Mount Kit (sold separately) for motors other than Sevyor 12 Volt Motor, Model 2000004144

⚠ WARNING!

Do not exceed the certified maximum capacities under any circumstances!

NMMA (ABYC Standard)	Persons Capacity	Maximum Payload Capacity	Engine	Inflation Pressure	Inflation Pressure
Model #	Persons Only	Persons, Gear, Motor (if applicable)	Max. HP Engine	Main Chamber(s)	Floor Chamber(s)
Super Caravelle 2 Person Boat	2 Pers. or 300 lbs.	360 lbs.	12V Electric Motor (Sevyor 2000004144)	0.9 PSI	0.9 PSI
Super Caravelle 3 Person Boat	3 Pers. or 550 lbs.	600 lbs.	2.0 *	0.9 PSI	0.9 PSI
Super Caravelle 4 Person Boat	4 Pers. or 600 lbs.	700 lbs.	3.5 *	0.9 PSI	0.9 PSI
Super Caravelle 6 Person Boat	6 Pers. or 900 lbs.	1,100 lbs.	3.5 *	0.9 PSI	0.9 PSI

* Requires 2000004146 Motor Mount Kit (sold separately) for motors other than Sevyor 12 Volt Motor, Model 2000004144

⚠ WARNING!

Do not attempt to mount a motor on any boat that does not state a Max. HP Engine rating.

SEVYTEST™ GAUGE

Some of the Sevylor® products are equipped with a Sevytest™ gauge. The Sevytest™ device is a pressure gauge, not an inflation gauge. The Sevytest™ gauge is found on the side wall, inside the main chamber(s). The purpose is to show you when to let some air out after the pressure has increased due to temperature change.

The principle of the Sevytest™ gauge is based on the lengthening of the PVC under the influence of pressure. Once the boat is properly inflated, note the position of the Sevytest™ indicator. Then periodically check the Sevytest™ gauge and let out enough air to keep the test strip in the same general area. If the Sevytest™ indicator is in the “+” zone, add pressure to the product. If the Sevytest™ indicator is in the “-” zone, release pressure from the product.

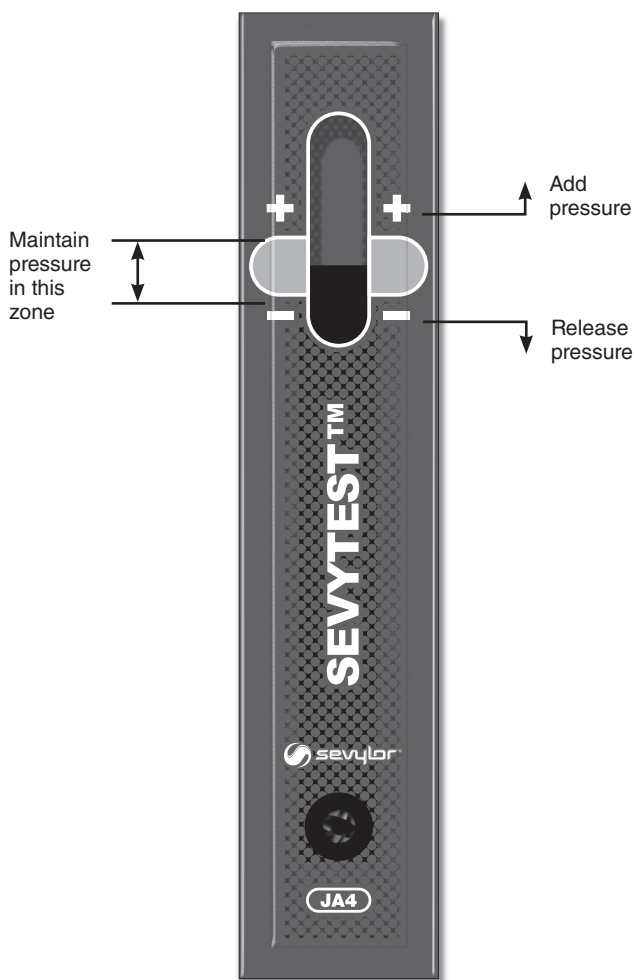

OPERATING INSTRUCTIONS:

- Follow all local boating regulations and navigation rules. Familiarize yourself with boating conditions where you plan to use the boat. Use common sense and caution when operating in unfamiliar places.
- Observe the maximum weight the boat can carry and do not overload past this limit. Over-loading jeopardizes the safety of the occupants.
- Be sure all accessories and/or equipment (e.g. oars, life jackets) are in proper working condition before using the boat. Each person occupying the boat is to wear an approved Personal Flotation Device (life preserver).
- Sharp objects are not to be carried in the boat without adequate protection or storage.
- When navigating the boat in any water depth, watch for submerged or sharp objects that may damage or pierce the boat's air chambers.
- Enter the boat from the port (left) or starboard (right) sides - not from the fore (front) or aft (back) sides.
- Never tow with a boat or any other vehicle.

MOTOR MOUNTING

⚠ WARNING!

Do not mount a motor on any boat that exceeds the Maximum Horsepower Rating for your specific boat model.

All Sevylor® boats that have a Horsepower Rating can accept the Sevylor® 12V Trolling Motor, Model 2000004144 without purchasing any additional mounting hardware. Refer to 12V Trolling Motor mounting instructions.

Mounting any motor other than the Sevylor® 12V Trolling Motor, Model 2000004144, requires the Sevylor® Motor Mount Kit, Model 2000004146, which is sold separately.

CARE & STORAGE:

- These boats are made of the highest quality materials and comply with NMMA (National Marine Manufacturers Association) regulations. Altering the construction of these boats will void the limited warranty and could jeopardize the safety of the occupants.
- If your boat has been used in salt water, rinse it off with fresh water as soon as possible.
- Remove tar spots or other soiled areas by using a mild soap and rinsing with fresh water.
- Be sure your boat is completely dry before storing.
- The boats may be stored inflated, but do not place any heavy or sharp objects on it. Storage is best in a dry room.

Caravelle Models

5 PERSON

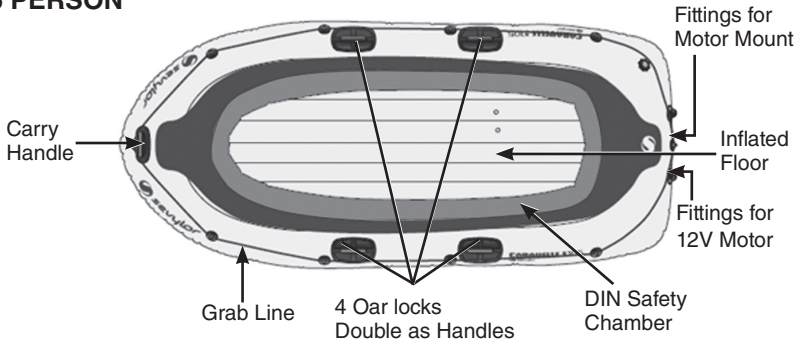

4 PERSON

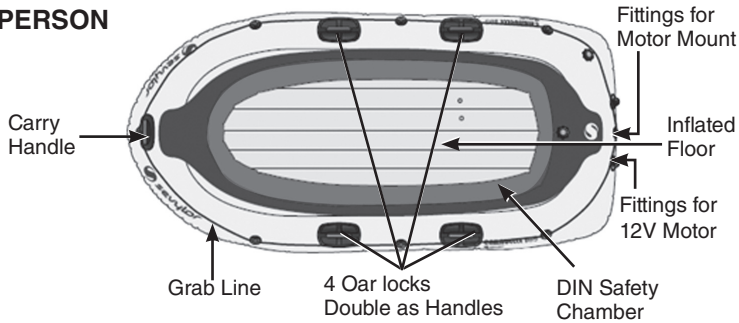

3 PERSON

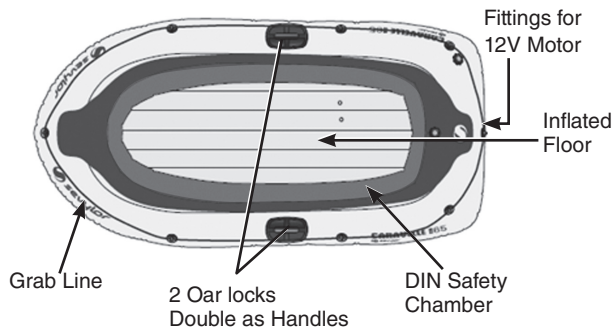

2 PERSON

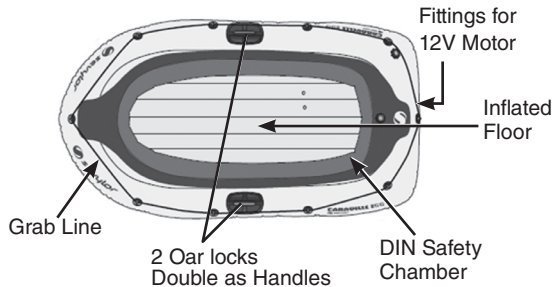

Super Caravelle Models

6 PERSON

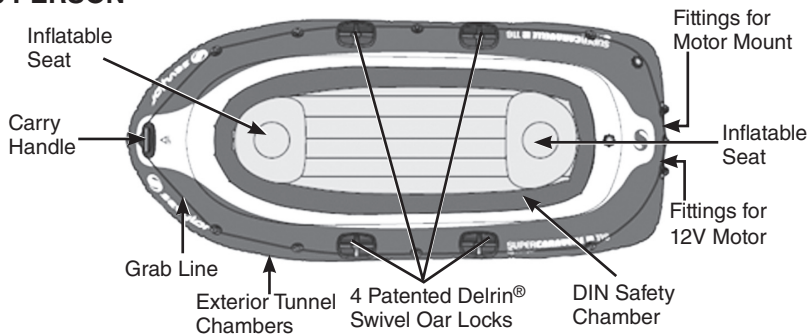

4 PERSON

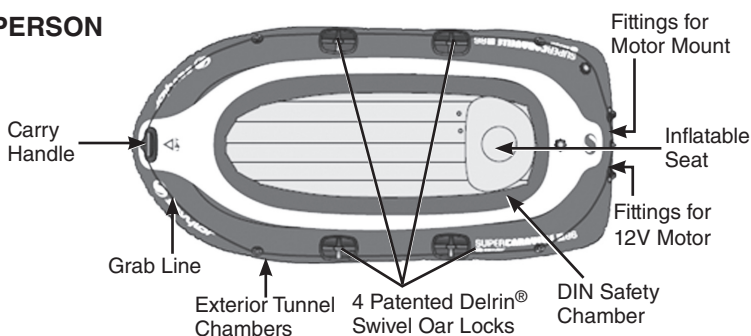

3 PERSON

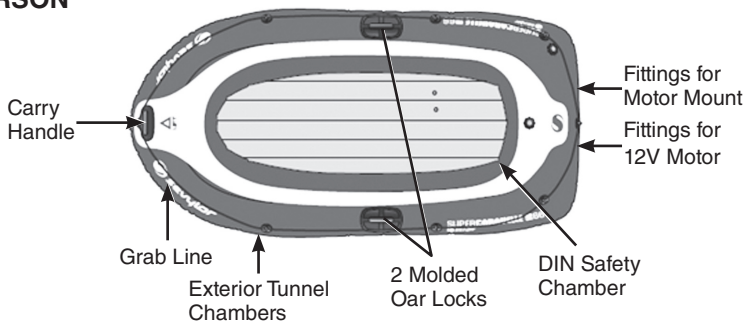

2 PERSON

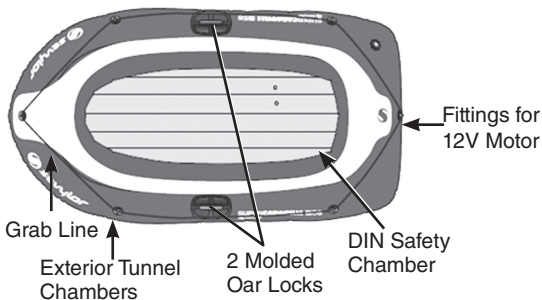

Colossus™ Models

4 PERSON

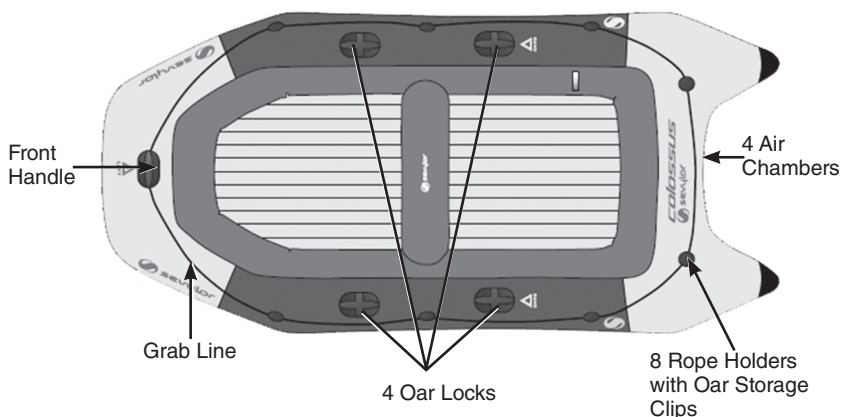

3 PERSON

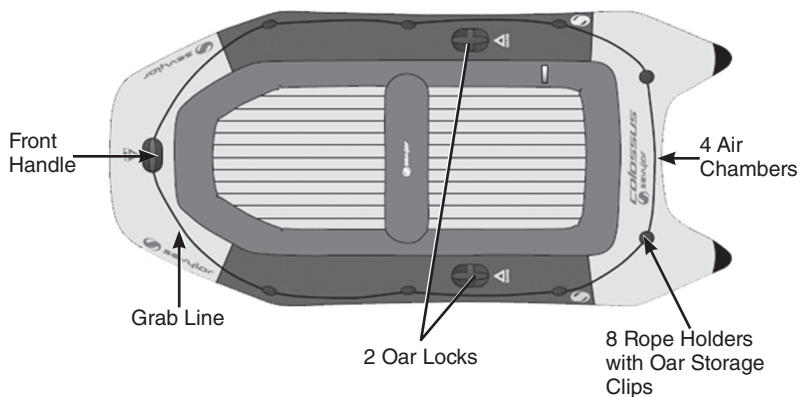

2 PERSON

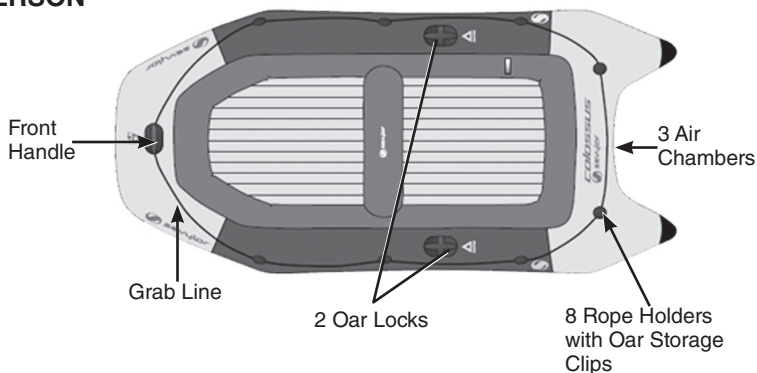

Fish Hunter™ Models

6 PERSON

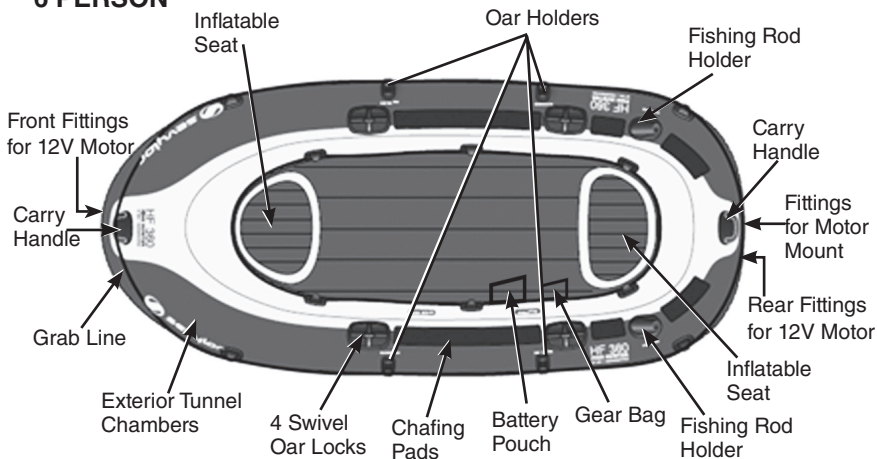

4 PERSON

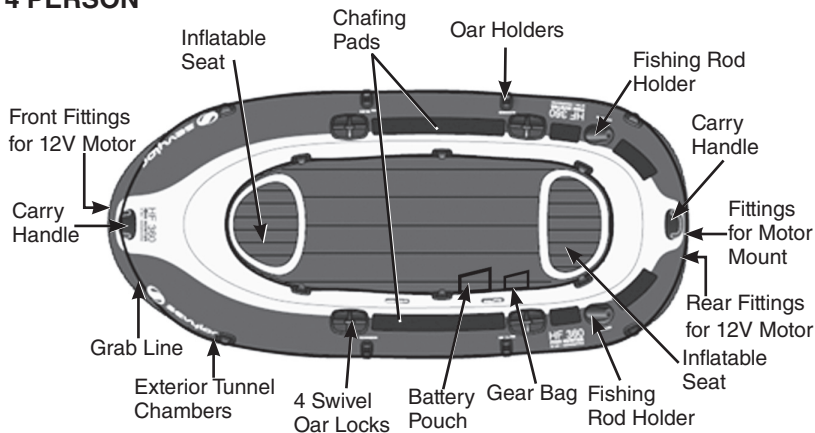

3 PERSON

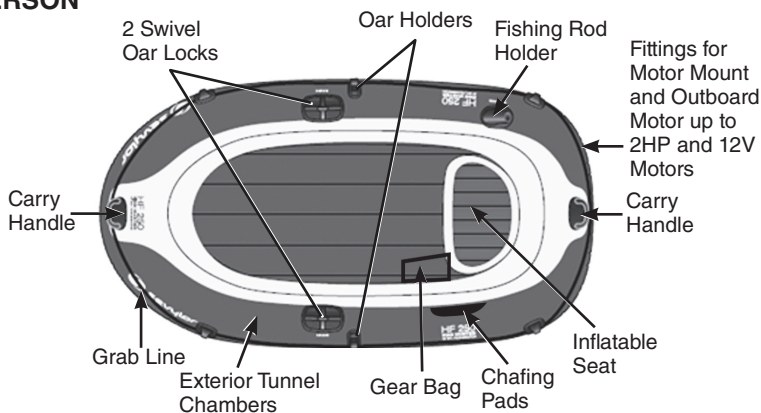

HUI Models

HUI 400

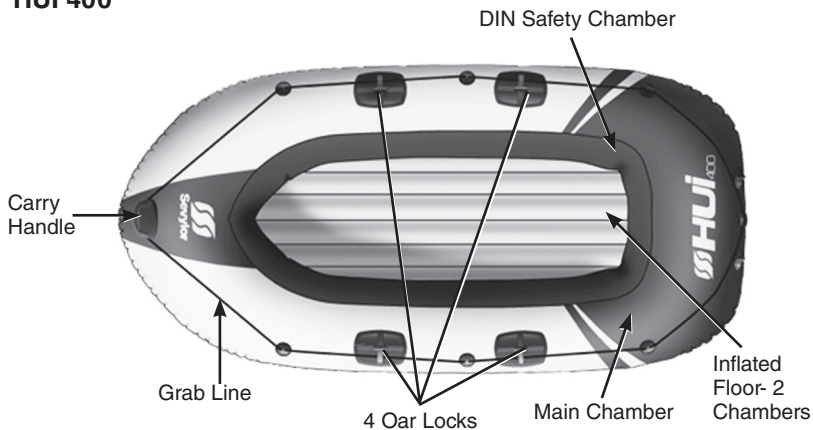

HUI 200

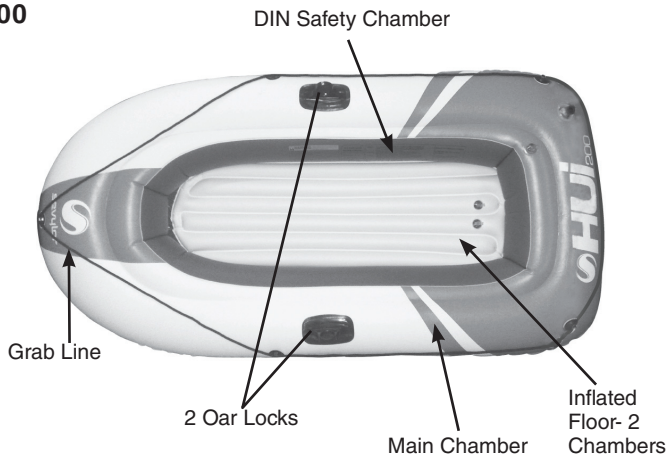

HUI 100

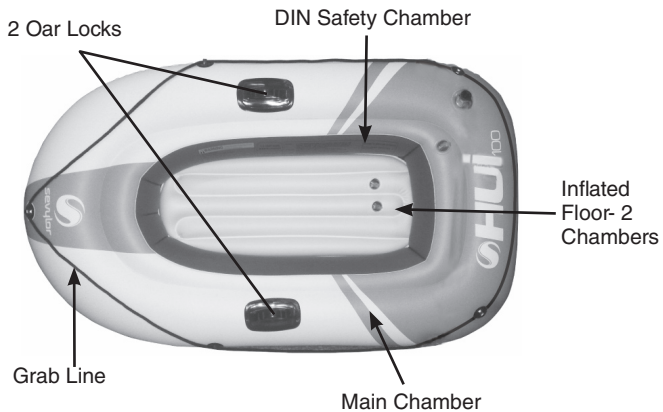

GRAB LINE INSTALLATION:

IMPORTANT: To properly install the inflatable boat's grab line, first inflate the boat. Feed the grab line through the eyelets on each of the rope holders. Then tie the two loose ends in a square knot at the rear of the boat.



Square Knot

OAR ASSEMBLY: (for models with oar included)

Join the two shafts together by screwing them together into the coupler. Attach the blade to the shafts by screwing in into the bottom of the shaft.

Replacement Part #2000004151

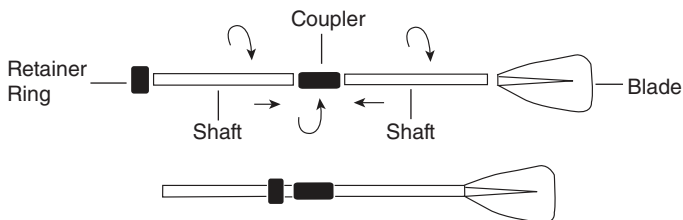

The assembled oar is to be inserted into the oar locks from the outside of the boat. The oar retainer ring is then placed onto the top half of the assembled oar, from the inside of the boat, to prevent the oar from sliding into the water (see below).

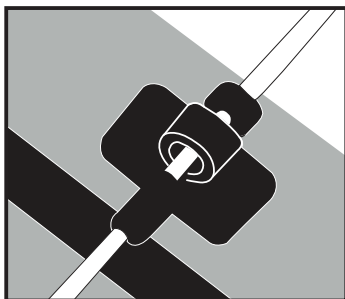

REPAIRING SMALL PUNCTURES

For inadvertent punctures, you can repair them with the included Sevylor® repair patch.

INSTRUCTIONS:

1. Thoroughly clean and dry the damaged area. Completely deflate if an inflatable article.
2. Cut a portion of the patch to cover the puncture, and allow an additional ¼" on all sides. Always cut a round or oval patch. Never leave corners.
3. Be sure the spot is completely dry.
4. Peel the backing from the patch.
5. Adhere the patch to the puncture.
6. Using your thumb or finger apply even pressure across the entire surface of the patch.

The Sevylor® AirSeal repair kit is also another repair option available (Model # 2000003730 - not included). Sevylor® AirSeal is a fast, reliable repair for vinyl inflatables: air mattresses, toys, pools, boats as well as rainwear, groundsheets, golf bags, etc.

INSTRUCTIONS:

1. Thoroughly clean and dry the damaged area. Completely deflate if an inflatable article.
2. When the damage is small (a pin hole or tear under 2 inches) apply a light coat of AirSeal two or three times. Allow five minutes to dry between each application.
3. For heavier material, e.g. fabric backed vinyl or a vinyl boat, apply up to five coats allowing a five-minute drying period between coats.
4. Ensure the AirSeal is completely dry before resuming use of the article.
5. When the damage is more extensive, cut a patch (with rounded corners) using any vinyl material. Generously coat the damaged area spreading the AirSeal at least 3/8" from the torn edges. Apply the patch and apply AirSeal to all edges of the patch making a seal between patch and the item being repaired. Allow the article to dry at least 10 hours before using.

Contains sufficient material for several small repairs.
AirSeal is intended for use with 100% PVC (poly vinyl chloride) only.

Do not use with any other material.

You may purchase the Sevylor® repair patch (Model # 2000003731) and Sevylor® AirSeal (Model # 2000003730) by calling Coleman Customer Service at 1-800-835-3278 or going to www.sevylor.com.

Limited 90 Day Warranty

The Coleman Company, Inc. ("Coleman") warrants that for a period of 90 days from the date of original retail purchase, this product will be free from defects in material and workmanship. Coleman, at its option, will repair or replace this product or any component of the product found to be defective during the warranty period. Replacement will be made with a new or remanufactured product or component. If the product is no longer available, replacement may be made with a similar product of equal or greater value. This is your exclusive warranty.

This warranty is valid for the original retail purchaser from the date of initial retail purchase and is not transferable. Keep the original sales receipt. Proof of purchase is required to obtain warranty performance. Coleman dealers, service centers, or retail stores selling Sevylor® products do not have the right to alter, modify or in any way change the terms and conditions of this warranty.

What This Warranty Does Not Cover

This warranty does not cover normal wear of parts, parts that are not genuine Coleman® parts, or damage resulting from any of the following: negligent use or misuse of the product; commercial use of the product; use contrary to the operating instructions; disassembly, repair or alteration by anyone other than Coleman or an authorized service center. Further, the warranty does not cover Acts of God, such as fire, flood, hurricanes and tornadoes. Warranty void if damage to the product results from the use of a part other than a genuine Sevylor® part.

COLEMAN SHALL NOT BE LIABLE FOR DEFECTS THAT ARE CAUSED BY THE USE OF UNAUTHORIZED PARTS OR SERVICE. COLEMAN SHALL NOT BE LIABLE FOR ANY INCIDENTAL OR CONSEQUENTIAL DAMAGES CAUSED BY THE BREACH OF ANY EXPRESS OR IMPLIED WARRANTY OR CONDITIONS. EXCEPT TO THE EXTENT PROHIBITED BY APPLICABLE LAW, ANY IMPLIED WARRANTY OF MERCHANTABILITY OR FITNESS FOR A PARTICULAR PURPOSE IS LIMITED IN DURATION TO THE DURATION OF THE ABOVE WARRANTY OR CONDITIONS. SOME STATES OR JURISDICTIONS DO NOT ALLOW THE EXCLUSION OR LIMITATION OF INCIDENTAL OR CONSEQUENTIAL DAMAGES OR LIMITATIONS ON HOW LONG AN IMPLIED WARRANTY LASTS, SO THE ABOVE LIMITATIONS OR EXCLUSION MAY NOT APPLY TO YOU. THIS WARRANTY GIVES YOU SPECIFIC LEGAL RIGHTS, AND YOU MAY ALSO HAVE OTHER RIGHTS THAT VARY FROM STATE TO STATE.

How to Obtain Warranty Service

Take the product to an authorized Coleman service center. You can find the nearest authorized Coleman service center by visiting www.coleman.com or calling 1-800-835-3278 or TDD 1-316-832-8707. If a service center is not conveniently located, attach to the product a tag that includes your name, address, daytime telephone number and description of the problem. Include a copy of the original sales receipt. Carefully package the product and send either by courier or insured mail with shipping and insurance prepaid to:

The Coleman Company, Inc.
3600 North Hydraulic
Wichita, KS 67219

The costs of transporting the product to Coleman or an authorized service center for warranty service is the responsibility of the purchaser.

DO NOT RETURN THIS PRODUCT TO THE PLACE OF PURCHASE.

If you have any questions regarding this warranty please call 1-800-835-3278 or TDD 1-316-832-8707.

© 2010 The Coleman Company, Inc. All rights reserved.

QuickPump™, Fish Hunter™, Double Lock™ and Colossus™ are trademarks of The Coleman Company, Inc. Sevylor® is a registered trademark and  is a trademark of Sevca, LLC.



3600 North Hydraulic • Wichita, KS 67219 U.S.A.
1-800-835-3278 • www.Sevylor.com

4010006024 (20100105)

Free Manuals Download Website

<http://myh66.com>

<http://usermanuals.us>

<http://www.somanuals.com>

<http://www.4manuals.cc>

<http://www.manual-lib.com>

<http://www.404manual.com>

<http://www.luxmanual.com>

<http://aubethermostatmanual.com>

Golf course search by state

<http://golfingnear.com>

Email search by domain

<http://emailbydomain.com>

Auto manuals search

<http://auto.somanuals.com>

TV manuals search

<http://tv.somanuals.com>