

Models
SV7729
SV7729N



ONE (1) YEAR LIMITED WARRANTY

EURO-PRO Operating LLC warrants this product to be free from defects in material and workmanship for a period of one (1) year from the date of the original purchase. This warranty applies only to normal domestic household use.

Should your appliance fail to operate properly while in use under normal household conditions within the one (1) year warranty period, return the complete appliance and accessories, freight prepaid to **EURO-PRO Operating LLC** at the address given below.

U.S. **EURO-PRO Operating LLC**, 94 Main Mill Street, Door 16, Plattsburgh, N.Y. 12901
Canada: **EURO-PRO Operating LLC**, 4400 Bois Franc, St. Laurent, H4S 1A7

If the appliance is found by **EURO-PRO Operating LLC** to be defective in material or workmanship, **EURO-PRO Operating LLC** will repair or replace it free of charge. Proof of purchase date and \$ 5.95 to cover the cost of return shipping and handling must be included. * Non-durable parts including, without limitation, dust cup filters, brushes and electrical parts which normally require replacement are specifically excluded from warranty.

The liability of **EURO-PRO Operating LLC** is limited solely to the cost of the repair or replacement of the unit at our option. This warranty does not cover normal wear of parts and does not apply to any unit that has been tampered with or used for commercial purposes. This limited warranty does not cover damage caused by misuse, abuse, negligent handling or damage due to faulty packaging or mishandling in transit. This warranty does not cover damage or defects caused by or resulting from damages from shipping or repairs, service or alterations to the product or any of its parts, which have been performed by a repair person not authorized by **EURO-PRO Operating LLC**.

This warranty is extended to the original purchaser of the unit and excludes all other legal and/or conventional warranties. The responsibility of **EURO-PRO Operating LLC** if any, is limited to the specific obligations expressly assumed by it under the terms of the limited warranty. **In no event is EURO-PRO Operating LLC** liable for incidental or consequential damages of any nature whatsoever. Some states/provinces do not permit the exclusion or limitation of incidental or consequential damages, so the above may not apply to you.

This warranty gives you specific legal rights, and you may also have other rights which vary from state to state or province to province.

***Important: Carefully pack item to avoid damage in shipping. Be sure to include proof of purchase date and to attach tag to item before packing with your name, complete address and phone number with a note giving purchase information, model number and what you believe is the problem with item. We recommend you insure the package (as damage in shipping is not covered by your warranty). Mark the outside of your package "ATTENTION CUSTOMER SERVICE". We are constantly striving to improve our products, therefore the specifications contained herein are subject to change without notice.**



**OWNERSHIP REGISTRATION CARD
FOR CANADIAN CONSUMERS ONLY**

Please fill out and mail the product registration card within ten (10) days of purchase. The registration will enable us to contact you in the unlikely event of a product safety notification. By returning this card you acknowledge to have read and understood the instructions for use, and warnings set forth in the accompanying instructions.

**RETURN TO: EURO-PRO Operating LLC, 4400 Bois Franc, St. Laurent, QC H4S 1A7
SV7729 – SV7729N**

Appliance model			
Date purchased		Name of store	
Owner's name			
Address	City	Province	Zip Code

Printed in China



Cordless 14.4 V Hand Vac

OWNER'S MANUAL

**Models/Modelos/Modèles: SV7729, SV7729N
14.4 V DC / 14.4 V CC**



EURO-PRO Operating LLC

U.S.: 94 Main Mill Street, Door 16
Plattsburgh, NY 12901

Canada: 4400 Bois-Franc
St-Laurent, QC H4S 1A7

Tel. : 1 (800) 798-7398
www.sharkvac.com



IMPORTANT SAFEGUARDS

When using an electrical appliance, basic safety precautions should always be observed, including the following

READ ALL INSTRUCTIONS BEFORE USING YOUR CORDLESS HAND VACUUM.

WARNING: To reduce the risk of fire, electrical shock, or injury:

1. **Do not** charge this unit outdoors.
2. **Do not** use outdoors or on wet surfaces.
3. **Do not** allow to be used as a toy. Close attention is necessary when used by or near children.
4. Use only as described in this manual. Use only manufacturer's recommended attachments.
5. **Do not** use charger if power cord has been damaged. Do not use cordless hand vacuum or charger if it has been dropped, damaged, left outdoors, or dropped in water. Return it to **EURO-PRO Operating LLC** for examination, repair or adjustment.
6. **Do not** abuse the charger cord. Never carry the charger by the cord or yank to disconnect from an outlet; instead grasp the plug and pull to disconnect.
7. Keep charger cord away from heated surfaces.
8. This product includes rechargeable nickel cadmium batteries. Batteries must be recycled or disposed of properly. **Do not incinerate batteries or expose to high temperatures**, as they may explode.
9. **Do not** handle plug or appliance with wet hands.
10. **Do not** put any object into openings. Do not use with any opening blocked; keep free of dust, lint, hair and anything that may reduce air flow.
11. Keep hair, loose clothing, fingers, and all parts of body away from openings and moving parts.
12. **Do not** pick up anything that is burning or smoking, such as cigarettes, matches, or hot ashes.
13. **Do not** attempt to change accessories while unit is running.
14. Use extra care when cleaning on stairs.
15. **Do not** use to pick up flammable or combustible liquids such as gasoline or use in areas where they may be present.
16. Look on your hand vacuum and follow all label and marking instructions.
17. **Do not** use charger with an extension cord. Plug charger directly into an electrical outlet. Use charger only in a standard (120V., 60Hz) electrical outlet.
18. **Do not use the hand vacuum cleaner without dust cup filter in place.**
19. Store the cordless vacuum indoors. Put the cordless vacuum away after use to prevent accidents.
20. Leaks from battery cells can occur under extreme conditions. If the liquid, which is 20-35% solution of potassium hydroxide, gets on the skin - wash immediately with soap and water or neutralize with a mild acid such as lemon juice or vinegar. If the liquid gets into the eyes, flush them immediately with clean water for a minimum of 10 minutes and seek medical attention.
21. Use only on dry, indoor surfaces.
22. **Do not** use for any purpose other than described in this user's guide.
23. **Do not** attempt to use the charger with any other product nor attempt to charge this product with another charger. **Use only the charger model AD-1820-UL supplied with this appliance.**
24. The appliance must be disconnected from the supply when removing the battery.
25. "Ni-Cd" battery must be recycled or disposed of properly.

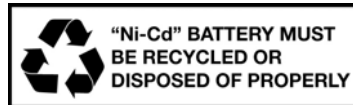

SAVE THESE INSTRUCTIONS

For Household Use Only

OPERATING INSTRUCTIONS

TROUBLESHOOTING GUIDE

PROBLEM	POSSIBLE REASON	POSSIBLE SOLUTION
HAND VACUUM WILL NOT OPERATE	<ol style="list-style-type: none"> 1. Batteries discharged. 2. No power in electrical outlet supplying transformer. 	<ol style="list-style-type: none"> 1. Charge unit. 2. Check fuse or breaker. Replace fuse/reset breaker.
HAND VACUUM WILL NOT PICK-UP OR SUCTION POWER IS WEAK	<ol style="list-style-type: none"> 1. Dust cup container is full. 2. Dust cup filter needs cleaning or replacement. 3. Unit needs recharging. 	<ol style="list-style-type: none"> 1. Empty dust cup container 2. Remove dust cup filter and check for object(s) in air duct and remove. Clean or replace dust cup filter. 3. Charge unit.
DUST ESCAPING FROM HAND VACUUM	<ol style="list-style-type: none"> 1. Dust cup container is full. 2. Dust cup filter is not installed correctly. 3. Puncture/hole in dust cup filter. 	<ol style="list-style-type: none"> 1. Empty dust cup container. 2. Review dust cup filter installation instructions. 3. Replace dust cup filter.

REPLACEMENT PARTS FOR MODELS SV7729 – SV7729N

To order replacement batteries or filters call customer service:

Tel.: 1 (800) 798-7398

Monday to Friday 8:30 A.M. - 5:00 P.M. Eastern Standard Time

or

visit our website: www.sharkvac.com

For technical support call customer service:

Tel.: 1 (800) 798-7398

Monday to Friday 8:30 A.M. - 5:00 P.M. Eastern Standard Time

Please Note

The Dust Cup Filter is washable. It should, however, be replaced every three (3) months to ensure peak performance of your vacuum.

Important

Make sure that Dust Cup Filter has completely air dried before re-installing back in the hand vacuum.

OPERATING INSTRUCTIONS

Assembly

Note: Dust cup filter must always be used when operating the hand vacuum.

1. To open the dust cup compartment, push the dust cup release button and remove the dust cup container. (Fig. 2)

Dust Cup Release Button

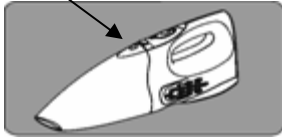

Fig. 2

2. Verify that the dust cup filter is inside, then re-attach the dust cup container to the hand vacuum. (Fig. 3)



Fig. 3

3. To attach the crevice tool or the dusting brush to the hand vacuum, push the attachment into the suction hole in the front of the dust container. (Fig. 4 & Fig. 5)

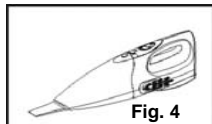

Fig. 4

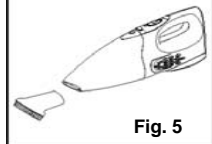

Fig. 5

CAUTION: The suction inlet must be open and free of any obstructions at all times. Otherwise, the motor will overheat and could become damaged.

Using Your Cordless Vacuum

1. Unplug unit from charger.
2. To start the unit, slide the "On/Off" switch to the "On" position.
3. To stop the vacuum cleaner, slide the "On/Off" switch to the "Off" position.
4. A crevice tool is provided for cleaning narrow, hard to reach places. A dusting brush is provided for cleaning upholstery, furniture, etc.

Changing & Cleaning the Dust Cup Filter

To achieve the best performance, empty the dust cup container and clean the dust cup filter after each use.

1. To remove the dust cup container, press down on the dust cup release button and pull off the dust cup container.
2. Pull out the dust cup filter.
3. Empty the dust from the dust cup container. (Fig. 6)

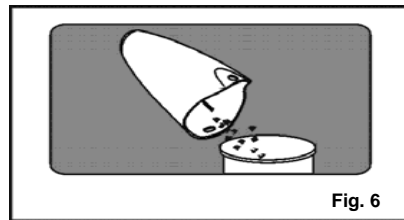

Fig. 6

4. Rinse the dust cup filter in cold water, and then wait until it dries completely before replacing it back into the dust cup container. Do **not** use a washing machine to clean the dust cup filter. Do not use a hair dryer to dry it. **Air dry only.**
5. Replace the dust cup filter carefully into the dust cup compartment. **NEVER** operate vacuum cleaner without dust cup filter in place.
6. Attach the dust cup container to the cordless vacuum.

Note: It is recommended that the dust cup filter be replaced every three (3) months to ensure peak performance of the unit.

PARTS AND COMPONENTS

1. Dust Cup Container
2. Dust Cup Filter
3. Dust Cup Release Switch
4. Charging Indicator
5. On/Off Switch
6. Main Unit
7. Charging Adapter
8. Crevice Tool
9. Dusting Brush

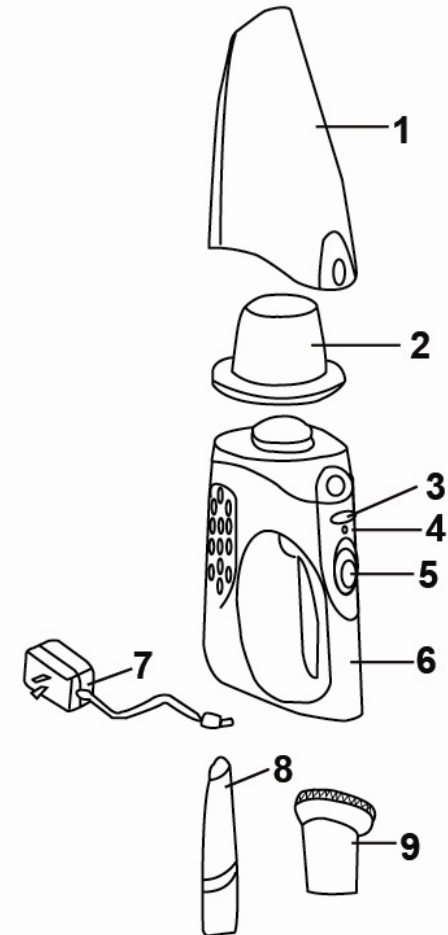

NOTE: Your cordless vacuum is shipped with the batteries uncharged. Charging of the unit for 20 hours prior to first use is required.

Before Use

1. This cordless hand vacuum is powered by rechargeable nickel-cadmium batteries. Before using the vacuum, charge the vacuum cleaner for a minimum of 20 hours.

Note: Ensure that the On/Off switch is in the "Off" position before charging.

Note: Peak performance may only be realized after the unit has been charged and discharged two (2) or three (3) times.

IMPORTANT: To maintain peak performance of your cordless hand vacuum, it is recommended that the unit be fully discharged, then completely re-charged at least once a month.

Charging Your Vacuum Cleaner

1. Place the vacuum cleaner and charging adapter near an electrical power outlet (120 V., 60 Hz.) and plug in the charging adapter's jack into the vacuum.
2. Plug the charger into wall outlet.
3. The charging indicator light will shine red to indicate that the charging jack is properly inserted into the charging receptacle at the rear of the unit and that the unit is being charged. (Fig. 1)

Note: Ensure that the On/Off switch is in the "Off" position before charging.

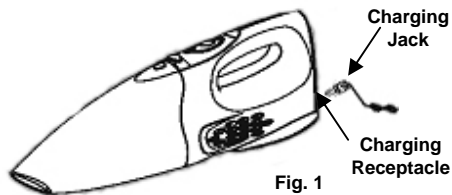

4. The normal full charging time for this vacuum is 20 hours. The vacuum cleaner will run for maximum operational time only if it has been fully charged. To fully charge the unit, run the vacuum cleaner until it stops, then fully recharge the battery.

To Maximize the Life of your Ni-Cd Batteries

1. Charge for a minimum of 20 hours before initial use. Failure to do so will reduce the product's battery life significantly.
2. Do not store the unit with the charging adaptor attached and plugged in.
3. Only recharge when the batteries are fully discharged (or as close to fully discharged as possible).
4. Do not store in areas of high temperature or humidity.
5. Fully discharge, then completely re-charge the unit at least once a month.
6. After three (3) months of storage, the product should be fully discharged and then recharged to maximize battery power.
7. Use only the charger supplied with the product. If other chargers are used, the batteries can fail causing damage to the battery, product or personal property.
8. Ni-Cd batteries have a long useful life but at some time they will need to be replaced. To purchase replacement batteries visit www.sharkvac.com.

Note:

1. The on/off switch must be in the "OFF" position in order to charge the unit. If the charging indicator does not light, depress the on/off switch once.
2. If the product has never been used or has been stored for an extended period of time without use – it will take several complete charge and discharge cycles to realize the full operational time of your product.

Battery Pack Replacement & Disposal

WARNING: NEVER use ordinary batteries for replacement, as these may leak and damage your vacuum cleaner. Use only battery pack XB7729 provided by **EURO-PRO Operating LLC** for replacement.

This vacuum cleaner contains a nickel-cadmium (Ni-Cd) batteries, which must be recycled or disposed of properly in accordance with state, federal and local laws. Call your nearest recycling center for information on the recycling and disposal of nickel-cadmium (Ni-Cd) batteries.

If uncertain as to how to remove the battery pack, we suggest you take your wet/dry hand vacuum to a reputable small appliance service technician to have this service preformed.

The battery pack of your SV7729 is replaceable, however care should be taken when doing so. Follow these steps when replacement is required:

1. Open the battery pack compartment by removing the single Phillips head screw located in the recess at the rear of the unit. NEVER open the battery compartment except to change the battery pack when required.
2. Remove battery compartment cover. Set aside battery compartment cover with the screw.
3. Carefully detach the two (2) electrical connectors from the battery pack by pulling straight out from the battery pack.
4. Lift out the battery pack and set aside.

5. Insert the new battery pack and re-connect the terminals by pushing lead wires onto battery tabs.
6. Tuck the wiring inside the battery compartment so that the wiring does not interfere with the battery compartment cover when it is replaced.
7. Re-install the battery compartment cover by sliding it over the battery towards the front of the unit, making sure that the front snap engages the body of the unit.
8. Replace the battery compartment cover screw.

CAUTION: NEVER use the unit without the battery compartment cover in place.

Note: Any other servicing should be performed by an authorized service representative.

CAUTION

- Use only with the battery pack supplied with the unit.
- Do not attempt to remove the battery pack from the unit to charge it.
- Never attempt to throw the battery pack or unit into a fire or incinerate it.
- Do not attempt to remove or damage the battery casing.
- Battery must be recycled or disposed of properly at the end of it's service life.

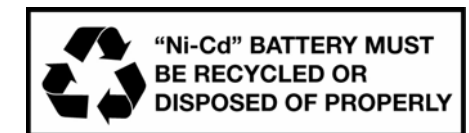

Free Manuals Download Website

<http://myh66.com>

<http://usermanuals.us>

<http://www.somanuals.com>

<http://www.4manuals.cc>

<http://www.manual-lib.com>

<http://www.404manual.com>

<http://www.luxmanual.com>

<http://aubethermostatmanual.com>

Golf course search by state

<http://golfingnear.com>

Email search by domain

<http://emailbydomain.com>

Auto manuals search

<http://auto.somanuals.com>

TV manuals search

<http://tv.somanuals.com>