

EURO-PRO X™

Shark™
SPECTRA
DELUXE

Upright Vacuum
Model UV204

Use and Care Instructions

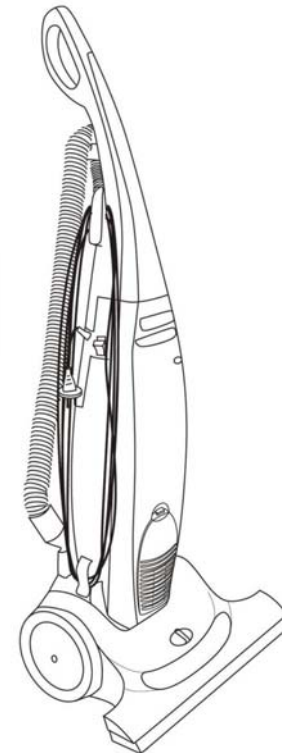

For information or assistance:
EURO-PRO Operating LLC
94 Main Mill Street, Door 16
Plattsburgh, NY 12901
www.sharkvac.com

ONE (1) YEAR LIMITED WARRANTY

EURO-PRO Operating LLC warrants this product to be free from defects in material and workmanship for a period of one (1) year from the date of the original purchase. This warranty applies only to normal domestic household use.

Should your appliance fail to operate properly while in use under normal household conditions within the one (1) year warranty period, return the complete appliance and accessories, freight prepaid to **EURO-PRO Operating LLC** at the address given below. If the appliance is found by **EURO-PRO Operating LLC** to be defective in material or workmanship, **EURO-PRO Operating LLC** will repair or replace it free of charge. Proof of purchase date and \$19.95 to cover the cost of return shipping and handling must be included. *

In US: **EURO-PRO Operating LLC**, 94 Main Mill Street, Door 16, Plattsburgh, N.Y. 12901

If the appliance is found to be defective in material or workmanship, **EURO-PRO Operating LLC** will repair or replace it free of charge. Include \$19.95 to cover the cost of return shipping and handling must be included. *

Non-durable parts including, without limitation, disposable dust bags, drive belts, rotating brushes and electrical parts which normally require replacement are specifically excluded from warranty.

The liability of **EURO-PRO Operating LLC** is limited solely to the cost of the repair or replacement of the unit at our option. This warranty does not cover normal wear of parts and does not apply to any unit that has been tampered with or used for commercial purposes. This limited warranty does not cover damage caused by misuse, abuse, negligent handling or damage due to faulty packaging or mishandling in transit. This warranty does not cover damage or defects caused by or resulting from damages from shipping or repairs, service or alterations to the product or any of its parts, which have been performed by a repair person not authorized by **EURO-PRO Operating LLC**.

This warranty is extended to the original purchaser of the unit and excludes all other legal and/or conventional warranties. The responsibility of **EURO-PRO Operating LLC** if any, is limited to the specific obligations expressly assumed by it under the terms of the limited warranty. **In no event is EURO-PRO Operating LLC** liable for incidental or consequential damages of any nature whatsoever. Some states do not permit the exclusion or limitation of incidental or consequential damages, so the above may not apply to you.

This warranty gives you specific legal rights, and you may also have other rights which vary from state to state.

***Important: Carefully pack item to avoid damage in shipping. Be sure to include proof of purchase date and to attach tag to item before packing with your name, complete address and phone number with a note giving purchase information, model number and what you believe is the problem with item. We recommend you insure the package (as damage in shipping is not covered by your warranty). Mark the outside of your package "ATTENTION CUSTOMER SERVICE". We are constantly striving to improve our products, therefore the specifications contained herein are subject to change without notice.**

Shark™

SPECTRA

Deluxe

Upright Vacuum

TO ORDER REPLACEMENT BAGS, FILTERS OR BELTS for Model UV204

Call: 1-866-98SHARK (1-866-987-4275)
Monday to Friday 8:30 A.M. - 5:00 P.M. Eastern Standard Time
or
visit our website: www.sharkvac.com

FOR TECHNICAL SUPPORT for Model UV204

Call: 1-800-798-7398
Monday to Friday 8:30 A.M. - 5:00 P.M. Eastern Standard Time

Please Note:

The Pre-Motor Filter is washable. It should however be replaced every three (3) months to ensure peak performance of your vacuum.

Important:

Make sure that the Filter is **completely** dry before inserting back in the vacuum.

Please Note:

The Cloth Bag is washable. It should however be replaced every three (3) months to ensure peak performance of your vacuum.

IMPORTANT SAFETY INSTRUCTIONS

When using your **SHARK Spectra Deluxe Upright**, basic safety precautions should always be observed, including the following:

- WARNING:** To reduce the risk of fire, electrical shock, or injury:
1. Do not leave vacuum cleaner unattended when it is plugged in. Unplug from outlet when not in use and before filters.
 2. To reduce the risk of electric shock – do not use outdoors or on wet surfaces.
 3. Do not allow children to use as a toy. Close attention is necessary when used by or near children.
 4. Use only as described in this manual. Use only manufacturer's recommended attachments.
 5. Do not use with damaged cord or plug. Do not use vacuum cleaner if it has been dropped, damaged, left outdoors, or dropped into water. Return appliance to **EURO-PRO Operating LLC** for examination, repair or adjustment.
 6. Do not pull or carry by cord. Do not use cord as a handle, close a door on cord, or pull cord around sharp edges or corners. Do not run appliance over cord. Keep cord away from heated surfaces.
 7. Do not unplug by pulling on cord. To unplug, grasp the plug, not the cord.
 8. Do not handle plug or vacuum cleaner with wet hands. Do not use outdoors or on wet surfaces.
 9. Do not put any objects into openings. Do not use with any opening blocked and do not restrict airflow. Keep all openings free of dust, lint, hair, and anything that may reduce airflow.
 10. Keep hair, loose clothing, fingers, feet and all parts of body away from openings, rotating agitator and other moving parts. Do not operate cleaner in bare feet or when wearing open toe shoes.
 11. Do not pick up hot coals, cigarette butts, matches or any hot, smoking, or burning objects.
 12. Do not pick up hard or sharp objects such as glass, nails, screws, coins, etc.
 13. Do not use without filters in place. Use **ONLY** filters and accessories provided by **SHARK**. Failure to do so will void the warranty.
 14. Turn off all controls before plugging or unplugging vacuum cleaner.
 15. Use extra care when vacuuming on stairs.
 16. Do not pick up flammable or combustible materials (lighter fluid, gasoline, kerosene, etc.) or use in the presence of explosive liquids or vapor.
 17. Do not pick up toxic material (chlorine bleach, ammonia, drain cleaner, etc.).
 18. Do not use in an enclosed space filled with vapors given off by oil based paints, paint thinner, moth proofing substances, flammable dust, or other explosive or toxic vapors.
 19. Always unplug this appliance before connecting or disconnecting vacuum hose.
 20. Use only on dry, indoor surfaces.
 21. Do not use for any purpose other than described in this user's guide.
 22. The use of an extension cord is not recommended.
 23. **Do not** put any objects into openings. Do not use with any opening blocked. Keep free of dust, lint, hair and anything else that may reduce air flow.
 24. Store your appliance indoors in a cool, dry area.
 25. Keep your work area well lit.
 26. **Do not** immerse the vacuum into water or other liquids.
 27. Keep end of hose, wands and other openings away from your face and body.

SAVE THESE INSTRUCTIONS For Household Use Only

WARNING: To reduce the risk of electric shock, this appliance has a polarized plug (one blade is wider than the other). This plug will fit in a polarized outlet only one way. If the plug does not fit fully in the outlet, reverse the plug. If it still does not fit, contact a qualified electrician to install the proper outlet. Do not modify the plug in any way.

Deluxe
Upright Vacuum

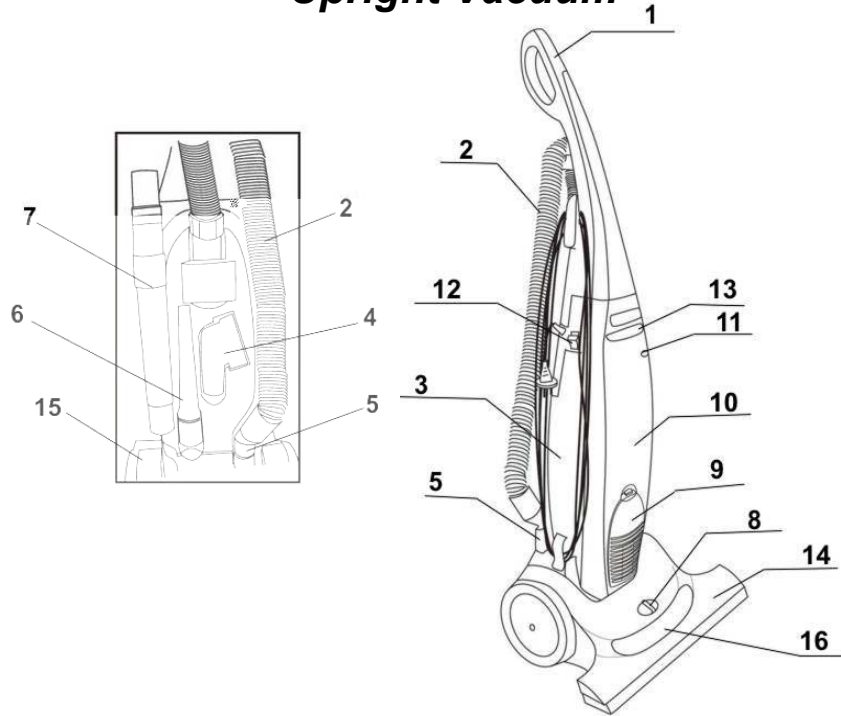

- | | |
|----------------------------------|--------------------------|
| 1. Upper Handle | 9. HEPA Filter Cover |
| 2. Flexible Hose | 10. Front Panel |
| 3. Main Body | 11. Full Bag Indicator |
| 4. Dusting Brush | 12. On/Off Switch |
| 5. Hose Connector | 13. Lock Plate |
| 6. Crevice Nozzle | 14. Motorized Power Head |
| 7. Nested Extension Tubes (2) | 15. Handle Release |
| 8. Carpet Height Adjustment Knob | 16. Head Light |

Technical Specifications

Voltage: 120V., 60Hz.
Power: 12 Amps

5. Changing the Power Nozzle Belt:

- A) Occasionally the power nozzle drive belt will require changing, the frequency will depend upon the amount of use your vacuum sees.
- B) Turn unit "Off" and unplug from wall outlet.
- C) Use a Phillips screwdriver and remove the two screws from the back of the motorized power head cover.
- D) Remove the two screws from the bottom of the motorized power head.
- E) If the belt has broken, remove any loose pieces before replacing.
- F) Grasp the beater bar at either end and lift straight up.
- G) Place one end of new belt over motor shaft and the other on the round pulley end of the beater bar.
- H) Align the rubber supports at the ends of the beater bar, with the slots in the motorized power head. Push into place. Ensure that the cut-outs on the rubber supports face upwards.
- I) Replace the two screws from the bottom of the motorized power head and then replace the cover. Then replace the two screws from the back side of the motorized power head.

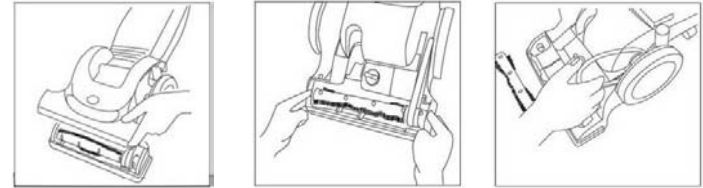

6. Changing the Head Light Bulbs:

Warning: Always disconnect from power source when servicing or cleaning the unit. Failure to do so could result in electrical shock or personal injury from cleaner suddenly starting.

1. Turn unit "Off" and unplug from wall outlet.
2. With a Phillips #2 screw driver, remove the two screws that are on the head light lens.
3. Lift off the head light lens.
4. Remove the light bulbs by pulling them out carefully.
5. Replace the new bulbs by pushing them in.
6. Replace the head light lens and then replace the two screws on the head light lens to secure in place.

Note: Always replace the light bulb with the same or smaller wattage size (12V 4W) to prevent damage to the surrounding parts.

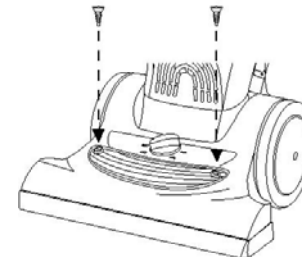

3. Changing & Cleaning the Pre-Motor Filter:

- A) This is best done every three months or depending on the amount of usage.
- B) Remove the front panel of the vacuum cleaner.
- C) To remove the pre-motor filter, simply slide it out.
- D) To clean the filter rinse in warm, soapy water. Filter must be completely dry before re-installing into your vacuum.
- E) Once filter has been replaced, replace front panel.

Assembling Your Vacuum Cleaner

Warning: Do not plug in vacuum unit until it is fully assembled.

- 1. Carefully unpack all components, set aside packaging.
- 2. Lift vacuum body to upright position.
- 3. Remove the screws (2) that are already attached to the body.
- 4. From the rear of the vacuum, align the handle with groove

Using the Vacuum with the Attachments

1. Place vacuum in its upright position.
2. Make sure that the vacuum cleaner is **NOT** plugged into the electrical outlet.
3. Turn the carpet adjustment knob to the high pile position.
4. Pull the hose connector from the rear of the vacuum and push the desired attachment firmly onto the end of the hose.
5. If additional length is required, attach one or both of the extension tube to the end of the hose and then attach the crevice nozzle or dusting brush to the end of the extension tube.

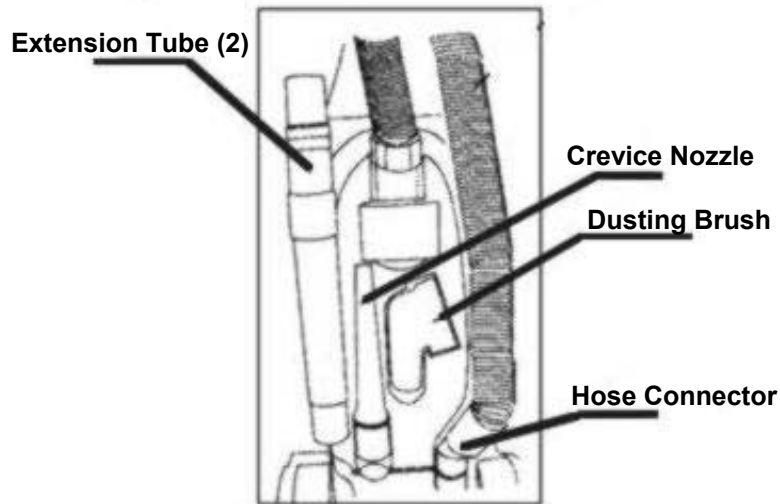

WARNING: When the vacuum is turned on, the beater brush will continue to rotate. Avoid tipping the vacuum or setting it on furniture, fringed area rugs or carpeted stairs while you are using the hose with the attachments. Avoid leaving the vacuum in one place for an extended period of time, particularly on thick carpet.

IMPORTANT: If the bag is not inserted correctly into the housing, the cover will not close. Please make sure that the bag is inserted all the way in until the latch catches otherwise front cover will not close.

Maintenance & Care

For best cleaning results, the dust bag should be changed often. The use of powder carpet fresheners can decrease the effectiveness of the dust bag filtering system by clogging the bag and not allowing air to flow through properly. We recommend that hard objects, pins, broken glass, paper clips, etc. be picked up from the floor before vacuuming. Although, your vacuum will pick them up, they could do severe damage to the vacuum. Use genuine **SHARK** dust bags, belts and filters only, to insure top performance from your vacuum.

1. Changing the Dust Bag:

Your vacuum comes with both paper bags and a reusable cloth bag. To change bags:

- A) Unplug power cord from wall outlet.
- B) Remove the front panel of the unit.
- C) Remove the old dust bag by holding the cardboard tab and pull towards you. Remove carefully to avoid dust/dirt spilling from dust bag.
- D) Take a new dust bag and while holding the cardboard tab push the bag over the opening of the dirt discharge tube until it is seated against the rear of the enclosure.
- E) Make sure that the entire bag is correctly inserted inside the housing, before replacing the front panel. Always check the pre-motor and post motor filters every time you change the dust bag.
- F) Once the new dust bag is in place, replace the front panel by aligning the bottom locking tabs with the slots in the body, close cover slowly allowing the front panel to snap in place. The latch will self lock.

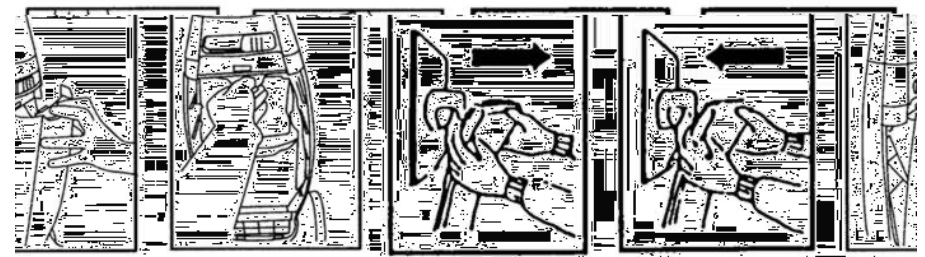

2. Emptying the Cloth Dust Bag:

- A) Hold the dust bag over a dustbin. Remove the clip by sliding it off the dust bag sideways.
- B) Shake the contents of the dust bag into the dustbin.
- C) Close the dust bag by sliding the clip back onto the bottom edge of the dust bag.

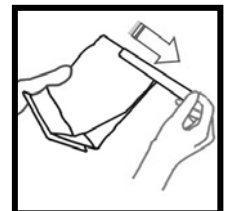

Free Manuals Download Website

<http://myh66.com>

<http://usermanuals.us>

<http://www.somanuals.com>

<http://www.4manuals.cc>

<http://www.manual-lib.com>

<http://www.404manual.com>

<http://www.luxmanual.com>

<http://aubethermostatmanual.com>

Golf course search by state

<http://golfingnear.com>

Email search by domain

<http://emailbydomain.com>

Auto manuals search

<http://auto.somanuals.com>

TV manuals search

<http://tv.somanuals.com>