

# SHARP®

## BD-HP24U(A)

BLU-RAY DISC/DVD PLAYER  
REPRODUCTOR DE DISCO BLU-RAY/DVD  
LECTEUR DE DISQUES BLU-RAY/DVD

OPERATION MANUAL  
MANUAL DE MANEJO  
MODE D'EMPLOI

ENGLISH

ESPAÑOL

FRANÇAIS



AQUOS LINK



BD-Video



RW  
COMPATIBLE



dts-HD  
Master Audio | Essential

DOLBY  
DIGITAL PLUS

DOLBY  
TRUEHD

MP3



HDMI®  
HIGH DEFINITION MULTIMEDIA INTERFACE

AVCHD

x.v.Color



For future reference, record the model and serial number (located on the rear of the product) in the space provided.

Model No.: \_\_\_\_\_

Serial No.: \_\_\_\_\_

ENGLISH

**WARNING: TO REDUCE THE RISK OF FIRE OR ELECTRIC SHOCK, DO NOT EXPOSE THIS APPLIANCE TO RAIN OR MOISTURE.**



**CAUTION**  
RISK OF ELECTRIC SHOCK  
DO NOT OPEN



**CAUTION:**

TO REDUCE THE RISK OF ELECTRIC SHOCK, DO NOT REMOVE COVER. NO USER-SERVICEABLE PARTS INSIDE. REFER SERVICING TO QUALIFIED SERVICE PERSONNEL.



This symbol warns the user of uninsulated voltage within the unit that can cause dangerous electric shocks.



This symbol alerts the user that there are important operating and maintenance instructions in the literature accompanying this unit.

**“WARNING—FCC Regulations state that any unauthorized changes or modifications to this equipment not expressly approved by the manufacturer could void the user’s authority to operate this equipment.”**

**INFORMATION**

This equipment has been tested and found to comply with the limits for a Class B digital device, pursuant to Part 15 of the FCC Rules. These limits are designed to provide reasonable protection against harmful interference in a residential installation. This equipment generates, uses and can radiate radio frequency energy and, if not installed and used in accordance with the instructions, may cause harmful interference to radio communications. However, there is no guarantee that interference will not occur in a particular installation. If this equipment does cause harmful interference to radio or television reception, which can be determined by turning the equipment off and on, the user is encouraged to try to correct the interference by one or more of the following measures:

- Reorient or relocate the receiving antenna.
- Increase the separation between the equipment and receiver.
- Connect the equipment into an outlet on a circuit different from that to which the receiver is connected.
- Consult the dealer or an experienced radio/TV technician for help.

**CAUTION:**

USE OF CONTROLS OR ADJUSTMENTS OR PERFORMANCE OF PROCEDURES OTHER THAN THOSE SPECIFIED HEREIN MAY RESULT IN HAZARDOUS RADIATION EXPOSURE.

AS THE LASER BEAM USED IN THIS UNIT IS HARMFUL TO THE EYES, DO NOT ATTEMPT TO DISASSEMBLE THE CABINET. REFER SERVICING TO QUALIFIED PERSONNEL ONLY.

- This Player is classified as a CLASS 1 LASER product.
- The CLASS 1 LASER PRODUCT label is located on the rear cover.
- This product contains a low power laser device. To ensure continued safety do not remove any cover or attempt to gain access to the inside of the product. Refer all servicing to qualified personnel.



# Contents

## Introduction

<b>Contents</b> .....	<b>2</b>
<b>What would you like to do with this Player?</b> .....	<b>3</b>
<b>DEAR SHARP CUSTOMER</b> .....	<b>4</b>
<b>IMPORTANT SAFETY INSTRUCTIONS</b> .....	<b>4-5</b>
<b>About Media Types</b> .....	<b>6-8</b>
Blu-ray Disc.....	6
Types of Discs that Can Be Used with This Player.....	6
Discs that Cannot Be Used with This Player.....	6-7
About Disc Contents.....	8
BD Video.....	8
Title, Chapter and Track.....	8
Icons Used on DVD Video Disc Cases.....	8
The Icons Used in This Operation Manual.....	8
<b>Important Information</b> .....	<b>9</b>
Disc Precautions.....	9
Copyright.....	9
<b>Getting Started</b> .....	<b>10</b>
<b>Major Components</b> .....	<b>11-12</b>
Main Unit (Front).....	11
Main Unit (Rear).....	11
Remote Control Unit.....	12

## Connection

<b>Introduction to Connections</b> .....	<b>13</b>
<b>Video Connections</b> .....	<b>14-16</b>
Connecting to the HDMI Terminal.....	14
Selecting the priority video output when connecting HDMI and Component video.....	14
Connecting to the Component Jacks.....	15
Connecting to the Video Jack.....	16
<b>Audio Connections</b> .....	<b>17</b>
Connecting to the Digital Audio Terminal or Audio Jacks.....	17
<b>Broadband Internet Connection</b> .....	<b>18</b>
Connecting to the ETHERNET terminal.....	18

## Playback

<b>Before Starting Playback</b> .....	<b>19-23</b>
Loading the Batteries in the Remote Control.....	19
Approximate operating range of remote control.....	19
Connecting the Power Cord.....	19
Turning the Power On.....	20
Turning the power on.....	20
Entering standby.....	20
Indicators on the Player.....	20
Language Setting.....	21
Changing the on-screen display language.....	21
Operating a SHARP TV Using the Remote Control.....	21
TV function control.....	21
Turning Off the LCD Backlight and Indications.....	21
Using AQUOS LINK.....	22
Controlling the Blu-ray disc player using AQUOS LINK.....	22
Control Panel.....	23
<b>Video/Picture/Music Playback</b> .....	<b>24-32</b>
Loading a Disc.....	24
BD/DVD Video Playback.....	24
Displaying the disc information.....	24
BD/DVD Menus.....	25
Start playback by selecting a title from the top menu.....	25
Using the disc menu.....	25
Using the pop-up menu.....	25
Enjoying BONUSVIEW or BD-LIVE.....	26
Use of Picture in Picture function (secondary audio/video playback).....	26
Virtual Package.....	26
BD-LIVE.....	26

DVD-R/-RW (VR format) / BD-RE/-R (BD-RE format)	
Playback.....	27
Playback by selecting a title.....	27
Sorting the titles.....	27
Playback by selecting a Playlist.....	27
Audio CD Playback.....	28
Playback from the beginning.....	28
Playback by selecting a track.....	28
Operation procedure for the "Functions" menu.....	28
Audio Data (MP3 File) Playback.....	29
Playing back Audio data (MP3 files).....	29
To play another file during Playback.....	29
To skip the file during Playback.....	29
Displaying Still Images (JPEG files).....	30
Displaying Still Images (JPEG files).....	30
Playing back Slide Show.....	30
Setting slide show speed/repeat playback.....	30
Instantly Watching Movies from Netflix.....	31-32
<b>Playback Functions</b> .....	<b>33-35</b>
Fast Forward/Reverse (Search).....	33
Skipping to the Next or the Start of the Current Chapter (Track/Title).....	33
Pause/Frame Advance Playback.....	33
Slow Playback.....	33
Repeat Playback of a Title or Chapter (Repeat Playback).....	34
Partial Repeat Playback (Repeat Playback of a Specified Part).....	34
Displaying the Audio Information.....	35
Switching Subtitles.....	35
Switching the Angle.....	35
Displaying the Angle Mark.....	35
<b>Settings During Playback</b> .....	<b>36-37</b>
Function Control.....	36
Function control operation procedure.....	36
Functions which can be set.....	37

## Settings

<b>SETTINGS</b> .....	<b>38-48</b>
Common operations.....	38
Basic Operation for Playback Setting.....	38
Audio Video Settings.....	39-40
Smart Settings.....	40
AQUOS LINK.....	40
Playback Setting.....	41
On Screen Language.....	41
Version.....	42
System.....	42
Communication Setup.....	42-43
The operation procedure for inputting characters manually.....	43
USB Memory Management.....	44
Software Update Settings.....	45-47
Manual Update from Network.....	45
Manual Update from USB memory device.....	46-47

## Appendix

<b>Troubleshooting</b> .....	<b>49-51</b>
To Reset this Player.....	51
<b>On-screen Error Messages</b> .....	<b>51</b>
<b>Specifications</b> .....	<b>52</b>
<b>Glossary</b> .....	<b>53-55</b>
<b>Network Service Disclaimer</b> .....	<b>56</b>
<b>About Software License</b> .....	<b>57</b>
<b>LIMITED WARRANTY</b> .....	<b>58-59</b>

# What would you like to do with this Player?

## Watch high quality movies on Blu-ray discs

This Player offers full high-definition Blu-ray disc playback.

**Video/Picture/Music Playback (p. 24)**

## Enjoy different kinds of media sources

Use this player to enjoy video, picture or music content from various types of media sources such as DVDs, USB memory devices and via the Internet.

**About Media Types (pp. 6–8)  
Video/Picture/Music Playback (p. 24)**

## Simple connection and operation through HDMI

This Player is equipped with an HDMI terminal. You can connect it to the TV using HDMI and no other cable will be needed to enjoy movies. If your TV is compatible with AQUOS LINK, you can control both the TV and this Player with simple operations.

**Introduction to Connections (p. 13)  
Video Connections (p. 14)**

## Enjoy BD-LIVE functions through the Internet

This Player is compatible with BD-LIVE. You can enjoy bonus content such as movie trailers through the Internet when playing back BD-Video discs compatible with BD-LIVE.

**Enjoying BONUSVIEW or BD-LIVE (p. 26)**

## Enjoy movies streamed from Netflix

Instantly watch movies streaming via this player. By connecting this player to the Internet, you can instantly watch TV episodes and movies streamed from Netflix on your TV.

**Instantly Watching Movies from Netflix (pp. 31–32)**

## What to do first:

Refer to “Getting Started” (p. 10) to prepare for using this player.

## Introduction (pp. 1–12)

Explains the important operation information.

## Connection (pp. 13–18)

Shows the connecting options provided by this Player.

## Playback (pp. 19–37)

Shows simple playback and useful functions.

## Settings (pp. 38–48)

Gives you more options to suit your circumstances.

## Appendix (pp. 49–59)

Provides troubleshooting tips and more information.

The illustrations and on-screen displays in this operation manual are for explanation purposes and may vary slightly from the actual operations.

# DEAR SHARP CUSTOMER

Thank you for your purchase of the SHARP Blu-ray Disc/DVD Player. To ensure safety and many years of trouble-free operation of your product, please read the Important Safety Instructions carefully before using this product.

## IMPORTANT SAFETY INSTRUCTIONS

Electricity is used to perform many useful functions, but it can also cause personal injuries and property damage if improperly handled. This product has been engineered and manufactured with the highest priority on safety. However, improper use can result in electric shock and/or fire. In order to prevent potential danger, please observe the following instructions when installing, operating and cleaning the product. To ensure your safety and prolong the service life of your Blu-ray Disc/DVD Player, please read the following precautions carefully before using the product.

- 1) Read these instructions.
- 2) Keep these instructions.
- 3) Heed all warnings.
- 4) Follow all instructions.
- 5) Do not use this apparatus near water.
- 6) Clean only with dry cloth.
- 7) Do not block any ventilation openings. Install in accordance with the manufacturer's instructions.
- 8) Do not install near any heat sources such as radiators, heat registers, stoves, or other apparatus (including amplifiers) that produce heat.
- 9) Do not defeat the safety purpose of the polarized or grounding-type plug. A polarized plug has two blades with one wider than the other. A grounding type plug has two blades and a third grounding prong. The wide blade or the third prong are provided for your safety. If the provided plug does not fit into your outlet, consult an electrician for replacement of the obsolete outlet.
- 10) Protect the power cord from being walked on or pinched particularly at plugs, convenience receptacles, and the point where they exit from the apparatus.
- 11) Only use attachments/accessories specified by the manufacturer.
- 12) Use only with the cart, stand, tripod, bracket, or table specified by the manufacturer, or sold with the apparatus. When a cart is used, use caution when moving the cart/apparatus combination to avoid injury from tip-over.
- 13) Unplug this apparatus during lightning storms or when unused for long periods of time.
- 14) Refer all servicing to qualified service personnel. Servicing is required when the apparatus has been damaged in any way, such as power-supply cord or plug is damaged, liquid has been spilled or objects have fallen into the apparatus, the apparatus has been exposed to rain or moisture, does not operate normally, or has been dropped.



### Additional Safety Information

- 15) Power Sources—This product should be operated only from the type of power source indicated on the marking label. If you are not sure of the type of power supply to your home, consult your product dealer or local power company. For products intended to operate from battery power, or other sources, refer to the operating instructions.
- 16) Overloading—Do not overload wall outlets, extension cords, or integral convenience receptacles as this can result in a risk of fire or electric shock.
- 17) Object and Liquid Entry—Never push objects of any kind into this product through openings as they may touch dangerous voltage points or short-out parts that could result in a fire or electric shock. Never spill liquid of any kind on the product.
- 18) Damage Requiring Service—Unplug this product from the wall outlet and refer servicing to qualified service personnel under the following conditions:
  - a) When the AC cord or plug is damaged,
  - b) If liquid has been spilled, or objects have fallen into the product,
  - c) If the product has been exposed to rain or water,
  - d) If the product does not operate normally by following the operating instructions. Adjust only those controls that are covered by the operating instructions as an improper adjustment of other controls may result in damage and will often require extensive work by a qualified technician to restore the product to its normal operation,
  - e) If the product has been dropped or damaged in any way, and
  - f) When the product exhibits a distinct change in performance - this indicates a need for service.
- 19) Replacement Parts—When replacement parts are required, be sure the service technician has used replacement parts specified by the manufacturer or have the same characteristics as the original part. Unauthorized substitutions may result in fire, electric shock, or other hazards.
- 20) Safety Check—Upon completion of any service or repairs to this product, ask the service technician to perform safety checks to determine that the product is in proper operating condition.
- 21) Wall or ceiling mounting—When mounting the product on a wall or ceiling, be sure to install the product according to the method recommended by the manufacturer.
- 22) The main AC plug is used as disconnect device and shall always remain readily operable.

# IMPORTANT SAFETY INSTRUCTIONS

- Water and Moisture—Do not use this product near water - for example, near a bath tub, wash bowl, kitchen sink, or laundry tub; in a wet basement; or near a swimming pool; and the like.
- Stand—Do not place the product on an unstable cart, stand, tripod or table. Placing the product on an unstable base can cause the product to fall, resulting in serious personal injuries as well as damage to the product. Use only a cart, stand, tripod, bracket or table recommended by the manufacturer or sold with the product. When mounting the product on a wall, be sure to follow the manufacturer's instructions. Use only the mounting hardware recommended by the manufacturer.
- Selecting the location—Select a place with no direct sunlight and good ventilation.
- Ventilation—The vents and other openings in the cabinet are designed for ventilation. Do not cover or block these vents and openings since insufficient ventilation can cause overheating and/or shorten the life of the product. Do not place the product on a bed, sofa, rug or other similar surface, since they can block ventilation openings. This product is not designed for built-in installation; do not place the product in an enclosed place such as a bookcase or rack, unless proper ventilation is provided or the manufacturer's instructions are followed.
- Heat—The product should be situated away from heat sources such as radiators, heat registers, stoves, or other products (including amplifiers) that produce heat.
- Lightning—For added protection for this product during a lightning storm, or when it is left unattended and unused for long periods of time, unplug it from the wall outlet. This will prevent damage to the product due to lightning and power-line surges.
- To prevent fire, never place any type of candle or flames on the top or near the product.
- To prevent fire or shock hazard, do not expose this product to dripping or splashing.  
No objects filled with liquids, such as vases, should be placed on the product.
- To prevent fire or shock hazard, do not place the AC cord under the product or other heavy items.

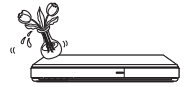

## Precautions when cleaning this product

- Turn off the main power and unplug the AC cord from the wall outlet before handling.
- To clean the outer cabinet, periodically wipe it with a soft cloth (cotton, flannel, etc.).
- For severe dirt, soak a soft cloth (cotton, flannel, etc.) in some neutral detergent diluted with water, wring the cloth out thoroughly, wipe off the dirt, then wipe again with a soft, dry cloth.
- Do not use chemicals or a chemically treated cloth for cleaning. It may damage the cabinet finish.





## About Media Types

### The following CD-RW/R discs cannot be played.

- Discs on which data has not been recorded cannot be played back.
- Discs recorded in a format other than an Audio CD and JPEG/MP3 file format cannot be played back.
- Discs may not be played back depending on their recording status or the status of the disc itself.
- Discs may not be played back depending on their compatibility with this Player.

### \*2 About the JPEG file format

JPEG is a type of file format for storing still-image files (photos, illustrations, etc.). The Player lets you play JPEG format still-image files.

#### File formats that are not compatible.

- Still images in formats other than JPEG (such as TIFF) cannot be played.
- There may be some files that cannot be played even if they are in JPEG format.
- Progressive JPEG files cannot be played.
- Moving image files as well as Motion JPEG format files cannot be played, even though they are JPEG files.

#### Other files that cannot be played back.

- You may not be able to play some still images which you have created, touched up, copied or otherwise edited on your computer.
- You may not be able to play some still images you have processed (rotated or saved by overwriting other images you have imported from the Internet or e-mail).

### You may experience one or more of the following symptoms when playing files.

- It may take some time to play files depending on the number of folders, number of files and volume of data involved.
- EXIF information will not be displayed. EXIF stands for Exchangeable Image File Format, and is a standard for storing interchange information in image files, especially those using JPEG compression. (Refer to <http://exif.org> for more information.)

### \*3 About the MP3 file format

MP3 files are audio data compressed in the MPEG1/2 Audio layer-3 file format. "MP3 files" have ".mp3" as extensions. (Some files that have ".mp3" extensions or files that have not been recorded in MP3 format will produce noise or cannot be played.)

#### Playing the MP3 file format

- The MP3 files are not played in the order they were recorded.
- It is recommended to record data at a lower speed as data recorded at a fast speed can produce noise and may not be able to be played.
- The more folders there are, the longer the reading time.
- Depending on the folder tree, reading MP3 files can take time.
- The playing time may not be correctly displayed during MP3 file playback.

### The following files cannot be played on this player.

- When both Audio CD [CD-DA] format and JPEG/MP3 file formats are recorded on a disc. (The disc is recognized to be an Audio CD [CD-DA] only tracks in Audio CD [CD-DA] format are played back.)
- Multi-session discs cannot be played.

### About files/folders for Still images (JPEG files) and audio data (MP3 files)

You can play still images (JPEG files) /audio data (MP3 files) with this unit by making folder(s) on discs or USB memory devices as shown below.

Example of a folder structure:

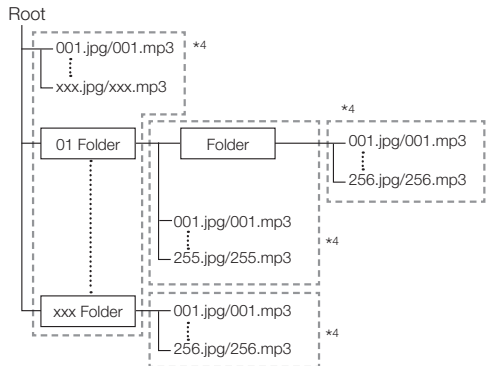

\*4 Including the root directory, the maximum number of folders and files in each folder is limited to 256 in total.

#### File and folder requirements

- The discs or USB memory devices which this player can play back (recognize) are limited to the following properties:
  - Contains EXIF format files (only JPEG files)
  - Picture resolution: Between 32 x 32 and 7680 x 4320 pixels (only JPEG files)
  - Maximum number of folders and files in each folder: 256
  - Maximum hierarchy level of folders: 5
  - File size: 20 MB or less (JPEG files)
  - 200 MB or less (MP3 files)

#### NOTE

- File and folder names displayed on this player may differ from those displayed on PCs.

## About Disc Contents

### BD Video

Enjoy BD-specific functions including BONUSVIEW (BD-ROM Profile 1 Version 1.1), such as picture-in-picture, and BD-LIVE (page 26).

For the BD video discs compatible with BONUSVIEW/BD-LIVE, you can enjoy additional contents by copying the data from the discs or downloading it via the internet. For instance, this function is capable of playing the original movie as the primary video while playing video commentary from the film director on a small screen as a secondary video.

#### NOTE

- The available functions differ depending on the disc.

### Title, Chapter and Track

- Blu-ray discs and DVDs are divided into "Titles" and "Chapters". If the disc has more than one movie on it, each movie would be a separate "Title". "Chapters", on the other hand, are subdivisions of titles. (See Example 1.)
- Audio CDs are divided into "Tracks". You can think of a "Track" as one tune on an Audio CD. (See Example 2.)

Example 1: Blu-ray disc or DVD

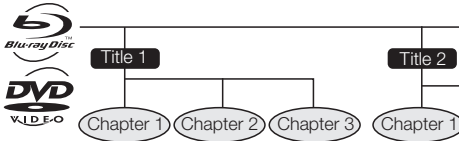

Example 2: Audio CD



### Icons Used on DVD Video Disc Cases

The back of the case of a DVD that is commercially available usually contains various information about the contents of the disc.

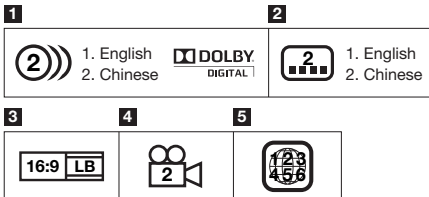

#### 1 Audio tracks and audio formats

DVD discs can contain up to 8 separate tracks with a different language on each. The first in the list is the original track.

This section also details the audio format of each soundtrack — Dolby Digital, DTS, MPEG etc.

#### Dolby Digital

A sound system developed by Dolby Laboratories Inc. that gives movie theater ambience to audio output when the Player is connected to a Dolby Digital processor or amplifier.

#### DTS

DTS is a digital sound system developed by DTS, Inc. for use in cinemas.

#### Linear PCM

Linear PCM is a signal recording format used for Audio CDs and on some DVD and Blu-ray discs. The sound on Audio CDs is recorded at 44.1 kHz with 16 bits. (Sound is recorded between 48 kHz with 16 bits and 96 kHz with 24 bits on DVD video discs and between 48 kHz with 16 bits and 192 kHz with 24 bits on BD video discs.)

#### 2 Subtitle languages

This indicates the kind of subtitles.

#### 3 Screen aspect ratio

Movies are shot in a variety of screen modes.

#### 4 Camera angle

Recorded onto some BD/DVD discs are scenes which have been simultaneously shot from a number of different angles (the same scene is shot from the front, from the left side, from the right side, etc.).

#### 5 Region code

This indicates the region code (playable region code).

## The Icons Used in This Operation Manual

<b>BD VIDEO</b> [Icon]	..... Indicates the functions that can be performed for BD Video discs.
<b>BD-RE</b> [Icon]	..... Indicates the functions that can be performed for BD-RE discs.
<b>BD-R</b> [Icon]	..... Indicates the functions that can be performed for BD-R discs.
<b>DVD VIDEO</b> [Icon]	..... Indicates the functions that can be performed for DVD Video discs.
<b>DVD-RW</b> [Icon]	..... Indicates the functions that can be performed for DVD-RW discs.
<b>DVD-R</b> [Icon]	..... Indicates the functions that can be performed for DVD-R discs.
<b>AUDIO CD</b> [Icon]	..... Indicates the functions that can be performed for Audio CDs.
<b>CD-R</b> [Icon]	..... Indicates the functions that can be performed for CD-R discs.
<b>CD-RW</b> [Icon]	..... Indicates the functions that can be performed for CD-RW discs.
<b>USB</b> [Icon]	..... Indicates the functions that can be performed for USB memory devices.





# Important Information

## Disc Precautions

### Be Careful of Scratches and Dust

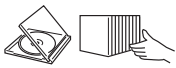
- BD, DVD and CD discs are sensitive to dust, fingerprints and especially scratches. A scratched disc may not be able to be played back. Handle discs with care and store them in a safe place.

### Proper Disc Storage

Place the disc in the center of the disc case and store the case and disc upright.	
Avoid storing discs in locations subject to direct sunlight, close to heating appliances or in locations of high humidity.	
Do not drop discs or subject them to strong vibrations or impacts.	
Avoid storing discs in locations where there are large amounts of dust or moisture.	

### Handling Precautions

- If the surface is soiled, wipe gently with a soft, damp (water only) cloth. When wiping discs, always move the cloth from the center hole toward the outer edge.



- Do not use record cleaning sprays, benzene, thinner, static electricity prevention liquids or any other solvent.
- Do not touch the surface.
- Do not stick paper or adhesive labels to the disc.
- If the playing surface of a disc is soiled or scratched, the Player may decide that the disc is incompatible and eject the disc tray, or it may fail to play the disc correctly. Wipe any dirt off the playing surface with a soft cloth.

### Cleaning the Pick Up Lens

- Never use commercially available cleaning discs. The use of these discs can damage the lens.
- Request the nearest service center approved by SHARP to clean the lens.

### Warnings about dew formation

- Condensation may form on pick up lens or disc in the following conditions:
  - Immediately after a heater has been turned on.
  - In a steamy or very humid room.
  - When the Player is suddenly moved from a cold environment to a warm one.

#### When condensation forms:



- It becomes difficult for the Player to read the signals on the disc and prevents the Player from operating properly.

#### To remove condensation:

- Take out the disc and leave the Player with the power off until the condensation disappears. Using the Player when there is condensation may cause malfunction.

## Copyright

Audio-visual material may consist of copyrighted works which must not be recorded without the authority of the owner of the copyright. Refer to relevant laws in your country.

- "This item incorporates copy protection technology that is protected by U.S. patents and other intellectual property rights of Rovi Corporation. Reverse engineering and disassembly are prohibited."
- Manufactured under license from Dolby Laboratories. "Dolby" and the double-D symbol are trademarks of Dolby Laboratories.
- Manufactured under license under U.S. Patent #'s: 5,451,942; 5,956,674; 5,974,380; 5,978,762; 6,226,616; 6,487,535; 7,392,195; 7,272,567; 7,333,929; 7,212,872 & other U.S. and worldwide patents issued & pending. DTS and the Symbol are registered trademarks, & DTS-HD, DTS-HD Master Audio | Essential and the DTS logos are trademarks of DTS, Inc. Product includes software. ©DTS, Inc. All Rights Reserved.
-  is a trademark.
- "BD-LIVE" logo is a trademark of Blu-ray Disc Association.
-  is a trademark of DVD Format/Logo Licensing Corporation.
- HDMI, the HDMI logo and High-Definition Multimedia Interface are trademarks or registered trademarks of HDMI Licensing LLC.
- "x.v.Color" and "x.v.Color" logo are trademarks of Sony Corporation.
- Java and all Java-based trademarks and logos are trademarks or registered trademarks of Sun Microsystems, Inc. in the United States and/or other countries.
- "BONUSVIEW" logo is a trademark of Blu-ray Disc Association.
- "AVCHD" and the "AVCHD" logo are trademarks of Panasonic Corporation and Sony Corporation.

## ENERGY STAR® Program Information



Products that have earned the ENERGY STAR® are designed to protect the environment through superior energy efficiency.

ENERGY STAR® is a U.S. registered mark.

# Getting Started

## Step 1: Unpacking

Make sure the following accessories are provided with the product.

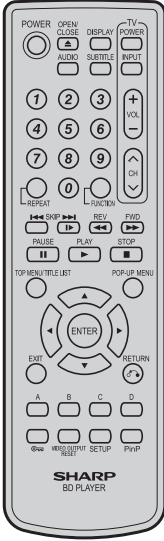
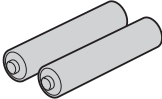
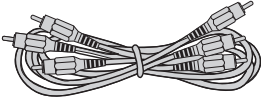
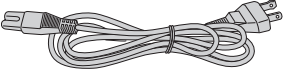
Remote control unit	"AA" size battery (× 2)	AC cord
 <p>Page 12 and 19</p>	 <p>Page 19</p>  <p>Page 16 and 17</p>	 <p>Page 19</p>

## Step 2: Selecting equipment to connect

Connection varies with the equipment used. Refer to Connection (Pages 13–18).  
Turn off the devices before connecting.

### For using online services such as BD-LIVE and Netflix

To use the online services available on this player (BD-LIVE or Netflix), after an internet connection is made, communication setup is required. Refer to "Communication Setup" (Pages 42–43).

## Step 3: Playing back video/picture/music content

Play back video, picture or music content from the desired media source such as Blu-ray and DVD discs, or via the internet. Refer to Playback (Pages 19–37).

## Step 4: Adjust settings to suit your preference

Adjust settings to enjoy various features and other functions for playing discs/content.  
Refer to Settings (Pages 38–48).

# Major Components

## Main Unit (Front)

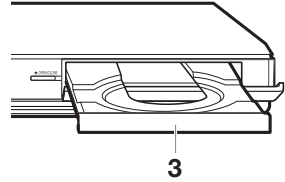
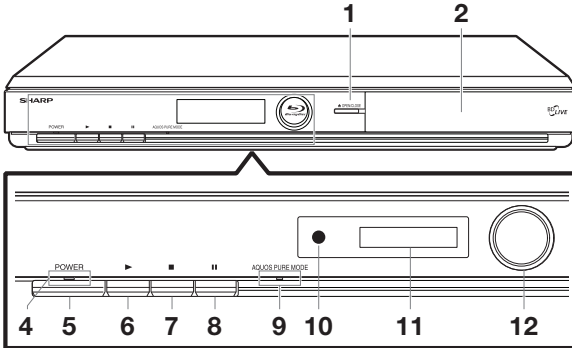

- |                                |                    |  |
|--------------------------------|--------------------|--|
| 1 OPEN/CLOSE (p. 24)           | 5 POWER (p. 20)    | 9 AQUOS PURE MODE indicator (pp. 20, 22) |
| 2 Door flap                    | 6 ► PLAY (p. 24)   | 10 Remote control sensor (p. 19)         |
| 3 Disc tray (p. 24)            | 7 ■ STOP (p. 24)   | 11 Front panel display (p. 20)           |
| 4 ON/STANDBY indicator (p. 20) | 8    PAUSE (p. 28) | 12 BD/DVD/CD mode indicator (p. 20)      |

## Main Unit (Rear)

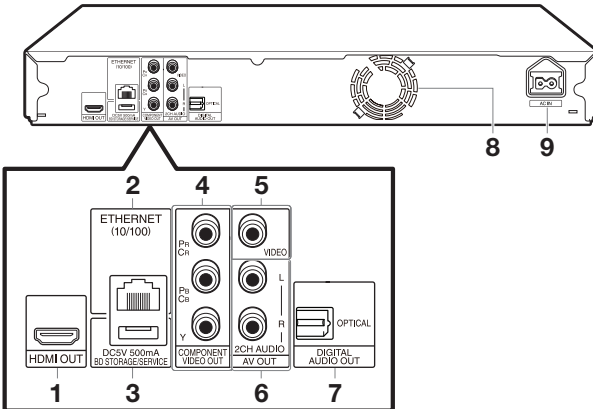

- 1 HDMI OUT terminal (p. 14)
- 2 ETHERNET terminal (p. 18)
- 3 BD STORAGE/SERVICE terminal  
BD STORAGE (pp. 26, 44)  
SERVICE for software (p. 46)
- 4 COMPONENT VIDEO OUT jacks (p. 15)
- 5 VIDEO output jack (p. 16)
- 6 2CH AUDIO output jacks (p. 17)
- 7 DIGITAL AUDIO OUT OPTICAL terminal (p. 17)
- 8 Ventilation holes  
Do not cover the ventilation holes.
- 9 AC IN terminal (p. 19)

Remote Control Unit

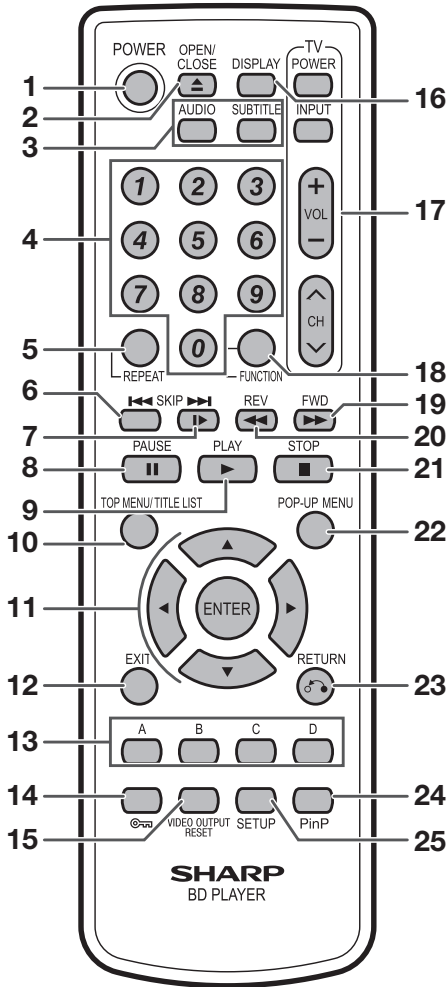

- 1 POWER (p. 20)
- 2 ▲ OPEN/CLOSE (p. 24)
- 3 ▲ AUDIO (p. 35), SUBTITLE (p. 35)
- 4 Number buttons (p. 37)
- 5 REPEAT (p. 34)
- 6 ⏮ SKIP (pp. 27, 33)
- 7 ⏭ SKIP/▶ (pp. 27, 33)
- 8 || PAUSE (pp. 28, 33)
- 9 ▶ PLAY (p. 24)
- 10 TOP MENU/TITLE LIST (pp. 25, 27)
- 11 Cursor buttons (▲/▼/◀/▶), ENTER (pp. 21, 38)
- 12 EXIT (p. 38)
- 13 A (Red), B (Green), C (Blue), D (Yellow) (pp. 27, 28, 30, 43)
- 14 🔒 (Lock) (See below.)
- 15 VIDEO OUTPUT RESET (p. 39)
- 16 DISPLAY (pp. 24, 34)
- 17 TV control buttons (p. 21)
- 18 FUNCTION (pp. 35, 36)
- 19 ⏭ FWD (p. 33)
- 20 ⏮ REV (p. 33)
- 21 ■ STOP (p. 24)
- 22 POP-UP MENU (p. 25)
- 23 ↶ RETURN (pp. 28, 34)
- 24 PinP (p. 26)
- 25 SETUP (pp. 21, 38)

**Keylock function**

You can set the keylock to prevent accidental operations. This function allows TVs compatible with AQUOS LINK to also perform a Key Lock on the player.

Press and hold 🔒 (Lock) for more than 2 seconds.

- Each time you perform this operation, the function is activated or deactivated.
- If you try to operate the Player while the keylock function is set, "Hold" blinks on the front display panel to indicate that the keylock function is set.

Hold

# Introduction to Connections

This Player is equipped with the terminals/jacks listed below. Find the corresponding terminal/jack on your video equipment. Using the supplied cable or commercially available cables, connect the video first. Then connect the audio.

## Video terminals/jacks on this Player

Higher Quality

① HDMI OUT terminal



Page 14

② COMPONENT VIDEO OUT jacks

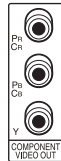

Page 15

③ VIDEO output jack



Page 16

Standard Quality

Connection

## Audio terminals/jacks on this Player

### Digital audio connection

Higher Quality

① HDMI OUT terminal



Page 14

② DIGITAL AUDIO OUT OPTICAL terminal



Page 17

Standard Quality

### Analog audio connection

Standard Quality

2CH AUDIO output jacks



Page 17

## Broadband Internet connection

ETHERNET terminal

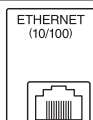

Page 18

# Video Connections

## Connecting to the HDMI Terminal

- You can enjoy high quality digital picture and sound through the HDMI terminal.
- For details on digital audio output formats (PCM/bitstream), refer to the digital audio output format selection table on page 48.
- When you use AQUOS LINK, make sure to use a certified HDMI cable.

### STEPS

- 1 Be sure to turn off this Player and the equipment before making any connections.
- 2 Firmly connect an HDMI cable (commercially available) to the HDMI terminals (① and ②).

### NOTE

- Audio transmitted in DTS-HD High Resolution Audio and DTS-HD Master Audio formats is output from the HDMI terminal as Bitstream. Connect an amplifier with a built-in decoder to enjoy the fine sound quality.

- When using an HDMI output, 7.1 ch Digital Output is available.

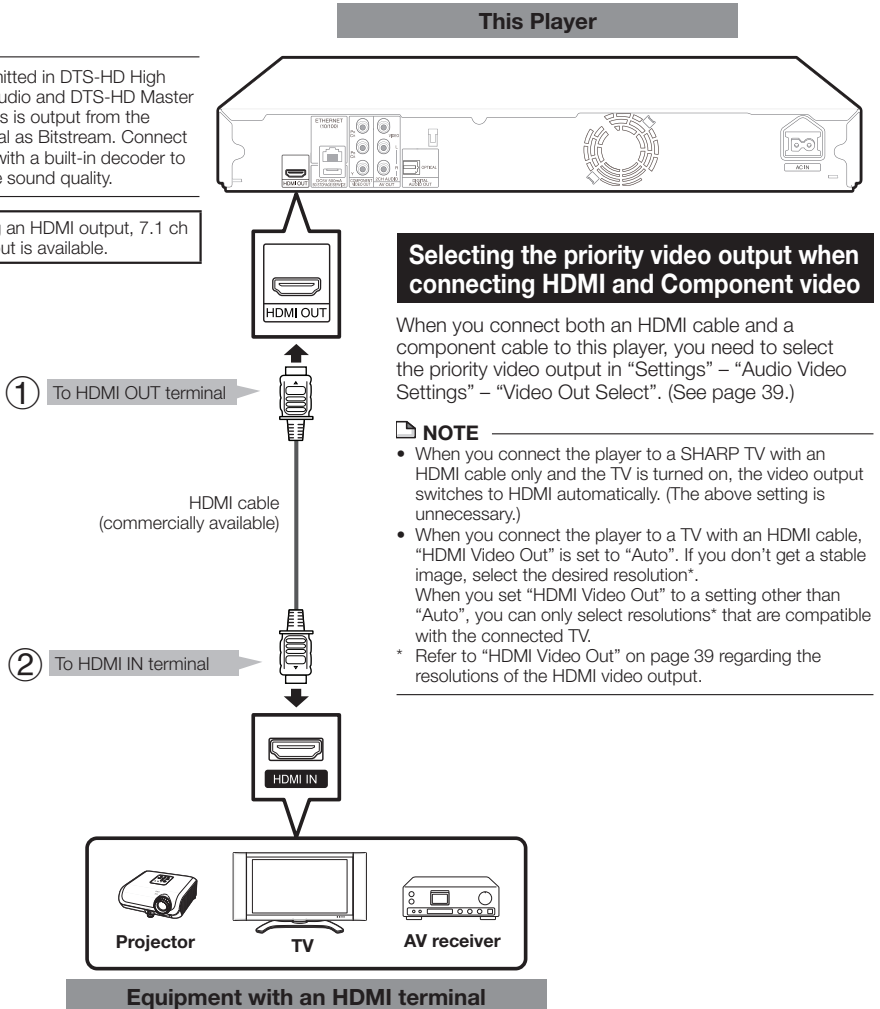

### After connecting

- If desired, connect audio equipment. (Page 17)
- If necessary, perform the Audio Video Settings. (Pages 39–40)
- Refer to AQUOS LINK function. (Pages 22 and 40)
- Prepare the desired disc or content and start playback. (Pages 24–32)



## Connecting to the Component Jacks

You can enjoy accurate color reproduction and high quality images through the component jacks.

### STEPS

- 1 Be sure to turn off this Player and the equipment before making any connections.
- 2 Firmly connect a component video cable (commercially available) to the component jacks (① and ②).

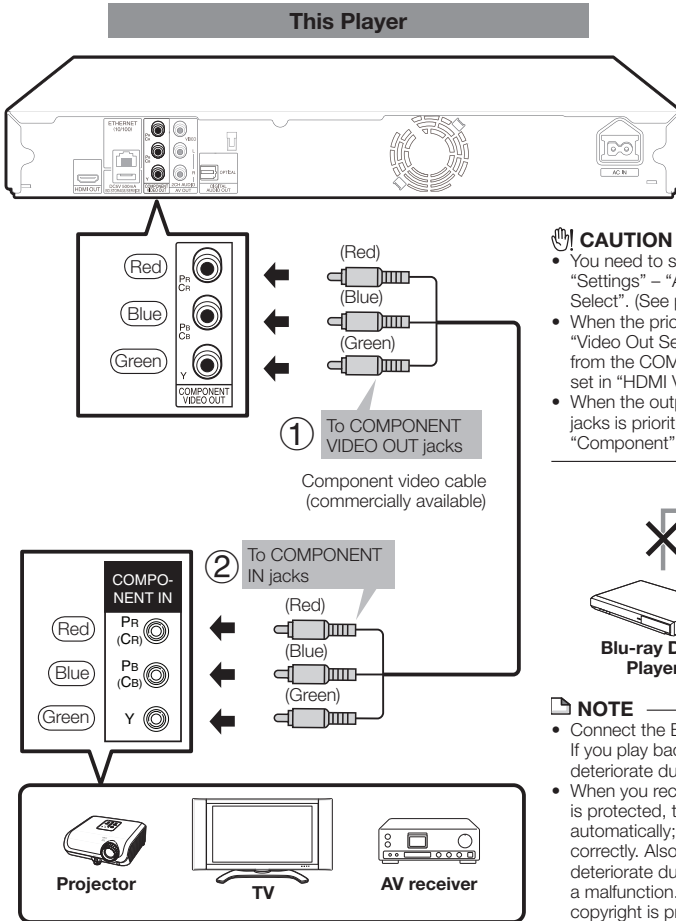

### CAUTION

- You need to select the priority video output in "Settings" – "Audio Video Settings" – "Video Out Select". (See page 39.)
- When the priority video output is set to "HDMI" in "Video Out Select", the video resolution which is output from the COMPONENT VIDEO OUT jacks is the one set in "HDMI Video Out".
- When the output from the COMPONENT VIDEO OUT jacks is prioritized, set the priority video output to "Component".

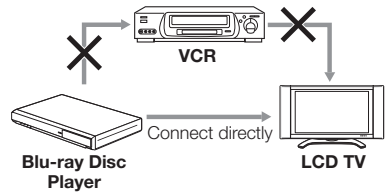

### NOTE

- Connect the Blu-ray disc player to LCD TV directly. If you play back the image via VCR, the image may deteriorate due to the copy guard function.
- When you record the program where copyright is protected, the copy guard function is activated automatically; the program cannot be recorded correctly. Also, the playback image via VCR may deteriorate due to this function. However, this is not a malfunction. When you watch the program where copyright is protected, we recommend that the Blu-ray disc player be connected to LCD TV directly.

### Video equipment with component jacks

### After connecting

- Connect audio equipment or the audio terminals of the TV. (Page 17)
- If necessary, perform the Audio Video Settings. (Pages 39–40)

## Connecting to the Video Jack

You can enjoy the images through the video jack.

### STEPS

- 1 Be sure to turn off this Player and the equipment before making any connections.
- 2 Firmly connect an AV cable (supplied) to the video jacks (1) and (2).

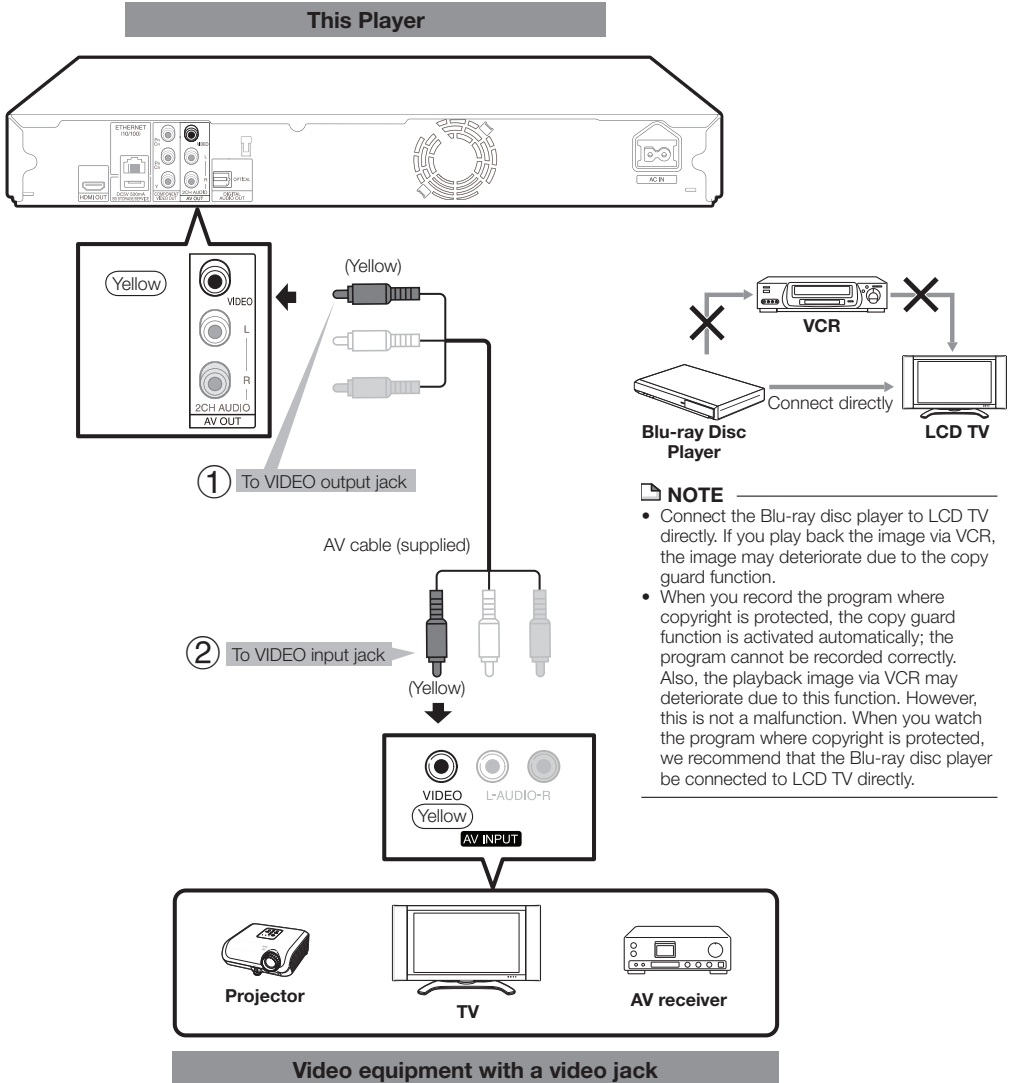

### After connecting

- Connect audio equipment or the audio terminals of the TV. (Page 17)
- If necessary, perform the Audio Video Settings. (Pages 39–40)

# Audio Connections

## Connecting to the Digital Audio Terminal or Audio Jacks

- You can connect audio equipment or the TV to the DIGITAL AUDIO OUT terminal or 2CH AUDIO output jacks.
- For details on digital audio output formats (PCM/bitstream), refer to the digital audio output format selection table on page 48.

### STEPS

- 1 Be sure to turn off this Player and the equipment before making any connections.
- 2 Firmly connect an optical digital cable (commercially available) or AV cable (supplied) to the optical digital audio terminals or audio jacks (① and ②, or ③ and ④).

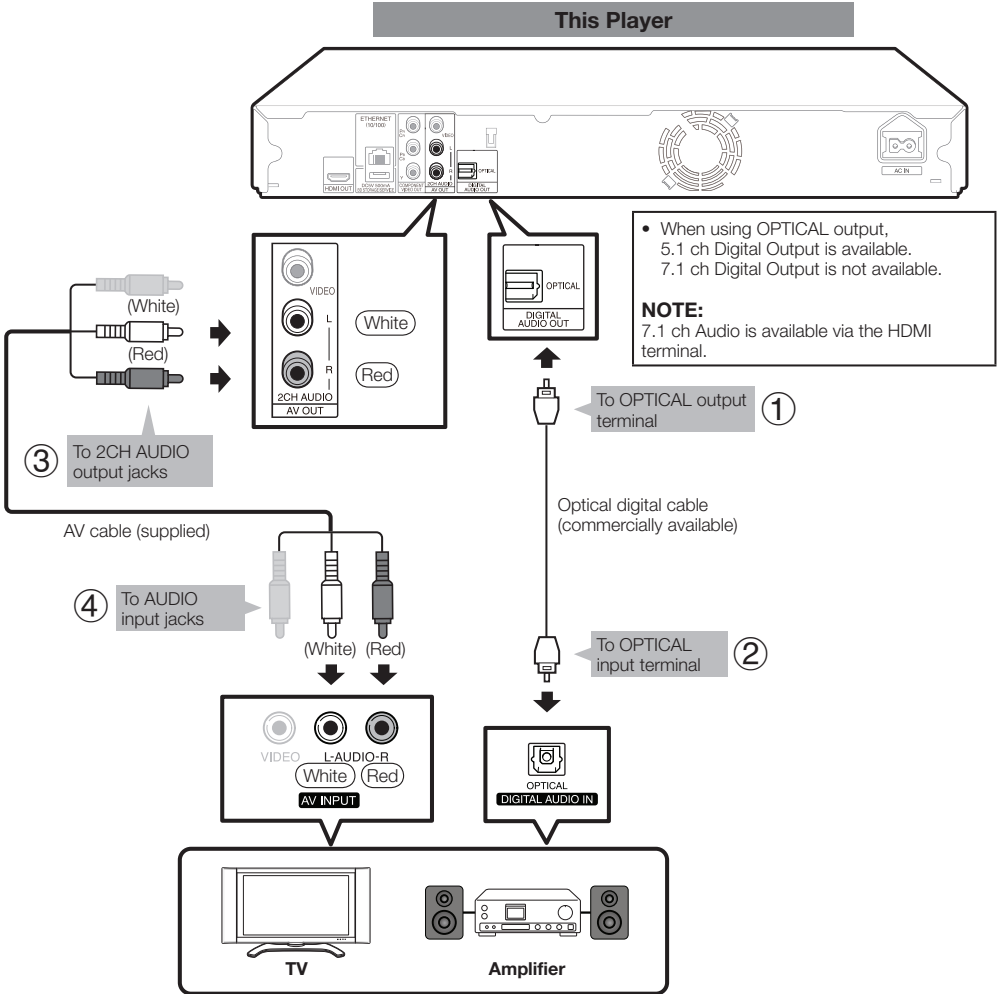

### Audio equipment with a digital audio input terminal or audio jacks

#### After connecting

- If necessary, perform the Audio Video Settings. (Pages 39–40)
- Prepare the desired disc or content and start playback. (Pages 24–32)

# Broadband Internet Connection

## Connecting to the ETHERNET terminal

- By connecting this player to the Internet, you can enjoy a variety of content on your TV using BD-LIVE functions and Netflix.
- This player can update the software from Sharp's server using the Internet.
- When using the internet, a broadband internet connection as shown below is required.

### STEPS

- 1 Be sure to turn off this Player and the equipment before making any connections.
- 2 Firmly connect a LAN cable (commercially available) to the ETHERNET terminal (① and ②).

### This Player

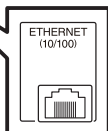
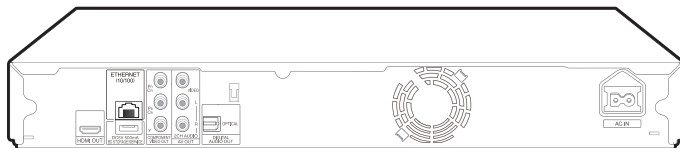

To ETHERNET terminal ①

LAN cable  
(commercially available)

To LAN terminal ②

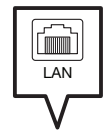

### CAUTION

- When using a broadband Internet connection, a contract with an Internet service provider is required. For more details, contact your nearest Internet service provider.
- Refer to the operation manual of the equipment you have as the connected equipment and connection method may differ depending on your Internet environment.

### NOTE

- Use a LAN cable/router supporting 10BASE-T/100BASE-TX.
- SHARP cannot guarantee that all brands' hubs will operate with this player.

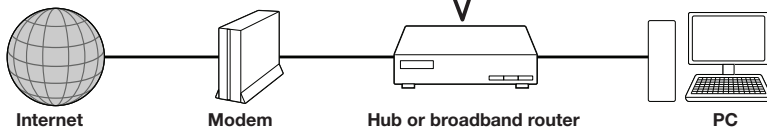

### Example of a Broadband Internet Connection

### After connecting

- Perform the communication settings. (Pages 42-43)
- When enjoying online services (BD-LIVE, Netflix), refer to BD-LIVE functions (pages 26 and 41) or Netflix (pages 31-32).
- To update the software via the Internet, perform Software Update Settings. (Page 45)

# Before Starting Playback

## Loading the Batteries in the Remote Control

- 1 Hold in the tab on the battery cover and pull the cover towards the direction of the arrow.

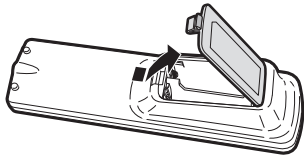

- 2 Load the two "AA" size batteries (R-06 size, UM/SUM-3). Place batteries with their terminals corresponding to the  $\oplus$  and  $\ominus$  indications in battery compartment.

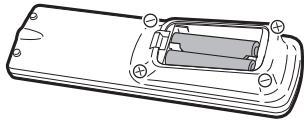

- 3 Insert the smaller tab of the battery cover into the opening ①, and press down on the cover until it clicks in place ②.

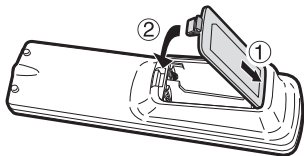

### NOTE

- Do not subject the remote control unit to shock, water or excessive humidity.
- The remote control unit may not function if the Player's remote sensor is in direct sunlight or any other strong light.
- Incorrect use of batteries may cause them to leak or burst. Read the battery warnings and use the batteries properly.
- Do not mix old and new batteries, or mix different brands.
- Remove the batteries if you will not use the remote control unit for an extended period of time.

### WARNING

- Do not use or store batteries in direct sunlight or other excessively hot place, such as inside a car or near a heater. This can cause batteries to leak, overheat, explode or catch fire. It can also reduce the life or performance of batteries.

## Approximate operating range of remote control

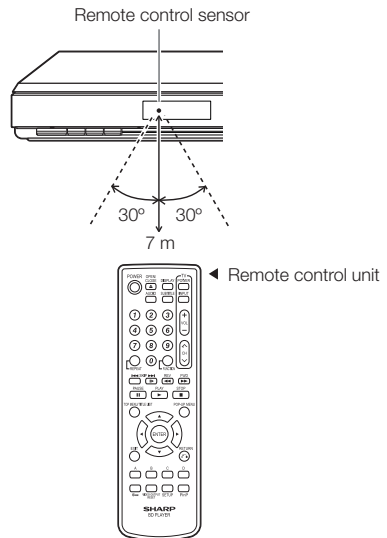

## Connecting the Power Cord

Plug the supplied AC cord into the AC IN terminal on the rear of the Player. Then plug into AC outlet.

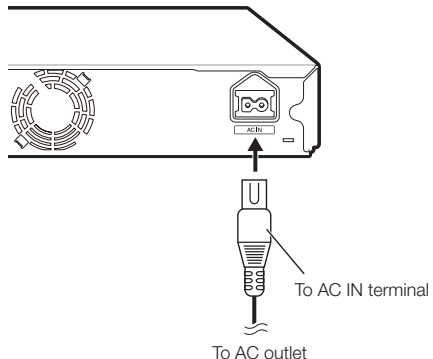

### NOTE

- Place the Player close to the AC outlet, and keep the power plug within reach.
- TO PREVENT RISK OF ELECTRIC SHOCK, DO NOT TOUCH THE UN-INSULATED PARTS OF ANY CABLES WHILE THE AC CORD IS CONNECTED.
- The ON/STANDBY indicator blinks while the Player is preparing for starting up. You cannot turn the Player on until the ON/STANDBY indicator stops blinking.
- If you are not going to use this Player for a long period of time, be sure to remove the AC cord from the AC outlet.

## Before Starting Playback

### Turning the Power On

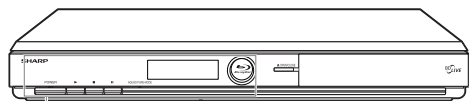

POWER

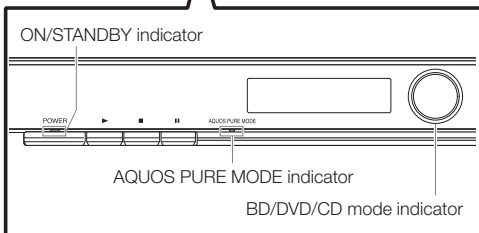

### Turning the power on

Press **POWER** on the remote control or on the Player to turn on the power of the Player.



#### NOTE

- When you turn on this player for the first time after purchase or when you turn on this player after you perform "System Reset" (see page 41), the language setting screen will be displayed, so please perform the language setting (see step 4 of page 21).

### Entering standby

Press **POWER** on the remote control or on the Player to enter standby.

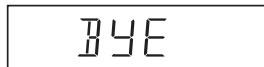

- If you press **POWER** again immediately after entering standby, the Player may not turn on. If this happens, wait for 10 seconds or more and then turn on the power again.

#### NOTE

- When the ON/STANDBY indicator is blinking (may take some time), the Player cannot be turned on.

### Indicators on the Player

#### ON/STANDBY indicator

Green on	Power on
Red blinks	Preparing for standby
Red on	Standby

#### AQUOS PURE MODE indicator

Green on	Output in AQUOS PURE MODE (See page 22.)
----------	--

#### BD/DVD/CD mode indicator

Blue on	Playing back
Blue blinks	Loading a disc

## Language Setting

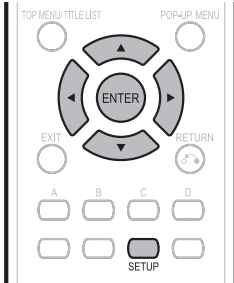

### Changing the on-screen display language

- 1 Press **SETUP** to display the Menu screen.
  - The same operation can be performed by pressing **ENTER** after selecting the MENU icon on the Wall Paper screen.



- 2 Press **▲/▼** to select “Settings”, then press **▶** or **ENTER**.



- 3 Press **▲/▼** to select “On Screen Language”, then press **▶** or **ENTER**.

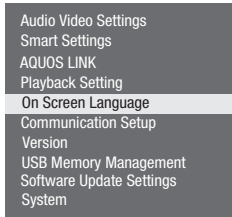

- 4 Press **▲/▼** to select the language you want to display on the screen, then press **ENTER**.

#### NOTE

- To select the DVD disc language, such as subtitle language, etc., see page 25.

## Operating a SHARP TV Using the Remote Control

The Universal Remote Control may operate the basic functions of the SHARP TV.

### TV function control



- TV Power: POWER
- TV-AV Selector: INPUT
- TV Volume up/down: VOL +/-
- TV Channel up/down: CH ▲/▼

### Turning Off the LCD Backlight and Indications

If you feel that the indicators on the player's front display are too bright when watching movies, you can turn them off except for the ON/STANDBY indicator.

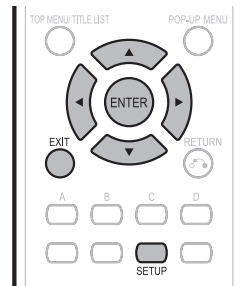

- 1 Press **SETUP** to display the Menu screen.
  - The same operation can be performed by pressing **ENTER** after selecting the MENU icon on the Wall Paper screen.
- 2 Press **▲/▼** to select “Settings”, then press **▶** or **ENTER**.
- 3 Press **▲/▼** to select “Smart Settings”, then press **▶** or **ENTER**.
- 4 Press **▲/▼** to select “Front Display/LED”, then press **▶** or **ENTER**.
- 5 Press **▲/▼** to select “On” or “Off”, then press **ENTER**.
- 6 Press **SETUP** or **EXIT** to exit.

### Using AQUOS LINK

#### Controlling the Blu-ray disc player using AQUOS LINK

##### What is AQUOS LINK?

Using the HDMI CEC (Consumer Electronics Control), with AQUOS LINK you can interactively operate this player with your SHARP AQUOS TV.

##### What you can do with AQUOS LINK

When you connect this player to the LCD TV compatible with AQUOS LINK using an HDMI cable, you can perform the functions listed below. (See page 14 for connecting to the HDMI terminal).

##### ● Automatic input select function

When you start playback of this player, the input selector of the LCD TV will automatically switch to the LCD TV input terminal connected to the player and the playback image will appear on the screen, even if you are watching a TV program.

##### ● Automatic power off function

If you turn off the LCD TV when this player is in stop mode, the power of this player will be turned off automatically. (However, when playing back a disc or other content using this player, the power does not turn off.)

##### ● Automatic power on function

When you switch to the LCD TV input terminal connected to this player, the power of this player will be turned on automatically.

##### ● AQUOS PURE MODE

When you connect this player to an AQUOS LCD TV compatible with AQUOS LINK and set "AQUOS LINK" to "Yes" (page 40), images automatically adjusted to the most suitable image quality for the AQUOS TV are output from the HDMI OUT terminal of this player.

The AQUOS PURE MODE indicator on the player lights in green.

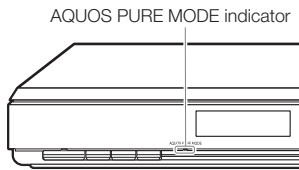

##### NOTE

- In order to make AQUOS LINK available, set up AQUOS LINK on the LCD TV that is connected to this player. See page 40 regarding the setup of this player. Refer to the Operation Manual of the TV for details regarding setup.



# Before Starting Playback

## Control Panel

This function allows you to operate this player using the TV remote control by displaying the control panel on the TV screen.

- To operate this function, connect this player to a TV compatible with HDMI CEC (Consumer Electronics Control) using an HDMI cable (See page 14). Make sure that "Control Panel" is set to "Yes" (See page 40). When the settings are completed, perform the following operations.

### NOTE

- The control panel may not be displayed depending on the TV. Also, it may not be available depending on the content.
- When operating using the remote control of the player, the control panel does not appear.
- When playing Netflix streaming content, the control panel cannot be displayed.

- 1 Switch the TV input to the input source to which this player is connected (HDMI input).
- 2 Press the **PLAY** button on the TV remote control.
  - The control panel appears on the TV screen.

### Control Panel

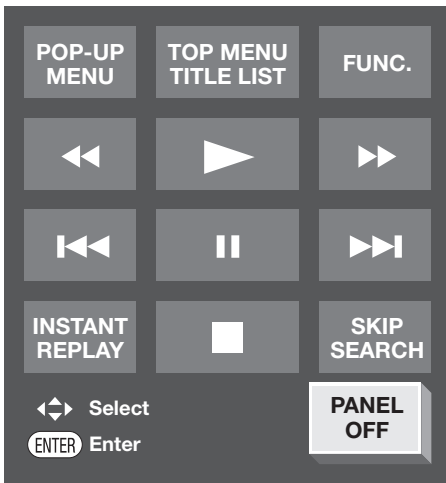

- When there is no operation for approximately 10 seconds, the control panel disappears automatically. To display the control panel, press the **PLAY** button on the TV remote control.

- 3 Press **▲/▼/◀/▶** on the TV remote control to select the desired button icon, then press **ENTER**.
  - The function of the selected button icon is available.

## Major functions of each button icon

### POP-UP MENU

- Display the pop-up menu screen for BD video and the menu screen for DVD video.

### TOP MENU TITLE LIST

- Display the top menu screen for BD video and DVD video.

### FUNC.

- Display the Function Control screen for BD video, DVD video, etc.



- Fast reverse (search).



- Play.



- Fast forward (search).



- Skip to the beginning of a chapter.



- Pause.



- Skip to the next chapter.

### INSTANT REPLAY

- Jump backward (approx. 10 seconds). (This function is used when you want to re-watch a scene that has just been shown.)



- Stop.

### SKIP SEARCH

- Jump ahead (approx. 30 seconds).

### PANEL OFF

- Turn off the control panel.

# Video/Picture/Music Playback

## Loading a Disc

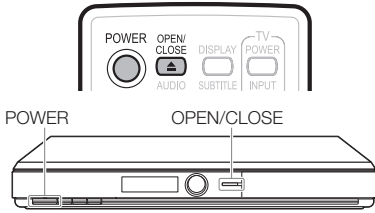

- 1 Press **POWER** to turn on the power.
- 2 Press **OPEN/CLOSE** to open the disc tray.
- 3 Load a disc on the disc tray.
  - Insert the disc with the label face up.
  - In case of disc recorded on both sides, face down the side to play back.

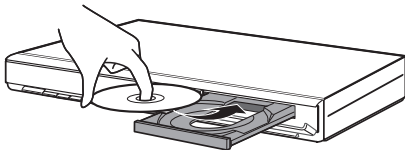

- 4 Press **OPEN/CLOSE** to close the disc tray.

## BD/DVD Video Playback

**BD VIDEO** **BD-RE** **BD-R**

**DVD VIDEO** **DVD-R** **DVD-RW**

This section explains playback of commercially available BD Video and DVD Video discs (like movies) and recorded DVD-RW/R discs.

- This player supports DVD upscaling during DVD playback.
- For a description of other playback functions, refer to "Playback Functions" on pages 33–35.



- 1 Load a disc.
  - Playback may begin automatically, depending on the disc.
  - Playback begins from the first title.
  - The menu may be displayed first, depending on the disc. Perform playback operation by following the directions on the screen.
- 2 Press **▶ PLAY** if playback does not begin automatically or playback is stopped.

### NOTE

- The disc load time may vary depending on the disc.

### Regarding playback of BD video discs

- Some of the newly released BD video discs cannot be played back unless you update the player software to the latest version. Therefore, it may be required to update the software of the player. Refer to pages 45–47 for more information regarding software updates for the player.

## To stop playback

Press **■ STOP**.

## Resume playback function

- If you press **▶ PLAY** next, playback will resume from the point where the Player was previously stopped. To playback from the beginning, cancel resume mode by pressing **■ STOP**, then press **▶ PLAY**. (This may not work depending on the type of disc. In this case, open the disc tray or enter standby.)

### NOTE

- Resume playback may not function depending on the disc.
- The resume playback function for discs will be cancelled if Netflix content is viewed after disc playback. Disc playback will start from the beginning after viewing Netflix content.

## Displaying the disc information

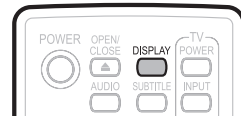

Press **DISPLAY** during playback.

- Each time you press **DISPLAY**, the display switches as follows.

### Disc Information Screen A

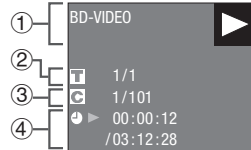

### Disc Information Screen B

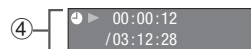

**No Display**

- ① Type of disc
- ② Title number being played / Total number of Titles
- ③ Chapter number being played / Total number of Chapters
- ④ Elapsed playback time / Total playback time for the Title

### NOTE

- Disc Information Screen A disappears after about 1 minute elapses without performing any operations.
- For some commercially-released BD VIDEO discs, the total playback time display for the Chapter/Title may not appear.

## BD/DVD Menus

- This section explains how to play back a BD/DVD video disc with a top menu, disc menu or pop-up menu.
- The titles listed in the top menu and a disc guide (for options like subtitles and audio languages) are given in the disc menu.

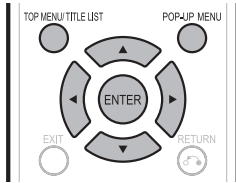

### Start playback by selecting a title from the top menu

BD VIDEO DVD VIDEO

- Press **TOP MENU/TITLE LIST**.
  - The top menu screen is displayed if present on the BD/DVD video disc.

#### Example

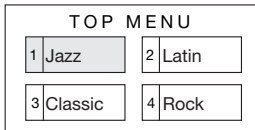

- Press **▲/▼/◀/▶** to select the title, then press **ENTER**.
  - The selected title is played back.

#### NOTE

- The procedure explained on this page is the basic operation procedure. Procedures vary depending on the BD/DVD video disc, so you may need to follow the instructions in the BD/DVD video disc manual or the instructions displayed on the screen.

#### Top menu

- With some BD/DVD discs, the top menu may be referred to as the "Title Menu". Use **TOP MENU/TITLE LIST** on the remote control when the instructions refer to "Title Menu".
- If no top menu is available, the **TOP MENU/TITLE LIST** button will have no effect.

## Using the disc menu

DVD VIDEO

**Example:** Select "SUBTITLE LANGUAGE".

- Press **TOP MENU/TITLE LIST**.
  - The disc menu screen is displayed if present on the DVD video disc.
- Press **▲/▼** to select "SUBTITLE LANGUAGE", then press **ENTER**.
  - The screen for selecting the subtitle language is displayed.

#### Example

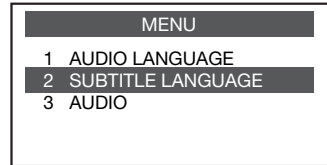

- Press **▲/▼** to select the subtitle language, then press **ENTER**.
- Press **TOP MENU/TITLE LIST** to exit.

## Using the pop-up menu

BD VIDEO

- Press **POP-UP MENU** during playback.
  - The pop up menu screen is displayed.
  - The menu contents displayed vary depending on the disc. For details on how to see and operate the pop-up menu, refer to the manual for the disc.

#### Example

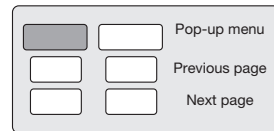

- Press **▲/▼/◀/▶** to select the desired item, then press **ENTER**.
- Press **POP-UP MENU** to exit.
  - The pop-up menu will automatically disappear for some discs.

## Enjoying BONUSVIEW or BD-LIVE

### BD VIDEO

This Player is compatible with additional functions of BD-Video, BONUSVIEW (BD-ROM Profile 1 Version 1.1) and BD-LIVE.

For BD-Video discs compatible with BONUSVIEW, the functions of Picture in Picture and Virtual Package are available. For BD-LIVE compatible discs, you can enjoy a variety of functions via the internet in addition to the BONUSVIEW functions.

Virtual Package/BD-LIVE data is saved in Local Storage (USB memory device connected to this Player). To enjoy these functions, connect a USB memory device (2GB or greater) supporting USB 2.0 High Speed (480Mbit/s) to the BD STORAGE/SERVICE terminal on the back of this player.

- When you insert or remove a USB memory device, be sure to turn the main power off.

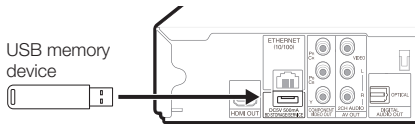

- If there is insufficient storage space, the data will not be copied/downloaded. Delete unneeded data or use a new USB memory device.
- If a USB memory device containing other data (previously recorded) is used, the video and audio may not play back properly.
- If the USB memory device is disconnected from this player during playback of Virtual Package/BD-LIVE data, playback of the disc will stop.
- Some time may be required for the data to load (read/write).
- Refer to "USB Memory Management" on page 44 for erasing the Virtual Package data and the BD-LIVE data in the USB memory device.

### NOTE

- SHARP cannot guarantee that all brands' USB memory devices will operate with this player.
- Only USB memory devices formatted with FAT 32/16 are compatible.

When formatting a USB memory device using a PC, perform the following settings.

Format File System: FAT32  
Allocation Unit Size: Default Allocation Size

- Do not use a USB extension cable when connecting a USB memory device to the BD STORAGE/SERVICE terminal of the player.
  - Using a USB extension cable may prevent the player from performing correctly.

## Use of Picture in Picture function (secondary audio/video playback)

BD-Video that includes secondary audio and video compatible with Picture in Picture can be played back with secondary audio and video simultaneously as a small video in the corner.

- 1 Press **PinP** during playback to show the 2-picture screen.



Primary audio/video

Secondary audio/video

- 2 To remove the secondary video, press **PinP** again.

### NOTE

- To listen to secondary audio, set the digital audio output setting (See "Audio Out" on page 40) according to the digital audio output format selection table on page 48.
- The secondary audio and video for Picture In Picture may automatically play back and be removed depending on the content. Also, playable areas may be restricted.

## Virtual Package

For BD-Video discs compatible with Virtual Package, data is copied from the discs or internet to local storage. It is automatically copied to the local storage prior to playback. You can enjoy a variety of additional functions including secondary video, secondary audio, subtitles, movie trailers, etc.

- The playback methods vary depending on the disc. For details, refer to the disc manual.

## BD-LIVE

In this Player, a variety of contents with interactive functions are available through BD-LIVE compatible Blu-ray discs by connecting to the internet. You can enjoy the download of bonus features such as latest movie trailers to the USB memory device, communication compatible BD-J interactive games, etc.

- The available functions differ depending on the disc.

### NOTE

- Regarding playback method of BD-LIVE contents, etc., perform the operations in accordance with the instructions in the BD disc manual.
- To enjoy BD-LIVE functions, perform the broadband internet connection (page 18) and communication settings (pages 42–43).
- Refer to page 41 regarding the setup to restrict access to BD-LIVE contents.
- If the BD-LIVE screen does not appear for a while after you select the BD-LIVE function in the BD disc menu, the USB memory device may not have enough free space. In such cases, eject the disc from the player, and then erase the data in the USB memory device in the "USB Memory Management" menu on page 44.



## DVD-R/-RW (VR format) / BD-RE/-R (BD-DAV format) Playback

**DVD-R** **DVD-RW** **BD-RE** **BD-R**

You can play back a recorded disc (DVD: VR format finalized disc only / BD: BDAV format disc only).

- For a description of other playback functions, refer to "Playback Functions" on pages 33–34.

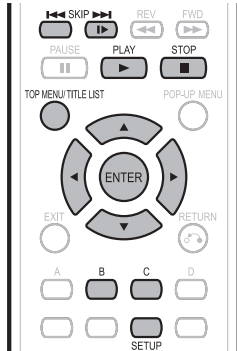

### NOTE

- "Finalize" refers to a recorder processing a recorded disc so that it will play in other DVD players/recorders as well as this player. Only finalized DVD discs will play back in this player. (This player does not have a function to finalize discs.)
- Some discs cannot be played back depending on the audio format.

## Playback by selecting a title

- Load a recorded disc.
  - The Title List screen is displayed.

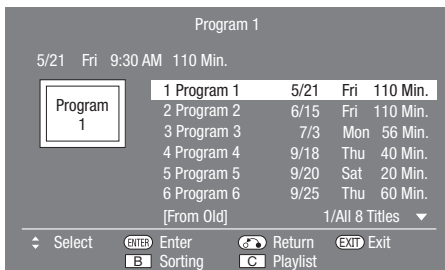

- If the Title List screen is not displayed, press **TOP MENU/TITLE LIST**.
- When loading a BD disc with usage restrictions placed by a BD recorder, the password input screen appears. Then, input your password. If you input a wrong password three times, the disc tray will open. Close the disc tray, and then input a correct password.

- Press **▲/▼** to select the desired title, then press **ENTER** to start playback.
  - If you want to select additional titles, switch pages by pressing **◀◀ SKIP** or **▶▶ SKIP/▶**.
  - You can playback by pressing **▶ PLAY** instead of pressing **ENTER**.
- Press **■ STOP** to stop playback.

### NOTE

- The Title List screen also can be displayed by pressing **TOP MENU/TITLE LIST** when playback is stopped.

## About Title List

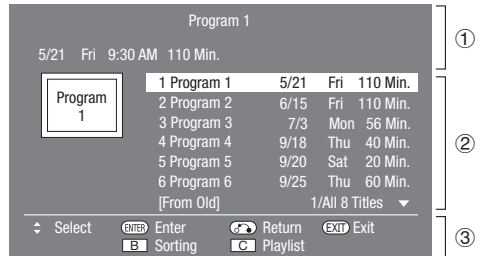

- Information of selected title
- Title Name  
Recording Date  
Recording Duration
- Button Guide

## Sorting the titles

Each time you press **B** (Green) while the Title List screen is displayed, the Title List display changes between displaying the newest title first and the oldest title first.

## Playback by selecting a Playlist

- Press **C** (Blue) while the Title List screen is displayed.
  - The Playlist screen is displayed.
- The Playlist screen is displayed. Press **▲/▼** to select the desired title, then press **ENTER** to start playback.
- Press **■ STOP** to stop playback.

## Audio CD Playback

### AUDIO CD

This Player can play back audio CDs.

- For a description of other playback functions, refer to "Playback Functions" on pages 33–34.

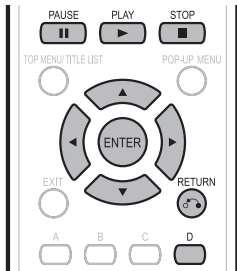

### Playback from the beginning

- Load an audio CD.
  - The CD screen is displayed. (The CD screen is displayed only when a compact disc recorded in the CD-DA format is inserted.)
  - Playback may begin automatically, depending on the disc.

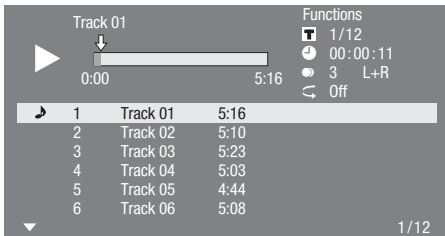

- Press **▶ PLAY** if playback does not begin automatically or playback is stopped.
- To pause the playback at any time, press **⏸ PAUSE**.
  - Press **⏸ PAUSE** or **▶ PLAY** to return to playback.
- Press **■ STOP** to stop playback.

### Playback by selecting a track

- Press **▲/▼** to select the track, then press **ENTER** during playback or when playback is stopped.
  - Playback of the selected track will begin.

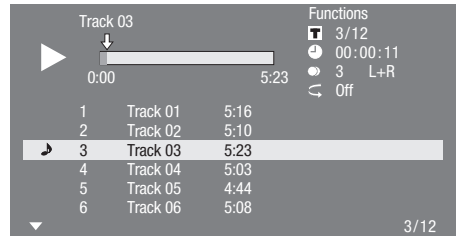

- Press **■ STOP** to stop playback.

### Operation procedure for the "Functions" menu

- Press **D (Yellow) (Functions)** when the CD screen is displayed.
  - The "Functions" menu is activated.

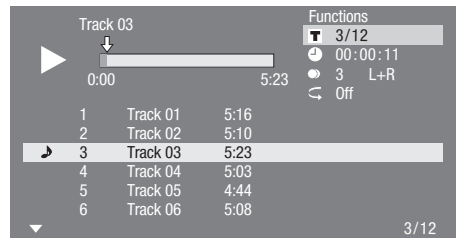

- Press **▲/▼** to select the desired setting, then press **ENTER**.
  - When playback is stopped, only "Track" can be selected.
  - For a description of each setting, see "Functions which can be set" (Page 37).
- Press **▲/▼/◀/▶** to set, then press **ENTER**.
  - Operations vary depending on the setting. Follow the operation instructions on the screen.
- Press **↻ RETURN** or **D (Yellow)** to exit the "Functions" menu.

### NOTE

- The displayed items vary depending on the disc.

## Audio Data (MP3 File) Playback

CD-R CD-RW DVD-R DVD-RW USB

This Player can play back audio data (MP3 files) recorded on CD-R/RW discs, DVD-R/RW discs and USB memory devices.

- For details on the audio data that you can play using this player, refer to page 7.

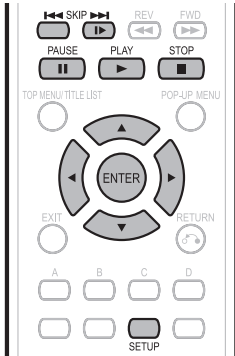

### Playing back Audio data (MP3 files)

When you insert or remove a USB memory device, be sure to turn the main power off.

- Load a disc or insert a USB memory device containing audio data (MP3 files), then press **SETUP** to display the Menu screen.
- Press **▲/▼** to select "Music", then press **▶** or **ENTER**.
- Press **▲/▼** to select "DVD/CD\*" or "USB Memory Device", then press **▶** or **ENTER**.
  - \* Display name varies depending on the type of media inserted.
  - If only a "DVD/CD" or a USB memory device is inserted, the "DVD/CD" or "USB Memory Device" selection screen does not appear. In such cases, after step 2, proceed to step 4.
- Press **▲/▼** to select a folder or file.
  - When you select a folder, press **ENTER** to open it, and then press **▲/▼** to select a file in the folder.

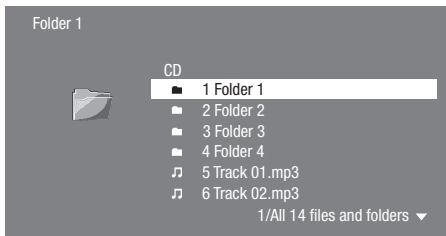

- Press **ENTER** to play back the selected file.
  - Playback of the selected file will begin.

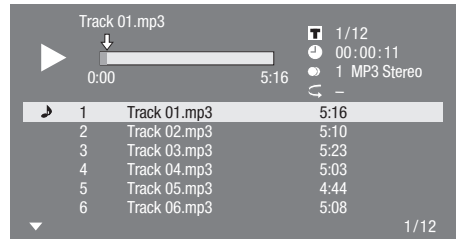

- When MP3 files are played, the "Functions" menu is not available.
- To pause the playback at any time, press **|| PAUSE**.
    - Press **|| PAUSE** or **▶ PLAY** to return to playback.
  - Press **■ STOP** to stop playback.

### To play another file during Playback

Press **▲/▼** to select the file you want to play, then press **ENTER**.

- The chosen file will be played.

### To skip the file during Playback

Press **◀◀◀ SKIP** or **▶▶▶ SKIP/I▶**.

- Press **◀◀◀ SKIP** to skip backward.
- Press **▶▶▶ SKIP/I▶** to skip forward.

### NOTE

- The Fast Forward/Reverse function does not work.
- The Repeat function does not work.

## Displaying Still Images (JPEG files)

CD-R CD-RW DVD-R DVD-RW USB

This Player can display still images (JPEG files) recorded on CD-R/RW discs, DVD-R/RW discs and USB memory devices.

- For details on the still images that you can display using this player, refer to page 7.
- Still images are played one by one while during "Slide show", they are automatically replaced one after another.

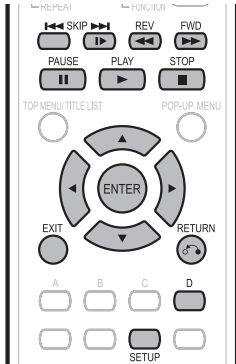

- 5 Press **ENTER** to display the selected file.
  - The selected still image appears on the screen.



- 6 Press **SKIP** or **SKIP/▶** to replace one image with another.
  - The same operation can be performed by pressing **REV/▶ FWD**.
  - Press **RETURN** if you wish to return to the selection screen.
- 7 To stop the still image display at any time, press **STOP**.

## Playing back Slide Show

- 1 To play back Slide Show, in Step 6 of the "Displaying Still Images (JPEG files)", press **PLAY** (Slide Show).
  - The still images inside the selected folder are played as a slide show.
- 2 To pause the playback at any time, press **PAUSE**.
  - Press **PLAY** to return to playback of a slide show.
- 3 To stop the playback at any time, press **STOP**.

## Displaying Still Images (JPEG files)

When you insert or remove a USB memory device, be sure to turn the main power off.

- 1 Load a disc or insert a USB memory device containing Still Images (JPEG files), then press **SETUP** to display the Menu screen.
- 2 Press **▲/▼** to select "Picture", then press **▶** or **ENTER**.
- 3 Press **▲/▼** to select "DVD/CD\*" or "USB Memory Device", then press **▶** or **ENTER**.
  - \* Display name varies depending on the type of media inserted.
  - If only a "DVD/CD" or a USB memory device is inserted, the "DVD/CD" or "USB Memory Device" selection screen does not appear. In such cases, after step 2, proceed to step 4.
- 4 Press **▲/▼** to select a folder or file.
  - When you select a folder, press **ENTER** to open it, and then press **▲/▼** to select a file in the folder.

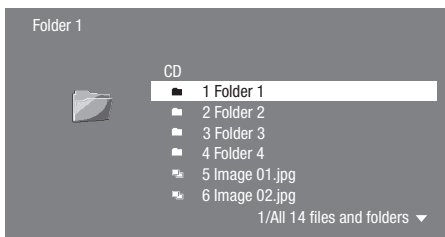

## Setting slide show speed/repeat playback

- 1 Press **D** (Yellow) (Slide Show Menu) while the selection screen is displayed.
  - The setting screen for "Slide Show Speed"/"Repeat Mode Setting" appears.
- 2 Press **▲/▼** to select "Slide Show Speed", then press **▶** or **ENTER**.
- 3 Press **▲/▼** to select the desired speed, then press **ENTER**.
  - The slide show speed may be selected from "Fast", "Normal", "Slow1" and "Slow2".
- 4 Press **▲/▼** to select "Repeat Mode Setting", then press **▶** or **ENTER**.
- 5 Press **▲/▼** to select the desired item, then press **ENTER**.
  - The desired item may be selected from "Yes" or "No".
- 6 Press **EXIT** to exit.



## Instantly Watching Movies from Netflix

Please check that the most current software is loaded on this player by using the software update function (See pages 45–47) or by visiting <http://www.sharppusa.com/products/support/> to check for a download of the newest software version.

This function allows you to enjoy Netflix through the Internet.

Netflix is an online DVD and Blu-ray Disc rental service, offering rental-by mail and streaming instantly to Netflix unlimited members.

- To enjoy this function, make a broadband Internet connection to both your PC and this player (See page 18), and then set communication settings (See pages 42–43), then perform the following operation.
- Before using this function, please read “Network Service Disclaimer” (page 56).

### NOTE

- Disc playback and this function cannot be used at the same time.
- As the registration process takes time, we recommend setting “Auto Power Off” to “No” before starting the registration. (See page 40.)
- The streaming quality (SD or HD) depends on the network speed and original bit rate of the title.
- For more information on Netflix visit <http://www.netflix.com/help> or login to your Netflix account and click “Help” at the top of the page.
- Netflix is only available in the US.
- Illustrations are examples and may differ from the actual Netflix screens.

### The buttons which can be used :

▲/▼/◀/▶ / ENTER / ► PLAY / || PAUSE / ■ STOP / ◀◀ REV / ▶▶ FWD / EXIT

### Settings for watching Netflix content on your TV

- 1 Press **SETUP** to display the Menu screen.
  - The same operation can be performed by pressing **ENTER** after selecting the MENU icon on the Wall Paper screen.
- 2 Press ▲/▼ to select “e-Contents”, then press ▶ or **ENTER**.

#### The screen of this player shown on the TV



- 3 Press ▲/▼ to select “Netflix”, then press ▶ or **ENTER**.

- 4 Read the Disclaimer displayed on the screen. If you agree, press ▲ on the last page to select “Agree”, then press **ENTER**.  
(If you do not agree, this service cannot be used.)
- 5 Obtain the Netflix activation code.

### If you don't have a Netflix account

- ① Press ▲/▼ to select “no-start my FREE trial”, then press **ENTER**.

#### The screen of this player shown on the TV



- ② Subscribe by visiting <http://www.netflix.com/sharp> from your PC.
- ③ Press ▲/▼ to select “I'm now a member”, then press **ENTER**.

#### The screen of this player shown on the TV



### If you have a Netflix account

Press ▲/▼ to select “yes-activate instant streaming from Netflix”, then press **ENTER**.

#### The screen of this player shown on the TV



## Video/Picture/Music Playback

- 6 You will see the following window.
- The activation code is displayed.

The screen of this player shown on the TV



- 7 Using your PC, visit <http://www.netflix.com/activate>, and then enter the activation code displayed in step 6.

The screen of the PC

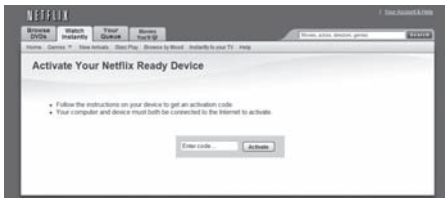

- After a period of time, the player will be activated, and the empty instant Queue screen will be displayed on your TV from the player.

### Adding content to the Instant Queue

- 8 To add a movie to the instant Queue of this player, select the "Add to Instant" button on Netflix "Watch Instantly" web page using your PC.
- After a period of time, the instant Queue registered using your PC will appear on your TV screen.

### Playing back content in the Instant Queue on your TV

- 9 Press **◀▶** to select the desired title, then press **ENTER**.
- Once this function is set and the registration is completed, the next time this service is used instant Queue screens such as the following can be displayed directly by pressing **ENTER** after selecting the NETFLIX icon on the Wall Paper screen.

The screen of this player shown on the TV

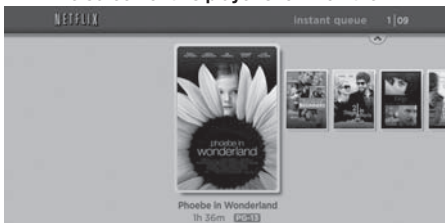

- 10 The title you selected is displayed.

- To return to the step 9, press **▲**.

Press **▲/▼** to select "play", then press **ENTER** or **▶ PLAY** to start playback.

The screen of this player shown on the TV

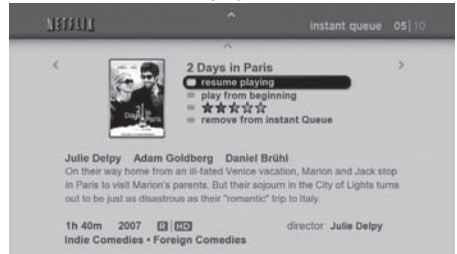

The screen of this player shown on the TV

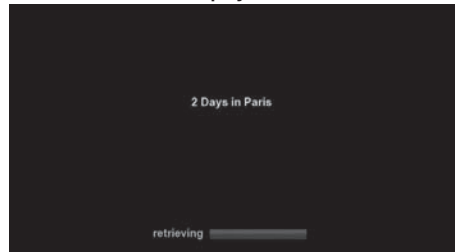

- After a period of time, playback of the movie begins.

- 11 To pause the playback at any time, press **|| PAUSE**.
- Press **|| PAUSE** or **▶ PLAY** to return to playback.
- 12 To stop the playback or go to step 10, press **▲** or **■ STOP**.
- 13 Press **EXIT** to exit.

### Fast Forward/Reverse

The Fast Forward/Reverse function is enabled when **◀◀ REV** or **▶▶ FWD** is pressed during playback.

# Playback Functions

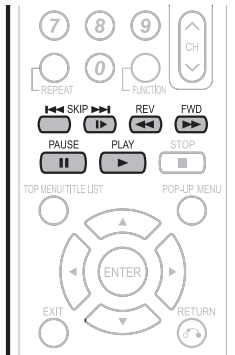

## NOTE

- Some operations in the following playback functions cannot be performed depending on the specifications of the disc.

## Fast Forward/Reverse (Search)

BD VIDEO BD-R BD-RE  
DVD VIDEO DVD-R DVD-RW  
AUDIO CD

The Fast Forward/Reverse function is enabled when **REV** or **FWD** is pressed during playback.

**Example:** When **FWD** is pressed

- The search speed will change each time you press the button.

### When playing back a DVD

- You cannot perform Fast Forward/Fast Reverse from one title and continue to another title (except when playing audio CDs). At the end or beginning of the title, Fast Forward/Fast Reverse will be cancelled and normal playback will automatically resume.

## NOTE

- Subtitles are not played back with BD/DVD video discs during Fast Forward and Fast Reverse.

## Skipping to the Next or the Start of the Current Chapter (Track/Title)

BD VIDEO BD-R BD-RE  
DVD VIDEO DVD-R DVD-RW  
AUDIO CD CD-R CD-RW USB

The Skipping (to the beginning of a chapter, track or title) function is enabled when **SKIP** or **SKIP/▶** is pressed during playback.

## Pause/Frame Advance Playback

BD VIDEO BD-R BD-RE  
DVD VIDEO DVD-R DVD-RW

The Pause function is enabled when **PAUSE** is pressed during playback. (If you are playing back an audio CD, audio data [MP3 files] or still images [JPEG files], these will also pause.)

The Frame Advance Playback function is enabled when

**SKIP/▶** is pressed during pause.

- Frame Advance Playback may not function properly with discs other than DVD-RW/R (VR format).

## NOTE

- Some BD/DVD Video discs are not compatible with Pause/Frame Advance Playback.
- Frame Reverse Playback cannot be performed with this player.

## Slow Playback

BD VIDEO BD-R BD-RE  
DVD VIDEO DVD-R DVD-RW

The Slow Playback function is enabled when

**SKIP/▶** is pressed for more than 2 seconds during pause.

- Press **PLAY** to return to normal playback.

## NOTE

- This doesn't work for audio CDs.
- You cannot perform Slow Playback between titles. At the end of the title, Slow Playback will be cancelled and normal playback will automatically resume.
- Reverse Slow Playback cannot be performed with this player.

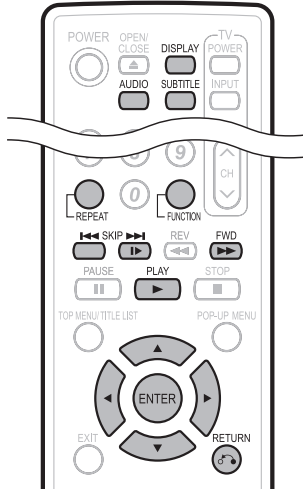

## NOTE

- Some operations in the following playback functions cannot be performed depending on the specifications of the disc.

## Repeat Playback of a Title or Chapter (Repeat Playback)

BD VIDEO | BD-R | BD-RE

DVD VIDEO | DVD-R | DVD-RW

AUDIO CD

- 1 Play back the title or chapter you want to repeat.
- 2 Press **REPEAT**.
- 3 Press **▲/▼** to select the type of Repeat Playback.
  - Playback Title: Repeats the title currently being played back.
  - Playback Chapter: Repeats the chapter currently being played back.
  - Scene Selection: Repeats the specified scene of title or chapter.

Playback Title

Playback Chapter

Scene Selection

- Press **RETURN** to cancel without setting the type of Repeat Playback.
- For Audio CD, you can select "Playing Disc", "Playing Track" and "Specify The Part" as Repeat Playback options.

- 4 Press **ENTER**.

**Example:** Repeat playback of a title (TITLE)

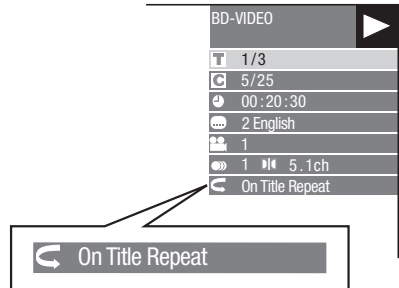

- 5 Press **REPEAT** to return to normal playback.

## NOTE

- "Scene Selection" operation is not available for BD video.

## Partial Repeat Playback (Repeat Playback of a Specified Part)

DVD VIDEO | DVD-R | DVD-RW

AUDIO CD

- 1 Press **REPEAT** during playback.
- 2 Press **▲/▼** to select "Scene Selection", then press **ENTER**.
  - "Set Start Point" displays.

Playback Title

Playback Chapter

Scene Selection

Set Start Point

- 3 Press **ENTER** at the scene where you want to set the start point.
  - "Set End Point" displays.
- 4 Press **ENTER** at the scene where you want to set the end point.
  - You can press **▶▶ FWD** to fast forward to the scene where you want to set the end point. When you reach the desired scene, simply press **▶ PLAY** and then **ENTER** to set the end point. To cancel Repeat Playback, press **REPEAT**.

## NOTE

- Press **▶▶▶ SKIP/▶▶**, the Repeat Playback is cancelled and the next chapter being play back.
- Press **◀◀◀ SKIP** once, the Repeat Playback is cancelled and the player returns to the start of current chapter (track).
- If you press **◀◀◀ SKIP** again (within about 5 seconds) the player will skip to the beginning of the previous chapter (track).
- For Partial Repeat Playback, set the start and end points within the same title.
- Repeat Playback may be forbidden depending on the disc.
- Partial Repeat Playback may not work in multi-angle scenes.
- If you press **DISPLAY**, you can confirm the Repeat Playback status.

## Displaying the Audio Information

You can display the audio information on the disc currently being played back by pressing **AUDIO**.

- The displayed contents vary depending on the disc.

**BD VIDEO** **DVD VIDEO**

The audio channel currently being played back will be displayed.

If multiple audio channels are recorded, you can switch the audio channel by pressing **AUDIO**.

**DVD-RW** **DVD-R**

### When a recorded broadcast with stereo or monaural audio is played back:

"Stereo" is displayed. (Audio cannot be switched.)

#### NOTE

- When you play a program recorded in stereo or monaural, and if you are listening to the Bitstream sound via the digital output jack, you cannot select the audio channel. Set the digital audio output setting to "PCM" (page 40) or listen via the analog output jacks if you want to change the audio channel.
- Settings for audio can also be changed in the Function Control screen (Page 36).
- The operation of audio differs according to each disc. You may need to refer to the operation manual of the disc.
- The display for audio information automatically disappears after 5 seconds.

## Switching Subtitles

**BD VIDEO** **DVD VIDEO**

If subtitles are provided in multiple languages, you can switch between them.

Press **SUBTITLE** during playback.

- The display indicates the subtitle number currently being played back, and the subtitles appear. Each time **SUBTITLE** is pressed, the subtitles change.
- "—" is displayed if a disc has no subtitles.
- You can also select "Off".

#### NOTE

- Settings for subtitles can also be changed in the Function Control screen (Page 36).
- The operation of subtitles differs according to each disc. You may need to refer to the operation manual of the disc.
- The display for subtitle information automatically disappears after 5 seconds.

## Switching the Angle

**BD VIDEO** **DVD VIDEO**

If multiple angles are recorded, you can switch between them.

- 1 Press **FUNCTION** during playback.
  - The Function Control screen is displayed on the TV.
- 2 Press **▲/▼** to select the Angle Number column, then press **ENTER**.

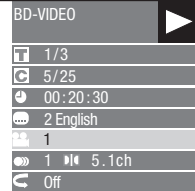

- 3 Press **▲/▼** to select the desired Angle Number, then press **ENTER**.
  - "—" is displayed if a disc is recorded with only one angle.
- 4 Press **↶** **RETURN** or **FUNCTION** to close the Function Control screen.

#### NOTE

- The displayed items vary depending on the disc.
- If you access the Function Control screen during playback of a BD/DVD video, it may be impossible to operate the BD/DVD video playback. In cases like this, close the Function Control screen.
- The operation of angles differs according to each disc. You may need to refer to the operation manual of the disc.
- The display for angle information automatically disappears after 5 seconds.

## Displaying the Angle Mark

**BD VIDEO** **DVD VIDEO**

You can change settings so that Angle Mark appears in the right bottom part of the screen when multiple angles are recorded. The settings can be changed in "Settings" – "Playback Setting" – "Angle Mark Display" (Page 41).

# Settings During Playback

## Function Control

BD VIDEO | BD-R | BD-RE

DVD VIDEO | DVD-R | DVD-RW

AUDIO CD

This allows you to adjust various settings at once, like subtitles, angle settings and the title selection for Direct Playback. You can adjust the video and audio to suit your preferences. The operations are the same for BD and DVD.

### Function Control screen

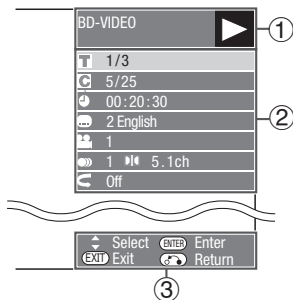

#### ① Playback status display

Shows the operation status and the disc type.

#### ② Setting items

Selects a title (or track) or chapter for playback, or performs video/audio settings.

- Title/Track Number (Direct Title/Track Skip)
- Chapter Number (Direct Chapter Skip)
- Playback Elapsed Time (Direct Time Skip)
- Subtitle Language
- Angle Number
- Audio
- Repeat

#### ③ Operation guide display

Provides help on remote control button operations.

## Function control operation procedure

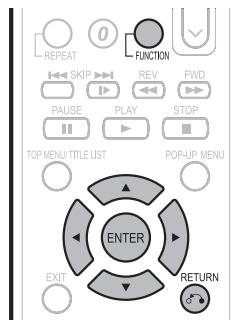

- 1 Press **FUNCTION** during playback.
  - The Function Control screen is displayed on the TV.
- 2 Press **▲/▼** to select the desired setting, then press **ENTER**.
  - For a description of each setting, see "Functions which can be set" (Page 37).

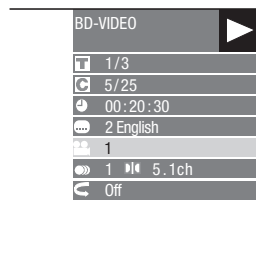

- 3 Press **▲/▼/◀/▶** to set, then press **ENTER**.
  - Operations vary depending on the setting. Follow the operation instructions on the screen.
- 4 Press **RETURN** or **FUNCTION** to close the Function Control screen.

#### NOTE

- If "--" is displayed for an option like title number or subtitles, the disc has no titles or subtitles which can be selected.
- The displayed items vary depending on the disc.
- If you access the Function Control screen during playback of a BD/DVD video, it may be impossible to operate the BD/DVD video playback. In cases like this, close the Function Control screen.

## Functions which can be set

### **T** Title/Track Number (Direct Title/Track Skip)

- Shows the title number being played back (or track number when playing back an audio CD). You can skip to the start of the title (or track).
- To skip to the start of a selected title (or track), press the **Number** buttons to enter the title (or track) number when this option is highlighted.

### **C** Chapter Number (Direct Chapter Skip)

- Shows the chapter number being played back. You can skip to the start of the chapter.
- To skip to the start of a selected chapter, press the **Number** buttons to enter the chapter number when this option is highlighted.

### **⏸** Playback Elapsed Time (Direct Time Skip)

- Shows the time elapsed from the beginning of the current disc title (or track). This lets you skip to a specific time.
- Press **◀/▶** to select the Hour, Minute or Second, then press **▲/▼** or the **Number** buttons to set the time. Press **ENTER** to start playback at the set time.

### **⋮** Subtitle Language

- Shows the currently selected subtitle language. If subtitles are provided in other languages, you can switch to your preferred language.

### **👤** Angle Number

- Shows the currently selected angle number. If the video is recorded with multiple angles, you can switch the angle.

### **🔊** Audio

- Shows the currently selected type of audio. You can select the desired type of audio.

### **↺** Repeat

- The current Title (or Chapter) or partial segments can be repeatedly played back. Repeat Playback is also possible with the **REPEAT** button on the remote control.

### **📖** NOTE

- These functions may not work with all discs.



# SETTINGS

## Common operations

The "Menu" enables various audio/visual settings and adjustments on the functions using the remote control unit. You need to call up the On Screen Display to perform settings for this player. The following is the explanation for the basic operations of the "Menu".

**Example:** Setting "AQUOS LINK"

### 1 Display the Menu screen

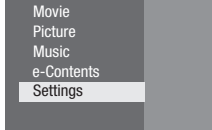

Press **SETUP** to display the Menu screen.

- The same operation can be performed by pressing **ENTER** after selecting the MENU icon on the Wall Paper screen.
- Press **▲/▼** to select "Settings", then press **▶** or **ENTER**.

### 3 Select the next item

Press **▲/▼** to select the desired item, then press **ENTER**.

Press **RETURN** to return to the previous "Menu" page.

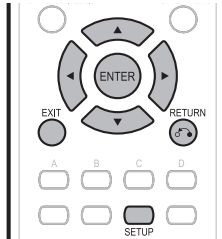

### 2 Select a menu item

Press **▲/▼** to select "AQUOS LINK", then press **▶** or **ENTER**.

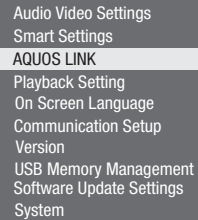

### 4 Exit the Menu screen

Press **SETUP** or **EXIT** to exit.

## Basic Operation for Playback Setting

**Example:** Setting "Parental Control" under "Playback Setting"

- Press **SETUP** to display the Menu screen.
  - The same operation can be performed by pressing **ENTER** after selecting the MENU icon on the Wall Paper screen.
- Press **▲/▼** to select "Settings", then press **▶** or **ENTER**.
- Press **▲/▼** to select "Playback Setting", then press **▶** or **ENTER**.
- Press **▲/▼** to select "Parental Control", then press **▶** or **ENTER**.
  - When you operate this Player for the first time, the password setting screen will be displayed. See "When setting the password for the first time" below.
- Enter your 4-digit password.
  - You cannot move to the next setting screen until you can input the correct password.

**When setting the password for the first time.**

- To set the password for the first time, press **▲/▼** to select "Yes" to enter the password setting menu, then press **▶** or **ENTER**.

- Enter a 4-digit number for the password, then the same 4-digit number for confirmation.
- Press **ENTER** to complete the password setting procedure and move to the next setting screen.
- Press **◀/▶** to select the parental control level for DVD VIDEO/BD-ROM, and then select the country code. Press **ENTER** after making each selection.

**Example:** when the selected parental control is "8"

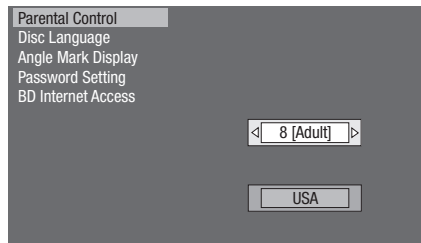

- Press **SETUP** or **EXIT** to exit.



# SETTINGS

## Audio Video Settings

### TV Aspect Ratio

You can set the screen aspect ratio of the connected TV, and adjust the video output.

If you switch your TV (i.e. because you have bought a new one) and the screen aspect ratio of the connected TV changes, you will have to change the "TV Aspect Ratio" setting.

#### Item

Wide 16:9: Select this when connecting to a TV with a 16:9 screen aspect ratio.

Normal 4:3: Select this when connecting to a TV with a 4:3 screen aspect ratio.

### <When selecting Normal 4:3>

#### Item

Letter Box: If you connect to a TV with a screen aspect ratio of 4:3 and playback a DVD with 16:9 video, the video will be played back with black bands at the top and bottom while maintaining the 16:9 ratio.

Pan Scan: If you connect to a TV with a screen aspect ratio of 4:3 and playback a DVD with 16:9 video, the video will be played back with the left and right sides of the image cut off to display in 4:3 screen aspect ratio. (This function works if the disc is labelled for 4:3PS.)

### Component Video Out

This sets the resolution of the component video output.

Some TVs are not fully compatible with the Blu-ray disc player, which may cause the image distortion. In this case, press **VIDEO OUTPUT RESET** on the remote control for five seconds. "Component Video Out" will be reset to "480i" (factory preset value).

#### Item

1080i, 720p, 480p, 480i

### HDMI Video Out

This sets the resolution of the HDMI video output. Some TVs are not fully compatible with the Blu-ray disc player, which may cause the image distortion. In this case, press **VIDEO OUTPUT RESET** on the remote control for five seconds. "HDMI Video Out" will be reset to "Auto" (factory preset value).

#### Item

Auto, 1080p, 1080i, 720p, 480p

### NOTE

- When the BD player is connected to a 1080p 24Hz compatible TV and the "HDMI Video Out" is set to "Auto", 1080p 24Hz will automatically be displayed when compatible discs are played back. At 1080p 24Hz/1080p 60Hz, there is no output from the COMPONENT VIDEO OUT jacks and VIDEO output jack.

### Video Out Select

Dual video output is possible simultaneously from the COMPONENT VIDEO OUT jacks and the HDMI OUT terminal with the following settings. Select the video output which you want to have priority according to the following chart.

### NOTE

- 1080p and AQUOS LINK are only available in HDMI.

Video Out Select	Dual Output	HDMI Video Out	Component Out Resolution in Dual Mode
HDMI	No	Auto	*1
	No	1080p	No
	Yes	1080i	1080i
	Yes	720p	720p
	Yes	480p	480p
Component	Dual Output	Component Video Out	HDMI Out Resolution in Dual Mode
	Yes	1080i	1080i
	Yes	720p	720p
	Yes	480p	480p
	Yes	480i	480i

\*1 Depends on source. 1080p is not available.

#### Item

HDMI, Component

- When the priority video output is selected, video is output from the other video terminal with the resolution of the selected video output.
- There is no output from the COMPONENT VIDEO OUT jacks and VIDEO output jack when video is output at 1080p resolution and the priority video output is selected to "HDMI".
- If the video equipment connected to each of the terminals is not compatible with the resolution of the priority video output, abnormalities in images on the screen may appear.

# SETTINGS

## Audio Out

This lets you set the digital audio output format according to the capabilities of the connected audio equipment.

- To listen to the secondary audio of Blu-ray discs, select "PCM" or "Bitstream (Mix)".
- For details, refer to the digital audio output format selection table on page 48.

### Item

PCM, Bitstream (Mix), Bitstream

### NOTE

- Make sure to select a compatible digital audio output format, otherwise you will hear no sound or a garbled noise.
- If the HDMI device (Receiver, TV) is not compatible with compressed formats (Dolby digital, DTS), the audio signal outputs as PCM.
- Secondary and Effect audio is not present on DVD video.
- This setting has no effect on the analog (L/R) audio or HDMI audio output to your TV. It is only valid for the optical and HDMI audio output to a receiver.
- If you play MPEG audio soundtracks, the audio signal format will be PCM regardless of digital audio output format selection (PCM or Bitstream).

## Dynamic Range Control

This lets you adjust the range between the loudest and softest sounds (dynamic range) for playback at average volume. Use this when it is hard to hear dialog.

### Item

Normal: The same audio output range is played as the original recorded audio output range.  
Shift\*: When Dolby Digital audio is played back, the dynamic range of the audio is adjusted so that the dialog portion can be heard easily. (If the audio sounds abnormal, set to "Normal".)  
Auto: When you play back audio in the Dolby TrueHD format, the dynamic range is automatically adjusted.

\* Lower the audio volume before setting. If you do not do so, the speakers may emit a loud sound or excessive output may be applied to the speakers.

## Smart Settings

### Auto Power Off

This sets the Player so that power is automatically shut off if playback is stopped for about 10 minutes.

#### Item

Yes, No

### Front Display/LED

If you feel that the indicators on the player's front display are too bright when watching movies, you can turn them off except for the ON/STANDBY indicator.

#### Item

On, Off

### Control Panel

This lets you set display of the control panel on the TV screen to on or off.

#### Item

Yes, No

## AQUOS LINK

This lets you set the Player to receive the control signal from the AQUOS LINK remote control via the HDMI cable.

#### Item

Yes, No

### NOTE

- For details, refer to the operation manual of TV.
- If "Component" is selected from the "Video Out Select" menu, AQUOS LINK is not available. Select "HDMI" if you want to use AQUOS LINK features.

# SETTINGS

## Playback Setting

### Parental Control

This lets you set the Parental Control for BD-ROM/DVD-video depending on the disc content. The available Parental Control Levels are shown below. The 4-digit password number needs to be entered before the Parental Control Levels and the Country Code are set. The Parental Control Levels and the Country Code cannot be set if a password has not been created or the password is not entered.

- Select the rating level appropriate for the age of the user.

#### Item (Parental control level)

8 and off: All BD-video/DVD-video can be played.  
1-7: Prohibits play of BD-video/DVD-video with corresponding ratings recorded on them.

#### Item (Country code)

Select the country code.

- The ratings differ according to the country.

#### NOTE

- Refer to "Basic Operation for Playback Setting" on page 38 for details.

### Disc Language (Disc Priority Language)

This lets you select the language for subtitles, audio and menus displayed on the screen.

#### Item (Subtitle)

Select the language you want to display.

#### Item (Audio)

Select the language you want to hear.

#### Item (Menu)

Select the language you want to display.

### Angle Mark Display

This lets you turn the Angle Mark Display on or off when BD/DVD video recorded with multiple angles is played back. (The Angle Mark is displayed in the lower right screen.)

#### Item

Yes, No

### Password Setting

This sets the password for setting or changing the Parental Control Level.

#### Item

Yes: Enter the 4-digit number.  
No

#### NOTE

- When you forget the password, you can reset the current password using "System Reset" under "Settings". (See below.)
- You can also set the new password if desired.

### BD Internet Access

This allows you to set access restriction to BD-LIVE contents.

#### Item

Permit: Allows all BD-LIVE discs.  
Limit: Allows only discs with owner certification.  
Prohibit: Prohibits all BD-LIVE discs.

#### NOTE

- The available functions differ depending on the disc.
- Regarding playback method of BD-LIVE contents, etc., perform the operations in accordance with the instructions in the BD disc manual.
- To enjoy BD-LIVE functions, perform the broadband internet connection (page 18) and communication settings (pages 42-43).

### On Screen Language

You can set the language you want to display on the screen.

#### Item

English, Español, Français

### Version

When you select "Version" the system software version and Netflix ESN are displayed.

### System

#### System Reset

You can reset all settings to the factory presets.

#### Item

Reset, Not Reset

#### Netflix Deactivate

You can deactivate your Netflix information on the player.

#### Item

Yes, No

## Communication Setup

This allows you to perform and/or change the communication setting. This setting is required to use BD-LIVE functions, Netflix and software updates that connect to the internet.

**NOTE**

- Make sure that the LAN cable is connected to this Player. (See page 18.)
- For manually performing the setting, the following information of the connected router or modem is required. Confirm the information prior to the setting.
  - IP address, netmask, gateway, DNS address
- This player cannot be connected to a network when a proxy server is used.

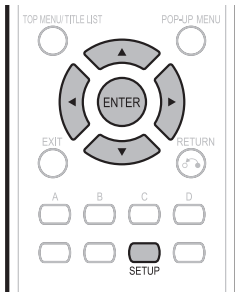

- 1 Press **SETUP** to display the Menu screen.
- 2 Press **▲/▼** to select “Settings”, then press **▶** or **ENTER**.
- 3 Press **▲/▼** to select “Communication Setup”, then press **▶** or **ENTER**.
- 4 Press **ENTER**, then press **▲/▼** to select “Change”, and then press **ENTER** again.

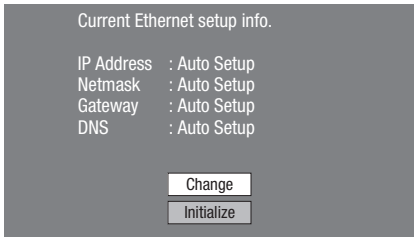

- For initializing the current setting, select “Initialize”, then press **ENTER**.

- 5 For setting the IP address, press **◀/▶** to select “Yes” or “No”, then press **ENTER**.

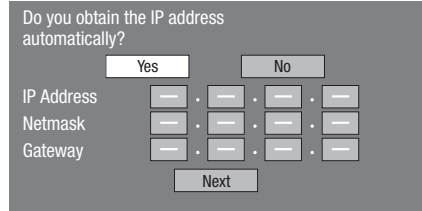

- If selecting “Yes”: The IP address is automatically obtained.
- If selecting “No”: The IP address, netmask and gateway are manually entered using the screen for inputting characters. (See page 43.) Regarding each of the setup values, confirm the specifications of your broadband router.

- 6 Select “Next”, then press **ENTER**.

- If selecting “Yes” in the step 5, go to the step 9.

- 7 Enter your DNS address.



- The primary and secondary DNS addresses are entered using the screen for inputting characters. (See page 43.) Regarding each of the setup values, confirm the specifications of your broadband router.

- 8 Select “Next”, then press **ENTER**.

- 9 For testing the connection to the internet, after confirming the settings, press **▲/▼** to select “Test”, then press **ENTER**.

- “Test” is available only when setting to obtain the IP address automatically. “Test” cannot be selected if the IP address has not been obtained automatically.

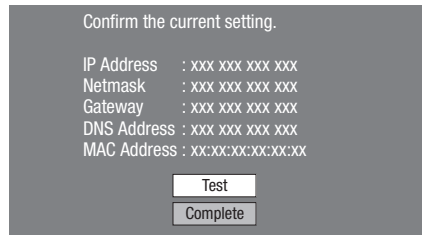

- As a result of the test, if the internet connection fails, enter the setup values manually.

- 10 Press **▲/▼** to select “Complete”, then press **ENTER**.

## The operation procedure for inputting characters manually

**NOTE**

- Numeric characters such as IP address can be entered on the input screen either by selecting each of the characters in the "Numeric" mode or using the **Number** buttons on the remote control.

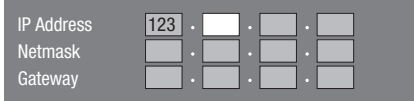

- Press **ENTER** at the boxes in which characters are to be entered, and the input screen will appear.

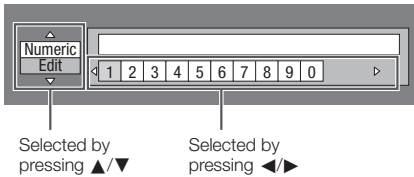

- Press **▲/▼** to select the desired input mode.
- Press **◀/▶** to select a number/character, then press **ENTER**.

- Repeat the step 3 to display all of the desired characters/numbers in the input field.

**Example:** The screen for inputting numeric characters

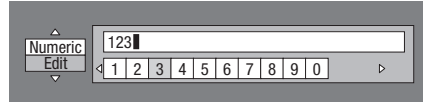

**NOTE**

- Press **RETURN** (Del.Char.) to delete a number/character you have input.
- To change a number/character you have input, press **B** (Green) (Left) or **C** (Blue) (Right) to select the number/character you want to change, and press **RETURN** (Del.Char.). Then, press **◀/▶** to select a new number/character you want to input, and press **ENTER**.

- Press **D** (Yellow) (Complete) to fix the numbers which have been input.

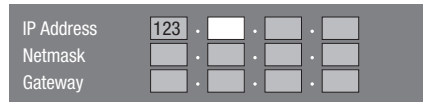

- Repeat step 1 to 5 to finish inputting all the required characters.

### Input character list

Numeric	<table border="1" style="width: 100%;"> <tr> <td style="width: 20%;"></td> <td style="width: 20%;">1 2 3 4 5 6 7 8 9 0</td> <td style="width: 20%;"></td> <td style="width: 20%;"></td> <td style="width: 20%;"></td> </tr> </table>						1 2 3 4 5 6 7 8 9 0			
	1 2 3 4 5 6 7 8 9 0									
Edit	<table border="1" style="width: 100%;"> <tr> <td style="width: 20%;">Cancel</td> <td style="width: 20%;">Left</td> <td style="width: 20%;">Right</td> <td style="width: 20%;">Complete</td> <td style="width: 20%;">Del.Char.</td> </tr> </table> <p>* The same operation as the colored buttons and <b>RETURN</b> can be performed by selecting each of the items and pressing <b>ENTER</b>.          "Del.Char." stands for deleting characters.</p>					Cancel	Left	Right	Complete	Del.Char.
Cancel	Left	Right	Complete	Del.Char.						

# SETTINGS

## Before using the USB memory device

### CAUTION:

- Do not remove the USB memory device or unplug the AC cord while the operations for "USB Memory Management" or "Software Update (Manual Update from USB memory device)" are being performed.
- Do not use a USB extension cable when connecting a USB memory device to the BD STORAGE/SERVICE terminal of the player.
  - Using a USB extension cable may prevent the player from performing correctly.

### NOTE:

- SHARP cannot guarantee that all brands' USB memory devices will operate with this player.
- Only USB memory devices formatted with FAT 32/16 are compatible.  
When formatting a USB memory device using a PC, perform the following settings.  
Format File System: FAT32  
Allocation Unit Size: Default Allocation Size

## USB Memory Management

The following instructions explain how to delete data such as the Virtual Package data and the BD-LIVE data in a USB memory device.

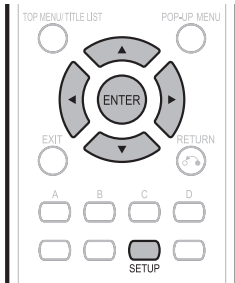

When you insert or remove a USB memory device, be sure to turn the main power off.

- 1 Insert the USB memory device into the BD STORAGE/SERVICE terminal on rear of this player.

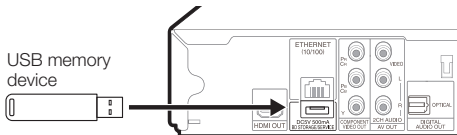

- 2 Press **SETUP** to display the Menu screen.
- 3 Press **▲/▼** to select "Settings", then press **▶** or **ENTER**.
- 4 Press **▲/▼** to select "USB Memory Management", then press **▶** or **ENTER**.
  - The "USB Memory Management" screen is displayed.
  - "No USB Memory" appears when no USB memory is inserted.
- 5 Press **▶** or **ENTER** to proceed.

Erase: Deletes only BD-VIDEO data written on the USB memory device such as BD-LIVE data.

- If you want to delete all of the data or delete only the unneeded software update data after the software is updated, delete the data on the USB memory device using a PC.
- 6 Press **▲/▼** to select "Yes", then press **ENTER**.
  - 7 Start the process.
    - The screen for the current operation will display.

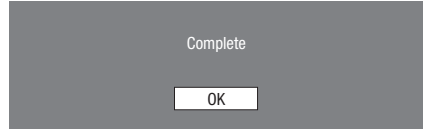

- 8 Press **ENTER**.

### NOTE

- Data which has been saved to the player's internal memory (game score, etc.) will also be deleted.

## Software Update Settings

In this player, the software version can be updated using either one of the following methods.

- Manual Update from Network
- Manual Update from USB memory device

### Manual Update from Network

This function allows you to perform the update operation by accessing an internet connection manually to check if there is a new firmware version.

**NOTE**

- Make sure that the LAN cable is connected to this player. (See page 18.)
- Make sure to perform the communication settings. (See pages 42–43.)
- It may take time to access and download the update depending on the internet connection and other factors.

**CAUTION**

- Do not remove the LAN cable or unplug the AC cord while downloading or updating software.

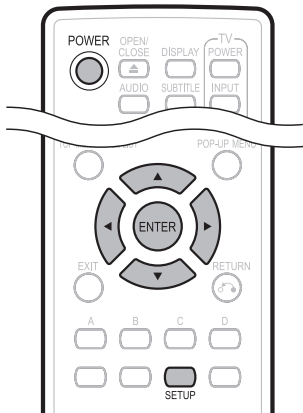

- 1 Press **SETUP** to display the Menu screen.
- 2 Press **▲/▼** to select “Settings”, then press **▶** or **ENTER**.
- 3 Press **▲/▼** to select “Software Update Settings”, then press **▶** or **ENTER**.
- 4 Press **▶** or **ENTER** to move to the menu to the right.
- 5 Press **▲/▼** to select “Network”, then press **ENTER**.

- 6 During access to the network and checking the latest version of firmware, “Accessing” blinks.
  - The current version of this unit software and the latest version of the update file on the network are displayed when latest version of firmware has been found. To update this player software with update file, select “Yes”, and go to step 7.

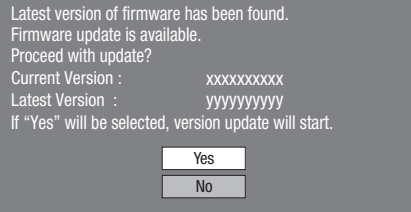

- If the firmware has already been updated to the latest version, the following message appears.



- If the internet connection has failed, an error message appears. Retry to perform the update after checking if the LAN cable connection (page 18) and internet settings (pages 42–43) are performed properly.

- 7 Press **ENTER** to start updating.

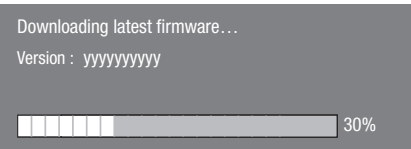

- 8 When the software is successfully updated, a screen is displayed indicating that the update process is completed.
  - If the update has failed, an error message appears. Retry to perform the update after checking if the LAN cable connection (page 18) and internet settings (pages 42–43) are performed properly.
- 9 Press **POWER** to turn off the player.

## Manual Update from USB memory device

This function allows software updates by inserting a USB memory device with the update file into the BD STORAGE/SERVICE terminal on this player.

- When a software update is performed, the software update data must be written onto the USB memory device in advance using a PC.
- The USB memory device must be clear of all files except software update data to allow new software uploading.

**To check for the availability of a software update, visit [www.sharpusa.com/products/support/](http://www.sharpusa.com/products/support/). If you have any questions, please call 1-800-BE-SHARP (800-237-4277).**

- When software update data is released, copy the data onto a USB memory device after downloading it to a PC.
- For methods such as downloading and copying to a USB memory device, carefully read the description shown on the website before performing the operation.

### NOTE

- Only USB memory devices formatted with FAT 32/16 are compatible.  
When formatting a USB memory device using a PC, perform the following settings.  
Format File System: FAT32  
Allocation Unit Size: Default Allocation Size
- Do not extract the firmware update file to any folders other than the root directory on the USB memory device. The firmware update file must be only one file directly in the root directory.

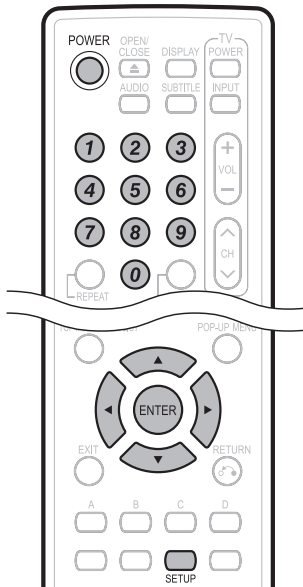

### CAUTION

- Do not remove the USB memory device or unplug the AC cord while the software is being updated.

When you insert or remove a USB memory device, be sure to turn the main power off.

- 1 Insert the USB memory device with the update file into the BD STORAGE/SERVICE terminal on rear of this player.

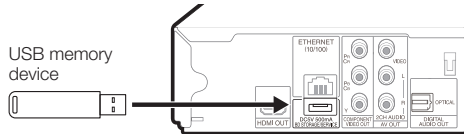

- 2 Press **SETUP** to display the Menu screen.
- 3 Press **▲/▼** to select "Settings", then press **▶** or **ENTER**.
- 4 Press **▲/▼** to select "Software Update Settings", then press **▶** or **ENTER**.
- 5 Press **▶** or **ENTER** to move to the menu to the right.
- 6 Press **▲/▼** to select "USB Memory", then press **ENTER**.
  - If you have not yet set the password, go to step 8.
- 7 Enter the 4-digit number using 0–9.

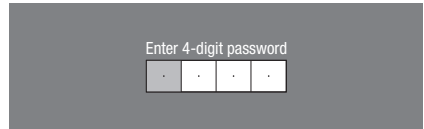

- 8 Press **ENTER** to start checking data in the USB memory device.

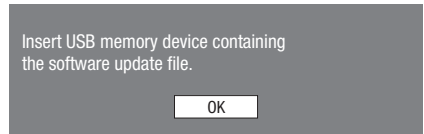

- 9 During the data checking, "Checking" blinks.

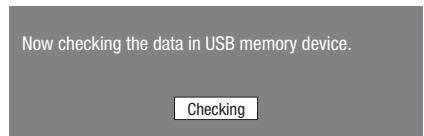





## Digital Audio Output Selection Formats

Setup	Definition	Output terminal	Audio Stream						
			PCM	Dolby Digital	Dolby Digital Plus	Dolby TrueHD	DTS	DTS-HD HR	DTS-HD MA
PCM	Decodes Primary, Secondary and Effect audio streams together into PCM audio.	HDMI OUT	PCM	PCM	PCM	PCM	PCM	PCM 7.1ch	PCM 7.1ch
		OPTICAL	PCM 2ch	PCM 2ch	PCM 2ch	PCM 2ch	PCM	PCM 2ch	PCM 2ch
Bitstream (Mix)	Decodes Primary, Secondary and Effect audio streams together into PCM audio, then re-encodes the PCM audio into DTS bitstream.	HDMI OUT/ OPTICAL	DTS	DTS	DTS	DTS	DTS	DTS 5.1ch	DTS 5.1ch
Bitstream	Outputs only the Primary audio soundtrack (main soundtrack of the movie) so that your audio equipment can decode the audio bitstream. You will not hear Secondary and Effect audio.	HDMI OUT	PCM	Dolby Digital	Dolby Digital Plus	Dolby TrueHD	DTS	DTS-HD HR	DTS-HD MA
		OPTICAL	PCM 2ch	Dolby Digital	Dolby Digital	Dolby Digital	DTS	DTS-ES 5.1ch	DTS-ES 5.1ch

Blu-ray discs may include three audio streams.

- Primary Audio: The audio soundtrack of the main feature
- Secondary Audio: Additional soundtrack such as director or actor's commentary.
- Interactive Audio: Interactive sounds will be heard when selected.  
Interactive Audio is different on each Blu-ray Disc.

# Troubleshooting

The following problems do not always suggest a defect or malfunction of this Player. Refer to the problems and lists of possible solutions below before calling for service.

## Power

Problem	Possible causes and solutions
The Player power cannot be turned on.	<ul style="list-style-type: none"> <li>Is the power cord firmly plugged into the AC outlet? (Page 19)</li> <li>When the power cord is plugged into an AC outlet, press and hold <b>POWER</b> on the Player until "P E S E L" appears on the front panel display. Then, after the ON/STANDBY indicator is lit, turn on the power. (Page 51)</li> <li>Press <b>POWER</b> after the ON/STANDBY indicator turns on. (Page 20)</li> </ul>
The Player power is turned off.	<ul style="list-style-type: none"> <li>Is "Auto Power Off" set to "Yes"? When "Auto Power Off" is set to "Yes", the power will be automatically turned off after 10 continuous minutes of inactivity (no playback). (Page 40)</li> </ul>

## Basic Operation

Problem	Possible causes and solutions
The remote control does not work.	<ul style="list-style-type: none"> <li>Use the remote control within its operating range. (Page 19)</li> <li>Replace the batteries. (Page 19)</li> <li>Reset the remote control.           <ul style="list-style-type: none"> <li>Press and hold <b>1</b> (the number button) first and then <b>ENTER</b> on the remote control together for more than 5 seconds.</li> </ul> </li> </ul>
Cannot operate the Player.	<ul style="list-style-type: none"> <li>Are you operating the Player within the specified operating temperature range? (Page 52)</li> </ul>

## Playback

Problem	Possible causes and solutions
The Player cannot play a disc.	<ul style="list-style-type: none"> <li>Take out the disc and clean it. (Page 9)</li> <li>Make sure that the disc is loaded properly (aligned in disc tray and label-side up). (Page 24)</li> <li>Make sure that region code on the disc matches that of this Player. (Page 6)</li> <li>Allow any condensation in or near the Player to dry. (Page 9)</li> <li>Check that the disc is recorded in the compatible TV system (PAL or NTSC).</li> <li>The Player cannot play back video which was not recorded normally. (Page 6)</li> <li>Proper playback may be impossible due to the state of the disc recording, a scratched, warped or dirty disc, the state of the pick-up, or compatibility issues between this Player and the disc being used. (Pages 6, 9)</li> <li>When the recorded time of a disc is unusually short, playback may not be possible.</li> <li>BD-RE/R discs recorded in a format other than BDMV/BD-RE cannot be played back. (Page 6)</li> </ul>
The disc is automatically ejected after closing the disc tray.	<ul style="list-style-type: none"> <li>Make sure that the disc is loaded properly (aligned in disc tray and label-side up). (Page 24)</li> <li>Take out the disc and clean it. (Page 9)</li> <li>Make sure that the disc is playable. (Page 6)</li> </ul>
Video stops.	<ul style="list-style-type: none"> <li>Has the Player been subjected to shock or impact? Are you using it in an unstable location? The Player will stop if it senses shock or vibration.</li> </ul>
The Player makes a snapping sound when starting playback or loading a disc.	<ul style="list-style-type: none"> <li>The player may sometimes make a snapping sound when starting playback if it has not been operated in a while. These sounds are not malfunctions of the player but are normal operating conditions.</li> </ul>

## Picture

Problem	Possible causes and solutions
No picture.	<ul style="list-style-type: none"> <li>Make sure that the cables are connected correctly. (Pages 14–16)</li> <li>Make sure that the connected TV or the AV receiver is set to the correct input. (Pages 14–16)</li> <li>Take out the disc and clean it. (Page 9)</li> <li>Make sure that region code on the disc matches that of this Player. (Page 6)</li> <li>There is no picture from the HDMI output.           <ul style="list-style-type: none"> <li>Are the settings performed correctly? Please check the settings. (Page 39)</li> </ul> </li> <li>There is no picture from the component video output.           <ul style="list-style-type: none"> <li>Are the settings performed correctly? Please check the settings. (Page 39)</li> </ul> </li> </ul>

(Continued on the next page)

## Troubleshooting

### Picture (Continued)

Problem	Possible causes and solutions
Screen freezes and operation buttons do not work.	<ul style="list-style-type: none"> <li>• Turn off the power and turn on the power again.</li> <li>• If the power is not turned off, perform a reset. (Page 51)</li> <li>• Is the disc damaged or dirty? Check the condition of the disc. (Page 9)</li> </ul>
There is just audio with no video.	<ul style="list-style-type: none"> <li>• Is the connection cable for video output connected properly? (Pages 14–16)</li> </ul>
Widescreen video appears vertically stretched, or black bands appear at the top and bottom of the screen.	<ul style="list-style-type: none"> <li>• Is "TV Aspect Ratio" set to match the connected TV? (Page 39)</li> <li>• If you are using a widescreen TV, is the "TV Aspect Ratio" set to "Wide"? (Page 39)</li> </ul>
Square noise (mosaic) appears on the screen.	<ul style="list-style-type: none"> <li>• Blocks in images may be visible in scenes with rapid movement due to the characteristics of digital image compression technology.</li> </ul>
The playback screen will be disturbed if DVD video is recorded to a VCR, or played back through a VCR.	<ul style="list-style-type: none"> <li>• This Player complies with analog copy protection. Some discs contain a copy prohibiting signal. If you try to play back such discs through a VCR, or record to a VCR and play back the signal, the copy protection will prevent normal playback. (Pages 15–16)</li> </ul>
Audio is not output, or images are not played back properly.	<ul style="list-style-type: none"> <li>• The audio may not be output or the images may not be played back properly for some discs in which copyright-protected contents are recorded.</li> </ul>

### Sound

Problem	Possible causes and solutions
No sound, or sound is distorted.	<ul style="list-style-type: none"> <li>• If the volume of the TV or amplifier is set to minimum, turn the volume up.</li> <li>• There is no sound during still mode, slow motion playback, fast forward and fast reverse. (Page 33)</li> <li>• DVD audio recorded in DTS is only output from the DIGITAL AUDIO OUT terminal. Connect a DTS compatible digital amplifier or decoder to the DIGITAL AUDIO OUT OPTICAL terminal on this Player. (Page 17)</li> <li>• Check that the audio cable is connected correctly. (Page 17)</li> <li>• Check that the cable plugs are clean.</li> <li>• Take out the disc and clean it. (Page 9)</li> <li>• Audio may not be output depending on the audio recording status, such as when audio other than an audio signal or non-standard audio is recorded for the audio content of the disc. (Page 6)</li> </ul>
Left and right channels of audio are reversed, or sound comes out of only one side.	<ul style="list-style-type: none"> <li>• Are left and right audio cables connected to the opposite terminal, or is one side disconnected? (Page 17)</li> </ul>
Audio is not output, or images are not played back properly.	<ul style="list-style-type: none"> <li>• The audio may not be output or the images may not be played back properly for some discs in which copyright-protected contents are recorded.</li> </ul>

### Network

Problem	Possible causes and solutions
Cannot connect to the Internet.	<ul style="list-style-type: none"> <li>• Is the LAN cable connected properly?</li> <li>• Is the wrong cable such as a modular cable used? Connect a LAN cable to the ETHERNET terminal. (Page 18)</li> <li>• Is the power for the connected equipment, such as broadband router or modem turned on?</li> <li>• Is the broadband router and/or modem properly connected?</li> <li>• Is the proper value(s) set in the network setting? Check "Communication Setup". (Pages 42–43)</li> </ul>
Cannot download BD-LIVE contents.	<ul style="list-style-type: none"> <li>• Is the LAN cable connected properly?</li> <li>• Is the USB memory device properly connected? Check that the USB memory device is connected to the BD STORAGE/SERVICE terminal of this Player.</li> <li>• Check if the BD disc supports BD-LIVE.</li> <li>• Check the setting for "BD Internet Access". (Page 41)</li> </ul>

## Troubleshooting

### Other

Problem	Possible causes and solutions
The TV operates incorrectly.	<ul style="list-style-type: none"> <li>Some TVs with wireless remote control capability may operate incorrectly when using the remote control of this Player. Use such TVs away from this Player.</li> </ul>
The Player heats up during use.	<ul style="list-style-type: none"> <li>When using this Player, the console cabinet may heat up depending on the usage environment. This is not a malfunction.</li> </ul>
ON/STANDBY indicator will remain lit.	<ul style="list-style-type: none"> <li>When the AC cord is removed from the outlet, the ON/STANDBY indicator will remain lit for a short period. This is normal and is not a malfunction.</li> </ul>

### To Reset this Player

- If this Player receives strong interference from a source such as excessive static electricity, strong external noise, malfunction of power supply, or voltage caused by lightning during use or a wrong operation is sent to the Player, errors like the Player not accepting an operation may occur.

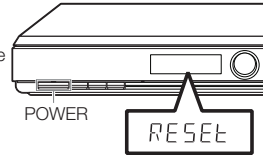

- Press and hold **POWER** on the Player until "**RESET**" appears on the front panel display when the Player does not operate properly even after the power has been turned off. Then, after the ON/STANDBY indicator is lit, turn on the power.
- When a reset is performed while the power is on, the Player will turn off. Turn the power on again. At this point, it may take a few moments for the system processing to finish before the Player is ready for use. During the system processing, the BD/DVD/CD mode indicator on the front panel display of the Player will blink. Once the system processing has finished, the indicator will finish blinking and then light up normally. You can operate the Player when the BD/DVD/CD mode indicator is lit.
  - Since all settings including the language setting stored in memory are also reset when a reset has been performed, they must be set again.
  - When the problem persists even after performing a reset, unplug the AC cord and plug it in again. If this does not solve the problem, contact the nearest service center approved by SHARP.

## On-screen Error Messages

The following messages appear on the TV screen in case of an error during operation.

Error message	Possible Error	Suggested Solution
Cannot play.	<ul style="list-style-type: none"> <li>The disc cannot be played back with this Player.</li> </ul>	<ul style="list-style-type: none"> <li>Check the disc, and load it correctly.</li> </ul>
Incompatible disc.	<ul style="list-style-type: none"> <li>If you load a disc which cannot be played with this Player (i.e. a scratched disc), or if you load a disc upside down, this message will appear, and the disc tray will automatically pop out.</li> </ul>	<ul style="list-style-type: none"> <li>Remove the disc.</li> </ul>
	<ul style="list-style-type: none"> <li>Occurs if the loaded disc cannot be played because it is a non-standard disc or scratched, etc.</li> </ul>	
Cannot operate.	<ul style="list-style-type: none"> <li>Occurs if an operation is incorrect.</li> </ul>	—
This USB memory is not formatted properly. Please format the memory in USB memory management.	<ul style="list-style-type: none"> <li>Occurs if there is a formatting error.</li> <li>Occurs if the USB memory is not formatted with FAT 32/16.</li> </ul>	<ul style="list-style-type: none"> <li>Format the USB memory again.</li> <li>Format the USB memory with your PC.</li> </ul>
The Connected USB Memory cannot be used. It should be compliant with USB 2.0	<ul style="list-style-type: none"> <li>Occurs if USB memory not compliant with USB 2.0 High Speed (480Mbit/s) is used (i.e. USB 1.0/USB 1.1).</li> </ul>	<ul style="list-style-type: none"> <li>Connect USB 2.0 High Speed (480Mbit/s) compliant USB memory.</li> </ul>

# Specifications

## General

Power supply	AC 120V, 60Hz
Power consumption (Normal)	15 W
Power consumption (Standby)	0.3 W
Dimensions	Approx. 17 <sup>1</sup> / <sub>16</sub> × 2 <sup>5</sup> / <sub>16</sub> × 8 <sup>11</sup> / <sub>16</sub> inch (W × H × D) Approx. 432 mm × 58 mm × 220 mm (W × H × D)
Weight	4.4 lbs. (2.0 kg)
Operating temperature	41°F to 95°F (5°C to 35°C)
Storage temperature	-4°F to 140°F (-20°C to 60°C)
Operating humidity	10 % to 80 % (no condensation)
TV systems	NTSC system

## Playback

Playable discs	BD-ROM, BD-RE Dual Layer, BD-R Dual Layer, DVD Video, DVD+RW/+R/-RW/-R Dual Layer (Video/VR/AVCHD/JPEG file/MP3 file format), Audio CD (CD-DA), CD-RW/R (CD-DA/JPEG file/MP3 file format)
Region code	A or ALL for BD, 1 or ALL for DVD

## Input/Output

HDMI	HDMI 19-pin standard connector (1080p 24Hz output) HDMI® (Deep Color, x.v.Color, Dolby TrueHD, DTS-HD Master Audio   Essential)
Component video output	Output level: Y: 1 Vp-p (75 ohms) P <sub>B</sub> /C <sub>B</sub> , P <sub>R</sub> /C <sub>R</sub> : 0.7 Vp-p (75 ohms) Jacks: RCA jack
Video output	Output level: 1 Vp-p (75 ohms) Jack: RCA-pin jack
Digital audio optical output	Terminal: Square Optical terminal
Audio output	Output level: 2 V rms (Output impedance: 1k ohms) Jacks: RCA jack
USB input	USB 2.0 High Speed (480Mbit/s) correspondence (for Local storage/Software update/JPEG and MP3 playback)
ETHERNET	10BASE-T/100BASE-TX

Specifications are subject to change without notice.

# Glossary

## AVCHD (page 6)

AVCHD (Advanced Video Codec High Definition) refers to a recording format (specification) for digital video cameras which can record to a disc such as 8 cm DVD disc and play back digital high definition images.

## BDAV (page 6)

BDAV (Blu-ray Disc Audio/Visual, BD-AV) refers to one of the application formats used for writable Blu-ray discs such as BD-R, BD-RE, etc. BDAV is a recording format equivalent to DVD-VR (VR mode) of the DVD specifications.

## BD-J application

The BD-ROM format supports Java for interactive functions. "BD-J" offers content providers almost unlimited functionality when creating interactive BD-ROM titles.

## BD-LIVE (page 26)

A variety of interactive content is available from BD-LIVE compatible Blu-ray discs via the internet.

## BDMV (page 6)

BDMV (Blu-ray Disc Movie, BD-MV) refers to one of the application formats used for BD-ROM which is one of the Blu-ray Disc specifications. BDMV is a recording format equivalent to DVD-video of the DVD specification.

## BD-R (pages 6, 24)

A BD-R (Blu-ray Disc Recordable) is a recordable, write-once Blu-ray Disc. Since contents can be recorded and cannot be overwritten, a BD-R can be used to archive data or for storing and distributing video material.

## BD-RE (pages 6, 24)

A BD-RE (Blu-ray Disc Rewritable) is a recordable and rewritable Blu-ray Disc.

## BD-ROM

BD-ROMs (Blu-ray Disc Read-Only Memory) are commercially produced discs. Other than conventional movie and video contents, these discs have enhanced features such as interactive content, menu operations using pop-up menus, selection of subtitle display, and slide shows. Although a BD-ROM may contain any form of data, most BD-ROM discs will contain movies in High Definition format for playback on Blu-ray Disc players.

## Blu-ray Disc (BD) (page 6)

A disc format developed for recording/playing high-definition (HD) video (for HDTV, etc.), and for storing large amounts of data. A single layer Blu-ray Disc holds up to 25 GB, and a dual-layer Blu-ray Disc holds up to 50 GB of data.

## Chapter number (pages 36, 37)

Sections of a movie or a music feature that are smaller than titles. A title is composed of several chapters. Some discs may only be comprised of a single chapter.

## Control Panel (page 23)

This function allows you to operate this player using the TV remote control by displaying the control panel on the TV screen.

## Copy guard

This function prevents copying. You cannot copy discs marked by the copyright holder with a signal which prevents copying.

## Deep Color

Deep Color can reproduce rich colors, increasing the number of bits describing colors.

This Player is compatible with Deep Color. You can enjoy this function by connecting to a Deep Color compatible TV using an HDMI cable.

## Disc menu (page 25)

This lets you select things like the subtitle language or audio format using a menu stored on the DVD video disc.

## Dolby Digital

A sound system developed by Dolby Laboratories Inc. that gives movie theater ambience to audio output when the product is connected to a Dolby Digital processor or amplifier.

## Dolby Digital Plus

A sound system developed as an extension to Dolby Digital. This audio coding technology supports 7.1 multi-channel surround sound.

## Dolby TrueHD

Dolby TrueHD is a lossless coding technology that supports up to 8 channels of multi-channel surround sound for the next generation optical discs. The reproduced sound is true to the original source bit-for-bit.

## DTS

This is a digital sound system developed by DTS, Inc. for use in cinemas.

## DTS-HD High Resolution Audio

DTS-HD High Resolution Audio is a new technology developed for the next generation high definition optical disc format.

## DTS-HD Master Audio

DTS-HD Master Audio is a lossless audio compression technology developed for the next generation high definition optical disc format.

## DTS-HD Master Audio | Essential

DTS-HD Master Audio | Essential is a lossless audio compression technology developed for the next generation high definition optical disc format.

## DVD upscaling (page 24)

Upscaling (upconverting) refers to a function of various players and devices that enlarge the image size to fit the size of the screen of video equipments such as a TV.

(Continued on the next page)

### **DVD video (pages 6, 24)**

A disc format that contains up to eight hours of moving pictures on a disc the same diameter as a CD. A single-layer single sided DVD holds up to 4.7 GB; a double layer single-sided DVD, 8.5 GB; a single layer double-sided DVD, 9.4 GB; double-layer double-sided DVD, 17 GB. The MPEG 2 format was adopted for efficient video data compression. It is a variable rate technology that encodes the data to according to the status of the video for reproducing high-quality images. Audio information is recorded in a multi-channel format such as Dolby Digital, allowing for a realistic audio presence.

### **DVD+/-R (pages 6, 24)**

A DVD+/-R is a recordable and write-once DVD. Since contents can be recorded and cannot be overwritten, a DVD+/-R can be used to archive data or for storing and distributing video material. The DVD+/-R has two different formats: VR format and Video format. DVDs created in Video format have the same format as a DVD video, while discs created in VR (Video Recording) format allow the contents to be programed or edited.

### **DVD+/-RW (pages 6, 24)**

A DVD+/-RW is a recordable and rewritable DVD. The re-recordable feature makes editing possible. The DVD+/-RW has two different formats: VR format and Video format. DVDs created in Video format have the same format as a DVD video, while discs created in VR (Video Recording) format allow the contents to be programed or edited.

### **HDMI (page 14)**

HDMI (High-Definition Multimedia Interface) is an interface that supports both video and audio on a single digital connection. The HDMI connection carries standard to high definition video signals and multi-channel audio signals to AV components such as HDMI equipped TVs, in digital form without degradation.

### **Interlace format**

Interlace format shows every other line of an image as a single "field" and is the standard method for displaying images on television. The even numbered field shows the even numbered lines of an image, and the odd numbered field shows the odd numbered lines of an image.

### **JPEG (pages 6, 7, 30)**

JPEG (Joint Photographic Experts Group) is a still image data compression format and is used in most of digital cameras.

### **Letter Box (LB 4:3) (page 39)**

A screen size with black bars on the top and bottom of the image to allow viewing of wide-screen (16:9) material on a connected 4:3 TV.

### **Linear PCM Sound**

Linear PCM is a signal recording format used for Audio CDs and on some DVD and Blu-ray discs. The sound on Audio CDs is recorded at 44.1 kHz with 16 bits. (Sound is recorded between 48 kHz with 16 bits and 96 kHz with 24 bits on DVD video discs and between 48 kHz with 16 bits and 192 kHz with 24 bits on BD video discs.)

### **MP3 (pages 6, 7, 29)**

MP3 files are audio data compressed in the MPEG1/2 Audio layer-3 file format. "MP3 files" have ".mp3" as extensions.

### **MPEG-2**

MPEG-2 (Moving Picture Experts Group phase 2) is one of the video data compression schemes, which is adopted for DVD videos and digital broadcasts worldwide. Some Blu-ray Discs also use high bitrate MPEG-2.

### **Multi Angle (pages 35–37)**

This is a feature of DVD and BD video discs. In some discs, the same scene is shot from different angles, and these are stored in a single disc so you can enjoy playback from each angle. (This function can be enjoyed if the disc is recorded with multiple angles.)

### **Multi Audio**

This is a feature of DVD and BD video discs. This function makes it possible to record different audio tracks for the same video, so you can enhance your enjoyment by switching the audio. (You can enjoy this function with discs recorded with multiple audio tracks.)

### **Netflix (pages 31, 32)**

Netflix is an online DVD and Blu-ray Disc rental service, offering rental-by mail and streaming instantly to Netflix unlimited members.

### **Pan Scan (PS 4:3) (page 39)**

A screen size that cuts off the sides of the image to allow viewing of wide-screen (16:9) material on a connected 4:3 TV.

### **Parental control (page 41)**

In some digital broadcasts and BD/DVD video discs, a control level for disc viewing is set depending on the age of the viewer. With this Player, you can set the control level for viewing such broadcasts and discs.

### **Pop-up menu (page 25)**

An enhanced menu operation available on BD video discs. The pop-up menu appears when **POP-UP MENU** is pressed during playback, and can be operated while playback is in progress.



### **Progressive format**

Compared to the Interlace format that alternately shows every other line of an image (field) to create one frame, the Progressive format shows the entire image at once as a single frame. This means that while the Interlace format can show 30 frames/60 fields in one second, the Progressive format can show 60 frames in one second. The overall picture quality increases and still images, text, and horizontal lines appear sharper.

### **Region code (page 6)**

Code identifying a geographic region of compatibility for a BD/DVD.

### **Resume playback (page 24)**

If you stop playback while it is in progress, the Player stores the stop position in memory, and this function lets you playback from that point.

### **Skip (pages 29, 33)**

This returns to the start of the chapter (or track) being played, or skips to the next chapter (or track).

### **Subtitles (pages 35–37)**

These are the lines of text appearing at the bottom of the screen which translate or transcribe the dialog. They are recorded on many DVD and BD video discs.

### **Time number**

This indicates the play time which has elapsed from the start of a disc or a title. It can be used to find a specific scene quickly. (It may not work with some discs.)

### **Title number (pages 36, 37)**

These numbers are recorded on DVD and Blu-ray discs. When a disc contains two or more movies, these movies are numbered as title 1, title 2, etc.

### **Top menu (page 25)**

In a BD/DVD video, this is the menu for selecting things like the chapter to be played back and the subtitle language. In some DVD videos, the top menu may be called the "Title Menu".

### **Track number (pages 36, 37)**

These numbers are assigned to the tracks which are recorded on audio CDs. They enable specific tracks to be located quickly.

### **x.v.Color**

x.v.Color reproduces a greater range of color than before, showing almost all of the colors that the human eye can detect. (Applicable for JPEG files only with this system)

# Network Service Disclaimer

---

This Sharp device facilitates the access to content and services provided by third parties. The content and services accessible via this device belong to and may be proprietary to third parties. Therefore, any use of such third party content and services must be in accordance with any authorization or terms of use provided by such content or service provider. Sharp shall not be liable to you or any third party for your failure to abide by such authorization or terms of use. Unless otherwise specifically authorized by the applicable content or service provider, all third party content and services provided are for personal and non-commercial use; you may not modify, copy, distribute, transmit, display, perform, reproduce, upload, publish, license, create derivative works from, transfer or sell in any manner or medium any content or services available via this device.

Sharp is not responsible, nor liable, for customer service-related issues related to the third party content or services. Any questions, comments or service-related inquiries relating to the third party content or service should be made directly to the applicable content or service provider.

You may not be able to access content or services from the device for a variety of reasons which may be unrelated to the device itself, including, but not limited to, power failure, other Internet connection, or failure to configure your device properly. Sharp, its directors, officers, employees, agents, contractors and affiliates shall not be liable to you or any third party with respect to such failures or maintenance outages, regardless of cause or whether or not it could have been avoided.

ALL THIRD PARTY CONTENT OR SERVICES ACCESSIBLE VIA THIS DEVICE IS PROVIDED TO YOU ON AN "AS-IS" AND "AS AVAILABLE" BASIS AND SHARP AND ITS AFFILIATES MAKE NO WARRANTY OR REPRESENTATION OF ANY KIND TO YOU, EITHER EXPRESS OR IMPLIED, INCLUDING, WITHOUT LIMITATION, ANY WARRANTIES OF MERCHANTABILITY, NON-INFRINGEMENT, FITNESS FOR A PARTICULAR PURPOSE OR ANY WARRANTIES OF SUITABILITY, AVAILABILITY, ACCURACY, COMPLETENESS, SECURITY, TITLE, USEFULNESS, LACK OF NEGLIGENCE OR ERROR-FREE OR UNINTERRUPTED OPERATION OR USE OF THE CONTENT OR SERVICES PROVIDED TO YOU OR THAT THE CONTENT OR SERVICES WILL MEET YOUR REQUIREMENTS OR EXPECTATIONS.

SHARP IS NOT AN AGENT OF AND ASSUMES NO RESPONSIBILITY FOR THE ACTS OR OMISSIONS OF THIRD PARTY CONTENT OR SERVICE PROVIDERS, NOR ANY ASPECT OF THE CONTENT OR SERVICE RELATED TO SUCH THIRD PARTY PROVIDERS.

IN NO EVENT WILL SHARP AND/OR ITS AFFILIATES BE LIABLE TO YOU OR ANY THIRD PARTY FOR ANY DIRECT, INDIRECT, SPECIAL, INCIDENTAL, PUNITIVE, CONSEQUENTIAL OR OTHER DAMAGES, WHETHER THE THEORY OF LIABILITY IS BASED ON CONTRACT, TORT, NEGLIGENCE, BREACH OF WARRANTY, STRICT LIABILITY OR OTHERWISE AND WHETHER OR NOT SHARP AND/OR ITS AFFILIATES HAVE BEEN ADVISED OF THE POSSIBILITY OF SUCH DAMAGES.

# About Software License

## Information on the Software License for This Product

### Software composition

The software included in this product is comprised of various software components whose individual copyrights are held by SHARP or by third parties.

### Software developed by SHARP and open source software

The copyrights for the software components and various relevant documents included with this product that were developed or written by SHARP are owned by SHARP and are protected by the Copyright Act, international treaties, and other relevant laws. This product also makes use of freely distributed software and software components whose copyrights are held by third parties. These include software components covered by a GNU General Public License (hereafter GPL), a GNU Lesser General Public License (hereafter LGPL) or other license agreement.

### Obtaining source code

Some of the open source software licensors require the distributor to provide the source code with the executable software components. GPL and LGPL include similar requirements. For information on obtaining the source code for the open source software and for obtaining the GPL, LGPL, and other license agreement information, visit the following website:

<http://www.sharpusa.com/gpl>

We are unable to answer any questions about the source code for the open source software. The source code for the software components whose copyrights are held by SHARP is not distributed.

### Acknowledgements

The following open source software components are included in this product:

- backtrace • directfb-extra • cairo • directfb • iconv • openssl • curl • freetype • jpeg • expat • mng • png • xml • zlib • kernel
- net-tools • GNU bash • busybox • cramfs • dhcpcd • e2fsprogs • fdisk • TinyLogin • sysutils • iptables • mtd-utils • ntfs-3g
- sfdisk • hotplug • utelnetd • procps • freetype • GNU termcap • libusb • uClibc • tcpdump • strace • hdparm • libpcap
- portmap

## Software License Notice

### Software License Notice Requirements

The software components incorporated into this product include components whose copyright holders require license notices. The license notices for these software components are shown below.

#### OpenSSL License

This product includes software developed by the OpenSSL Project for use in the OpenSSL Toolkit. (<http://www.openssl.org>)

#### Original SSLeay License

This product includes cryptographic software written by Eric Young ([ey@cryptsoft.com](mailto:ey@cryptsoft.com)).

#### BSD License

This product includes software developed by the University of California, Berkeley and its contributors.

# CONSUMER LIMITED WARRANTY

(Valid for warranty service in the U.S. and PUERTO RICO only)

## CONSUMER LIMITED WARRANTY

SHARP ELECTRONICS CORPORATION warrants to the first consumer purchaser that this Sharp brand product (the "Product"), when shipped in its original container, will be free from defective workmanship and materials, and agrees that it will, at its option, either repair the defect or replace the defective Product or part thereof with a new or remanufactured equivalent at no charge to the purchaser for parts or labor for the period(s) set forth below.

This warranty does not apply to any appearance items of the Product or if the serial number or model number affixed to the Product has been removed, defaced, changed, altered or tampered with. This warranty does not cover installation or signal reception problems. This limited warranty will not apply if the Product has been or is being used in a commercial setting or application; this warranty is meant solely for the non-commercial, household use of the Product by consumers in their home or residence.

In order to enforce the rights under this limited warranty, the purchaser should follow the steps set forth below and provide proof of purchase to the servicer.

To the extent permitted by applicable state law, the warranties set forth are in lieu of, and exclusive of, all other warranties, express or implied. Specifically ALL OTHER WARRANTIES OTHER THAN THOSE SET FORTH ABOVE ARE EXCLUDED. ALL EXPRESS AND IMPLIED WARRANTIES INCLUDING THE WARRANTIES OF MERCHANTABILITY, FITNESS FOR USE, AND FITNESS FOR A PARTICULAR PURPOSE ARE SPECIFICALLY EXCLUDED. IF, UNDER APPLICABLE STATE LAW, IMPLIED WARRANTIES MAY NOT VALIDLY BE DISCLAIMED OR EXCLUDED, THE DURATION OF SUCH IMPLIED WARRANTIES IS LIMITED TO THE PERIOD(S) FROM THE DATE OF PURCHASE SET FORTH BELOW. THIS WARRANTY GIVES YOU SPECIFIC LEGAL RIGHTS. YOU MAY ALSO HAVE OTHER RIGHTS WHICH VARY FROM STATE TO STATE.

The warranties given herein shall be the sole and exclusive warranties granted by Sharp and shall be the sole and exclusive remedy available to the purchaser and only for the time periods set forth herein. No other representations or promises made by anyone are permitted. Correction of defects, in the manner and for the period of time described herein, shall constitute complete fulfillment of all liabilities and responsibilities of Sharp to the purchaser with respect to the Product, and shall constitute full satisfaction of all claims, whether based on contract, negligence, strict liability or otherwise. Sharp does not warrant nor shall Sharp be liable, or in any way responsible, for Products which have been subject to abuse (including, but not limited to, improper voltage), accident, misuse, negligence, lack of reasonable care, alteration, modification, tampering, improper operation or maintenance or any damages or defects in the Product which were caused by repairs or attempted repairs performed by anyone other than a Sharp authorized servicer. Nor shall Sharp be liable or in any way responsible for any incidental or consequential economic or property damage. Some states do not allow limits on warranties or on remedies for breach in certain transactions; in such states, the limits herein may not apply.

THIS LIMITED WARRANTY IS VALID ONLY IN THE FIFTY (50) UNITED STATES, THE DISTRICT OF COLUMBIA, AND PUERTO RICO

### Model Specific Section

**Your Product Model Number & Description:**

BD-HP24U(A) BLU-RAY DISC/DVD PLAYER  
(Be sure to have this information available when you need service for your Product.)

**Warranty Period for this Product:**

One (1) year parts and labor from the date of purchase.

**Additional Item(s) Excluded from Warranty Coverage (if any):**

Non-rechargeable batteries.

**Where to Obtain Service:**

From a Sharp Authorized Servicer located in the United States. To find the location of the nearest Sharp Authorized Servicer, call Sharp toll free at 1-800-BE-SHARP.

**What to do to Obtain Service:**

Please transport the Product in its original packaging and ensure that the Product is covered to avoid scratches and damage. Sharp shall not be responsible for lost, stolen or misdirected mail or for damage to the product incurred during shipping.

TO OBTAIN PRODUCT INFORMATION, CALL 1-800-BE-SHARP OR VISIT [www.sharppusa.com](http://www.sharppusa.com)

# **SHARP®**

**SHARP ELECTRONICS CORPORATION**

Sharp Plaza, Mahwah, New Jersey 07495-1163

**SHARP CORPORATION**

Printed in China  
Impreso en China  
Imprimé en Chine

**TINS-E819WJQZ**

10P07-CH-NG

## Free Manuals Download Website

<http://myh66.com>

<http://usermanuals.us>

<http://www.somanuals.com>

<http://www.4manuals.cc>

<http://www.manual-lib.com>

<http://www.404manual.com>

<http://www.luxmanual.com>

<http://aubethermostatmanual.com>

Golf course search by state

<http://golfingnear.com>

Email search by domain

<http://emailbydomain.com>

Auto manuals search

<http://auto.somanuals.com>

TV manuals search

<http://tv.somanuals.com>