

**SHARP**

**PORTABLE MINIDISC  
RECORDER**

**MODEL  
MD-MT866H**

**OPERATION MANUAL**



If you require any advice or assistance regarding your Sharp product, please visit our web-site [www.sharp.co.uk/support](http://www.sharp.co.uk/support). Customers without internet access may telephone 08705 274277 during office hours (or (01) 676 0648 if telephoning from Ireland).



Thank you for purchasing this SHARP product.  
For the best performance, read this manual carefully.  
It will guide you in operating your SHARP product.

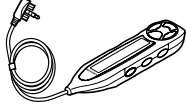

## Accessories

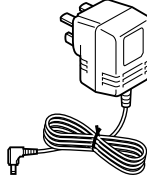
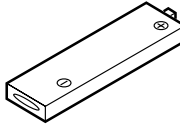
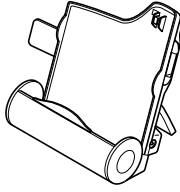
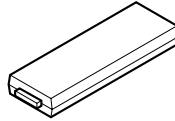
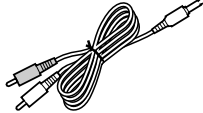
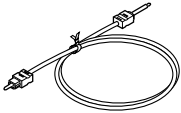
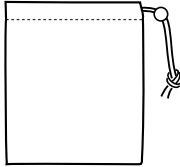
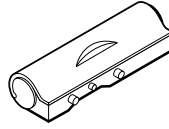
 Remote Control x 1	 Earphones x 1	 AC Adaptor (RADPA8046AWZZ) x 1	 Rechargeable Nickel-Metal Hydride Battery (AD-N55BT) x 1	 Battery Charger x 1
 Battery Carrying Case x 1	 Connection Cable (for analogue recording) x 1	 Connection Cable (for digital recording) x 1	 Carrying Bag x 1	 Battery Case x 1

### Notes:

- Parts and equipment mentioned in this operation manual other than those detailed above are not included.
- The AC adaptor may be different from the one in the drawing.



# Contents

## Important Introduction

Special Notes .....	4-5
Precautions .....	6
Names of Controls and Indicators .....	7-9
Battery Charger .....	10-11

## Power Source

Using with the Rechargeable Battery .....	12-13
Using with the AC Adaptor .....	14
Using with the Alkaline Battery .....	15

## Preparation

Hold Function .....	16
Inserting a MiniDisc .....	17
Connections .....	18-19

## Basic Operation

Recording .....	20-23
Playback .....	24-25

## Useful Features

Advanced Playback .....	26-27
Advanced Recording .....	28-32
Recording from a Microphone .....	33-35
Checking Displays .....	36-37
Changing Default Settings .....	38-39

## Advanced Features

Titling a MiniDisc .....	40-43
Editing a Recorded MiniDisc .....	44-46
Listening to a MiniDisc Through a Stereo System or a Car Stereo .....	47

## References

Other Features and Caution .....	48
MiniDisc System Limitations .....	49
Error Messages .....	50-51
Troubleshooting .....	52-53
Maintenance .....	53
Specifications .....	54-55

TERMS OF GUARANTEE .....	Back cover
--------------------------	------------



## Special Notes

### NOTES FOR USERS IN THE U.K. AND IRELAND

#### SERVICE INFORMATION

In the unlikely event of your equipment requiring repair, please contact the dealer or supplier from whom it was purchased. Where this is not possible, please visit our web-site [www.sharp.co.uk/support](http://www.sharp.co.uk/support).

Customers without internet access may telephone 08705 274277 during office hours (or (01) 676 0648 if telephoning from Ireland).

Please note; all calls will be charged at local rate.

Certain replacement parts and accessories may be obtained from our main parts distributor.

WILLOW VALE ELECTRONICS LTD.  
0121 766 5414

In the unlikely event of this equipment requiring repair during the guarantee period, you will need to provide proof of the date of purchase to the repairing company. Please keep your invoice or receipt, which is supplied at the time of purchase.

### Warnings

- The supplied AC adaptor contains no user serviceable parts.  
Never remove covers unless qualified to do so. It contains dangerous voltages, always remove mains plug from the main outlet socket before any service operation or when not in use for a long period.
- The AC adaptor supplied with the MD-MT866H must not be used with other equipment.
- To prevent fire or shock hazard, do not expose this appliance to dripping or splashing liquids.  
No objects filled with liquids, such as vases, shall be placed on the apparatus.
- Never use an AC adaptor other than the one specified.  
Otherwise, problems or serious hazards may be created.

### Cautions

- When recording important selections, make a preliminary test to ensure that the desired material is properly recorded.
- SHARP is not liable for damage or loss of your recording arising from malfunction of this unit.

**Web-site:** [www.sharp.co.uk/support](http://www.sharp.co.uk/support) **Help Line:** 08705 274277 (office hours)



- At full volume, prolonged listening to a personal stereo may damage the user's hearing.  
This model complies with the law if used with the correct earphones (model number RPHOH0176AFSA).  
If the earphones are damaged in any way, please order using the model number given above.
- Use the Portable MiniDisc Recorder only in accordance with the instructions given in this manual and do not attempt to interfere with the interlock switch or make any other adjustment as this may result in exposure to hazardous radiation.

- It is not recommendable to put the MiniDisc into a rear pocket, as this may damage the product when sitting.



### Notes

- Recording and playback of any material may require consent, which SHARP is unable to give. Please refer particularly to the provisions of the Copyright Act 1956, the Dramatic and Musical Performers Protection Act 1958, the Performers Protection Acts 1963 and 1972 and to any subsequent statutory enactments and orders.
- This equipment complies with the requirements of Directives 89/336/EEC and 73/23/EEC as amended by 93/68/EEC.
- US and foreign patents licensed from Dolby Laboratories Licensing Corporation.
- The letters in brackets contained in the model number indicate the colour of the product only. Operation and specifications are unaffected.

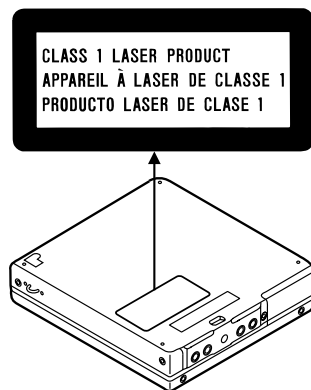

Web-site: [www.sharp.co.uk/support](http://www.sharp.co.uk/support) Help Line: 08705 274277 (office hours)



## Precautions

### Important

- Do not wear your earphones when you are crossing streets or near traffic.
- Do not use your earphones whilst driving a motor vehicle, it may create a traffic hazard and may be illegal. Remember to obey all of the safety rules in your area.
- Do not play the unit at a high volume. Hearing experts advise against extended listening at high volume levels.
- If you experience ringing in your ears, reduce the volume or discontinue use.
- No naked flame sources, such as lighted candles, should be placed on the apparatus.
- Attention should be drawn to the environmental aspects of battery disposal.
- The apparatus is designed for use in moderate climate.



### To avoid accidental electric shock or other possible problems, observe the precautions listed below.

- Do not disassemble or modify the unit.
- Do not drop or subject the unit to shock.
- Do not use the unit near open flames.
- Do not spill liquid on the unit.
- Do not use an external power supply, other than the 5V DC supplied with this unit, as it may damage it.
- SHARP is not responsible for damage due to improper use. Refer all servicing to a SHARP authorised service centre.

### Storing the unit

#### Avoid using or leaving the unit in the following places.

- Places exposed to direct sunlight for many hours (especially in cars with the doors and windows closed) or near heaters. (The cabinet may deform, change colour or the unit may malfunction.)
- Places exposed to water.
- Places exposed to excessive dust.
- Places where temperatures are excessively high or low.
- Places (bathrooms) where the humidity is extremely high.
- Places with strong magnetic fields such as TVs or loudspeakers.
- Places exposed to vibration.
- Places where sand can easily enter the inside of the unit (beaches etc.).
- If the unit is used near radio tuners or TVs, noise and/or picture interference may result. If you experience these problems, move the unit away from such devices.

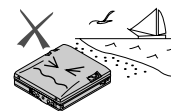
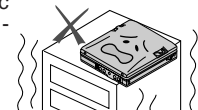
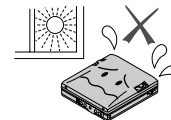



## Names of Controls and Indicators

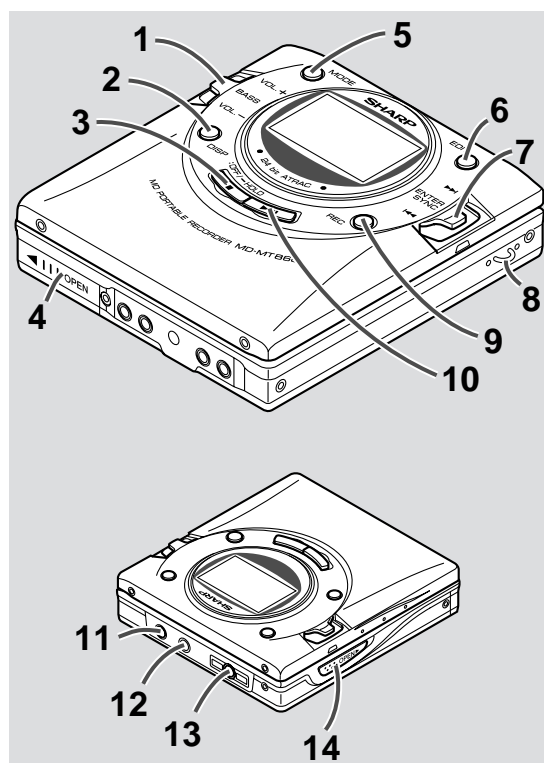

### Main unit

1. Volume/Cursor/Bass/Delete Left Shuttle Switch (24, 41)
2. Display/Character Select Button (36, 37, 40)
3. Stop/Power Off/Hold Button (16, 20, 24, 38)
4. Rechargeable Battery Cover (12)
5. Mode Button (27, 29, 38)
6. Edit/Auto Mark/Time Mark Button (31, 35, 40-46)
7. Enter/Fast Play/Synchro/Fast Forward/Fast Reverse/Recording Level/Name Select Right Shuttle Switch (20, 26-28, 38-46)
8. Handstrap Holder
9. Record/Track Mark Button (20, 31)
10. Play/Pause Button (20, 24)
11. Optical/Line Input Socket (18, 19)
12. Microphone Input Socket (33)
13. Remote Control/Earphones/Line Output Socket (24)
14. Open Lever (17)



## Names of Controls and Indicators (continued)

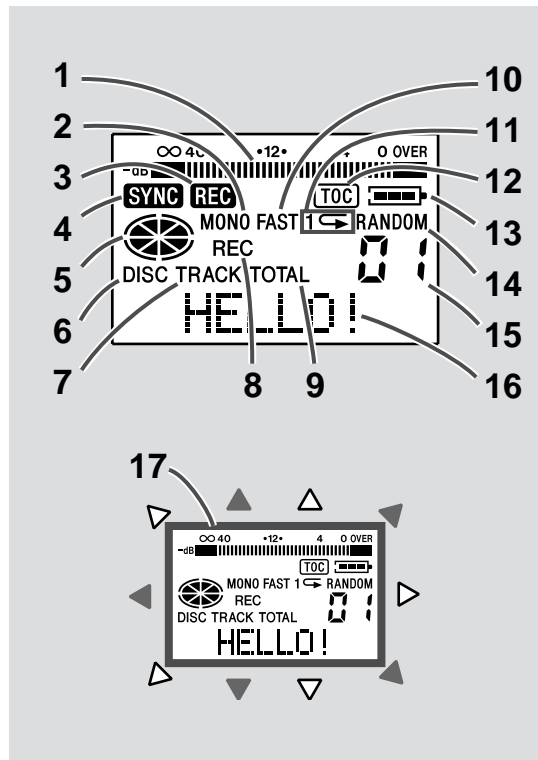

### Main unit display panel

1. Level Meter
  2. Monaural Long-Play Mode Indicator
  3. Record Indicator
  4. Synchro Recording Indicator
  5. Disc Mode Indicator
  6. Disc Name Indicator
  7. Track Name Indicator
  8. Remaining Recording Time Indicator
  9. Total Track Number Indicator
  10. Fast Play Indicator
  11. Repeat Indicator
  12. TOC Indicator
  13. Battery Indicator
  14. Random Indicator
  15. Track Number Indicator
  16. Character/Time Information Indicator
  17. LCD Edge Light
- Lights around the LCD show the operating condition.

<b>Charging</b>	Flashes slowly.
<b>Refresh</b>	Flashes quickly.
<b>Playback</b>	Flashes once slowly every 3 seconds.
<b>Recording</b>	Flashes twice slowly every 5 seconds.
<b>Fast forward and reverse</b>	Flashes
<b>TOC</b>	Reading : Flashes Writing : Flashes quickly



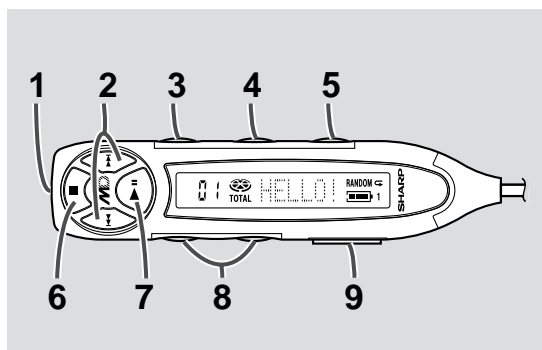

### Remote control unit

1. Earphones Socket (24)
2. Fast Forward/Fast Reverse Button
3. Display Button
4. Play Mode Button (27)
5. Sound/Track Mark Button (25, 31)
6. Stop/Power Off Button (22, 25)
7. Play/Pause Button
8. Volume Button
9. Hold Switch (16)

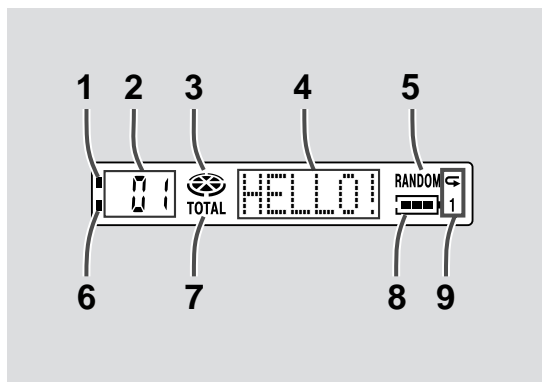

### Remote control display panel

1. Record Indicator
2. Track Number Indicator
3. Disc Mode Indicator
4. Character/Time Information Indicator
5. Random Indicator
6. Synchro Recording Indicator
7. Total Track Number Indicator
8. Battery Indicator
9. Repeat Indicator

Web-site: [www.sharp.co.uk/support](http://www.sharp.co.uk/support) Help Line: 08705 274277 (office hours)



## Battery Charger

There are two different ways to use the battery charger one is to use it as a normal battery charger, the other is to use it with an AC adaptor by attaching the portable MD to the battery charger.

### Names

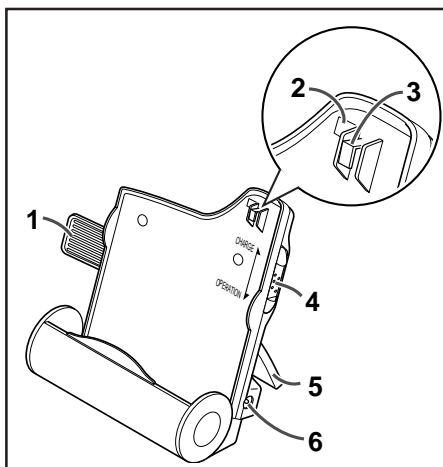

1. Remote Control Holder (11)  
(You can hang the remote control on it.)
2. Lock Detector
3. Hook For Fixing The Main Unit
4. Charge/Operation Switch (10, 11)
5. Stand
6. AC Adaptor Connecting Socket (18, 19)

### Setting

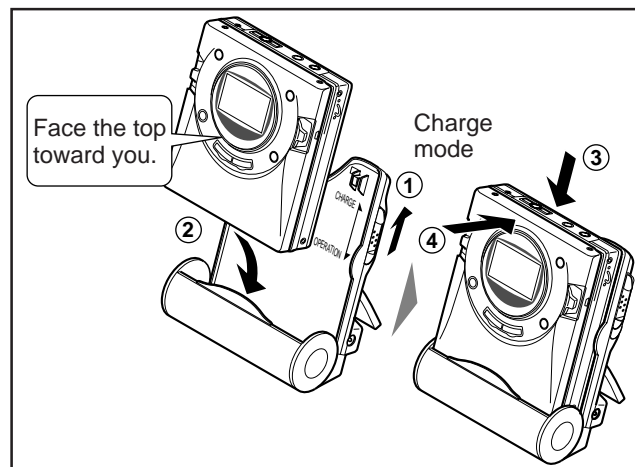

#### Caution:

- Before setting the portable MD to the battery charger, make sure the battery charger is in charge mode (CHARGE). If you insert the portable MD by force whilst in operation mode (OPERATION), the hook for fixing the portable MD may break.
- Operating whilst in charge mode, "CHARGE mode" will appear and no operation is possible.



### How to use the Charge / Operation switch

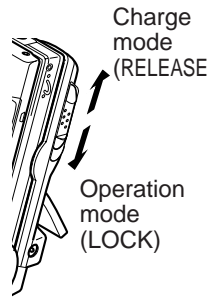

<b>Charge mode (RELEASE)</b>	<b>For charging</b> Move it to charge mode (see "Using with the Rechargeable Battery" page 12).
<b>Operation mode (LOCK)</b>	<b>For operations</b> Move it to operation mode when playing back or recording (see "Using with the AC Adaptor" page 14).

### Removing

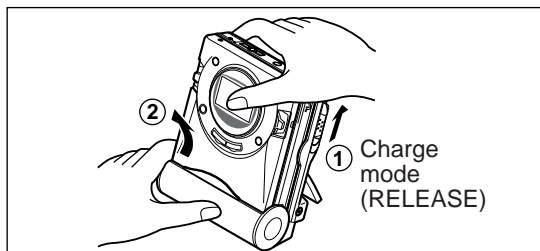

- Move the Charge / Operation switch to charge mode.

### Setting the battery charger and hanging the remote control.

When the remote control is not used, hang it on the holder for your convenience.

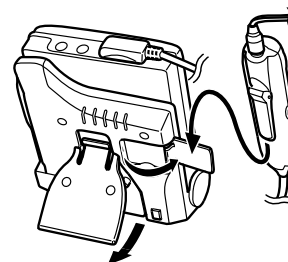

### For use with the AC adaptor.

When using the unit with AC adaptor, use it horizontally. Do not stand the unit.

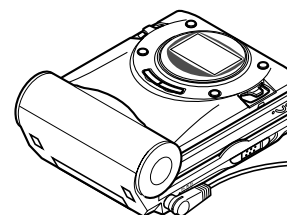



## Using with the Rechargeable Battery

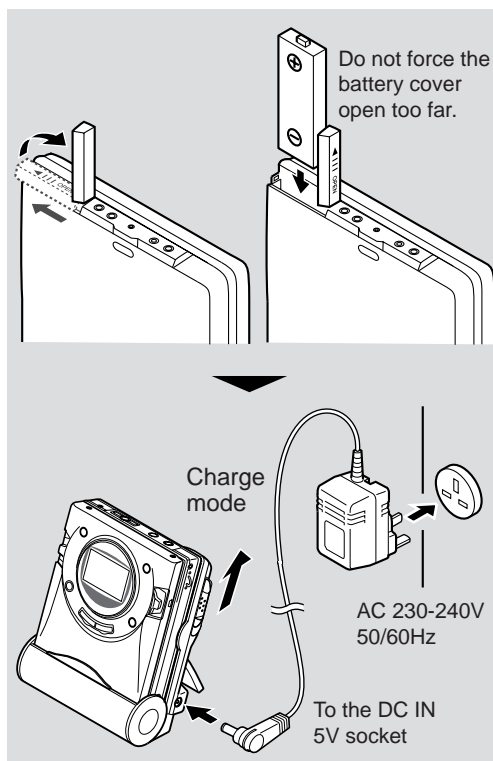

### Charging

When the rechargeable battery is used for the first time or when you want to use it after a long period of disuse, be sure to charge it fully.



- 1** Insert the rechargeable battery.
- 2** Move the Charge/Operation switch to charge mode.
- 3** Place the portable MD into the battery charger and connect the AC adaptor.

- After the rechargeable battery is charged or used, it will get slightly warm. This is normal.
- When the portable MD is turned on or operating, the battery will not be charged.

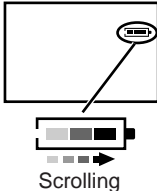
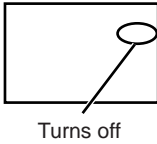

### About the liquid crystal display (LCD)

The condition of the portable MD will be shown on the LCD when inserting it into the battery charger.

Display	Conditions
	<ul style="list-style-type: none"> <li>● Charging.</li> </ul>
	<ul style="list-style-type: none"> <li>● The charging is complete.</li> <li>● When the portable MD is not inserted correctly to the battery charger, or Rechargeable terminal is dirty, it may not be possible to charge the battery. (Wipe the terminal by cotton swab.)</li> </ul>
	<ul style="list-style-type: none"> <li>● Refreshing (see page 38). The unit checks and, if necessary, discharge the rechargeable battery to recharge it automatically. (At this time battery indicator is flashing.)</li> </ul>

### About charging time

After about 3.5 hours have passed, “” will go out.

#### Notes:

- This portable MD should only be used within the range of 0°C - 40°C (32°F - 104°F).
- Charge the battery within the range of 5°C - 35°C (41°F - 95°F).
- The unit can be left in the charging state after it is completed.
- If the MiniDisc unit is not to be used for some time, remove the battery. (The battery drains gradually even when the power is turned off.)
- Carry the battery in the supplied case.

#### Caution:

- Use the specified battery AD-N55BT only. Do not charge a battery (nickel-cadmium, alkaline, etc.) other than that specified.
- Do not remove the outer cover of the rechargeable battery. It may cause heat generation, fire, or explosion.
- Do not dip the battery in water, do not dispose of it in a fire, and do not take it apart.
- If the rechargeable battery terminal is dirty, charging may not start. In such a case, wipe off the dirt with a dry cloth.
- Do not disassemble the battery.

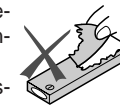



## Using with the AC Adaptor

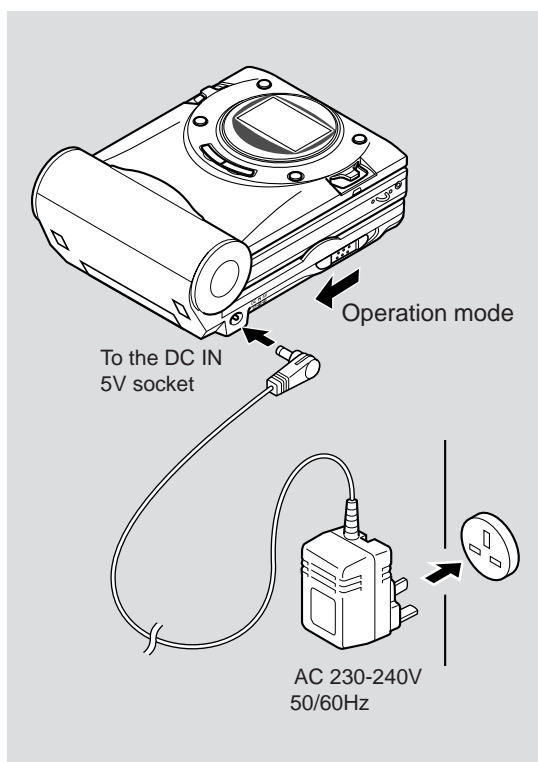

- 1** Place the portable MD to the battery charger.
- 2** Move the Charge/Operation switch to operation mode.
- 3** Plug the AC adaptor.

**Caution:**

- If the Charge/Operation switch is not set to operation mode, no operation is possible.  
(See “How to use the Charge/Operation switch”, page 11)
- When the unit is not in use for extended periods, remove the AC adaptor from the wall socket.
- Insert the plugs firmly.

**Note:**

When power failure occurs whilst playing back using the AC adaptor, disconnect the adaptor from the outlet. Otherwise, playback may start automatically when the power returns.

## Using with the Alkaline Battery

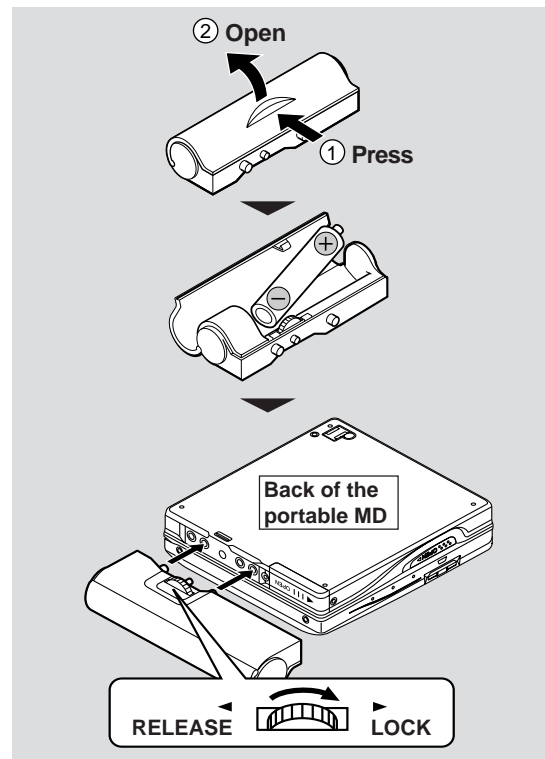

Use one commercially available alkaline battery (LR6, "AA" size).  
When using the alkaline batteries, make sure the rechargeable battery is inserted.

- 1 Open the case cover.
- 2 Insert a alkaline battery into the battery case.
- 3 Attach the battery case to the portable MD.

**Caution:**

- Do not use rechargeable batteries (nickel-cadmium battery etc.) in the battery case.



## Hold Function

The present operation condition can be kept even if other buttons are accidentally pressed in a place such as a crowded train.

### Main unit

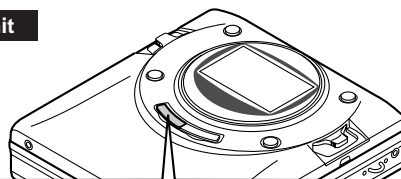

Press the **•■/ :OFF** button for 2 seconds or more.

HOLD ON Hold



HOLD OFF Release

- If the alkaline batteries are inserted or the AC adaptor is connected, you can set this function even when the power is turned off.

### To cancel the hold mode

Press and hold down for 2 seconds or more whilst the unit is in the hold mode.

- "HOLD OFF" will be shown

### Remote control unit



Move the HOLD switch to the safety position (direction indicated by the arrow).

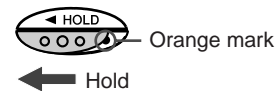

### To cancel the hold mode:

Move the HOLD switch away from the safety position (the opposite direction of the arrow).

- If the hold function is active whilst the power is turned off, the power cannot be turned on by mistake and the battery will not be drained.





## Inserting a MiniDisc

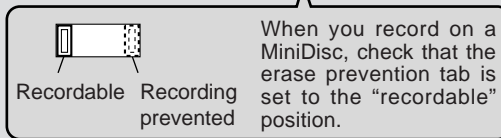
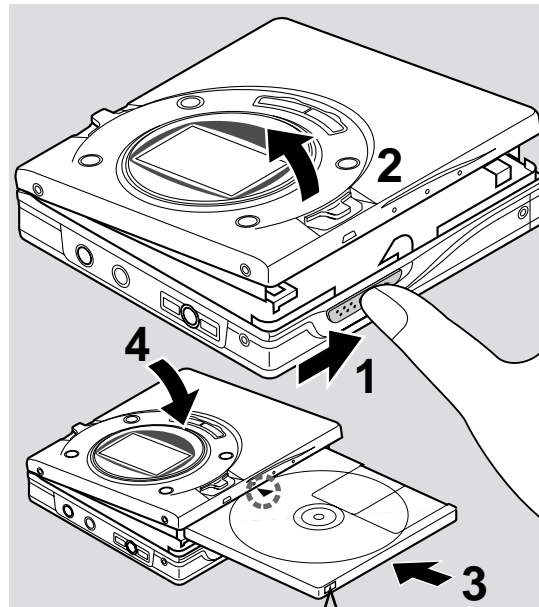

- 1** Slide the OPEN lever to release the compartment door.
- 2** Lift it up.
- 3** Insert a MiniDisc as shown.
- 4** Close the compartment door.

### Notes:

- Do not place the MiniDisc under the holder.

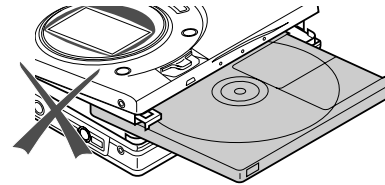

- If any resistance is felt, do not force the MiniDisc into the unit, as it may cause damage to the unit. If resistance is felt, remove the MiniDisc and reload it.
- The lid can not be opened if "TOC" is displayed refer to the instruction on page 22.



## Connections

You can record your favorite CDs or tapes to an MD.

### To connect to a stereo system with "AUDIO OUT" or "LINE OUT" sockets

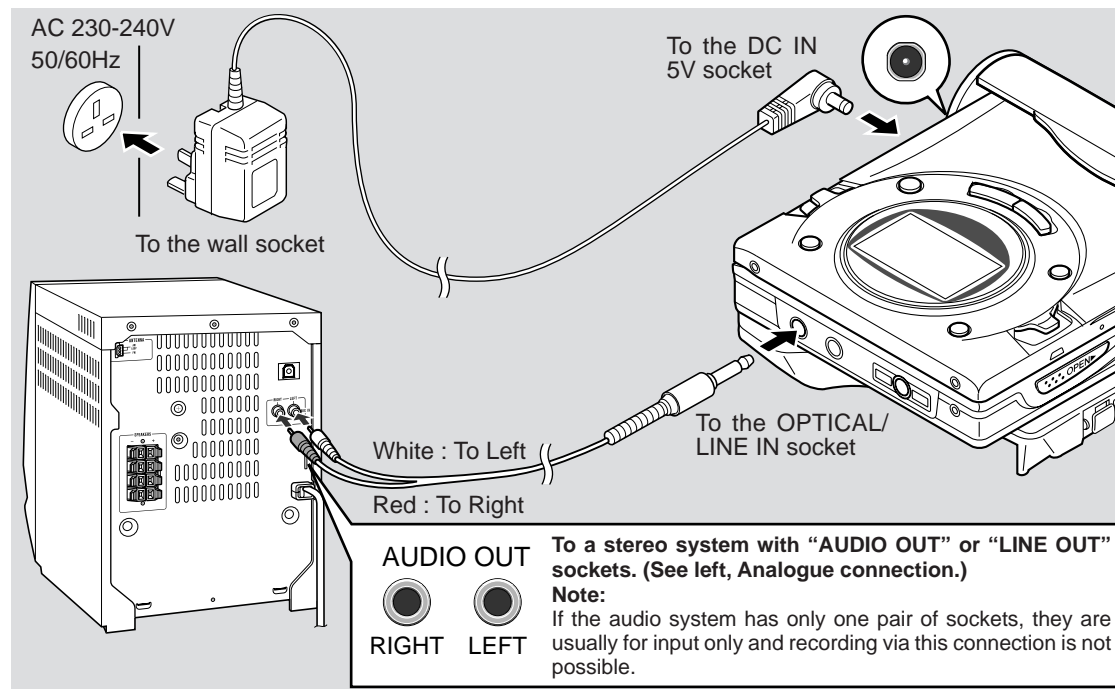



### To connect to a stereo system with a "DIGITAL OUT" or "OPTICAL OUT" socket

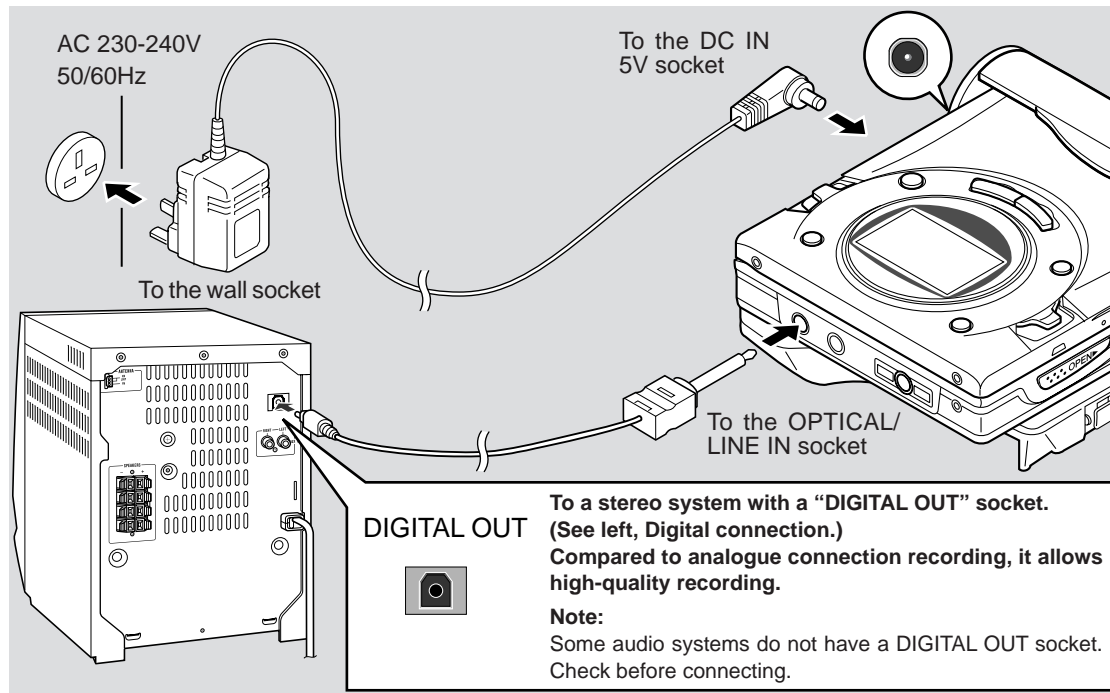

Web-site: [www.sharp.co.uk/support](http://www.sharp.co.uk/support) Help Line: 08705 274277 (office hours)



## Recording

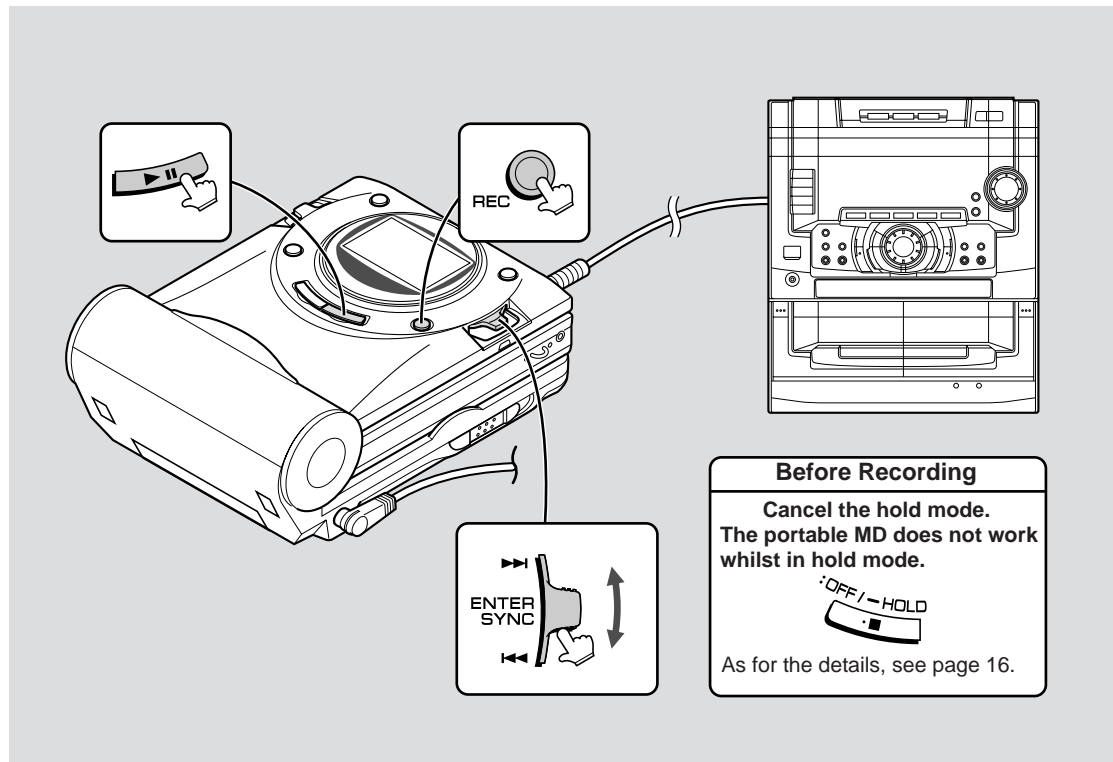



- 1 Press the REC button.**
  - Record pause mode is entered.
  - The REC button does not light.
- 2 Begin playback on the stereo system connected to this portable MD.**
  - To enable the record level to be set.
- 3 Move the right shuttle switch to ◀◀ or ▶▶ to adjust the recording level.**

#### Analogue recording

- Adjust the recording level so that the maximum sound volume from the source makes the reading swing somewhere between -4 dB and 0 dB.

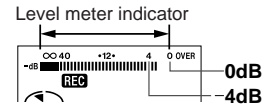

#### Digital recording

- You can adjust the level in 1 dB increments within the range of +12 - -12dB.



- Once you adjust the digital recording level, the setting remains even after the recording stops. (For cancellation instructions, see page 38.)

- 4 Press the PAUSE button on the stereo system to enter the playback pause mode at the point you wish to start recording.**
  - Here you can select the track to be recorded.
- 5 Press the ▶|| button to start the MiniDisc unit recording.**
- 6 Begin playback on the stereo system, the output will be recorded.**

#### Notes:

- Changing the volume level whilst recording does not affect the recording.
- You cannot adjust the bass level whilst recording.

## Recording (continued)

### To interrupt recording

Press the ►|| button.

- The track number will be increased by one each time the recording is interrupted.

### To stop recording

Press the ●■ / :OFF button.

- When recording stops, "TOC" appears (Table Of Contents). Whilst "TOC" appears the MiniDisc recorded contents have not yet been updated.
- To prevent the new recording from being lost it is not possible to remove the MiniDisc whilst "TOC" is displayed.

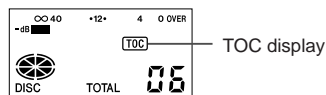

### To update the recorded contents of the MiniDisc

Press the ●■ / :OFF button whilst in the stop mode.

- The power turns off after recorded contents have been updated on the MiniDisc.



### About the TOC

After any recording or editing function "TOC" (Table Of Contents) is displayed. To finalise the recording or editing function, press the ●■ / :OFF button. During this process "TOC" will flash and "TOC EDIT!" will be displayed.

During any recording or editing function the MiniDisc unit Lid is locked, the MiniDisc can not be removed until the process is finalised.

### Warning

- If the power is removed (Battery/AC adapter) whilst "TOC" is displayed the MiniDisc unit lid will remain locked until the battery/main power is restored and the unit is turned on. Your new recordings or edited changes will be lost and your MiniDisc may become unusable.

### Caution:

- Whilst "TOC" or "TOC EDIT!" is displayed, do not do any of the following.
  - Do not jerk or bump the unit.
  - Do not unplug the AC adaptor.
  - Do not remove the rechargeable battery or an alkaline battery.
  - Do not subject the unit to shock.
 Otherwise, tracks may not be recorded properly.



### To prevent recorded MiniDiscs from being erased accidentally

Slide the accidental erase prevention tab, located on the side of the MiniDisc, in the direction indicated by the arrow.

- The MiniDisc will then be protected against accidental erasure.

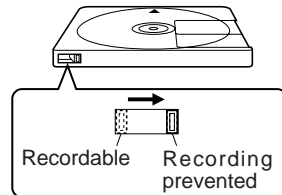

To add a recording to such a MiniDisc, slide the accidental erase prevention tab back to its original position.

### Helpful tip when attaching a label

When attaching a label to an MiniDisc cartridge, be sure to note the following. If the label is not attached properly, the MiniDisc may jam inside the unit and it may not be possible to remove it.

- If the label peels off or partially lifts away, replace it with a new one.
- Do not put a new label on top of an existing one.
- Attach the label only in the specified location.

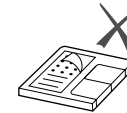



# Playback

**Before Playing back**  
**Cancel the hold mode.**  
 The portable MD does not work whilst in hold mode.

Main unit      Remote control unit

OFF / HOLD      → Release

As for the details, see page 16.

Right channel      Left channel

+

VOL.

-

SOUND

To the socket





- 1** Insert the earphones plug firmly into the earphones socket on the remote control unit.

---

- 2** Plug the remote control into the  $\Omega$  socket on the unit.

---

- 3** Insert a MiniDisc (page 17).

---

- 4** Press the **▶||** button.
  - Playback starts automatically with a playback only MiniDisc or a MiniDisc which is protected against accidental erasure (Auto-play function).

**To interrupt playback**

Press the **▶||** button.

- To resume playback, press the **▶||** button again.

**To stop playback**

Press the **●■** / :OFF button.

- If the unit is not operated for at least 2 minutes whilst in the stop mode, the power will shut off automatically.

**To turn off the power**

Press the **●■** / :OFF button whilst in the stop mode.

**Volume control**

Move the left shuttle switch to VOL+ to increase the volume and the left shuttle switch to VOL- to decrease the volume.

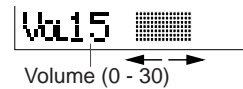
**Bass control**

Each time the left shuttle switch is pressed toward "BASS" (Remote control: the SOUND button is pressed), the tone will be switched as follows.

BASS 1	Emphasised slightly
BASS 2	Emphasised more
BASS 3	Emphasised fully
BASS OFF	Cancelled

**Notes:**

- If power failure occurs whilst playing a disc using the AC adaptor, disconnect it from the wall socket. Otherwise, playback may start automatically when electricity resumes.
- If you connect the AC adaptor without installing the rechargeable battery, playback may start automatically. Be sure to turn off the power.
- Reduce the volume before starting to play. MiniDiscs, compared to ordinary cassette tapes, have very little noise. If the volume is adjusted according to your usual expectations of noise, high volume may damage your hearing.
- The sound escaping from your earphones may annoy people around you. In particularly crowded places (such as on trains or buses), reduce the volume.

**Web-site:** [www.sharp.co.uk/support](http://www.sharp.co.uk/support) **Help Line:** 08705 274277 (office hours)



## Advanced Playback

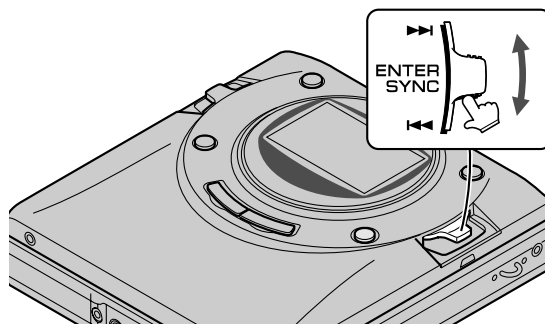

### To locate the desired portion

#### For audible fast forward:

Move and hold the right shuttle switch to ►► during playback.

#### For audible fast reverse:

Move and hold the right shuttle switch to ◀◀ during playback.

- Normal playback will resume when the right shuttle switch to ◀◀ or ►► is released.
- When the end of the last track is reached during fast forward, the unit will enter the pause mode. When the beginning of the first track is reached during fast reverse, the unit will enter the playback mode.

### To locate the beginning of a track

#### To move to the beginning of the next track:

Move the right shuttle switch to ►► during playback.

#### To re-start the track being played:

Move the right shuttle switch to ◀◀ during playback.

#### To locate the next track:

Move the right shuttle switch to ►► whilst the unit is stopped.

#### To locate the previous track:

Move the right shuttle switch to ◀◀ whilst the unit is stopped.

- To skip a number of tracks at one time, move the right shuttle switch to ◀◀ or ►► repeatedly until the desired track number is shown.
- When you press the ►|| button, play back starts from the beginning of the track.

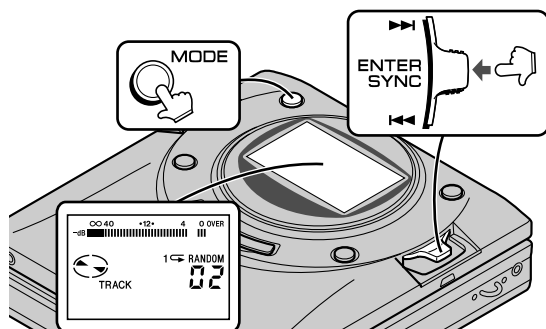

### Random play or repeat play

During playback, press the MODE button repeatedly to select the playback mode.

RANDOM	Random play
↺RANDOM	Repeat play of tracks in random order
↺	Repeat play of all of the tracks
1↺	Repeat play of a single track
No display	Normal playback

### To play at double speed (Mono recording only)

Press the right shuttle switch toward "ENTER/SYNC" whilst a MiniDisc recorded in the monaural long-play mode is being played. **FAST PLAY**

- If a track recorded in the stereo mode is reached during fast playback, the fast playback mode will be cancelled.
- Depending on the contents recorded on a MiniDisc, it may be difficult to hear them.

### To interrupt fast playback

Press the ►|| button during playback. When the ►|| button is pressed again, the unit will resume fast playback.

### To return to normal playback

Press the right shuttle switch toward "ENTER/SYNC".

### Notes:

- If the playback mode is selected whilst stopped, press the ►|| button to start playback.
- When "TOC" is displayed, random play or repeat play is impossible.
- In random play the unit will select and play tracks automatically. (You cannot select the order of the tracks.) After all of the tracks have been played once each in random order, the unit will stop automatically.
- During random, random repeat, or single track repeat play, you can forward or reverse the MiniDisc only within the track being played.
- During random play, the unit cannot find the beginning of any track which has been played.
- Repeat play lasts until you stop the unit.



## Advanced Recording

### Playback sound-actuated recording (Synchronised recording)

Recording automatically starts or pauses by detecting sound from the stereo system (Synchronised recording).

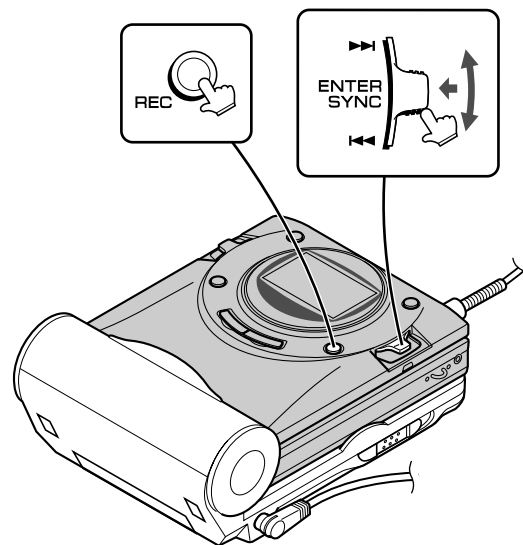

- 1 Press the REC button.
- 2 Begin playback on the stereo system connected to this portable MD.
- 3 Move the right shuttle switch to ◀◀ or ▶▶ to adjust the recording level.
- 4 Press the PAUSE button on the stereo system to enter the playback pause mode. (See page 18,19)
  - Select the starting point for your recording and press the PAUSE button.
- 5 Press the right shuttle switch toward “ENTER/SYNC”.
- 6 Begin playback on the stereo system. Recording will begin automatically.

#### To interrupt recording:

- When the stereo system is stopped, the unit will enter the synchro recording pause mode. When playback is resumed, the recording will be resumed.
- If a silence lasts for 3 seconds or more, the recording will be paused (Pause function does not work for approximately 10 seconds after a recording starts).
- When the unit receives sound again, recording automatically starts.
- A new track number is created when the recording resumes.



### Long-play recording (monaural recording)

When recording in long-play mode, the available recording time will be doubled. Long-play recordings can be replayed at double speed, see page 27.

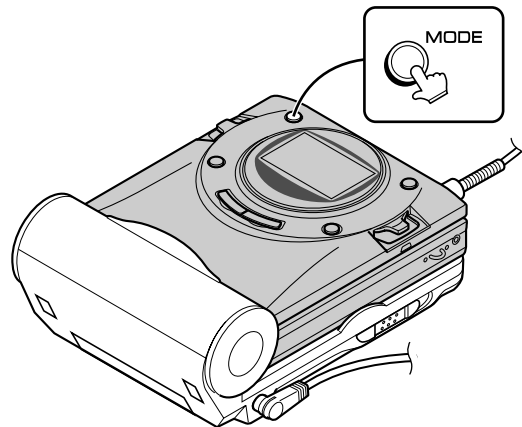

#### 1 Press the MODE button whilst the recording is paused.

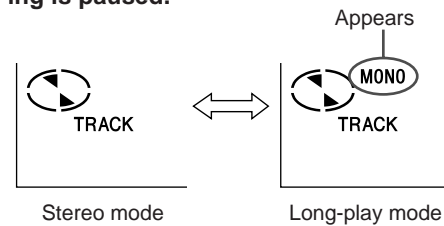

- "MONO" appears whilst in the long-play mode.

#### 2 Start recording.

##### Notes:

- When the unit is stopped after a recording has been made in this mode, the recording mode will return to the stereo mode automatically.
- If input is from a stereo source, the sounds from the left and right channels will be combined.
- Although the monitor sound you hear in the earphones whilst recording is in stereo, recording will be monaural.
- MiniDiscs recorded in the monaural long-play mode may not play on other MiniDisc players.



## Advanced Recording (continued)

### To start recording from the middle of a track

You can erase a portion of a track and make a new recording.

- All of the tracks that follow the newly recorded track will be erased.

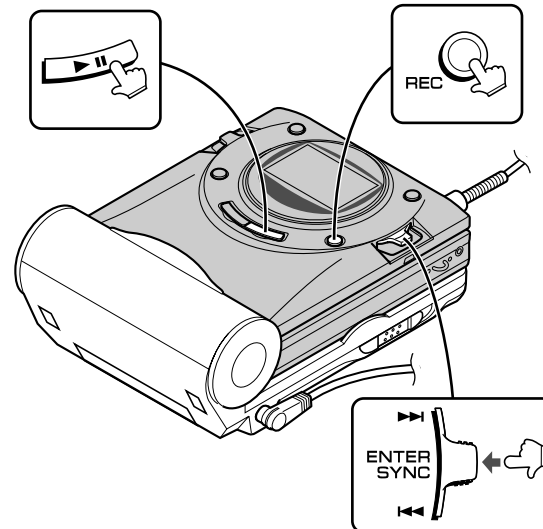

**1** During playback, press the ▶|| button at the point where you want to begin recording.

**2** Press the REC button.

ERASE OK?

- To cancel the operation, press the ●/■ / :OFF button.

**3** Press the right shuttle switch toward “ENTER/SYNC”.

- All of the tracks and track names will be erased, following the point where the playback is paused.

**4** Press the ▶|| button.

- Recording will start.

**Note:**

- To keep a track after the point you want to make a new recording, move the track and then make recording after that point.

(See “Editing a Recorded MiniDisc”, page 46.)



### To create your own track numbers

You can create your own track numbers at any point.

**Whilst recording, press the REC button at the point where you want to create track numbers.**

The track number will be increased by one.

- One track number will be created every time the REC button is pressed.
- The SOUND button on the remote control can also be used to create track numbers.

### Recording tracks as a single track

You can record several pieces of music as a single track by disabling the auto marker function.

**When a recording is paused or whilst recording...**  
Press the EDIT button.

AUTO MARK ↔ MARK OFF

**Note:**

- When making digital recordings using a CD player or an MiniDisc player, track numbers will be created automatically regardless of the setting of the auto marker function.



## Advanced Recording (continued)

### About track numbers

- Track numbers are created automatically during recording via the analogue connection when a silence of 1 second or more is detected (Auto marker function). A series of tracks can be recorded as one by disabling the auto marker function see page 31.

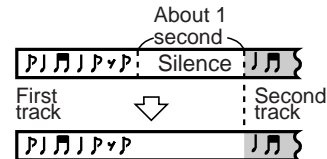

- When recording from a CD or a MiniDisc using the digital connection, track numbers will be created at the same points as on the CD or MiniDisc (Synchro marker function).

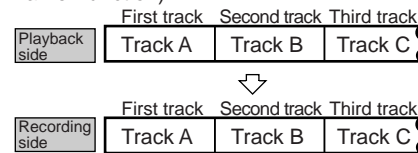

- Track numbers may not be created in proper places, depending on the source to be recorded from, such as signals with noise.
- The track numbers on the playback side may not match the track numbers recorded on the MiniDisc.

- When recording, if a programmed playback is performed by the source or playback is performed by selecting tracks manually, the MiniDisc track numbers may not be the same as on the source.
- Track numbers may not be created properly, depending on the connected stereo system.

### About sampling rate converter

This portable MD incorporates a sampling rate converter meaning it can record from digital radios or DAT tape recorders.

### Note for digital recording

You can not copy a MiniDisc that you recorded from digital inputs to another MiniDisc or DAT. It is prevented by the SCMS (Serial Copy Management System). Recording from analogue inputs is not affected.

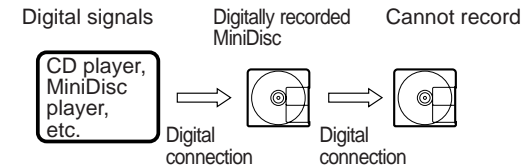





## Recording from a Microphone

### To record from a microphone

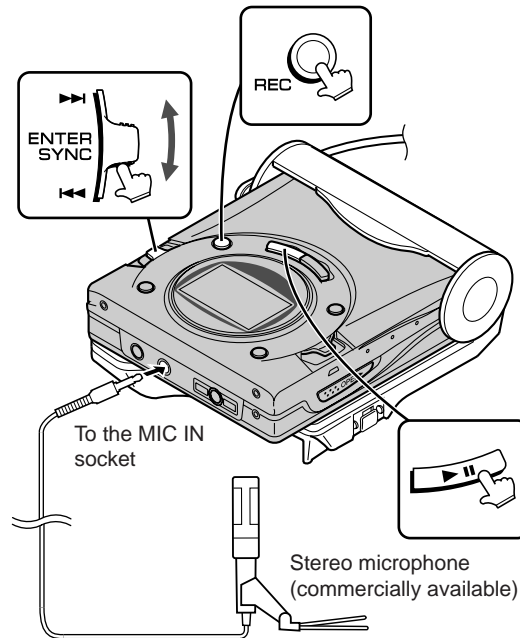

- 1 Connect a stereo microphone to the MIC IN socket.
- 2 Insert a recordable MiniDisc (page 17).
- 3 Press the REC button.
- 4 Move the right shuttle switch to ◀◀ or ▶▶ to adjust the recording level.

Level meter indicator

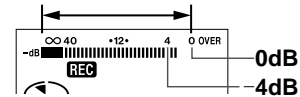

- Adjust the recording level so that the maximum sound volume from the source makes the reading swing somewhere between -4 dB and 0 dB.

- 5 Press the ▶|| button.
  - Recording will start.

#### To interrupt a recording

Press the ▶|| button whilst recording.

- To resume recording, press the ▶|| button again. The track number will be increased by one each time you interrupt a recording.

#### To stop recording

Press the ●■ / :OFF button.

#### To write recorded contents on the MiniDisc

Press the ●■ / :OFF button whilst in the stop mode.

Web-site: [www.sharp.co.uk/support](http://www.sharp.co.uk/support) Help Line: 08705 274277 (office hours)



## Recording from a Microphone (continued)

### Sound-actuated recording (Mic Synchronised recording)

- 1 Press the REC button.
- 2 Move the right shuttle switch to ◀◀ or ▶▶ to adjust the recording level.

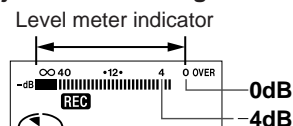

- 3 Press the right shuttle switch toward “ENTER/SYNC” to select the recording sensitivity.

MIC SYNC H : Recording starts when the unit detects -24 dB or more (The unit can start recording from quiet sounds).

MIC SYNC L : Recording starts when the unit detects -12 dB or more.

- 4 When a sound, such as person speaking, is picked up by the microphone, recording will begin automatically.

### About pause function

The unit automatically pauses when the microphone does not pick up any sound for 3 seconds or more. (Pause function does not work for approximately 10 seconds after a recording starts.) When the microphone picks up sound again, recording starts automatically.

### Notes:

- Whilst making a mic recording, do not connect anything to the OPTICAL/LINE IN socket on the portable MD.
- To use a microphone, be sure it is a plug-in-power type microphone.
  - When a plug-in-power type microphone is plugged in, the portable MD will provide power for the microphone's operation.
  - If a different type of microphone is plugged in, it may not operate properly or it may cause the unit to malfunction.
- Insert the plug firmly. If you don't, the recording will not be made properly.
- Use a microphone with a 3.5 mm (1/8") diameter stereo mini plug.
- If the unit starts recording too often from low unwanted noises, set the microphone input to “MIC SYNC L”.
- Recording sensitivity can be changed whilst recording.



### Track intervals

When recording from the microphone, track numbers will be created automatically at regular intervals (default setting: approximately every 5 minutes). During a mic synchro recording, the unit pauses when a silence lasts for 3 seconds or more, and creates a track number.

#### Changing intervals between tracks

**1** When a recording is paused or whilst recording, press the EDIT button repeatedly.

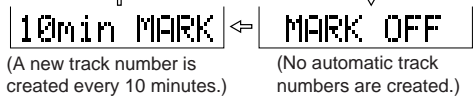
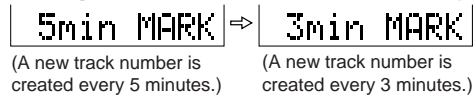

- The interval between marks may vary slightly compared with the actual recording time.

**2** Track numbers will be created automatically at regular intervals.

#### Creating track numbers manually

Press the REC button whilst recording.

Example: Set to "5 minutes".

#### During a mic manual recording

- Timed auto marks will be created every 5 minutes.

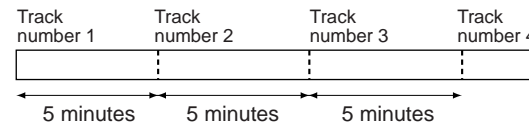

#### During a mic synchro recording

If a silence lasts for 3 seconds or more, a timed auto mark will be created 5 minutes after the previous mark is created.

--- : Track number which is created by the timed auto mark function.  
 — : Track number which is created when a silence lasts for 3 seconds or more during synchro recording.

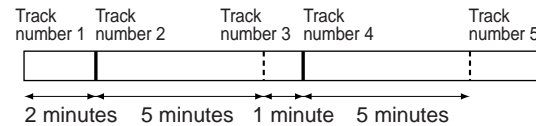



## Checking Displays

### To check the elapsed time and remaining time of the track

During playback, press the DISP button. Each time the button is pressed, the display will change as follows:

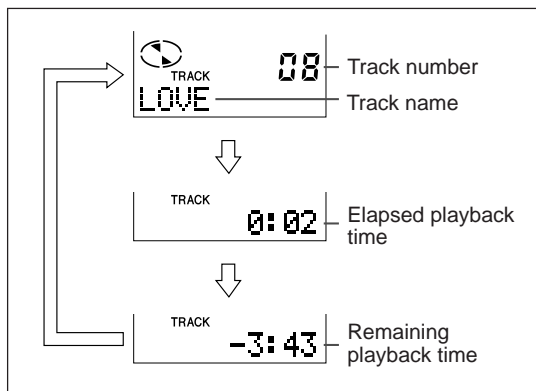

#### Notes:

- If the disc name or the track name was not originally recorded on the MiniDisc, "NO NAME" will be displayed.
- Remaining recording time will not be displayed with a playback only MiniDisc.
- Elapsed playback time and remaining playback time may be different from the actual time.

### To check the remaining recording time and the total playing time

Whilst in the stop mode, press the DISP button. Each time the button is pressed, the display will change as follows:

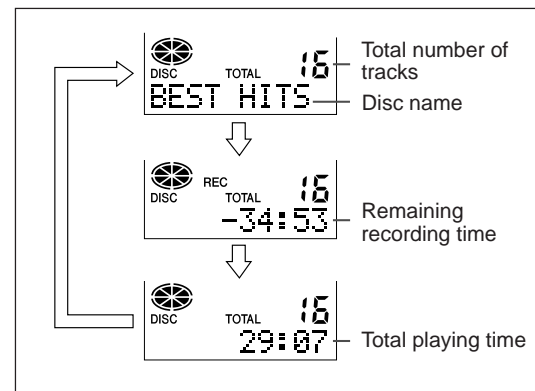



### To display the playing time of an individual track

**1** Whilst in the stop mode, move the right shuttle switch to **◀◀** or **▶▶** to display the track number and track name.

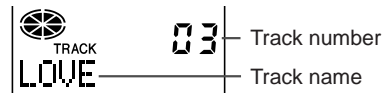

**2** Press the DISP button to display the playing time for that track.



- Each time the right shuttle switch to **◀◀** or **▶▶** is moved, the playing time of the previous or next track will be displayed.

### Checking the remaining amount of battery level

The remaining amount of battery level is shown by the battery indicator ( ) during operation.

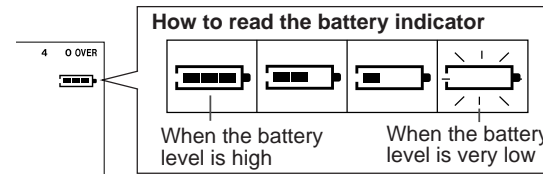

- When the battery is completely discharged, the battery indicator will flash. Recharge the battery or replace the alkaline battery with a new one.
- When the battery has run completely out, "BATT EMPTY (LoBATT)" will appear. Then, the power will be disconnected automatically.

#### Notes:

- If you use the battery which you stopped charging halfway, " " may appear. It does not mean that the battery is completely charged.
- The battery indicator will not correctly display the remaining capacity for approximately 10 seconds after the power has been turned on.
- When the AC adaptor or a separately available car adaptor is used, the battery indicator will not be shown.
- The number of bars shown in the battery indicator may increase or decrease, depending on the operation being performed. This is normal.



## Changing Default Settings

Whilst in the stop mode ...

- 1** With a MiniDisc inserted, press the **MODE** button for 2 seconds or more. “SET UP” will appear.



- When you release the button, “BEEP ON” or “BEEP OFF” will appear.

- 2** Move the right shuttle switch to **◀◀** or **▶▶** to display the menu.



- 3** Press the **MODE** button to switch items.



- 4** Press the **•■ / :OFF** button.

MENU	SETTING ITEM	
BEEP ON confirmation sound	BEEP ON* BEEP OFF	Beep Silent
EL ON display backlight	EL ON 1* EL ON 2 EL OFF	Turn on Turn on Turn off
A-PLAY ON auto play	A-PLAY ON* A-PLAY OFF	Setting Cancelled
AUTO Psave auto power save	AUTO Psave* Psave OFF	Setting Cancelled
D.L MODE 1 digital recording level	D.L MODE 1* D.L MODE 2	Setting keep Cancelled
RFRESH ON refresh	RFRESH ON* RFRESH OFF	Setting Cancelled
LIGHT ON LCD edge light	LIGHT ON* LIGHT OFF	Setting Cancelled

(\*) indicates default setting.



### Beep sound

You can eliminate the confirmation sound that beeps when you press a button.

### Display backlight on the remote control

#### “EL ON 1”

When any button is pressed, the backlight will remain lit for about 10 seconds.

#### “EL ON 2”

When the rechargeable battery, alkaline battery or car adaptor is used, the backlight will remain lit for about 10 seconds.

When the battery charger is used and the power is turned on, the backlight will always be lit.

#### “EL OFF”

Light will not be turned on.

### Auto play

You can make the unit not play automatically when you insert a playback-only MiniDisc or an accidental erasure protected MiniDisc.

### Auto power save

When the unit is used in a place exposed to much vibration, sound skipping can be decreased by cancelling the auto power save function. (Battery will drain faster.)

### Digital recording level

#### “D.L MODE 1”

The digital recording level you set will be kept even after canceling recording.

#### “D.L MODE 2”

Every time you cancel recording, the level will return to [ D.L 0dB ].

### Refresh

If you charge the battery before it runs out completely, the operating time may be shortened. To avoid this, the battery will be discharged and refreshed automatically. You can cancel this function.

### LCD edge light

Whilst in [ LIGHT ON ] mode, LCD edge lights flash according to the function.

#### What is auto power save function?

Auto power save function automatically adjusts the sound skip memory storage to be from 5 to 10 seconds depending on playback conditions, this saves battery power.









If the MiniDisc unit is used in areas of much vibration it may be necessary to fix the sound skip memory to 10 seconds “Psave OFF (PS off)” this will improve performance under difficult conditions but uses more power. (When the AC/car adaptor is used the 10 second mode is always used.)

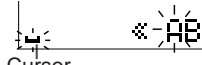

## Titling a MiniDisc

### Creating disc and track names

One disc name and up to 255 track names can be created per disc (A maximum of 100 characters for the disc and each track name and a total of 1,700 characters can be entered).

1	Disc name	Track name			
	Whilst in the pause mode, press the EDIT button repeatedly to select "DISC NAME".	Whilst in the pause mode, press the EDIT button repeatedly to select "TRACK NAME".			
					
<b>2</b>	Press the right shuttle switch toward "ENTER/SYNC".				
					
	<ul style="list-style-type: none"> <li>The unit will enter the character input mode.</li> <li>The MiniDisc lid will be locked, to cancel the operation, press the  / :OFF button.</li> </ul>				
<b>3</b>	Press the DISP button repeatedly to select the type of characters.				
					
	<table border="1"> <tr> <td>ABC (Capital letters)</td> <td>abc (Lower-case letters)</td> <td>123 (Numbers and symbols)</td> </tr> </table> <ul style="list-style-type: none"> <li>The first 3 characters in the group of the selected characters will be displayed for about 1 second.</li> </ul>		ABC (Capital letters)	abc (Lower-case letters)	123 (Numbers and symbols)
ABC (Capital letters)	abc (Lower-case letters)	123 (Numbers and symbols)			

**4** Move the right shuttle switch to  or  repeatedly to select the letter.



**5** Press the right shuttle switch toward "ENTER/SYNC" to enter it.

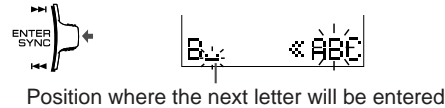

**6** To enter more letters, repeat steps 3 - 5.

**7** When the name has been completely entered, press the EDIT button.



**8** TOC will be displayed to write the updated contents to the MiniDisc press the  / :OFF button.

- You cannot remove the MiniDisc whilst TOC is displayed. TOC will not disappear until the recorded contents have been updated.





### To erase a character

Move the left shuttle switch to VOL + or VOL - to move the cursor to the character you want to erase, and then press the left shuttle switch toward "BASS".

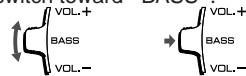

### To enter a space

Move the left shuttle switch to VOL + to move the cursor to the right.



### Characters (symbols)

Capital letters



Lower-case letters

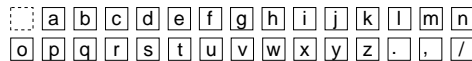

Numbers and symbols

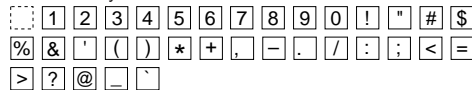

□ : indicates a space.

### To add characters

**1** Put the unit in the character input mode. (Perform steps 1 - 2 on page 40.)

**2** Move the left shuttle switch to VOL + or VOL - to move the cursor to the right of the character, where you want to add a new character.



**3** Select the character to add. (Perform steps 3 - 4 on page 40.)

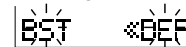

**4** Press the right shuttle switch toward "ENTER/SYNC".



**5** Press the EDIT button.



**6** TOC will be displayed to write the updated contents to the MiniDisc press the **•■/ :OFF** button.

- You cannot remove the MiniDisc whilst TOC is displayed. TOC will not disappear until the recorded contents have been updated.



## Titling a MiniDisc (continued)

### Stamping titles from another MiniDisc

#### Before stamping

When there are 2 MiniDiscs on which the same tracks are recorded, you can transfer the character information (disc and track names) of the Master MiniDisc to another MiniDisc (for stamping).

#### 1. What is a master MiniDisc?

A recordable MiniDisc that contains tracks and character information.  
(You can not transfer the information from a play-back only MiniDisc.)



#### 2. What is a MiniDisc for stamping?

A MiniDisc that contains the same tracks in the same order as the master MiniDisc.  
(Make sure that the total number of tracks of the master MiniDisc and the one for stamping are the same.)



#### Master MiniDisc operation

#### 1 Insert a Master MiniDisc.



- Do not mistake the Master MiniDisc for the target one.
- If you turn off the unit after inserting the master MD, the operation from step 2 may not allow the unit to stamp the titles correctly.

#### 2 Whilst in the stop mode, press the EDIT button repeatedly to select "NAME STAMP".



NAME STAMP

#### 3 Press the right shuttle switch toward "ENTER/SYNC".



READ OK?

- To cancel the operation, press the ■/ :OFF button.

#### 4 Press the right shuttle switch toward "ENTER/SYNC".



Reading! CHANGE MD



**5** When the unit displays “CHANGE MD”, remove the master MiniDisc.

- Remove it without turning off the power. Or, the operation will be cancelled.



**Operation of the MiniDisc for stamping**

**6** Load a MiniDisc for stamping.

```

INSERT MD
  ▼
TOC READ
  ▼
WRITE OK?
  
```

**7** Press the right shuttle switch toward “ENTER/SYNC”.



```

Writing!
  ▼
COMPLETE
  
```

- The unit will finish recording the character information and enter the stop mode.

**Notes:**

- If the total number of tracks on the master MiniDisc does not match that on the MiniDisc for stamping, the unit will display “Can't STAMP” and turn off the power.

Can't STAMP

If this happens, adjust the total number of tracks on the newly recorded MiniDisc using the edit operation.

- Use a MiniDisc that was recorded by this portable MD to make a MiniDisc for stamping. Character information may not be transferred if you use a MiniDisc recorded by other equipment. In such a case, enter at least one character for the disc name or the track names. You can transfer information once you record the TOC.



## Editing a Recorded MiniDisc

### To erase tracks one at a time

**1** Start playing the track to be erased, and press the button.

**2** Press the EDIT button repeatedly to select “ERASE”.



**3** Press the right shuttle switch toward “ENTER/SYNC”.



● To cancel the operation, press the / :OFF button.

**4** Press the right shuttle switch toward “ENTER/SYNC” again.



● The track will be erased.

**5** To erase other tracks, repeat steps 1 - 4.

### To erase all of the tracks at once

**1** Whilst in the stop mode, press the EDIT button repeatedly to select “ALL ERASE”.



**2** Press the right shuttle switch toward “ENTER/SYNC”.



● To cancel the operation, press the / :OFF button.

**3** Press the right shuttle switch toward “ENTER/SYNC” again.



● All of the tracks will be erased.

**Caution:**

Once a track has been erased, it can not be recovered. Check the track number before erasing it.



### To divide a track

**1** Start playing the track to be divided into two. Press the button at the point where you want to divide the track.

**2** Press the EDIT button repeatedly to select "DIVIDE".



**3** Press the right shuttle switch toward "ENTER/SYNC".



- To cancel the operation, press the :OFF button.

**4** Press the right shuttle switch toward "ENTER/SYNC" again.



- The track will be divided into two tracks, and the unit will pause at the beginning of the second of the two new tracks.

### To combine tracks

**1** Start playing the last of the two tracks to be combined, and press the button.

**2** Press the EDIT button repeatedly to select "COMBINE".



**3** Press the right shuttle switch toward "ENTER/SYNC".



- To cancel the operation, press the :OFF button.

**4** Press the right shuttle switch toward "ENTER/SYNC" again.



- The two tracks will be combined, and the unit will be paused at the beginning of the combined track.



## Editing a Recorded MiniDisc (continued)

### To move a track

**1** Play the track to be moved, and press the  button.

**2** Press the EDIT button repeatedly to select “MOVE”.



MOVE

**3** Press the right shuttle switch toward “ENTER/SYNC”.



05 → 01 ?

- To cancel the operation, press the  / :OFF button.

**4** Move the right shuttle switch to  or  to select the direction.



05 → 03 ?

**5** Press the right shuttle switch toward “ENTER/SYNC” again.



- The track will be moved, and the unit will be paused at the beginning of the track.

#### When a track has a name before dividing:

- The two new tracks will have the same name. However, in the TOC FULL condition, the second track may not be named.

#### Total number of tracks that can be divided:

- Each disc can hold up to 255 tracks. However, even if the number of assigned tracks has not reached 254, it might not be possible to make any further divisions of tracks.

#### To combine two non-adjacent tracks:

- First, put the two tracks next to each other in the order you want using the MOVE function. Then combine them using the COMBINE function.

#### When one or both tracks to be combined have a name:

- The first track name will be used. However, when the first track does not have a name, the second track name will be used.

#### In the following cases, tracks may not be combined:

- Tracks recorded by different inputs cannot be combined.  
Example:
  - Digital recorded track and analogue recorded track.
  - Long play recorded track and stereo recorded track.
- Tracks whose recording time is less than 12 seconds.

## Listening to a MiniDisc Through a Stereo System or a Car Stereo

### Listening through a stereo system

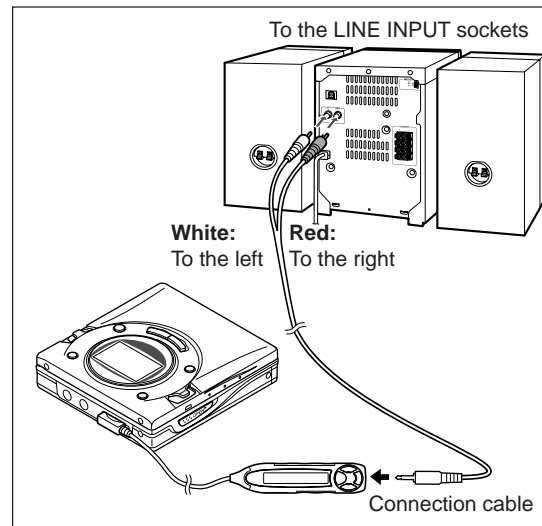

#### Notes:

- When recording with stereo system, eliminate the confirmation sound (page 38). Otherwise, it will also be recorded.
- The recording will be made in the analogue mode.
- Character information will not be recorded.

### Listening through a car stereo

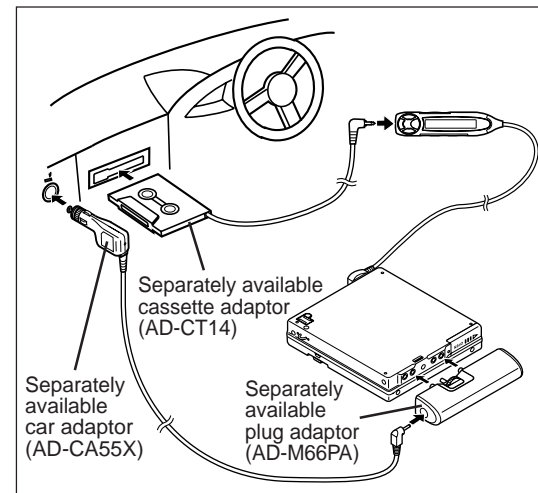

#### Notes:

- Adjust the volume of both this portable MD and a car stereo.
- Do not operate this portable MD whilst you drive a car. It may distract your attention and cause a traffic accident.
- Do not use any car adaptor except for the separately available AD-CA55X.
- Remove the battery when you power the unit from the car battery.

Web-site: [www.sharp.co.uk/support](http://www.sharp.co.uk/support) Help Line: 08705 274277 (office hours)



## Other Features and Caution

### Resuming auto play

- When you stop playback and replay the MiniDisc without removing it, playback starts from the point you stopped it.

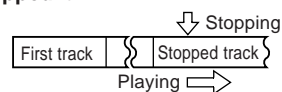

- Once you remove the MiniDisc, playback starts from the first track.

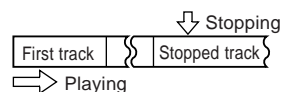

- The unit provides the following functions when you use it with the separately available car adaptor (AD-CA55X) (when the rechargeable or alkaline battery is removed):

1. When you turn off the engine, the power of this portable MD also turns off. (It may not work with some types of cars.)
2. When you restart the engine, playback starts from the beginning of the stopped track.

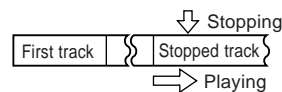

### Rechargeable battery

- A rechargeable nickel-metal hydride battery is the only kind that can be used. Even if the battery is not used, you should charge it at least once every three months because of the special quality of this battery.
- The rechargeable battery can be charged approximately 300 times.
- When the operating time is reduced to about half the normal amount of time, even after a full charge is performed, replace the battery with a new one (AD-N55BT).
- When the battery is charged for the first time or is charged after not being used for a long period, the operating time may be shorter than normal. The battery life will recover with normal use i.e. charging and discharging.
- To avoid shortening the service life of the battery only recharge the battery after it has been completely discharged.
- If the rechargeable battery is used in a cold environment, the operating time will be reduced.
- Do not carry the battery in your pocket or a bag together with metal objects (keys, coins, jewelry, etc.). The battery may short out and generate significant amounts of heat.
- Do not short-circuit the terminals as they will become very hot and will damage the battery.
- Do not drop or subject the battery to shock.
- Do not insert objects (metal etc.) into the battery compartment of this product or into the rechargeable battery.





## MiniDisc System Limitations

The unit may have the following symptoms whilst recording or editing. The unit is not out of order.

SYMPTOM	LIMITATIONS
<b>“DISC FULL” or “TOC FULL” appears even though the MiniDisc still has recording time left.</b>	More than 255 tracks (maximum) cannot be recorded regardless of the recording time. If the MiniDisc is recorded or edited repeatedly or if it has scratches (recording skips scratched parts), you may not be able to record the maximum tracks above.
<b>The remaining recording time does not increase even though you erased tracks.</b>	The unit does not count non-recorded portions that last 12 or fewer seconds to display the remaining recording time. The time may not increase even if you erase short tracks.
<b>The total of the recorded time and the remaining time does not match the maximum recordable time.</b>	One cluster (approximately 2 seconds) is the minimum unit for recording. For example, a 3-second track uses 2 clusters (approximately 4 seconds). Therefore, the actual recordable time may be shorter than the displayed time.
<b>Combine function does not work.</b>	A MiniDisc on which recording and editing are repeated may not allow the combine function.
<b>Sound skips in fast reverse/forward.</b>	One track is divided and recorded in separate places on a repeatedly recorded or edited MiniDisc. Sound may skip.
<b>A track number is created in the middle of a track.</b>	A track number may be created if there are scratches or dust on the MiniDisc.

**Web-site:** [www.sharp.co.uk/support](http://www.sharp.co.uk/support) **Help Line:** 08705 274277 (office hours)



## Error Messages

ERROR MESSAGES	MEANING	REMEDY
<b>BATT EMPTY (LoBATT)</b>	● The battery is run down.	● Charge the rechargeable battery or replace the alkaline battery (or use the AC adaptor for power).
<b>BLANK MD (BLANK)</b>	● Nothing is recorded.	● Replace the disc with a recorded disc.
<b>Can't COPY (Can'tC)</b>	● You tried to record from a copy prohibited MiniDisc.	● Record using the analogue cable.
<b>Can't EDIT (Can'tE)</b>	● A track cannot be edited.	● Change the stop position of the track and then edit it.
<b>Can't READ * (Can'tS) (Can'tT) (Can'tU)</b>	● The disc data cannot be read because the disc is damaged.	● Reload the disc. ● Replace it with another recorded disc.
<b>Can't REC (Can'tR)</b>	● Recording cannot be performed correctly due to vibration or shock.	● Re-record or replace it with another recordable disc.
<b>Can't STAMP</b>	● Stamp function does not work.	● Check the number of tracks.
<b>Can't WRITE (Can'tW)</b>	● Cannot save the TOC information correctly to a MiniDisc. (A large portion of the disc has been damaged.)	● Replace the disc with another recordable disc.
<b>CHARGEmode</b>	● The Charge/Operation switch is not set to the operation mode when using this unit with the AC adaptor.	● Set the Charge/Operation switch to the operation mode.
<b>DEFECT (DEFECT)</b>	● The disc is scratched.	● If the sound you hear is not right, record again. ● Replace the disc with another recordable disc.
<b>DISC FULL</b>	● The disc is out of recording space.	● Replace it with another recordable disc.
<b>Er-MD ** (ErMD*)</b>	● The microprocessor has reported a system fault and the unit is out of order.	● To have it repaired, go to the distributor where you purchased the unit.
<b>HOLD (HOLD)</b>	● The unit is in the hold mode.	● Return the HOLD switch to its original position.
<b>LOCKED (Can'tLOCK)</b>	● You removed a MiniDisc whilst recording or editing.	● Turn off the power and remove the MiniDisc.

Web-site: [www.sharp.co.uk/support](http://www.sharp.co.uk/support) Help Line: 08705 274277 (office hours)



ERROR MESSAGES	MEANING	REMEDY
<b>NO DISC</b>	● A disc has not been loaded.	● Load a disc.
<b>NO SIGNAL (noSIG.)</b>	● Poor connection of the digital cable. ● No output signal comes out from the connected unit to playback. ● The input signal has improper sampling frequency.	● Connect the digital cable securely. ● If the portable CD player has a function to prevent sound skips, deactivate it. ● Playback with the connected unit.
<b>PLAY MD (PLAYmd)</b>	● You recorded on a playback-only disc.	● Replace it with a recordable disc.
<b>POWER ?</b>	● The battery charger is defective.	● To have it repaired, go to the distributor where you purchased the unit.
<b>PROTECTED</b>	● The write protection tab of a MiniDisc is set to the protected position. ● You tried to record on a playback-only disc.	● Move the write protection tab back to its original position. ● Replace it with a recordable MiniDisc.
<b>SORRY (SORRY)</b>	● Since a track number is currently being located or updated, the unit cannot accept your command.	● Wait for a while and try the operation again.
<b>TEMP OVER (TEMP!)</b>	● The temperature is too high.	● Turn off the power, and wait for a while.
<b>TOC FORM ** (Tform**)</b>	● There is an error in the recording signal.	● Erase all of the tracks, and then record again.
<b>TOC FULL</b>	● There is no space left for recording character information (track names, disc names, etc.).	● Replace it with another recordable disc.
<b>Tr. Protect</b>	● The track has been protected from being erased.	● Edit the track with the device on which it was recorded.
<b>? DISC (? DISC)</b>	● A disc which contains data other than music was played. ● There is an error in the signal recorded on the disc. ● Stamping is not possible.	● A disc which contains non-music data cannot be played. ● Replace it with another recorded disc. ● Retry.

( ) : Error messages seen on the remote control.  
Number or symbol appears in \* position.

Web-site: [www.sharp.co.uk/support](http://www.sharp.co.uk/support) Help Line: 08705 274277 (office hours)



## Troubleshooting

Many potential “problems” can be resolved by the owner without calling a service technician. If something seems to be wrong with this product, check the following before calling your authorised SHARP dealer or service centre.

PROBLEM	CAUSE
<b>The unit does not turn on.</b>	<ul style="list-style-type: none"> <li>● Is the AC adaptor disconnected?</li> <li>● Is the battery exhausted?</li> <li>● Is the unit in the hold mode?</li> <li>● Has condensation formed inside the unit?</li> <li>● Is the unit being influenced by mechanical shock or by static electricity?</li> </ul>
<b>No sound is heard from the ear-phones.</b>	<ul style="list-style-type: none"> <li>● Is the volume set too low?</li> <li>● Is the remote control unit or the earphones plugged in?</li> <li>● Are you trying to play a MiniDisc with data on it instead of a MiniDisc containing music?</li> </ul>
<b>When the operation buttons are pressed, the unit does not respond.</b>	<ul style="list-style-type: none"> <li>● Is the unit in the hold mode?</li> <li>● Is the battery exhausted?</li> <li>● Is the remote control unit plug or the earphones plug inserted firmly?</li> </ul>
<b>Some sounds are skipped.</b>	<ul style="list-style-type: none"> <li>● Is the battery exhausted?</li> <li>● Is the unit being subjected to excessive vibration?</li> </ul>
<b>The MiniDisc cannot be ejected.</b>	<ul style="list-style-type: none"> <li>● Has the track number or character information been updated on the disc yet?</li> <li>● Is the unit in the recording or editing mode?</li> </ul>
<b>Recording and editing are impos- sible.</b>	<ul style="list-style-type: none"> <li>● Is the MiniDisc protected against accidental erasure?</li> <li>● Is the unit connected properly to the other equipment?</li> <li>● Is the AC adaptor unplugged or did a power failure occur whilst recording or editing?</li> <li>● Is the unit in the hold mode?</li> <li>● Is an optical signal being output from the stereo system? Read the operation manual for the stereo system.</li> </ul>

**Web-site:** [www.sharp.co.uk/support](http://www.sharp.co.uk/support) **Help Line:** 08705 274277 (office hours)



### If trouble occurs

When this product is subjected to strong external interference (mechanical shock, excessive static electricity, abnormal supply voltage due to lightning, etc.) or if it is operated incorrectly, it may malfunction.

**If such a problem occurs, do the following:**

1. Unplug the AC adaptor from the wall socket.
2. Remove the battery.
3. Leave the unit completely unpowered for approximately 30 seconds.
4. Plug the AC adaptor back into the wall socket and reoperate the unit.

### Moisture condensation

When the unit has condensation inside, the disc signals cannot be read, and the unit may not function properly.

In the following cases, condensation may form inside the unit.

- Shortly after turning on a heater.
- When the unit is placed in a room where there is excessive steam or moisture.
- When the unit is moved from a cool place to a warm place.

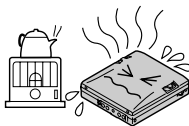

**To remove condensation:**

Remove the MiniDisc and leave the unit for approximately 1 hour. The condensation should evaporate and the unit will work properly.

## Maintenance

### ■ Cleaning

**When the unit becomes dirty**

Clean it with a soft cloth.

When the unit is excessively dirty, use a soft cloth dampened in water (external surfaces only).

**Clean the plugs and the connecting socket.**

If the plugs or sockets are dirty, noise may be heard. Cleaning will prevent noise.

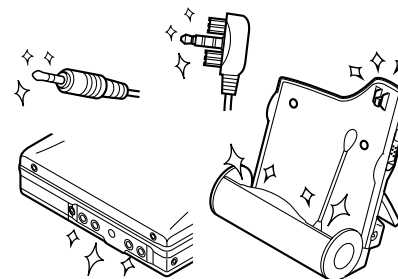

**Cautions:**

- Do not use chemicals for cleaning (petrol, paint thinner, etc.). It may damage the cabinet finish.
- Do not apply oil to the inside of the unit. It may cause malfunctions.



## Specifications

As a part of our policy of continuous improvement, SHARP reserves the right to make design and specification changes for product improvement without prior notice.  
The performance specification figures indicated are nominal values of production units. There may be some deviations from these values in individual units.

<b>Power source</b>	DC 1.2V: Rechargeable Nickel-Metal Hydride battery (AD-N55BT) x 1 DC 5V: AC adaptor (AC 230 - 240V, 50/60 Hz) DC 1.5V: Commercially available, "AA" size (LR6), alkaline battery x 1 DC 1.5V: Separately available car adaptor, AD-CA55X (for cars with a 12-24V DC negative earth electrical system)	
<b>Power consumption</b>	7 W (AC adaptor)	
<b>Output power</b>	RMS; 10 mW (5 mW + 5 mW) (0.2% T.H.D.)	
<b>Charging time</b>	Approx. 3.5 hours	
<b>Battery life</b>	When using the rechargeable battery (fully charged) included with the unit	Continuous recording: Approx. 6.5 hours Continuous play: Approx. 12 hours
	When using one, commercially available, high capacity, "AA" size (LR6), alkaline battery (The rechargeable battery is in the unit, discharged)	Continuous recording: Approx. 6 hours Continuous play: Approx. 18 hours
	When using one, commercially available, high capacity, "AA" size (LR6), alkaline battery with the rechargeable battery (fully charged)	Continuous recording: Approx. 15.5 hours Continuous play: Approx. 30 hours
<ul style="list-style-type: none"> <li>● The continuous recording time is for analogue inputs when the volume level is set to "VOL 0" (LCD edge light off).</li> <li>● The continuous play time shows the value when the volume level is set to "VOL 15" (LCD edge light off).</li> <li>● The above values are the standard values when the unit is charged and used at an ambient temperature of 20°C (68°F).</li> <li>● The operating time when using an alkaline battery may be different, depending on the type and manufacturer of the battery, and on the operating temperature.</li> </ul>		

**Web-site:** [www.sharp.co.uk/support](http://www.sharp.co.uk/support) **Help Line:** 08705 274277 (office hours)



<b>Input sensitivity</b>	MIC H: reference input level 0.25 mV      input impedance 10 k ohms MIC L: reference input level 2.5 mV      input impedance 10 k ohms LINE: reference input level 100 mV      input impedance 20 k ohms
<b>Output level</b>	Earphones: maximum output level 5 mW + 5 mW      load impedance 32 ohms LINE: specified output 250 mV (-12 dB)      load impedance 10 k ohms
<b>Dimensions</b>	Width: 72.0 mm (2-27/32") Height: 19.5 mm (25/32") Depth: 78.9 mm (3-1/8")
<b>Weight</b>	137 g (0.30 lbs.) with rechargeable battery
<b>Input socket</b>	Line/optical digital, microphone (powered by the main unit)
<b>Output socket</b>	Earphones (impedance: 32 ohms)/remote control unit
<b>Type</b>	Portable MiniDisc recorder
<b>Signal readout</b>	Non-contact, 3-beam semi-conductor laser pick-up
<b>Audio channels</b>	Stereo 2 channels/monaural (long-play mode) 1 channel
<b>Frequency response</b>	20 – 20,000 Hz ( $\pm$ 3 dB)
<b>Rotation speed</b>	Approx. 400 – 1,350 rpm
<b>Error correction</b>	ACIRC (Advanced Cross Interleave Reed-Solomon Code)
<b>Coding</b>	ATRAC (Adaptive Transform Acoustic Coding), 24-bit computed type
<b>Recording method</b>	Magnetic modulation overwrite method
<b>Sampling frequency</b>	44.1 kHz (32 kHz and 48 kHz signals are converted to 44.1 kHz, and then recorded.)
<b>Wow and flutter</b>	Unmeasurable (less than $\pm$ 0.001% W. peak)



### TERMS OF GUARANTEE

Subject to the terms listed below, Sharp Electronics (U.K.) Ltd. (hereinafter called "the Company") guarantee to provide for the repair of, or at its option replace this Sharp Equipment, or any component thereof, (other than batteries), which is faulty or below standard, as a result of inferior workmanship or materials.

The conditions of this guarantee are:

1. The guarantee shall only apply to defects which occur within one year from the date of purchase, provided that this equipment is sent to the repair address within this period.
2. This guarantee covers equipment intended for private domestic use only. This guarantee does not apply to equipment used in the course of a business, trade or profession.
3. The guarantee does not cover MiniDiscs or batteries.
4. This guarantee does not cover any faults or defects caused by accident, misuse, fair wear and tear, neglect, tampering with the equipment, or any attempt at adjustment or repair other than by a Service Facility appointed by Sharp.
5. In the unlikely event of a defect occurring, the product must be returned to the Company's repair centre with proof of purchase. A postage paid label and a fault report form are supplied with the product for this purpose. It is your responsibility to ensure that the packaging is adequate, and to obtain proof of posting. Further details of the repair service, which is available after the guarantee period on a chargeable basis, and additional report forms and labels can be obtained by telephoning 0870 738 0000.
6. No person has any authority to vary the terms or conditions of this guarantee.
7. This guarantee is offered as an additional benefit to the consumer's statutory rights and does not affect these rights in any way.

# SHARP

**SHARP ELECTRONICS (U.K.) LTD.**

Sharp House, Thorp Road, Newton Heath, Manchester, M40 5BE

**SHARP CORPORATION**

TINSE0334AWZZ

A0008.TO



## Free Manuals Download Website

<http://myh66.com>

<http://usermanuals.us>

<http://www.somanuals.com>

<http://www.4manuals.cc>

<http://www.manual-lib.com>

<http://www.404manual.com>

<http://www.luxmanual.com>

<http://aubethermostatmanual.com>

Golf course search by state

<http://golfingnear.com>

Email search by domain

<http://emailbydomain.com>

Auto manuals search

<http://auto.somanuals.com>

TV manuals search

<http://tv.somanuals.com>