

# SHARP®

**LC-37AD5E**  
**LC-37AD5S**

**LC-42AD5E**  
**LC-42AD5S**

LCD COLOUR TELEVISION  
LCD-FARBFERNSEHGERÄT  
TÉLÉVISION COULEUR À ÉCRAN  
À CRISTAUX LIQUIDES (LCD)  
TELEVISORE A COLORI LCD  
LCD-KLEURENTELEVISIE  
TELEVISIÓN EN COLOR LCD

OPERATION MANUAL  
BEDIENUNGSANLEITUNG  
MODE D'EMPLOI  
MANUALE DI ISTRUZIONI  
GEBRUIKSAANWIJZING  
MANUAL DE MANEJO

# AQUOS



**HDMI™**  
HIGH-DEFINITION MULTIMEDIA INTERFACE

**HD**  
*ready*

**DVB**  
Digital Video  
Broadcasting

ENGLISH

DEUTSCH

FRANÇAIS



ITALIANO

NEDERLANDS

ESPAÑOL



#### **SPECIAL NOTE FOR USERS IN THE U.K.**

The mains lead of this product is fitted with a non-rewireable (moulded) plug incorporating a 13A fuse. Should the fuse need to be replaced, a BSI or ASTA approved BS 1362 fuse marked  or  and of the same rating as above, which is also indicated on the pin face of the plug, must be used.

Always refit the fuse cover after replacing the fuse. Never use the plug without the fuse cover fitted.

In the unlikely event of the socket outlet in your home not being compatible with the plug supplied, cut off the mains plug and fit an appropriate type.

#### **DANGER:**

The fuse from the cut-off plug should be removed and the cut-off plug destroyed immediately and disposed of in a safe manner.

Under no circumstances should the cut-off plug be inserted elsewhere into a 13A socket outlet, as a serious electric shock may occur.

To fit an appropriate plug to the mains lead, follow the instructions below:

#### **IMPORTANT:**

The wires in the mains lead are coloured in accordance with the following code:

**Blue: Neutral**

**Brown: Live**

As the colours of the wires in the mains lead of this product may not correspond with the coloured markings identifying the terminals in your plug, proceed as follows:

- The wire which is coloured blue must be connected to the plug terminal which is marked N or coloured black.
- The wire which is coloured brown must be connected to the plug terminal which is marked L or coloured red.

Ensure that neither the brown nor the blue wire is connected to the earth terminal in your three-pin plug.

Before replacing the plug cover make sure that:

- If the new fitted plug contains a fuse, its value is the same as that removed from the cut-off plug.
- The cord grip is clamped over the sheath of the mains lead, and not simply over the lead wires.

**IF YOU HAVE ANY DOUBT, CONSULT A QUALIFIED ELECTRICIAN.**

- The models LC-37AD5E-BK, LC-37AD5S-BK, LC-42AD5E-BK and LC-42AD5S-BK feature a black cabinet.
- The models LC-37AD5E-GY, LC-42AD5E-GY and LC-42AD5S-GY feature a silver cabinet.
- The illustrations and on-screen displays in this operation manual are for explanation purposes and may vary slightly from the actual operations.
- The examples used throughout this manual are based on the LC-37AD5E model.
- The factory preset PIN is "1234".

**TV only** **TV/AV only** **TV/DTV/AV only** **AV only** **PC only** : these icons used throughout this manual indicate the menu item can be set or adjusted only in the selected input mode.

## Contents

<b>Contents</b> .....	<b>1</b>	Child Lock .....	17
<b>Dear SHARP customer</b> .....	<b>2</b>	Input Label .....	17
<b>Important Safety Precautions</b> .....	<b>2</b>	Fine Sync. ....	17
<b>Trademarks</b> .....	<b>2</b>	Position .....	18
<b>Supplied accessories</b> .....	<b>3</b>	WSS (Wide Screen Signalling) .....	18
<b>Quick guide</b> .....	<b>3</b>	4:3 Mode .....	18
Attaching the stand .....	3	Language .....	18
Setting the TV .....	4	Supply Voltage .....	18
Inserting the batteries .....	5	Option menu .....	18
Using the remote control unit .....	5	Audio Only .....	18
Cautions regarding the remote control unit .....	5	DNR (Digital Noise Reduction) .....	19
Remote control unit .....	6	HDMI Setup .....	19
TV (Front view) .....	7	Input Select .....	19
TV (Rear view) .....	7	Colour System .....	19
Turning on the power .....	8	Demo .....	19
Standby mode .....	8	<b>Useful features</b> .....	<b>20</b>
Initial auto installation (Analogue) .....	8	WIDE MODE .....	20
Using the analogue programme list .....	8	Still image .....	21
Initial auto installation (DTV) .....	8	Teletext function .....	21
<b>Using external equipment</b> .....	<b>9</b>	<b>DTV menu operations</b> .....	<b>22</b>
Connecting a VCR .....	9	DTV menu operation buttons .....	22
Connecting a game console or camcorder .....	9	DTV On-Screen Display .....	22
Connecting a DVD player .....	9	DTV common operations .....	22
Connecting a decoder .....	10	About using the character set screen .....	23
Connecting a PC .....	10	Language .....	23
Using AV Link function .....	10	Programme Setup .....	23
<b>Menu operations</b> .....	<b>11</b>	Favourite .....	24
Menu operation buttons .....	11	Lock .....	24
On-Screen Display .....	11	Move .....	24
Common operations .....	12	Move To .....	24
Picture menu .....	13	Skip .....	24
AV Mode .....	13	Select .....	25
Picture adjustments .....	13	Erase .....	25
Advanced .....	13	Label .....	25
Colour Temp. ....	14	View .....	25
Black .....	14	Installation .....	25
3D-Y/C .....	14	Auto Installation .....	25
Monochrome .....	14	Carrier Scan .....	25
Film Mode .....	14	Carrier Setup .....	26
I/P Setting .....	14	System Setup .....	26
Audio menu .....	14	OSD Setup .....	26
AV Mode .....	14	Child Lock .....	27
Audio adjustments .....	14	Accessories .....	27
Surround .....	14	Software Version .....	27
Auto Vol. ....	14	Software Upgrade .....	27
Clear Voice .....	14	Common Interface .....	28
Power Control menu .....	15	Inserting a CA card .....	28
No Signal Off .....	15	Supplying power to the antenna .....	28
No Operation Off .....	15	<b>Useful features (DTV)</b> .....	<b>29</b>
Power Management .....	15	About EPG .....	29
Setup menu .....	15	Using the EPG .....	29
Auto Installation .....	15	Using the EPG Timer .....	29
Programme Setup .....	15	Using the ESG .....	30
Auto Search .....	15	Using the digital programme list .....	30
Manual Adjust .....	16	Viewing a service banner .....	30
Fine .....	16	Using the multi audio function .....	31
Colour sys. ....	16	Displaying subtitles .....	31
Sound sys. (Broadcasting system) .....	16	Using the MHEG5 application (UK only) .....	31
Label .....	16	<b>Appendix</b> .....	<b>32</b>
Skip .....	16	Troubleshooting .....	32
Decoder .....	16	PC compatibility chart .....	33
Lock .....	16	RS-232C port specifications .....	33
Sort .....	16	Specifications .....	35
Erase Programme .....	16	Optional accessories .....	35
		End of life disposal .....	36

# Dear SHARP customer

Thank you for your purchase of the SHARP LCD colour TV product. To ensure safety and many years of trouble-free operation of your product, please read the Important Safety Precautions carefully before using this product.

## Important Safety Precautions

- **Cleaning**—Unplug the AC cord from the AC outlet before cleaning the product. Use a damp cloth to clean the product. Do not use liquid cleaners or aerosol cleaners.
- **Water and moisture**—Do not use the product near water, such as bathtub, washbasin, kitchen sink, laundry tub, swimming pool and in a wet basement.
- Do not place vases or any other water-filled containers on this product. The water may spill onto the product causing fire or electric shock.
- **Stand**—Do not place the product on an unstable cart, stand, tripod or table. Doing so can cause the product to fall, resulting in serious personal injuries as well as damage to the product. Use only a cart, stand, tripod, bracket or table recommended by the manufacturer or sold with the product. When mounting the product on a wall, be sure to follow the manufacturer's instructions. Use only the mounting hardware recommended by the manufacturer.
- When relocating the product placed on a cart, it must be moved with utmost care. Sudden stops, excessive force and uneven floor surface can cause the product to fall from the cart.
- **Ventilation**—The vents and other openings in the cabinet are designed for ventilation. Do not cover or block these vents and openings since insufficient ventilation can cause overheating and/or shorten the life of the product. Do not place the product on a bed, sofa, rug or other similar surface, since they can block ventilation openings. This product is not designed for built-in installation; do not place the product in an enclosed place such as a bookcase or rack, unless proper ventilation is provided or the manufacturer's instructions are followed.
- The LCD panel used in this product is made of glass. Therefore, it can break when the product is dropped or impact applied. If the LCD panel is broken, be careful not to be injured by broken glass.
- **Heat sources**—Keep the product away from heat sources such as radiators, heaters, stoves and other heat-generating products (including amplifiers).
- To prevent fire, never place any type of candle or naked flames on the top or near the TV set.
- To prevent fire or shock hazard, do not place the AC cord under the TV set or other heavy items.
- Do not display a still picture for a long time, as this could cause an afterimage to remain.
- There is power consumption always if main plug is connected.

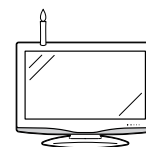

The LCD panel is a very high technology product, giving you fine picture details. Due to the very large number of pixels, occasionally a few non-active pixels may appear on the screen as a fixed point of blue, green or red. This is within product specifications and does not constitute a fault.

### Precautions when transporting the TV

When moving the TV, it should always be carried by two people, using both hands, be careful not to apply pressure to the display.





## Trademarks

• "HDMI, the HDMI logo and High-Definition Multimedia Interface are trademarks or registered trademarks of HDMI Licensing LLC."

• The "HD ready" Logo is a trademark of EICTA.

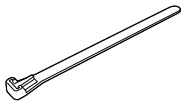
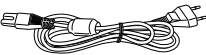
• The DVB logo is the registered trademark of the Digital Video Broadcasting - DVB - project.

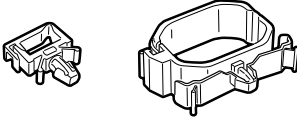
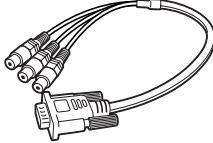
# Supplied accessories

Remote control unit (× 1)	AC cord	Cable tie (× 1)
	(For Europe, except U.K. and Eire) (For U.K. and Eire)	
		
U.K. type 3-pin AC cord is only included with models LC-37AD5E-BK, LC-42AD5E-BK.		
Pages 5 and 6	Page 4	Page 4
Cable clamp (Small × 1, Large × 1)	3 RCA to 15-pin D-sub adapter (× 1)	Stand unit (× 1)
		
Page 4	Page 9	Page 3
• “AA” size battery (× 2) ..... Page 5	• Operation manual (This publication)	

## Quick guide

### Attaching the stand

Before performing work spread cushioning over the base area to lay the TV on, making sure the area is completely flat. This will prevent it from being damaged.

Before attaching (or detaching) stand, unplug the AC cord from the AC INPUT terminal.

- 1 Confirm the 8 screws supplied with the TV.
- 3
  - ① Insert the stand into the opening on the bottom of the TV.
  - ② Insert and tighten the 4 long screws on the rear of the TV as shown.

**Short screws (× 4)**  
(used in step 2)



**Long screws (× 4)**  
(used in step 3)

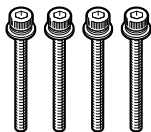

- 2 Attach the two parts of the stand unit to each other using the 4 short screws as shown.

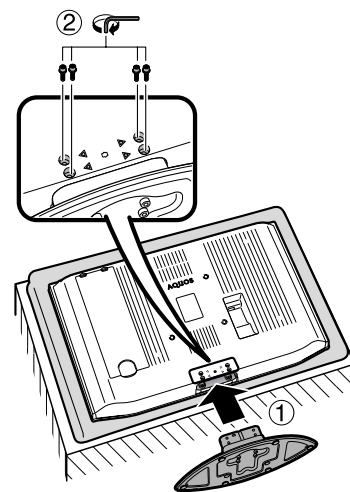
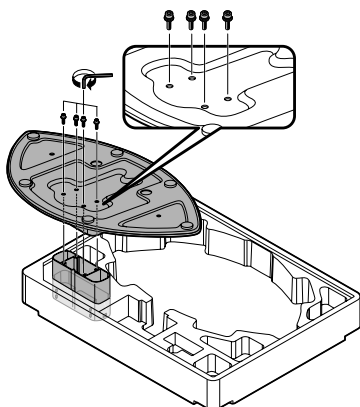

#### NOTE

- To detach the stand, perform the above steps in reverse order.

## Setting the TV

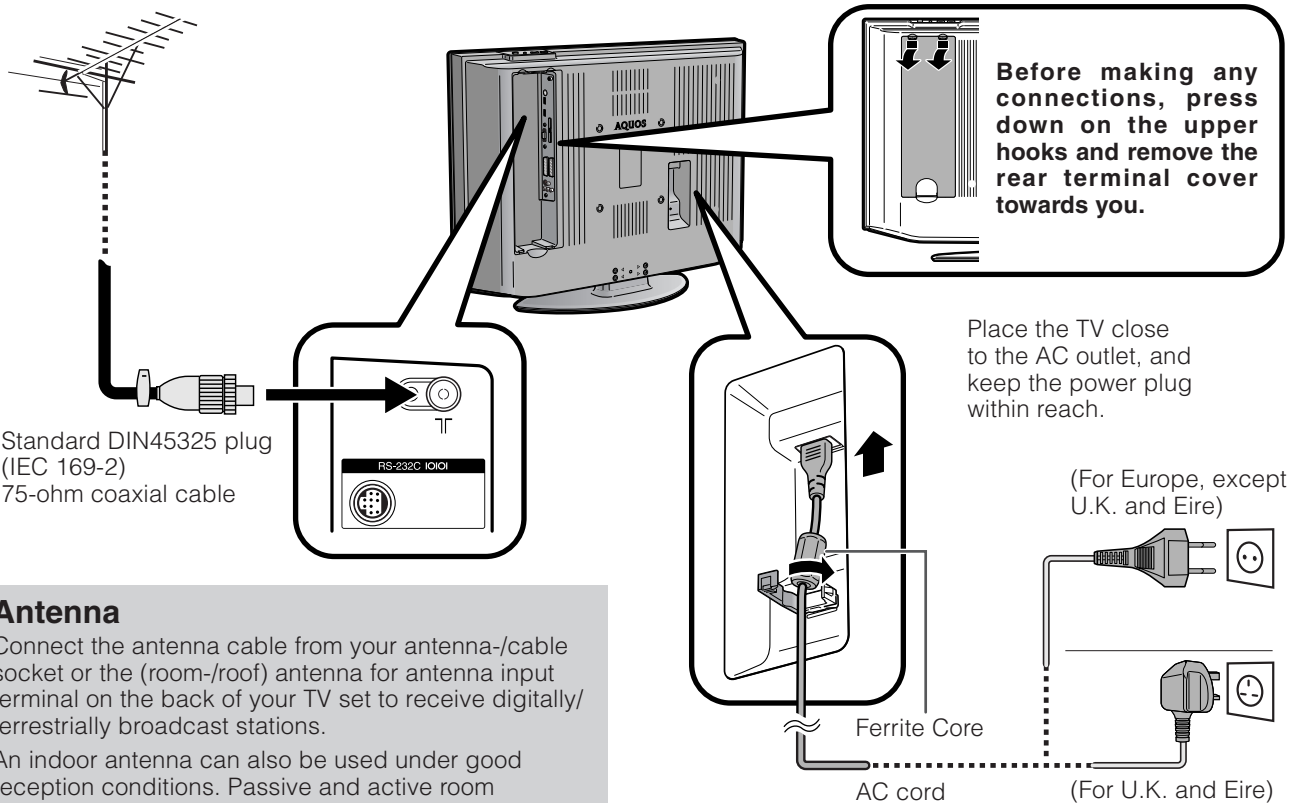

### Antenna

Connect the antenna cable from your antenna-/cable socket or the (room-/roof) antenna for antenna input terminal on the back of your TV set to receive digitally/ terrestrially broadcast stations.

An indoor antenna can also be used under good reception conditions. Passive and active room antennas are offered commercially. In an active antenna its power is supplied via the antenna input terminal.

The supply voltage (5V) must be correspondingly set under "Supply Voltage". (See page 18.)

### Ferrite Core

The Ferrite Core should be permanently attached and never removed from the AC cord.

## Bundling the cables

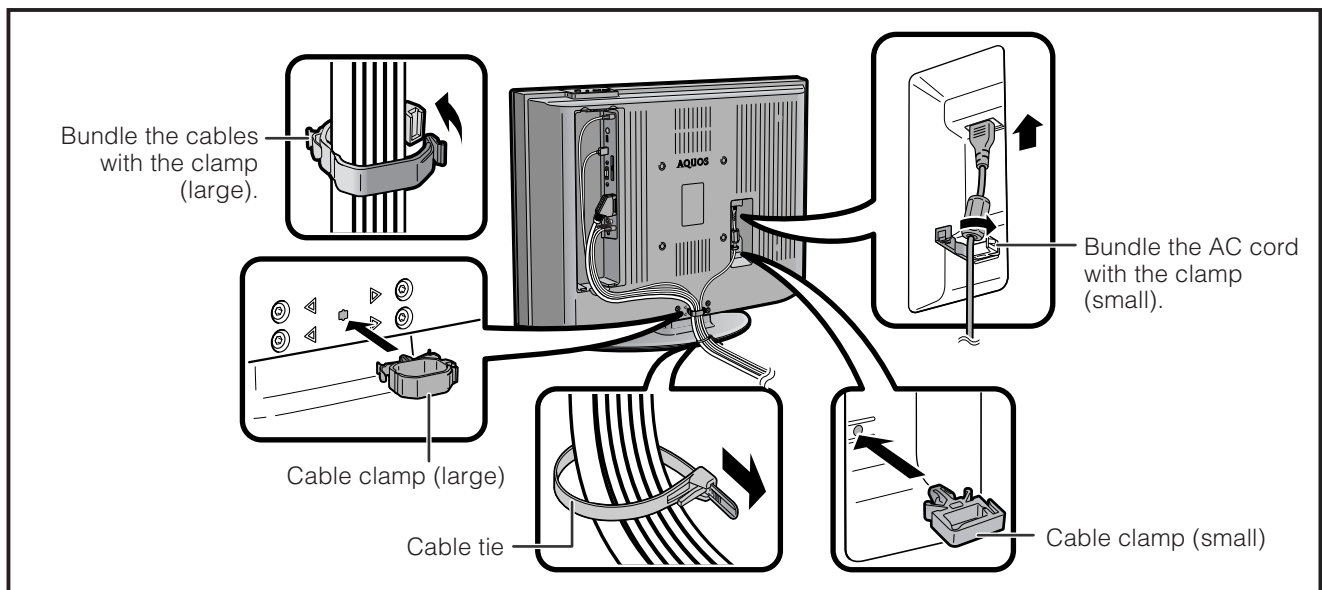

## Setting the TV on the wall

- This TV should be mounted on the wall only with the wall mount bracket available from SHARP. (See page 35.) The use of other wall mount brackets may result in an unstable installation and may cause serious injuries.
- When you use the AN-37AG2 (SHARP) wall mount bracket, set the angle of the TV to 0° or 5°. Do not set the angle to more than 10°.
- Installing the LCD Colour TV requires special skill that should only be performed by qualified service personnel. Customers should not attempt to do the work themselves. SHARP bears no responsibility for improper mounting or mounting that results in accident or injury.
- You can ask a qualified service personnel about using an optional bracket to mount the TV to the wall.

## Quick guide

### Inserting the batteries

Before using the TV for the first time, insert two "AA" size batteries (supplied). When the batteries become depleted and the remote control unit fails to operate, replace the batteries with new "AA" size batteries.

- 1 Hold in the tab on the battery cover and pull the cover towards the direction of the arrow.
- 2 Insert two supplied "AA" size batteries.
  - Place batteries with their terminals corresponding to the (+) and (-) indications in the battery compartment.
- 3 Insert the smaller tab of the battery cover into the opening (①), and press down on the cover until it clicks in place (②).

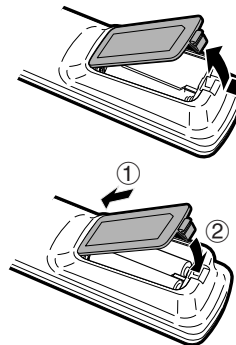

### CAUTION

Improper use of batteries can result in chemical leakage or explosion. Be sure to follow the instructions below.

- Do not mix batteries of different types. Different types of batteries have different characteristics.
- Do not mix old and new batteries. Mixing old and new batteries can shorten the life of new batteries or cause chemical leakage in old batteries.
- Remove batteries as soon as they have worn out. Chemicals that leak from batteries can cause a rash. If you find any chemical leakage, wipe thoroughly with a cloth.
- The batteries supplied with this product may have a shorter life expectancy due to storage conditions.
- If you will not be using the remote control unit for an extended period of time, remove the batteries from it.

### Using the remote control unit

Use the remote control unit by pointing it towards the remote control sensor. Objects between the remote control unit and sensor may prevent proper operation.

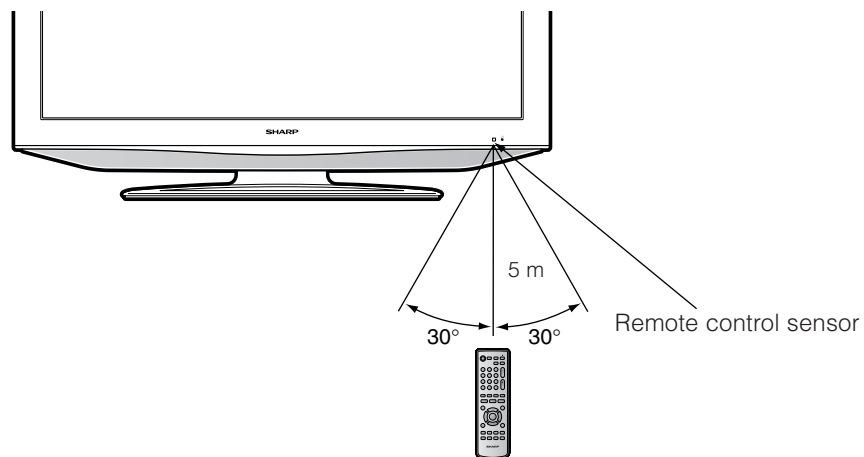

### Cautions regarding the remote control unit

- Do not expose the remote control unit to shock. In addition, do not expose the remote control unit to liquids, and do not place in an area with high humidity.
- Do not install or place the remote control unit under direct sunlight. The heat may cause deformation of the unit.
- The remote control unit may not work properly if the remote control sensor of the TV is under direct sunlight or strong lighting. In such case, change the angle of the lighting or TV, or operate the remote control unit closer to the remote control sensor.

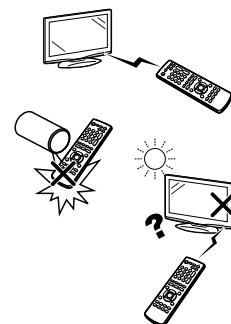

## Remote control unit

- 1 **⏻ | (Standby/On)**  
Enter standby mode or turn on the power. (See page 8.)
- 2 **AV MODE**  
Select a video setting. (See page 13.)
- 3 **0-9**  
Set the channel in TV and DTV mode. Set the page in Teletext mode.
- 4 **↶ (Flashback)**  
Press to return to the previous image in normal viewing mode. (Will not work while operating in EPG/ESG screen.)
- 5 **⊞ (WIDE MODE)**  
Select the wide mode. (See page 20.) Set the area of magnification in Teletext mode. (See page 21.)
- 6 **∇/∇/∇/∇ (Sound mode)**  
Select the sound multiplex mode. (See below.)
- 7 **EPG**  
DTV: To display EPG (Electronic Programme Guide) screen.
- 8 **ESG**  
DTV: To display ESG (Electronic Service Guide) screen. (See page 30.)
- 9 **☰ (Teletext)**  
Select the TELETEXT mode. (All TV image, DTV/DATA image, all TEXT image, TV/TEXT image) (See pages 21 and 31.)  
DTV: Select DTV data broadcasting and TELETEXT.
- 10 **▲/▼/◀/▶ (Cursor)**  
Select a desired item on the setting screen.
- 11 **END**  
Exit the menu screen.
- 12 **Ⓜ (Reveal hidden Teletext)**  
(See page 21.)
- 13 **Ⓜ (Freeze/Hold)**  
(See page 21.)

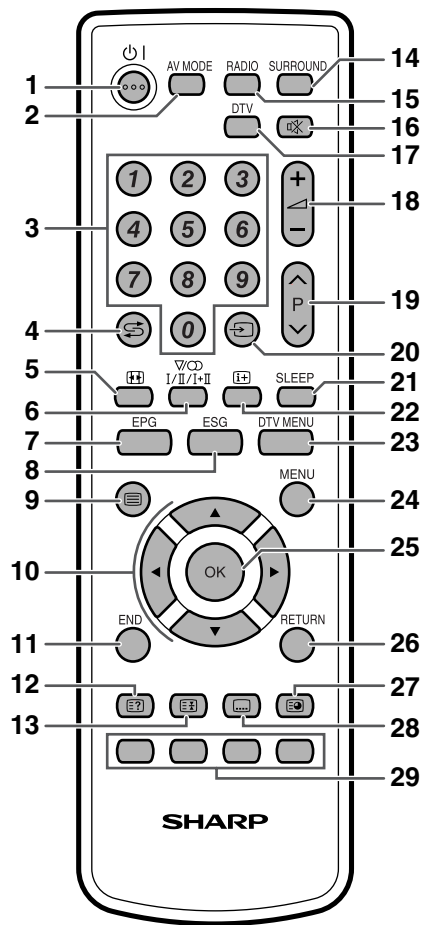

- 14 **SURROUND**  
Switch the surround effects on and off. (See page 14.)
- 15 **RADIO**  
DTV: Switch between RADIO and DTV mode.
- 16 **Ⓜ (Mute)**  
Switch the sound on and off.
- 17 **DTV**  
Press to access DTV mode while watching other input sources, and vice versa.  
(This button will not work if you were watching DTV immediately before turning off the TV. In this case first select any other input source except DTV using the **→ (INPUT SOURCE)** button.)
- 18 **△ (+/-) (Volume)**  
△ (+) Increase the volume.  
▽ (-) Decrease the volume.
- 19 **P (▲/▼)**  
TV/DTV: Select the channel.  
External: Switch to TV or DTV input mode.  
Teletext: Move to the next/previous page.
- 20 **→ (INPUT SOURCE)**  
Select an input source.  
(TV, DTV, EXT1, EXT2, EXT3, EXT4, EXT5, EXT6) (See page 9.)
- 21 **SLEEP**  
Set the sleep timer on (in units of 30 min. up to max. 2 hr. 30 min) and off.
- 22 **⊞ (Display information)**  
(See pages 21, 29 and 30.)
- 23 **DTV MENU**  
DTV: Display DTV Menu screen.
- 24 **MENU**  
Display the MENU screen. (See page 11.)
- 25 **OK**  
Execute a command within the menu screen.  
Display the programme list. (Except external input.)
- 26 **RETURN**  
Return to the previous menu screen.
- 27 **Ⓜ (Subpage)**  
(See page 21.)
- 28 **☰ (Subtitle for Teletext)**  
TV/External: To turn the subtitles on and off. (See page 21.)  
DTV: Display the subtitle selection screen. (See page 31.)
- 29 **Colour (Red/Green/Yellow/Blue)**  
TELETEXT: Select a page. (See page 21.)  
DTV: The coloured buttons are used to select correspondingly to the coloured items in the menu screen.

### ● Using ∇/∇/∇/∇ on the remote control unit

#### DTV mode:

Press ∇/∇/∇/∇ to open the multi audio screen. (See page 31.)

#### Analogue TV mode:

Each time you press ∇/∇/∇/∇, the mode switches as illustrated in the following tables.

NICAM TV broadcasts selection

Signal	Selectable items
Stereo	NICAM STEREO, MONO
Bilingual	NICAM CH A, NICAM CH B, NICAM CH AB, MONO
Monaural	NICAM MONO, MONO

A2 TV broadcasts selection

Signal	Selectable items
Stereo	STEREO, MONO
Bilingual	CH A, CH B, CH AB
Monaural	MONO

#### NOTE

- When no signal is input, the sound mode will display "MONO".



Quick guide

**TV (Front view)**

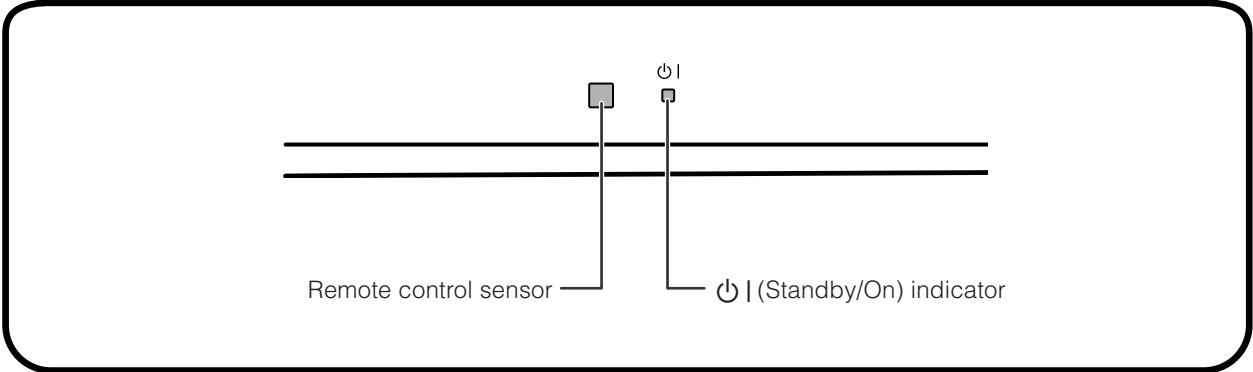
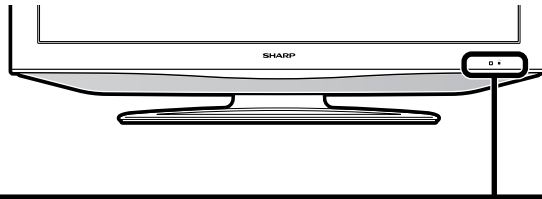

**TV (Rear view)**

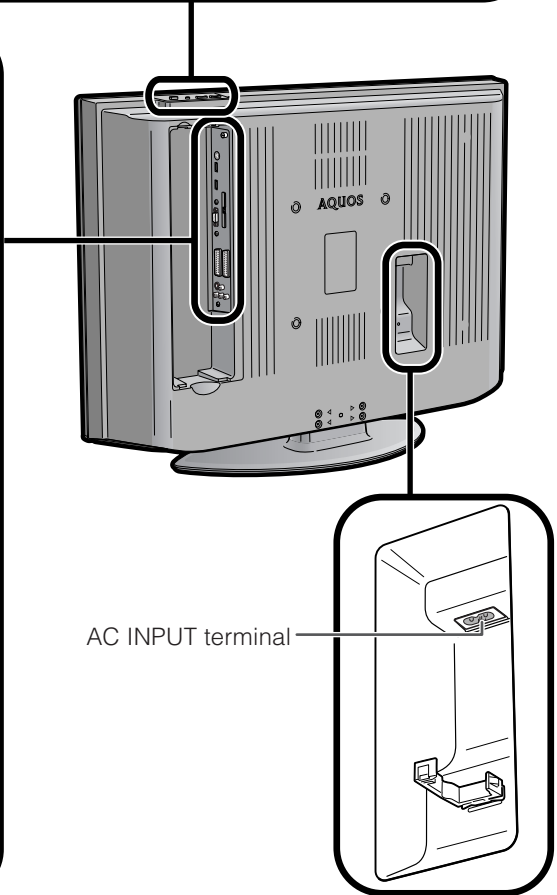
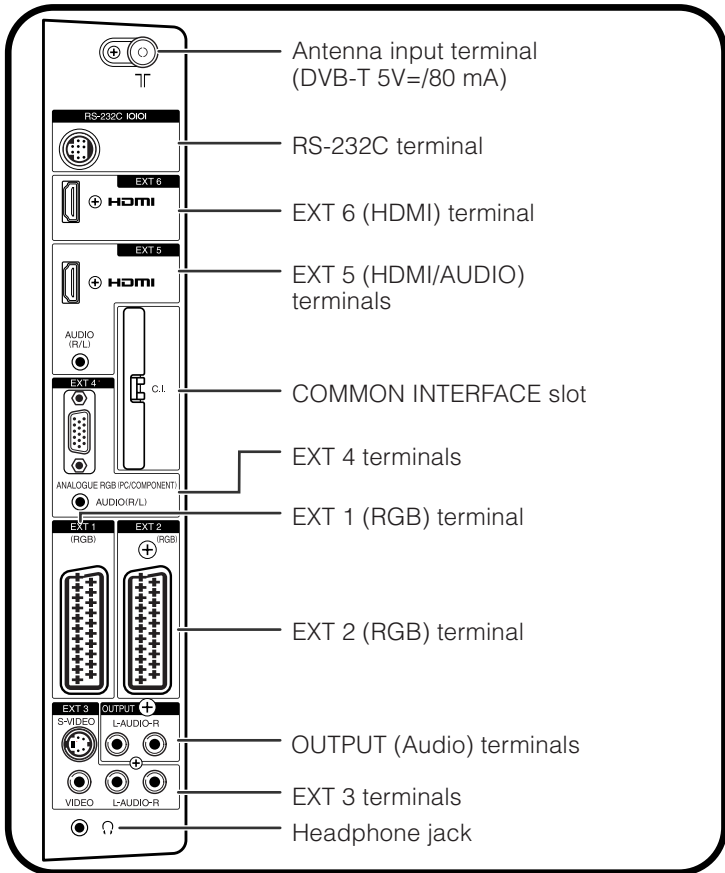
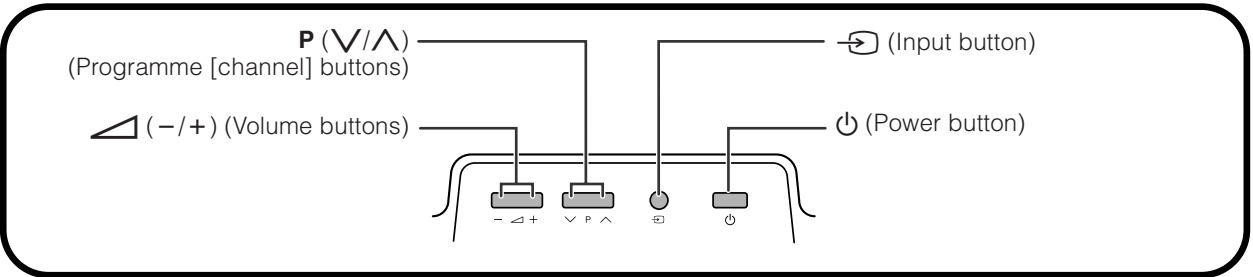

**NOTE**

- Only if you use an active terrestrial antenna, select "On (5V)" under "Supply Voltage". (See page 18.)

## Quick guide

### Turning on the power

Press  on the TV or  | on the remote control unit.

### Standby mode

Press  | on the remote control unit when the TV is on.

- The TV enters standby mode and the image on the screen disappears.
- The  | indicator on the TV changes from green to red.
- To completely turn off the power to the TV, unplug the AC cord from the AC outlet. However, do not unplug the AC cord unless otherwise instructed.

#### Display status indicator

Off	Power off.
Red	The TV is in standby mode.
Green	The TV is on.

#### NOTE

- If you are not going to use this TV for a long period of time, be sure to remove the AC cord from the power outlet.
- Weak electric power is still consumed even when  is turned off.
- In DTV input mode, if the power is turned off immediately after a setting change from the menu screen, the new setting or channel information may not be memorised.

### Initial auto installation (Analogue)

When the TV powers on for the first time after purchase, the initial auto installation (Analogue) is invoked. You can automatically set language, country and channels in successive operations.

#### NOTE

- The initial auto installation functions only once. If the initial auto installation is not completed, (ex: When menu screen disappeared by not operating for a few minutes, when the power shut down, etc.), try Auto Installation from the Setup menu. (See page 15.)
- The initial auto installation stops by pressing **RETURN**.

#### 1 Setting the on-screen display language

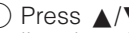
- ① Press  to select the desired language listed on the screen.
- ② Press **OK** to enter the setting.

#### 2 Setting the country or area

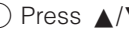
- ① Press  to select your country or area listed on the screen.
  - ② Press **OK** to enter the setting.
- The programme auto search starts at the same time.

After this setting, auto search starts with the following order:

- ① Programme auto search
- ② Auto labelling
- ③ Auto sorting
- ④ Preset download

You do not need to do anything during the auto search.



The setup menu disappears and you can watch the programme on channel 1.

### Using the analogue programme list



You can also select the desired channel from programme list instead of using **0-9** numeric buttons or **P** ().

- 1 Press **OK** when no other menu screen is displayed. (Except external input.)
- 2 Press  to select the desired channel to tune in, and then press **OK**.
- 3 Press **END** to exit the Programme List.

### Initial auto installation (DTV)

Digital Video Broadcasting is a transmission scheme. It is much more than a simple replacement for existing analogue television transmission. DVB provides more stations, clearer picture quality and other services displayed on the screen. It also allows a range of new features and services including subtitles and multiple audio tracks.

To watch DTV broadcasts, follow the procedures below to scan all available services in your area.

- 1 Press **DTV** or  to access the DTV mode.
- 2 Press **DTV MENU** and the DTV Menu screen displays.
- 3 Press  to select "Installation".
- 4 Press  to select "Auto Installation", and then press **OK**.

If you have already set the PIN, enter it here. If not, enter the factory preset PIN "1234".

- See page 17 for setting PIN.
- A confirmation message displays. Press  to select "Yes", and then press **OK** to start the search.

- 5 The TV starts scanning all available DTV and radio services in your area.

#### NOTE

- The language and country settings used in this operation are the settings you have already set while executing the **Initial auto installation (Analogue)**. If you want to reconfigure the country setting, for instance after moving to another country, conduct "Auto Installation" from the Analogue Menu again.
- The services are stored according to the channel number information embedded in the stream (if available). If the information is not available, the services are stored according to the order in which they were received. If you would like to sort the order, it is possible to arrange it as explained in page 24.
- To cancel the scan in progress, press **END**.
- You cannot select any DTV-related menu items unless "Auto Installation" has been completed.

# Using external equipment

## Setting the input source

To view external source images, select the input source using  on the remote control unit or the TV.

### NOTE

- The cables marked with \* are commercially available items.

## Connecting a VCR

You can use the EXT 1 or 2 terminals when connecting a VCR and other audiovisual equipment. If your VCR supports TV-VCR advanced AV Link systems, you can connect the VCR to the EXT 2 terminal of the TV using the fully-wired SCART cable.

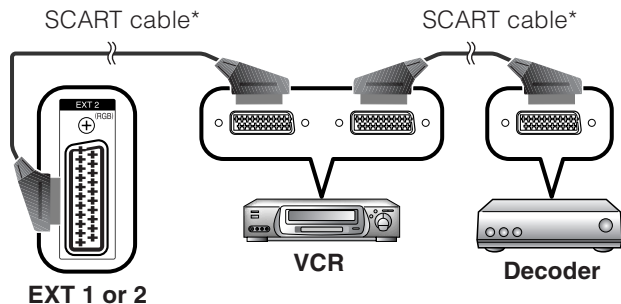

### NOTE

- TV-VCR advanced AV Link systems may not be compatible with some external sources.
- TV-OUT from EXT 1 is not outputted when EXT 5 (HDMI), EXT 6 (HDMI) or DTV is selected as the input.

## Connecting a game console or camcorder

A game console, camcorder and some other audiovisual equipment are conveniently connected using the EXT 3 terminals.

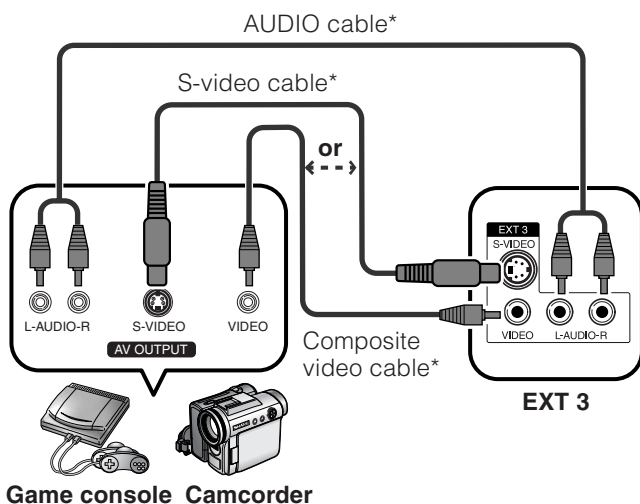

### NOTE

- EXT 3: The S-VIDEO terminal has priority over the VIDEO terminals.

## Connecting a DVD player

You can use the EXT 2, 3, 4, 5 (HDMI) or 6 (HDMI) terminals when connecting to a DVD player and other audiovisual equipment.

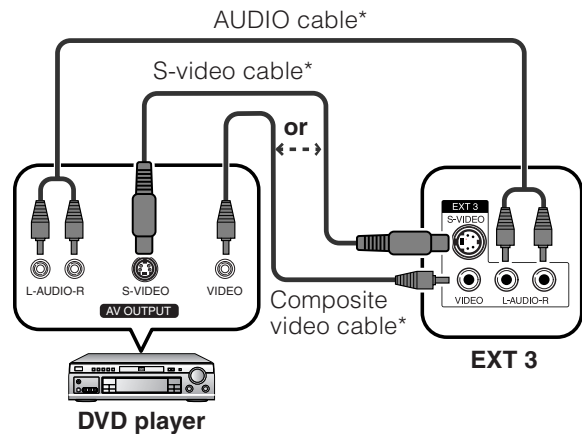

### NOTE

- EXT 3: The S-VIDEO terminal has priority over the VIDEO terminals.

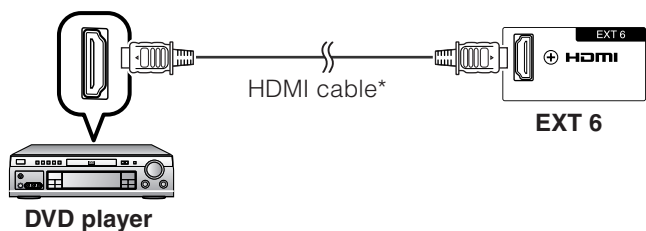
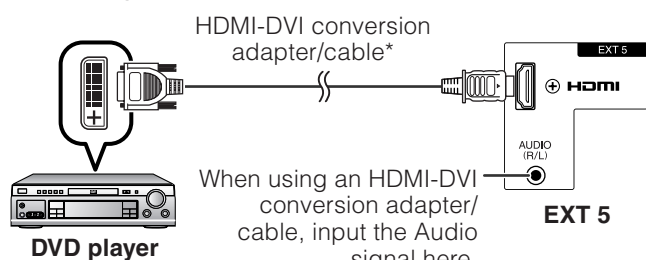
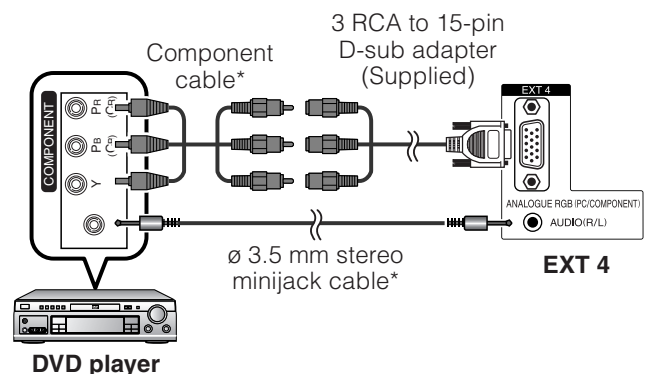

### NOTE

- When connecting an HDMI-DVI conversion adapter/cable to the HDMI terminal, the image may not come in clearly.

## Using external equipment

### Connecting a decoder

You can use the EXT 1 terminal when connecting a decoder and other audiovisual equipment.

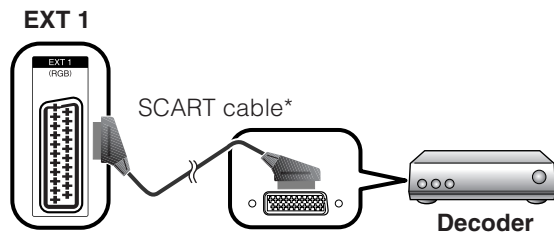

#### NOTE

- In cases when the decoder needs to receive signal from the TV, make sure to set "Decoder" to "EXT1" in the Programme Setup "Manual Adjust" menu. (See page 16.)
- Do not connect the decoder to the EXT 2 terminal.

### Connecting a PC

Use the EXT 4 terminals to connect a PC.

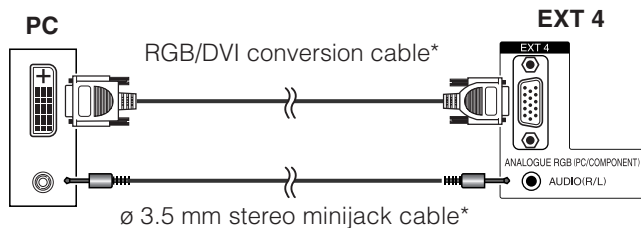
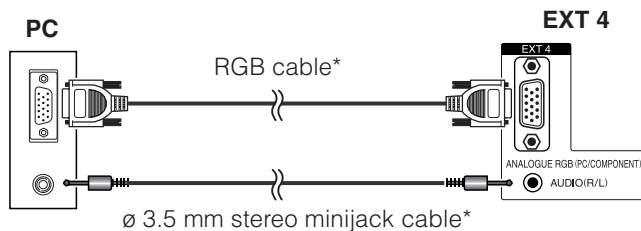

#### NOTE

- The cables marked with \* are commercially available items.
- The PC input terminals are DDC1/2B-compatible.
- Refer to page 33 for a list of PC signals compatible with the TV.
- When connecting to a PC, the correct input signal type is automatically detected.

### Using AV Link function

This TV incorporates three typical AV Link functions for smooth connections between the TV and other audiovisual equipment.

#### One Touch Play

While the TV is in standby mode, it automatically turns on and plays back the image from the audiovisual source (e.g. VCR, DVD).

#### WYSIWYR (What You See Is What You Record)

When the remote control unit of the connected VCR has the WYSIWYR button, you can automatically start recording by pressing the WYSIWYR button.

#### Preset Download

Automatically transfers the channel preset information from the tuner on the TV to the one on the connected audiovisual equipment (e.g. VCR) via the EXT 2 terminal.

#### NOTE

- Refer to operation manuals of each external equipment for the details.
- Only works when the audiovisual equipment is connected to the EXT 2 terminal on the TV with AV Link via a fully wired SCART.
- The use of the AV Link function is only possible if the TV-set has enforced a complete auto-installation with the connected audiovisual equipment (page 8, Initial auto installation).  
The availability of the AV Link function depends on the audiovisual equipment used. Depending on the manufacturer and type of equipment used, it is possible that the described functions may be completely or partially unusable.

# Menu operations

## Menu operation buttons

Use the following buttons on the remote control unit to operate the menu.

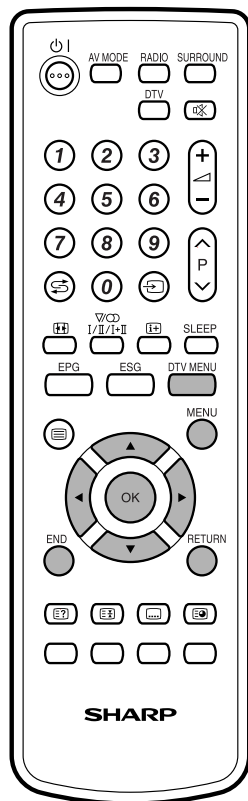

**MENU:** Press to open or close the menu screen.

**▲/▼/◀/▶:** Press to select a desired item on the screen or adjust a selected item.

**OK:** Press to go to the next step or complete the setting.

**RETURN:** Press to return to the previous step.

**DTV MENU:** Press to open or close the DTV Menu screen.

**END:** Press to exit the menu item.

## On-Screen Display

### Example

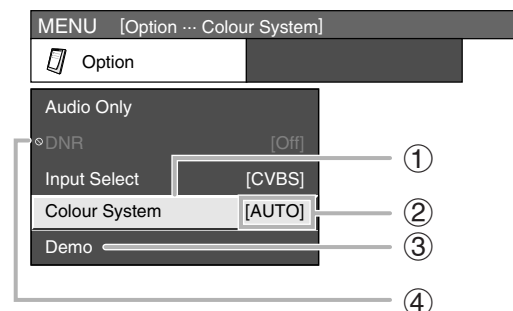

- ① **Item displayed in yellow**
  - This indicates the item currently selected.
- ② **Item in brackets**
  - This indicates the current setting for the item.
- ③ **Item displayed in white**
  - This indicates an item can be selected.
- ④ **Item with  displayed in grey**
  - This indicates the item cannot be selected for various reasons.

### NOTE

- Menu options differ in the selected input modes, but the operating procedures are the same.
- The screens in the operation manual are for explanation purposes (some are enlarged, others cropped) and may vary slightly from the actual screens.

## Common operations

### Menu Operation: A

- ① Press **MENU** and the MENU screen displays.
- ② Press **◀/▶** to select the desired menu.
- ③ Press **▲/▼** to select the desired menu item, and then press **OK** (Example: AV Mode, etc.).
  - Select "Reset" to reset all adjustment items to the factory preset values.

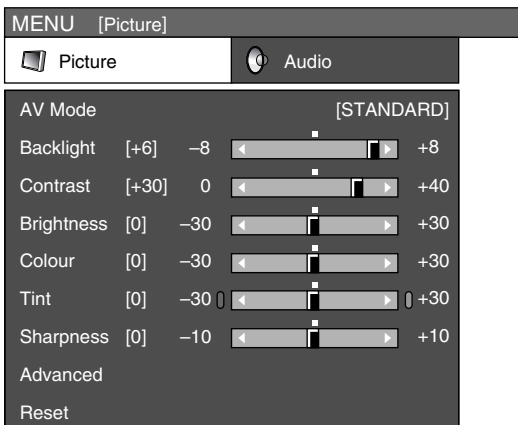

- ④ Press **▲/▼/◀/▶** to select the desired item, and then press **OK**.



### Menu Operation: B

- ① Press **MENU** and the MENU screen displays.
- ② Press **◀/▶** to select the desired menu.
- ③ Press **▲/▼** to select the desired menu item (Example: Backlight, Contrast, etc.).
- ④ Press **◀/▶** to adjust the item to your desired position.
  - Select "Reset" to reset all adjustment items to the factory preset values.

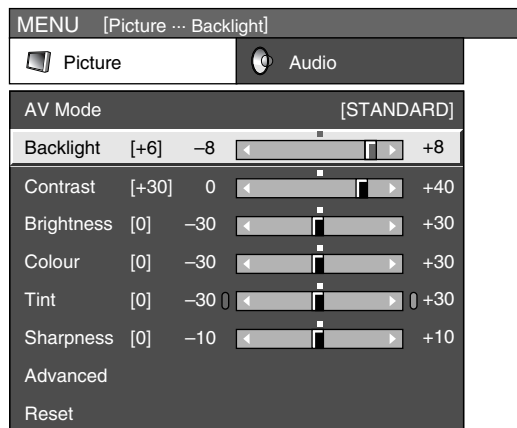

### Menu Operation: C

- ① Press **MENU** and the MENU screen displays.
- ② Press **◀/▶** to select the desired menu.
- ③ Press **▲/▼** to select the desired menu item, and then press **OK** (Example: Advanced, Demo, etc.).
- ④ Press **▲/▼** to select the desired menu item, and then press **OK** (Example: Colour Temp., Black, etc.).
  - Select "Reset" to reset all adjustment items to the factory preset values.

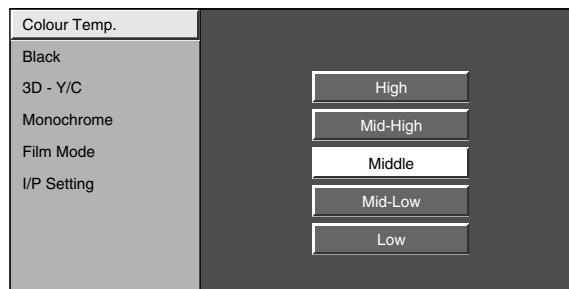

- ⑤ Press **▲/▼/◀/▶** to select or adjust the desired item, and then press **OK**.

## Menu operations

### Picture menu

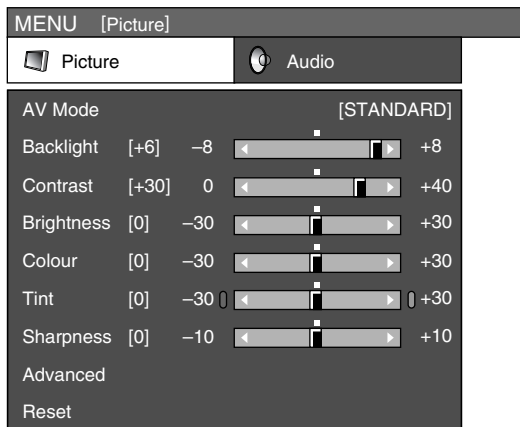

### AV Mode

#### Menu Operation: A (page 12)

AV Mode gives you five viewing options to choose from to best match the system environment, which can vary due to factors like room-brightness, type of programme watched or the type of image input from external equipment.

#### Item

**STANDARD:** For a highly defined image in a normally bright room.

**SOFT\*:** Creates a softer image.

**ECO\*:** Reduces power consumption.

**USER:** Allows the user to customise settings as desired. You can set the mode for each input source.

**DYNAMIC\*:** For a clear-cut image emphasising high contrast for sports viewing.

#### NOTE

- You can also select AV Mode options by pressing **AV MODE** on the remote control unit.
- You can adjust the factory preset parameters given in "STANDARD", "SOFT", "ECO" and "DYNAMIC". The parameters chosen affect each of the input sources.
- The items marked with \* are only available for TV/DTV/AV input mode.

### Picture adjustments

#### Menu Operation: B (page 12)

Adjust the picture to your preference with the following picture settings.

#### Adjustment items for AV source

Selectable items	◀ button	▶ button
<b>Backlight</b>	The screen dims	The screen brightens
<b>Contrast</b>	For less contrast	For more contrast
<b>Brightness</b>	For less brightness	For more brightness
<b>Colour</b>	For less colour intensity	For more colour intensity
<b>Tint</b>	Skin tones become purplish	Skin tones become greenish
<b>Sharpness</b>	For less sharpness	For more sharpness

#### Adjustment items for PC source

Selectable items	◀ button	▶ button
<b>Backlight</b>	The screen dims	The screen brightens
<b>Contrast</b>	For less contrast	For more contrast
<b>Brightness</b>	For less brightness	For more brightness
<b>Red</b>	For weaker red	For stronger red
<b>Green</b>	For weaker green	For stronger green
<b>Blue</b>	For weaker blue	For stronger blue

### Advanced

TV/DTV/AV only

#### Menu Operation: C (page 12)

This TV provides various advanced functions for optimising the picture quality.

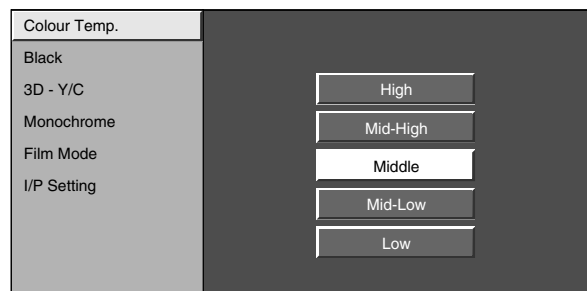

## Menu operations

### Colour Temp.

Adjust the colour temperature to give the best white image.

#### Item

- High:** White with bluish tone
- Mid-High:** Intermediate tone between High and Middle
- Middle:** Natural tone
- Mid-Low:** Intermediate tone between Middle and Low
- Low:** White with reddish tone

### Black

For easier viewing, change the viewing depth by selecting a level for automatically adjusting the dark portion of an image.

### 3D-Y/C

Provide high quality images with minimal dot crawl and cross colour noise by detecting changes in the image.

#### Item

- Off:** No detecting
- Standard:** Normal adjustment
- Fast:** Set the optimum image quality for fast-moving images.
- Slow:** Set the optimum image quality for slow-moving images.

#### NOTE

- 3D-Y/C may not operate depending on the input signal type or noisy input signal.
- 3D-Y/C has even more effect on composite video signals (CVBS).

### Monochrome

For viewing a video in monochrome.

#### NOTE

- When Monochrome is set to "On", the DTV Menu screen displays in monochrome.

### Film Mode

Automatically detect a film-based source (originally encoded at 24/25 frames/second, depending on the vertical frequency), analyses it then recreates each still film frame for high-definition picture quality.

### I/P Setting

Adjust the image and input signal can give you a more beautiful picture.

#### Item

- Interlace:** Display finely detailed images for TV or video, etc.
- Progressive:** Display smooth images for still images or graphics, etc.

#### NOTE

- The I/P Setting is set to "Progressive" when Film Mode is "On".

## Audio menu

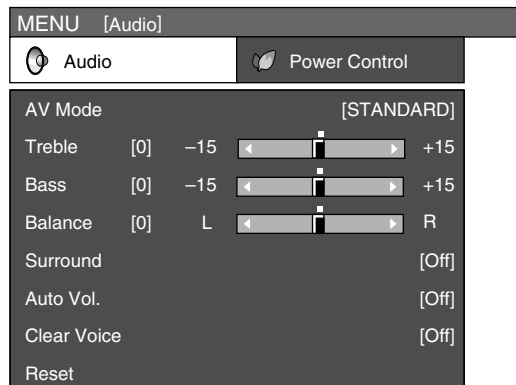

### AV Mode

#### Menu Operation: A (page 12)

This option links to AV Mode in the Picture menu. (See page 13.)

### Audio adjustments

#### Menu Operation: B (page 12)

You can adjust the sound quality to your preference with the following settings.

Selectable items	◀ button	▶ button
<b>Treble</b>	For weaker treble	For stronger treble
<b>Bass</b>	For weaker bass	For stronger bass
<b>Balance</b>	Decrease audio from the right speaker	Decrease audio from the left speaker

### Surround

#### Menu Operation: A (page 12)

Surround function allows you to enjoy realistic "live" sound.

#### NOTE

- You can also choose surround effects by pressing **SURROUND** on the remote control unit.

### Auto Vol.

TV/DTV/AV only

#### Menu Operation: A (page 12)

Different sound sources, fairly often do not have the same volume level, for example the changing from movie to the advertisements. The Automatic Volume Control (Auto Vol.) solves this problem and equalises the volume levels.

### Clear Voice

#### Menu Operation: A (page 12)

This function emphasises speech against the background noise for more intelligibility. It is not recommended for music sources.



## Menu operations

### Power Control menu

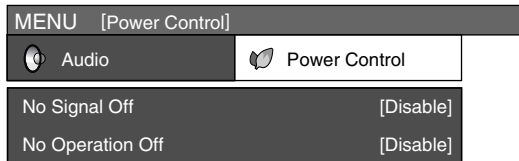

### No Signal Off

TV/AV only

#### Menu Operation: A (page 12)

When set to "Enable" the TV will automatically enter the standby mode if there is no signal input for 15 minutes.

- Five minutes before the TV enters standby mode, the remaining time displays every minute.

#### NOTE

- When a TV programme finishes, this function may not operate.
- This function is not available in DTV mode.

### No Operation Off

TV/DTV/AV only

#### Menu Operation: A (page 12)

When set to "Enable" the TV will automatically enter the standby mode if no operations are performed for 3 hours.

- Five minutes before the TV enters standby mode, the remaining time displays every minute.

### Power Management

PC only

#### Menu Operation: A (page 12)

When set, the TV will automatically enter the standby mode.

#### Item

- Off:**
- No power management
  - Factory preset value.
- Mode1:**
- If there is no signal input for 8 minutes, the TV enters the standby mode.
  - Even if you start using the PC and the signal inputs again, the TV stays in standby mode.
  - The TV turns on again by pressing on the TV or on the remote control unit. (See page 8.)
- Mode2:**
- If there is no signal input for 8 seconds, the TV enters the standby mode.
  - When you start using the PC and the signal inputs again, the TV turns on.
  - The TV turns on again by pressing on the TV or on the remote control unit. (See page 8.)

### Setup menu

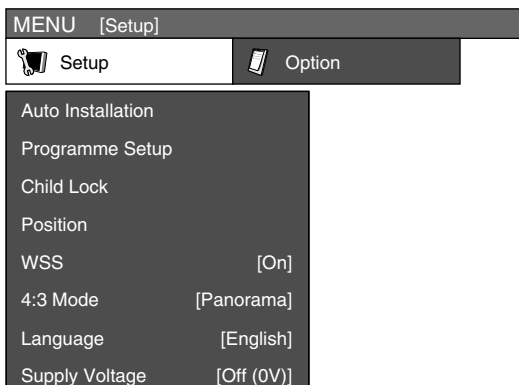

### Auto Installation

TV only

You can run Auto Installation again, even after setting up the preset channels.

- 1 Press **MENU** and the MENU screen displays.
- 2 Press to select "Setup".
- 3 Press to select "Auto Installation", and then press **OK**.  
If you have already set the PIN under "Child Lock", enter it here.
  - See page 17 for setting PIN.
- 4 Press to select "Yes", and then press **OK**.
- 5 You can set language and country the same as in the initial auto installation. Follow steps 1 and 2 on page 8.

### Programme Setup

TV only

This section describes how to set up analogue TV channels manually.

- 1 Press **MENU** and the MENU screen displays.
- 2 Press to select "Setup".
- 3 Press to select "Programme Setup", and then press **OK**.  
If you have already set the PIN under "Child Lock", enter it here.
  - See page 17 for setting PIN.
- 4 Press to select "Auto Search", "Manual Adjust", "Sort" or "Erase Programme", and then press **OK**.

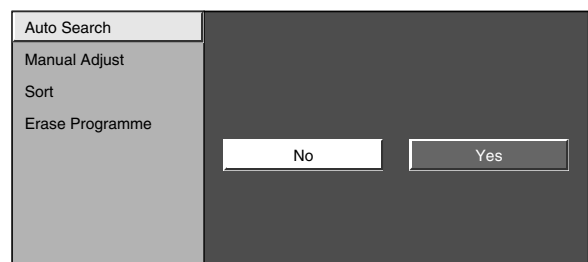

### Auto Search

You can automatically search for and download TV channels by performing the procedure below. This is the same function as from programme auto search to preset download in Auto Installation.

- 1 Repeat steps 1 to 4 in **Programme Setup**.
- 2 Press to select "Yes", and then press **OK**.
  - ① Programme auto search
  - ② Auto labelling
  - ③ Auto sorting
  - ④ Preset download

## Menu operations

### Manual Adjust

You can set some channel items manually.

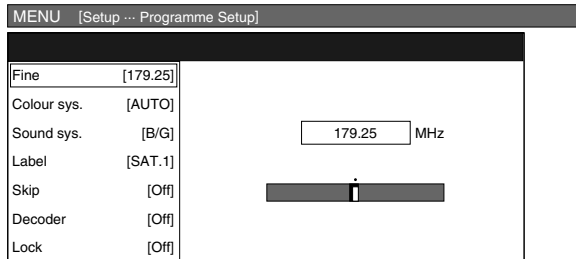

- 1 Press **MENU** and the MENU screen displays.
- 2 Press **◀/▶** to select "Setup".
- 3 Press **▲/▼** to select "Programme Setup", and then press **OK**.  
If you have already set the PIN under "Child Lock", enter it here.
  - See page 17 for setting PIN.
- 4 Press **▲/▼** to select "Manual Adjust", and then press **OK**.
- 5 Press **◀/▶** to select "Yes", and then press **OK**.
- 6 Press **▲/▼/◀/▶** to select the channel you want to edit, and then press **OK**.
  - The selected channel information displays.
- 7 Press **▲/▼** to select the desired menu item, and then press **OK**.
- 8 Press **▲/▼/◀/▶** to select or adjust.

#### NOTE

- When you exit Programme Setup "Manual Adjust" menu, preset download automatically runs if you change information on that menu.

#### Fine

You can adjust the frequency to your desired position.

#### NOTE

- Adjust while checking the background picture as a reference.
- Instead of pressing **◀/▶** to adjust the frequency in step 8 above, you can set by directly entering the frequency number of the channel with **0-9**.

#### EXAMPLE

- 179.25 MHz: Press **1** → **7** → **9** → **2** → **5**.
- 49.25 MHz: Press **4** → **9** → **2** → **5** → **OK**.

#### Colour sys.

Select the optimum colour systems to receive. (AUTO, PAL, SECAM)

#### Sound sys. (Broadcasting system)

Select the optimum sound systems (Broadcasting systems) to receive. (B/G, D/K, I, L, L')

#### Label

When a TV channel sends its Network Name, the Auto Installation detects the information and assigns a name to it. However, you can change individual channel names.

- 1 Repeat steps 1 to 7 in **Manual Adjust**.

- 2 Press **▲/▼/◀/▶** to select each character of the new name for the channel, and then press **OK**.

- 3 Repeat step 2 above until the name is fully spelt out.

- The name can be 5 characters or less.
- If a channel name is less than 5 characters, select "END", then press **OK**.

#### Skip

Channels with "Skip" set to "On" are passed over when using **P▲/P▼** even if selected while watching the image from the TV.

#### Decoder

When connecting a decoder to the unit, you need to select EXT1.

#### NOTE

- "Off" is factory preset value.

#### Lock

You can block the viewing of any channel.

#### NOTE

- See page 17 for setting PIN.
- When Lock is set to "On" for a channel, "Child lock has been activated." displays, and the image and sound of the channel are blocked.
- When pressing **OK** while "Child lock has been activated." displays, PIN input menu will display. Inputting the correct PIN lifts the child lock temporarily until the power is turned off.

### Sort

Channel positions can be sorted freely.

- 1 Repeat steps 1 to 4 in **Programme Setup**.
- 2 Press **◀/▶** to select "Yes", and then press **OK**.
- 3 Press **▲/▼/◀/▶** to select the channel you want to move, and then press **OK**.
- 4 Press **▲/▼/◀/▶** to move it to the desired position, and then press **OK**.
- 5 Repeat steps 3 and 4 until all desired channels are sorted.

### Erase Programme

An individual programme can be erased.

- 1 Repeat steps 1 to 4 in **Programme Setup**.
- 2 Press **◀/▶** to select "Yes", and then press **OK**.
- 3 Press **▲/▼/◀/▶** to select the channel you want to erase, and then press **OK**.
  - A message screen pops up.
- 4 Press **◀/▶** to select "Yes", and then press **OK** to erase the selected programme. All the subsequent programmes move up.
- 5 Repeat steps 3 and 4 until all desired channels are erased.

## Menu operations

### Child Lock

TV only

Allow you to use a PIN to protect certain settings from being accidentally changed.

#### Changing the PIN

- 1 Press **MENU** and the MENU screen displays.
- 2 Press **◀/▶** to select "Setup".
- 3 Press **▲/▼** to select "Child Lock", and then press **OK**.

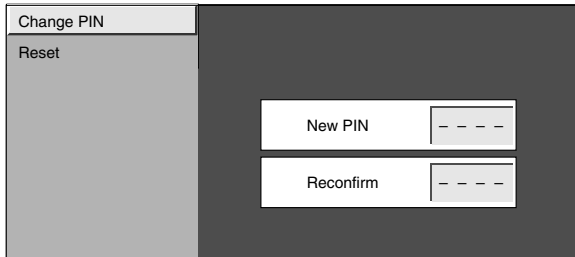

- 4 Enter the 4-digit number as a PIN using **0 – 9**.
- 5 Enter the same 4-digit number as in step 4 to confirm.
  - "The system PIN has been changed successfully" displays.

#### NOTE

- To view a locked channel, you must enter a PIN. (See pages 16 and 27 for locking channels from viewing in analogue TV and DTV mode.) When you select a locked channel, a PIN prompt message pops up. Press **OK** to display the PIN input window.

#### Resetting the PIN

Allow you to reset your PIN to the factory preset "1234".

- 1 Repeat steps 1 to 3 in **Changing the PIN**.
- 2 Enter the PIN.
- 3 Press **▲/▼** to select "Reset", and then press **OK**.
- 4 Press **◀/▶** to select "Yes", and then press **OK**.

#### NOTE

- As a precautionary measure, make a note of your PIN on the back of this operation manual, cut it out and keep it in a safe place that children cannot reach.
- See page 32 for resetting the current PIN to the factory preset "1234" if you lose or forget your PIN.

### Input Label

You can assign each input source a label you like.

- 1 Press **→/←** to select the desired input source.
- 2 Press **MENU** and the MENU screen displays.
- 3 Press **◀/▶** to select "Setup".
- 4 Press **▲/▼** to select "Input Label", and then press **OK**.
- 5 Press **▲/▼/◀/▶** to select each character of the new name for the input source, and then press **OK**.
- 6 Repeat step 5 above until the name is fully spelt out, and then press **OK**.
  - The name can be 6 characters or less.
  - If a label name is less than 6 characters, select "END", then press **OK**.

#### NOTE

- You cannot change the label if the input source is TV or DTV.

### Fine Sync.

PC only

#### Menu Operation: C (page 12)

Ordinarily, the TV automatically adjusts image positions coming from PC (Auto Sync. function). In some cases, however, manual adjustment is needed to optimise the image.

#### Item

- H-Pos.:** Centres the image by moving it to the left or right.
- V-Pos.:** Centres the image by moving it up or down.
- Clock:** Adjusts when the image flickers with vertical stripes.
- Phase:** Adjusts when characters have low contrast or when the image flickers.

#### NOTE

- If you need to adjust the image position, adjust the position using your PC.

## Menu operations

### Position

TV/DTV/AV only

#### Menu Operation: C (page 12)

For adjusting a picture's horizontal and vertical position.

##### Item

- H-Pos.:** Centres the image by moving it to the left or right.  
**V-Pos.:** Centres the image by moving it up or down.

#### NOTE

- Adjustments are stored separately according to input source.
- Depending on the input signal type a position setting may not be available.

### WSS (Wide Screen Signalling)

TV/DTV/AV only

#### Menu Operation: A (page 12)

WSS allows a television to switch automatically among the different screen formats.

#### NOTE

- Use WIDE MODE if an image does not switch to the correct screen format. When the broadcast signal contains no WSS information, the function will not work even if enabled. (See page 20.)

### 4:3 Mode

TV/DTV/AV only

#### Menu Operation: A (page 12)

The WSS signal has 4:3 auto-switching that allows you to select between Normal and Panorama.

##### Item

- Normal:** Normal range keeping 4:3 or 16:9 aspect ratio  
**Panorama:** Wide image without side bars

#### WSS signal 4:3 screen

4:3 mode "Normal"



4:3 mode "Panorama"



### Language

#### Menu Operation: A (page 12)

You can select a language from the Setup menu. Select from among 13 languages. (Dutch, English, Finnish, French, German, Greek, Italian, Polish, Portuguese, Russian, Spanish, Swedish, Turkish)

### Supply Voltage

#### Menu Operation: A (page 12)

Switch on or off the power to the antenna connected to the antenna input terminal. (See page 4.)

### Option menu

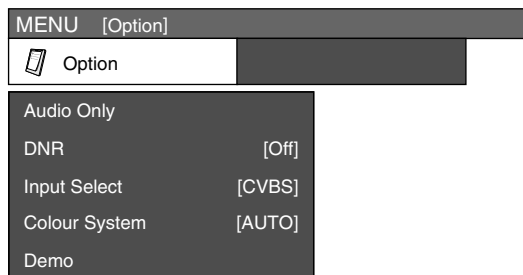

#### NOTE

- "HDMI Setup" is displayed only when "EXT5" or "EXT6" is selected from the INPUT SOURCE menu.

### Audio Only

#### Menu Operation: A (page 12)

When listening to music from a music programme, you can set the TV off and enjoy audio only.

##### Item

- Off:** Both screen images and audio are output.  
**On:** Audio is output without screen image.

## Menu operations



### DNR (Digital Noise Reduction) TV/DTV/AV only

#### Menu Operation: A (page 12)



Produce a clearer image. (Off, High, Low)

### HDMI Setup AV only

HDMI (High-Definition Multimedia Interface) terminal selection.

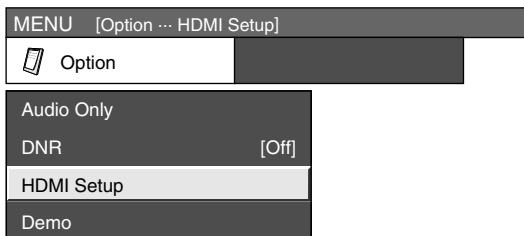
- 1 To watch an HDMI equipment image, select "EXT5" or "EXT6" (the terminal which you are using) from "INPUT SOURCE" menu using  on the remote control unit or TV.
- 2 Press **MENU** and the MENU screen displays.
- 3 Press  to select "Option".
- 4 Press  to select "HDMI Setup", and then press **OK**.
  - "HDMI Setup" is displayed only when "EXT5" or "EXT6" is selected from the INPUT SOURCE menu.



- 5 Press  to select the desired item, and then press **OK**.
- 6 Press  to select the desired setting, and then press **OK**.

HDMI Setup items	Selectable items	Description
<b>Signal Type*</b>	RGB/YCbCr 4:4:4/ YCbCr 4:2:2	Select the video signal type from the HDMI terminal.
<b>Colour Matrix*</b>	ITU601/ITU709	Select the internal colour space conversion method when an RGB signal is input.
<b>Dynamic Range*</b>	Normal/ Enhanced	Select the signal amplitude range. Usually, select "Normal".
<b>Auto View</b>	Disable/Enable	Set whether or not to use WIDE MODE based on signal recognition, including an HDMI signal.
<b>Audio Select**</b>	Digital/Analogue	Select "Digital" for audio signal via the HDMI terminal. Select "Analogue" for audio signal via the AUDIO jack.

#### NOTE

- Refer to your external equipment operation manual for the signal type.
- Items marked \* may be greyed out (with ) depending on the type of signal input from the external equipment.
- Item marked \*\* is only available when EXT5 is selected.

### Input Select

#### Menu Operation: A (page 12)

For setting the signal type of external equipment.

Input source	Signal type
<b>EXT 1</b>	Y/C, CVBS, RGB
<b>EXT 2</b>	Y/C, CVBS, RGB
<b>EXT 3</b>	AUTO
<b>EXT 4</b>	PC (RGB), COMPONENT (Y, P <sub>B</sub> , P <sub>R</sub> )

#### NOTE

- If no (colour) image displays, try to change the other signal type.
- Check the operation manual of the external equipment for the signal type.
- TV, EXT3, EXT5 and EXT6 are not displayed in Input Select.
- If both CVBS and RGB signals are input to EXT 1 or EXT 2 using a SCART cable, the TV may output an RGB signal even though you have designated CVBS for the respective terminal. This happens due to the setting of your external equipment.

### Colour System TV/AV only

#### Menu Operation: A (page 12)

You can change the colour system to one that is compatible with the image on the screen. (AUTO, PAL, SECAM, NTSC3.58, NTSC4.43, PAL-60)

#### NOTE

- Factory preset value is "AUTO".
- If "AUTO" is selected, colour system for each channel is automatically set. If an image does not display clearly, select another colour system (e.g. PAL, SECAM).
- "NTSC3.58", "NTSC4.43" and "PAL-60" cannot be selected in TV tuner mode.

### Demo TV/AV only

#### Menu Operation: C (page 12)

When activated, this function demonstrates some of the functions of the TV on the screen.

#### Item

**Demo:** Sets whether to activate the function.  
**Input Source:** Selects whether to demonstrate all functions of connected terminals or skip some.  
**Teletext:** Sets whether to demonstrate Teletext.  
**Freeze:** Sets whether to demonstrate Freeze.  
**Menu:** Sets whether to demonstrate Menu.  
**Interval:** Sets the interval between the presentations.

#### NOTE

- Some demonstrations may not be presented depending on the settings made above.
- After switching on this demo function, it takes 70 seconds approximately, before the TV-set starts the demo show. The selected functions are shown in a self-repeating sequence. Return to normal television-mode is possible only by deactivating the demo-function.

# Useful features

## WIDE MODE

TV/AV only

You can select the picture size. Selectable picture size varies with the type of signal received.

### Item (for SD (Standard) signal)

**Normal:** For 4:3 "standard" pictures. A side bar appears on each side.

**Zoom 14:9:** For 14:9 letterbox pictures. A thin side bar appears on each side, and you may see bars on the top and bottom with some programmes.

**Panorama:** In this mode the picture is progressively stretched toward each side of the screen.

**Full:** For 16:9 squeeze pictures.



**Cinema 16:9:** For 16:9 letterbox pictures. Bars may appear on the top and bottom with some programmes.

**Cinema 14:9:** For 14:9 letterbox pictures. Bars may appear on the top and bottom with some programmes.

### Item (for HD (High-Definition) signal)

**Full:** Display with the Overscan image. Crop all sides of screen.

## Manual Selection

- 1 Press .
  - The WIDE MODE menu displays.
  - The menu lists the wide mode options selectable for the type of video signal currently received.
- 2 Press  or  while the WIDE MODE menu displays on the screen.
  - As you toggle down the options, each is immediately reflected on the screen. No need to press **OK**.

## Auto Selection

If you set WSS and 4:3 Mode in the Setup menu on page 18, the optimum WIDE MODE is automatically chosen for every broadcast, VCR or DVD containing the WSS information.

## WSS menu

To enable Auto Selection, set WSS in the Setup menu to "On". (See page 18.)

## 4:3 Mode menu

To set the type of the wide screen, select "Normal" or "Panorama" in the 4:3 Mode menu. (See page 18.)

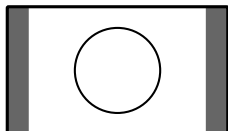

4:3 Mode set to "Normal"

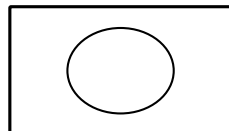

4:3 Mode set to "Panorama"

## NOTE

- If the signal contains no WSS information, Auto Selection will not function even when the WSS option is enabled.

## WIDE MODE

PC only

You can select the picture size.

- 1 Press .
  - The WIDE MODE menu displays.
- 2 Press  or  to select a desired item on the menu.

## NOTE

- Connect the PC before making adjustments. (See page 10.)
- Selectable picture size may vary with input signal type.

## EXAMPLE

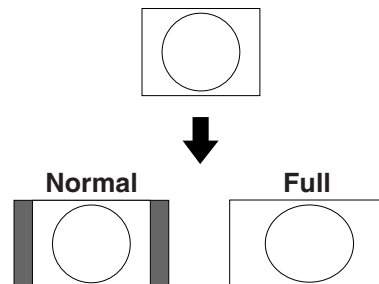

### Item



**Normal:** Keeps the original aspect ratio in a full screen display.

**Full:** An image fully fills the screen.

## Useful features

### Still image

You can freeze a motion picture on the screen.

- 1 Press .
- 2 Press  again to exit still image.

#### NOTE



- When this function is not available, "No still image display available." will display.
- The still image automatically goes out after 30 minutes.

### Teletext function

#### What is Teletext?

Teletext broadcasts pages of information and entertainment to specially equipped television sets. Your TV receives Teletext signals broadcast by a TV network, and decodes them into graphical format for viewing. News, weather and sports information, stock exchange prices and programme previews are among the many services available.

#### Turning on and off Teletext

- 1 Select a TV channel or external input source providing the Teletext programme.
- 2 Press  to display the Teletext.
- 3 Press  again to display the Teletext on the right screen and normal image on the left screen.
  - Each time you press , the screen switches as shown below.

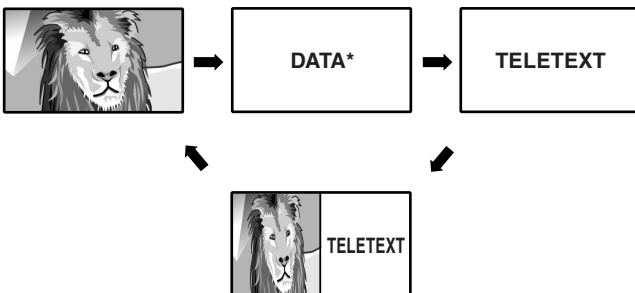

\* May appear in DTV input mode.

- If you select a programme with no Teletext signal, "No Teletext available." displays.
- The same message displays during other modes if no Teletext signal is available.

#### NOTE



- Teletext will not work if the selected signal type is RGB. (See page 19.)

### Time display

You can display the time information included in the DTV and Teletext broadcasts.

#### NOTE





- Skip step 1 if receiving DTV broadcasts.

- 1 Select a TV channel providing Teletext information. (The time information is automatically captured.)
- 2 Press . The channel display will appear on the TV.
- 3 Press  again within the several seconds that the channel display is on the screen. Time information will display below the channel display for several seconds.
- 4 Even when you change the TV channel, you can display the time information with steps 2 and 3 above.

#### NOTE

- The time display cannot be stored once the power is turned off. When you turn on the power, perform steps 1 to 4 again.
- If acquired successfully, the time information will appear in the upper-right corner of the screen by pressing **MENU**.

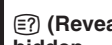
### Button functions

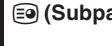
Buttons	Description
<b>P</b> (  )	Increase or decrease the page number.
<b>Colour (Red/Green/Yellow/Blue)</b>	Select a group or block of pages displayed in the coloured brackets at the bottom of the screen by pressing the corresponding <b>Colour (Red/Green/Yellow/Blue)</b> on the remote control unit.
<b>0-9</b>	Directly select any page from 100 to 899 by using <b>0-9</b> .
 ( <b>WIDE MODE</b> )	Switch the Teletext image to Full, Upper half or Lower half.
 ( <b>Reveal hidden Teletext</b> )	Reveal or hide hidden information such as an answer to a quiz.
 ( <b>Freeze/hold</b> )	Stop updating Teletext pages automatically or release the hold mode.
 ( <b>Subtitle for Teletext</b> )	Display the subtitle or exit the subtitle screen. <ul style="list-style-type: none"> <li>• Subtitle will not be displayed when the service does not contain the subtitle information.</li> </ul> <div style="border: 1px solid gray; padding: 5px; margin-top: 5px;"> <p>User for LC-37AD5E, LC-42AD5E:</p> <ul style="list-style-type: none"> <li>• Subtitle is set to off when the power is turned on.</li> </ul> <p>User for LC-37AD5S, LC-42AD5S:</p> <ul style="list-style-type: none"> <li>• Subtitle is set to on when the power is turned on.</li> </ul> </div>
 ( <b>Subpage</b> )	Reveal or hide subpages. <ul style="list-style-type: none"> <li>• Red button: Move to the previous subpage.</li> <li>• Green button: Move to the following subpage.</li> <li>• These two buttons are shown on the screen by the signs <b>-</b> and <b>+</b>.</li> </ul>

# DTV menu operations

## DTV menu operation buttons

Use the following buttons on the remote control unit to operate the DTV Menu.

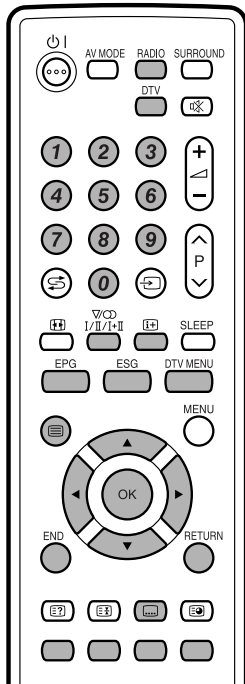

- : Press to display the subtitle selection screen.
- : Press to display TELETEXT or start the MHEG5 presentation, if available.
- 0 - 9**: Aside from direct channel entry, each of the **1 - 9** numeric buttons have a unique function assigned in the Programme Setup screen.
- DTV**: Press to access DTV mode.
- EPG**: Press to open the EPG screen.
- ESG**: Press to open the ESG screen.
- RADIO**: Press to switch between TV and RADIO mode.
  - Due to the large variation in transmitted volume levels in RADIO mode, some stations will produce distortion if the volume level is set too high.
- : Press to open the multi audio screen.
- DTV MENU**: Press to open or close the DTV Menu screen.
- : Press to open the service banner or view detailed information from the EPG/ESG screen.
- : Press to select a desired item on the screen or adjust a selected item.
- OK**: Press to go to the next step or complete the setting. Press to open the Programme List when no other menu screen is active. (Except external input.)
- END**: Press to exit the current menu screen without saving the changes.
- Colour**: Each of the coloured buttons have a unique function assigned in the menu screen.
- RETURN**: Press to return to the previous step.

## DTV On-Screen Display

### Example

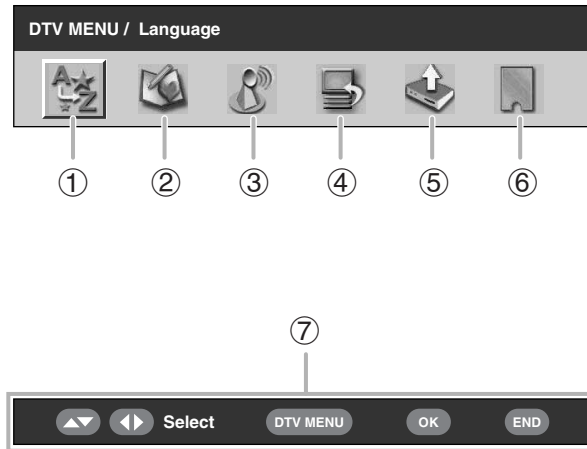

- 1 Language**
  - To customise the language preference for audio and MHEG5 application.
- 2 Programme Setup**
  - To configure various settings for each service. These include: Fav(ourite), Lock, Move, Move To, Skip, Select, Erase, Label, and View functions.
- 3 Installation**
  - To scan all services available in your area, or to label/erase/re-scan the selected carrier.
- 4 System Setup**
  - To configure On-Screen Display and Child Lock settings.
- 5 Accessories**
  - To display the current version of the software or to allow the software upgrade to take place.
- 6 Common Interface**
  - To display the current Common Interface details.
- 7 Navigation buttons**
  - To navigate within the DTV Menu screen.

## DTV common operations

### DTV common menu operation

- 1** Press **DTV** or to access the DTV mode.
- 2** Press **DTV MENU** and the DTV Menu screen displays.
- 3** Press to select the desired menu, and then press **OK** if necessary.
  - From this point, menu operations differ depending on the item you are going to adjust. See the respective section of the menu operation.
  - You cannot select any DTV-related menu items unless "Auto Installation" has been completed.
  - Press **RADIO** to switch between DTV and Radio mode.
  - To exit the current screen without saving the change, press **END**.



## DTV menu operations

### About using the character set screen

In some cases you may be prompted to enter characters. See below for details.

#### Sample Alpha Numerical Character Set screen

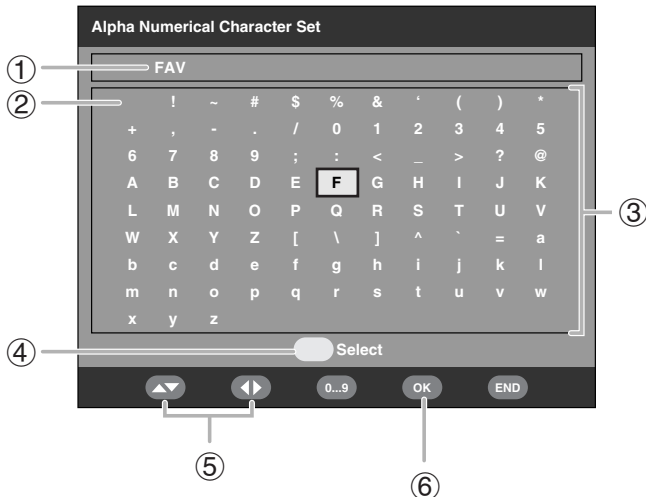

① **Input area**

② **Space**

To add or overwrite with a space.

③ **Character select area**

④ **YELLOW (Select) button**

Press to move between the input area and character select area.

⑤ **▲/▼/◀/▶ button**

Press to move the cursor.

⑥ **OK button**

**While in the input area:**

Confirms the new name.

Once **OK** is pressed to confirm, a confirmation message displays.

Press **◀/▶** to select "Yes", and then press **OK**.

**While in the character select area:**

Confirms the input of a character.

#### Sample operation using Alpha Numerical Character Set

- 1 Call up the character set screen while in the "Label" or "Carrier Setup" screen. (See pages 25 and 26.)
- 2 Press **YELLOW (Select)** to move the cursor to the character select area.
- 3 Press **▲/▼/◀/▶** to select the desired character, and then press **OK**. Repeat until the new name is fully entered.
  - Use space to add a space or overwrite.
- 4 To register the new name, press **YELLOW (Select)** to move the cursor back to the input area.
- 5 Press **OK**.
  - A confirmation message displays.
- 6 Press **◀/▶** to select "Yes", and then press **OK**.

### Language

Select language settings for audio (if a programme is broadcast in more than one language) and MHEG5 service.

- 1 Press **OK** while the cursor is on "Language".
- 2 Press **▲/▼** to select "1st Pref. Audio", "2nd Pref. Audio", "3rd Pref. Audio" or "MHEG".
- 3 Select a desired language for each item.

**NOTE**

- See page 18 to change the language displayed on-screen.
- See page 31 to change the subtitle language.
- See page 31 for details on the MHEG5 service.

#### Available language list

Basque	Greek
Catalan	Italian
Croatian	Norwegian
Czech	Polish
Danish	Portuguese
Dutch	Russian
English*	Serbian
Finnish	Slovak
French	Spanish
Gaelic*	Swedish
Gallegan	Turkish
German	Welsh*

\* Languages available for MHEG5 service

### Programme Setup

Configure various settings for each service. Press the preassigned ① - ⑨ numeric buttons to access each of the functions explained below.

Press **OK** while the cursor is on "Programme Setup".

#### Sample Programme Setup screen

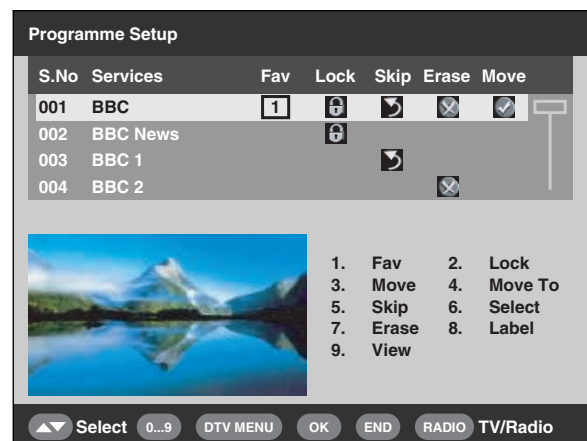

**NOTE**

- The picture window shows a blank image if Radio services are listed.

## DTV menu operations

### Favourite

Assign services to 4 different favourite groups.

- 1 Press ▲/▼ to select the desired service.
- 2 Press ① on the remote control. A selection box displays.
- 3 Press ▲/▼ to register the selected service to any of the 4 favourite groups (None, Fav 1 ... Fav 4) and then press **OK**. An icon displays indicating the favourite status.
  - Do not press **END** to exit the screen here if you wish to register the change.
- 4 Press **OK**.
- 5 Now you can easily select your favourite service from the Programme List. (See page 30.)

#### NOTE

- You cannot register the same service to two different favourite groups.

### Lock

When the service is locked, you must enter your PIN whenever you tune to the service.

- 1 Press ▲/▼ to select the desired service.
- 2 Press ② on the remote control. If you have already set the PIN, enter it here. If not, enter the factory preset PIN "1234". An icon displays indicating the service is locked.
  - Pressing ② will turn the lock icon on and off. (PIN entry is required when lifting the lock icon.)
  - Do not press **END** to exit the screen here if you wish to register the change.
- 3 Press **OK**.

#### NOTE

- See page 17 for setting the PIN.

### Move

Sort the order of the selected service by moving the service position.

- 1 Press ▲/▼ to select the desired service.
- 2 Press ③ on the remote control. An icon displays indicating the service to be moved.
  - Pressing ③ will turn the move icon on and off.
- 3 Move the selected service to the desired position using ▲/▼, and then press **OK**.
  - Do not press **END** to exit the screen here if you wish to register the change.
- 4 Press **OK** to register the change.

#### EXAMPLE:

**Moving "002 ZDF" ahead of "001 ARD".**

Default order: Press ▲/▼ to select the desired service in 001←→002←→003←→004.

Sorted order: Press ▲/▼ to select the desired service in 002←→001←→003←→004.

001	ARD	→	002	ZDF
002	ZDF		001	ARD
003	SAT. 1		003	SAT. 1
004	RTL		004	RTL

### Move To

Use this function to change the position of two selected services.

- 1 Press ▲/▼ to select the desired service.
- 2 Press ④ on the remote control.
- 3 Enter the number you want to change to using ① - ⑨ numeric buttons, and then press **OK**. The positions of the selected services are switched.
  - Do not press **END** to exit the screen here if you wish to register the change.
  - You cannot enter a service number that is not listed.
- 4 Press **OK** again, the message "Successfully updated" displays. The change is now registered.

001	ZDF	→	001	RTL
002	ARD		002	ARD
003	SAT. 1		003	SAT. 1
004	RTL		004	ZDF

### Skip

Services that are set to skip will not be picked up when pressing **P** (▼/▲).

- 1 Press ▲/▼ to select the desired service.
- 2 Press ⑤ on the remote control. An icon displays indicating the service to be skipped.
  - Pressing ⑤ will turn the skip icon on and off.
  - Do not press **END** to exit the screen here if you wish to register the change.
- 3 Press **OK**.

#### NOTE

- To view services that are set to be skipped, use ① - ⑨ numeric buttons or select from the Programme List.

## DTV menu operations

### Select

Use this function to jump to the specific service in one step. This is useful when there are many services displayed on screen to scroll through.

- 1 Press **6** on the remote control. Now you can change the service number on the left side of the screen.
- 2 Enter the number using **0** - **9** numeric buttons, and then press **OK**. The highlight moves to the selected service.

### Erase

Erase the selected service(s) from the memory.

- 1 Press **▲/▼** to select the desired service.
- 2 Press **7** on the remote control. An icon displays indicating the service to be erased.
  - Pressing **7** will turn the erase icon on and off.
  - Do not press **END** to exit the screen here if you wish to register the change.
- 3 Press **OK**.
  - A confirmation message displays.
- 4 Press **◀/▶** to select "Yes", and then press **OK**.

### Label

Change individual service names.

- 1 Press **▲/▼** to select the desired service.
- 2 Press **8** on the remote control. A character set screen displays.
- 3 Enter new name for the service. See page 23 for operations using the character set screen.

### View

Tune to the service shown in the picture window.

- 1 Press **▲/▼** to select the desired service.
- 2 Press **9** on the remote control.
  - The image shown in the picture window changes.
- 3 Press **END** to exit the Programme Setup screen to view the image in full screen.

## Installation

This section describes how to reconfigure the DTV settings after conducting **Initial auto installation (DTV)** on page 8.

### Auto Installation

The TV automatically detects and stores all available services in your area. See **Initial auto installation (DTV)** on page 8 for details.

#### NOTE

- If the TV detects a new carrier/service that has become available after performing "Auto Installation", the message "Do you want to save?" displays. Press **◀/▶** to select "Yes" or "No", and then press **OK**.

### Carrier Scan

Manually add a new carrier by entering the desired carrier number or frequency band.

- 1 Press **◀/▶** to select "Installation".
- 2 Press **▲/▼** to select "Carrier Scan", and then press **OK**.  
If you have already set the PIN, enter it here. If not, enter the factory preset PIN "1234".

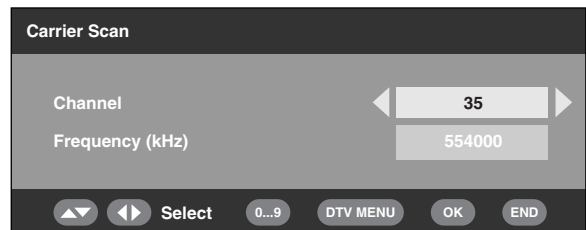

- 3 Press **▲/▼** to select "Channel", then **◀/▶** to enter the carrier number, and then press **OK**.
  - The frequency of the selected carrier in the below cell changes correspondingly.
- 4 After the scan is complete, the screen shows all available services for the selected range.
- 5 A confirmation message displays. Press **◀/▶** to select "Yes", and then press **OK** to save the change.

#### NOTE

- You can directly enter the frequency instead of step 3. In this case, select "Frequency (kHz)", enter the number using **0** - **9** numeric buttons, and then press **OK**. Use **◀/▶** to move between the digits.
- After performing "Carrier Scan", the order stored by using the "Move" function will revert to the default order.
- See page 17 for setting the PIN.

## DTV menu operations

### Carrier Setup

This is provided for you to rename (label), erase, or re-scan carriers. "Carrier" in this context refers to a service station that provides a set of individual services.

- 1 Press **◀/▶** to select "Installation".
- 2 Press **▲/▼** to select "Carrier Setup", and then press **OK**.  
If you have already set the PIN, enter it here. If not, enter the factory preset PIN "1234".

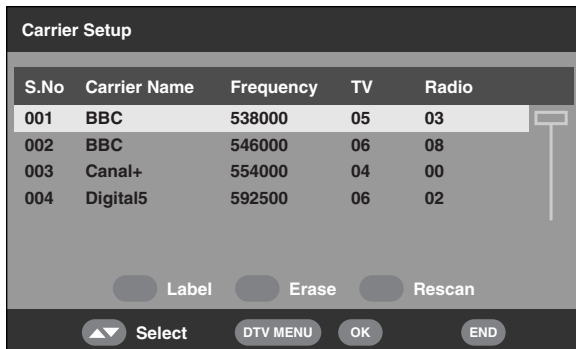

- ① **To rename the selected carrier:**  
Select the carrier, and then press **RED** (Label). The character set screen displays. Enter a new name for the carrier. See page 23 for details on using the character set screen.
- ② **To erase the selected carrier:**  
Select the carrier, and then press **GREEN** (Erase). An icon displays indicating the carrier to be erased. Pressing **GREEN** will turn the erase icon on and off. Press **OK**. A confirmation message displays. Press **◀/▶** to select "Yes", and then press **OK**.
- ③ **To re-scan the selected carrier:**  
Select the carrier, and then press **BLUE** (Rescan). Re-scanning starts. A confirmation message displays. Press **◀/▶** to select "Yes", and then press **OK**.

#### NOTE

- After re-scanning the selected carrier, the order stored by using the "Move" function will revert to the default order.

### System Setup

Configure On-Screen Display and Child Lock settings.

#### OSD Setup

The On-Screen Display appearance and the position/duration of the service banner information can be customised.

- 1 Press **◀/▶** to select "System Setup".
- 2 Press **OK**.

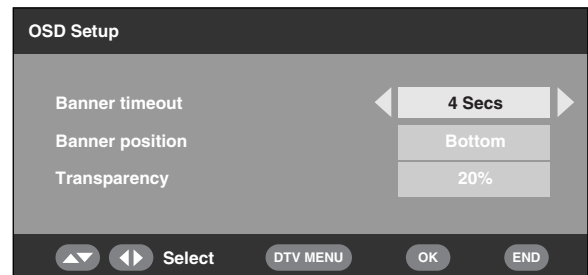

- 3 Press **▲/▼** to select the desired item.
- 4 Press **◀/▶** to select the desired parameter, and then press **OK**.
- 5 A confirmation message displays. Press **◀/▶** to select "Yes", and then press **OK** to save the change.

OSD Setup items	Selectable items	Description
Banner timeout	1 Sec/2 Secs/... 7 Secs/None	Select how long the service banner information appears on screen.
Banner position	Top/Bottom	Select whether the service banner information appears on top or bottom of the screen.
Transparency	None/10%/20%/...50%	Select the desired level of On-Screen Display transparency.

## DTV menu operations

### Child Lock

This function allows TV and Radio services to be restricted. It prevents children from watching violent or sexual scenes that may be harmful.

- 1 Press ◀▶ to select "System Setup".
- 2 Press ▲▼ to select "Child Lock", and then press **OK**.
- 3 If you have already set the PIN, enter it here. If not, enter the factory preset PIN "1234".
- 4 Press ◀▶ to select the desired age/rating (4 ...18/Universal/Parental/X-rated/None), and then press **OK**.

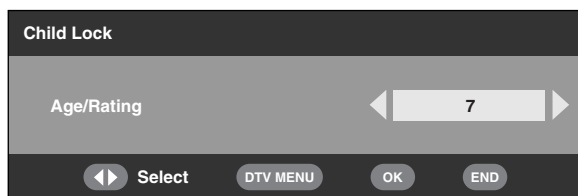

#### NOTE

- "Universal" and "Parental" are the ratings used exclusively in France.
- "X-rated" is the rating used exclusively in Spain.
- For details about ratings see page 34.

### Accessories

Check the version information of the digital module and allow it to be upgraded (when available).

### Software Version

- 1 Press ◀▶ to select "Accessories".
- 2 Press **OK**.
  - The software version is displayed.

### Software Upgrade

The software for controlling the built-in DTV decoder can be upgraded when necessary. In Great Britain this can be achieved via an Over Air Download.

#### Preparation

Confirm and make a note of the current software version number as in step 2 of **Software Version**.

#### Manual upgrade

- 1 Press ◀▶ to select "Accessories".
- 2 Press ▲▼ to select "Software Upgrade", and then press **OK**. The TV checks all carriers if there is a new software available for upgrade.

##### ① If upgrade via Over Air Download is available at the time:

A confirmation message appears asking you to accept the upgrade or not.

To download now, press ◀▶ to select "Yes", and then press **OK**. After the upgrade is completed, the TV restarts automatically with the new software version installed.

To postpone the download, press ◀▶ to select "No", and then press **OK**. Enter the download time for more convenient time as instructed.

The software upgrade will not be carried out if there is no new software available at the specified download time.

##### ② If upgrade via Over Air Download is NOT available at the time:

A message tells you that there is no software available to be downloaded.

- 3 Check the new software version number to confirm the successful upgrade.

#### Auto upgrade

- 1 When you tune to the service that provides the upgrade via Over Air Download, a confirmation message displays.
- 2 Follow the screen prompts.
- 3 Check the new software version number to confirm the successful upgrade.

#### NOTE

- To scan all carriers for upgrade availability, perform the manual upgrade.
- The software upgrade may take about 30 minutes, but may take longer (up to 1 hour) depending on the signal status. While updating, you cannot switch to TV or external input mode or enter standby mode using ⏻ | on the remote control unit.

#### CAUTION

- **Do not disconnect the AC cord when the software upgrade is in progress, as this may cause the upgrade to fail. If problem arises ask a qualified service personnel before the software upgrade period expires.**

### Common Interface

Check the detailed information on the Common Interface module card in use.

- 1 Press **OK** while the cursor is on "Common Interface".

- The CI module name is displayed.

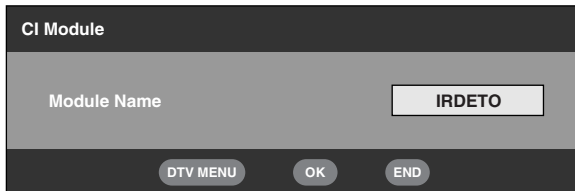

- 2 Press **OK** to access the CI menu.
  - Detailed information on the CI card in use is displayed.
- 3 Press **▲/▼** to select the item, and then press **OK**.
  - Detailed information on the selected item is displayed.

### Inserting a CA card

A single DVB Common Interface (CI) will be implemented to allow adoption of a Conditional Access (CA) system by means of a plug-in CA module. Scrambled Broadcasting service can be routed via the CA system.

If the CA system on the CI module requires a smart-card reader, this reader shall be part of the CI module. When the compatible CA card is inserted, you can view the programme without any operations.

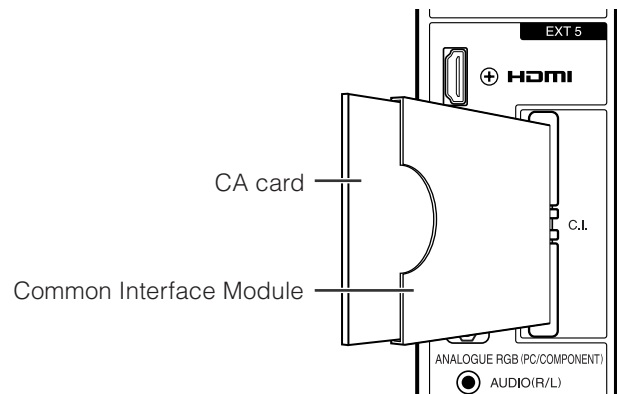

When the compatible card is not inserted:

- ① Select the programme which needs the compatible CA card.
  - The caution screen appears.
- ② Insert the compatible CA card.
  - The caution screen disappears and you can view the programme.

CA system supported by:

Crypto Works  
Aston CAM  
VIAccess  
Nagra Vision  
Irdeto  
MR CAM

#### NOTE

- To view paid TV broadcasting, you need to make a contract with a service provider. Please contact a service provider for details.
- The Common Interface Module and the CA card are neither supplied nor optional accessories.

### Supplying power to the antenna

You may choose to supply power through the antenna terminal. (See page 4.)

#### NOTE

- This function is enabled using the Analogue Menu. See page 18 for details.

# Useful features (DTV)

## About EPG

With the Electronic Programme Guide (EPG), you can check the schedule of DTV and Radio events, view detailed information about them, tune to an event currently on-air and set a timer for future events.

### General EPG screen

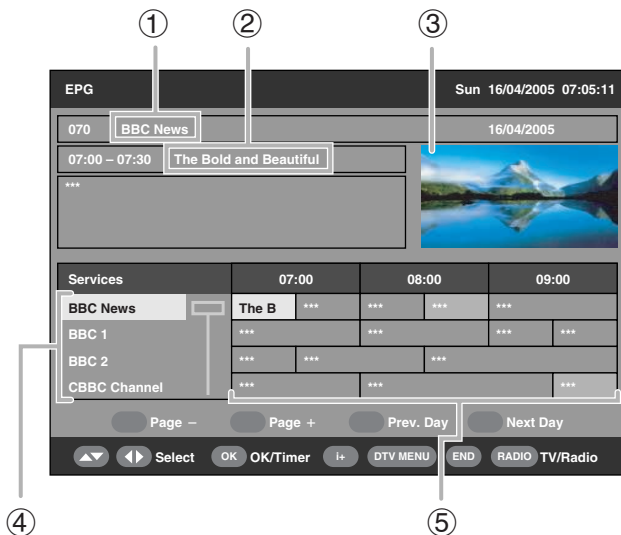

① **Service name**

② **Event name**

③ **Picture window**

④ **Service list**

- Shows the list of all services currently available. As you scroll down the list, the rows in the Event name list on the right will be refreshed correspondingly.

⑤ **Event name list**

- Shows the names of current events in a grid of rows and columns. You can check scheduled event information up to several days ahead, depending on conditions.
- If a received programme does not contain a name, either "No event name" or a blank space will be displayed. However, the programme can still be watched.

## Using the EPG

**1 Press EPG.**

- Pressing **RADIO** will switch between DTV and Radio mode.

**2 Press ▲/▼/◀/▶ to access the desired service or event.**

- The image shown in the picture window changes.

### In the Service list:

- Press ▲/▼ to scroll the page up/down. Or,
- Press **RED** (Page -) or **GREEN** (Page +) to skip to the previous/next page in one step.

### In the Event name list:

- Press ◀/▶ to scroll the page left/right. Or,
- Press **YELLOW** (Prev. Day) or **BLUE** (Next Day) to skip to the previous/next day in one step.

**3 To watch an event currently on-air, press OK (OK/Timer).**

- The TV will show the image in full screen.
- Selecting an event that has not yet started will activate the EPG Timer mode instead.

### NOTE

- Pressing **i+** opens the EPG Description screen that provides more information about the selected event. Press **i+** or **END** to exit.

## Using the EPG Timer

When the Timer is set, the TV automatically tunes to a preset TV event when its on-air time begins.

**1 Press EPG.**

**2 Press ▲/▼/◀/▶ to select the desired event to be preset from the Event name list, and then press OK (OK/Timer).**

- Select an event not yet started.

**3 Press RED (Timer Mode), and then press ▲/▼ to select the desired parameter (Once, Daily, Weekly, or Monthly), and then press OK.**

- Once set, the preset event is indicated with an orange background in the EPG event name list.

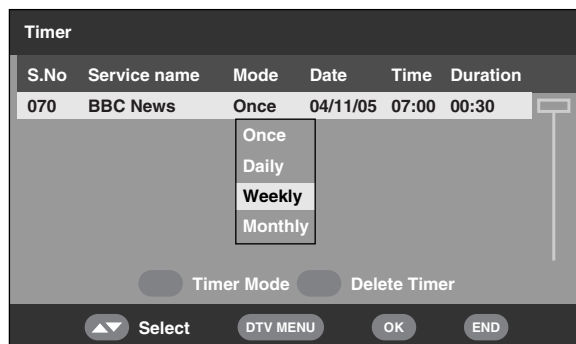

### NOTE

- If using this function for recording, make sure to set the timer of your recording equipment as well.
- Do not switch channels while recording using this function.
- This function cannot be set for locked services or when Child Lock applies. (See pages 24 and 27.)
- Up to 8 events can be preset using the Timer function.
- If the TV is in standby mode when the preset on-air time nears, it will output signals for recording without image displayed on the screen.
- If you are watching another event, an alarm message displays on the screen a few seconds before the preset time.
- To cancel the preset, select the event to delete, press **GREEN** (Delete Timer), press ◀/▶ to select "Yes", and then press **OK**.
- An alert message displays when the preset events overlap one another.
- The TV power may not come on for several seconds if you preset an event using the EPG Timer and if the AC cord has been disconnected.
- Once you preset an event using the EPG Timer, in DTV, and then press **U** on the remote control to enter the standby mode, the power consumption will be higher than normal (about 22 W) until the programmed event is broadcast. When pressing **U** on the TV to turn off the power, the power consumption will be same as normal standby consumption (about 0.9 W), and the EPG Timer will not be in operation.

## Useful features (DTV)

### Using the ESG

The Electronic Service Guide (ESG) is a simplified version of EPG, giving you only essential information of current events for faster access.

- 1 Press **ESG**.
  - The ESG screen displays.

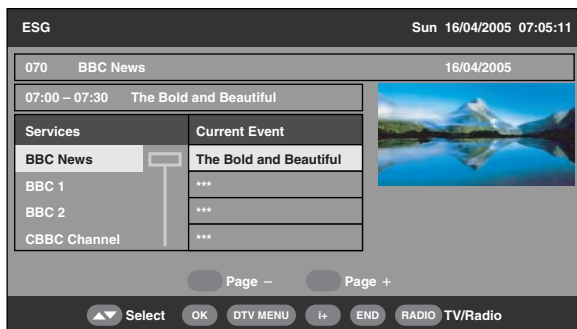

- 2 Press **▲/▼** to select a desired service, and then press **OK**.
  - The TV will show the image in full screen.

#### NOTE

- Basic operation procedures are similar to EPG operations.
- ESG does not provide information about future events, or access to Timer function.

### Using the digital programme list

Select services by using the Programme List instead of using **0** - **9** numeric buttons or **P** (**√/∧**).

- 1 Press **OK** when no other menu screen is displayed. (Except external input.)



Currently tuned service

Service shown in picture window

- 2 The screen shows the service list in either TV or Radio mode sorted by favourite type (All, Fav 1 - 4) as configured in page 24.
- 3 Press **▲/▼** to select the desired service, and then press **OK**.
  - The image shown in the picture window changes.
- 4 Press **END** to exit the Programme List to watch the image in full screen.

### Viewing a service banner

A service banner shows event names, start/end time of event, and other useful information.

- 1 Press **i+**.

#### Service banner

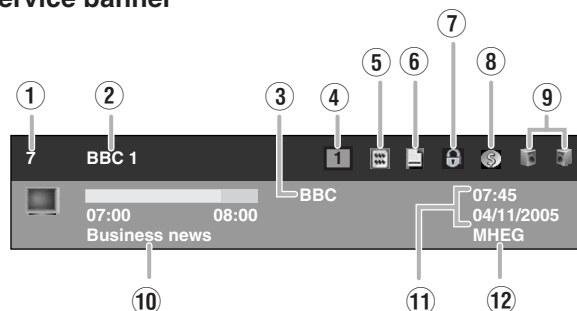

- 1 Logical channel number
- 2 Service name
- 3 Carrier name
- 4 Favourite type
- 5 Teletext available
- 6 Subtitle available
- 7 Lock status
- 8 Scrambled service
- 9 Multi audio status
- 10 Current event name
- 11 Current date and time
- 12 MHEG5 service available

- 2 To display more detailed information, press **i+** again.

- You can verify the signal strength and quality of the selected service here.



## Useful features (DTV)

### Using the multi audio function

Change the audio mode and language for the currently viewed service.

- 1 Press  $\nabla/\square/\square/\square$  when no other menu screen is displayed.

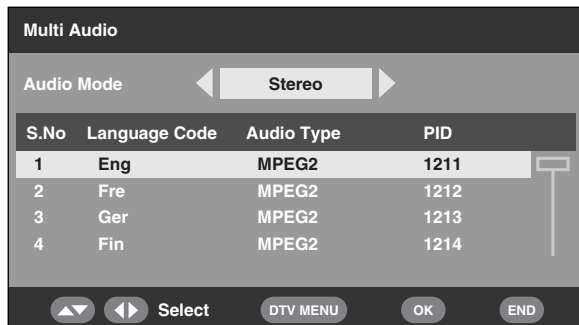

- 2 Press  $\leftarrow/\rightarrow$  to select the desired audio mode (Left, Right, L+R, Stereo), and then press  $\nabla$  to move down.
- 3 Press  $\blacktriangle/\blacktriangledown$  to select the desired language available for the service, and then press **OK**.

#### NOTE

- Once you tune to another service or the power is turned off, the setting returns to the parameter set in the Language menu (page 23).

### Displaying subtitles

Set the desired language for the subtitle display and enable/disable the subtitle display.

- 1 Press  $\square$  when no other menu screen is displayed.

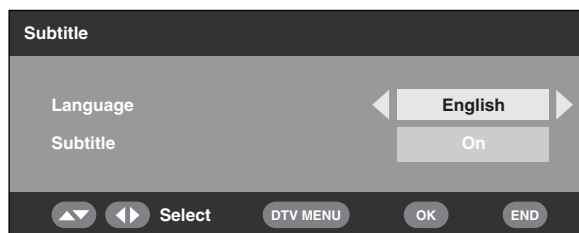

- 2 Press  $\blacktriangle/\blacktriangledown$  to select "Language",  $\leftarrow/\rightarrow$  to select the desired language available in the stream, and then press  $\nabla$ .
- 3 Select "Subtitle", press  $\leftarrow/\rightarrow$  to select "On" or "Off".
  - A confirmation message displays.
- 4 Press  $\leftarrow/\rightarrow$  to select "Yes", and then press **OK**.

#### NOTE

- When "Subtitle" is set to "On", the TV will automatically start subtitle presentation if tuned to a programme containing subtitle data.
- This function deactivates each time you turn off the TV.
- When you press  $\square$  while watching DTV broadcasts, the message "No subtitle" may appear instead of the Subtitle OSD screen as mentioned. (This happens depending on the type of programme and happens even when the TV is actually receiving the subtitle data.)  
In this case, press  $\square$  first to activate the teletext mode, then press  $\square$ .

User for LC-37AD5E, LC-42AD5E:

- Subtitle is set to off when the power is turned on.

User for LC-37AD5S, LC-42AD5S:

- Subtitle is set to on when the power is turned on.

### Using the MHEG5 application (UK only)

Some services bring you programmes with the MHEG (Multimedia and Hypermedia Expert Group) application encoded, letting you experience DTV interactively.

When provided, the MHEG5 application will start when you press  $\square$ .

#### Sample MHEG5 screen







#### NOTE

- When "Subtitle" is set to "On", and the TV is tuned to a service containing both MHEG5 and subtitle data, the subtitle takes priority and subtitle presentation starts automatically. In this case press  $\square$  to start the MHEG5 presentation.

# Appendix

## Troubleshooting

Problem	Possible Solution
<ul style="list-style-type: none"> <li>No power.</li> </ul>	<ul style="list-style-type: none"> <li>Check if you pressed  on the remote control unit. (See page 8.) If the indicator on the TV lights up red, press   .</li> <li>Is the AC cord disconnected? (See page 4.)</li> <li>Check if you pressed  on the TV. (See page 8.)</li> </ul>
<ul style="list-style-type: none"> <li>Unit cannot be operated.</li> </ul>	<ul style="list-style-type: none"> <li>External influences such as lightning, static electricity, etc., may cause improper operation. In this case, operate the unit after first turning the power off, or unplugging the AC cord and re-plugging it in after 1 or 2 minutes.</li> </ul>
<ul style="list-style-type: none"> <li>Remote control unit does not operate.</li> </ul>	<ul style="list-style-type: none"> <li>Are batteries inserted with polarity (+, -) aligned? (See page 5.)</li> <li>Are batteries worn out? (Replace with new batteries.)</li> <li>Are you using it under strong or fluorescent lighting?</li> <li>Is a fluorescent light illuminated to remote control sensor?</li> </ul>
<ul style="list-style-type: none"> <li>Picture is cut off.</li> </ul>	<ul style="list-style-type: none"> <li>Is the image position correct? (See page 18.)</li> <li>Are screen mode adjustments (4:3 Mode/WSS) such as picture size made correctly? (See pages 18 and 20.)</li> </ul>
<ul style="list-style-type: none"> <li>Strange colour, light colour, or dark, or colour misalignment.</li> </ul>	<ul style="list-style-type: none"> <li>Adjust the picture tone. (See pages 13 and 14.)</li> <li>Is the room too bright? The picture may look dark in a room that is too bright.</li> <li>Check the colour system setting. (See pages 16 and 19.)</li> <li>Check the HDMI Setup setting. (See page 19.)</li> </ul>
<ul style="list-style-type: none"> <li>Power is suddenly turned off.</li> </ul>	<ul style="list-style-type: none"> <li>The unit's internal temperature has increased. Remove any objects blocking vent or clean.</li> <li>Check the power control setting. (See page 15.)</li> <li>Is sleep timer set? Press <b>SLEEP</b> on the remote control unit until it sets to Off.</li> </ul>
<ul style="list-style-type: none"> <li>No picture.</li> </ul>	<ul style="list-style-type: none"> <li>Is connection to other components correct? (See pages 9 and 10.)</li> <li>Is input signal type selected correctly after connection? (See page 19.)</li> <li>Is the correct input source selected? (See page 9.)</li> <li>Is non-compatible signal being input? (See page 33.)</li> <li>Is picture adjustment correct? (See pages 13 and 14.)</li> <li>Is the antenna connected properly? (See page 4.)</li> <li>Is "On" selected in "Audio Only"? (See page 18.)</li> </ul>
<ul style="list-style-type: none"> <li>No sound.</li> </ul>	<ul style="list-style-type: none"> <li>Is the volume too low? (See pages 6 and 7.)</li> <li>Make sure that headphones are not connected. (See page 7.)</li> <li>Check if you pressed  on the remote control unit. (See page 6.)</li> </ul>
<ul style="list-style-type: none"> <li>The DTV menu screen is displayed in monochrome and hard to select the item.</li> </ul>	<ul style="list-style-type: none"> <li>Check if "Monochrome" is set to "On". If so, set it to "Off". (See page 14.)</li> </ul>
<ul style="list-style-type: none"> <li>The TV sometimes makes a cracking sound.</li> </ul>	<ul style="list-style-type: none"> <li>This is not a malfunction. This happens when the cabinet slightly expands and contracts according to change in temperature. This does not affect the TV's performance.</li> </ul>

### Cautions regarding use in high and low temperature environments

- When the unit is used in a low temperature space (e.g. room, office), the picture may leave trails or appear slightly delayed. This is not a malfunction, and the unit will recover when the temperature returns to normal.
- Do not leave the unit in a hot or cold location. Also, do not leave the unit in a location exposed to direct sunlight or near a heater, as this may cause the cabinet to deform and the LCD panel to malfunction.  
Storage temperature: -20°C to +60°C.

### IMPORTANT NOTE ON RESETTING THE PIN

We suggest that you remove the following instruction from the operation manual to prevent children from reading it. As this operation manual is multilingual, we also suggest the same with each language. Keep it in a safe space for future reference.



1 Repeat steps 1 to 3 in **Changing the PIN**. (See page 17.)

2 Enter "3001" to cancel out the current PIN.

- The PIN resets to the factory preset "1234".

## Appendix

### PC compatibility chart

Resolution		Horizontal Frequency	Vertical Frequency	VESA Standard
VGA	640 × 480	31.5 kHz	60 Hz	✓
SVGA	800 × 600	37.9 kHz	60 Hz	✓
XGA	1024 × 768	48.4 kHz	60 Hz	✓

VGA, SVGA and XGA are registered trademarks of International Business Machines Co., Inc.

#### NOTE

- This TV has only limited PC compatibility, correct operation can only be guaranteed if the video card conforms exactly to the VESA 60Hz standard. Any variations from this standard will result in picture distortions.

### RS-232C port specifications

#### PC Control of the TV

- When a program is set, the TV can be controlled from the PC using the RS-232C terminal. The input signal (PC/video) can be selected, the volume can be adjusted and various other adjustments and settings can be made, enabling automatic programmed playing.
- Attach an RS-232C cable cross-type (commercially available) to a 9 pin D-sub/MINI-DIN (optional: AN-A1RS) for the connections.

#### NOTE

- This operation system should be used by a person who is accustomed to using PCs.

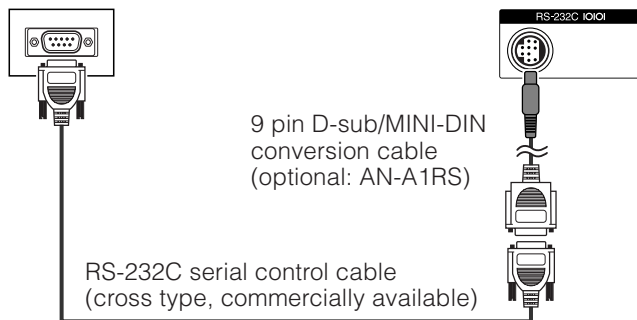

#### Communication conditions

Set the RS-232C communications settings on the PC to match the TV's communications conditions. The TV's communications settings are as follows:

<b>Baud rate:</b>	9,600 bps
<b>Data length:</b>	8 bits
<b>Parity bit:</b>	None
<b>Stop bit:</b>	1 bit
<b>Flow control:</b>	None

#### Communication procedure

Send the control commands from the PC via the RS-232C connector.

The TV operates according to the received command and sends a response message to the PC.

Do not send multiple commands at the same time. Wait until the PC receives the OK response before sending the next command.

#### Command format

Eight ASCII codes + CR

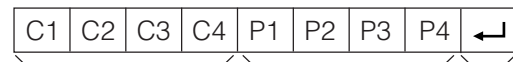

Command 4-digits      Parameter 4-digits      Return code

Command 4-digits: Command. The text of four characters.

Parameter 4-digits: Parameter 0 – 9, ×, blank, ?

#### Parameter

Input the parameter values, aligning left, and fill with blank(s) for the remainder. (Be sure that four values are input for the parameter.)

When the input parameter is not within an adjustable range, "ERR" returns. (Refer to "Response code format".)

0			
---	--	--	--

0	0	0	9
---	---	---	---

-	3	0	
---	---	---	--

1	0	0	
---	---	---	--

0	0	5	5
---	---	---	---

When "?" is input for some commands, the present setting value responds.

?			
---	--	--	--

?	?	?	?
---	---	---	---

#### Response code format

Normal response

O	K	↵
---	---	---

Return code (0DH)

Problem response (communication error or incorrect command)

E	R	R	↵
---	---	---	---

Return code (0DH)

# Appendix

## Commands

CONTROL ITEM	COMMAND	PARAMETER	CONTROL CONTENTS	CONTROL ITEM	COMMAND	PARAMETER	CONTROL CONTENTS
POWER SETTING	P O W R	0 _ _ _	POWER OFF (STANDBY)	POSITION	H P O S	* * * _	H-POSITION AV (-10 - +10)
INPUT SELECTION A	I T G D	_ _ _ _	INPUT SWITCHING (Toggle)		H P O S	? ? ? ?	AV (-10 - +10)
	I T V D	_ _ _ _	TV (CHANNEL FIXED)		V P O S	* * * _	V-POSITION AV (-10 - +10)
	I D T V	_ _ _ _	DTV (CHANNEL FIXED)		V P O S	? ? ? ?	AV (-10 - +10)
	I A V D	* _ _ _	EXT1 - 6 (1 - 6)		C L C K	* * * _	CLOCK (0 - 180)
	I A V D	? ? ? ?	1 to 6, ERR (TV/DTV)		C L C K	? ? ? ?	0 to 180
CHANNEL	D C C H	* * _ _	TV DIRECT CHANNEL (1 - 99)		P H S E	* * _ _	PHASE (0 - 40)
	D C C H	? ? ? ?	1 to 99		P H S E	? ? ? ?	0 to 40
	C H U P	_ _ _ _	CHANNEL UP	WIDE MODE	W I D E	0 _ _ _	WIDE MODE (Toggle)
	C H D W	_ _ _ _	CHANNEL DOWN		W I D E	1 _ _ _	NORMAL (AV)
	D T V D	* * * _	DTV DIRECT CHANNEL (1 to 999)		W I D E	2 _ _ _	ZOOM 14:9 (AV)
	D T V D	? ? ? ?	1 to 999		W I D E	3 _ _ _	PANORAMA (AV)
	D T U P	_ _ _ _	DTV CHANNEL UP		W I D E	4 _ _ _	FULL (AV)
	D T D W	_ _ _ _	DTV CHANNEL DOWN		W I D E	5 _ _ _	CINEMA 16:9 (AV)
INPUT SELECTION B	I N P 1	0 _ _ _	EXT1 (Y/C)		W I D E	6 _ _ _	CINEMA 14:9 (AV)
	I N P 1	1 _ _ _	EXT1 (CVBS)		W I D E	9 _ _ _	NORMAL (PC)
	I N P 1	2 _ _ _	EXT1 (RGB)		W I D E	1 0 _ _	FULL (PC)
	I N P 1	? ? ? ?	0 to 2		W I D E	? ? ? ?	1 to 10
	I N P 2	0 _ _ _	EXT2 (Y/C)	MUTE	M U T E	0 _ _ _	MUTE (Toggle)
	I N P 2	1 _ _ _	EXT2 (CVBS)		M U T E	1 _ _ _	MUTE ON
	I N P 2	2 _ _ _	EXT2 (RGB)		M U T E	2 _ _ _	MUTE OFF
	I N P 2	? ? ? ?	0 to 2		M U T E	? ? ? ?	1 to 2
	I N P 3	0 _ _ _	EXT3 (Rear)	SURROUND	A C D V	0 _ _ _	SURROUND (Toggle)
	I N P 3	2 _ _ _	EXT3 (Side)		A C D V	1 _ _ _	SURROUND ON
	I N P 4	0 _ _ _	EXT4 (RGB)		A C D V	2 _ _ _	SURROUND OFF
	I N P 4	1 _ _ _	EXT4 (COMPONENT)		A C D V	? ? ? ?	1 to 2
	I N P 4	? ? ? ?	0 to 1	AUDIO CHANGE	A C H A	_ _ _ _	SOUND SELECT (ST/Bilingual/mono)
	I N P 5	0 _ _ _	EXT5 (HDMI)	SLEEP TIMER	O F T M	0 _ _ _	OFF
I N P 6	0 _ _ _	EXT6 (HDMI)	O F T M		1 _ _ _	30 m	
AV MODE SELECTION	A V M D	0 _ _ _	AV MODE SELECTION (Toggle)		O F T M	2 _ _ _	1 h 00 m
	A V M D	1 _ _ _	STANDARD		O F T M	3 _ _ _	1 h 30 m
	A V M D	2 _ _ _	SOFT		O F T M	4 _ _ _	2 h 00 m
	A V M D	3 _ _ _	ECO		O F T M	5 _ _ _	2 h 30 m
	A V M D	4 _ _ _	USER	O F T M	? ? ? ?	0 to 150	
	A V M D	5 _ _ _	DYNAMIC	TEXT	T E X T	0 _ _ _	TEXT OFF
A V M D	? ? ? ?	1 to 5	T E X T		1 _ _ _	TEXT CHANGE (Toggle)	
VOLUME	V O L M	* * _ _	VOLUME (0 - 60)		T E X T	? ? ? ?	0 to 1
	V O L M	? ? ? ?	0 to 60		D C P G	* * * _	DIRECT PAGE JUMP (100 - 899)
				D C P G	? ? ? ?	100 to 899	

### NOTE

- If an underbar ( \_ ) appears in the parameter column, enter a space.
- If an asterisk ( \* ) appears, enter a value in the range indicated in brackets under CONTROL CONTENTS.

## Rating table for Child Lock

Broadcasted rating User-adjusted rating	AGE														
	4	5	6	7	8	9	10	11	12	13	14	15	16	17	18
Universal	✓	—	—	—	—	—	—	—	—	—	—	—	—	—	—
Parental	✓	✓	✓	✓	✓	—	—	—	—	—	—	—	—	—	—
X-rated	✓	✓	✓	✓	✓	✓	✓	✓	✓	✓	✓	✓	✓	✓	✓

Broadcasted rating User-adjusted rating	Universal	Parental	X-rated
Universal	—	—	—
Parental	✓	—	—
X-rated	✓	✓	—

## Appendix

### Specifications

Item		37" LCD COLOUR TV, Model: LC-37AD5E, LC-37AD5S	42" LCD COLOUR TV, Model: LC-42AD5E, LC-42AD5S
LCD panel		37" Advanced Super View	42" WXGA PANEL
Number of dots		3,147,264 dots (1366 × 768 × 3 dots)	
Video Colour System		PAL/SECAM/NTSC 3.58/NTSC 4.43/PAL 60	
TV Function	TV-Standard	Analogue	CCIR (B/G, I, D/K, L, L')
		Digital	DVB-T (2K/8K OFDM)
	Receiving Channel	VHF/UHF	E2-E69ch, F2-F10ch, I21-I69ch, IR A-IR Jch, (Digital: E5-E69ch)
		CATV	Hyper-band, S1-S41ch
	TV-Tuning System	Auto Preset 99 ch, Auto Label, Auto Sort	
STEREO/BILINGUAL		NICAM/A2	
Brightness		470 cd/m <sup>2</sup>	500 cd/m <sup>2</sup>
Backlight life		60,000 hours (at Backlight Standard position)	
Viewing angles		H : 176° V : 176°	H : 178° V : 178°
Audio amplifier		10W × 2	
Speaker		(100 mm × 35 mm) × 2	(100 mm × 40 mm) × 4
Terminals	Antenna input	UHF/VHF 75Ω Din type (Analogue & Digital)	
	RS-232C	9 pin MINI-DIN male connector	
	EXT 1	SCART (AV input, Y/C input, RGB input, TV output)	
	EXT 2	SCART (AV input/output, Y/C input, RGB input, AV Link)	
	EXT 3	S-VIDEO (Y/C input), RCA pin (AV input)	
	EXT 4	Ø 3.5 mm jack (Audio input), 15 pin mini D-sub (PC/Component)	
	EXT 5	HDMI, Ø 3.5 mm jack (Audio input)	
	EXT 6	HDMI	
	C. I. (Common Interface)	EN50221, R206001	
	OUTPUT	RCA pin (Audio)	
	Headphones	Ø 3.5 mm jack (Audio output)	
OSD language		English/German/French/Italian/Spanish/Dutch/Swedish/Portuguese/Finnish/Turkish/Greek/Russian/Polish	
Power Requirement		AC 220-240 V, 50 Hz	
Power Consumption		156 W (0.9 W Standby) (Method IEC60107)	203 W (0.9 W Standby) (Method IEC60107)
Weight		19.1 kg (Display only), 21.2 kg (Display with stand)	25.4 kg (Display only), 28.0 kg (Display with stand)
Operating temperature		0°C to +40°C	

- As a part of policy of continuous improvement, SHARP reserves the right to make design and specification changes for product improvement without prior notice. The performance specification figures indicated are nominal values of production units. There may be some deviations from these values in individual units.

#### NOTE

- Refer to inside back cover for dimensional drawings.

### Optional accessories

The listed optional accessories are available for the LCD colour TV. Please purchase them at your nearest shop.

- Additional optional accessories may be available in near future. When purchasing, please read the newest catalogue for compatibility and check the availability.

No.	Part name	Part number
1	Wall mount bracket (LC-37AD5E, LC-37AD5S, LC-42AD5E, LC-42AD5S)	AN-37AG2
2	9 pin D-sub/MINI-DIN conversion cable	AN-A1RS

## A. Information on Disposal for Users (private households)

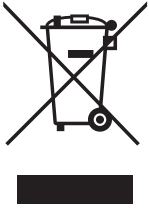

Attention: Your product is marked with this symbol. It means that used electrical and electronic products should not be mixed with general household waste. There is a separate collection system for these products.

### 1. In the European Union

Attention: If you want to dispose of this equipment, please do not use the ordinary dust bin!

Used electrical and electronic equipment must be treated separately and in accordance with legislation that requires proper treatment, recovery and recycling of used electrical and electronic equipment. Following the implementation by member states, private households within the EU states may return their used electrical and electronic equipment to designated collection facilities free of charge\*. In some countries\* your local retailer may also take back your old product free of charge if you purchase a similar new one.  
\*) Please contact your local authority for further details.

If your used electrical or electronic equipment has batteries or accumulators, please dispose of these separately beforehand according to local requirements.

By disposing of this product correctly you will help ensure that the waste undergoes the necessary treatment, recovery and recycling and thus prevent potential negative effects on the environment and human health which could otherwise arise due to inappropriate waste handling.

### 2. In other Countries outside the EU

If you wish to discard this product, please contact your local authorities and ask for the correct method of disposal.

For Switzerland: Used electrical or electronic equipment can be returned free of charge to the dealer, even if you don't purchase a new product. Further collection facilities are listed on the homepage of [www.swico.ch](http://www.swico.ch) or [www.sens.ch](http://www.sens.ch).

## B. Information on Disposal for Business Users

### 1. In the European Union

If the product is used for business purposes and you want to discard it:

Please contact your SHARP dealer who will inform you about the take-back of the product. You might be charged for the costs arising from take-back and recycling. Small products (and small amounts) might be taken back by your local collection facilities.

For Spain: Please contact the established collection system or your local authority for take-back of your used products.

### 2. In other Countries outside the EU

If you wish to discard of this product, please contact your local authorities and ask for the correct method of disposal.

**LC-37AD5E / LC-37AD5S / LC-42AD5E / LC-42AD5S**

( ) : LC-37AD5E  
LC-37AD5S

[ ] : LC-42AD5E  
LC-42AD5S

■ : LC-37AD5E  
LC-37AD5S  
LC-42AD5E  
LC-42AD5S

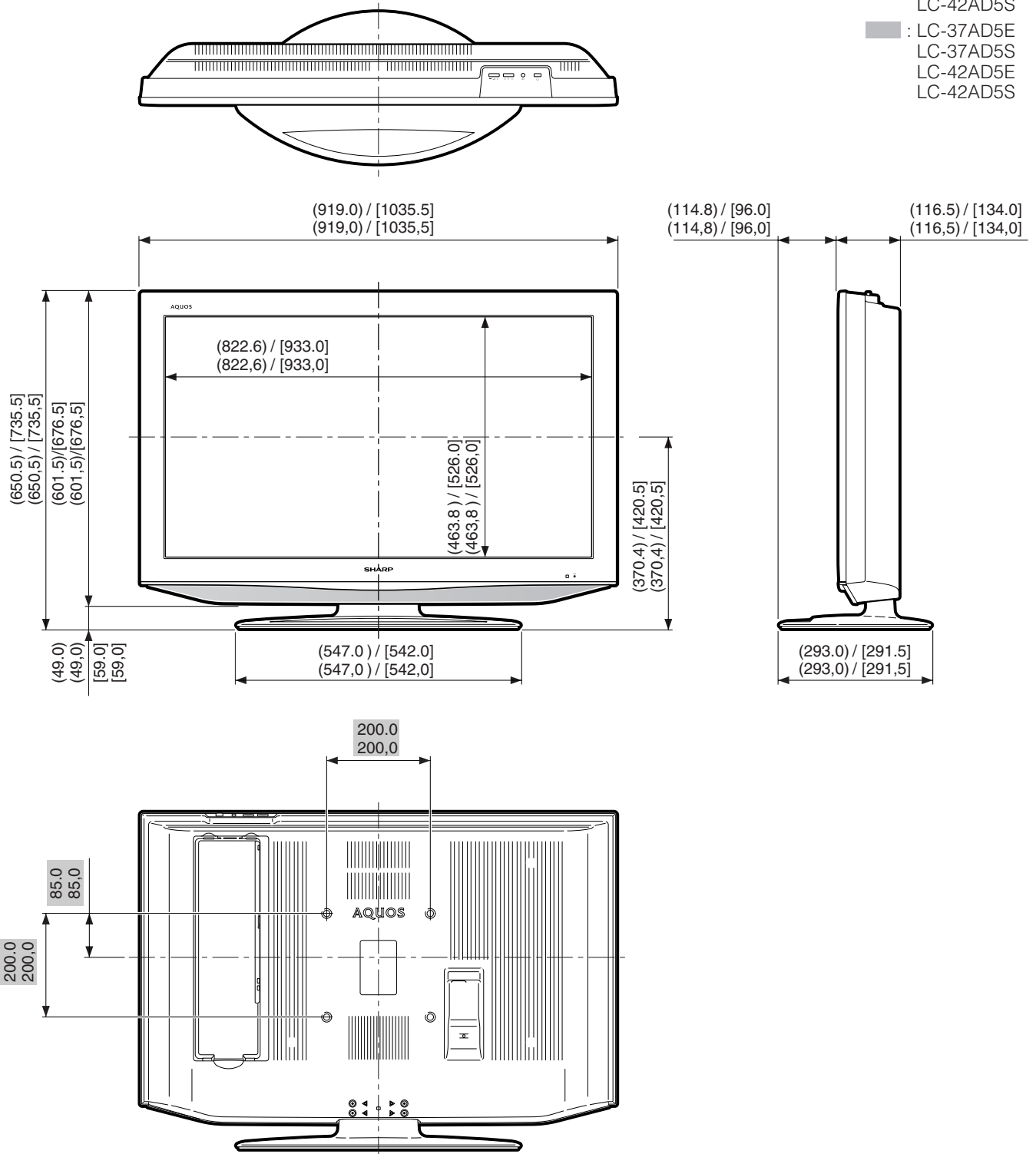

# SHARP®

## SHARP ELECTRÓNICA ESPAÑA S.A.

Polígono Industrial Can Sant Joan  
Calle Sena s/n  
08174 SANT CUGAT DEL VALLÉS  
BARCELONA (ESPAÑA)

## SHARP CORPORATION

Printed on environmentally friendly paper  
Auf ökologischem Papier gedruckt  
Imprimé sur papier écologique  
Stampato su carta ecologica  
Afgedrukt op ecologisch papier  
Impreso en papel ecológico



Printed in Spain  
Gedruckt in Spanien  
Imprimé en Espagne  
Stampato in Spagna  
Gedruckt in Spanje  
Impreso en España

**TINS-D141WJZZ**  
07P07-SP-NG

PIN

--	--	--	--



## Free Manuals Download Website

<http://myh66.com>

<http://usermanuals.us>

<http://www.somanuals.com>

<http://www.4manuals.cc>

<http://www.manual-lib.com>

<http://www.404manual.com>

<http://www.luxmanual.com>

<http://aubethermostatmanual.com>

Golf course search by state

<http://golfingnear.com>

Email search by domain

<http://emailbydomain.com>

Auto manuals search

<http://auto.somanuals.com>

TV manuals search

<http://tv.somanuals.com>