

SHARP

**PORTABLE MINIDISC
RECORDER**

MODEL

MD-MT888H

OPERATION MANUAL

If you require any advice or assistance regarding your Sharp product, please visit our web-site www.sharp.co.uk/support. Customers without Internet access may telephone 08705 274277 during office hours (or (01) 676 0648 if telephoning from Ireland).

MT888H_UK_F

1

Thank you for purchasing this SHARP product.
For the best performance, read this manual carefully.
It will guide you in operating your SHARP product.





MDLP

01.8.30, 1:57 PM

Accessories

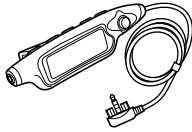
Important Introduction

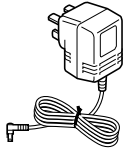
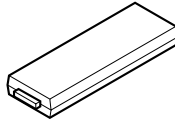
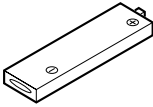
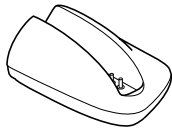
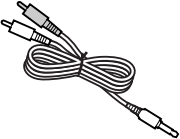
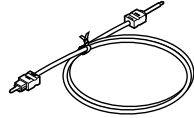
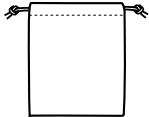
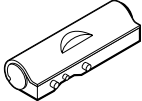
 <p>Remote control x 1</p>	 <p>Earphones x 1</p>	 <p>AC adaptor (RADPA8046AWZZ) x 1</p>	 <p>Battery carrying case x 1</p>	 <p>Rechargeable nickel-metal hydride battery (AD-N55BT) x 1</p>
 <p>Battery charger x 1</p>	 <p>Connection cable (for analogue re- cording) x 1</p>	 <p>Connection cable (for digital record- ing) x 1</p>	 <p>Carrying bag x 1</p>	 <p>Battery case x 1</p>

Notes:

- Parts and equipment mentioned in this operation manual other than those detailed above are not included.
- The AC adaptor may be different from the one in the drawing.

Contents

MD-MT888H

■ Important Introduction

	Page
Special Notes	4 - 5
Precautions	6
Names of Controls and Indicators	7 - 9

■ Preparation

Using with the Rechargeable Battery	10 - 11
Using with the AC Adaptor	12
Using with the Alkaline Battery	13
Inserting a MiniDisc	13
Connections	14 - 15

■ Basic Operation

Long Time Recording and Group Recording	16
Group Playback	17
Recording	18 - 21
Playback	22 - 24

■ Useful Features

Advanced Playback	25 - 27
Advanced Recording	28 - 33
Recording from a Microphone	34 - 37
Checking Displays	38 - 39

■ Advanced Features

	Page
Titling a MiniDisc	40 - 42
Editing a Recorded MiniDisc	43 - 50
Hold Function	51
Changing Default Settings	52 - 53
Listening through Another System	54

■ References

Other Features and Caution	55
Troubleshooting	56 - 57
MiniDisc System Limitations	58
Error Messages	59 - 61
Maintenance	61
Specifications	62 - 63

TERMS OF GUARANTEE Back cover

Special Notes

NOTES FOR USERS IN THE U.K. AND IRELAND

SERVICE INFORMATION

In the unlikely event of your equipment requiring repair, please contact the dealer or supplier from whom it was purchased. Where this is not possible, please visit our web-site www.sharp.co.uk/support. Customers without internet access may telephone 08705 274277 during office hours (or (01) 676 0648 if telephoning from Ireland).

Please note; all calls will be charged at local rate.

Certain replacement parts and accessories may be obtained from our main parts distributor.

WILLOW VALE ELECTRONICS LTD.
0121 766 5414

In the unlikely event of this equipment requiring repair during the guarantee period, you will need to provide proof of the date of purchase to the repairing company. Please keep your invoice or receipt, which is supplied at the time of purchase.

■ Warnings

- The supplied AC adaptor contains no user serviceable parts. Never remove covers unless qualified to do so. It contains dangerous voltages, always remove mains plug from the main outlet socket before any service operation or when not in use for a long period.
- The AC adaptor supplied with the MD-MT888H must not be used with other equipment.
- To prevent fire or shock hazard, do not expose this appliance to dripping or splashing liquids. No objects filled with liquids, such as vases, shall be placed on the apparatus.
- Never use an AC adaptor other than the one specified. Otherwise, problems or serious hazards may be created.

■ Caution

- When recording important selections, make a preliminary test to ensure that the desired material is properly recorded.
- SHARP is not liable for damage or loss of your recording arising from malfunction of this unit.

- At full volume, prolonged listening to a personal stereo may damage the user's hearing. This model complies with the law if used with the correct earphones (model number RPHOH0004AWZZ). If the earphones are damaged in any way, please order using the model number given above.
- This product is classified as a CLASS 1 LASER PRODUCT.
- Use the Portable MiniDisc Recorder only in accordance with the instructions given in this manual and do not attempt to interfere with the interlock switch or make any other adjustment as this may result in exposure to hazardous radiation.

Laser Diode Properties

- Material: GaAlAs
- Wavelength: 785 nm
- Pulse time:
Read mode: 0.8 mW Continuous
Write mode: max 10 mW 0.5S
min cycle 1.5S
Repetition

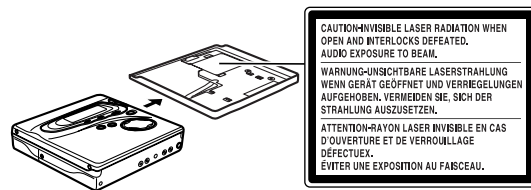

CAUTION-INVISIBLE LASER RADIATION WHEN
OPEN AND INTERLOCKS DEFEATED.
AUDIO EXPOSURE TO BEAM.

WARNUNG-UNSICHTBARE LASERSTRAHLUNG
WENN GERÄT GEÖFFNET UND VERRIEGELUNGEN
AUFGEHOBEN. VERMEIDEN SIE, SICH DER
STRAHLUNG AUSZUSETZEN.

ATTENTION-RAYON LASER INVISIBLE EN CAS
D'OUVERTURE ET DE VERROUILLAGE
DÉFECTUEUX.
ÉVITER UNE EXPOSITION AU FAISCEAU.

Notes

- Recording and playback of any material may require consent, which SHARP is unable to give. Please refer particularly to the provisions of the Copyright Act 1956, the Dramatic and Musical Performers Protection Act 1958, the Performers Protection Acts 1963 and 1972 and to any subsequent statutory enactments and orders.
- This equipment complies with the requirements of Directives 89/336/EEC and 73/23/EEC as amended by 93/68/EEC.
- US and foreign patents licensed from Dolby Laboratories.
- The letters in brackets contained in the model number indicate the colour of the product only. Operation and specifications are unaffected.

Precautions

■ Important

- Do not wear your earphones when you are crossing streets or near traffic.
- Do not use your earphones whilst driving a motor vehicle, it may create a traffic hazard and may be illegal. Remember to obey all of the safety rules in your area.



- Do not play the unit at a high volume. Hearing experts advise against extended listening at high volume levels.
- If you experience ringing in your ears, reduce the volume or discontinue use.
- No naked flame sources, such as lighted candles, should be placed on the apparatus.
- Attention should be drawn to the environmental aspects of battery disposal.
- The apparatus is designed for use in moderate climate.
- This portable MD should only be used within the range of 0°C - 40°C (32°F - 104°F).

To avoid accidental electric shock or other possible problems, observe the precautions listed below.

- Do not disassemble or modify the unit.
- Do not drop or subject the unit to shock.
- Do not use the unit near open flames.
- Do not spill liquid on the unit.
- Do not use an external power supply, other than the 2 V DC supplied with this unit as it may be damaged.

- SHARP is not responsible for damage due to improper use. Refer all servicing to a SHARP authorised service centre.

■ Storing the unit

Avoid using or leaving the unit in the following places.

- Places exposed to direct sunlight for many hours (especially in cars with the doors and windows closed) or near heaters. (The cabinet may deform, change colour or the unit may malfunction.)
- Places exposed to excessive dust.
- Places exposed to water.
- Places where temperatures are excessively high or low.
- Places (bathrooms) where the humidity is extremely high.
- Places with strong magnetic fields such as TVs or loudspeakers.
- Places exposed to vibration.
- Places where sand can easily enter the inside of the unit (beaches etc.).
- If the unit is used near radio tuners or TVs, noise and/or picture interference may result. If you experience these problems, move the unit away from such devices.
- It is not recommendable to put the MiniDisc into a rear pocket, as this may damage the product when sitting.



Names of Controls and Indicators

MD-MT888H

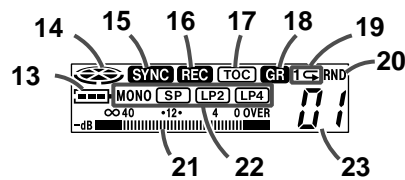
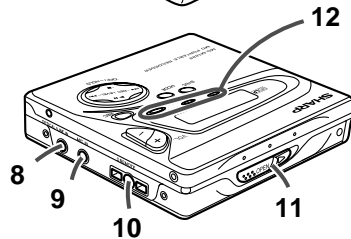
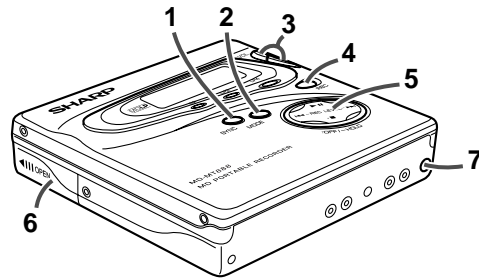

■ Main unit

Reference page

- 1. Synchronised Recording Button (28)
- 2. Mode Button (19, 26, 29)
- 3. Volume Buttons (24)
- 4. Record Button (19, 31)
- 5. Play/Pause/Stop/Power Off/Hold/Fast Forward/
Fast Reverse Button (19 - 21, 23 - 25, 40, 51)
- 6. Rechargeable Battery Cover (10)
- 7. 2 V DC Input Socket (12)
- 8. Optical/Line Input Socket (14, 15)
- 9. Microphone Input Socket (34)
- 10. Remote Control/Earphones/
Line Output Socket (18, 22)
- 11. Open Lever (13)
- 12. 3-Colour Indicators (23, 53)
- 13. Battery Indicator
- 14. Disc Mode Indicator
- 15. Synchro Recording Indicator
- 16. Record Indicator
- 17. TOC Indicator
- 18. Group Indicator
- 19. Repeat Indicator
- 20. Random Indicator
- 21. Level Meter
- 22. Recording Mode Indicators
- 23. Track Number Indicator

Important Introduction
-Names of Controls and Indicators-

Names of Controls and Indicators (continued)

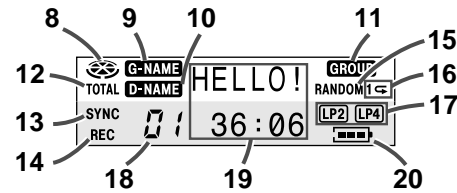
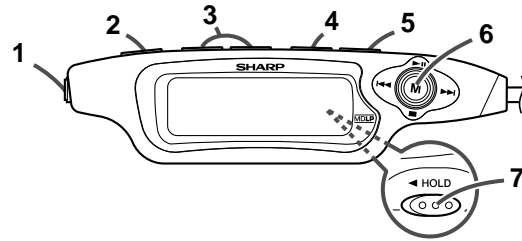

■ Remote control unit

Reference page

- | | |
|--|----------------------------|
| 1. Earphones Socket | (22) |
| 2. Record Button | (19, 31) |
| 3. Volume Buttons | (24) |
| 4. Mode/Display Button | (19, 26, 38) |
| 5. Group/Clear Button | (16, 21) |
| 6. Menu Button | (19 - 21, 23 - 25, 27, 40) |
| 7. Hold Switch | (51) |
| 8. Disc Mode Indicator | |
| 9. Group Name Indicator | |
| 10. Disc Name Indicator | |
| 11. Group Indicator | |
| 12. Total Track Number Indicator | |
| 13. Synchro Recording Indicator | |
| 14. Record Indicator | |
| 15. Random Indicator | |
| 16. Repeat Indicator | |
| 17. Recording Mode Indicators | |
| 18. Track Number Indicator | |
| 19. Character/Time Information Indicator | |
| 20. Battery Indicator | |

Menu button operation

Various operations are performed by moving the M button on the remote control all around or pressing it.

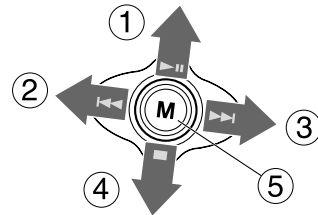

- ① **If you move the M button toward ►||...**
Playback, pause, selecting a character
- ② **If you move the M button toward ◀◀...**
Fast reverse, selecting a track, menu, and setting item, moving cursor, adjusting recording level, selecting a character
- ③ **If you move the M button toward ►►...**
Fast forward, selecting a track, menu, and setting item, moving cursor, adjusting recording level, selecting a character
- ④ **If you move the M button toward ■...**
Stop, power off
- ⑤ **If you press the M button...**
Displaying a menu, determining a menu, setting item, and character

Menu display

When the unit enters the menu mode, the initial letter of each menu will be displayed in the first line and the contents of the selected menu in the second line.

The initial letter of the selected menu will flash.

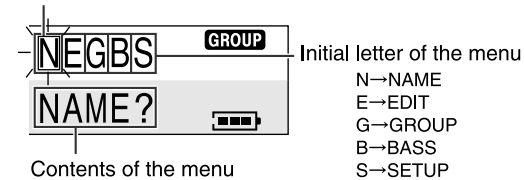

Note:

Display of the initial letter of the menu depends on the used conditions.

(Whilst stopped, playback, paused, digital-recording, analogue-recording, microphone recording, or when a group-recorded MD or non-group MD is loaded)

Using with the Rechargeable Battery

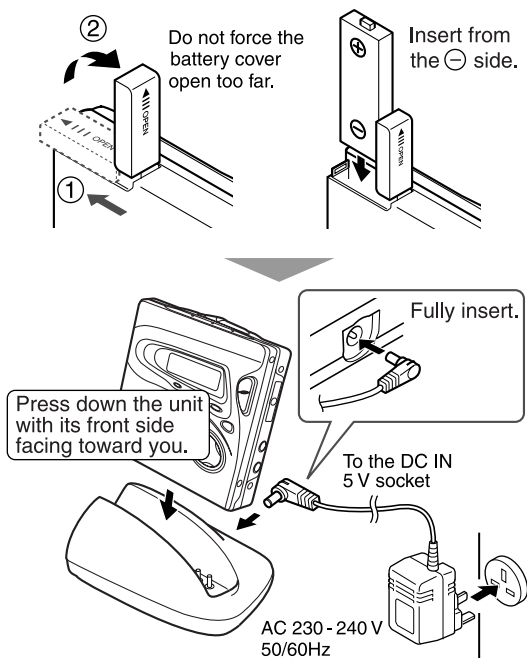

■ Charging

When the rechargeable battery is used for the first time or when you want to use it after a long period of disuse, be sure to charge it fully.

- 1 Insert the rechargeable battery.
- 2 Connect the AC adaptor.
- 3 Place the unit on the battery charger.



- When the portable MD is turned on or operating, the battery will not be charged.
- No operation can be performed whilst charging. If you try to operate, "CH" will appear.
- After the rechargeable battery is charged or used, it will get slightly warm. This is normal.

Caution:

- Use the specified battery AD-N55BT only. Do not charge a battery (nickel-cadmium, alkaline, etc.) other than that specified.
- Do not remove the outer cover of the rechargeable battery. It may cause heat generation, fire, or explosion.
- Do not dip the battery in water, do not dispose of it in a fire, and do not take it apart. 
- If the rechargeable battery terminal is dirty, charging may not start. In such a case, wipe off the dirt with a dry cloth.
- Do not disassemble the battery.

■ Display of remaining amount of battery

When the unit is set on the charger, the remaining amount of battery is displayed.

Display	Conditions
 Scroll	Charging.
 Turned off	Charging completed. When the unit is not set correctly on the charger, the rechargeable terminal is dirty, or foreign material adheres to it, charging may not be possible. (Wipe the terminal with dry cotton swab.)
 Flashing	Refreshing. The unit reads the memory effect of the rechargeable battery and discharge the battery if necessary. After refreshing, it starts charging automatically.

■ Charging time

Charging is completed in about 3 hours, and the display of remaining amount of battery will go out.

90 % of charging is completed. If you leave it for another 2 hours, the battery will be fully charged.

- Charge the battery within the range of 5°C - 35°C (41°F - 95°F).
- The unit can be left in the charging state after it is completed.

Refresh

If you charge the battery before it runs out completely, the operating time may be shortened. To avoid this, the battery is discharged automatically and refreshed.

Preparation
-Using with the Rechargeable Battery-

Using with the AC Adaptor

Preparation
-Using with the AC Adaptor-

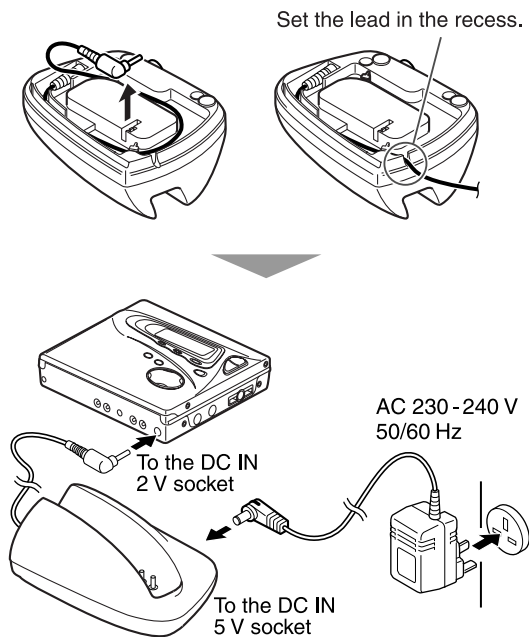

- 1** Take out the lead from the charger.
- 2** Connect the lead to the main unit (at DC IN 2 V socket).
- 3** Connect the AC adaptor.

Caution:

- If the AC adaptor is not used for a long period of time, be sure to remove the plug from the socket for safety.
- Insert each plug fully.

Note:

When the power failure occurs whilst playing back music using the AC adaptor, unplug the unit. If it is left plugged in, playback may start automatically after the power is restored.

Using with the Alkaline Battery

MD-MT888H

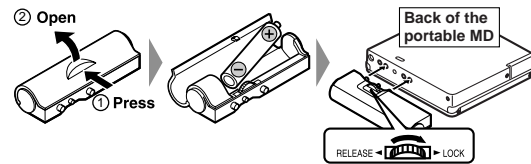

Use one commercially available alkaline battery (LR6, AA size).

When using the alkaline battery, be sure to insert the rechargeable battery also.

- 1 Open the battery case cover.**
- 2 Insert an alkaline battery into the battery case.**
- 3 Attach the battery case to the unit.**

Caution:

Do not put a rechargeable battery (nickel-cadmium battery, etc.) in the battery case.

Inserting a MiniDisc

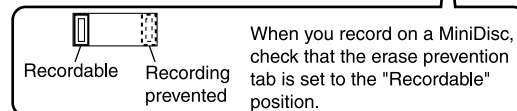
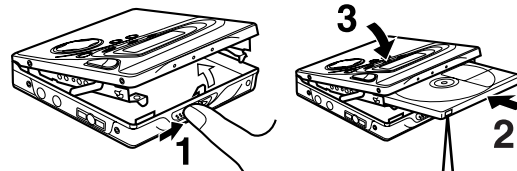

- 1 Slide the OPEN lever to release the compartment door.**
- 2 Insert a MiniDisc as shown.**
- 3 Close the compartment door.**

Notes:

- Do not place the MiniDisc under the holder.
- If any resistance is felt, do not force the MiniDisc into the unit, as it may cause damage to the unit. If resistance is felt, remove the MiniDisc and reload it.
- The lid cannot be opened if "TOC" is displayed; refer to the instruction on page 21.

Connections

You can record your favourite CDs or tapes to MD.

■ To connect to a stereo system with "LINE OUT" or "AUDIO OUT" sockets

LINE OUT	To a stereo system with "LINE OUT" or "AUDIO OUT" sockets.
RIGHT	Note: If the audio system has only one pair of sockets, they are usually for input only and recording via this connection is not possible.
LEFT	

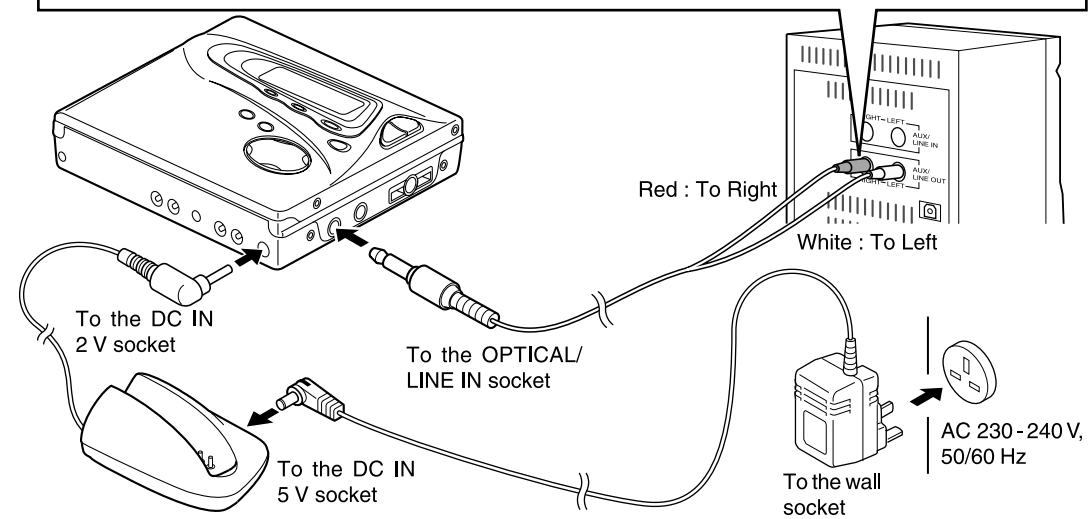

■ To connect to a stereo system with a "DIGITAL OUT" or "OPTICAL OUT" socket

Notes:

- Some audio systems do not have a DIGITAL OUT socket. Check before connecting.
- When recording, it is recommended to use the AC adaptor and also install the battery. Should the power failure occur, the power source would be automatically switched to the battery.

DIGITAL OUT



To a stereo system with a "DIGITAL OUT" socket.
Compared to analogue connection recording, it allows high-quality recording.

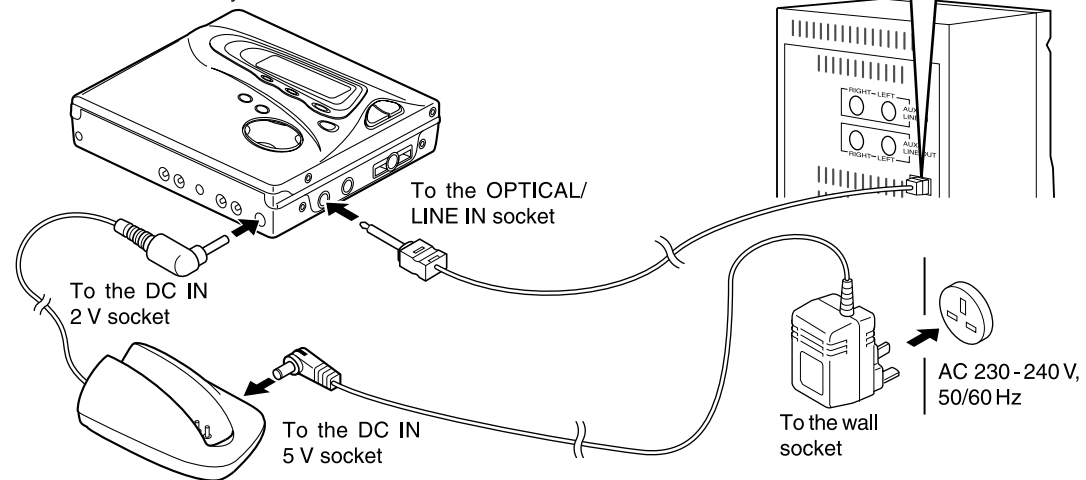

Long Time Recording and Group Recording

■ Long time recording

Since this MD portable recorder adopts the 4 times long recording mode, you can record many tracks on one MD (supporting MDLP).

Up to 320 minutes of recording is possible on one MD (of 80 minutes).

■ Group recording

You can record tracks by the group of artists or albums, etc. That MD can be played by selecting the group.

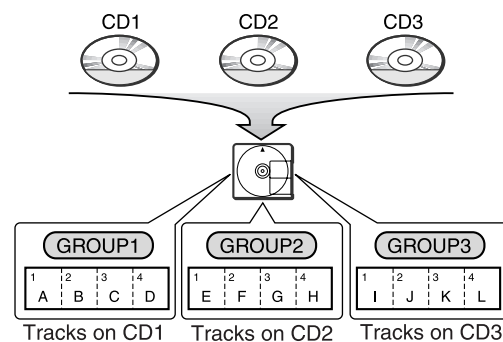

When the group mode is selected for recording, tracks are played by the group, starting with the first track of the group.

Group1				Group2				Group3			
1	2	3	4	1	2	3	4	1	2	3	4
A	B	C	D	E	F	G	H	I	J	K	L

When the group mode is cancelled, tracks will be numbered sequentially from the beginning.

Disc name											
1	2	3	4	5	6	7	8	9	10	11	12
A	B	C	D	E	F	G	H	I	J	K	L

Setting the group mode

1. Hold down the REC button on the remote control for 2 seconds or more. Recording is paused.
2. Hold down the GROUP button on the remote control for 1 second or more so that "GROUP" lights up.

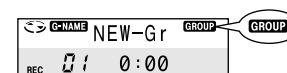

To cancel the group mode

Hold down the GROUP button on the remote control for 1 second or more so that "GROUP" goes out.

Caution:

The group-recorded MD may not be properly recorded or edited with other equipment.

Group Playback

MD-MT888H

Using a group-recorded MD, you can play back tracks by the desired group (albums, artists, etc.).

■ Playback of group-recorded MD

Example of group recording:

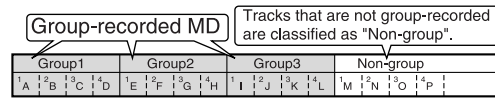

Depending on the selection of the group mode, playback of a group-recorded MD changes as follows.

When the group mode is selected

("GROUP" lights up)

Tracks are played by the group, starting with the first track of the group.

You can select a group to play back.

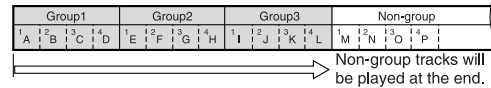

When the group mode is cancelled

("GROUP" goes out)

Tracks are numbered in the order they are recorded.

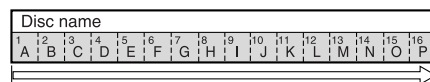

Setting the group mode
Inserting a group-recorded MD automatically sets the unit to the group mode.
 (The first group is displayed.)

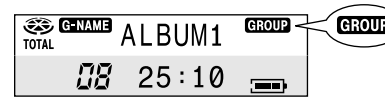

If you eject the MD, the group mode is cancelled.

To cancel the group mode

Whilst in the stop mode, hold down the GROUP button for 1 second or more so that "GROUP" goes out.

Note:

If a group-recorded MD is played back with the equipment that does not support the group function, the disc name will not be displayed correctly and the group name will not be displayed at all. (Example) 0;BEST//1- 10;...

Recording

Basic Operation
-Recording-

REC MODE GROUP M

MODE REC

REC MODE

OFF/HOLD

HOLD
Release

To the REMOTE socket

Plug in the remote control unit completely.

Before recording
Cancel the hold mode.
The portable MD does not work whilst in hold mode.

Main unit Remote control unit

OFF/HOLD HOLD
Release

As for the details, see page 51.

1 Plug the remote control into the REMOTE socket on the unit.

2 Hold down the REC button for 2 seconds or more.

You can perform the same operation by simply pressing the REC button on the main unit.

3 To perform group recording, hold down the GROUP button for 1 second or more so that "GROUP" is lit.

NEW-Gr **GROUP**

- The unit is ready to record a new group. (To select a group, refer to page 21.)
- When group recording is not performed, hold down the GROUP button for 1 second or more so that "GROUP" goes out.
- Setting for the group recording will not be changed until a new setting is entered.

4 Begin playback on the stereo system connected to this portable MD.

5 Move the M button toward \lll or \ggg to adjust the recording level (page 20).

You can perform the same operation by holding down the \lll or \ggg button on the main unit.

6 Press the PAUSE button on the stereo system to enter the playback pause mode.

Here you can search for the track to record.

7 Press the MODE button repeatedly to select the recording mode (page 30).

SP	(Stereo recording)
LP2	(2 times long recording)
LP4	(4 times long recording)
MONO	(Monaural recording)

You can perform the same operation by pressing the MODE button on the main unit.

8 Move the M button toward \ggg .

You can perform the same operation by pressing the \ggg button on the main unit.

9 Begin playback on the stereo system, the output will be recorded.

Notes:

- Changing the volume level whilst recording does not affect the recording.
- You cannot adjust the bass level whilst recording.
- After the group recording is performed, non-group tracks will be moved behind the groups and track numbers will be changed.

Recording (continued)

To interrupt recording

Move the M button toward **▶||**.

- Recording starts by moving the M button toward **▶||** again.
- You can perform the same operation by pressing the **▶||** button on the main unit.
- The track number will be increased by one each time the recording is interrupted.

To stop recording

Move the M button toward **■**.

- You can perform the same operation by pressing the **■** button on the main unit.
- When recording stops, "TOC" appears. Whilst "TOC" appears, the MiniDisc recorded contents have not yet been updated.
- To prevent the new recording from being lost, it is not possible to remove the MiniDisc whilst "TOC" is displayed.

To update the recorded contents of the MiniDisc

Whilst in the stop mode, move the M button toward **■**. You can perform the same operation by pressing the **■** button on the main unit.

- The power turns off after recorded contents have been updated on the MiniDisc.

■ Recording level

<Analogue recording>

Adjust the recording level so that the maximum sound volume from the source makes the reading swing somewhere between -4 dB and 0 dB.

You can check the level on the LCD of the main unit.

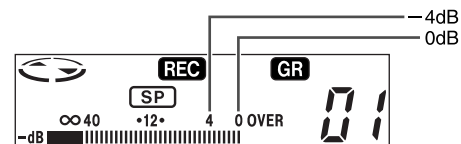

<Digital recording>

You can adjust the level in 1dB increments within the range of +12 - -12dB.

You can check the level on the LCD of the remote control.



Once you adjust the digital recording level, the setting is retained even after the recording stops. (For cancellation instructions, see page 52.)

■ Adding tracks to an existing group

- 1 Hold down the REC button for 2 seconds or more.
- 2 Hold down the GROUP button for 1 second or more to display "GROUP".
- 3 Press the M button.

The unit enters the menu select mode.

- 4 Move the M button toward **◀◀** or **▶▶** to select "G(GrSE-LECT)" and press it.



- 5 Move the M button toward **◀◀** or **▶▶** to select the group you want to add tracks to and press it.

NEWGr

To create a new group.

Gr01, Gr02, Gr03...

To add tracks to an existing group. (If the group name has been recorded, the name will be displayed instead of "Gr01".)

NonGr

To record tracks as non-group.

6 Start recording.

- Complete the operation within 25 seconds whilst selecting the menus.
- If you press the CLEAR button during the operation, the previous display appears.
- To cancel the operation, move the M button toward **■**.

About the TOC

After any recording or editing function, "TOC" (Table Of Contents) is displayed. To finalise the recording or editing function, turn the power off. During this process "TOC" will flash and "T-EDIT" will be displayed. During any recording or editing function, the MiniDisc unit lid is locked, and the MiniDisc cannot be removed until the process is finalised.

Warning:

If the power is removed (Battery/AC adaptor) whilst "TOC" is displayed, the MiniDisc unit lid will remain locked until the battery/main power is restored and the unit is turned on. Your new recordings or edited changes will be lost and your MiniDisc may become unusable.

Caution:

Whilst "TOC" or "T-EDIT" is displayed, follow the instructions below.

- Do not jerk or bump the unit.
- Do not unplug the AC adaptor.
- Do not remove the rechargeable battery or an alkaline battery.
- Do not subject the unit to shock.

Otherwise, tracks may not be recorded properly.

Playback

Basic Operation
-Playback-

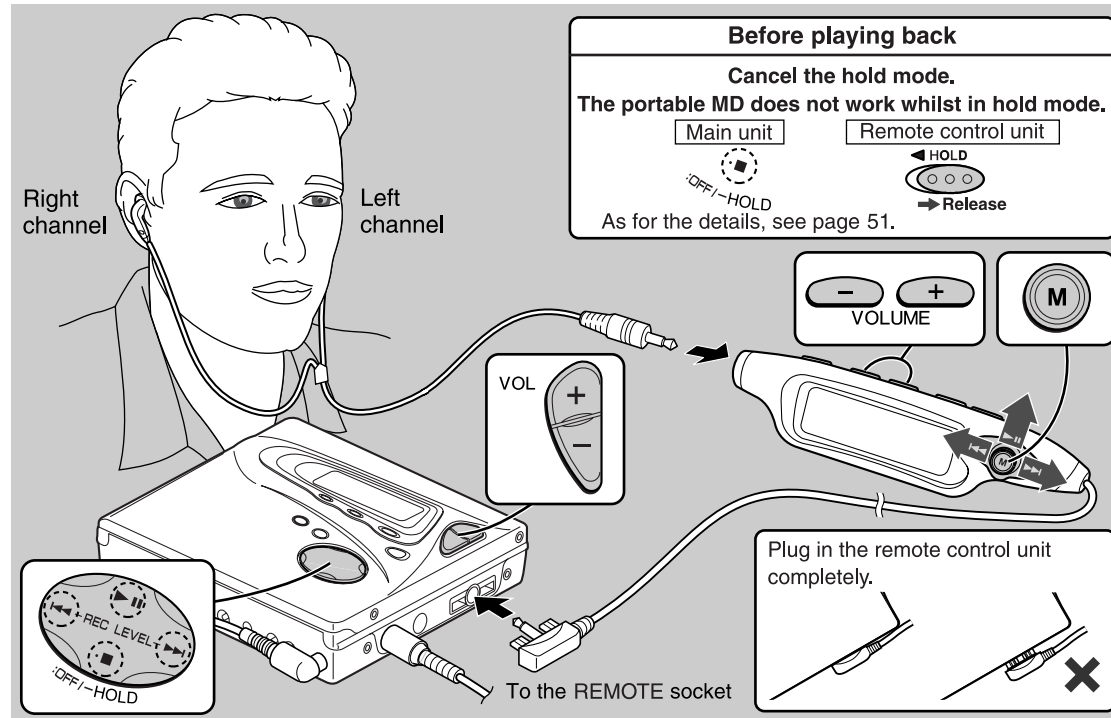

1 Plug the remote control and earphones into the unit.

2 Insert a MiniDisc (page 13).

Inserting a group-recorded MD automatically sets the unit to the group mode.

3 Start playback by moving the M button toward ►||.

- Playback starts automatically with a playback only MiniDisc or a MiniDisc which is protected against accidental erasure (Auto-play function).
- You can perform the same operation by pressing the ►|| button on the main unit.

Notes:

- If power failure occurs whilst playing a disc using the AC adaptor, disconnect it from the wall socket. Otherwise, playback may start automatically when electricity resumes.
- If you connect the AC adaptor without installing the rechargeable battery, playback may start automatically. Be sure to turn off the power.

To interrupt playback

During playback, move the M button toward ►||.

- You can perform the same operation by pressing the ►|| button on the main unit.
- Playback starts by moving the M button toward ►|| again.

To stop playback

During playback, move the M button toward ■.

- You can perform the same operation by pressing the ■ button on the main unit.
- If the unit is not operated for at least 2 minutes whilst in the stop mode, the power will shut off automatically.

To turn off the power

Whilst in the stop mode, move the M button toward ■.

- You can perform the same operation by pressing the ■ button on the main unit.

■ 3-colour indicators

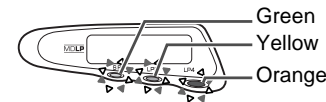

Green light flashing

Stereo playback or monaural playback

Yellow light flashes twice

2 times long playback (stereo)

Orange light flashes four times

4 times long playback (stereo)

Light flashes in order from green

Fast forward

Light flashes in order from orange

Fast reverse

Playback (continued)

■ Volume control

Press the VOLUME+ button to increase the volume and the VOLUME- button to decrease the volume.

■ Bass control

1 Press the M button.

2 Move the M button toward

◀◀ or ▶▶ to select "B(BASS)" and press it.

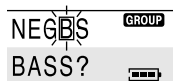

3 Move the M button toward ◀◀ or ▶▶ to select the bass strength and press it.

O(OFF)	Cancelled.
1(BASS1)	Emphasised slightly.
2(BASS2)	Emphasised more.
3(BASS3)	Emphasised fully.

- Complete the operation within 25 seconds whilst selecting the menus.
- If you press the CLEAR button during the operation, the previous display appears.
- To cancel the operation, move the M button toward ■.

Notes:

- Reduce the volume before starting to play. MiniDiscs, compared to ordinary cassette tapes, have very little noise. If the volume is adjusted according to your usual expectations of noise, high volume may damage your hearing.
- The sound escaping from your earphones may annoy people around you. In particularly crowded places (such as on trains or buses), reduce the volume.

■ To search a desired group

1 Press the GROUP button so that the "GROUP" flashes.

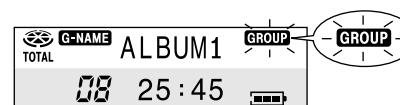

In the group mode, track numbers in the group are displayed.

2 Within 5 seconds, move the M button toward ◀◀ or ▶▶ to select the desired group.

To start playback whilst in the stop mode, move the M button toward ▶▶.

Advanced Playback

MD-MT888H

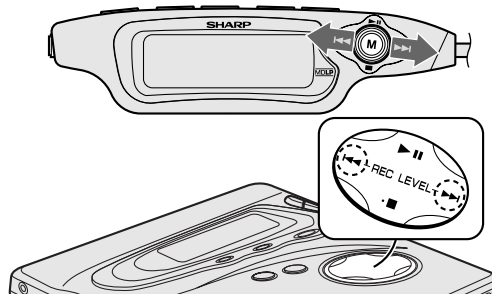

■ To locate the desired portion

For audible fast forward:

During playback, keep moving the M button toward ►►.

For audible fast reverse:

During playback, keep moving the M button toward ◀◀.

- Normal playback will resume when the M button is released.
- When the end of the last track is reached during fast forward, the unit will enter the pause mode. When the beginning of the first track is reached during fast reverse, the unit will enter the playback mode.
- You can perform the same operation by holding down the ◀◀ or ►► button on the main unit.

■ To locate the beginning of a track

To move to the beginning of the next track:

During playback, move the M button toward ►► once.

To restart the track being played:

During playback, move the M button toward ◀◀ once.

To locate the next track:

In the stop mode, move the M button toward ►► once.

To locate the previous track:

In the stop mode, move the M button toward ◀◀ once.

- To skip a number of tracks at one time, move the M button toward ◀◀ or ►► repeatedly until the desired track number is shown.
- When you move the M button toward ►►, playback starts from the beginning of the track.
- You can perform the same operation by pressing the ◀◀ or ►► button on the main unit.

Advanced Playback (continued)

■ Random play or repeat play

During playback, press the **MODE** button repeatedly to select the playback mode.

Notes:

- If the playback mode is selected whilst stopped, move the M button toward ►|| to start playback.
- When "TOC" is displayed, random play or repeat play is impossible.
- During random play, the unit cannot find the beginning of any track which has been played.
- Repeat play lasts until you stop the unit.
- In random play the unit will select and play tracks automatically. (You cannot select the order of the tracks.) After all of the tracks have been played once in random order, the unit will stop automatically.
- During random, random repeat, or single track repeat play, you can forward or reverse the MiniDisc only within the track being played.

Display on the remote control	When the group mode is selected ("GROUP" lights up)	When the group mode is cancelled ("GROUP" goes out)
RANDOM (Random playback)	Tracks are played back at random within a group and playback stops automatically after all tracks are ended.	After all tracks are played back at random, playback stops automatically.
RANDOM \square (Random repeat playback)	Tracks are played back at random within a group and groups are played repeatedly in order.	All tracks are played back at random repeatedly.
\square (All tracks repeat playback)	All tracks are played back repeatedly in order.	All tracks are played back repeatedly in order.
1 \square (1 group repeat playback/1 track repeat playback)	The selected group is played back repeatedly.	The selected track is played back repeatedly.
No display	Normal group playback	Normal playback

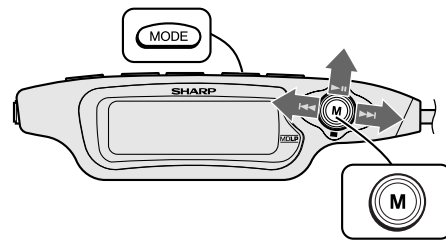

■ Intro play

You can listen to the beginning of each track for 5 seconds in the recorded order.

Whilst the playback is stopped or paused,

Keep moving the M button toward ►II for 2 seconds or more.

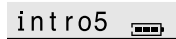

- Intro play cannot be performed whilst the random, random repeat, or one-track repeat mode is selected. In this case, normal playback starts.
- If any operation is performed whilst in the pause mode, intro play starts from the next track.
- The same operation can be performed by pressing the ►II button on the main unit for 2 seconds or more.

To return to normal playback

Move the M button toward ►II.

■ To play at double speed

A MiniDisc recorded in the monaural mode can be played back at double speed audibly. (Monaural recording, page 29)

1 During playback, press the M button.

The unit enters the menu select mode.

2 Move the M button toward

◀◀ or ▶▶ to select "F(FAST)" and press it.

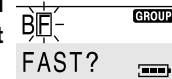

3 Move the M button toward ◀◀ or ▶▶ to select "F(FAST)" and press it.

- If a track recorded in the stereo mode is reached during the double-speed playback, it will be cancelled.
- Depending on the recorded materials, it may be difficult to hear them.

- Complete the operation within 25 seconds whilst selecting the menus.

- If you press the CLEAR button during the operation, the previous display appears.

- To cancel the operation, move the M button toward ■.

To interrupt fast playback

During playback, move the M button toward ►II.

- If you move the M button toward ►II again, the double-speed playback starts.

To return to normal playback

Select "N(NORMAL)" in step 3 and press the M button.

Advanced Recording

■ Playback sound-actuated recording

Recording automatically starts or pauses by detecting sound from the stereo system (Synchronised recording).

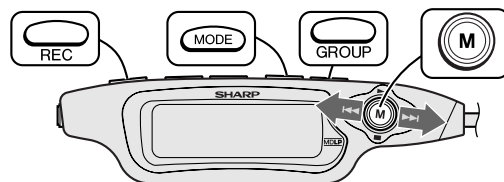

1 Hold down the REC button for 2 seconds or more.

You can perform the same operation by simply pressing the REC button on the main unit.

2 To perform group recording, hold down the GROUP button for 1 second or more so that "GROUP" is lit.

When group recording is not performed, hold down the GROUP button for 1 second or more so that "GROUP" goes out.

3 Begin playback on the stereo system connected to this portable MD.

4 Move the M button toward ◀◀ or ▶▶ to adjust the recording level (page 20).

You can perform the same operation by pressing the ◀◀ or ▶▶ button on the main unit.

5 Press the PAUSE button on the stereo system to enter the playback pause mode.

Select the starting point for your recording and press the PAUSE button.

6 Press the MODE button repeatedly to select the recording mode (page 29).

7 Press the M button.

- The unit enters the menu select mode.
- You can perform the same operation by pressing the SYNC button on the main unit. (At this time, steps 8-9 can be omitted.)

8 Move the M button toward ◀◀ or ▶▶ to select "S(SYNC)" and press it.

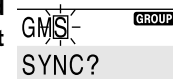

9 Press the M button.

Synchro recording will be paused.

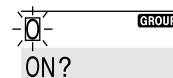

10 Begin playback on the stereo system. Recording will begin automatically.

To interrupt recording

- When the stereo system is stopped, the unit will enter the synchro recording pause mode. When playback is resumed, the recording will be resumed.
- If a silence lasts for 3 seconds or more, the recording will be paused (pause function does not work for approximately 10 seconds after a recording starts). When the unit receives sound again, recording automatically starts.
- A new track number is created when the recording resumes.

■ Long-play recording**2 times and 4 times long recording**

Double or quadruple time of stereo recording is possible.

Monaural recording

In monaural, you can record twice as long as the stereo recording.

A track recorded in monaural can be played back in double speed, see page 27.

1 When a recording is paused, press the MODE button repeatedly to select the recording mode.

Each time the button is pressed, the display will change as follows.

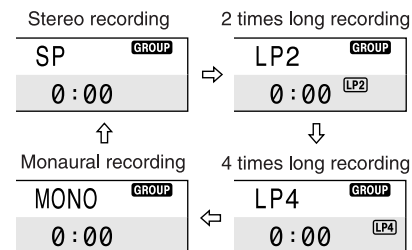
**2 Start recording.**

The recording mode remains unchanged until a new mode is selected.

Advanced Recording (continued)

Notes:

- Tracks can be recorded in stereo recording mode, 2 times long recording mode, and 4 times long recording mode on one MiniDisc.
- In monaural recording, the sound on the right and left channels is mixed even if the input source is in stereo. Although you can hear the stereo sound from the ear-phones, the recorded sound is monaural.
- Tracks recorded in 2 times long recording and 4 times long recording modes cannot be played with the unit that does not support these modes. On such a unit, no sound is heard. (The operation and the display may vary depending on the unit.)
- Tracks recorded in monaural cannot be played if equipment does not support the monaural playback.

■ About ATRAC

The ATRAC (Adaptive TRansform Acoustic Coding) system compresses the sound data into 1/5 by cutting out the inaudible sound. Since the sound is selected based on psychoacoustics masking, the sound quality is not impaired. This unit is equipped with the ATRAC3 compressing system that can reduce the sound data to 1/10 or 1/20 of its original size. By employing this system, 2 times and 4 times long recordings are enabled in stereo mode.

■ About the recording mode

You can select the recording mode from stereo recording, 2 times long recording, 4 times long recording, and monaural recording. Recordable time varies depending on the recording mode. If the tracks are recorded on an 80-minute MiniDisc, its recording time changes as follows:

Indication	Recording mode	Recording time
SP	Stereo	MAX. 80 min.
LP2	2 times long (stereo)	MAX. 160 min.
LP4	4 times long (stereo)	MAX. 320 min.
MONO	Monaural	MAX. 160 min.

■ Caution for 4 times long recording (LP4)

Special compressing method allows the 4 times long recording to realise long-time stereo recording. Therefore, some noise is recorded occasionally. If sound quality should be emphasised, stereo recording or 2 times long recording is recommended.

■ To create your own track numbers

You can create your own track numbers at any point.

Whilst recording, press the REC button at the point where you want to create track numbers.

The track number will be increased by one.

- One track number will be added every time the REC button is pressed.

Numbering restriction

If you try to number more than 10 tracks in certain amount of time, "Sorry" will be displayed and the operation will be disabled.

In that case, wait until the next operation can be resumed.

In stereo recording	Within 40 seconds
In 2 times long recording	Within 80 seconds
In 4 times long recording	Within 160 seconds
In monaural recording	Within 80 seconds

■ Recording tracks as a single track

You can record several pieces of music as a single track by disabling the auto marker function.

1 Whilst the recording or recording is paused, press the M button.

The unit enters the menu select mode.

2 Move the M button toward or to select "M(MARK)" and press it.



3 Move the M button toward or to select "A(AU-TO)" and press it.

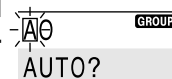

- Complete the operation within 25 seconds whilst selecting the menus.
- If you press the CLEAR button during the operation, the previous display appears.
- To cancel the operation, move the M button toward ■.

Note:

When making digital recordings using a CD player or a MiniDisc player, track numbers will be created automatically regardless of the setting of the auto marker function.

Advanced Recording (continued)

■ About track numbers

- Track numbers are created automatically during recording via the analogue connection when a silence of 1 second or more is detected (Auto marker function). A series of tracks can be recorded as one by disabling the auto marker function, see page 31.

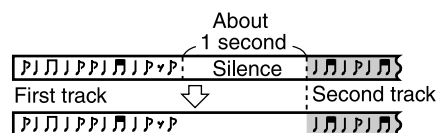

- When recording from a CD or a MiniDisc using the digital connection, track numbers will be created at the same points as on the CD or MiniDisc (Synchronizer marker function).

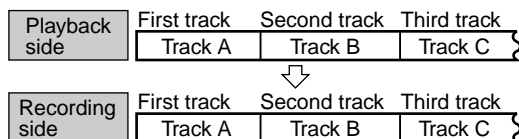

- Track numbers may not be created in proper places, depending on the source to be recorded from, such as signals with noise.
- The track numbers on the playback side may not match the track numbers recorded on the MiniDisc.
- When recording, if a programmed playback is performed by the source or playback is performed by selecting tracks manually, the MiniDisc track numbers may not be the same as on the source.
- Track numbers may not be created properly, depending on the connected stereo system.

■ To prevent recorded MiniDiscs from being erased accidentally

Slide the accidental erase prevention tab, located on the side of the MiniDisc, in the direction indicated by the arrow.

The MiniDisc will then be protected against accidental erasure.

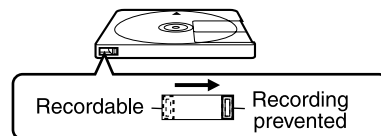

To add a recording to such a MiniDisc, slide the accidental erase prevention tab back to its original position.

■ Helpful tip when attaching a label

When attaching a label to an MiniDisc cartridge, be sure to note the following. If the label is not attached properly, the MiniDisc may jam inside the unit and you may not be able to remove it.

- If the label peels off or partially lifts away, replace it with a new one.
- Do not put a new label on top of an existing one.
- Attach the label only in the specified location.

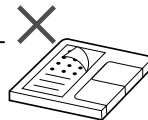

■ About sampling rate converter

This portable MD incorporates a sampling rate converter meaning it can record from digital radios or DAT tape recorders.

■ Note for digital recording

You cannot copy a MiniDisc that you recorded from digital inputs to another MiniDisc or DAT. It is prevented by the SCMS (Serial Copy Management System). Recording from analogue inputs is not affected.

Digital signals Digitally recorded MiniDisc Cannot record

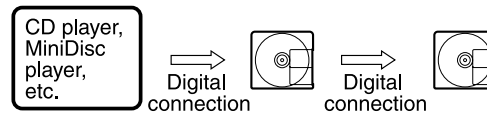

Recording from a Microphone

■ To record from a microphone

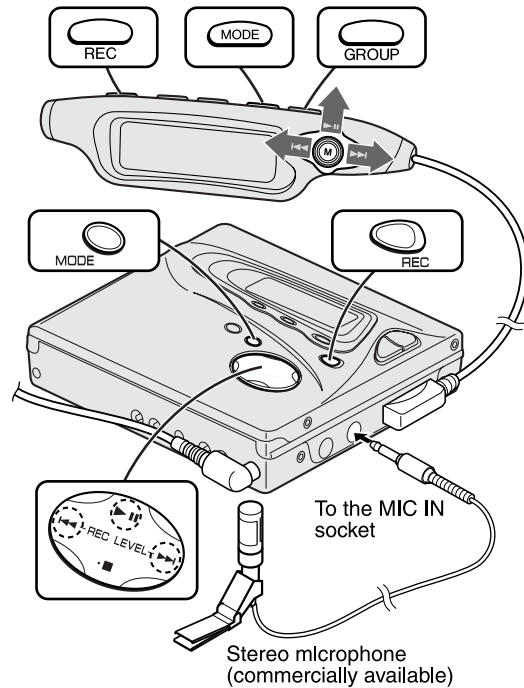

1 Connect a stereo microphone to the MIC IN socket.

2 Insert a recordable MiniDisc (page 13).

3 Hold down the REC button for 2 seconds or more.

You can perform the same operation by simply pressing the REC button on the main unit.

4 To perform group recording, hold down the GROUP button for 1 second or more so that "GROUP" is lit.

When group recording is not performed, hold down the GROUP button for 1 second or more so that "GROUP" goes out.

5 Move the M button toward ◀◀ or ▶▶ to adjust the recording level.

The same operation can be performed by pressing the ◀◀ or ▶▶ button on the main unit.

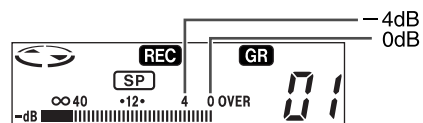

Level meter indicator

Adjust the recording level so that the maximum sound volume from the source makes the reading swing between -4 dB and 0 dB.

6 Press the MODE button repeatedly to select the recording mode (page 29).

7 Move the M button toward ▶▶.

- You can perform the same operation by pressing the ▶▶ button on the main unit.
- Recording will start.

To interrupt recording

Move the M button toward ▶▶.

- Recording starts by moving the M button toward ▶▶ again.
- You can perform the same operation by pressing the ▶▶ button on the main unit.
- The track number will be increased by one each time the recording is interrupted.

To stop recording

Move the M button toward ■.

You can perform the same operation by pressing the ■ button on the main unit.

To write recorded contents on the MiniDisc

Move the M button toward ■ whilst in the stop mode.

Notes:

- Whilst making a mic recording, do not connect anything to the OPTICAL/LINE IN socket on the portable MD.
- To use a microphone, be sure it is a plug-in-power type microphone.
 - When a plug-in-power type microphone is plugged in, the portable MD will provide power for the microphone's operation.
 - If a different type of microphone is plugged in, it may not operate properly or it may cause the unit to malfunction.
- Insert the plug firmly. If you don't, the recording will not be made properly.
- Use a microphone with a 3.5 mm (1/8") diameter stereo mini plug.

Recording from a Microphone (continued)

■ Sound-actuated recording (Mic Synchronised recording)

The unit automatically pauses when the microphone does not pick up any sound for 3 seconds or more. (Pause function does not work for approximately 10 seconds after a recording starts.) When the microphone picks up sound again, recording starts automatically.

1 Hold down the REC button for 2 seconds or more.

You can perform the same operation by simply pressing the REC button on the main unit.

2 To perform group recording, hold down the GROUP button for 1 second or more so that "GROUP" is lit.

When group recording is not performed, hold down the GROUP button for 1 second or more so that "GROUP" goes out.

3 Move the M button toward ◀◀ or ▶▶ to adjust the recording level (page 20).

The same operation can be performed by pressing the ◀◀ or ▶▶ button on the main unit.

4 Press the MODE button repeatedly to select the recording mode (page 29).

5 Press the M button.

The unit enters the menu select mode.

6 Move the M button toward ◀◀ or ▶▶ to select "M(MIC SYNC LEVEL)" and press it.



7 Move the M button toward ◀◀ or ▶▶ to select the recording sensitivity and press it.

H (High): Recording starts when the unit detects -24 dB or more (the unit can start recording from quiet sounds).

L (Low): Recording starts when the unit detects -12 dB or more.

8 Press the M button.

- The unit enters the menu select mode.
- You can perform the same operation by pressing the SYNC button on the main unit. (At this time, steps 9-10 can be omitted.)

9 Move the M button toward ◀◀ or ▶▶ to select "S(SYNC)" and press it.



10 Press the M button.

Synchro recording will be paused.

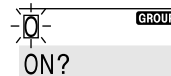

11 When a sound, such as person speaking, is picked up by the microphone, recording will begin automatically.

Notes:

- If the unit starts recording too often from low unwanted noises, set the microphone input to "L(Low)".
- Recording sensitivity can be changed whilst recording.

■ Track intervals

When recording from the microphone, track numbers will be created automatically at regular intervals (default setting: approximately every 5 minutes). During a mic synchro recording, the unit pauses when a silence lasts for 3 seconds or more, and creates a track number.

Changing intervals between tracks

1 Whilst the recording or recording is paused, press the M button.

The unit enters the menu select mode.

2 Move the M button toward **◀◀** or **▶▶** to select "T(TIME MARK)" and press it.

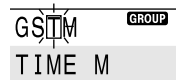

3 Move the M button toward **◀◀** or **▶▶** to select the desired interval and press it.

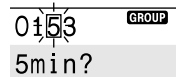

O(OFF): No track numbers are created automatically.

1(10min): A new track number is created every 10 minutes.

5(5min): A new track number is created every 5 minutes.

3(3min): A new track number is created every 3 minutes.

4 Track numbers will be created automatically at regular intervals.

- Complete the operation within 25 seconds whilst selecting the menus.

- If you press the CLEAR button during the operation, the previous display appears.
- To cancel the operation, move the M button toward ■.

Example: Set to "5 minutes".

During a mic manual recording

Timed auto marks will be created every 5 minutes.

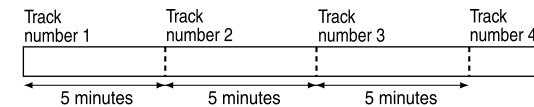

During a mic synchro recording

If a silence lasts for 3 seconds or more, a timed auto mark will be created 5 minutes after the previous mark is created.

--- : Track number which is created by the timed auto mark function.
 — : Track number which is created when a silence lasts for 3 seconds or more during synchro recording.

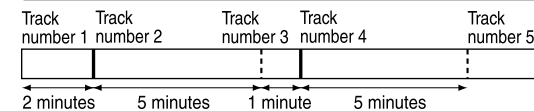

Creating track numbers manually

Press the REC button whilst recording.

Checking Displays

- To check the remaining recording time and the total playing time

Whilst in the stop mode, hold down the DISP button for 1 second or more.

Each time the button is pressed, the display will change as follows.

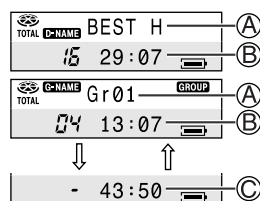

(A) Disc name when "GROUP" is off

(B) Total playing time when "GROUP" is off

Group name when "GROUP" is on

Total playing time of the selected group when "GROUP" is on

(C) Remaining recording time

- Remaining recording time varies depending on the set recording mode.
- Remaining recording time will not be displayed with a playback only MiniDisc.

- To display the playing time of an individual track

- 1 Whilst in the stop mode, move the M button toward ◀◀ or ▶▶ to select a track number or name.

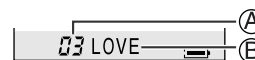

- 2 Hold down the DISP button for 1 second or more.

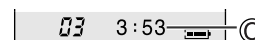

Once displaying the playing time, just select the desired track number to display its playing time.

(A) Track number

(B) Track name

(C) Playing time

In the group mode, track numbers in the group are displayed.

■ To check the elapsed time and remaining time of the track

Whilst the playback or the playback is paused, hold down the DISP button for 1 second or more.

Each time the button is pressed, the display will change as follows.

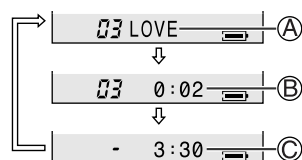

- (A) Track name (B) Elapsed playback time
(C) Remaining playback time

Notes:

- If the disc name or the track name was not originally recorded on the MiniDisc, "NoNAME" will be displayed.
- Elapsed playback time and remaining playback time may be different from the actual time.

■ Checking the remaining amount of battery level

The remaining amount of battery level is shown by the battery indicator () during operation.

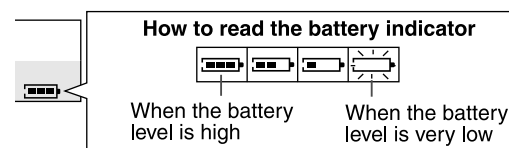

- When the battery is completely discharged, the battery indicator will flash. Recharge the battery or replace the alkaline battery with a new one.
- When the battery has run out completely, "LoBATT" will appear. Then, the power will be disconnected automatically.

Notes:

- If you use the battery which you stopped charging halfway, "" may appear. It does not mean that the battery is completely charged.
- The battery indicator will not correctly display the remaining capacity for approximately 20 seconds after the power has been turned on.
- When the AC adaptor or a separately available car adaptor is used, the battery indicator will not be shown.
- The number of bars shown in the battery indicator may increase or decrease, depending on the operation being performed. This is normal.

Titling a MiniDisc

- Load a MiniDisc to be named. A playback only or recording prevented MiniDisc cannot be edited.
- The group-recorded MD may not be edited properly with other equipment.

The group-recorded MD contains the menus that cannot be edited if the group mode has been cancelled. Select the group mode before editing.

■ Creating a disc name

Whilst in the stop mode, check that "TOTAL" is displayed on the LCD.

If "TOTAL" is not displayed, move the M button toward



- 1 Whilst in the stop mode, press the M button.

The unit enters the menu select mode.

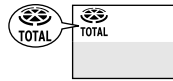

- 2 Move the M button toward or to select "N(NAME)" and press it.

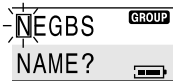

- 3 Move the M button toward or to select "D(DISC)" and press it.

The unit will enter the character input mode.

- 4 Move the M button toward to select the type of characters.

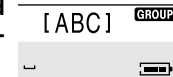

(Capital letters) (Lower-case letters) (Numbers and symbols)

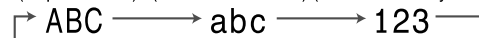

You can perform the same operation by pressing the MODE button repeatedly.

- 5 Move the M button toward or to select the character you want to enter.

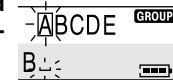

- 6 Press the M button to enter it.

- 7 To enter more letters, repeat steps 4 - 6.



- 8 After entering all the characters, hold down the M button for 1 second or more.

■ Creating a group name



Select the group mode.

- 1 Whilst in the stop mode, press the M button.**

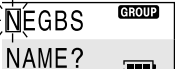
The unit enters the menu select mode.

- 2 Move the M button toward**  **or**  **to select**  **"N(NAME)" and press it.**

- 3 Move the M button toward**  **or**  **to select** **"G(GROUP)" and press it.**



- 4 Move the M button toward**  **or**  **to select** **the group you want to name and then press it.**
The unit will enter the character input mode.

- 5 Enter the characters (page 40, steps 4 - 8).**

■ Creating a track name

- 1 Whilst the track to be named is paused, press the M button.**

The unit enters the menu select mode.

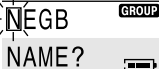

- 2 Move the M button toward**  **or**  **to select**  **"N(NAME)" and press it.**

- 3 Press the M button.**

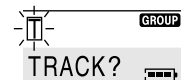
The unit will enter the character input mode.



- 4 Enter the characters (page 40, steps 4 - 8).**

- Complete the operation within 25 seconds whilst selecting the menus.
- If you press the CLEAR button during the operation, the previous display appears. (If you press this button whilst entering characters, the display you see before entering characters appears.)
- To cancel the operation, move the M button toward . (Whilst entering characters, press the CLEAR button first and then move the M button toward .)

Titling a MiniDisc (continued)

■ To erase a character

- 1 Set the unit to character input mode.
Disc name : page 40, steps 1 - 3
Group name : page 41, steps 1 - 4
Track name : page 41, steps 1 - 3
- 2 Press the VOLUME+ or VOLUME- button to move the cursor to the character you want to erase, and then press the REC button.
- 3 Hold down the M button for 1 second or more.

■ To add characters

- 1 Set the unit to character input mode.
Disc name : page 40, steps 1 - 3
Group name : page 41, steps 1 - 4
Track name : page 41, steps 1 - 3
- 2 Press the VOLUME+ or VOLUME- button to move the cursor to the character on the right of the position where you want to add a character, and enter a character.
- 3 Hold down the M button for 1 second or more.

■ To enter a space

Press the VOLUME+ button to move the cursor to the right.

■ Characters (symbols)

Capital letters																									
A	B	C	D	E	F	G	H	I	J	K	L	M	N	O	P	Q	R								
S	T	U	V	W	X	Y	Z	.	!	:															
Lower-case letters																									
a	b	c	d	e	f	g	h	i	j	k	l	m	n	o	p	q	r								
s	t	u	v	w	x	y	z	.	!	:															
Numbers and symbols																									
1	2	3	4	5	6	7	8	9	0	!	"	#	\$	%	&	'	(
)	*	+	.	-	/	:	<	=	>	?	@	_	`	~	:										

: indicates a space.

Notes:

- One disc name and up to 99 group names and 255 track names can be created per disc. (A maximum of 40 characters for each disc, group and track name, and a total of 1,700 characters can be entered per disc.)
- You cannot use "/" in a name successively.
- The MD that has been group recorded with this unit should not be named using other equipment. The disc may not be played properly.
- If the number of characters entered as a disc, group or track name exceeds 40, "N-FULL" will be displayed.
- When a disc, group, or track name that contains 40 characters is changed, "NAME CUT" will be displayed. In this case, delete all the characters and reenter the names.
- If you enter "LP:" at the beginning of a name, "LP:" may not be displayed.

Editing a Recorded MiniDisc

MD-MT888H

■ To erase one track at a time

You can erase one track at a time.

1 During playback of the track to be erased, move the M button toward ► to pause it.

2 Press the M button.

The unit enters the menu select mode.

3 Move the M button toward ◀ or ▶ to select "E(EDIT)" and press it.

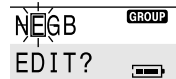

4 Move the M button toward ◀ or ▶ to select "E(ERASE)" and press it.

5 Press the M button.

The track will be erased.

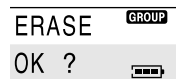

6 To erase other tracks, repeat steps 1 - 5.

Caution:

Once a track has been erased, it cannot be recovered. Check the track number before erasing it.

Note:

When all the tracks in a group have been erased, the group and the group name will also be erased.

■ To erase all of the tracks at once

You can erase all tracks at once.

1 Whilst in the stop mode, press the M button.

The unit enters the menu select mode.

2 Move the M button toward ◀ or ▶ to select "E(EDIT)" and press it.

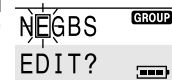

3 Move the M button toward ◀ or ▶ to select "A(ALL ERASE)" and press it.

4 Press the M button.

All of the tracks will be erased.

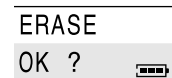

Caution:

Once a track has been erased, it cannot be recovered. Check the track number before erasing it.

- Complete the operation within 25 seconds whilst selecting the menus.
- If you press the CLEAR button during the operation, the previous display appears.
- To cancel the operation, move the M button toward ■.

Editing a Recorded MiniDisc (continued)

■ To divide a track

You can divide a track into 2 tracks.

- 1 Play back the track to be divided, and move the M button toward ►| at the point where you want to divide the track to pause it.**

- 2 Press the M button.**

The unit enters the menu select mode.

- 3 Move the M button toward ◀◀ or ▶▶ to select "E(EDIT)" and press it.**

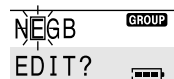

- 4 Move the M button toward ◀◀ or ▶▶ to select "D(DIVIDE)" and press it.**

- 5 Press the M button.**

The track will be divided into two tracks, and the unit will pause at the beginning of the second of the two new tracks.

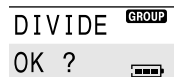

When a track has a name before dividing:

The two new tracks will have the same name. However, in the "T-FULL" condition, the second track may not be named.

Total number of tracks that can be divided:

Each disc can hold up to 255 tracks. However, even if the number of assigned tracks has not reached 255, it might not be possible to make any further divisions of tracks.

■ To move a track

You can move a track to the desired position.

- 1 Play back the track to be moved, and move the M button toward ►| to pause it.**

- 2 Press the M button.**

The unit enters the menu select mode.

- 3 Move the M button toward ◀◀ or ▶▶ to select "E(EDIT)" and press it.**



- 4 Move the M button toward ◀◀ or ▶▶ to select "M(MOVE)" and press it.**

- 5 Move the M button toward ◀◀ or ▶▶ to locate the position the track is moved to.**

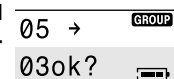

- 6 Press the M button.**

The track will be moved, and the unit will be paused at the beginning of the track.

Moving a track to another group

Group-recorded tracks can be moved within the group. To move them to a different group, use the GROUP CHANGE function.

■ To combine tracks

Two adjacent tracks can be combined.

1 Play back the second of the two tracks to be combined and move the M button toward ► to pause it.

2 Press the M button.

The unit enters the menu select mode.

3 Move the M button toward ◀ or ▶ to select "E(EDIT)" and press it.

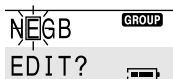

4 Move the M button toward ◀ or ▶ to select "C(COMBINE)" and press it.

5 Press the M button.

The two tracks will be combined, and the unit will be paused at the beginning of the combined track.

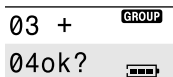

To combine two non-adjacent tracks:

- First, put the two tracks next to each other in the order you want using the MOVE function. Then combine them using the COMBINE function.
- For group-recorded tracks, only those in the same group can be combined. To combine tracks in different groups, move one track using the GROUP CHANGE function before combining them.

When one or both tracks to be combined have a name:

The first track name will be used. However, when the first track does not have a name, the second track name will be used.

In the following cases, tracks may not be combined.

- Tracks recorded by different inputs cannot be combined.
- Example:
 - Digital recorded track and analogue recorded track.
 - Different recording modes (stereo recording, 2 times long recording, 4 times long recording, monaural recording).
- Tracks whose recording time is less than 12 seconds.

- Complete the operation within 25 seconds whilst selecting the menus.
- If you press the CLEAR button during the operation, the previous display appears.
- To cancel the operation, move the M button toward ■.

Editing a Recorded MiniDisc (continued)

■ Moving a track to another group

On a group-recorded MD, you can move a track to a different group. (Group change)

1 Play back the track to be moved, and move the M button toward ►|| to pause it.

2 Press the M button.

The unit enters the menu select mode.

3 Move the M button toward ◀◀ or ▶▶ to select "G(GROUP)" and press it.

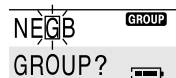

4 Move the M button toward ◀◀ or ▶▶ to select "C(GrCHANGE)" and press it.

5 Move the M button toward ◀◀ or ▶▶ to select the group the track is moved to.

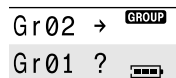

6 Press the M button.

The track is moved to the end of the selected group, and the playback is paused at the beginning of the moved track.

Notes:

- When all the tracks in a group are moved to different groups, the group and the group name will be erased.
- Non-group tracks can also be moved to a group using the GROUP CHANGE function.

■ Moving a group to the top

On a group-recorded MD, group-recorded tracks can be moved to the beginning of the MiniDisc. (Group top move)

1 Whilst in the stop mode, select the group to be moved (page 24).

2 Press the M button.

The unit enters the menu select mode.

3 Move the M button toward ◀◀ or ▶▶ to select "G(GROUP)" and press it.

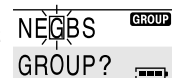

4 Move the M button toward ◀◀ or ▶▶ to select "T(GrTOPMOVE)" and press it.

5 Press the M button.

The group will be moved to the top of the MD.

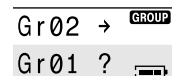

Notes:

- If the group name has been recorded, the group name will not be changed even if the GROUP TOP MOVE function is performed.
- The GROUP TOP MOVE function cannot be performed with non-group tracks or groups without tracks.



■ Erasing a group

On a group-recorded MD, you can erase all tracks in a group at once. (Group erase)



1 Whilst in the stop mode, select the group you want to erase (page 24).

2 Press the M button.

The unit enters the menu select mode.

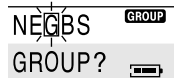
3 Move the M button toward  **or**  **to select** "G(GROUP)" **and press it.**



4 Move the M button toward  **or**  **to select** "E(Gr&TrERASE)" **and press it.**

5 Press the M button.

The selected group will be erased.

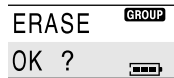

Caution:

Once a group has been erased, it cannot be recovered. Check carefully before you erase it.

Note:

The GROUP ERASE function erases the group and group name.

- Complete the operation within 25 seconds whilst selecting the menus.
- If you press the CLEAR button during the operation, the previous display appears.
- To cancel the operation, move the M button toward .

Editing a Recorded MiniDisc (continued)

■ Stamping titles from another MiniDisc

Before stamping

When there are 2 MiniDiscs on which the same tracks are recorded, you can transfer the character information (disc, group, and track names) of the master MiniDisc to another MiniDisc (for stamping) simultaneously.

1. What is a master MiniDisc?

A recordable MiniDisc that contains tracks and character information. (You cannot transfer the information from a playback-only MiniDisc.)

2. What is a MiniDisc for stamping?

A MiniDisc that contains the same tracks in the same order as the master MiniDisc. (Make sure that the total number of tracks of the master MiniDisc and the one for stamping are the same.)

Notes:

- When information of the non-grouped MD is stamped on the group-recorded MD, the disc and track names will be stamped properly. However, the group information will be erased.
- When information of the group-recorded MD is stamped on the non-grouped MD, tracks will be grouped automatically.

Master MiniDisc operation

1 Insert a master MiniDisc.

Do not mistake the master MiniDisc for the target one.

2 Whilst in the stop mode, press the M button.

The unit enters the menu select mode.

3 Move the M button toward

◀◀ or ▶▶ to select "E(EDIT)" and press it.

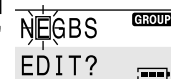

4 Move the M button toward

◀◀ or ▶▶ to select "N(NAME STAMP)" and press it.

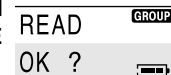

5 Press the M button.

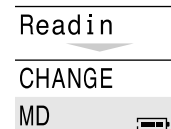

6 When the unit displays "CHANGE MD", remove the master MiniDisc.



Remove it without turning off the power. Or, the operation will be cancelled.

Operation of the MiniDisc for stamping

7 Load a MiniDisc for stamping.

TOC RE 

WRITE

OK ? 

8 Press the M button.

The unit will finish recording the character information and enter the stop mode.

Writin

EDIT

COMPLE 

Note:

If the total number of tracks on the master MiniDisc does not match that on the MiniDisc for stamping, the unit will display "Can'tE" and turn off the power.

Can'tE 

If this happens, adjust the total number of tracks on the newly recorded MiniDisc using the edit operation.

- Complete the operation within 25 seconds whilst selecting the menus.
- If you press the CLEAR button during the operation, the previous display appears.
- To cancel the operation, move the M button toward .

■ Creating a group before recording



You can create a group in advance and record tracks in it.

1 Whilst in the stop mode, press the M button.

The unit enters the menu select mode.

2 Move the M button toward



◀◀ or ▶▶ to select "G(GROUP)" and press it.

NEGBS  GROUP
GROUP? 

3 Move the M button toward ◀◀ or ▶▶ to select "R(GrRESERVE)" and press it.

The unit will enter the character input mode.

4 Enter the group name (page 40, steps 4 - 7).

ABCDE  GROUP
 

Otherwise, you will not be able to create a group.

5 Hold down the M button for 1 second or more.

The created group name will be displayed.

Note:

Even if you create a group using the GROUP RESERVE function, it will not be played if no track is recorded in it. (Group name will not be displayed either.) To check the contents of the group, refer to "To search a desired group (page 24)".

To record in the created group:

Refer to "Adding tracks to an existing group (page 21)".

Editing a Recorded MiniDisc (continued)

■ Moving non-group tracks to after group-recorded tracks

If non-group tracks are found in the middle of a group-recorded MD, they can be moved to after group-recorded tracks. (Group arrange)

1 Whilst in the stop mode, press the M button.

The unit enters the menu select mode.

2 Move the M button toward

◀◀ or ▶▶ to select "G(GROUP)" and press it.

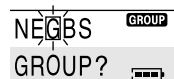

3 Move the M button toward ◀◀ or ▶▶ to select "A(GrARRANGE)" and press it.

4 Press the M button.

Non-group tracks are moved to after group-recorded tracks.

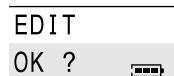

Note:

As the GROUP ARRANGE function moves all the non-group tracks to the end of the MD, the order of tracks will be completely changed.

■ Erasing group information

You can erase the entire group information of a group-recorded MD. By erasing the group information of a MD, it will be a non-group MD. (Group cancel)

1 Whilst in the stop mode, press the M button.

The unit enters the menu select mode.

2 Move the M button toward

◀◀ or ▶▶ to select "G(GROUP)" and press it.

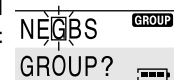

3 Move the M button toward ◀◀ or ▶▶ to select "C(GrCANCEL)" and press it.

4 Press the M button.

The group information will be erased.

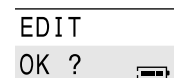

Caution:

The GROUP CANCEL function erases all the group information. Check carefully before you erase it.

- Complete the operation within 25 seconds whilst selecting the menus.
- If you press the CLEAR button during the operation, the previous display appears.
- To cancel the operation, move the M button toward ■.

Hold Function

MD-MT888H

The present operation condition can be kept even if other buttons are accidentally pressed in a place such as a crowded train.

Main unit

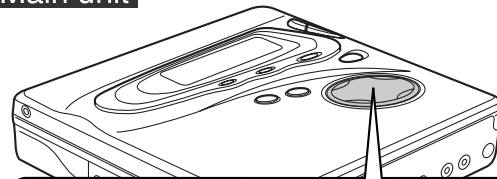

Press the ■ (HOLD) button for 2 seconds or more.

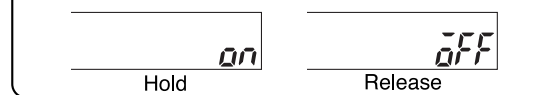

If the battery is inserted or the AC adaptor is connected, you can set this function even when the power is turned off.

To cancel the hold mode

Press and hold down the ■ (HOLD) button for 2 seconds or more whilst the unit is in the hold mode. "OFF" will be shown.

Remote control unit

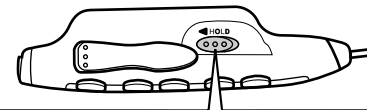

Move the HOLD switch to the safety position (direction indicated by the arrow).



To cancel the hold mode

Move the HOLD switch away from the safety position (the opposite direction of the arrow).

If the hold function is active whilst the power is turned off, the power cannot be turned on by mistake and the battery will not be drained.

Changing Default Settings

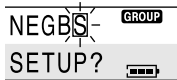
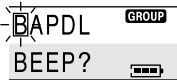
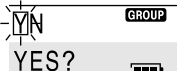
- 1** Insert a MiniDisc.
- 2** Whilst in the stop mode, press the M button.
The unit enters the menu select mode.
- 3** Move the M button toward **◀** or **▶** to select "S(SET-UP)" and press it.
 
- 4** Move the M button toward **◀** or **▶** to select a menu and press it.
 
- 5** Move the M button toward **◀** or **▶** to select an item and press it.
 

- Complete the operation within 25 seconds whilst selecting the menus.
- If you press the CLEAR button during the operation, the previous display appears.
- To cancel the operation, move the M button toward **■**.

Menu	Item	
B(BEEP)	Y(YES) *	Beep on
Beep sound	N(NO)	Beep off
A(AUTO PLAY)	Y(YES) *	Set
Auto play	N(NO)	Cancelled
P(PowerSave)	Y(YES) *	Set
Auto power save	N(NO)	Cancelled
D(D-LEVEL)	1(D.L 1)*	Setting retained
Digital recording level	2(D.L 2)	Cancelled
L(LIGHT)	N(NORM)*	See the next page
3-colour indicators/Backlight on the remote control	A(ALL)	
	O(OFF)	

(*) indicates default setting.

■ Beep sound

You can eliminate the confirmation sound that beeps when you press a button.

■ Auto play

You can make the unit not play automatically when you insert a playback-only MiniDisc or an accidental erasure protected MiniDisc.

■ Auto power save

When the unit is used in a place exposed to much vibration, sound skipping can be decreased by cancelling the auto power save function. (Battery will drain faster.)

What is auto power save function?

During playback, maximum 40 seconds (in stereo) of musical information is stored. Auto power save function automatically adjusts the storage time between 5 and 40 seconds to reduce the power consumption. If this function is cancelled, the storage time cannot be adjusted.

- If this unit is used with the AC adaptor, the storage time will be 40 seconds regardless of the settings.
- The storage time varies depending on the recording mode.

■ Digital recording level

"D.L 1"

The digital recording level you set will be kept even after cancelling recording.

"D.L 2"

Every time you cancel recording, the level will return to [D.L 0dB].

■ 3-colour indicators lighting and backlight on the remote control

"NORM"

3-colour indicators Always flashing

Backlight on the remote control Lit for approx. 10 seconds during operation

"ALL"

3-colour indicators Always lit

Backlight on the remote control Lit for approx. 10 seconds during operation

(Always lit if used with AC adaptor)

"OFF"

3-colour indicators Not lit

Backlight on the remote control Not lit

Listening through Another System

■ Listening through a stereo system

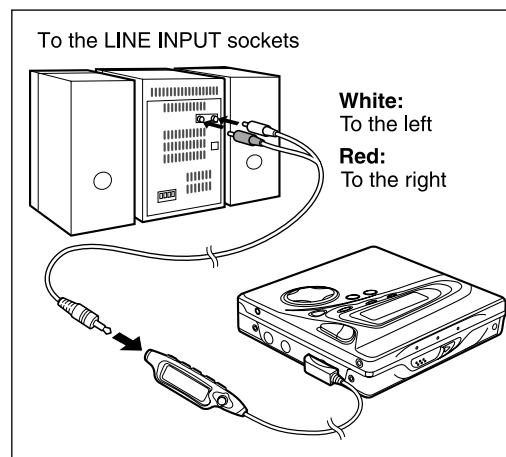

Notes:

- It is recommended that the volume level of the MiniDisc unit be set to maximum when listening through a stereo system.
- When recording with stereo system, eliminate the confirmation sound (page 52). Otherwise, it will also be recorded.
- The recording will be made in the analogue mode.
- Character information will not be recorded.

■ Listening through a car stereo

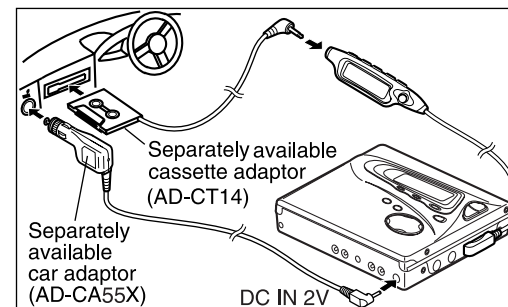

Notes:

- Adjust the volume of both this portable MD and a car stereo.
- Do not operate this portable MD whilst you drive a car. It may distract your attention and cause a traffic accident.
- Do not use any car adaptor except for the separately available AD-CA55X.
- Remove the battery when you power the unit from the car battery.
- Do not leave the unit in the place of high temperature such as in a car. If the unit gets hot, the LCD display will be darkened and hard to read. It will return to normal when the temperature cools down.

Other Features and Caution

MD-MT888H

■ Resuming auto play

When you stop playback and replay the MiniDisc without removing it, playback starts from the point you stopped it.

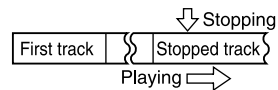

Once you remove the MiniDisc, playback starts from the first track.

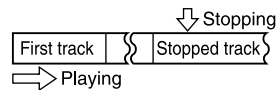

The unit provides the following functions when you use it with the separately available car adaptor (AD-CA55X) (when the rechargeable or alkaline battery is removed):

1. When you turn off the engine, the power of this portable MD also turns off. (It may not work with some types of cars.)
2. When you restart the engine, playback starts from the beginning of the stopped track.

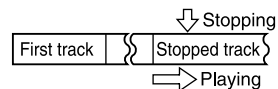

■ Rechargeable battery

- A rechargeable nickel-metal hydride battery is the only kind that can be used. Even if the battery is not used, you should charge it at least once every three months because of the special quality of this battery.
- The rechargeable battery can be charged approximately 300 times.
- When the operating time is reduced to about half the normal amount of time, even after a full charge is performed, replace the battery with a new one (AD-N55BT).
- When the battery is charged for the first time or is charged after not being used for a long period, the operating time may be shorter than normal. The battery life will recover with normal use i.e. charging and discharging.
- To avoid shortening the service life of the battery only recharge the battery after it has been completely discharged.
- If the rechargeable battery is used in a cold environment, the operating time will be reduced.
- Do not carry the battery in your pocket or a bag together with metal objects (keys, coins, jewelry, etc.). The battery may short out and generate significant amounts of heat.
- Do not short-circuit the terminals as they will become very hot and will damage the battery.
- Do not drop or subject the battery to shock.
- Do not insert objects (metal etc.) into the battery compartment of this product or into the rechargeable battery.

Troubleshooting

Many potential "problems" can be resolved by the owner without calling a service technician. If something seems to be wrong with this product, check the following before calling your authorised SHARP dealer or service centre.

The unit does not turn on.

- Is the AC adaptor disconnected?
- Is the battery exhausted?
- Is the unit in the hold mode?
- Has condensation formed inside the unit?
- Is the unit being influenced by mechanical shock or by static electricity?

When the operation buttons are pressed, the unit does not respond.

- Is the unit in the hold mode?
- Is the battery being charged?
- Is the battery exhausted?
- Is the remote control unit plug or the earphones plug inserted firmly?

No sound is heard from the earphones.

- Is the volume set too low?
- Is the remote control unit or the earphones plugged in?
- Are you trying to play a MiniDisc with data on it instead of a MiniDisc containing music?

Some sounds are skipped.

- Is the battery exhausted?
- Is the unit being subjected to excessive vibration?

The MiniDisc cannot be ejected.

- Has the track number or character information been written on the disc yet?
- Is the unit in the recording or editing mode?

Recording and editing are impossible.

- Is the MiniDisc protected against accidental erasure?
- Has the recording level been properly adjusted?
- Is the unit connected properly to the other equipment?
- Is the AC adaptor unplugged or did a power failure occur whilst recording or editing?
- Is the unit in the hold mode?
- Is an optical signal being output from the stereo system? Read the operation manual for the stereo system.

The battery cannot be charged.

- Is the rechargeable battery in the unit?
- Is the terminal dirty?

Group functions cannot be used with the group-recorded MD.

- TOC information may have been changed with other equipment.

■ If trouble occurs

When this product is subjected to strong external interference (mechanical shock, excessive static electricity, abnormal supply voltage due to lightning, etc.) or if it is operated incorrectly, it may malfunction.

If such a problem occurs, do the following:

1. Unplug the AC adaptor from the wall socket.
2. Remove the battery.
3. Leave the unit completely unpowered for approximately 30 seconds.
4. Plug the AC adaptor back into the wall socket and re-operate the unit.

■ Moisture condensation

When the unit has condensation inside, the disc signals cannot be read, and the unit may not function properly.

In the following cases, condensation may form inside the unit.

- Shortly after turning on a heater.
- When the unit is placed in a room where there is excessive steam or moisture.
- When the unit is moved from a cool place to a warm place.

To remove condensation:

Remove the MiniDisc and leave the unit for approximately 1 hour. The condensation should evaporate and the unit will work properly.

MiniDisc System Limitations

The unit may have the following symptoms whilst recording or editing. The unit is not out of order.

SYMPTOM	LIMITATIONS
"D-FULL" or "T-FULL" appears even though the MiniDisc still has recording time left.	More than the limited number of tracks (255) cannot be recorded regardless of the recording time. If the MiniDisc is recorded or edited repeatedly or it has scratches (recording skips scratched parts), you may not be able to record the maximum number of tracks described above. If the total number of character information (disc, group, and track names) exceeds 1,700, the MD cannot be edited.
The remaining recording time does not increase even though you erased tracks.	The unit does not count non-recorded portions that last 12 or fewer seconds to display the remaining recording time. The time may not increase even if you erase short tracks.
The total of the recorded time and the remaining time does not match the maximum recordable time.	One cluster (approximately 2 seconds) is the minimum unit for recording. For example, a 3-second track uses 2 clusters (approximately 4 seconds). Therefore, the actual recordable time may be shorter than the displayed time. (The number of seconds indicates that in the stereo recording mode (SP). It varies depending on the recording mode.)
Combine function does not work.	A MiniDisc on which recording and editing are repeated may not allow the combine function.
Sound skips in fast reverse/forward.	If one track is divided and recorded in separate places on a repeatedly recorded or edited MiniDisc, sound may skip.
A track number is created in the middle of a track.	A track number may be created if there are scratches or dust on the MiniDisc.
Even if "LP :" is entered at the top of the name, "LP :" is not displayed.	If "LP :" is entered at the top of the 2 times/4 times long recorded track (LP2/LP4), "LP :" will not be displayed. Enter other symbols than ":" after "LP".

Error Messages

MD-MT888H

ERROR MESSAGES	MEANING
BLANK	<ul style="list-style-type: none"> Nothing is recorded. (Replace the disc with a recorded disc.)
busy	<ul style="list-style-type: none"> A track is being moved.
Can'tC	<ul style="list-style-type: none"> You tried to record from a copy prohibited MiniDisc. You tried to record signals other than music (such as data). (Record using the analogue cable.)
Can'tE	<ul style="list-style-type: none"> A track cannot be edited. (Change the stop position of the track and then edit it.)
Can'tL	<ul style="list-style-type: none"> You tried to record or edit the MD whilst operating the OPEN lever.
Can'tP	<ul style="list-style-type: none"> Cannot play the MD.
Can'tR	<ul style="list-style-type: none"> Recording cannot be performed correctly due to vibration or shock.
Can'tS Can'tT(*) Can'tU	<ul style="list-style-type: none"> The disc data cannot be read because the disc is damaged. (Reload the Minidisc or replace it with another one.)

ERROR MESSAGES	MEANING
Can'tSTAMP	<ul style="list-style-type: none"> Stamp function does not work. (Check the number of tracks.)
Can'tW	<ul style="list-style-type: none"> Cannot save the TOC information correctly to a MiniDisc.
CH (displayed on the main unit)	<ul style="list-style-type: none"> You tried to operate whilst charging.
D-FULL	<ul style="list-style-type: none"> The disc is out of recording space.
DEFECT	<ul style="list-style-type: none"> The disc is scratched. (If the recorded sound is not right, retry recording or replace the disc with a recordable one.)
Er-MD (**)	<ul style="list-style-type: none"> The microprocessor has reported a system fault and the unit is out of order. (To have it repaired, go to the distributor where you purchased the unit.)

Number or symbol appears in (*) position.

Error Messages (continued)

ERROR MESSAGES	MEANING
G-FULL	<ul style="list-style-type: none"> The total number of groups exceeds 99. (Erase unnecessary groups.)
HOLD	<ul style="list-style-type: none"> The unit is in the hold mode.
LoBATT	<ul style="list-style-type: none"> The rechargeable or alkaline battery has run down.
LOCKED	<ul style="list-style-type: none"> You removed a MiniDisc whilst recording or editing. (Turn off the power before removing the MiniDisc.)
N-FULL	<ul style="list-style-type: none"> The number of a disc, group, or track name exceeds 40. (Shorten the name.)
NoDISC	<ul style="list-style-type: none"> A disc has not been loaded.
noSIG.	<ul style="list-style-type: none"> Poor connection of the digital cable. No output signal comes out from the connected unit to playback. (Use the AC power for the connected unit.) <ul style="list-style-type: none"> The input signal has improper sampling frequency.

ERROR MESSAGES	MEANING
NoTRACK	<ul style="list-style-type: none"> There is no track to be played.
PLAYmd	<ul style="list-style-type: none"> You tried to record on a playback-only disc.
POWER ?	<ul style="list-style-type: none"> The battery charger is defective.
PROTECTED	<ul style="list-style-type: none"> The write protection tab of a MiniDisc is set to the protected position.
Sorry	<ul style="list-style-type: none"> Since a track number is currently being located or updated, the unit cannot accept your command. (Wait for a while and try the operation again.)
T Form (*)	<ul style="list-style-type: none"> There is an error in the recording signal. (Erase all of the tracks, and then record again.)
T-FULL	<ul style="list-style-type: none"> There is no space left for recording character information (track names, disc names, etc.).
TEMP!	<ul style="list-style-type: none"> The temperature is too high. (Turn off the power, and wait for a while.)

Number or symbol appears in (*) position.

ERROR MESSAGES	MEANING
Tr. Protect	<ul style="list-style-type: none"> The track has been protected from being erased. (Edit the track with the device on which it was recorded.)
?DISC	<ul style="list-style-type: none"> A disc which contains data other than music was played. (A disc which contains nonmusic data cannot be played.)
?GrForm	<ul style="list-style-type: none"> The group recording or the GROUP RESERVE function cannot be performed. (Erase the disc name and retry the same operation.)

- If the operation is not accepted, "--" may be displayed on the main unit. For details, refer to the display on the remote control.

Maintenance

MD-MT888H

■ Cleaning

When the unit becomes dirty

Clean it with a soft cloth. When the unit is excessively dirty, use a soft cloth dampened in water (external surfaces only).

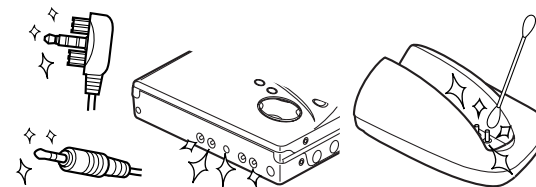

Clean the plugs and the connecting sockets.

If the plugs or sockets are dirty, noise may be heard. Cleaning will prevent noise.

Caution:

- Do not use chemicals for cleaning (petrol, paint thinner, etc.). It may damage the cabinet finish.
- Do not apply oil to the inside of the unit. It may cause malfunctions.

Specifications

As a part of our policy of continuous improvement, SHARP reserves the right to make design and specification changes for product improvement without prior notice. The performance specification figures indicated are nominal values of production units. There may be some deviations from these values in individual units.

Power source:	DC 5 V: AC adaptor (AC 230 - 240 V, 50/60 Hz) DC 1.5 V: Commercially available, "AA" size (LR6), alkaline battery x 1 DC 1.2 V: Rechargeable Nickel-Metal Hydride battery AD-N55BT x 1 DC 1.5 V: Optional car adaptor, AD-CA55X (for cars with a 12-24 V DC negative earth electrical system)
Power consumption:	7 W (AC adaptor)
Output power:	RMS: 10 mW (5 mW + 5 mW) (0.2 % T.H.D.)
Charging time:	Approx. 3.0 hours (90 %) Approx. 5.0 hours (fully charged)
Dimensions:	Width: 71.9 mm (2-27/32") Height: 15.7 mm (5/8") Depth: 78.9 mm (3-1/8")
Weight:	128 g (0.28 lbs.) with rechargeable battery
Input socket:	Line/optical digital, microphone (powered by the main unit)
Output socket:	Earphones (impedance: 32 ohms)/remote control unit
Type:	Portable MiniDisc recorder
Signal readout:	Non-contact, 3-beam semiconductor laser pickup
Audio channels:	Stereo 2 channels/monaural 1 channel
Frequency response:	20 - 20,000 Hz (\pm 3 dB)
Rotation speed:	Approx. 400 - 1,350 rpm
Error correction:	ACIRC (Advanced Cross Interleave Reed-Solomon Code)
Coding:	ATrac/ATrac3 (Adaptive TRansform Acoustic Coding), 24-bit computed type
Recording method:	Magnetic modulation overwrite method
Sampling frequency:	44.1 kHz (32 kHz and 48 kHz signals are converted to 44.1 kHz, and then recorded.)
Wow and flutter:	Unmeasurable (less than \pm 0.001 % W. peak)

Battery life:

	Stereo		2 times long		4 times long	
When using the rechargeable battery (fully charged) included with the unit	Continuous recording: Approx. 8 hours	Continuous play: Approx. 13.5 hours	Continuous recording: Approx. 11 hours	Continuous play: Approx. 16 hours	Continuous recording: Approx. 14 hours	Continuous play: Approx. 18.5 hours
When using one, commercially available, high capacity, "AA" size (LR6), alkaline battery (The rechargeable battery is in the unit, discharged.)	Continuous recording: Approx. 9 hours	Continuous play: Approx. 20 hours	Continuous recording: Approx. 14 hours	Continuous play: Approx. 25 hours	Continuous recording: Approx. 19.5 hours	Continuous play: Approx. 29 hours
When using one, commercially available, high capacity, "AA" size (LR6), alkaline battery with the rechargeable battery (fully charged)	Continuous recording: Approx. 19 hours	Continuous play: Approx. 35 hours	Continuous recording: Approx. 27.5 hours	Continuous play: Approx. 42.5 hours	Continuous recording: Approx. 36.5 hours	Continuous play: Approx. 49 hours

Input sensitivity:

	Reference input level	Input impedance
MIC H	0.25 mV	10 k ohms
MIC L	2.5 mV	10 k ohms
LINE	100 mV	20 k ohms

Output level:

	Specified output	Maximum output level	Load impedance
Earphones	-	5 mW + 5 mW	32 ohms
LINE	250 mV (-12 dB)	-	10 k ohms

- The continuous recording time is for analogue inputs when the volume level is set to "VOL 0".
- The continuous play time shows the value when the volume level is set to "VOL 15".
- The above values are the standard values when the unit is charged and used at an ambient temperature of 25°C (77°F).
- The operating time when using an alkaline battery may be different, depending on the type and manufacturer of the battery, and on the operating temperature.
- The L (LIGHT) is set at "O (OFF)" (see page 52).



TERMS OF GUARANTEE

Subject to the terms listed below, Sharp Electronics (U.K.) Ltd. (hereinafter called "the Company") guarantee to provide for the repair of, or at its option replace this Sharp Equipment, or any component thereof, (other than batteries), which is faulty or below standard, as a result of inferior workmanship or materials.

The conditions of this guarantee are:

1. The guarantee shall only apply to defects which occur within one year from the date of purchase, provided that this equipment is sent to the repair address within this period.
2. This guarantee covers equipment intended for private domestic use only. This guarantee does not apply to equipment used in the course of a business, trade or profession.
3. The guarantee does not cover MiniDiscs or batteries.
4. This guarantee does not cover any faults or defects caused by accident, misuse, fair wear and tear, neglect, tampering with the equipment, or any attempt at adjustment or repair other than by a Service Facility appointed by Sharp.
5. In the unlikely event of a defect occurring, the product must be returned to the Company's repair centre with proof of purchase. A postage paid label and a fault report form are supplied with the product for this purpose. It is your responsibility to ensure that the packaging is adequate, and to obtain proof of posting. Further details of the repair service, which is available after the guarantee period on a chargeable basis, and additional report forms and labels can be obtained by telephoning 0870 738 0000.
6. No person has any authority to vary the terms or conditions of this guarantee.
7. This guarantee is offered as an additional benefit to the consumer's statutory rights and does not affect these rights in any way.

SHARP

SHARP ELECTRONICS (U.K.) LTD.

Sharp House, Thorp Road, Newton Heath, Manchester, M40 5BE

SHARP CORPORATION

TINSE0400AWZZ

A0108.YT



Free Manuals Download Website

<http://myh66.com>

<http://usermanuals.us>

<http://www.somanuals.com>

<http://www.4manuals.cc>

<http://www.manual-lib.com>

<http://www.404manual.com>

<http://www.luxmanual.com>

<http://aubethermostatmanual.com>

Golf course search by state

<http://golfingnear.com>

Email search by domain

<http://emailbydomain.com>

Auto manuals search

<http://auto.somanuals.com>

TV manuals search

<http://tv.somanuals.com>