

SHARP®

MODEL

FO-IS125N

FACSIMILE

OPERATION MANUAL

U.S.A.

WARNING - FCC Regulations state that any unauthorized changes or modifications to this equipment not expressly approved by the manufacturer could void the user's authority to operate this equipment.

Note: This equipment has been tested and found to comply with the limits for a Class B digital device, pursuant to Part 15 of the FCC Rules. These limits are designed to provide reasonable protection against harmful interference in a residential installation. This equipment generates, uses and can radiate radio frequency energy and, if not installed and used in accordance with the instructions, may cause harmful interference to radio communications. However, there is no guarantee that interference will not occur in a particular installation. If this equipment does cause harmful interference to radio or television reception, which can be determined by turning the equipment off and on, the user is encouraged to try to correct the interference by one or more of the following measures:

- Reorient or relocate the receiving antenna.
- Increase the separation between the equipment and the receiver.
- Connect the equipment into an outlet on a circuit different from that to which the receiver is connected.
- Consult the dealer or an experienced radio/TV technician for help.

ABOUT THE TELEPHONE CONSUMER PROTECTION ACT OF 1991

"The Telephone Consumer Protection Act of 1991 makes it unlawful for any person to use a computer or other electronic device to send any message via a telephone facsimile machine unless such message clearly contains in a margin at the top or bottom of each transmitted page or on the first page of the transmission the following information:

- (1) The date and time of transmission.
- (2) Identification of either the business, business entity or individual sending the message.
- (3) Telephone number of either the sending machine, business, business entity or individual.

In order to program this information into your facsimile machine, please refer to the appropriate instructions in the operation manual."

Declaration of Conformity

SHARP FACSIMILE, FO-IS125N

This device complies with Part 15 of the FCC rules. Operation is subject to the following two conditions:

- (1) This device may not cause harmful interference, and (2) this device must accept any interference received, including interference that may cause undesired operation.

Responsible Party:

SHARP ELECTRONICS CORPORATION
Sharp Plaza, Mahwah, New Jersey 07430-1163
TEL: 800-237-4277



As an ENERGY STAR® partner, SHARP has determined that this product meets the ENERGY STAR® guidelines for energy efficiency.

This product contains a CR Coin Lithium Battery which contains Perchlorate Material - special handling may apply, California residents, See www.dtsc.ca.gov/hazardouswaste/perchlorate/

Canada

This product meets the applicable Industry Canada technical specifications

The Ringer Equivalence Number is an indication of the maximum number of devices allowed to be connected to a telephone interface. The termination on an interface may consist of any combination of devices subject only to the requirement that the sum of the RENs of all the devices does not exceed five.

Table of Contents

Table of Contents	1
<hr/>	
Introduction	4
Specifications	4
<hr/>	
A Look at the Operation Panel	9
<hr/>	
1. Installation	13
<hr/>	
Unpacking Checklist	13
Basic Setup	14
Installing the Toner Cartridge and Drum Cartridge	18
Loading Printing Paper	23
Entering Your Name and Fax Number	24
Setting the Date and Time	25
Setting the Reception Mode	27
Volume Adjustment	27
<hr/>	
2. Network Scanning	29
<hr/>	
Setting up Network Scanning	29
Storing E-mail Addresses	37
Scan to E-mail Transmission	42
Network Settings	46
Scan to Folder / FTP	48
<hr/>	
3. Sending Faxes	52
<hr/>	
Transmittable Documents	52
Loading the Document	53
Adjusting the Resolution and Contrast	55
Sending a Fax by Normal (Manual) Dialing	57
Sending a Fax by Automatic Dialing	60
<hr/>	
4. Receiving Faxes	68
<hr/>	
Using AUTO Mode	68
Using MANUAL Mode	69
Reception to Memory	70

Table of Contents

5. Security Functions (Administrator)	71
Introduction	71
Administrator Code	72
User Authentication	74
Secure Fax	84
Authorized Transmission	88
Call Restriction	96
Send Hold Function (Fax Only)	100
6. Printing	102
Installing the Printer Driver	102
Printing a Document From an Application	104
Selecting Print Settings	105
7. Making Copies	109
8. Special Functions	111
Broadcasting	111
Distinctive Ring (Requires Service)	115
Blocking Unwanted Faxes	117
Duplex Scanning	119
Receiving Faxes to E-mail/Folder	120
Searching for an Address in a Global Address Book	123
Polling (Requesting a Fax)	128
Timer Transmission	133
9. Option Settings	136
10. Checking Stored Information	141
Transaction Report	143
11. Maintenance	144
Cleaning the Scanning Glass and Rollers	144
Cleaning the Paper Feed Roller	147
Replacing the Toner Cartridge	148
Replacing the Drum Cartridge	150

Table of Contents

12. Troubleshooting	154
Problems and Solutions	154
Messages and Signals	159
Clearing Paper Jams	163
FCC Regulatory Information	168
Index	173

Introduction

Specifications

Print specifications

Toner cartridge yield* (continuous printing, 5% page coverage, letter paper)	Initial starter cartridge (included with machine): Approx. 1500 pages Replacement cartridge (FO-25ND): Approx. 3000 pages
Drum cartridge yield* (continuous printing, 5% page coverage, letter paper)	Initial starter cartridge (included with machine): 20,000 pages (average) Replacement cartridge (FO-25DR): 20,000 pages (average)
Paper tray capacity	Letter: Approx. 250 sheets (20-lb. copier paper at room temperature; maximum stack height should not be higher than the line on the tray) Legal: 100 sheets Recommended paper weight: 20-lb. Copy Bond
Printer type	Laser
Print resolution	600 × 600 dpi (dots per inch)
Effective printing width	8.2" (208 mm) max.
PC print speed**	12 ppm (pages per minute) max.

*The yields may vary depending on coverage and operating conditions.

**Measured based on letter-size continuous printing (3rd through 14th page), excluding warm-up time.

Fax specifications

Memory capacity*	Approximately 600 average pages
Modem speed	33,600 bps with auto fallback to lower speeds.
Transmission time*	Approx. 3 seconds
Compatibility	ITU-T (CCITT) Super G3, G3 mode
Compression scheme	MR, MH, MMR
Applicable telephone line	Public switched telephone network

Reception modes	AUTO, MANUAL
Scanning Resolution	Horizontal: 203 lines/inch (8 lines/mm) Vertical: Standard: 98 lines/inch (3.85 lines/mm) Fine /Halftone: 196 lines/inch (7.7 lines/mm) Super fine: 391 lines/inch (15.4 lines/mm)
Halftone (grayscale)	64 levels
Contrast control	Automatic/Dark selectable

*Based on Sharp Standard Chart at standard resolution, excluding time for protocol signals (i.e., ITU-T phase C time only).

Network and general specifications

Automatic document feeder	Letter/A4: 30 sheets max. (20-lb. paper) Legal: 5 sheets max.
Input document size	Automatic feeding: Width: 5.8" to 8.5" (148 to 216 mm) Length (30 sheets): 5.5" to 11" (140 to 279 mm) Length (5 sheets): 5.5" to 14" (140 to 356 mm) Manual feeding: Width: 2.75" to 8.5" (70 to 216 mm) Length: 5.5" to 14" (140 to 356 mm)
Effective scanning width	8.2" (208 mm) max.
Storable transmission destinations	Rapid Keys: 36 Speed Dial numbers: 114
Telephone function	Yes (cannot be used if power fails)
Copy function	Single/Multi/Sort (up to 99 copies per page)
Network interface	10 Base-T, 100 Base-TX
Network frame type	IEEE802.2/IEEE802.3 Ethernet II
Network protocol	TCP/IP
Scan to E-mail	Yes
Scan to Network Folder	Yes

Global Address Search	Yes (requires LDAP server)
User authentication	Yes
File formats	TIFF (G4), PDF (G4)
Supported operating systems (printer driver)	Windows® 2000, XP, Server 2003, Vista
Display	LCD display, 20 digits x 2 lines
Power requirements	120 V AC, 60 Hz
Power consumption	Standby: 8.2 W when not connected to a network 8.6 W when connected to a network Maximum: 690 W
Operating temperature	50 - 86°F (10 - 30°C)
Humidity	20 - 85% RH
Dimensions (without attachments)	Width: 16.8" (426 mm) Depth: 16.1" (410 mm) Height: 8.2" (208 mm)
Weight (with attachments)	Approx. 15.6 lbs. (7.1 kg)

As a part of our policy of continuous improvement, SHARP reserves the right to make design and specification changes for product improvement without prior notice. The performance specification figures indicated are nominal values of production units. There may be some deviations from these values in individual units.

Important: This machine is not designed for use on a line which has call waiting, call forwarding, or certain other special services offered by your telephone company (errors may occur during transmission and reception of faxes).

This machine is not compatible with digital telephone systems.

Important safety information

Do not disassemble this machine or attempt any procedures not described in this manual. Refer all servicing to qualified service personnel.

Do not install or use the machine near water, or when you are wet. For example, do not use the machine near a bath tub, wash bowl, kitchen sink or laundry tub, in a wet basement, or near a swimming pool. Do not spill any liquids on the machine.

Unplug the machine from the power outlet and telephone jack and consult a qualified service representative if any of the following situations occur:

- Liquid has been spilled into the machine or the machine has been exposed to rain or water.
- The machine produces odors, smoke, or unusual noises.
- The power cord is frayed or damaged.
- The machine has been dropped or the housing damaged.

Do not allow anything to rest on the power cord, and do not install the machine where people may walk on the power cord.

This machine must only be connected to a 120 V, 60 Hz, grounded (3-prong) outlet. Connecting it to any other kind of outlet will damage the machine and invalidate the warranty.

Never insert objects of any kind into slots or openings on the machine. This could create a risk of fire or electric shock. If an object falls into the machine that you cannot remove, unplug the machine and consult a qualified service representative.

Do not place this machine on an unstable cart, stand or table. The machine could be seriously damaged if it falls.

Never install telephone wiring during a lightning storm.

Never install telephone jacks in wet locations unless the jack is specifically designed for wet locations.

Never touch bare telephone wires or terminals unless the telephone line has been disconnected at the network interface.

Use caution when installing or modifying telephone lines.

Avoid using a telephone (other than a cordless type) during an electrical storm. There may be a remote risk of electric shock from lightning.

Do not use a telephone to report a gas leak in the vicinity of the leak.

The power outlet must be installed near the equipment and must be easily accessible.

Trademark information

- Microsoft, Windows and Internet Explorer are trademarks of Microsoft Corporation in the U.S.A. and other countries.
- Acrobat and Adobe are trademarks of Adobe Systems Incorporated.
- Datalight is a registered trademark of Datalight, Inc.
FlashFX™ is a trademark of Datalight, Inc.
Copyright 1993 - 2004 Datalight, Inc. All Rights Reserved.
U.S. Patent Office 5.860.082/6.260.156
- OpenLDAP is a registered trademark of the OpenLDAP Foundation.
Copyright 1999 - 2003 The Open LDAP Foundation, Redwood City, California, U.S.A. All rights reserved.
- This product includes software developed by Computing Services at Carnegie Mellon University (<http://www.cmu.edu/computing/>). Copyright (c) 1998 - 2003. Carnegie Mellon University. All rights reserved.
- All other company names and product names appearing in this manual are the trademarks of their respective owners.

A Look at the Operation Panel

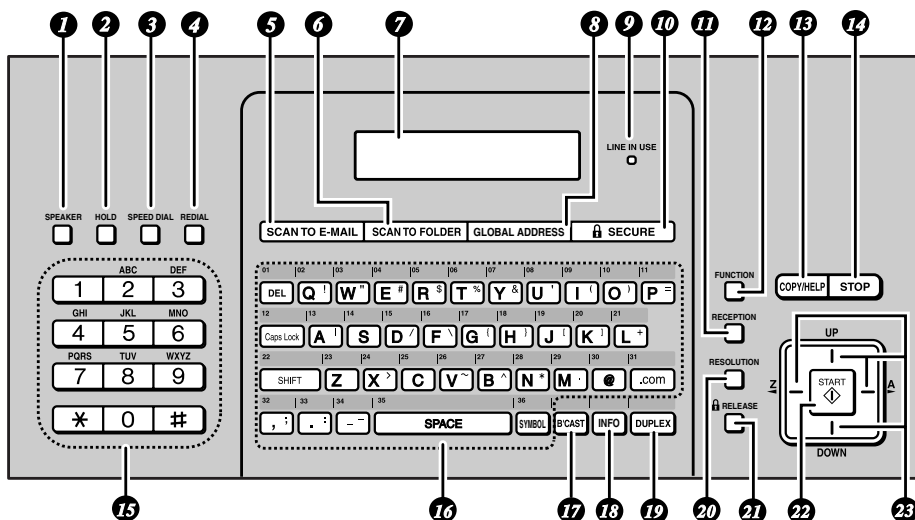

Note: Affix the Rapid Key labels as shown above.

- 1 SPEAKER key**
Press to listen to the line and fax tones through the speaker when faxing (p. 57).
Note: **This is not a speakerphone.** It cannot be used for speaking.
- 2 HOLD key**
Press to put a phone call on hold (p. 70).
- 3 SPEED DIAL key**
Press to select a fax, e-mail, or network folder destination stored in a 3-digit Speed Dial number (pp. 37, 64).
- 4 REDIAL key**
Press to automatically redial the last number dialed (p. 66). This can also be used to enter a pause when storing a fax number for automatic dialing (p. 61).
- 5 SCAN TO E-MAIL key**
Press to send a document to an e-mail recipient (p. 42).
- 6 SCAN TO FOLDER key**
Press to send a document to a folder on a computer on the same network as the machine, or to an FTP server (p. 50).

A Look at the Operation Panel

- 7 Display**
This displays messages and prompts to help you operate the machine.
- 8 GLOBAL ADDRESS key**
Press to search for a destination in a global address book on an LDAP server (p. 126).
- 9 LINE IN USE light**
This lights up when the machine is using the phone line to send or receive a fax.
- 10 SECURE key**
Press to set up and use the security functions of the machine (p. 71).
- 11 RECEPTION key**
Press to select the reception mode (AUTO or MANUAL) for receiving faxes. The selected mode will appear in the display (p. 27).
- 12 FUNCTION key**
Press this key followed by the arrow keys to select special functions and settings.
- 13 COPY/HELP key**
When a document is in the feeder, press to make a copy (p. 109). At any other time, press to print the Help List.
- 14 STOP key**
Press to cancel an operation before it is completed.
- 15 Number keys**
Use these keys to dial fax numbers, and enter numbers when storing transmission destinations.
- 16 Rapid Keys / letter keys**
A fax number, e-mail address, or network folder can be stored in each of these keys for one-touch selection (attach the Rapid Key labels). When entering text, the keys are used as letter keys.
- 17 BROADCAST key**
Press to send to multiple fax or e-mail destinations (p. 111).
- 18 INFO key**
Press to check various types of machine information.
- 19 DUPLEX key**
Use to scan two-sided documents for transmission and copying (p. 119).

A Look at the Operation Panel

20

RESOLUTION key

When a document is in the feeder, press to adjust the scanning resolution for transmission (p. 55).

21

RELEASE key

When a fax has been received to memory instead of being printed out because the Secure Fax function has been activated, press this key to enter the Secure code and print out the fax (p. 84).

22

START key

Press after dialing to send a fax (p. 57).

23



Arrow keys

Use to scroll through and select settings, and to search for stored destinations.

A Look at the Operation Panel

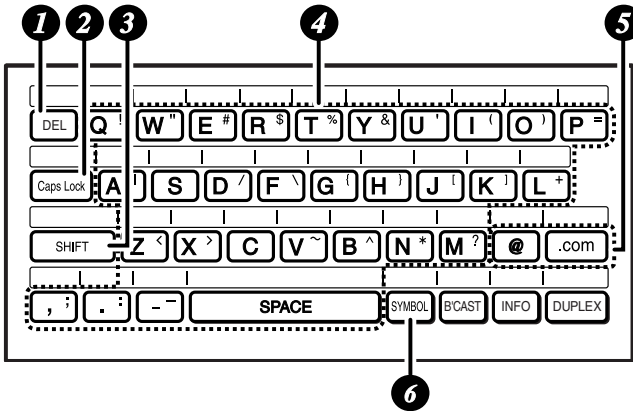
Letter keys



- 1 DEL key**
Press to delete the character marked by the cursor (the cursor can be moved by pressing  or ). When the cursor is to the right of a line of text, press to backspace and clear characters. To delete all entered characters, hold down until all characters are cleared.
- 2 Caps Lock key**
Press to enter upper case letters. Press again to return to lower case letter entry.
- 3 SHIFT key**
Hold down while pressing a letter key to temporarily change case.
- 4 Letter keys**
Use to enter letters.
- 5 @key, .com key**
Press to conveniently enter “@” and “.com” when entering an e-mail address.
- 6 SYMBOL key**
Hold down while pressing a letter key to enter the symbol that appears on the right side of the key.

1. Installation

Unpacking Checklist

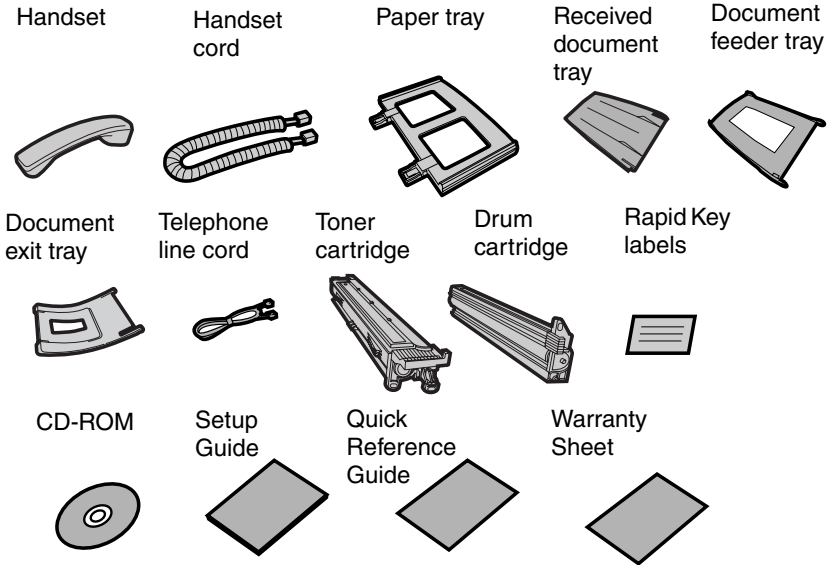

Points to keep in mind when setting up

- ◆ Do not place the machine in direct sunlight.
- ◆ Do not place the machine near heaters or air conditioners.
- ◆ Keep dust away from the machine.
- ◆ Keep the area around the machine clear.

About condensation

If the machine is moved from a cold to a warm place, condensation may form on the scanning glass, preventing proper document scanning. To remove the condensation, turn on the power and wait approximately two hours before using the machine.

Basic Setup

Basic Setup

Connecting the handset

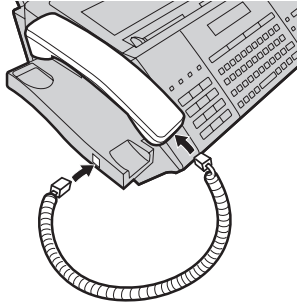

Attaching the trays

Attach the paper tray.

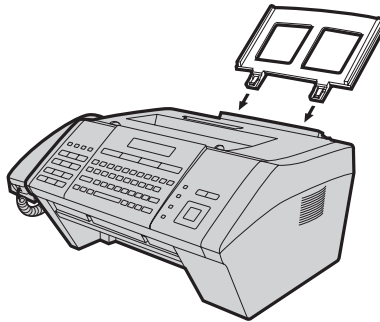

Attach the document feeder tray and the received document tray.

Insert the trays
at an angle and
rotate back

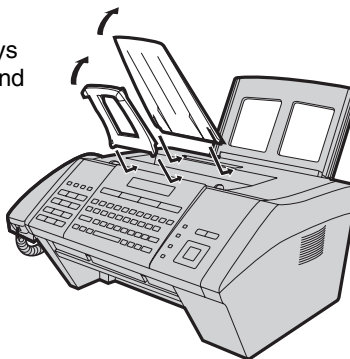

Attach the document exit tray.

After inserting the tray, flip out the extension

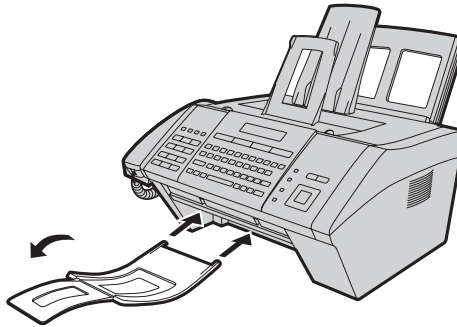

Connecting the power cord

Plug the power cord into a 120 V, 60 Hz, grounded AC (3-prong) outlet.

- ◆ Do not plug the power cord into any other kind of outlet. This will damage the machine and is not covered under the warranty.

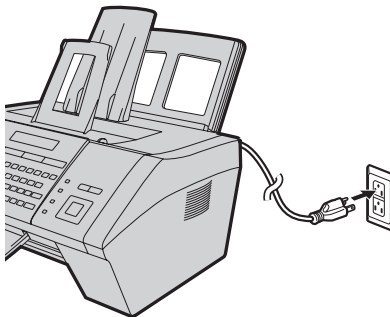

Comments:

- ◆ The machine does not have a power on/off switch. The power is turned on and off by simply plugging in or unplugging the power cord.
- ◆ Whenever you unplug the power cord, wait at least 5 seconds before plugging it back in.
- ◆ If your area experiences a high incidence of lightning or power surges, it is recommended that you install surge protectors for the power and telephone lines. Surge protectors can be purchased from your dealer or at most telephone specialty stores.

Basic Setup

Connecting the telephone line cord

Insert one end of the line cord into the socket on the back of the machine marked **TEL. LINE**. Insert the other end into a wall telephone socket.

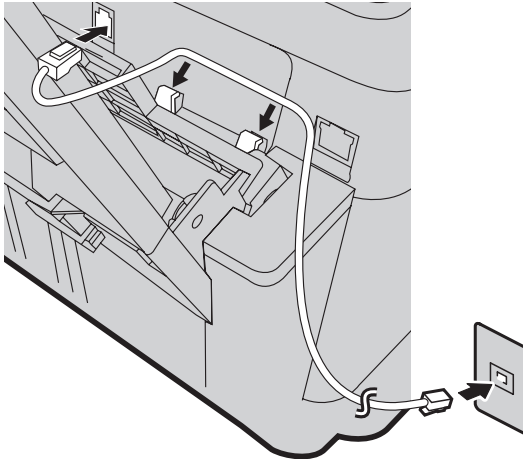

The machine is initially set for tone dialing. If you are on a pulse dial line, change the "DIAL MODE" setting (pp. 136 and 137).

Important:

- ◆ The facsimile function of this machine is not designed for use on a line which has call waiting, call forwarding, or certain other special services offered by your telephone company. If you attempt to use the facsimile function in conjunction with any of these services, you may experience errors during transmission and reception of facsimile messages.
- ◆ The facsimile function of this machine is not compatible with digital telephone systems.

Affixing the Rapid Key labels

Affix each strip of Rapid Key labels above each row of letter keys as shown in the panel illustration on page 9.

Connecting the machine to your network

To use the Scan to E-mail and Scan to Folder functions, and to use the machine as a printer, you must connect the machine to an Ethernet network. In addition, to use Scan to E-mail, the network must have an Internet connection. A typical setup is shown below.

The machine is connected using an Ethernet cable (not included). Please purchase a 10Base-T/100Base-TX straight-through (regular) cable.

Connect one end of the cable to the LAN port on the machine. Connect the other end to a LAN port on your switch or hub.

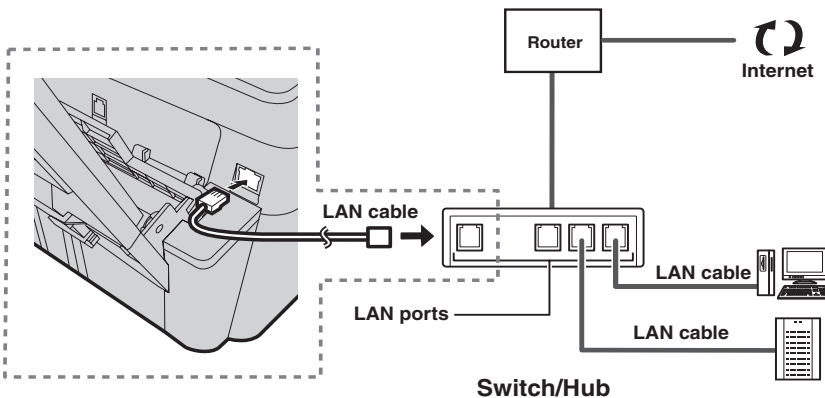

- ◆ If you are uncertain which port to connect the cable to, see the manual for the router, switch or hub.
- ◆ The connections can be made with all devices powered on.

To communicate on your network, the machine must have an IP address. To set the machine's IP address and configure other network settings, see page 29.

Installing the Toner Cartridge and Drum Cartridge

Installing the Toner Cartridge and Drum Cartridge

The laser printer in the machine uses a toner cartridge and a drum cartridge.

- ◆ The starter toner cartridge included with the machine can print approximately 1500 letter-size pages at 5% page coverage.
- ◆ When replacing the toner cartridge, use a **SHARP FO-25ND** toner cartridge. One cartridge can print about 3000 letter-size pages at 5% coverage.
- ◆ The drum cartridge (both starter and replacement) can print approximately 20,000 letter-size pages. When replacing the drum cartridge, use a **SHARP FO-25DR** drum cartridge.

Follow the steps below to install the toner cartridge and the drum cartridge.

Note: The quality of the toner cartridge is guaranteed for 18 months after the date of manufacture indicated on the package. The quality of the drum cartridge is guaranteed for 24 months after the date of manufacture indicated on the package.

1 Open the top cover of the machine.

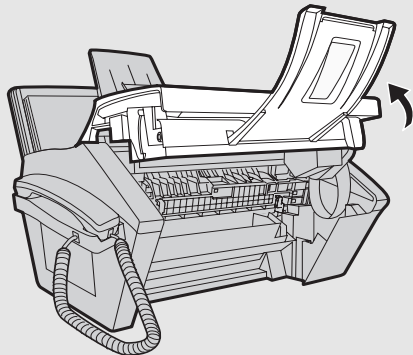

- **Caution!**

The fusing unit inside the print compartment becomes very hot during operation. Do not touch the inside of the print compartment after the machine has been in operation.

Installing the Toner Cartridge and Drum Cartridge

- 2** Press the release (❶) and open the front cover (❷).

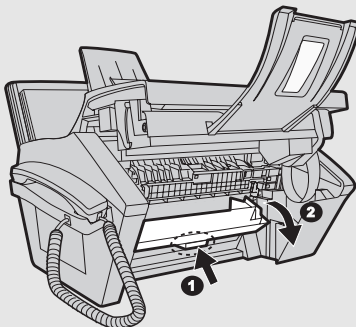

- 3** Open the side cover.

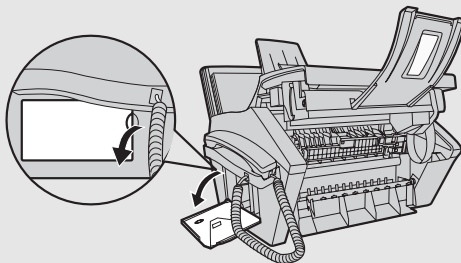

- 4** Remove the new drum cartridge from its packaging.

Installing the Toner Cartridge and Drum Cartridge

- 5** Insert the drum cartridge into the print compartment, sliding it along the guides.

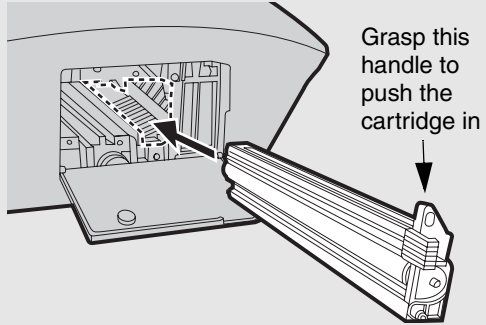

- Do not touch or allow other objects to contact the drum (the green cylinder). This may damage the drum. If fingerprints, dust, or other contaminants get on the drum, wipe it gently with a clean cloth.
- Exposure to light for more than several minutes will damage the drum. Be sure to insert the drum cartridge promptly into the machine.
- If you find it necessary to leave the cartridge out of the machine for more than several minutes, wrap the cartridge in black paper.

- 6** Remove the new toner cartridge from its packaging. Shake the cartridge side to side four or five times to distribute the toner evenly within the cartridge.

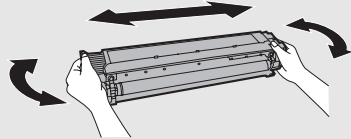

7 Grasp the cartridge handle and insert the toner cartridge into the print compartment, sliding it along the guides.

- Make sure the cartridge “clicks” into place.
- Do not touch the roller in the toner cartridge.

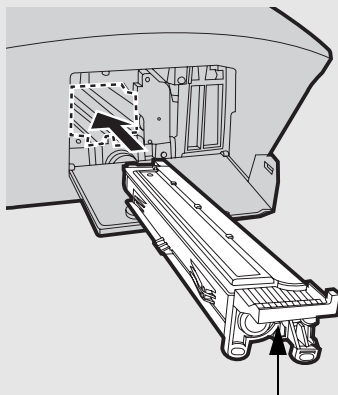

Grasp this handle to insert the cartridge

8 Close the side cover (❶), the front cover (❷), and the top cover (❸).

- When closing the side cover, press on the dots to make sure the cover is completely closed. Otherwise, light may enter the print compartment and damage the drum.
- The display will show:
[TONER EXCHANGED?] /
[1 = NEW, 2 = OLD]

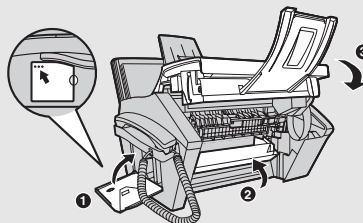

9 If you installed a new toner cartridge, press to select NEW (this will reset the toner counter to zero).

- If you temporarily removed and then replaced an old toner cartridge for maintenance or other reason, press to continue using the previous toner count. (Note: Be sure to press or the machine will not alert you when the toner cartridge is out of toner.)

Installing the Toner Cartridge and Drum Cartridge



10 Press  .

11 If you installed a new drum cartridge, reset the drum counter as explained below.

Resetting the drum counter

Each time you install a new drum cartridge, follow the steps below to reset the drum counter to zero.

1 Press  and then  until [LIFE] appears in the display.



2 Press  , then  until [CLEAR DRUM COUNTER] appears.

3 Press  .

Manually resetting the toner counter

When a new toner cartridge is installed, the toner counter is reset in Step 9 on the previous page. The procedure below is normally not necessary; however, it can be used in the event that you need to reset the toner counter manually.

1 Press  and then  until [LIFE] appears in the display.

2 Press  , then  until [CLEAR TONER COUNTER] appears.

3 Press  .

Loading Printing Paper

You can load letter or legal size paper in the paper tray.

Maximum number of sheets

(20-lb. copy bond paper at room temperature)

Letter size: Approx. 250 sheets

Legal size: 100 sheets

Caution!

Do not use the blank side of paper that has already been printed on.

- 1 Fan the paper, and then tap the edges against a flat surface to even the stack.**

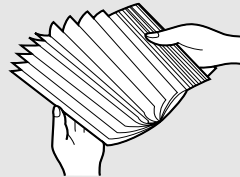

- 2 Pull the paper plate forward ①. Squeeze the paper guide and adjust it to the width of the paper ②. Insert the stack of paper into the tray, print side up ③.**



The maximum stack height should not be higher than the line on the paper guide

- 3 Push the paper plate back.**

- If you loaded legal size paper (or you changed the paper size), change the paper size setting as explained on pages 136 and 140.

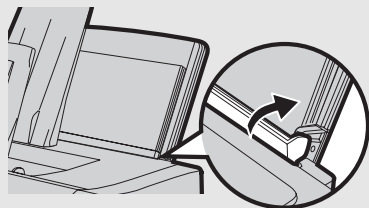



Entering Your Name and Fax Number

Entering Your Name and Fax Number

Enter your name and fax number.



- ◆ Your entered name and fax number will be printed automatically at the top of all fax pages you send. (This is required by FCC regulations.)

1 Press  , then  until [ENTRY MODE] appears in the display.

2 Press  .
Display: [OWN NUMBER SET]

3 Press  . [ENTER FAX #]

4 Enter your fax number by pressing the number keys (max. 20 digits).

- To insert a space between digits, press  .
- To clear a mistake, press  .

5 Press  .

6 Enter your name using the letter keys (max. 24 characters).

Example: SHARP

      =

- To clear a mistake, press  .
- For information on using the letter keys, see page 12.

7 Press  . [DATE&TIME SET]



8 Press  to exit.

Setting the Date and Time

Set the date and time as explained below.

- ◆ The date and time will be printed automatically at the top of all fax pages you send (this is required by FCC regulations). The date and time also appear in the display.
- ◆ To have the clock automatically move forward and backward at the beginning and end of daylight-saving time, turn on the “DAY LIGHT SAVING” setting (pp. 136 and 139). Do this **before** you set the date and time.

1 Press  , then  until [ENTRY MODE] appears.

2 Press  , then  until [DATE & TIME SET] appears.

3 Press .

- The currently set date appears (example): [DATE 08-15-2007]

4 Enter a two-digit number for the month (“01” for January, “02” for February, “12” for December, etc.).

Example: January
[DATE 01-15-2007]

- To correct a mistake, press  to move the cursor back to the mistake and enter the correct number.

5 Enter a two-digit number for the day (“01” to “31”).

Example: the 5th
[DATE 01-05-2007]

Setting the Date and Time

6 Enter the year (four digits).

Example: 2007

- The currently set time appears (example): [TIME 12:19 PM]

7 Enter a two-digit number for the hour (“01” to “12”) and a two-digit number for the minute (“00” to “59”).

Example: 9:25
[TIME 09:25 PM]

8 Press to select A.M. or to select P.M.

9 Press to start the clock.
[ANTI JUNK #]

10 Press to exit.

Setting the Reception Mode

The machine has two modes for receiving incoming faxes:

AUTO mode:

Select this mode when you only want to receive faxes on the line connected to the machine. The machine will automatically answer all calls on 4 rings and begin fax reception.

MANUAL mode:

Select this mode when you want to receive both phone calls and faxes on the line connected to the fax machine. **All calls, including faxes, must be answered by picking up the fax machine's handset** or an extension phone connected to the same line.

To set the reception mode, press ^{RECEPTION} until the desired mode appears in the display ("AUTO" or "MANU").

For more information on receiving faxes, see Chapter 4.

Volume Adjustment

You can adjust the volume of the speaker, handset, and ringer using the up and down arrow keys.

Speaker volume

1 Press ^{SPEAKER} .

2 Press  or  to select **HIGH**, **MIDDLE**, or **LOW**.

- To turn off the speaker, press ^{SPEAKER} again.

Volume Adjustment

Handset

1 When talking through the handset, press  or  to select HIGH, MIDDLE, or LOW.

- **Note:** The volume reverts to MIDDLE each time you replace the handset.

Ringer

1 Press  or  to select HIGH, MIDDLE, LOW or OFF.

(Make sure  has not been pressed, the handset is not lifted, and a document is not loaded in the feeder.)

- The ringer will ring once at the selected level.

2 If you selected “OFF OK ?” to turn off the ringer, press .

2. Network Scanning

Setting up Network Scanning

Introduction

The network scanning feature lets you scan a document and directly send the image file to an e-mail recipient (Scan to E-mail), or to a folder on a computer on your network (Scan to Folder).

- ◆ The scanned file can be in TIFF or PDF format.
- ◆ Scan to E-mail saves you the trouble of scanning a document into a computer and sending the scanned file using an e-mail program. The scanned document is automatically sent as an attachment to an e-mail message.

To use network scanning, the machine must be connected to an Ethernet network as explained on page 17.

IP address

The machine requires an IP address to in order to communicate on your network and the Internet.

If your network is set up to automatically assign IP addresses, you do not need to do anything; the machine will automatically receive an IP address when it is connected.

If your network requires that a static (permanent) IP address be assigned to the machine, see *Network Settings* on page 46 to enter the IP address and related information.



Setting up Network Scanning

Checking your IP address and the connection

To check the machine's IP address and verify that the machine is able to communicate on the network, follow these steps.

1 Press **INFO**, then  until **[NETWORK INFORMATION]** appears.

2 Press .

- If the machine has automatically received an IP address and is able to communicate, **[IP ADDRESS/DHCP: ON]** will appear on the top line of the display, followed by the IP address on the bottom line. To show the machine's host name, press .
- If a static IP address has been entered in the machine and the machine is able to communicate, **[IP ADDRESS/DHCP: OFF]** will appear on the top line of the display, followed by the IP address on the bottom line. To show the machine's host name, press .
- If the machine was unable to receive an IP address automatically, or if the router locked up after the machine received an IP address, **[IP ADDRESS/DHCP: FAIL] / [192.168. 1 .201]** will appear. "192.168. 1 .201" is an IP address that is assigned to the machine for diagnostic purposes when connection fails (it cannot be used for regular communication).
- If **[NOW CONNECTING / CHECK LATER]** appears, press **STOP** to exit. This message will appear if a cable is not connected or the machine has not yet established communication on the network. Make sure a cable is correctly connected, wait briefly, and then repeat the procedure again.

If the machine is unable to communicate...

- ◆ Check the Ethernet cable. Are the connections secure? Are you using straight-through (not crossover) cable for 10Base-T/100Base-TX?
- ◆ There may be a problem in the router or other device to which the machine is connected. Try removing and then restoring the power to the router (see the manual for the router).
- ◆ If **[IP ADDRESS/DHCP: FAIL]** appears, remove and then reinsert the Ethernet cable plug, and then check the IP address again. If the same message appears, check the device that acts as the DHCP server on your network (try removing and restoring the power). If your router is your DHCP server, make sure that DHCP is enabled in the router settings. If your network does not have a DHCP server, set a static IP address as explained on page 46.
- ◆ If a static IP address has been set, make sure that the network settings (page 46) are correct .

Setting up Network Scanning

E-mail settings

Before the Scan to E-mail function can be used, you must configure the e-mail settings.

The e-mail settings specify your outgoing (SMTP) mail server, as well as your sender name, sender address, and other information that appears in the e-mail to which scanned image files are attached.

- ◆ The e-mail settings are configured in the machine's Web page. The machine's Web page can be accessed from any computer on the same network as the machine.

Accessing the machine's Web page

To access the Web page, you will need to know the machine's host name or IP address (usually it is most convenient to use the host name).

To check the machine's host name or IP address, follow the procedure in *Checking your IP address and the connection* (page 30), or print the Network Settings List (page 141).

Type in the host name or IP address of the machine in the address bar of your computer's Web browser. The machine's Web page will appear.

- ◆ For the Web browser, it is recommended that you use Internet Explorer 6.0 or higher.

Note: If the Web page is used while the machine is in operation, machine operation may become unstable.

If password protection has been enabled for the Web page...

If your administrator has enabled password protection for the Web page, you will need to enter the user name and password to open the Web page.

Regular users enter "user" in **User Name** and the user password in **Password**. (If you do not know the user password, ask your administrator.)

The administrator enters "admin" in **User Name** and the administrator password in **Password**.

Setting up Network Scanning

To open the Web page, enter the IP address or host name of the machine in your browser's address bar.

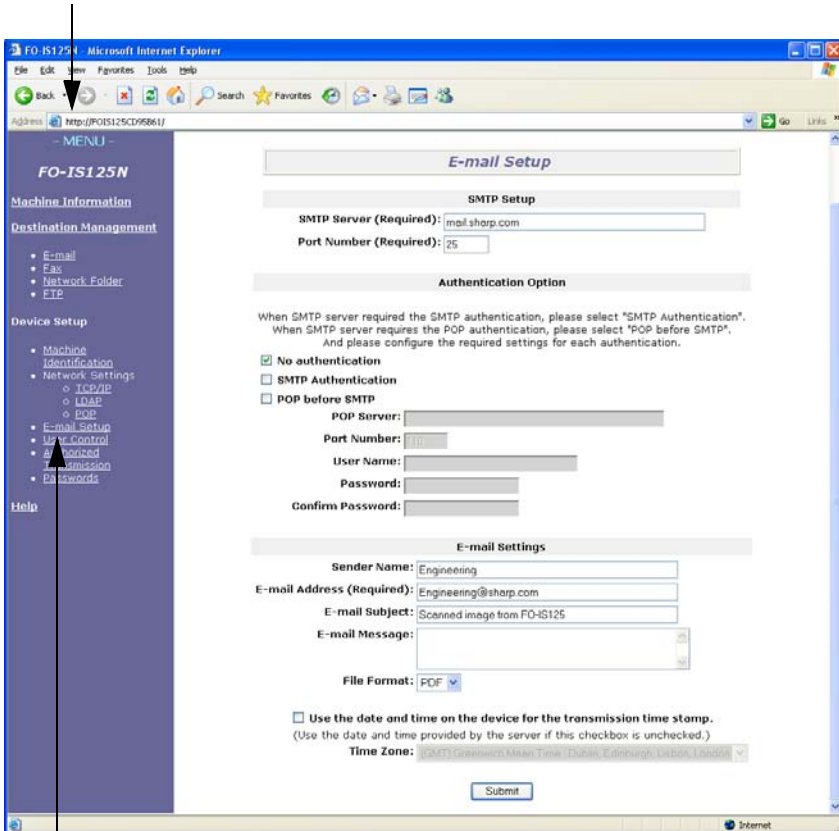

Click **E-mail Setup** to open the e-mail settings.

Configuring the e-mail settings in the Web page

Select **E-mail Setup** in the menu frame of the Web page to open the **E-mail Setup** screen.

Under **SMTP Setup**, enter the host name or IP address of your SMTP server in **SMTP Server**.

Setting up Network Scanning

For the **Port Number**, “25” is normally entered.

Under **Authentication Option**, select **No Authentication** if your SMTP server does not require authentication.

If your SMTP server requires SMTP authentication, select **SMTP Authentication** and enter your **User Name** and **Password**.

If your mail service requires POP before SMTP authentication, select **POP before SMTP** and enter the host name or IP address of your POP server in **POP Server**. Enter the **Port Number**, your **User Name**, and **Password**.

Under **E-mail Settings**, enter the **Sender Name** that you wish to have appear on e-mail sent from the machine, and the sender **E-mail Address**.

Note: The **E-mail Address** must be entered. This must be a valid e-mail address. Responses to e-mail sent from the machine and any undelivered mail reports will be sent to this address. It is normally convenient to use the e-mail address of the administrator of the machine or other person in charge of machine communication.







Enter an **E-mail Subject** and **E-mail Message**, and select the **File Format** used for the scanned image.

- ◆ The **Sender Name**, **E-mail Subject**, **E-mail Message**, and **File Format** that you enter in this screen are default settings. These settings will be used if the sender does not specify this information at the time of transmission.
- ◆ For further information on the settings in this screen, click **Help** in the menu frame.

Using the machine's operation panel to configure e-mail settings

The machine's operation panel can also be used to configure several of the e-mail settings.

The settings that can be configured on the machine's operation panel are shown in the table on the next page. Follow the steps below to display the e-mail settings, and then configure each setting as explained in the table.







- 1** Press  , then  until [E-MAIL SETTING] appears.
- 2** Press  , then  repeatedly until the setting that you wish to configure appears.
- 3** Press  . (Note: This step is not necessary for the "FILE FORMAT" setting.)
- 4** Enter the required information for the setting as explained in the table on the next page.
- 5** After configuring the setting, the next e-mail setting will appear in the display. You can configure the next setting, or press  to exit.

Setting up Network Scanning

E-mail settings on the machine's operation panel

The e-mail settings that can be configured on the machine's operation panel are shown below. Enter the required information for each setting as explained in the table (this is done in step 4 of the procedure on the previous page).

- ◆ The sender address is required (if not entered in the Web page). The other settings are optional.
- ◆ Use the letter keys to enter text. For information on using the letter keys, see page 12.
- ◆ The e-mail subject, e-mail message, and file format that are entered below are default settings. They will be used if you do not specify these items at the time of transmission.

Setting	Description
SENDER NAME	Enter the sender name that will appear in the e-mail message (max. of 50 characters). When finished, press  .
SENDER ADDRESS	Enter your sender e-mail address (max. of 128 characters). When finished, press  . (Note: Be sure to enter a valid e-mail address. Return e-mail and undelivered mail reports will be sent to this address. In addition, some SMTP servers reject outgoing e-mail if a valid sender e-mail address is not entered.)
E-MAIL SUBJECT	Enter a default subject (max. of 128 characters). When finished, press  .
E-MAIL MESSAGE	Enter a default message (max. of 256 characters). When finished, press  .
FILE FORMAT	This sets the default format for scanned files sent by directly entering an e-mail address, or by broadcasting. Press  for TIFF or  for PDF. Initial setting: TIFF

Storing E-mail Addresses

You can store e-mail addresses in Rapid Keys and Speed Dial numbers.

- ◆ An e-mail address stored in a Rapid Key is selected by simply pressing that key. A total of 36 Rapid Keys are available.
(Note: Attach the Rapid Key labels as shown on page 9.)
- ◆ An e-mail address stored in a Speed Dial number is selected by pressing
SPEED DIAL and entering the 3-digit Speed Dial number. A total of 114 Speed Dial numbers are available.

E-mail addresses can be stored using the machine's Web page or the operation panel.

Using the Web page to store e-mail addresses

Open the machine's Web page as explained on page 32.

To view a list of the Rapid Keys and Speed Dial numbers already in use, click **Destination Management** in the menu frame. The screen below will appear.

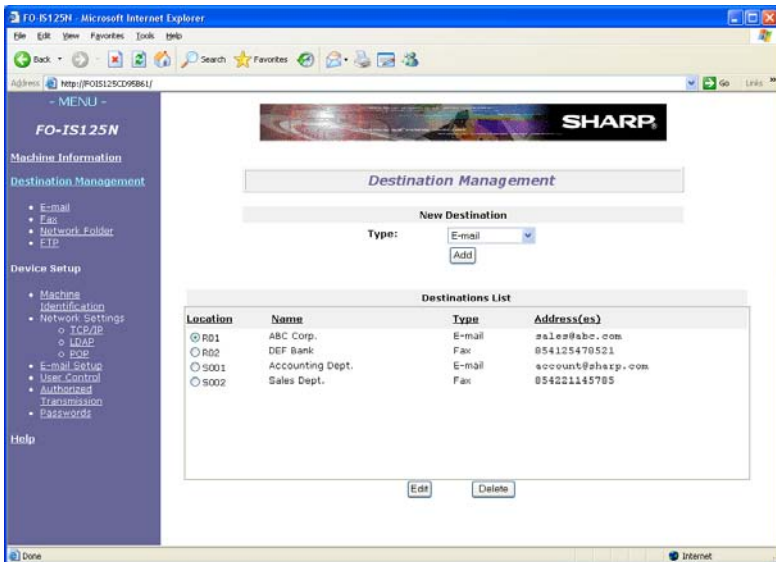

Storing E-mail Addresses

To store a new e-mail address, click **E-mail** under **Destination Management** in the menu frame. The screen below will appear.

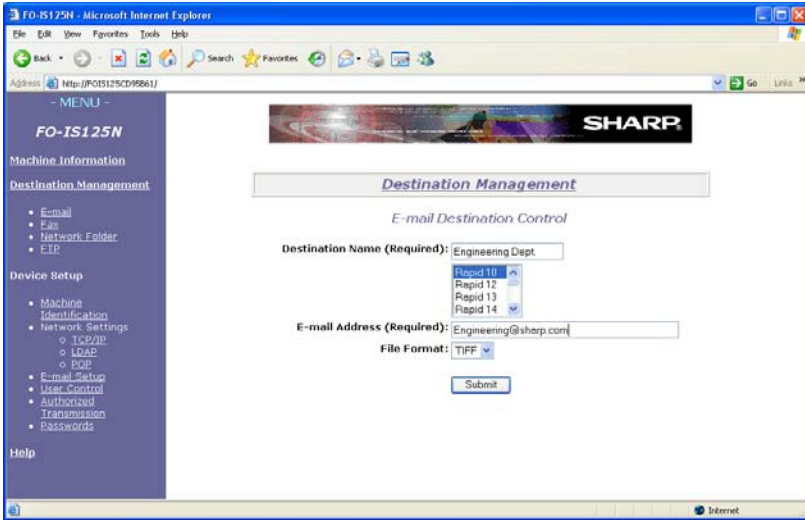

Enter the name of the destination in **Destination Name** and select the Rapid Key or Speed Dial number that you wish to use from the list. Type in the **E-mail Address** of the destination and select the **File Format** of the scanned image. (The file format selected here is a default format that will be used if a file format is not specified at the time of transmission.)

When finished, click **Submit**.

Editing or deleting a destination in the Web page

To edit or delete a previously stored destination, select the destination in the **Destinations List** and then click **Edit** or **Delete**.

Using the operation panel to store e-mail addresses

Follow the steps below to store an e-mail address using the machine's operation panel.

1 Press **FUNCTION**  then .

2 To store a number in a Rapid Key, press the desired Rapid Key.

To store a number in a Speed Dial number, press **SPEED DIAL**  and enter the desired Speed Dial number (the number must be 3 digits: enter "001" for Speed Dial 1, "010" for Speed Dial 10, etc.).

Display: [SELECT DEST. TYPE]

- If you prefer to have the machine suggest an available Rapid Key / Speed Dial number at the end of the procedure, press .

3 Press  to select "E-MAIL".
Display: [E-MAIL # MODE]

4 Enter the e-mail address with the letter and number keys (max. of 128 characters).

- To clear a mistake, press .
- For information on using the letter keys, see page 12.

5 Press .

6 Enter the name of the destination (max. 20 characters).

7 Press 
Display: [FILE FORMAT]

Storing E-mail Addresses

8 Select the default file format that will be used for scanned images if the user does not specify a format at the time of transmission. Press to select TIFF, or to select PDF.

9 If you selected a Rapid Key or Speed Dial number in Step 2, the display will briefly show [STORED], and then [NEW NUMBER]. Go to Step 10. If you did not select a Rapid Key or Speed Dial number in Step 2, the display will show the next available Rapid Key or Speed Dial number. If that number is acceptable, press and go to Step 10. If not, press the desired Rapid Key, or press and enter the desired 3-digit Speed Dial number, and go to Step 10.

10 Return to Step 2 to store another e-mail address, or press to exit.



Editing and clearing stored destinations

To make changes to a previously stored destination, or clear a destination, follow these steps:

1 Press then .

2 Select the destination that you wish to edit or delete using one of the methods below:

- **Rapid Key:** If the destination is stored in a Rapid Key, press the Rapid Key.
- **Speed Dial:** If the destination is stored in a Speed Dial number, press and enter the 3-digit Speed Dial number with the number keys (enter "001" for Speed Dial 1, "010" for Speed Dial 10, etc.).



- **Search:** Press  or  until the destination appears in the display and press .

Display: [1=EDIT, 2=CLEAR]

3 Press for “EDIT” or for “CLEAR”.

- If you pressed  for “CLEAR”, press  and go to Step 9.

4 If you selected “EDIT”, make the desired changes to the e-mail address.

- Press  or  to move the cursor to the character(s) you wish to change, and then press the appropriate letter or number key. The new character will replace the old character. You can also press  to backspace and clear characters.
- If you do not wish to change the address, go directly to Step 5.

5 Press .

6 Make the desired changes to the name.

- If you do not wish to change the name, go directly to Step 7.

7 Press .

Display: [FILE FORMAT]

8 Select the default file format that will be used for scanned images if the user does not specify a format at the time of transmission. Press to select TIFF, or to select PDF.

9 Return to Step 2 to edit or clear another destination, or press .

Scan to E-mail Transmission

Follow the steps below to send a scanned document or image to an e-mail recipient.

- ◆ The document will be sent as a file attachment to an e-mail message.
- ◆ You can specify the recipient by directly entering an e-mail address, or by selecting an address that has been stored as explained in the previous section.

-
- 1** Adjust the document guides to the width of your document.

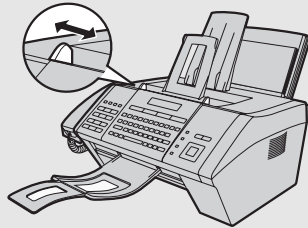



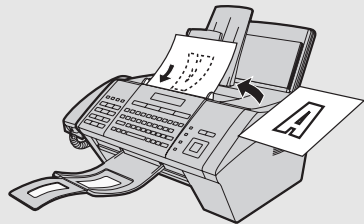

-
- 2** Insert the document face down in the document feeder. The top edge of the document should enter the feeder first.

- SEND READY will appear in the display.
- Up to 30 letter-size sheets (5 legal-size sheets) can be placed in the feeder at once.
- For more information on loading the document, see page 53.
- If desired, press ^{RESOLUTION} to set the resolution and contrast (see p. 55). (The default resolution for Scan to E-mail is FINE.)





3 Enter the destination e-mail address using one of the following methods:

- Press , and enter the address with the letter and number keys (p. 12). When finished, press .
- If the address has been stored in a Rapid Key, press the Rapid Key.
- If the address has been stored in a Speed Dial number, press  and enter the Speed Dial number.
- To search for a stored address, press (this eliminates stored fax numbers from the search), press  or  until the name or address appears, and press .





Note: If [CHECK E-MAIL SETTING] appears, your SMTP server or sender address has not been entered in the e-mail settings (p. 32).



4 If you need to select or change any of the e-mail options, press and go to Step 5 below. (Note that settings selected here are temporary. To make permanent changes, see p. 32.) If you do not wish to change the e-mail options, go directly to Step 7.

5 Press or until the desired option appears, and press (is not necessary for the FILE FORMAT setting). Change the option as explained below (use the letter keys to enter text and to delete text; p. 12).

- E-MAIL SUBJECT: Enter a subject (max. 128 characters). When finished, press .
- E-MAIL MESSAGE: Enter a message (max. 256 characters). When finished, press .

Scan to E-mail Transmission

- **FILE FORMAT:** Select the format of the scanned image file. Press  for TIFF or  for PDF. (Make sure the recipient has an image viewer that can show images in the selected format.)
- **FILE NAME:** To use an automatically generated file name for the scanned file, press  (AUTO). To assign a custom name, press  (CUSTOM), enter the desired name with the letter keys (max. 40 characters), and press .

6 When you have finished configuring the e-mail options, press  or  until the display shows [PRESS START TO SCAN].

7 Press  to begin transmission.

Note: The recipient may have security settings in their e-mail program or virus protection software that prevent the file attachment from being received or opened. In this case, ask the recipient to try changing the settings.

Error messages

If transmission is not successful because the machine is unable to connect to your mail server, one of the following error messages will appear.

[CONNECTION ERROR]

This appears when communication does not take place correctly on your local network, usually due to a problem with the cable connections. Make sure that the cable ends are securely inserted in the LAN ports. Make sure that the correct cable is being used and that the cable is good. Make sure that your router or hub is powered on.

[SERVER ERROR]

This appears when the machine cannot connect to your mail server or there is no response from the mail server. Make sure the SMTP server setting is correct (p. 32). If you have configured "POP before SMTP" settings in the Web page, make sure these settings are correct.

[SERVER NOT FOUND] / [SMTP]

This appears when an incorrect host name is entered for your SMTP server. Check the SMTP server setting (p. 32).

[SERVER NOT FOUND] / [DHCP]

This appears when the machine is unable to automatically obtain an IP address. Restart your router or other device that acts as your DHCP server.

[CABLE DISCONNECTED]

This may appear below any of the above messages. Check the same items as in [CONNECTION ERROR] above.

If an undelivered mail report is sent to inform you that your e-mail message was not successfully delivered, the report will be sent to the sender address entered in the e-mail settings (page 32).



Network Settings

Network Settings

If your network requires that you assign a static (permanent) IP address to the machine, follow the steps below to disable DHCP (automatic IP address assignment) and configure the network settings.

- ◆ Consult your network administrator for the information that must be entered. After DHCP is disabled, the settings that must be configured appear in the following order (these settings only appear when DHCP is set to NO):



IP ADDRESS
SUBNET MASK
DEFAULT GATEWAY
DNS (PRIMARY)
DNS (SECONDARY)

1 Press  , then  until [NETWORK SETTING] appears.

2 Press  .
[DHCP] will appear.

3 Press  for NO (the machine will not obtain an IP address automatically).

- [IP ADDRESS] will appear.

(If you wish to configure a different setting, press  or .)

4 Press  .

5 Press the number keys to enter the required number.

- Three digits must be entered in each segment of the number (the segments are separated by periods). If a segment does not have 3 digits, enter zeros as needed.

Example: IP address = 192.168.1.2

You must enter: 192.168.001.002

- If you make a mistake, press  to move the cursor to the mistake and enter the correct number.



6 When finished entering the number, press .

7 The next setting will appear in the display. Repeat Steps 4 through 6 to configure the next setting, or press  to exit.

Initializing the network settings

If you need to return the network settings to their initial state, follow the steps below.

- ◆ Initializing the settings enables DHCP and clears the IP address and related settings.

1 Press  , then  until [NETWORK SETTING] appears.

2 Press  , then  until [INITIALIZE SETTINGS] appears.

3 Press  .
Display: [INITIALIZE SETTINGS] / [IF OK, PRESS START]

4 Press .

Scan to Folder / FTP

You can also scan and send a document directly to a folder on a computer on your network, or to an FTP server.

To use this feature, you must first store the destination in a Rapid Key or Speed Dial number. Follow the appropriate procedure below to store a Scan to Folder destination or FTP destination.

- ◆ Scan to Folder and FTP destinations can only be stored using the machine's Web page. A maximum of 12 Scan to Folder destinations and 12 Scan to FTP destinations can be stored.

Storing a Scan to Folder destination

To store a Scan to Folder destination, open the machine's Web page as explained on page 32.

Click **Network Folder** under **Destination Management** in the menu frame. The screen below will appear.

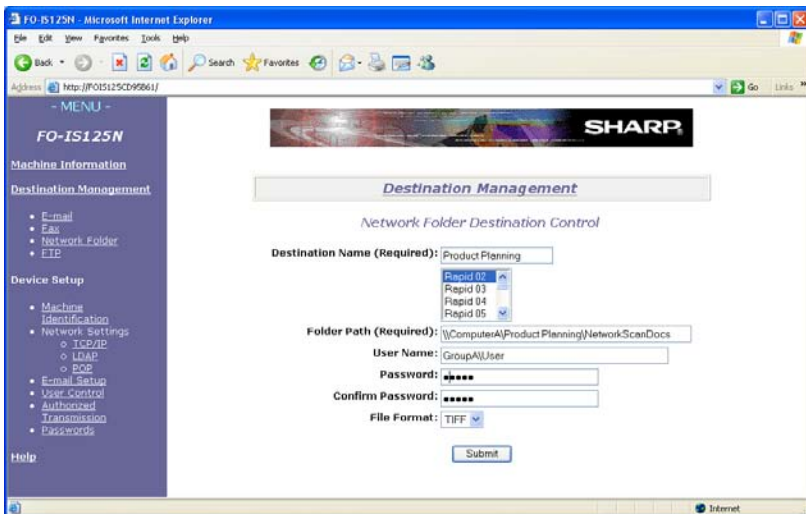

The screenshot shows a web browser window titled "FO-IS125N - Microsoft Internet Explorer". The address bar shows "http://FOIS125CD95861/". The page has a "MENU" bar and a "SHARP" logo. The main content area is titled "Destination Management" and "Network Folder Destination Control". The form includes the following fields:

- Destination Name (Required):** Product Planning
- Rapid Key Selection:** A dropdown menu with options: Rapid 02, Rapid 03, Rapid 04, Rapid 05. Rapid 05 is selected.
- Folder Path (Required):** \\ComputerA\Product Planning\Network-ScanDocs
- User Name:** GroupAllUser
- Password:** [Redacted]
- Confirm Password:** [Redacted]
- File Format:** TIFF
- Submit** button

The left sidebar contains a "Destination Management" menu with options: E-mail, Fax, Network Folder, and FTP. Below it is a "Device Setup" menu with options: Machine Identification, Network Settings (TCP/IP, LAN, PC), E-mail Setup, User Control, Antivirus Transmission, and Passwords. A "Help" link is at the bottom of the sidebar.

Enter the name of the destination in **Destination Name** and select the Rapid Key or Speed Dial number that you wish to use from the list.

Type in the **Folder Path** (the name or IP address of the computer on which the folder is located, followed by the path to the folder). For example, to specify the "NetworkScanDocs" folder in the "Product Planning" folder on "ComputerA", type in the following:

```
\\ComputerA\Product Planning\NetworkScanDocs
```

Note: The folder must be set as a folder that is shared on the network in the folder properties.

Enter the **User Name** and **Password** required to access the computer. If your network environment requires that you enter the domain name with the user name, enter the **User Name** in the format *DomainName\UserName*.

Select the **File Format** of the scanned image. (The file format selected here is a default format that will be used if a file format is not specified at the time of transmission.)

When finished, click **Submit**.

Storing an FTP destination

To store an FTP destination, open the machine's Web page as explained on page 32.

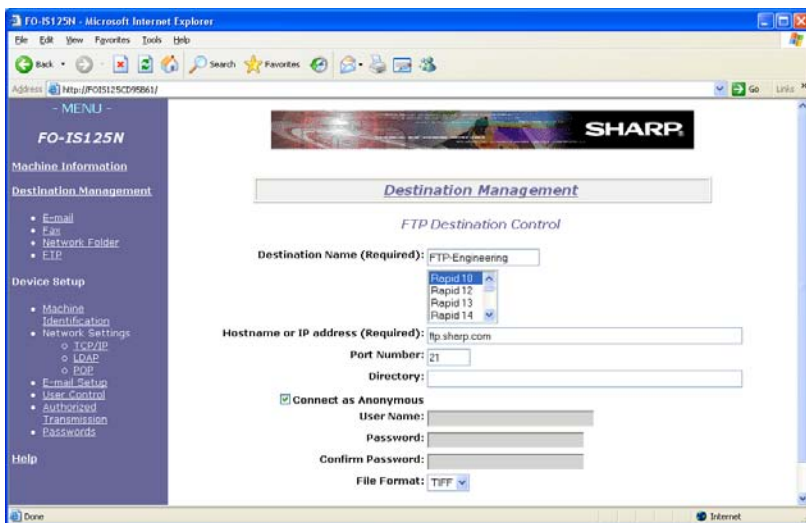

Scan to Folder / FTP

Click **FTP** under **Destination Management** in the menu frame. The screen below will appear.

Enter a name for the destination in **Destination Name** and select the Rapid Key or Speed Dial number that you wish to use from the list.

Type in the **Hostname** or **IP Address** of the FTP server and the **Directory** where the file will be stored on the FTP server.

Make sure **Anonymous** is selected if you will connect to the FTP server as an anonymous user; otherwise, deselect **Anonymous** and enter the **User Name** and **Password** required to access the server.

Select the **File Format** of the scanned image. (The file format selected here is a default format that will be used if a file format is not specified at the time of transmission.)

When finished, click **Submit**.

Scan to Folder/FTP Transmission

Follow the steps below to send a scanned document to a network folder or FTP server.



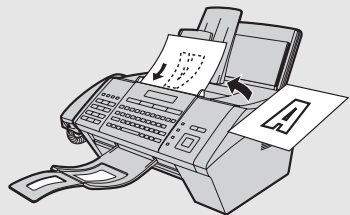

- ◆ The document will be sent as an image file. The file format can be selected in Steps 4 and 5 below.

1 Insert the document face down in the document feeder. The top edge of the document should enter the feeder first.

- SEND READY will appear in the display.
- Up to 30 letter-size sheets (5 legal-size sheets) can be placed in the feeder at once.
- For more information on loading the document, see page 53.
- If desired, press RESOLUTION to set the resolution and contrast (see p. 55).





2 Select the destination using one of the following methods:



- If the destination has been stored in a Rapid Key, press the Rapid Key.
- If the destination has been stored in a Speed Dial number, press  and enter the Speed Dial number.
- To search for the destination, press , press  or  until the name or address appears, and press .

3 If you need to specify either of the file options, press  and go to Step 4 below. (Note that settings selected here are temporary. To make permanent changes, change the settings in the Web page as explained on pages 49 and 50.)

If you do not wish to change the file options, go directly to Step 6.

4 Press  or  until the desired option appears, and then make a selection for the option as explained below.

- **FILE FORMAT:** Select the format of the scanned image file. Press for TIFF or for PDF.
- **FILE NAME:** To use an automatically generated file name for the scanned file, press (AUTO). To assign a custom name, press (CUSTOM), enter the desired name with the letter keys (max. 40 characters), and press .

5 When you have finished configuring the file options, press  or  until the display shows [PRESS START TO SCAN].

6 Press  to begin transmission.

3. Sending Faxes

Transmittable Documents

Minimum document size and weight

Minimum size

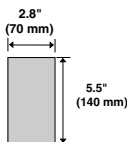

Minimum weight

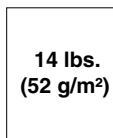

Maximum document size and weight

The maximum size and weight of documents that you can load in the document feeder depend on how many sheets you load.

Loading up to 30 sheets at once:

Size: Letter

(8.5" x 11", 216 x 279 mm)

Weight: 20 lbs. (80 g/m²)

Loading up to 5 sheets at once:

Size: Legal

(8.5" x 14", 216 x 356 mm)

Weight: 20 lbs. (80 g/m²)

Loading 1 sheet at a time (manual feeding):

Size: 8.5" x 14" (216 x 356 mm)

Weight: 42 lbs. (157 g/m²)

Letters or graphics on the edges of a document will not be scanned. (The maximum scanning width is 8.2" (208 mm), and the top and bottom 0.16" (4 mm) of the document cannot be scanned.)

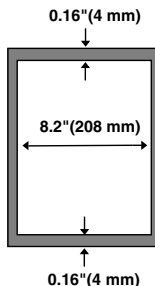

Letters in the shaded area will not be scanned.

Other restrictions

- ◆ The scanner cannot recognize yellow, greenish yellow, or light blue ink.
- ◆ Ink, glue, and correcting fluid on documents must be dry before they pass through the document feeder.
- ◆ All clips, staples, and pins must be removed from documents before loading in the feeder. If these are not removed, they may damage the machine.
- ◆ Documents which are patched, taped, torn, smaller than the minimum size, carbon backed, easily smudged, or have a slick coated surface should be photocopied, and the copy loaded in the feeder.

Loading the Document

Up to 30 letter-size sheets, or 5 legal-size sheets, can be placed in the feeder at once. The sheets will automatically feed into the machine starting from the bottom sheet.

- ◆ If you need to send or copy more than the maximum number of sheets, place the additional sheets gently and carefully in the feeder just before the last sheet is scanned. Do not try to force the sheets in, as this may cause double-feeding or jamming.
- ◆ For large or thick sheets that must be loaded one at a time, insert each sheet into the feeder as the previous sheet is being scanned. Insert gently to prevent double-feeding.

- 1 Adjust the document guides to the width of your document.**

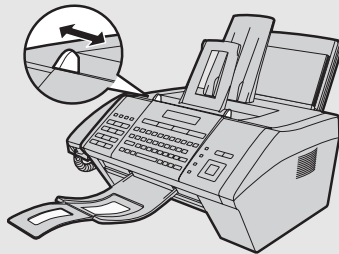

Loading the Document

2 Insert the document face down in the document feeder. The top edge of the document should enter the feeder first.

- SEND READY will appear in the display.

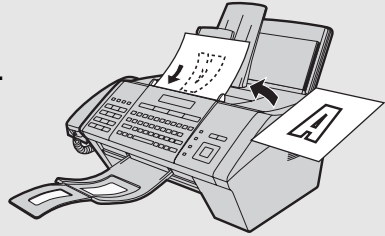

Note: When inserting a large number of pages in the feeder, slant the front end of the stack so that the bottom pages enter first.

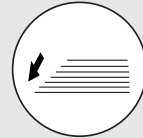

3 Adjust the resolution and/or contrast settings as explained on page 55, then dial the receiving machine as explained on page 57.

Adjusting the Resolution and Contrast

If desired, you can adjust the resolution and contrast before sending a document.

- ◆ The default resolution setting for faxing is STANDARD. The default contrast setting is AUTO.
- ◆ Adjust the settings each time you do not want to use the default settings.

Note: The resolution and contrast settings are only effective for sending a document. They are not effective for receiving a document.

Resolution settings

STANDARD	Use STANDARD for ordinary documents. This setting gives you the fastest and most economical transmission.
FINE	Use FINE for documents containing small letters or fine drawings.
SUPER FINE	Use SUPER FINE for documents containing very small letters or very fine drawings.
HALF TONE	Use HALF TONE for photographs and illustrations. The original will be reproduced in 64 shades of gray.

Contrast settings

AUTO	Use AUTO for normal documents.
DARK	Use DARK for faint documents.

Adjusting the Resolution and Contrast

1 Load the document(s).

- The resolution/contrast cannot be adjusted unless the document is loaded.

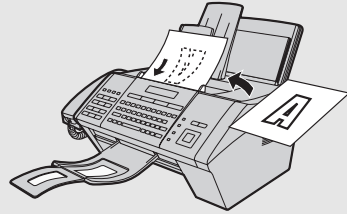

2 Press RESOLUTION one or more times until the desired resolution and contrast settings appear in the display.

- The first time you move through the list of resolution settings, the contrast setting AUTO will appear next to each resolution setting. The second time you move through the list, the contrast setting DARK will appear.

Note: In order to transmit in SUPER FINE resolution, the receiving fax machine must also have that resolution. If it doesn't, your machine will automatically step down to the next best available setting.

If you prefer to use FINE for the default resolution setting, change the "FINE PRIORITY" setting (p. 136).

Sending a Fax by Normal (Manual) Dialing

With Normal Dialing, you pick up the handset (or press ^{SPEAKER}) and dial by pressing the number keys.

- ◆ If a person answers, you can talk with them through the handset before sending the fax. (If you pressed ^{SPEAKER}, you must pick up the handset to talk.)
- ◆ Normal Dialing allows you to listen to the line and make sure the other fax machine is responding.

1 Load the document(s).

- If desired, press ^{RESOLUTION} to set the resolution and/or contrast.

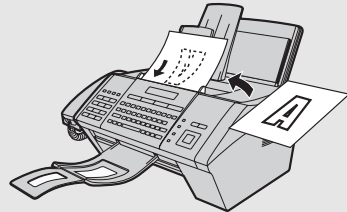

2 Pick up the handset or press ^{SPEAKER}. Listen for the dial tone.

3 Dial the number of the receiving machine by pressing the number keys.

4 Wait for the connection. Depending on the setting of the receiving machine, you will either hear a fax tone or the other person will answer.

- If the other party answers, ask them to press their Start key (if you pressed ^{SPEAKER}, pick up the handset to speak with them). The receiving machine will issue a fax tone.

Sending a Fax by Normal (Manual) Dialing

5 When you hear the fax tone, press . Replace the handset.

- If the transmission is completed successfully, the machine will beep once.
- If an error occurs, the machine will beep three times and print a Transaction Report to inform you of the problem (see page 143).

Page counter for Normal (manual) Dialing

When automatic dialing is used, a slash and the total number of pages is automatically added to each page number on transmitted fax pages (for example, "P. 1/5", "P.2/5", etc.). This allows the recipient to check for missing pages.

If you wish to use this feature with Normal Dialing, you must set the total number of pages manually. Follow the steps below.

1 Load the document(s).

2 Press  , then  until [PAGE COUNTER] appears in the display.

3 Press .

Display: [ENTER # (01 - 99)]

4 Enter the total number of pages ("01" to "99") with the numeric keys.

Example: 5 pages  

5 If desired, press  to set the resolution and/or contrast.

Sending a Fax by Normal (Manual) Dialing

6 Follow Steps 2 to 5 of the Normal Dialing procedure to send the fax.

- To cancel a batch number entry, remove the document from the feeder or press .
- If the number of pages actually transmitted is not the same as the batch number entered, an alarm will sound and **[PAGE COUNT ERROR]** will appear in the display. "PAGE E." will also appear in the **NOTE** column of the Transaction Report if printed.

Sending a Fax by Automatic Dialing

Sending a Fax by Automatic Dialing

You can store your most frequently dialed fax and phone numbers in Rapid Keys and Speed Dial numbers.

- ◆ A number stored in a Rapid Key is dialed by simply pressing the Rapid Key. A total of 36 Rapid Keys are available. (Note: Attach the Rapid Key labels as shown on page 9.)
- ◆ A number stored in a Speed Dial number is dialed by pressing ^{SPEED DIAL}, the 3-digit Speed Dial number, and then . A total of 114 Speed Dial numbers are available.

Storing fax and phone numbers

Follow the steps below to store a fax or phone number using the machine's operation panel.

- ◆ Fax/phone numbers can also be stored using the machine's Web page. Open the Web page as explained on page 32, and click **Fax** under **Destination Management** in the menu frame to open the **Fax Destination Control** screen.

1 Press ^{FUNCTION} then .

2 To store a number in a Rapid Key, press the desired Rapid Key.

To store a number in a Speed Dial number, press ^{SPEED DIAL} and enter the desired Speed Dial number (the number must be 3 digits: enter "001" for Speed Dial 1, "010" for Speed Dial 10, etc.).

Display: [SELECT DEST. TYPE]

- If you prefer to have the machine suggest an available Rapid Key / Speed Dial number at the end of the procedure, press .

Sending a Fax by Automatic Dialing

3 Press to select "FAX".
Display: [FAX # MODE]

4 Enter the fax or phone number by pressing the number keys (maximum of 32 digits).
(Note: A space cannot be entered.)

- To clear a mistake, press .
- If a pause is required between any of the digits to access a special service or an outside line, press . The pause appears as a hyphen (two seconds per pause). Several pauses can be entered in a row.

5 Press .

6 Enter the name of the destination (max. 20 characters).

- For information on using the letter keys, see page 12.

7 Press .

8 If you selected a Rapid Key or Speed Dial number in Step 2, the display will briefly show [STORED], and then [NEW NUMBER]. Go to Step 9. If you did not select a Rapid Key or Speed Dial number in Step 2, the display will show the next available Rapid Key or Speed Dial number. If that number is acceptable, press and go to Step 9. If not, press the desired Rapid Key, or press and enter the desired 3-digit Speed Dial number, and go to Step 9.

9 Return to Step 2 to store another number, or press to exit.





Sending a Fax by Automatic Dialing

Editing and clearing auto-dial numbers

To make changes to a previously stored auto-dial number, or clear a number, follow these steps:

1 Press ^{FUNCTION}  then .

2 Select the number that you wish to edit or delete using one of the methods below:



- **Rapid Key:** If the number is stored in a Rapid Key, press the Rapid Key.
- **Speed Dial:** If the number is stored in a Speed Dial number, press ^{SPEED DIAL}  and enter the 3-digit Speed Dial number with the number keys (enter “001” for Speed Dial 1, “010” for Speed Dial 10, etc.).
- **Search:** Press  or  until the name or number of the destination appears in the display and press .

Display: [1=EDIT, 2=CLEAR]

3 Press  for “EDIT” or  for “CLEAR”.

- If you selected “CLEAR”, go to Step 7.



4 If you selected “EDIT”, make the desired changes to the number.

- Press  or  to move the cursor to the digit or digits you wish to change, and then enter the new digit. The new digit will replace the old digit. You can also press  to backspace and clear digits.
- If you do not wish to change the number, go directly to Step 5.

5 Press .

Sending a Fax by Automatic Dialing

6 Make the desired changes to the name.

- Press  or  to move the cursor to the letter or letters you wish to change, and then press the appropriate letter key. The new letter will replace the old letter. You can also press  to backspace and clear letters.
- If you do not wish to change the name, go directly to Step 7.

7 Press .

8 Return to Step 2 to edit or clear another number, or press to exit.

Sending a Fax by Automatic Dialing

Using an auto-dial number to send a fax

1 Load the document(s).

- If desired, press ^{RESOLUTION} to set the resolution and/or contrast.

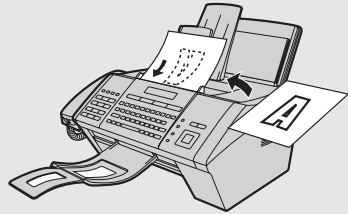

2 Select the fax number using one of the methods below:

- **Rapid Key Dialing:** If the number is stored in a Rapid Key, press the Rapid Key.
- **Speed Dialing:** If the number is stored in a Speed Dial number, press ^{SPEED DIAL} and enter the Speed Dial number with the number keys (the number must be 3 digits: enter “001” for Speed Dial 1, “010” for Speed Dial 10, etc.). Make sure the correct destination appears in the display (if not, press), and then press .
- **Search Dialing:** Press or until the name or number of the other party appears in the display, and press .



3 Scanning, dialing, and transmission will take place automatically.

- To cancel transmission, press .
- If the transmission is completed successfully, the machine will beep once.
- If an error occurs, the machine will beep three times and print a Transaction Report to inform you of the problem (see page 143).

Making a voice call with an auto-dial number

Rapid Key Dialing: Lift the handset and press the Rapid Key.

Speed Dialing: Lift the handset, press ^{SPEED DIAL}, and enter the Speed Dial number with the number keys (the number must be 3 digits: enter "001" for Speed Dial 1, "010" for Speed Dial 10, etc.).

Search Dialing: Press  or  until the name or number of the other party appears, and lift the handset.

(You can also lift the handset first, search for the number, and then press



Sending a fax by Direct Keypad Dialing

Use this method to dial a full fax number without using the handset.

1 Load the document(s).

- If desired, press ^{RESOLUTION} to set the resolution and/or contrast.

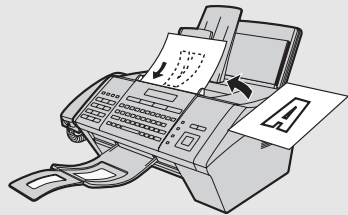

2 Enter the number of the receiving machine with the number keys.



- If a pause is required between any of the digits to access a special service or an outside line, press ^{REDIAL}. The pause appears as a hyphen (two seconds per pause). Several pauses can be entered in a row.

3 Check the display. If the number shown is correct, press .

- If the number is not correct, press to clear the incorrect digits, and then re-enter the correct digit(s).

Sending a Fax by Automatic Dialing

Using the REDIAL key

To redial the last number dialed on the machine, press . The speaker will be automatically activated. To fax a document, press  when you hear the fax tone after the other machine answers.

Automatic redialing

If you use auto dialing (including Direct Keypad Dialing) to send a fax and the line is busy, the machine will automatically make three redial attempts at intervals of five minutes.

During this time, [RECALLING] will appear in the display, followed by the attempt number. You will not be able to dial any other locations while the message appears.

- ◆ To clear the message and stop automatic redialing, press . If there are multiple fax numbers being automatically redialed, only the number that was attempted first will appear in the display. To cancel automatic redialing of a different number, see *Checking and canceling stored fax jobs* on page 67.

Under certain conditions, automatic redialing may stop before three redialing attempts are made.

Checking and canceling stored fax jobs



If you use automatic dialing (including Direct Keypad Dialing) to send a fax while the machine is busy with another job, the fax job will be stored in the machine's memory and performed after all previously stored jobs are finished.

To check what fax jobs are waiting in memory to be performed, or to cancel a job, follow the steps below.

- ◆ Timer transmission jobs can also be checked and canceled using this procedure.

1 Press  .

2 Make sure that [TX JOBS] appears in the display and press  .

3 Press  or  to scroll through the stored fax jobs.

- The top line of the display shows the memory number assigned to the job and the time the job was stored. The bottom line alternately shows the destination and the status of the job.
- [NO DATA] will appear if no jobs are currently stored in memory.

4 To cancel a job, display the job and press  .

[IF CLEAR, PRESS START] will appear. Press  again to clear the job.

5 Press  to exit.

4. Receiving Faxes

Using AUTO Mode

To select AUTO mode, press ^{RECEPTION} (with no document in the feeder) until [AUTO] appears in the display.

In AUTO mode, the machine automatically answers all calls on 4 rings and receives incoming faxes.

- ◆ If you pick up the handset before the machine answers, you can talk to the other party and receive a fax as explained in *Using MANUAL Mode* below.

To change the number of rings on which the machine answers calls, change the "NUMBER OF RINGS" setting (pp. 136 and 137).

The machine automatically reduces received faxes as needed to fit the paper. If you prefer to have all faxes printed at full size, change the "RECEIVE RATIO" setting (pp. 136 and 140).

Important:

Do not let more than 100 sheets collect in the received document tray. Too many sheets in the tray will cause paper jams.

Using MANUAL Mode

To select MANUAL mode, press  (with no document in the feeder) until [MANU] appears in the display.

In MANUAL mode, you must answer all calls (even faxes) by picking up the machine's handset or an extension phone connected to the same line.

Answering on the machine's handset

Important: If a document is loaded in the machine's feeder, remove it before performing the steps below.

1 When the machine rings, pick up the handset.

2 If you hear a soft fax tone, wait until the display shows [RECEIVING] and then replace the handset.

- ◆ If [RECEIVING] does not appear (or if you have set the Fax Signal Receive setting to NO (pp. 136, 138)), press  to begin reception.

3 If the other party first speaks with you and then wants to send a fax, press  after speaking. (Press before the sender presses their Start key.)

- When [RECEIVING] appears in the display, hang up.

Answering on an extension phone connected to the same line

1 Answer the extension phone when it rings.



Reception to Memory

2 If you hear a soft fax tone (this is sent by the sending machine), wait until you hear pronounced, high-pitched fax tones (this is the response from your machine), then hang up.

3 If the machine doesn't respond, or if the other party first talks to you and then wants to send a fax, set the phone down (do not hang up), walk over to the machine, lift the machine's handset, and press .

- The above step is necessary if you have set the "FAX SIGNAL RX" setting to NO (pp. 136, 138).

Putting a call on hold

To put the other party on hold during a phone call, press . When this is done, they cannot hear you. You can put the handset back in the cradle without breaking the connection. When you are ready to speak with the other party again, pick up the handset. If you did not put the handset back in the cradle, press  again to resume conversation.

Reception to Memory

Incoming faxes will be received to memory when printing is not possible, such as when the machine runs out of paper, the print cartridge needs replacement, or the paper jams.

When you have received a fax in memory, [FAX RX IN MEMORY] will appear in the display, alternating with a message that indicates the problem.

When you resolve the problem, the stored faxes will automatically print out.

- ◆ If you received faxes to memory because the machine ran out of paper, be sure to add paper that is the same size as the paper previously used, or the fax print-out size will not match the size of the printing paper.

5. Security Functions (Administrator)

Introduction

The security functions help you control the use of the machine and ensure that sensitive documents are kept confidential.

The security functions are described below. Any combination of these functions can be used.

Note: Only the administrator of the machine can set up and activate the security functions. To access the functions, the administrator code must be entered. To set the administrator code, see page 72.

- ◆ **User Authentication:** This function restricts use of the machine to authenticated users. To use the machine, a user must first log in by entering his or her user number or login name and password.
- ◆ **Secure Fax:** This function ensures that received faxes are only picked up by authorized recipients. When Secure Fax is activated, all received faxes are held in memory without being printed out. To print out the received faxes, the preset Secure code must be entered.
- ◆ **Authorized Transmission:** This function requires that a supervisor approve faxes and Scan to E-mail transmissions before transmission takes place. Each time a user performs a fax or Scan to E-mail transmission, the machine automatically sends an e-mail notification with the scanned image as an attachment to a specified supervisor. The supervisor checks the transmission and decides whether it should be approved or denied, and then returns the e-mail to the machine. The transmission will only take place if the returned e-mail indicates that the transmission has been approved.
- ◆ **Call Restriction:** To ensure that a fax or Scan to E-mail transmission is not accidentally sent to the wrong destination, this function will only allow the transmission if the fax number or e-mail address that the user enters is one of the numbers/addresses that the administrator has previously approved for use in the machine settings.
- ◆ **Send Hold (fax only):** To ensure that a fax is not accidentally sent to the wrong fax number when automatic dialing is used, this function displays the entered fax number and prompts you to confirm that it is correct. After you check the number, press  to begin dialing and transmission.

Administrator Code

Administrator Code

The security functions can only be set up and changed by the administrator of the machine. To access the security functions, the administrator must enter the administrator code.

The administrator code has been set to “00000000” at the factory. ***It is strongly recommended that the administrator of the machine change the administrator code to a code that only he or she knows.*** To change the administrator code, follow the steps below.

1 Hold down  until [ADMIN CODE SETUP] / [PRESS START KEY] appears in the display.

2 Press .
Display: [ENTER OLD CODE]

3 Enter the current administrator code.

- If you are setting the code for the first time, enter 00000000.
 - To clear a mistake, press .
-

4 Press .

5 Enter the new code that you wish to use (any number from 5 to 8 digits).

6 Press . The code will be printed out.

- Take care not to lose the print-out or forget the code. In the event that you forget the code and have kept no record, contact your dealer.
- If [USE ANOTHER CODE] appears, the code you entered is already being used for one of the other security functions. Enter a different code.

Password protection for the Web page

To require that users enter a password in order to access the machine's Web page, open the Web page (see page 32) and click **Passwords** in the menu frame. The **Password Setup** screen will appear.

Enter a password for regular users under **User Password**, and enter an administrator password under **Admin Password**.

- ◆ The default administrator password is "Sharp". ***It is strongly recommended that the administrator of the machine change the administrator password to a password that only he or she knows.***

Note: The administrator password for the Web page is separate from the administrator code for the security functions described on page 72.

If you only wish to prevent users from accessing the settings under **Device Setup** in menu frame of the Web page, select "**Enable password protection of pages under Device Setup**". In this case, users can access all settings other than the **Device Setup** settings without entering a password (it is not necessary to set a password under **User Password** as explained above). To access the Device Setup settings, the administrator password must be entered.

If you wish to require that users enter the user password in order to access the Web page, select "**Enable password protection of this Website**". In this case as well, only the administrator can access the **Device Setup** settings.

If you select "**Disable Password**", anyone can freely access the Web page, including the settings under **Device Setup**.

In **Old Admin Password** at the bottom of the screen, enter the old administrator password. If you are setting passwords for the first time, enter the default administrator password "**Sharp**".

When finished, click **Submit** to save your settings.

User Authentication

User Authentication

This function restricts use of the machine to authenticated users. When the function is activated, all users must log in by entering a login name and password, or a user number, in order to use the machine.

To set up this function, the administrator must:

1. Select the login method. You can select login by login name and password, or login by user number.
2. Store login names and passwords, or user numbers, depending on the login method selected above, and notify each user of their login information.
3. Activate the user authentication function.

The above tasks can be performed in the machine's Web page, or using the machine's operation panel. The procedures for both methods are described on the following pages.

User authentication by LDAP server

If your network has an LDAP server and you wish to use the LDAP server for user authentication, use the Web page to configure settings.

1. Open the Web page as explained on page 32.
2. Select **LDAP** under **Network Settings** in the menu frame and configure your LDAP server information (see page 123).
3. In the Web page, follow the procedures on the following pages to set the login method to **Login Name and Password**, store users (select **Network Authentication** when you store each user), and activate user authentication.

Setting up user authentication in the Web page

Open the machine's Web page as explained on page 32.

Click **User Control** under **Device Setup** in the menu frame. The screen below will appear.

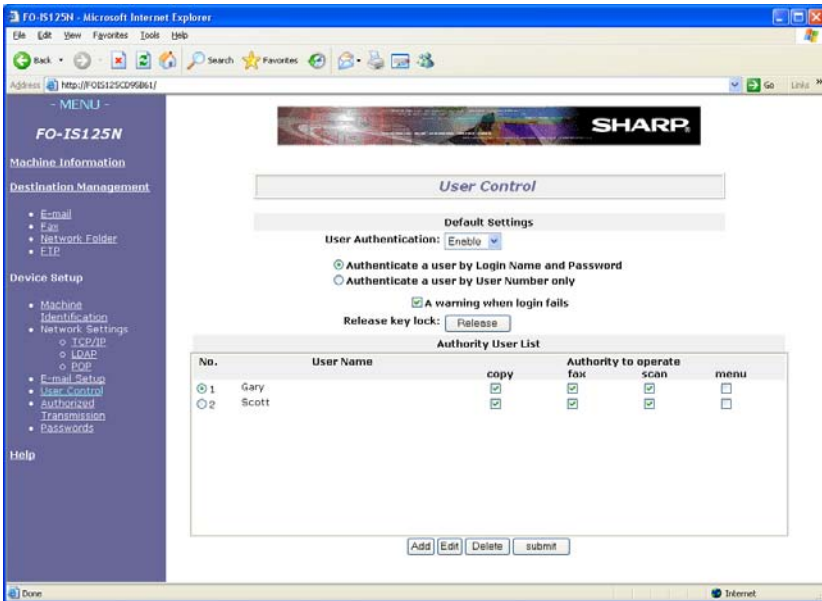

Under **Default Settings**, set **User Authentication** to **Enable**.

Select **Authenticate a user by Login Name and Password** or **Authenticate a user by User Number only**.

To add a new user, click **Add**. The following screen only will appear (the screen shown is the screen that appears when the authentication method is set to **Login Name and Password**).

User Authentication

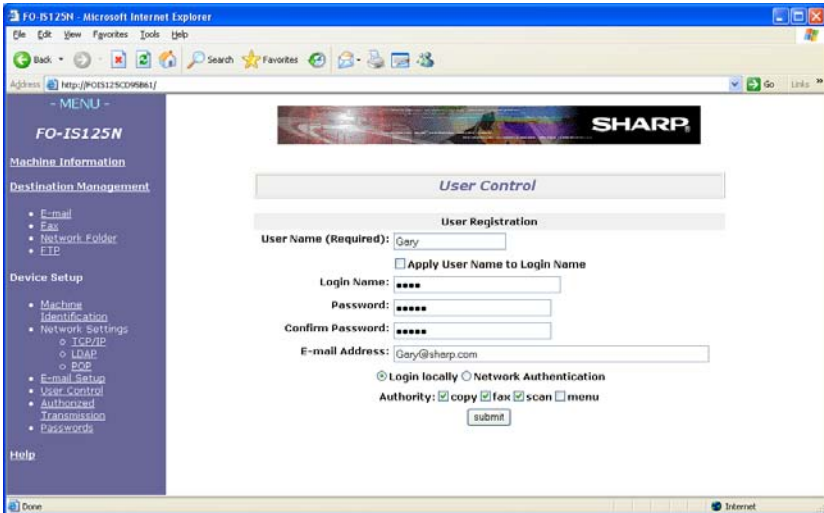

Enter the user information as appropriate.

- ◆ The **E-mail Address** is required if the user will be using the Authorized Transmission function (page 88).

If the authentication method is **Login Name and Password** and you will be using an LDAP server for authentication, select **Network Authentication**. Otherwise select **Login locally**.

In **Authority**, select the operations that you wish to permit the user to perform (**menu** is used to permit the user to configure the settings that are accessed

by pressing $\text{FUNCTION} \left[\square \right]$).

When finished, click **Submit**.



Using the operation panel to select the login method



To use the machine's operation panel to specify whether users must log in by entering a user number, or by entering a login name and password, follow the steps below.



- ◆ The login method cannot be changed if users have been stored for the currently selected method. To change the login method, first delete all users and then change the method.

1 Press , then  until [USER CONTROL] appears.

- If the display shows [ENTER PASSWORD] after you press

, enter the administrator code and press .

2 Press , then  until [AUTH. METHOD] appears.

3 Press  to select authentication by login name and password, or  to select authentication by user number only.

- If [FIRST DELETE ALL USERS FOR OTHER METHOD] appears, users have been stored for the previously selected method. You must first delete these users using the procedure on page 79.

4 Press  to exit.

User Authentication



Using the operation panel to store users

Follow the steps below to store users using the machine's operation panel.

- ◆ When the operation panel is used to store a user, the operations that the user is permitted to use are fixed at copying, faxing, and scanning. If you wish to permit the user to configure the FUNCTION key settings, store or edit the user using the Web page.

1 Press  **SECURE**, then  until **[USER CONTROL]** appears.

- If the display shows **[ENTER PASSWORD]** after you press

 **SECURE**, enter the administrator code and press .

2 Press , then  until **[USER REGISTRATION]** appears.

3 Press  twice.

4 Enter the name of the user (maximum of 20 characters).

- This name is only used for user management; it is not used to log in.

5 Press .

6 If user number has been selected as the authentication method, press the number keys to enter the user number that you wish to assign to the user (any number from 5 to 8 digits not already in use).

If login name and password has been selected as the authentication method, enter the login name that the user will use to log in (maximum of 32 characters). Press  and enter the password that the user will use (maximum of 30 characters).

7 Press .



8 Return to Step 4 to store another user, or press  to exit.



Using the operation panel to edit and delete users

Follow the steps below to edit or delete a previously stored user.



1 Press , then  until [USER CONTROL] appears.

- If the display shows [ENTER PASSWORD] after you press

, enter the administrator code and press .

2 Press , then  until [USER REGISTRATION] appears.

3 Press .

4 Press  or  until the user that you wish to edit or delete appears, and press .



- If you wish to delete all stored users, press  and go to Step 9.

5 Press  for “EDIT” or  for “CLEAR”.

- If you selected “CLEAR”, go to Step 9.

User Authentication

6 If you selected “EDIT”, make the desired changes to the name of the user.



- Press  or  to move the cursor to the letter or letters you wish to change, and then press the appropriate letter key. The new letter will replace the old letter. You can also press  to backspace and clear letters.
- If you do not wish to change the name, go directly to Step 7.

7 Press .

8 If the authentication method is user number, make the desired changes to the user number.

If the authentication method is user name and password, make the desired changes to the user’s login name (maximum of 32 characters).

Press  and make the desired changes to the password.

- Press  or  to move the cursor to the digit/character you wish to change, and then enter the new digit/character. The new digit/character will replace the old digit. You can also press  to backspace and clear digits/characters.

9 Press .



10 Return to Step 4 to edit or clear another user, or press  to exit.

Using the operation panel to activate the user authentication function

Follow the steps below to activate the user authentication function at the operation panel.

1 Press , then  until [USER CONTROL] appears.

- If the display shows [ENTER PASSWORD] after you press

, enter the administrator code and press .

2 Press .

Display: [USER AUTHENTICATION]

3 Press  (ON) to activate user authentication, or  (OFF) to deactivate user authentication.

4 Press  to exit.

User Authentication

Procedure for login by user number

To log in and use the machine when the authentication method is user number, follow the steps below.

1 Press any key on the operation panel of the machine.

Display: [ENTER YOUR USER NO.]

2 Enter your user number with the number keys.

3 Press .

- The display will briefly show [LOGGED IN]. You can now use the machine.
-

4 When you have finished using the machine, press  to log out.

- If you do not use the machine for more than 3 minutes, you will be automatically logged out.



Procedure for login by login name and password

To log in and use the machine when the authentication method is login name and password, follow the steps below.

- ◆ Your login name and password are case sensitive (they must be entered in the same case as they were stored in the machine (or LDAP server) by the administrator).

1 Press any key on the operation panel of the machine.

Display: [ENTER LOGIN NAME]

2 If you are logging in locally to the machine, press  or  until your login name appears in the display, or enter your login name with the letter keys.

If you are logging in to an LDAP server, enter your login name with the letter keys (if the authentication type is “SIMPLE”, enter your “Display name”; if the authentication type is “DIGEST MD5”, enter your “User logon name”) (see pages 124 and 125) .

3 Press .

Display: [ENTER YOUR PASSWORD]

4 Enter your password.

5 Press .

- The display will briefly show [LOGGED IN]. You can now use the machine.

6 When you have finished using the machine, press  to log out.

- If you do not use the machine for more than 3 minutes, you will be automatically logged out.

If login fails 3 times in a row...

If you enter the wrong user number or wrong password 3 times in a row, the operation panel keys will lock for 3 minutes. If you need to release the lock immediately, open the machine's Web page as explained on page 32, click **User Control** in the menu frame, and click the **Release key lock** button in the **User Control** screen. (If regular users are prohibited from accessing the items under **Device Setup** in the menu frame, you will need to ask your administrator to do this.)

Secure Fax



Secure Fax

To prevent others from viewing or taking your received faxes, use the Secure Fax function. When this function is activated, received faxes are held in memory without being printed. To print the faxes, a preset Secure code must be entered.



Setting the Secure code

The Secure code is used to print received faxes. Follow the steps below to set the Secure code.

- ◆ The Secure code can be any number from 5 to 8 digits in length.

1 Press  **SECURE** , make sure that **[SECURE FAX]** appears, and press .

- If the display shows **[ENTER PASSWORD]** after you press

 **SECURE** , enter the administrator code and press .

2 Press  until **[SECURE CODE] / [1 = SET, 2 = CLEAR]** appears.

3 Press  to select “SET”.

4 Enter a Secure code (5 to 8 digits).

5 Press .

- The machine will print the Secure code for your records.

Activating Secure Fax

Follow the steps below to activate Secure Fax.



- ◆ Secure Fax cannot be activated unless a Secure code has been set.

1 Press  **SECURE** , make sure that **[SECURE FAX]** appears, and

press .

Display: **[SECURE FAX] / [1 = ON, 2 = OFF]**

- If the display shows **[ENTER PASSWORD]** after you press

 **SECURE** , enter the administrator code and press .

2 Press  to select “ON”.

3 Press  to exit.

Printing received faxes

When the memory is holding one or more received faxes, **[RECEIVED SECURE FAX]** will appear in the display. Follow the steps below to print the faxes.

1 Press  **RELEASE** .
Display: **[SECURE DATA PRINT] / [ENTER SECURE #]**

2 Enter the Secure code.

3 Press .

- Printing will begin.

Secure Fax

Deactivating Secure Fax

To deactivate Secure Fax, follow the steps below.

- ◆ Secure Fax cannot be deactivated while received faxes are held in memory. (while **[RECEIVED SECURE FAX]**) appears in the display). First print the received faxes and then deactivate Secure Fax.

1 Press , make sure that **[SECURE FAX]** appears, and press .

Display: **[SECURE FAX] / [1 = ON, 2 = OFF]**

- If the display shows **[ENTER PASSWORD]** after you press

, enter the administrator code and press .

2 Press to select “OFF”.

Display: **[ENTER SECURE #]**

3 Enter the Secure code.



4 Press .

5 Press to exit.



Clearing the Secure code

To clear the Secure code, follow the steps below.

- ◆ Secure Fax must be deactivated (see page 86) before you can clear the Secure code.

1 Press  **SECURE** , make sure that **[SECURE FAX]** appears, and press .

- If the display shows **[ENTER PASSWORD]** after you press

 **SECURE** , enter the administrator code and press .

2 Press  until **[SECURE CODE] / [1 = SET, 2 = CLEAR]** appears.

3 Press  to select “CLEAR”.

4 Enter the Secure code.

5 Press .

- The display will briefly show **[SECURE # CLEAR] / [CLEARED]**.
- If the wrong code is entered, **[WRONG SECURE #]** will appear. Go back to Step 4. (If the wrong code is entered 3 times in a row, you will return to the standby display.)

6 Press  to exit.

Authorized Transmission

The Authorized Transmission function requires that a supervisor approve faxes and Scan to E-mail transmissions before transmission can take place. Each time a user performs a fax or Scan to E-mail transmission, the machine automatically sends an e-mail notification (with the scanned image as an attachment) to a specified supervisor. The supervisor checks the transmission and decides whether it should be approved or denied, and then uses “Reply” to return the e-mail to the machine. The transmission will only take place if the returned e-mail indicates that the transmission has been approved.

- ◆ When this function is enabled, faxes cannot be sent by Normal Dialing (page 57).

To set up this function, you must:

1. Establish an exclusive e-mail account for the machine and configure settings for the account in the Web page.
(Note: All e-mail received by the machine is automatically cleared. If an account that is shared by a person is used, e-mail sent to that person may be cleared before he or she can retrieve it.)
2. Store the name and e-mail address of the supervisor or other person who will check the transmission.
3. Activate the function.
4. In addition, user authentication must be activated (see page 74), and the e-mail address of each user that will use the function must be entered in the **User Registration** screen of **User Control** in the Web page as explained on page 76.

The procedures for performing tasks **1** to **3** above are explained on the following pages. Tasks **2** and **3** can either be performed using the Web page, or using the operation panel of the machine.

E-mail account settings in the Web page

Open the machine's Web page as explained on page 32.

Click **E-mail Setup** in the menu frame and enter the host name or IP address of your SMTP server. A sender address must also be entered. (These settings are the same as for Scan to E-mail transmission; page 33).

Next, click **POP** under **Network Settings** in the menu frame. The following screen will appear.

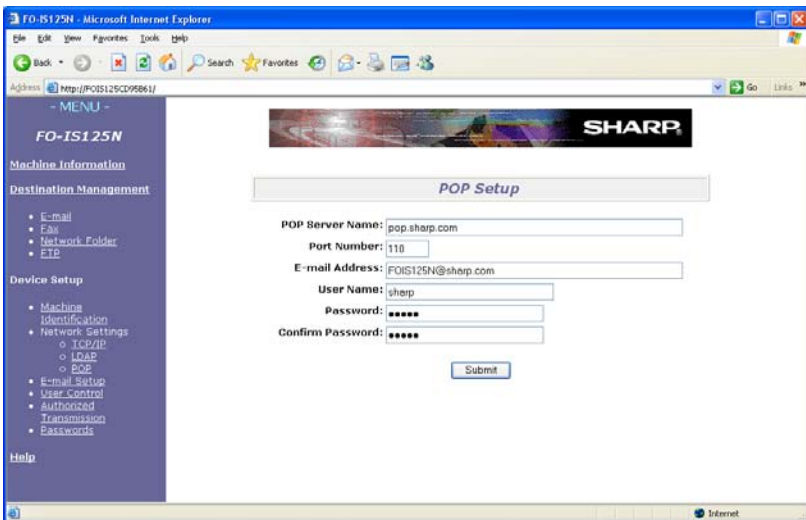

Enter the host name or IP address of the POP server that the machine will use to receive e-mail, the e-mail address assigned to the machine, the user name of the machine's e-mail account, and the password.

Authorized Transmission

Using the Web page to configure Authorized Transmission settings

To open the Authorized Transmission settings, click **Authorized Transmission** in the menu frame. The following screen will appear.

The screenshot shows a Microsoft Internet Explorer browser window displaying the 'Authorized Transmission' configuration page for 'FO-IS125N'. The page has a left-hand navigation menu with options like 'Machine Information', 'Destination Management', 'Device Setup', and 'Help'. The main content area is titled 'Authorized Transmission' and contains the following settings:

- Authorized Transmission:** A dropdown menu currently set to 'Disable'.
- Operation to be authorized:** Three radio button options: 'Fax transmission & Scan-to-Email', 'Fax transmission Only', and 'Scan-to-Email Only'.
- Notice to the sender:** Three radio button options: 'After authorization', 'After authorization & after sending fax', and 'No notice'.
- Automatic elimination of the image which hasn't been authorized yet:** A dropdown menu set to 'After 2 hours'.
- Authorized Approver 1, 2, and 3:** Three sections, each with a 'Name' and 'E-mail address' text input field.
- submit:** A button at the bottom right of the form.

Set **Authorized Transmission** to **Enable** and select the type of operation that you wish to be authorized in **Operation to be authorized**.

In **Notice to the sender**, select when an e-mail is sent to the user to inform him or her of the supervisor's decision and the status of the transmission.

In **Automatic elimination of the image which hasn't been authorized yet**, you can select a time after which a transmission will be canceled if no response is received from the supervisor.

At the bottom of the screen, enter the e-mail addresses of supervisors that are authorized to check transmissions (up to three e-mail addresses can be entered; the user will select one of the supervisors at the time of transmission).



When finished, click **submit**.

Using the operation panel to store supervisors

To store the name and e-mail address of the person who will check the transmission using the operation panel, follow the steps below. Up to three supervisors can be stored.

1 Press , then  until [AUTH. TRANSMISSION] appears.

- If the display shows [ENTER PASSWORD] after you press

, enter the administrator code and press .

2 Press , then  until [AUTHORIZED APPROVER] appears.

3 Press .

4 Press .

5 Enter the e-mail address of the supervisor with the letter (and number) keys.

- For information on using the letter keys, see page 12.

6 Press .

7 Enter the name of the supervisor with the letter keys.

Authorized Transmission

8 Press .



9 Return to Step 4 to store another supervisor, or press  to exit.

Using the operation panel to edit and delete supervisors

Follow the steps below if you need to edit the information stored for a supervisor or delete a supervisor.



1 Press , then  until [AUTH. TRANSMISSION] appears.

- If the display shows [ENTER PASSWORD] after you press

, enter the administrator code and press .

2 Press , then  until [AUTHORIZED APPROVER] appears.



3 Press .

4 Press  or  until the supervisor that you wish to edit or delete appears and press .

5 Press  for “EDIT” or  for “CLEAR”.



- If you selected “CLEAR”, go to Step 9.

6 If you selected “EDIT”, make the desired changes to the e-mail address of the supervisor.

- Press  or  to move the cursor to the letter or letters you wish to change, and then press the appropriate letter key. The new letter will replace the old letter. You can also press  to backspace and clear letters.
- If you do not wish to change the e-mail address, go directly to Step 7.

7 Press .

8 Make the desired changes to the name of the supervisor.

- Press  or  to move the cursor to the character you wish to change, and then enter the new character. The new character will replace the old character. You can also press  to backspace and clear characters.
- If you do not wish to change the name, go directly to Step 9.

9 Press .

10 Return to Step 4 to edit or clear another supervisor, or press  to exit.

Authorized Transmission



Using the operation panel to activate Authorized Transmission

Follow the steps below to activate (or deactivate) the Authorized Transmission function using the operation panel.

- ◆ At least one supervisor must be stored before Authorized Transmission can be activated.

1 Press , then  until **[AUTH. TRANSMISSION]** appears.

- If the display shows **[ENTER PASSWORD]** after you press

, enter the administrator code and press .

2 Press .

Display: **[ACTIVATE AUTH. TX]**

3 Press  (**ON**) to activate the function, or  (**OFF**) to deactivate the function.

- If **[SETUP APPROVER]** appears, you must first store a supervisor as explained on page 89.

4 Press  to exit.



Using Authorized Transmission

Follow the steps below to perform a fax or Scan to E-mail transmission when Authorized Transmission is enabled.

- ◆ If a timer transmission is not approved by the supervisor until after the set transmission time, transmission will begin as soon as approval is received.

1 Touch any key on the operation panel of the machine and log in.

2 Load the document in the feeder and perform all steps of the transmission.

- When you finish the transmission procedure, if more than one supervisor has been stored, the display will show the name of the first supervisor and [SELECT CHECKER BY ◀ ▶]. To select a different supervisor, press  or . When the name of the desired supervisor appears, press .

3 The machine will send an e-mail to the supervisor (with the scanned image as an attachment) notifying the supervisor of the transmission.

4 The supervisor checks the transmission information in the e-mail. To approve the transmission, the supervisor simply uses “Reply” (or equivalent command) to send the e-mail back to the machine. The supervisor must not change any of the content of the e-mail.

To deny the transmission, the supervisor must enter “REJECT” in the subject line and send the e-mail back to the machine using “Reply” or equivalent command. The supervisor must not change any other content of the e-mail.

5 If the transmission is approved, the machine will begin transmission. If the transmission is denied, the machine will cancel the transmission.

6 You will receive an e-mail notification of the status of the transmission (this depends on the Authorized Transmission settings in the Web page).

Call Restriction

Call Restriction

To ensure that a fax or e-mail message is not accidentally sent to the wrong destination because of a mistake made while dialing the fax number or entering the e-mail address, the Call Restriction function

1) only allows a destination that has been stored in a Rapid Key or Speed Dial number to be used for transmission (direct entry of full fax numbers and e-mail addresses is not allowed) and,

2) checks whether or not the Rapid Key or Speed Dial number specified by the user at the time of transmission has been permitted for use by the administrator. If the number or address has not been permitted for use, the fax or e-mail message will not be sent.

Note: When Call Restriction is activated, a voice number cannot be dialed unless it is stored in a Rapid Key or Speed Dial number and is permitted for use. For this reason, it is recommended that emergency numbers be stored in Rapid Keys or Speed Dial numbers.

To use this function, the administrator must specify the Rapid Keys and Speed Dial numbers that are permitted to be used, and then activate the function.



Permitting stored destinations to be used

Use this procedure to permit a previously stored Rapid Key or Speed Dial number to be used.

- ◆ This procedure can only be used to permit Rapid Keys or Speed Dial numbers to be used. If you need to cancel the permission setting of a Rapid Key or Speed Dial number, edit the key or number as explained on page 99.



1 Press  **SECURE**, then  until **[CALL RESTRICTION]** appears.

- If the display shows **[ENTER PASSWORD]** after you press

 **SECURE**, enter the administrator code and press .

2 Press , then  until [SET PERMITTED #] / [1=NEW, 2= SEARCH] appears.

3 Press (SEARCH).

4 Press  or  until the desired destination appears (only destinations that have not yet been permitted will appear).

- To check the fax number or e-mail address of a name that appears, press



5 Press .

6 Press (YES) to permit the destination to be used.
(To cancel, press (NO).)

7 Return to step 4 to permit another destination, or press to exit.

Call Restriction



Activating Call Restriction

Follow the steps below to activate Call Restriction.

- ◆ To activate Call Restriction, at least one stored destination must be permitted to be used.

1 Press , then  until [CALL RESTRICTION] appears.

- If the display shows [ENTER PASSWORD] after you press

, enter the administrator code and press .

2 Press .

Display: [ACT. CALL RESTRICT]

3 Press  (ON) to activate Call Restriction, or  (OFF) to deactivate Call Restriction.

4 Press  to exit.

When Call Restriction is activated

When Call Restriction is activated, after the user specifies the destination by pressing a Rapid Key, entering a Speed Dial number, or searching, the machine will check whether or not the number is permitted to be used.

- ◆ If the destination is permitted to be used, [APPROVED] will briefly appear and the machine will perform the transmission.
- ◆ If the destination is not permitted to be used, [NOT APPROVED] will briefly appear. Remove the document from the feeder and ask your administrator about the destination.

Note: The permission setting is associated with the stored fax number or e-mail address itself; not with the Rapid Key or Speed Dial number in which the number or address is stored.



Storing/editing destinations with a permission setting

The following procedure can be used to specify the permission setting at the same time as you store a new fax number or e-mail address. This saves you the trouble of first storing the destination using the regular procedure and then using the permission procedure to permit the destination to be used.

In addition, you can use this procedure to cancel the permission setting of a previously stored destination.

1 Press  **SECURE** , then  until **[CALL RESTRICTION]** appears.

- If the display shows **[ENTER PASSWORD]** after you press



 **SECURE** , enter the administrator code and press .

2 Press  , then  until **[SET PERMITTED #] / [1=NEW, 2= SEARCH]** appears.

3 Press  (**NEW**).

4 To store a new fax number, follow steps 2 through 7 of the storing procedure that starts on page 60. To store a new e-mail address, follow steps 2 through 8 of the storing procedure that starts on page 39.

To cancel the permission setting of a previously stored fax number (or otherwise edit the number), follow steps 2 through 7 of the editing procedure that starts on page 62. To cancel the permission setting of a previously stored e-mail address (or otherwise edit the address), follow steps 2 through 8 of the editing procedure that starts on page 40.

5 The display will show **[PERMIT TO SEND?]**. Press  (**YES**) to permit the destination to be used, or  (**NO**) to cancel permission.

6 Complete the remaining steps of the storing or editing procedure.

Send Hold Function (Fax Only)

Send Hold Function (Fax Only)



To ensure that a fax is not accidentally sent to the wrong fax number when you use automatic dialing, this function displays the fax number (or the name stored for the fax number) that you entered and prompts you to confirm that it is correct. After you check the number, press  to begin dialing and transmission.

- ◆ Send Hold will not operate if the handset is lifted or  is pressed before dialing.

Activating (or deactivating) the Send Hold function

1 Press , then  until [SEND HOLDING] appears.

- If the display shows [ENTER PASSWORD] after you press

, enter the administrator code and press .

2 Press .

Display: [ACT. SEND HOLDING]

3 Press  (ON) to activate Send Hold.

(Press  (OFF) to deactivate Send Hold.)





4 Press  to exit.

Sending a fax when the Send Hold function is activated

1 Load the document(s).

- If desired, press ^{RESOLUTION} to set the resolution and/or contrast.

2 Enter the fax number using one of the methods below:

- Press a Rapid Key.
- Press ^{SPEED DIAL} , enter a 3-digit Speed Dial number, and press .
- Enter the full fax number with the number keys and press .
- Press  or  until the name or number of the other party appears in the display, and press .

3 Check the name or number that appears in the display. If it is correct, press to begin dialing and transmission.

- If the name or number is not correct, press to clear it.

6. Printing

Installing the Printer Driver

The machine can be used as a network printer.

- ◆ To use the machine as a network printer, it must be connected to your network as explained on page 17, and it must be assigned an IP address as explained on page 29.

The printer driver must be installed on each computer that will use the machine as a printer. Follow the steps below to install the printer driver.

1 Insert the CD-ROM that accompanied the machine into your computer's CD-ROM drive.

2 In the initial screen that appears, click "Install Printer Driver".

- If the initial screen does not automatically appear, run "Launch.exe" on the CD-ROM. (Open "My Computer", double-click your CD-ROM drive, and double-click "Launch.exe".)
-

3 Follow the instructions in the windows that appear to install the printer driver.

- If multiple FO-IS125N machines are connected to your network, the printer driver can only be installed for one machine at a time. (When the list of detected machines appears during the installation, only one of the machines can be selected.) If you wish to install the printer driver for all connected machines, repeat the installation procedure for each machine. (When repeating the installation, the SHARP FO-IS125N Setup Maintenance program will appear after you click "Install Printer Driver" in Step 2. Select **Modify** to repeat the installation.)
- If a message appears indicating that the software has not passed Windows Logo testing, it does not have a digital signature, or that the publisher cannot be verified (the message may appear more than once), be sure to click "**Continue Anyway**", "**Yes**", or "**Install this driver software anyway**" to continue the installation.

Removing the printer driver

To remove the installed printer driver, simply delete the icon of the printer from the printers window (right-click the printer icon and select **Delete**).

If printer drivers are installed for multiple FO-IS125N machines, all printer drivers can be removed at once using the CD-ROM that accompanied the machine. Insert the CD-ROM into your computer's CD-ROM drive, select **Install Printer Driver**, and then select **Remove** in the FO-IS125N Setup Maintenance screen that appears.

Printing a Document From an Application

1 When you are ready to print a document from an application on your computer, select “Print” from the File menu.

- The **Print** dialog box appears.

2 Make sure that “SHARP FO-IS125N/120N” is selected as the printer.

3 If you need to select the paper size or adjust any of the other print settings, click **Properties**, **Setup**, or **Printer** in the **Print** dialog box (the name of the button varies depending on the application).

- The **Printing Preferences** window appears. Adjust the settings as desired (see pages 106 to 108) and then click **OK**.

4 Select the print range and adjust any other settings as desired in the **Print** dialog box.

5 When you are ready to begin printing, click “Print” or “OK” in the **Print** dialog box.

Note: When you adjust the print settings as explained above in Step 3, your changes will only remain in effect while you are using the application. To make permanent changes, see page 105.

Selecting Print Settings

The print settings are selected in the **Printing Preferences**.

- ◆ To make temporary changes to the print settings, open the **Printing Preferences** from an application as explained in Step 2 on page 104. The settings will remain in effect only while the application is running.
- ◆ To make permanent changes to the print settings, open the **Printing Preferences** from the **Printers and Faxes** folder (the **Printers** folder in Windows® 2000) as explained below:

Windows® Vista: Click the **Start** button, click **Hardware and Sound**, and click **Printers**. Right-click the **SHARP FO-IS125N/120N** icon and select **Printing Preferences**.

Windows® XP / Server 2003: Click the **start** button, click **Control Panel**, click **Printers and Other Hardware**, and then click **Printers and Faxes**. In the **Printers and Faxes** window, click on the **SHARP FO-IS125N/120N** icon and select **Printing Preferences** from the **File** menu.

Windows® 2000: Click the **Start** button, point to **Settings**, and select **Printers**. In the **Printers** window, click on the **SHARP FO-IS125N/120N** icon and select **Printing Preferences** from the **File** menu.

Selecting Print Settings

Page Layout tab

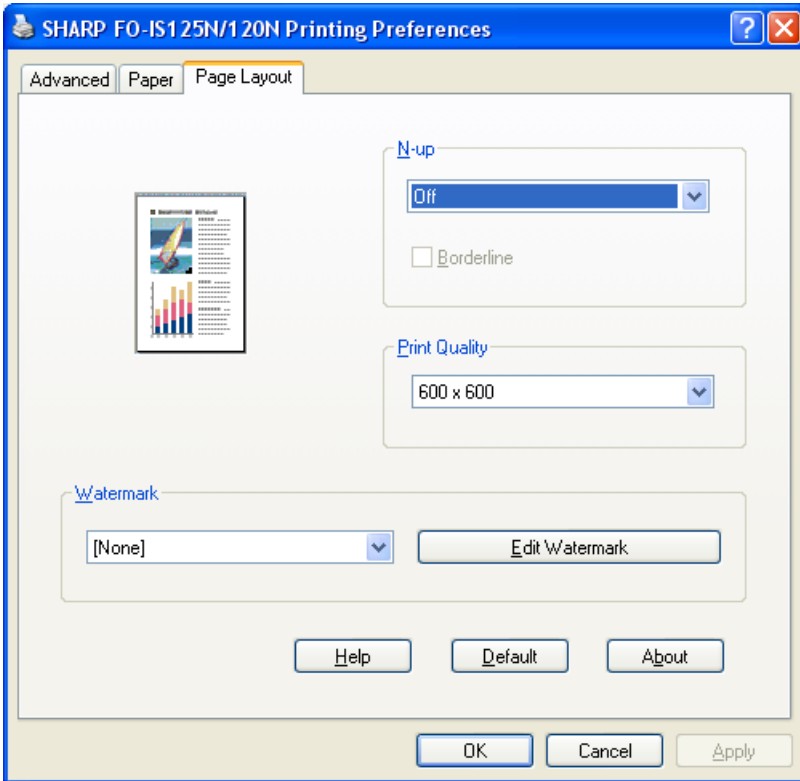

N-up: This is used to print multiple reduced-size images on one sheet of paper. Click the setting and select the desired number of images.

Print Quality: This determines the clarity of the printed image. Click the setting and select the desired quality (a higher setting produces a clearer image).

Watermark: This is used to print a watermark (a faint background image) on each sheet of output. Click the setting and select the desired watermark. To edit the selected watermark, click **Edit Watermark**.

To save your settings and close the window, click **OK**. To save your settings without closing the window, click **Apply**. To cancel your settings and close the window, click **Cancel**.

Paper tab

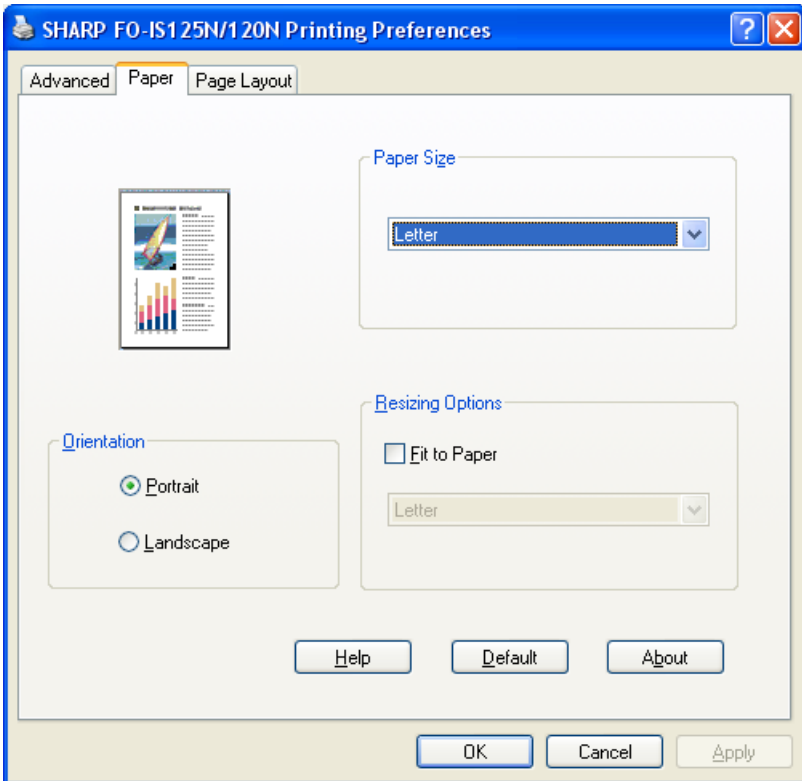

Paper Size: Click the setting and select **Letter** or **Legal** for the paper size. (Make sure that the selected size of paper is loaded in the paper tray.)

Orientation: Select **Portrait** or **Landscape** to match the orientation of your document.

Fit to Paper: Select this and then select a paper size to enlarge or reduce the printed image to the selected paper size.

To save your settings and close the window, click **OK**. To save your settings without closing the window, click **Apply**. To cancel your settings and close the window, click **Cancel**.

Selecting Print Settings

Advanced tab

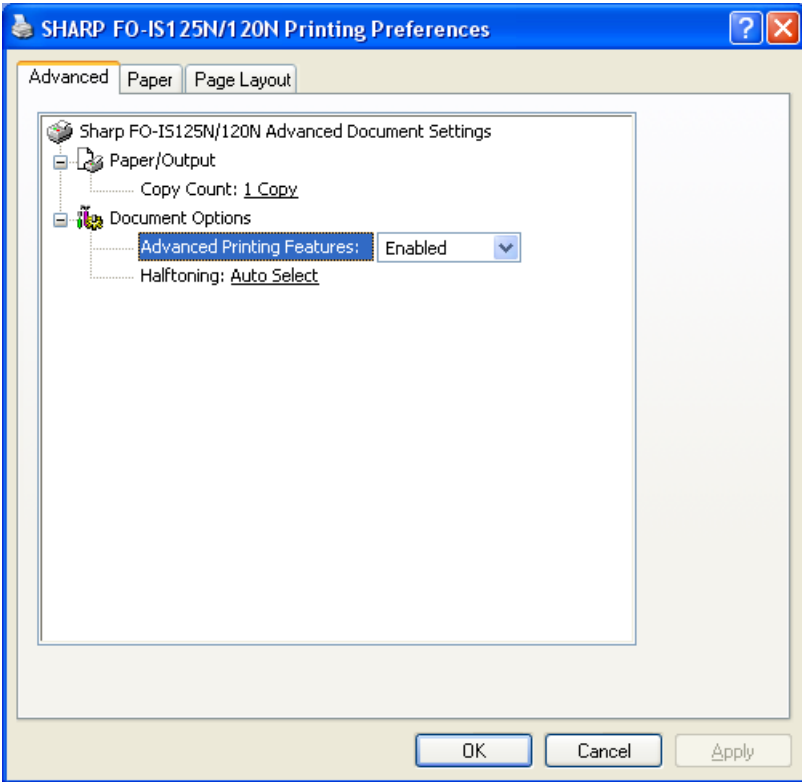

Copy Count: To change the number of copies printed of each page of your document, click this setting and enter the desired number.

Advanced Printing Features: Normally this is set to **Enabled** to allow you to use the advanced printing features.

Halftoning: This is normally set to **Auto Select** to let the printer select the best halftone setting.

To save your settings and close the window, click **OK**. To save your settings without closing the window, click **Apply**. To cancel your settings and close the window, click **Cancel**.

7. Making Copies

The machine can be used as a convenience copier. Follow the steps below to make copies.

Sorting copies

The machine is initially set to not sort copies. If you wish to have copies sorted as shown below, change the "SORT COPY" setting to YES (pp. 136 and 140).

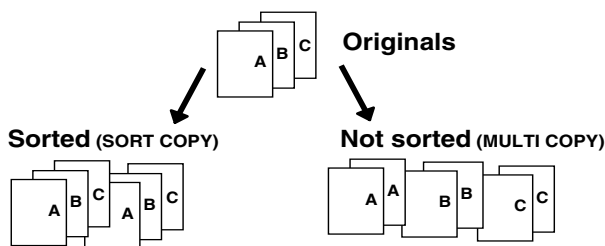



Example: Two copies
each of three originals

1 Load the document(s). (Maximum of 30 letter sheets or 5 legal sheets.)

- If desired, press ^{RESOLUTION} to set the resolution and/or contrast.

2 Select the following copy settings as needed:

- **Enlarge/reduce:** Press  or  to select 100%, 125%, 135%, 200%, 70%, 88% or 94%.
Default setting: 100%.
- **Number of copies per original:** Enter a number from 1 to 99.
Default setting: 1
Example: Press for two copies

3 When you are ready to begin copying, press .

If [MEMORY FULL] appears...

If you place many originals in the feeder, the memory may become full before all pages can be scanned (the display will show **[MEMORY FULL]**). If this happens, only the pages that were scanned will be copied and the remaining pages will automatically feed out. Repeat the copy procedure for the remaining pages, including the page that was being scanned when the memory became full.

Note: It may not be possible to make a copy of an original if a high resolution setting is used and/or the original contains so much detailed content that the memory becomes full before scanning finishes.

8. Special Functions

Broadcasting

You can send the same document to as many as 50 fax or e-mail destinations in just one operation.

- ◆ The destinations must be all fax or all e-mail. It is not possible to mix fax and e-mail destinations.
- ◆ Only destinations stored in Rapid Keys and Speed Dial numbers can be selected. (It is not possible to enter a full fax number or e-mail address.)

1 Load the document(s).

- If desired, press ^{RESOLUTION} to set the resolution and/or contrast.

2 Press .

3 Press to broadcast to FAX destinations, or to broadcast to E-MAIL destinations.



4 Select a destination using one of the following methods:

- Press a Rapid Key.
- Press ^{SPEED DIAL} and enter a 3-digit Speed Dial number.
- Press or until the desired destination appears in the display.



5 Press to enter the destination.

6 Repeat Steps 4 and 5 for each of the other desired destinations (maximum of 50).

Broadcasting



- You can press  to scroll through and check your entered destinations. To delete a destination, press  when it appears.

7 When you have finished selecting destinations, press .

- If you are broadcasting to fax destinations, transmission will begin.
- If you are broadcasting to e-mail destinations, you can press  to select e-mail options (see Steps 4 to 6 on page 43). When you are ready to begin transmission, press .
- For fax, a Transaction Report is automatically printed out after Broadcasting is completed. If any destinations in the "Note" column of the report are marked "Busy" or have a communication error code, you will need to send the document to those destinations again.

If the memory becomes full...

If the memory becomes full during scanning, **[MEMORY FULL]** will appear in the display.

- ◆ Press  to send the pages which have been stored up to that point in memory (the remaining pages will automatically feed out). After transmission, the memory will be cleared and you can send the remaining pages. You will also need to send the page which was being scanned when the memory filled up.
- ◆ To cancel the entire transmission, press .



Broadcasting using a Group Key

If the destinations to which you want to broadcast have all been stored in one Group Key (see *Storing numbers in Group Keys* which follows), you can perform the broadcast operation using the following simplified procedure:

1 Load the document(s).

- If desired, press  to set the resolution and/or contrast.

2 Press the Group key.

- If the group is a fax group, transmission will begin.
- If the group is an e-mail group, you can press  to select e-mail options (see Steps 4 to 6 on page 43). When you are ready to begin transmission, press .



Storing destinations in Group Keys



Follow the steps below to store a group of destinations in a Group Key.

- ◆ Any Rapid Key not already in use can be used as a Group Key. A key cannot be simultaneously programmed as both a Group Key and a Rapid Key.
- ◆ Up to 50 fax or e-mail destinations can be stored in one Group Key.
- ◆ The destinations must be all fax or all e-mail. It is not possible to mix fax and e-mail destinations.
- ◆ Only Rapid Key and Speed Dial numbers can be stored in a Group Key. Full numbers cannot be stored.

Broadcasting

1 Press ^{FUNCTION} , then  until [ENTRY MODE] appears.



2 Press , then  until [GROUP ENTRY] appears.

3 Press  (SET) to store a group. (Press  (CLEAR) to clear a group.)

4 Press the Rapid Key that you want to use as a Group Key. (If you are clearing a Group Key, press the Group key that you want to clear and go to Step 8.)



- If [ALREADY STORED] or [RAPID # STORED] appears, the key has already been programmed. Clear the key or try another Rapid Key.

5 Select a destination using one of the following methods:

- Press a Rapid Key.
- Press ^{SPEED DIAL}  and enter a 3-digit Speed Dial number.
- Press  or  until the desired destination appears in the display.

6 Press  to enter the destination.

7 Repeat Steps 5 and 6 for each of the other desired destinations (maximum of 50).

- You can press  to scroll through and check your entered destinations. To delete a destination, press  when it appears.

8 When you have finished entering the destinations, press .



9 Press to exit.

Distinctive Ring (Requires Service)

Important: To use this function, you must subscribe to a Distinctive Ring service from your telephone company. The machine may not be compatible with some Distinctive Ring services.

Distinctive Ring is a service offered by some local telephone companies whereby they assign an additional second number to your regular single line. The second number rings differently from your normal number.

If you subscribe to a Distinctive Ring service, you can set the machine to automatically answer when your second number is called. This allows you to use the second number as an exclusive fax number.

1 Press ^{FUNCTION} , then  until [OPTION SETTING] appears.

2 Press , then  until [DISTINCTIVE RING] appears.

3 Select the ring pattern below that matches the ring pattern of your second number. (To use your first number as a fax number, select STANDARD RING.)

Distinctive Ring (Requires Service)

- 1 RING PATTERN 1
Two short rings
- 2 RING PATTERN 2
One short, one long, and one short ring
- 3 RING PATTERN 3
Two short rings and one long ring
- 4 RING PATTERN 4
Three very short rings
(Canada only)
- 5 RING PATTERN 5
Two very short rings
(Canada only)
- 6 STANDARD RING
Your standard (normal) ring pattern
- 7 OFF SETTING
Turn distinctive ring off

4 If you changed the setting from “OFF SETTING” to any of the ring patterns, [SUBSCRIBED THIS SERVICE?] will appear. If you have subscribed to a distinctive ring service, press . (Otherwise, press any other key to return to Step 3 and select “OFF SETTING”.)

5 Press  to exit.

6 Press  to set the reception mode to AUTO.

- ◆ To use Distinctive Ring, the reception mode must be set to AUTO. When your designated fax number is dialed, the machine will automatically answer and begin reception after two rings. If one of your other numbers is dialed, the machine will ring; however, it will not answer.

Blocking Unwanted Faxes

The Anti Junk Fax function blocks reception of faxes from fax numbers that you specify.

To use this function, enter the fax numbers that you want to block. Up to five numbers can be entered.

1 Press  , then  until [ENTRY MODE] appears.

2 Press  , then  until [ANTI JUNK #] appears.

3 Press .

4 Press .

5 Enter the fax number with the number keys (max. 20 digits).
Note: Enter numbers only; hyphens and spaces cannot be entered.

6 Press .

7 Return to Step 4 to store another number, or press  to exit.

- ◆ When a fax is blocked, a transaction report (page 143) will print to inform you (unless “TRANSACTION LIST” on page 137 is set to “NEVER PRINT”).



Blocking Unwanted Faxes

Editing and clearing Anti Junk numbers

1 Press  , then  until [ENTRY MODE] appears.

2 Press  , then  until [ANTI JUNK #] appears.

3 Press .



4 Press  or  until the number you want to edit or clear appears in the display.

5 Press .

6 Press  for EDIT or  for CLEAR.

- If you selected CLEAR, go to Step 8.

7 If you selected EDIT, make the desired changes to the number.

- Press  or  to move the cursor to the digit or digits you wish to change, and then enter the new digit. The new digit will replace the old digit. You can also press  to backspace and clear digits.

8 Press .

9 Press  to exit.

Duplex Scanning

Duplex Scanning is convenient for transmitting or copying two-sided documents. When this function is selected, you simply feed all pages of the document through the machine once, turn the stack of pages over, and feed the stack through again. The machine will automatically sort the pages into the correct order (front of 1st page, back of 1st page, front of 2nd page, back of 2nd page, etc.).

- ◆ Note that any blank sides must be included when scanning the pages (if the number of pages is not equal each time the machine scans the stack, an error will result).

1 Load the documents. Make sure the pages are placed front-side down, with the first page on the bottom.

- If desired, press ^{RESOLUTION} to set the resolution and/or contrast.

2 Press  and then .

3 Perform all steps of the desired copy or transmission operation.

4 When all pages of the document have been scanned, turn the stack over (do not change the page order) and load the stack again.

5 Press .

Receiving Faxes to E-mail/Folder

If you have connected the machine to a network, you can have incoming faxes from specified fax numbers (or all fax numbers) automatically converted to e-mail and forwarded to designated e-mail recipients, or converted to image files and forwarded to a network folder or FTP server.

- ◆ This provides a convenient means of forwarding received faxes to someone who is out of the office.
- ◆ This function can be used to send copies of all received faxes to an administrator or network folder for centralized document storage.

Storing (or clearing) groups of originating fax numbers and forwarding e-mail addresses

To use the Fax to E-mail/Folder function, you must first store one or more groups of originating fax numbers and forwarding destinations (e-mail address, network folder, or FTP server).

- ◆ One originating fax number and one forwarding destination can be stored in each group. When a fax is received, the machine will check each stored group, and if the originating number of the received fax matches the originating fax number in one of the groups, the machine will forward the fax to the forwarding destination in that group.
- ◆ You can also omit entry of an originating fax number in a group and have faxes from all originating fax numbers forwarded to the forwarding destination.
- ◆ Up to 30 groups can be stored.
- ◆ If the same originating fax number (or “ALL TRANSFER”) is stored in two or more different groups, a network folder or FTP server can only be specified as the forwarding destination in one group; the forwarding destination of the other group(s) must be an e-mail address.

1 Press  **FUNCTION**, then  until **[FAX TO E-MAIL/FOLDER]** appears.

2 Press  , then  until **[FORWARDING ADDRESS]** appears.

3 Press  to select “SET”.

- To clear a previously stored group, press .

4 Enter a 2-digit number from “01” to “30” (this number is used to identify the group you will store).



- If you are clearing a group, enter the 2-digit number of the group you wish to clear and go to Step 8

5 Enter the originating fax number.

- If you wish to have faxes from all originating fax numbers forwarded (“ALL TRANSFER”), go directly to Step 6 without entering a fax number.

6 Press .

7 Specify the destination (e-mail address, network folder, or FTP server) to which you wish to have the faxes forwarded using one of the methods below:

- **Rapid Key Dialing:** Press a Rapid Key.
- **Speed Dialing:** Press  and enter a 3-digit Speed Dial number.
- **Search Dialing:** Press  or  until the destination appears in the display.

8 Press . The group is stored.

- If [NETWORK FOLDER/FTP IS ALREADY USED] appears, the same originating fax number (or “ALL TRANSFER”) has already been stored in a group with a network folder or FTP forwarding destination. In this case, only an e-mail address can be stored for the forwarding destination.

Receiving Faxes to E-mail/Folder

Activating (and deactivating) Fax to E-mail/Folder

After you have stored one or more Fax to E-mail/Folder groups, follow the steps below to activate the Fax to E-mail/Folder function.

1 Press  , then  until [FAX TO E-MAIL/FOLDER] appears.

2 Press  .
Display: [ACT. FAX TO MAIL/FLDR]

3 Press to select "ON".

- To deactivate the function, press to select "OFF".

4 Press to exit.

Printing forwarded faxes

The machine is initially set to print received faxes that are forwarded. If you prefer that the machine only print forwarded faxes when a forwarding error occurs, follow the steps below.

1 Press  , then  until [FAX TO E-MAIL/FOLDER] appears.

2 Press  , then  until [PRINT RECEIVED FAX] appears.

3 To have all forwarded faxes printed, press ("ALWAYS PRINT").
To have forwarded faxes printed only when a forwarding error occurs, press to select "PRINT ERROR ONLY".

4 Press to exit.

Searching for an Address in a Global Address Book

If you have connected the machine to a network and have an LDAP server on the network, you can search for a destination in a global address book on the LDAP server. The retrieved address can be used as the destination for a Scan to E-mail transmission or fax transmission.

Configuring LDAP server information

To search for an address in a global address book, your LDAP server information must first be configured in the machine's Web page.

- ◆ Consult your network administrator for the information that must be entered.

Open the machine's Web page as explained on page 32 and click **LDAP** under **Network Settings** in the menu frame. The **LDAP Setup** screen will appear.

In **LDAP**, select **Enable**.

Enter the host name or IP address of your LDAP server in **LDAP Server** (if the authentication type is DIGEST-MD5, only the host name can be entered).

- ◆ To check the host name of your LDAP server, click the **Start** button on the LDAP server and then select **Control Panel** and **System**. Select the **Computer Name** tab. The host name appears in **Full computer name**.

Enter the remaining settings as appropriate for your system. (Click **Help** for explanations of each of the settings.)

Example screens are shown on the following pages for when the **Authentication Type** is **SIMPLE** and when the **Authentication Type** is **DIGEST-MD5** in Active Directory.

Searching for an Address in a Global Address Book

Example screen when the authentication type is "SIMPLE"

Enter the host name (see page 123) or the IP address of the LDAP server

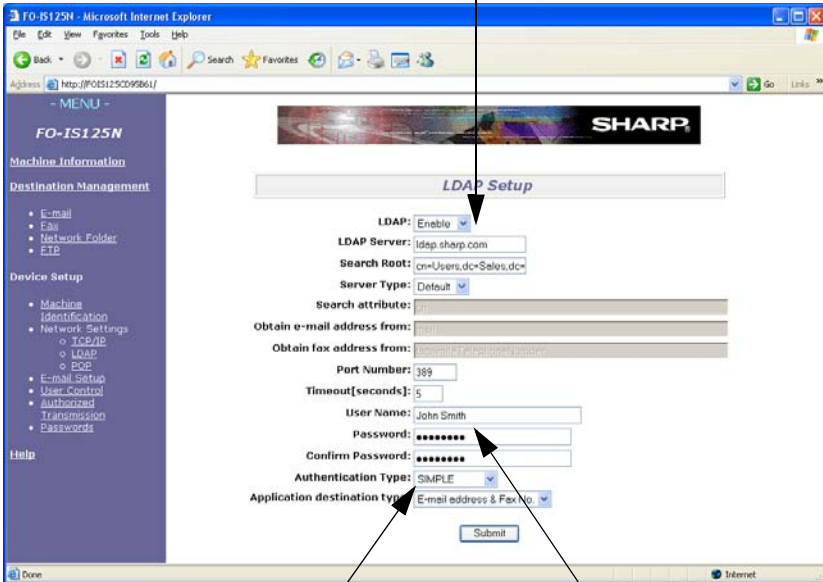

Select **SIMPLE** for the **Authentication Type**

For the **User Name**, enter the name that appears in **Display name** on the **General** tab of the user properties of any user stored on the Active Directory. For the **Password**, enter the password of that user. (These entries are used for connection to the Active Directory.)

When user authentication is activated on the machine...

When user authentication by user name and password is activated on the machine and the LDAP server authentication type is SIMPLE, you must enter your **Display name** for the user name when you log on at the machine (the **Display name** appears on the **General** tab of your user properties on the Active Directory).

Searching for an Address in a Global Address Book

Example screen when the authentication type is "DIGEST-MD5"

Enter the host name of the LDAP server (see page 123)

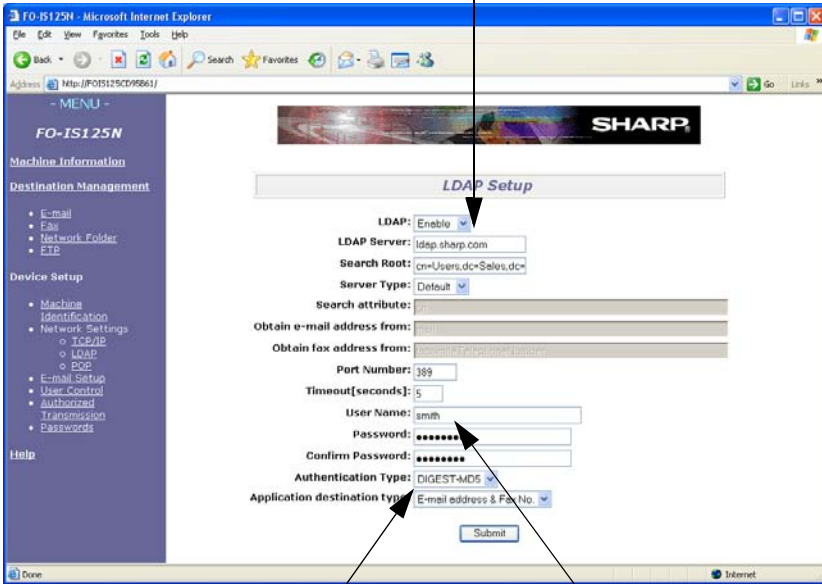

Select **DIGEST-MD5** for the **Authentication Type**

For the **User Name**, enter the name that appears in **User logon name** on the **Account** tab of the user properties of any user stored on the Active Directory. For the **Password**, enter the password of that user. (These entries are used for connection to the Active Directory.)

When user authentication is activated on the machine...

When user authentication by user name and password is activated on the machine and the LDAP server authentication type is DIGEST-MD5, you must enter your **User logon name** for the user name when you log on at the machine (the **User logon name** appears on the **Account** tab of your user properties on the Active Directory).

Searching for an Address in a Global Address Book

Searching for an address in a global address book

Follow the steps below to search for a fax number or e-mail address on the LDAP server when sending a fax or performing a Scan to E-mail transmission.

1 Load the document(s).

- If desired, press ^{RESOLUTION} to set the resolution and/or contrast.

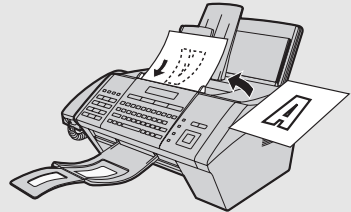

2 Press .





3 Enter a keyword with the letter keys.

- The keyword is normally the name of the person or destination whose fax number or e-mail address you are searching for.



4 Press .

- [SEARCHING...]/[PLEASE WAIT] appears while the LDAP server searches for the destination.



5 When the LDAP server completes the search, the name of the first matching person or destination will appear in the display. Press repeatedly to scroll through all persons/destinations that the server found (press to scroll backward).

- To show details on a displayed destination, press , and then press  to show the e-mail address or  to show the fax number. (If multiple e-mail addresses or fax numbers are stored, continue to press  or  to show the other e-mail addresses / fax numbers.) If an e-mail address or fax number is not stored, the down or right arrow mark will not appear in the second line of the display.
- If **[TOO MANY MATCHES]/[RE-ENTER KEYWORD]** appears, the server found more than 60 matches for the keyword you entered. Try entering a new keyword that will narrow the scope of the search (for example, a keyword with more letters).
- If **[NO MATCHING ADDRESS]/[RE-ENTER KEYWORD]** appears, the server does not have any entries that match your entered keyword. Enter a different keyword.

6 When the desired destination appears in the display, press .

- If you pressed  without displaying the fax number or e-mail address of the destination, **[SELECT DEST. TYPE]** will appear. Press (FAX) to send to the fax number, or (E-MAIL) to send to the e-mail address.
- If you pressed  with the fax number of the destination displayed, you will send to the fax number. If you pressed  with the e-mail address displayed, you will send to the e-mail address.

7 If you are sending to the fax number, scanning and transmission will begin.

If you are sending to the e-mail address, you can press  to begin scanning and transmission immediately, or  to select the e-mail options (see Steps 5 through 7 on pages 43 and 44).

Polling (Requesting a Fax)

Polling (Requesting a Fax)

Polling allows you to call another fax machine and have it send a document (previously loaded in its feeder or in memory) to your machine without assistance from the operator of the other machine.

Note: Polling is useful when you want the receiving fax machine, not the transmitting fax machine, to bear the cost of the call.





- ◆ To use the polling function, the other machine must be capable of being polled. Before polling, make sure the other machine is set up to receive your polling request.

Enabling the polling key

To use Polling, you must first set "POLLING" to "YES" and select a Rapid Key for use as the polling key in the Option Settings as explained on pages 136 and 138.

Using polling to request fax transmission

1 Dial the fax machine that you wish to poll using one of the following methods:

- Enter the full number using the numeric keys.
- Press ^{SPEED DIAL}  and enter a 3-digit Speed Dial number.
- Pick up the handset (or press ^{SPEAKER} ) and dial the full number or press a Rapid Key. Wait for the fax answerback tone.
- Press  or  until the name (or number) of the other party appears in the display

2 Press the Rapid Key that you specified as the polling key in the Option Settings.

- If you used the handset, replace it when POLLING appears in the display. Reception will begin.



Being polled (Memory polling)

To let another fax machine poll your machine, you must first scan the document into memory using the following procedure. Transmission will take place when the other fax machine calls your machine and activates polling. You can choose whether to allow polling only once, or an unlimited number of times.

- ◆ If you allow polling only once, the document will be automatically cleared from memory after polling. If you allow polling an unlimited number of times, the document will remain in memory until you clear it as explained on page 130.

1 Load the document.

- If desired, press ^{RESOLUTION}  to set the resolution and/or contrast.

2 Press ^{FUNCTION} , then  until [MEMORY POLLED] appears.**3 Press .****4 Press  to select SET.
Display: [1=ONCE, 2=REPEAT]****5 Press  to allow polling only once, or  to allow polling an unlimited number of times.****6 Press .**



- The document is scanned into memory.

7 Set the reception mode to AUTO (press ^{RECEPTION}  until "AUTO" appears in the display).

Polling (Requesting a Fax)

Clearing a memory polling document

To clear a memory polling document from memory, follow the steps below.

1 Press  , then  until [MEMORY POLLED] appears.

2 Press .

3 Press  to select CLEAR.

4 Press  to clear the document.



5 Press  to return to the date and time display.



Polling security

Polling Security allows you to prevent unauthorized polling of your machine. When this function is turned on, polling will only be allowed when the fax number of the polling machine has been entered in your machine's list of permitted fax numbers (called "passcode numbers"). The number of the polling machine must also be correctly programmed in that machine for identification.

To use Polling Security, follow the steps below to turn the function on, and then enter permitted numbers as explained on the following page.

1 Press  , then  until [ENTRY MODE] appears.

2 Press  , then  until [POLLING SECURITY] appears.

3 Press  (ON) to turn on polling security.
(To turn off polling security, press  (OFF).)

4 Press  to exit.

Storing fax numbers for polling permission

You can store up to 10 fax numbers in your machine's list of permitted numbers.

1 Press  , then  until [ENTRY MODE] appears.

2 Press  , then  until [POLLING PASSCODE] appears.

3 Press .

4 Press .

5 Enter the fax number with the number keys (max. 20 digits).
Note: Enter numbers only; hyphens and spaces cannot be entered.

6 Press .

7 Return to Step 4 to store another number, or press  to exit.



Polling (Requesting a Fax)

Editing and clearing polling permission numbers

1 Press ^{FUNCTION} , then  until [ENTRY MODE] appears.

2 Press , then  until [POLLING PASSCODE] appears.

3 Press .



4 Press  or  until the number you want to edit or clear appears in the display.

5 Press .

6 Press for EDIT or for CLEAR.

- If you selected CLEAR, go to Step 8.

7 If you selected EDIT, make the desired changes to the number.

- Press  or  to move the cursor to the digit or digits you wish to change, and then enter the new digit. The new digit will replace the old digit. You can also press to backspace and clear digits.

8 Press .

9 Press to exit.

Timer Transmission

The Timer function allows you to store a fax transmission job to be performed automatically at a time you specify. The time can be specified up to 24 hours in advance.

- ◆ You can use this function to take advantage of lower off-peak rates without having to be there when the transmission is performed.
- ◆ Up to 15 timer jobs can be stored at once.
- ◆ Multiple destinations can be entered if all are stored in Rapid Keys or Speed Dial numbers. A Group Key can also be used (once a Group Key is used, no further destinations can be entered).
- ◆ A destination can be specified by entering a full fax number with the number keys, however, in this case only one destination can be entered.

1 Load the document(s).

- If desired, press ^{RESOLUTION} to set the resolution and/or contrast.

2 Press ^{FUNCTION}, then until [TIMER SEND] appears.

3 Press .

4 Press 1 to select "SET".

5 Enter the time at which the fax is to be transmitted.

- Enter a two-digit number for the hour ("01" to "12") and a two-digit number for the minute ("00" to "59").



Example: 9:25 0 9 2 5

6 Press * to select A.M. or # to select P.M.

Timer Transmission



7 Press .

8 Enter the fax number using one of the methods below:

- **Rapid Key Dialing:** Press a Rapid Key.
- **Speed Dialing:** Press  and enter a 3-digit Speed Dial number.
- **Search Dialing:** Press  or  until the name or number of the other party appears in the display.
- **Group Dialing:** Press a Group Key. Go directly to Step 11 (once a group key is selected, no further destinations can be entered).
- **Direct Keypad Entry:** Enter the full fax number with the number keys. Go directly to Step 11 (when a full fax number is entered, only one destination can be entered).

9 Press . If you wish to enter more destinations, go to Step 10. If you have finished entering destinations or are only entering one destination, go to Step 11.

10 Repeat Steps 8 and 9 for each of the destinations that you wish to enter. (A maximum of 50 destinations can be entered.)

- You can press  to scroll through and check your entered destinations. To delete a destination, press  when it appears.

11 Press .

- The document will be scanned into memory and the timer number assigned to the job will appear briefly in the display. Transmission will take place at the specified time.
- If **[MEMORY FULL]** appears, see *If the memory becomes full* on page 112.



Checking and canceling stored timer transmission jobs

Follow the steps below to check the timer transmission jobs that are stored. If needed, you can also use this procedure to cancel a stored job.

1 Press  , then  until [TIMER SEND] appears.

2 Press .

3 Press  to select "REVIEW".

4 Press  or  to scroll through the stored timer transmission jobs.

- For each job, the timer number, the destination, and the specified time appear.



5 To cancel a displayed job, press  . Press  once again to complete the cancelation (press  if you do not wish to cancel).

6 When finished, press  to exit.

9. Option Settings

The option settings allow you to customize the operation of the machine to better suit your needs.

The option settings have been initially configured at the factory. To change a setting, follow the steps below to display the setting, and then enter a new selection for the setting as explained in the table that follows.

1 Press  ^{FUNCTION}, then  until [OPTION SETTING] appears.

2 Press  , then  repeatedly until the desired setting appears.



- The option settings are described in the table below and on the following pages.

3 Enter a selection for the setting by pressing the number keys as explained in the table.

4 After entering a selection, the subsequent option setting will appear in the display. To exit the settings, press .

Option Settings

Make a selection for the displayed setting as explained below. This is done in step 3 of the above procedure.

Setting	Description
FINE PRIORITY	This is used to change the default resolution for faxing from STANDARD to FINE. Press  (YES) to select FINE, or  (NO) to select STANDARD. Initial setting: NO (STANDARD)



NUMBER OF RINGS	<p>This sets the number of rings on which the machine answers calls when the reception mode is set to AUTO. Enter any number from 1 to 5.</p> <p>Initial setting: 4 rings.</p> <p>Note: If you have turned on Distinctive Ring (page 115), the machine will answer after 2 rings regardless of this setting.</p>
TRANSACTION LIST	<p>This sets the condition for printing transaction reports (see page 143). Press a number key as follows:</p> <p><input type="checkbox"/> 1 (ALWAYS PRINT): Print after every fax transmission, reception and error.</p> <p><input type="checkbox"/> 2 (ERROR/MEMORY): Print only after an error or memory operation.</p> <p><input type="checkbox"/> 3 (SEND ONLY): Print after every fax transmission.</p> <p><input type="checkbox"/> 4 (ERROR ONLY): Print only when an error occurs.</p> <p><input type="checkbox"/> 5 (NEVER PRINT): Never print.</p> <p>Initial setting: ERROR ONLY</p>
DIAL MODE	<p>This sets the dial mode. Press <input type="checkbox"/> 1 (TONE) if you are on a tone dial line, or <input type="checkbox"/> 2 (PULSE) if you are on a pulse dial line.</p> <p>Initial setting: TONE</p>
DISTINCTIVE RING	<p>If you subscribe to a distinctive ring service from your phone company, use this setting to select the ring pattern of the phone number that you will use as a fax number. For more information, see page 115.</p> <p>Initial setting: OFF SETTING</p>

Option Settings

FAX SIGNAL RX	<p>If you hear a soft fax tone after the machine rings and you answer on the machine's handset or an extension phone connected to the same line, the machine will automatically begin reception. If desired, you can turn automatic reception off. Press <input type="checkbox"/> 1 (YES) to turn on the the automatic reception function, or <input type="checkbox"/> 2 (NO) to turn off the function. If you select NO, you must start reception manually by pressing <input type="button" value="START"/> on the machine each time you hear a soft fax tone after answering a call.</p> <p>Initial setting: YES</p>
POLLING	<p>If you wish to use a Rapid Key as a polling key, press <input type="checkbox"/> 1 (YES), press the Rapid Key that you wish to use (any Rapid Key not already in use), and then press <input type="button" value="START"/>.</p> <p>If you do not wish to use the polling function, press <input type="checkbox"/> 2 (NO).</p> <p>Note: When a Rapid Key is used as the polling key, it cannot be used for Rapid Key Dialing.</p> <p>Initial setting: NO</p>
AUTO PRINT OUT	<p>Press <input type="checkbox"/> 1 (YES) to have the machine automatically print an Activity Report once every 40 send/receive operations. (The report can still be printed manually at any time.) Press <input type="checkbox"/> 2 (NO) to turn off Auto Print Out.</p> <p>Initial setting: NO</p>
ECM MODE	<p>Press <input type="checkbox"/> 1 (YES) to have any distortions in a transmission due to noise on the telephone line automatically corrected before print-out at the receiving end. This is only effective when the other machine has ECM as well. Press <input type="checkbox"/> 2 (NO) to turn off ECM mode. (When there is considerable noise on the line, you may find that ECM slows transmission. Turning off ECM mode may increase transmission speed.)</p> <p>Initial setting: YES</p>

<p>DAY LIGHT SAVING</p>	<p>To have the machine's clock automatically move forward and backward at the beginning and end of daylight saving time, press <input type="text" value="1"/> (YES). To turn off this feature, press <input type="text" value="2"/> (NO).</p> <p>If you pressed <input type="text" value="1"/> for YES, set the days on which daylight saving time starts and ends:</p> <ol style="list-style-type: none"> 1. The display will successively show each month of the year. <p>Press <input type="text" value="START"/> when the starting month of daylight saving time appears, or enter a 2-digit number for the month (for example, press <input type="text" value="0"/>, <input type="text" value="3"/> for March).</p> <ol style="list-style-type: none"> 2. Enter the number of the week that daylight saving time starts (for example, press <input type="text" value="3"/> for the third week). 3. Enter a number for the day of the week on which daylight saving time starts (0= Sunday, 1=Monday, 2=Tuesday, 3=Wednesday, 4=Thursday, 5=Friday, 6=Saturday).. 4. Press <input type="text" value="START"/>. 5. Repeat Steps 1 through 4 to set the day on which daylight saving time ends. <p>Initial setting: NO</p>
<p>DIAL TONE DETECTION</p>	<p>Press <input type="text" value="1"/> (YES) to have the machine verify the presence of a dial tone on the line before automatic dialing. Press <input type="text" value="2"/> (NO) to turn this function off.</p> <p>Note: If you select YES and find that the machine is unable to dial, change the setting to NO.</p> <p>Initial setting: NO</p>
<p>KEY TONE</p>	<p>Press <input type="text" value="1"/> (ON) to have the machine sound a beep each time a key is pressed on the operation panel (this confirms that the key has been correctly pressed). Press <input type="text" value="2"/> (OFF) to turn off the beep sound.</p> <p>Initial setting: ON</p>

Option Settings

SEARCH BY ◀▶ KEY	<p>Press <input type="text" value="1"/> if you want all stored destinations to appear when the  and  keys are used to search for a transmission destination. Press <input type="text" value="2"/> if you only want fax destinations to appear.</p> <p>Initial setting: SHOW ALL ADDRESSES</p>
PAPER SIZE	<p>This sets the size to which the machine scales printed images. Press <input type="text" value="1"/> (LETTER) if you loaded letter size paper, or <input type="text" value="2"/> (LEGAL) if you loaded legal size paper.</p> <p>Initial setting: LETTER</p>
RECEIVE RATIO	<p>Press <input type="text" value="1"/> (AUTO) to have the machine automatically reduce the size of received faxes to fit the size of the printing paper. This ensures that the edges of a fax are not cut off. (Note: AUTO may not operate if the received fax is too long, contains many fine graphics or images, or is sent at high resolution. In this case, the remainder of the fax will be printed on a second page.) Press <input type="text" value="2"/> (100%) to have all faxes printed at full size (if a fax is too long to fit on the paper, the remainder will be printed on a second sheet; note that the cut-off point may occur in the middle of a line).</p> <p>Initial setting: AUTO</p>
SORT COPY	<p>This setting determines whether or not copies are collated (sorted into sets) when multiple copies of each original page are made. Press <input type="text" value="1"/> (YES) to have copies automatically sorted, or <input type="text" value="2"/> (NO) to have copies grouped by page.</p> <p>Initial setting: NO</p>

10. Checking Stored Information

Printing lists

You can print lists showing settings and information stored in the machine.

1 Press  , then  until [LISTING MODE] appears.

2 Press .

3 Press  or  until the desired list below appears.

- **ACTIVITY LIST:** This report shows information on your most recent transmissions and receptions (combined maximum of 40). The headings are the same as in the Transaction Report (see the next section). The logged transactions are erased after the report is printed. To have the report print automatically whenever the number of logged transactions reaches 40, see page 136 and “AUTO PRINT OUT” on page 138.
- **DESTINATION LIST:** This shows the destinations that have been stored in Rapid Key and Speed Dial numbers (pages 37 and 60).
- **GROUP LIST:** This shows the destinations that are stored in the Group Keys (page 113).
- **SETUP LIST:** This shows your currently entered sender’s name, sender’s number, and anti-junk fax number, your current selections for the option settings, print setup, and a sample of the header printed at the top of every fax page you transmit (HEADER PRINT).
- **TIMER LIST:** This shows the timer jobs that have been stored (page 133).
- **FAX TRANSFER LIST:** This shows the Receive Fax to E-mail settings that have been stored (page 120).
- **NETWORK SETTING LIST:** This shows the machine’s current IP address and other network/Internet settings (page 46).



4 Press  to print the list.

Checking how many Entry mode items have been stored

To quickly check how many Rapid Keys, Speed Dial numbers, Group Keys, polling codes, and anti-junk numbers have been stored, follow the steps below. The information will appear in the display.

1 Press , then  until [ENTRY] appears.

2 Press .

3 Press  or  to scroll through the items.

- The number stored of each item appears followed by a slash and the total number available. For example, **[RAPID&GROUP 15/36]/[(RAPID: 13 /GROUP: 2)]** indicates that 15 Rapid and Group Keys out of a total of 36 have been stored. The second line shows how many of these are Rapid Keys and how many are Group Keys.

4 Press  to exit.

Transaction Report

This report is printed out automatically after a fax is sent or received to allow you to check the result. The machine is initially set to print out the report only when an error occurs.

- ◆ The Transaction Report cannot be printed manually. To change the condition for automatically printing out Transaction Reports, see page 137 and "TRANSACTION LIST" on page 137.

Headings in the Transaction Report

SENDER/ RECEIVER	The name or fax number of the other machine.
START	Starting time.
TX/RX TIME	Total time taken for transmission/reception.
PAGES	Number of pages.
NOTE	<p>One of the following notes will appear under NOTE to indicate whether the fax was successful, and if not, why it failed.</p> <p>OK - Transmission/reception was successful.</p> <p>P.FAIL - A power failure prevented the transaction.</p> <p>JAM - The printing paper or document jammed.</p> <p>BUSY - The fax was not sent because the line was busy.</p> <p>COM.E-X - (Where "X" is a number.) A communication error occurred. See page 154.</p> <p>CANCEL - The fax was canceled because the STOP key was pressed, no document was in the feeder, or the other machine requested a function that your machine does not have.</p> <p>PAGE E. - A page count error occurred (see page 58).</p>

11. Maintenance

Cleaning the Scanning Glass and Rollers

Any dirt, fingerprints, or other small debris on the scanning glass will degrade the quality of faxes, scanned images, and copies. Clean the scanning glass and roller frequently as explained below.

- 1 Open the operation panel.

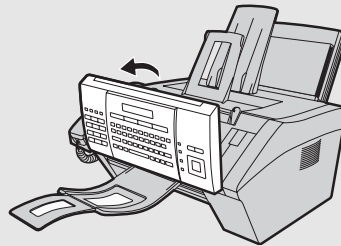

- 2 Rotate the lever toward you and down (1), and then pull the lever and right end of the roller up (2). Pull the white roller out to the right (3).

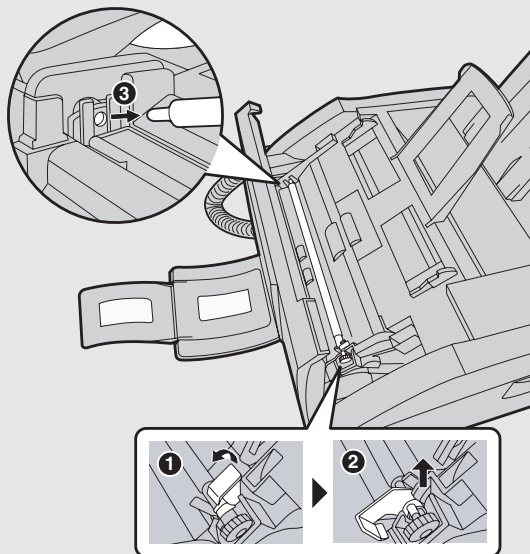

Cleaning the Scanning Glass and Rollers

- 3** Wipe the scanning glass, rollers, and rubber sheet with a clean cloth or swab.

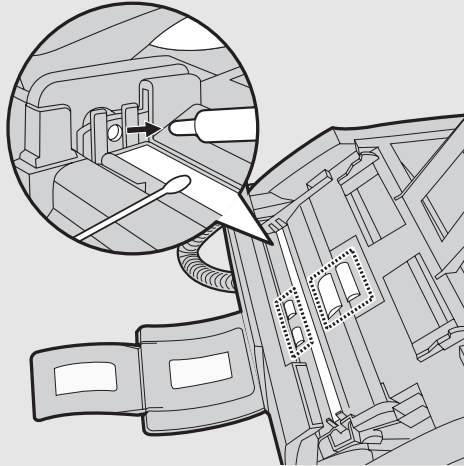

- Do not wipe off the grease on the ends of the white roller.
- Make sure that all dirt and stains (such as correcting fluid) are removed. Dirt and stains will cause vertical lines on transmitted images and copies.
- If the scanning glass is difficult to clean, try moistening the cloth with isopropyl alcohol or denatured alcohol. Take care that no alcohol gets on the rollers.
- Do not press down on the two front rollers.

Cleaning the Scanning Glass and Rollers

- 4** Replace the white roller, inserting the left end first (❶). Push the lever and right end of the roller down (❷). Rotate the lever back up and in, pushing it slightly to the right so that it fits into position (❸).

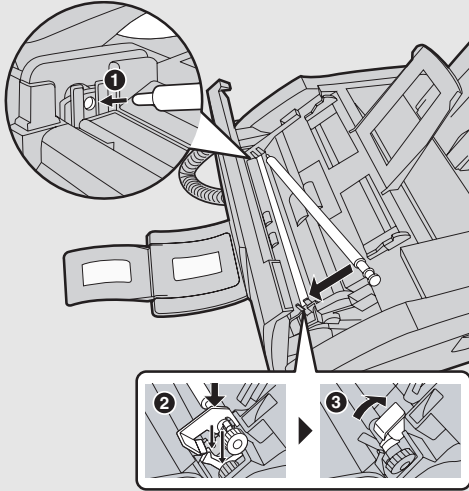

- 5** Close the operation panel, pressing down firmly on both sides to make sure it clicks into place.

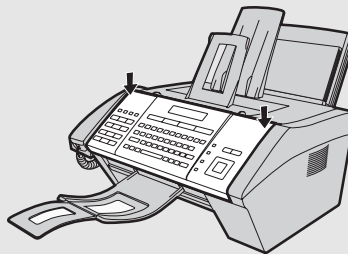

Cleaning the housing

Wipe the external parts and surface of the machine with a dry cloth.

Caution!

- ◆ Do not use benzene or thinner. These solvents may damage or discolor the machine.

Cleaning the Paper Feed Roller

Clean the paper feed roller regularly to remove dust and debris.

- ◆ A dirty paper feed roller will cause misfeeds and other paper feeding problems.

1 Remove the paper tray.

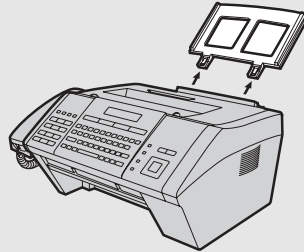

2 Pull the paper plate forward and clean the paper feed roller with a clean cloth.

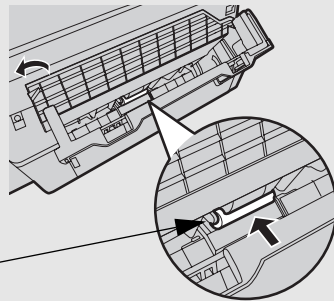

Clean this roller

3 Push the paper plate back down and replace the paper tray.

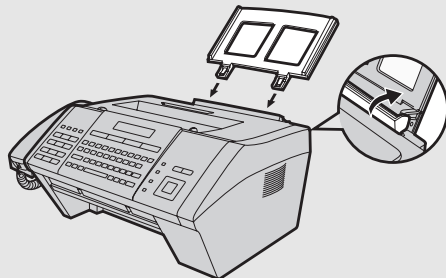

Replacing the Toner Cartridge

Replacing the Toner Cartridge

When the toner cartridge nears empty (about 200 pages can still be printed), TONER NEAR EMPTY will appear in the display. When the toner cartridge is empty, TONER EMPTY will appear in the display.

- ◆ When TONER EMPTY appears, printing will not be possible.

Replace the toner cartridge with the following cartridge:

SHARP FO-25ND toner cartridge

1 Open the top cover of the machine.

- **Caution!**

The fusing unit inside the print compartment becomes very hot during operation. Do not touch the inside of the print compartment after the machine has been in operation.

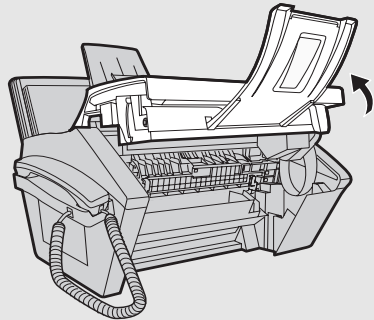

2 Press the release (1) and open the front cover (2).

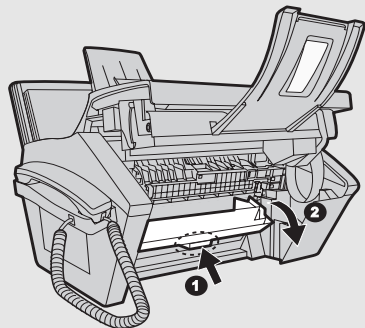

Replacing the Toner Cartridge

3 Open the side cover.

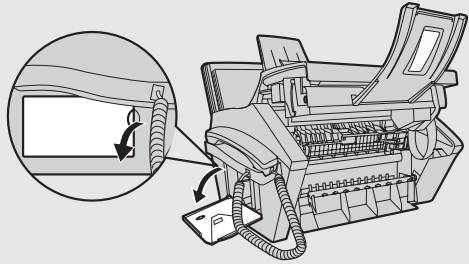

4 Push the toner cartridge handle to the left and then pull the toner cartridge out of the compartment.

- Dispose of the old toner cartridge according to local regulations. If in doubt, contact your local waste disposal agency.

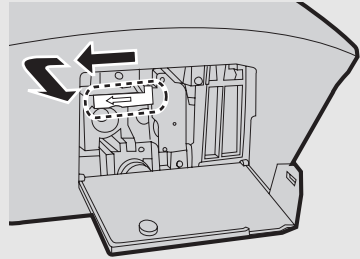

5 Continue from Step 6 on page 20 to install the new toner cartridge.

Replacing the Drum Cartridge

Replacing the Drum Cartridge

Viewing the total number of pages printed

To maintain the best printing quality, it is recommend that you replace the drum cartridge after 20,000 pages have been printed. To check the total number of pages printed, follow the steps below.

1 Press **INFO** and then  until [LIFE] appears in the display.

2 Press .

3 Press .

- The number of pages printed will appear in the display.

4 Press **STOP** repeatedly to exit.

Replacing the drum cartridge

When 20,000 pages have been printed, DRUM LIFE OVER will appear in the display. Replace the drum cartridge with the following cartridge:

SHARP FO-25DR drum cartridge

1 Open the top cover of the machine.

- **Caution!**
The fusing unit inside the print compartment becomes very hot during operation. Do not touch the inside of the print compartment after the machine has been in operation.

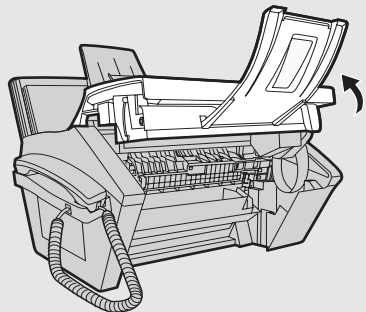

Replacing the Drum Cartridge

- 2** Press the release (❶) and open the front cover (❷).

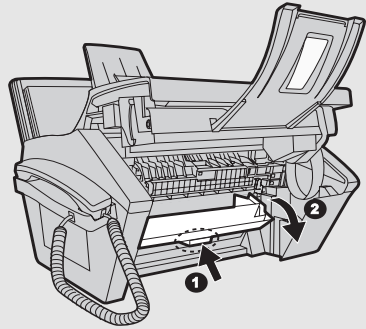

- 3** Open the side cover.

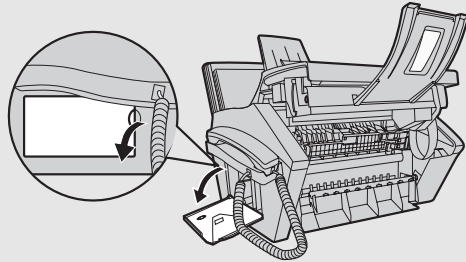

- 4** Push the toner cartridge handle to the left and then pull the toner cartridge out of the compartment.

- Place the toner cartridge on a sheet of paper on a level surface.
- Do not touch the roller in the toner cartridge.

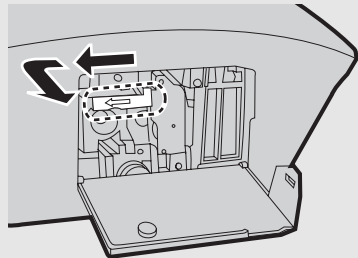

Replacing the Drum Cartridge

- 5** Grasp the drum cartridge handle and gently pull the old cartridge out of the machine.

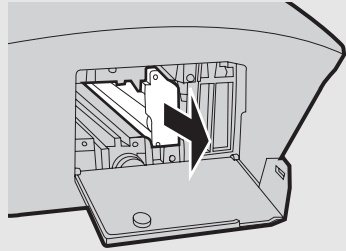

- 6** Remove the new drum cartridge from its packaging.

- 7** Insert the drum cartridge into the print compartment, sliding it along the guides.

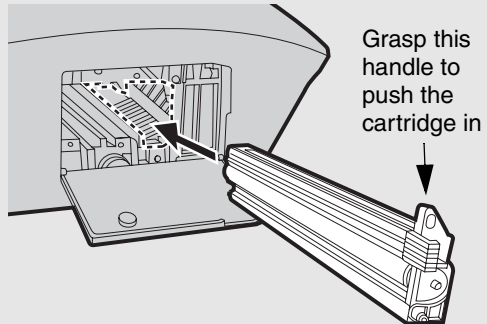

- Do not touch or allow other objects to contact the drum (the green cylinder). This may damage the drum. If fingerprints, dust, or other contaminants get on the drum, wipe it gently with a clean cloth.
- Exposure to light for more than several minutes will damage the drum. Be sure to insert the drum cartridge promptly into the machine.
- If you find it necessary to leave the cartridge out of the machine for more than several minutes, wrap the cartridge in black paper.

- 8** Replace the toner cartridge and close the side cover, inner cover, and top cover (Steps 7 and 8 on page 21).
When the display shows [TONER EXCHANGED?] / [1 = NEW, 2 = OLD],
press for “OLD” and then (Steps 9 and 10 on pages 21 and 22) .
When finished, reset the drum cartridge counter as explained on page 22.

12. Troubleshooting

Problems and Solutions

If you have any problems with the machine, refer to the following troubleshooting guide.

- ◆ For network connection problems, see page 31.

Line error

Problem	Solution
LINE ERROR appears in the display.	<p>A line error occurs when your machine cannot communicate correctly with the other fax machine. The error is usually due to a problem on the phone line.</p> <p>Press <input type="button" value="STOP"/> to clear the LINE ERROR message and then try the transaction again. If the error persists, check the following:</p> <ul style="list-style-type: none">• Check the connection. The cord from the TEL. LINE jack to the wall jack should be no longer than six feet.• Make sure there are no modem devices sharing the same telephone line.• Check with the other party to make sure their fax machine is functioning properly.• Have your telephone line checked for line noise.• Try connecting the machine to a different telephone line.• If the problem still occurs, your machine may need service.

Dialing and fax transmission problems

Problem	Solution
<p>No dial tone when you pick up the handset or press the SPEAKER key.</p>	<ul style="list-style-type: none"> • Make sure the handset cord is connected to the correct jack. See <i>Connecting the handset</i> on page 15. • Make sure that the telephone line is properly connected to both the TEL. LINE jack and the wall jack (see page 16). • Make sure that the telephone line is good.
<p>Dialing is not possible.</p>	<ul style="list-style-type: none"> • Make sure the power cord is properly plugged into a power outlet. • Make sure that the telephone line is properly connected to both the TEL. LINE jack and the wall jack (see page 16). • Make sure that the machine is set to the correct dialing mode for your telephone line. See the procedure on page 136 and “DIAL MODE” on page 137.
<p>The power is on, but no transmission takes place.</p>	<ul style="list-style-type: none"> • Make sure that the receiving machine has paper. • If the receiving machine is in manual mode with no attendant, reception will not be possible. • Check the display for error messages. • Pick up the handset and check for a dial tone. Dial the receiving machine manually and make sure that it is responding (you should hear a fax tone).
<p>Nothing is printed at the receiving end.</p>	<ul style="list-style-type: none"> • Make sure that the document for transmission is placed face down in the feeder.

Problems and Solutions

<p>A distorted image is received at the other end.</p>	<ul style="list-style-type: none">• Noise on the telephone line may cause distortion. Try sending the document again.• Make a copy of the document on your machine. If the copy is also distorted, your machine may need service.
--	--

Fax reception problems

Problem	Solution
<p>The machine doesn't receive documents automatically.</p>	<ul style="list-style-type: none">• Make sure that the reception mode is set to AUTO. If you subscribe to a distinctive ring service, make sure that the Distinctive Ring function is set to the correct ring pattern. If you do not subscribe to a distinctive ring service, make sure that Distinctive Ring is set to OFF SETTING. (See <i>Distinctive Ring</i> on page 115.)
<p>The paper comes out blank when you receive a fax.</p>	<ul style="list-style-type: none">• Make sure that the document is loaded properly in the feeder of the transmitting machine. Make a copy or print a report to confirm the printing ability of your machine.
<p>The received document is faint.</p>	<ul style="list-style-type: none">• Ask the other party to resend the document using a higher contrast setting.• If other printed output is also faint, the toner cartridge may need replacement (see page 148).
<p>Received images are distorted.</p>	<ul style="list-style-type: none">• Noise on the telephone line may cause distortion. Have the other party try sending the document again.• Make a copy or print a report on your machine. If the copy or report is also distorted, your machine may need service.
<p>When a fax is received, the size of the printed document image does not match the size of the paper.</p>	<ul style="list-style-type: none">• Make sure that the paper size setting is correct (see page 140).• Make sure that an appropriate reception ratio setting has been selected (see page 140).

<p>No reception occurs when polling is attempted.</p>	<ul style="list-style-type: none"> • Make sure the transmitting machine is in automatic reception mode. • If the transmitting machine has polling security, make sure that your fax number has been entered both in your machine (see page 24) and in the transmitting machine.
---	---

Copying problems

Problem	Solution
<p>The quality of copies is poor and/or dark vertical lines appear.</p>	<ul style="list-style-type: none"> • Any dirt or material on the scanning glass will cause spots to appear on copies and transmitted faxes. Clean the scanning glass as explained on page 144.
<p>The paper comes out blank when you make a copy.</p>	<ul style="list-style-type: none"> • Make sure the original is placed face down in the feeder.
<p>The size of the printed document image does not match the size of the paper.</p>	<ul style="list-style-type: none"> • Make sure that the paper size setting is correct (see page 140). • Make sure an appropriate enlarge/reduce setting is selected (see page 109).
<p>A copy is faint.</p>	<ul style="list-style-type: none"> • Adjust the contrast setting (see page 55). • If other printed output is also faint, the toner cartridge may need replacement (see page 148).



Problems and Solutions

General problems

Problem	Solution
Nothing appears in the display.	<ul style="list-style-type: none">• Make sure the power cord is properly plugged into a power outlet.• Connect another electrical appliance to the outlet to see if it has power.
The machine does not respond when you press any of its keys.	<ul style="list-style-type: none">• If a beep sound is not made when you press the keys, unplug the power cord, wait at least 5 seconds, and then plug it in again.
Automatic document feeding does not work .	<ul style="list-style-type: none">• Check the size and weight of the document (see page 52).
Printed output is faint.	<ul style="list-style-type: none">• The toner cartridge may need replacement (see page 148).
Dots appear at regular intervals on printed output.	<ul style="list-style-type: none">• The drum cartridge may be damaged. Replace the drum cartridge (see page 150).
Characters or parts of the image are missing from printed output.	<ul style="list-style-type: none">• Remove the drum cartridge as explained on page 150 and wipe the surface of the drum (the green cylinder) with a dry cotton swab. If print quality does not improve after wiping with a dry cotton swab, you can try moistening the swab with isopropyl alcohol or ethanol. However, do not moisten the swab with isopropyl alcohol or ethanol unless absolutely necessary, as this may cause stains or smears to appear on the first pages printed after cleaning (the stains may never completely disappear).

Messages and Signals

Display messages

<p>ADD PAPER &/ PRESS START KEY</p>	<p>Check the printing paper. If the tray is empty, add paper and then press . If there is paper in the tray, make sure it is inserted correctly (take out the stack, align the edges evenly, and then reinsert it in the tray) and then press . To simply clear the message and cancel printing (for example, if you need to immediately send or receive a fax), press .</p>
<p>CONNECTION ERROR</p>	<p>A Scan to E-mail transmission was not successful because of a communication problem on your local network. This is usually due to a problem with the cable connections. Make sure that the cable ends are securely inserted in the LAN ports. Make sure that the correct cable is being used and that the cable is good. Make sure that your router or hub is powered on.</p>
<p>CHECK E-MAIL SETTING</p>	<p>Scan to E-mail transmission is not possible because the SMTP server or the sender address has not been specified in the e-mail settings (see page 32).</p>
<p>COVER OPEN</p>	<p>The top, front, or side cover is open. Make sure each cover is completely closed (press down on the corners to make sure each cover is completely latched).</p>
<p>DOCUMENT JAMMED</p>	<p>The original document is jammed. See page 163 to clear the jam. Document jams will occur if you load more than 30 sheets at once or load documents that are too thick (see page 52). The document may also jam if the receiving machine doesn't respond properly when you attempt to send a fax.</p>
<p>DRUM LIFE OVER</p>	<p>This appears when the drum cartridge needs replacement.</p>

12. Trouble-shooting

Messages and Signals

FAX RX IN MEMORY	A fax has been received in memory because the toner cartridge needs replacement, you have run out of printing paper, or the paper is jammed. Another message will alternate with this message to indicate the problem. The fax will print out automatically when the problem is fixed.
HEATER HIGH / HEATER LOW / LASER ERROR	If this message appears, unplug the power cord and then plug it back in. If the message still appears, call for service.
LINE ERROR	Transmission or reception was not successful. Press <input type="button" value="STOP"/> to clear the message and then try again. If the error persists, see <i>Line error</i> on page 154.
M: xx%	This shows the percentage of the machine's memory currently in use.
M#xxx	This appears while a document is being scanned and indicates the memory number assigned to the job (the number appears in "xxx"). This number appears when you check or cancel a job with the <input type="button" value="INFO"/> key (page 67).
MEMORY FULL	If faxes have been received to memory because printing is not possible, resolve the problem so that printing can continue (see <i>Reception to Memory</i> on page 70). If faxes are being held in memory because the Secure Fax function has been activated, print the faxes as explained on page 85. If you are attempting to broadcast or transmit from memory, see <i>If the memory becomes full</i> on page 112. If you are copying, see <i>If MEMORY FULL appears</i> on page 110.
OUT OF PAPER / PRINT CANCELED	Printing was canceled because the tray is out of paper. Press any key to clear the message, add paper, and repeat the print job.
PAPER JAMMED	The printing paper is jammed. See page 165.

<p>PAPER MISMATCHED / CHECK PAPER SIZE</p>	<p>The paper size setting (page 140) does not match the size of paper loaded in the tray. Change the paper size setting or the size of paper loaded in the tray (for a print job from a computer, only the size of paper loaded in the tray can be changed; not the paper size setting). When finished, press .</p>
<p>RCVD FAX TRANSFER</p>	<p>This appears when the Fax to E-mail/Folder function is activated (page 120).</p>
<p>RECALLING</p>	<p>This appears if you attempt to send a fax by auto dialing and the line is busy or the receiving fax machine does not answer. Your machine will automatically reattempt the call. (See <i>Automatic redialing</i> on page 66.)</p>
<p>RECEIVED SECURE FAX</p>	<p>A received fax is being held in memory because the Secure Fax function has been activated. Enter your secure code to print the fax (see page 85).</p>
<p>SERVER ERROR</p>	<p>A Scan to E-mail transmission was not successful because the machine could not connect to your mail server or there was no response from the mail server. Make sure the SMTP server setting is correct (p. 32). If you have configured "POP before SMTP" settings in the Web page, make sure these settings are correct. If [CABLE DISCONNECTED] appears on the bottom line, see "CONNECTION ERROR" on page 159.</p>
<p>SERVER NOT FOUND/ CABLE DISCONNECTED</p>	<p>See "CONNECTION ERROR" on page 159.</p>
<p>SERVER NOT FOUND/ DHCP</p>	<p>A Scan to E-mail transmission was not successful because the machine was unable to automatically obtain an IP address. Restart your router or other device that acts as your DHCP server.</p>
<p>SERVER NOT FOUND/ SMTP</p>	<p>A Scan to E-mail transmission was not successful because an incorrect host name is entered for your SMTP server. Check the SMTP server setting (p. 32).</p>
<p>THERMISTOR ERROR</p>	<p>If this message appears, unplug the power cord and then plug it back in. If the message still appears, call for service.</p>

Messages and Signals

TONER EMPTY	The toner cartridge must be replaced. Printing is not possible until the toner cartridge is replaced.
TONER NEAR EMPTY	The toner cartridge is almost out of toner (approximately 200 pages can be printed).
TX MEMORY FULL	The transmission memory is full. Wait until previously stored transmission jobs have been completed before setting up a new job. To check the jobs that are waiting for transmission, see page 67.

Audible signals

Continuous tone	3 seconds	Indicates the end of transmission, reception, or copying.
Intermittent tone (3 beeps)	5 seconds (1 second on, 1 second off)	Indicates incomplete transmission, reception, or copying.

Clearing Paper Jams

Clearing a jammed document

If the original document doesn't feed properly during transmission or copying, or [DOCUMENT JAMMED] appears in the display, first try pressing . If the document doesn't feed out, remove it as explained below.

- 1 Open the operation panel.

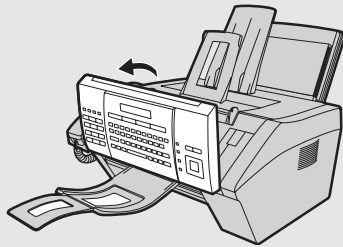

- 2 Rotate the lever toward you and down, and then pull the lever (1) and right end of the roller up (2). Remove the document (3).

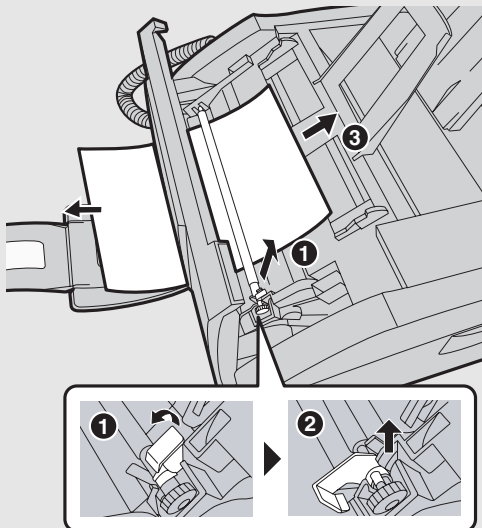

Clearing Paper Jams

- 3** Make sure the left end of the roller is inserted correctly in its holder (❶), and then push the lever and right end of the roller down (❷). Rotate the lever back up and in, pushing it slightly to the right so that it fits into position (❸).

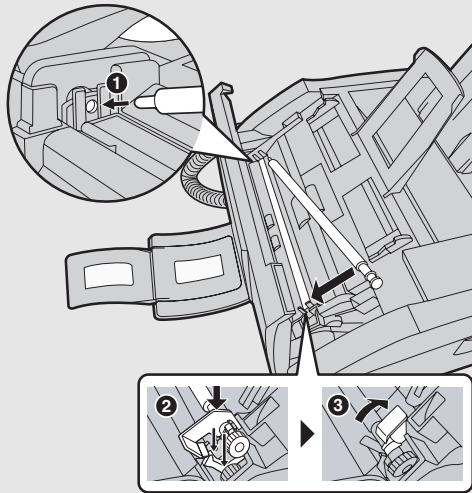

- 4** Close the operation panel, pressing down firmly on both sides to make sure it clicks into place.

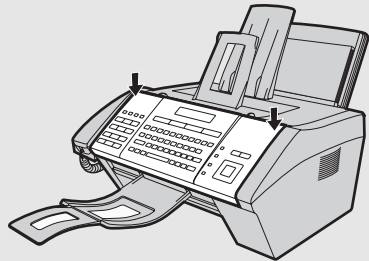

Clearing jammed printing paper

1 Open the top cover of the machine.

- **Caution!**

The fusing unit inside the print compartment becomes very hot during operation. Do not touch the inside of the print compartment after the machine has been in operation.

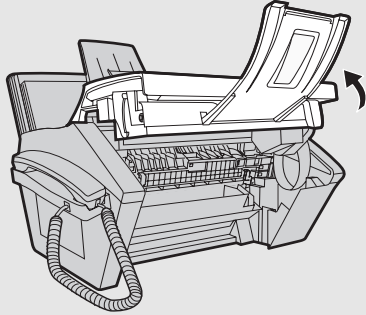

2 Press the release (1) and open the front cover (2).

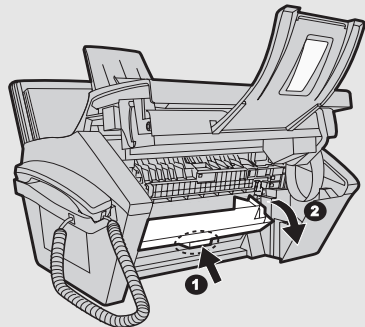

3 Push the two heater roller release levers down to release the heater roller.

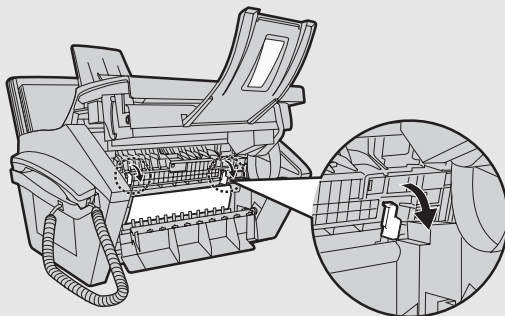

Clearing Paper Jams

3 If the jammed paper is protruding from the front of the machine, gently pull it out. Take care not to tear the paper or leave any torn pieces of paper in the print compartment.

- If this clears the jam, go to Step 5.
- If you are unable to clear the jam in this way, go to Step 4.
- Take care not to touch or allow other objects to contact the drum (the green cylinder). This may damage the drum.

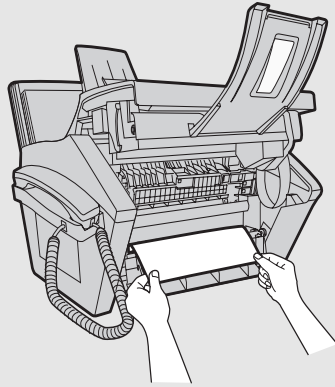

4 If the jammed page cannot be pulled out directly, open the side cover and rotate the white knob in the direction shown to feed out the jammed paper.

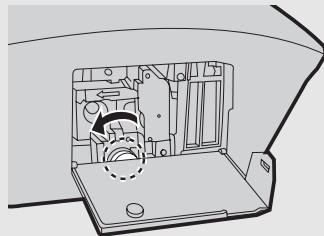
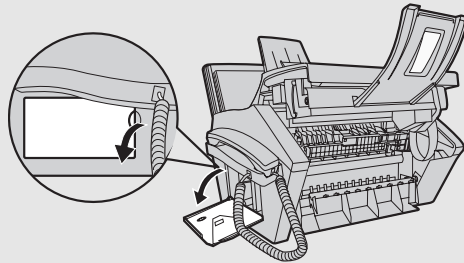

- 5** After the jammed paper has been removed, push the two heater roller release levers back up (❶), close the side cover (❷) (if you opened it), close the front cover (❸), and then the close the top cover (❹).

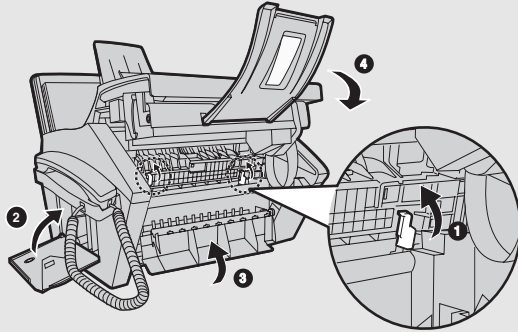

FCC Regulatory Information

This equipment complies with Part 68 of the FCC rules and the requirements adopted by the ACTA. On the rear of this equipment is a label that contains, among other information, a product identifier in the format US:AAAEQ##TXXXX. If requested, this number must be provided to the telephone company.

A plug and jack used to connect this equipment to the premises wiring and telephone network must comply with the applicable FCC Part 68 rules and requirements adopted by the ACTA. A compliant telephone cord and modular plug is provided with this product. It is designed to be connected to a compatible modular jack that is also compliant. See installation instructions for details. This equipment connects to the telephone network through a standard USOC RJ-11C network interface jack.

The REN is used to determine the number of devices that may be connected to a telephone line. Excessive RENs on a telephone line may result in the devices not ringing in response to an incoming call. In most but not all areas, the sum of RENs should not exceed five (5.0). To be certain of the number of devices that may be connected to a line, as determined by the total RENs, contact the local telephone company. For products approved after July 23, 2001, the REN for this product is part of the product identifier that has the format US:AAAEQ##TXXXX. The digits represented by ## are the REN without a decimal point (e.g., 03 is a REN of 0.3). For earlier products, the REN is separately shown on the label.

If this equipment causes harm to the telephone network, the telephone company will notify you in advance that temporary discontinuance of service may be required. But if advance notice isn't practical, the telephone company will notify the customer as soon as possible. Also, you will be advised of your right to file a complaint with the FCC if you believe it is necessary.

The telephone company may make changes in its facilities, equipment, operations or procedures that could affect the operation of the equipment. If this happens the telephone company will provide advance notice in order for you to make necessary modifications to maintain uninterrupted service.

If trouble is experienced with this equipment, or for repair or warranty information, please contact your authorized Sharp dealer. If the equipment is causing harm to the telephone network, the telephone company may request that you disconnect the equipment until the problem is resolved.

This equipment may not be used on coin service provided by the telephone company. Connection to party line service is subject to state tariffs. Contact the state public utility commission, public service commission or corporation commission for information.

If your home has specially wired alarm equipment connected to the telephone line, ensure the installation of this equipment does not disable your alarm equipment. If you have questions about what will disable alarm equipment, consult your telephone company or a qualified installer.

This equipment is hearing-aid compatible.

When programming and/or making test calls to emergency numbers:

- ◆ Remain on the line and briefly explain to the dispatcher the reason for the call.
- ◆ Perform such activities in the off-peak hours, such as early morning or late evening.

S H A R P

Date Revised : Jul. 13. 2007

Date Issued : Sep. 16. 2004

MATERIAL SAFETY DATA SHEET (1/4)

MSDS No. B-1021

Section 1. Product and Company Identification

Product Name : Toner Cartridge of FO-IS125N, FO-25ND, DUNT-424KXH02

Supplier Identification : Sharp Corporation

22-22 Nagaïke-cho, Abeno-ku, Osaka, Japan

Local suppliers are listed below. Please contact the nearest supplier for additional information

	(Country)	(Name and Telephone Number)
North America	U.S.A.	Sharp Electronics Corporation Telephone number for information : 1-800-237-4277 Emergency telephone number : 1-800-255-3924
	Canada	Sharp Electronics of Canada Ltd. Telephone number for information : 905-890-2100 Emergency telephone number : 1-800-255-3924

Section 2. Ingredients

Ingredients	Cas No.	Proportion	OSHA Z-Tables	ACGIH TLV	IARC	DFG-MAK(GER)	Other Limits
Polyester resin	+++	80-90%	—	—	—	—	—
Carbon black	1333-86-4	1-10%	3.5mg/m ³	3.5mg/m ³	2B	III 3B	++
Polyolefin wax	+++	1-10%	—	—	—	—	—
Magnetite	1317-61-9	1-10%	—	—	—	—	—
Amorphous silica	7631-86-9	< 1 %	—	—	—	—	—

++ : Worksafe-TWA(Austl) : 3 mg/m³, NTP(USA) : Not listed, EEC-No : 215-609-9,
Symbol (EC) : Not listed, R-Phrase (EC) : Not listed, California Proposition 65 : Listed

+++ : Supplier's confidential information

Section 3. Hazardous Identification

Emergency Overview : Black powder (mean dia. Is 5-15im by volume).

Almost odorless.

Classification : Not classified as dangerous. (1999/45/EC)

Most Important Hazards and Effects of the Products

Ingestion Effect :

None currently known.

Inhalation Effect :

None currently known. Minimal respiratory tract irritation may occur as with exposure to large amount of any non-toxic dust.

Eye Effect :

None currently known.

Skin Effect :

None currently known.

Chronic Effects :

Prolonged inhalation of excessive dusts may cause lung damage. Use of this product, as intended, dose not result in inhalation of excessive dust.

Environment Hazards :

No data are available on the adverse effects of this product on the environment.

Specific Hazards :

Dust explosion (like most finely divided organic powders)

Section 4. First-Aid Measures

Ingestion: Wash out mouth with water. Drink one or two glasses of water. If symptoms occur, get medical attention.

Inhalation: Move victim to fresh air immediately. If symptoms occur, get medical attention.

Eye Contact: Immediately flush eyes with plenty of water for 15 minutes. If symptoms occur, get medical attention.

Skin Contact: Wash with water and mild soap.

S H A R P

Date Revised : Jul. 13. 2007

Date Issued : Sep. 16. 2004

MATERIAL SAFETY DATA SHEET (2/4)

MSDS No. B-1021

Section 5. Fire-Fighting Measures

Suitable Extinguishing Media: CO₂, water spray, foam and dry chemical
Extinguishing Media to Avoid: Full water jet
Fire and Explosion Hazards: If dispersed in air, like most finely divided organic powders, may form an explosive mixture.
Protection of Firefighters: Use self-contained breathing apparatus (SCBA).

Section 6. Accidental Release Measures

Personal Precautions: None
Environmental Precautions: None
Methods for Cleaning Up: Wear personal protective equipment (See Section 8). Vacuum or sweep material and place in a bag and hold for waste disposal. Use vacuum equipped with High Efficiency Particulate Air (HEPA) filter. Vacuum should be electrically bonded and grounded to dispel static electricity. To avoid dust generation, do not sweep dry.

Section 7. Handling and Storage

Handling

Technical Measures: None
Precautions: Do not breathe dust. Avoid contact with eyes.
Safe Handling Advice: Try not to disperse the particulates.

Storage

Technical Measures: None
Storage Conditions: Keep container closed. Store in a cool and dry place. Keep out of reach of children.
Incompatible Products: None

Section 8. Exposure Control/Personal Protection

Engineering Measures

Ventilation: None required with intended use.

Control Parameters(As total dust)

OSHA-PEL(USA): 15mg/m³ ACGIH-TLV(USA): 10mg/m³ DFG-MAK(GER): 6mg/m³ Worksafe-TWA(Austl.): 10mg/m³

Personal Protective Equipment

Personal Protective Equipment

Not required under normal conditions. For use other than in normal operating procedures (such as in the event of large spill), goggles and respirators may be required.

Hygiene Measures: Wash hands after handling.

Section 9. Physical and Chemical Properties

Appearance

Physical State:	Solid	Form:	Powder (mean dia. Is 5 – 15 um by volume)
Odor:	Almost odorless	Explosion Properties:	No data available
Boiling Point:	Not applicable	Solubility in water:	Insoluble in water.
Melting Point(°C):	Around 125°C (275°F) (Softing Point)	Color:	Black
Ignition Temperature(°C):	400 *	Specific Gravity :	1.2 *
Flash Point:	Not applicable	Vapor Pressure:	Not applicable
pH:	Not applicable	Partition Coefficient, n-Octanol/Water:	Not applicable

S H A R P

Date Revised :Jul. 13, 2007

Date Issued :Sep. 16, 2004

MATERIAL SAFETY DATA SHEET (3/4)

MSDS No. B-1021

Section 10. Stability and Reactivity

Stability: Stable except above 200°C (392°F).

Hazardous Reactions: Dust explosion, like most finely divided organic powders.

Conditions to avoid: Electric discharge, throwing into fire.

Materials to Avoid: Oxidizing materials.

Hazardous Decomposition Products: CO, CO₂, and smoke.

Hazardous Polymerization : Will not occur.

Section 11. Toxicological Information

Health Effects from Exposure: No symptoms expected with intended use.

Toxicological Data

Acute Toxicity:

Ingestion(oral), LD50(mg/kg) : >2000 (Rat) *

Dermal, LD50(mg/kg) : No data available

Inhalation, LD50(mg/l) : >1.93 (Rat, 4hour) *

(This was the highest attainable concentration.)

Eye irritation : Slight conjunctival irritation (Rabbit) *

Skin irritation : Non irritant (Rabbit) *

Sensitizer : Non sensitizer (Guinea pig)

Local Effects : See Chronic Toxicity or Long term Toxicity

Chronic Toxicity or Long term Toxicity :

In a two-year inhalation study of chronic toxicity and carcinogenicity using a typical toner in rats, there were no lung changes at all in the lowest exposure level (1 mg/m³), the most relevant level to potential human exposures. A minimal to mild degree of fibrosis was noted in 22% of the animals at the middle exposure level (4 mg/m³), and a mild to moderate degree of fibrosis was observed in 92 % of the rats at the highest exposure level (16mg/m³). The lung changes observed in the higher exposure groups are interpreted in term of ilung overloading, a series of generic responses to the presence of large quantities of respirable, insoluble and relatively benign dusts retained for extended time periods in the lungs. Lung tumor frequency was unchanged among rats exposed to toner at the three exposure levels, and for air-only control rats.

Carcinogenicity

IARC Monographs: Not listed

NTP(USA): Not listed

OSHA Regulated(USA): Not listed

In 1996 the IARC reevaluated carbon black as a Group 2B carcinogen (possible human carcinogen). This evaluation is given to Carbon Black for which there is inadequate human evidence, but sufficient animal evidence. The latter is based upon the development of lung tumors in rats receiving chronic inhalation exposures to free carbon black at levels that induce particle overload of the lung. Studies performed in animal models other than rats have not demonstrated an association between carbon black and lung tumors. Moreover, a two-year cancer bioassay using a typical toner preparation containing carbon black demonstrated no association between toner exposure and tumor development in rats.

Mutagenicity : Negative * (AMES test)

(* = Based on data for other products with similar ingredients)

S H A R P

Date Revised :Jul. 13. 2007

Date Issued :Sep. 16. 2004

MATERIAL SAFETY DATA SHEET (4/4)

MSDS No. B-1021

Section 12. Ecological Information

No data are available on the adverse effects of this material on the environment.

Ecotoxicity : No data available

Mobility : No data available

Persistence and degradability : No data available

Bioaccumulative potential : No data available

Section 13. Disposal Consideration

When disposing of the waste or recovered material, consult federal, state and/or local regulations for the proper disposal method.

Section 14. Transport Information

Information on Code and Classifications According to International Regulations

UN Classification: None

Section 15. Regulatory Information

US Information

Information on the label: Not required

TSCA (Toxic Substances Control Act):

All chemical substances in this product comply with all applicable rules or order under TSCA.

California Proposition 65:

Ingredient carbon black subject to California Proposition 65 is bound in polymer-matrices so that warnings are not required.

EU Information

Information on the label (1999/45/EC) and 67/548/EEC : Not required

Article 14 (2.1) of Directive 1999/45/EC is not applicable to this product.

Section 16. Other Information

HMIS Rating: The National Paint and Coating Association (USA): Health: 1 Flammability: 1 Reactivity: 0

Recommended Uses: Toner for Electrophotographic Equipment

Explanation of term : IARC 2B means "possible human carcinogen".

Restrictions: This information relates only to the specific material designated as supplied by the manufacturer. This information is supplied to us by the manufacturer and Sharp offers no warranties as to its accuracy and accepts no responsibilities for any typographical errors which may appear on these sheets. It is the responsibility of the user to determine the suitability of this product for each particular use.

Revision Information : Not applicable in this time due to new issue.

Index

A

Activity List, 141
Administrator code, 72
Anti Junk Fax, 117
Audible signals, 162
Authorized Transmission, 88
Auto Print Out (of Activity Report), 138
AUTO reception mode, 68
Auto-dial numbers
 Storing, 60
 Using, 64

B

Batch page numbering, 58

C

Call Restriction, 96
Contrast, 55
Copies, 109

D

Date, setting, 25
Day Light Saving setting, 139
Destination List, 141
Dial Mode, 137
Dial tone detection, 139
Dialing
 Automatic redialing, 66
 Normal, 57
Display messages, 159
Distinctive ring, 115
Document feeder, 53
Document guides, 42, 53
Document restrictions, 53
Document, maximum scanning size, 52
Drum cartridge
 Installing, 18
 Replacing, 150
Duplex Scan, 119

E

ECM mode (Error Correction Mode),
 138
E-mail message, 43
E-mail options, 43
E-mail settings, 32, 36
E-mail subject, 43

F

FAX reception mode, 27
Fax Signal Receive, 138
Fax to E-mail/Folder, 120
File format, 44
Fine Priority setting, 136

G

Global address book, searching, 123
Group Keys, storing, 113
Group keys, using, 113
Group List, 141

H

Halftone setting, 55
Handset receiver volume, 28
Hold, 70
Housing, cleaning, 146

I

IP address, 30, 46

J

Jams, clearing, 163

K

Key Tone setting, 139

L

Line error, 154
Loading printing paper, 23
Loading the document, 53

Index

M

MANUAL reception mode, 69
Memory full, 160
Memory, substitute reception to, 70

N

Network
 Checking connection, 30
 Problems, 31
Network Setting List, 141
Network settings, configuring, 46
Network settings, initializing, 47
Normal dialing, 57
Number of Rings setting, 137

P

Page numbering, batch, 58
Paper feed roller, cleaning, 147
Paper jams, clearing, 163
Paper size setting, 140
Paper, loading, 23
Polling, 128
Power cord, 15
Print settings, 105
Printer driver, installing, 102
Printing, 102
Printing from an application, 104

R

Rapid Key, using for e-mail, 43
Receive Fax to E-mail List, 141
Receive Ratio setting, 140
Reception mode
 AUTO, 68
 FAX mode, 27
 MANUAL, 69
 TEL mode, 27
Redialing, 66
Redialing, automatic, 66

Resolution, 55
Ringer volume, 28

S

Scan to Folder, 48
Scan to FTP, 48
Scanning glass, cleaning, 144
Searching for stored e-mail address, 43
Secure Fax, 84
Send Hold function, 100
Sender's name and number, entering,
 24
Setup List, 141
Sort Copy, 140
Speaker volume, 27
Speed Dial number, using for e-mail, 43

T

TEL reception mode, 27
TEL. LINE jack, 16
Telephone line cord, 16
Time, setting, 25
Timer transmission, 133
Toner cartridge
 Installing, 18
 Replacing, 148
Transaction Report, 143
 Setting print condition, 137

U

User Authentication, 74

V

Voice calls, 65

W

Web page in machine, 32

NOTICE

BE SURE TO ASK YOUR AUTHORIZED SHARP DEALER ABOUT THE WARRANTY THAT YOUR SELLING DEALER EXTENDS TO YOU. In order to assure you, the end-user, of warranty protection, Sharp extends a limited warranty to each of its authorized dealers and, in turn, requires each of its authorized dealers to extend its own warranty to you on terms that are no less favorable than those given to the dealer by Sharp. You should be aware, however, that Sharp does not itself extend any warranties, either express or implied, directly to you, the end-user, and no one is authorized to make any representations or warranties on behalf of Sharp. Specifically, SHARP DOES NOT EXTEND TO YOU, THE END-USER, ANY EXPRESS WARRANTY OR ANY IMPLIED WARRANTY OF MERCHANTABILITY, FITNESS FOR USE OR FITNESS FOR ANY PARTICULAR PURPOSE IN CONNECTION WITH THE HARDWARE, SOFTWARE OR FIRMWARE EMBODIED IN, OR USED IN CONJUNCTION WITH THIS PRODUCT. Sharp is not responsible for any damages or loss, either direct, incidental or consequential, which you, the end-user, may experience as a result of your purchase or use of the hardware, software or firmware embodied in or used in conjunction with this Product. Your sole remedy, in the event that you encounter any difficulties with the Product, is against the authorized dealer from which you purchased the Product. In the event that this authorized dealer does not honor its warranty commitments, please contact the Vice President, Sharp Electronics Corporation, Sharp Plaza, Mahwah, NJ 07430-1163 or Sharp Electronics of Canada Ltd., 335 Britannia Road East, Mississauga, Ontario L4Z 1W9, so that Sharp can try to help assure complete satisfaction of all the warranty rights to which you are entitled from the authorized dealer.

AVIS

DEMANDEZ À VOTRE DÉTAILLANT SHARP AUTORISÉ DE VOUS INFORMER SUR LA GARANTIE PROLONGÉE QUE VOUS OFFRE VOTRE DÉTAILLANT VENDEUR. Afin de vous assurer, vous, l'utilisateur final, que votre produit est couvert par une garantie, Sharp offre à chacun de ses détaillants autorisés une prolongation de sa garantie limitée et leur demande, en retour, de prolonger la garantie qu'ils vous offrent à des conditions non moins avantageuses que celles qui leur sont offertes. Vous devriez cependant savoir que Sharp ne prolonge pas directement la garantie, expresse ou implicite, de votre produit à vous, l'utilisateur final, et que personne n'est autorisé à faire des représentations ou à offrir des garanties au nom de Sharp. Plus particulièrement, SHARP NE VOUS OFFRE, À VOUS, L'UTILISATEUR FINAL, AUCUNE PROLONGATION DE GARANTIE EXPRESSE OU DE GARANTIE IMPLICITE DE QUALITÉ MARCHANDE, D'APTITUDE À L'EMPLOI OU D'ADAPTATION À UN USAGE PARTICULIER POUR CE QUI EST DU MATÉRIEL, DES LOGICIELS OU DES PROGICIELS INCLUS DANS CE PRODUIT, OU UTILISÉS AVEC CE PRODUIT. Sharp n'est pas responsable des dommages ou pertes, directs, indirects ou consécutifs, que vous, l'utilisateur final, subissez à la suite de l'achat ou de l'utilisation du matériel, des logiciels ou des progiciels inclus dans ce produit ou utilisés avec ce produit. Le recours exclusif dont vous, l'utilisateur final, disposez, dans le cas où vous éprouvez des difficultés avec ce produit, est de vous adresser au détaillant autorisé qui vous a vendu le produit. Dans le cas où ce détaillant autorisé n'acquiesce pas les engagements liés à sa garantie, veuillez communiquer avec le vice-président, Sharp Électronique du Canada Ltée, 335 Britannia Road East, Mississauga (Ontario) L4Z 1W9, et Sharp veillera à ce que vous obteniez une satisfaction complète en ce qui a trait aux droits de garantie qui vous ont été conférés par votre détaillant autorisé.

SHARP®

SHARP ELECTRONICS CORPORATION

Sharp Plaza, Mahwah, New Jersey 07430-1163

1-800-BE-SHARP

<http://www.sharpusa.com>

SHARP ELECTRONICS OF CANADA LTD.

335 Britannia Road East, Mississauga, Ontario L4Z 1W9

<http://www.sharp.ca>

SHARP CORPORATION

FOR YOUR RECORDS

Please record the model number and serial number below, for easy reference, in case of loss or theft. These numbers are located on the rear side of the unit. Space is also provided for other relevant information.

Model Number	FO-IS125N
Serial Number	_____
Date of Purchase	_____
Place of Purchase	_____

Free Manuals Download Website

<http://myh66.com>

<http://usermanuals.us>

<http://www.somanuals.com>

<http://www.4manuals.cc>

<http://www.manual-lib.com>

<http://www.404manual.com>

<http://www.luxmanual.com>

<http://aubethermostatmanual.com>

Golf course search by state

<http://golfingnear.com>

Email search by domain

<http://emailbydomain.com>

Auto manuals search

<http://auto.somanuals.com>

TV manuals search

<http://tv.somanuals.com>