

SHARP

MD MICRO SYSTEM

OPERATION MANUAL

MODEL
MD-M3H

Thank you for purchasing this SHARP product. To obtain the best performance from this product, please read this manual carefully. It will guide you in operating your SHARP product.

MD-M3H MD micro system consisting of MD-M3H MD (Main unit) and CP-M3H (Speaker system).



CONTENTS

	Page		Page
SPECIAL NOTES	1	RECORDING	28-31
ACCESSORIES	2	EDITING	32-38
PRECAUTIONS	2	TIMER OPERATION	39-41
NAMES OF CONTROLS AND INDICATORS	3-5	USING EXTERNAL UNITS	42-43
PREPARATION FOR USE	6-8	WHAT IS A MINIDISC?	44
SETTING THE CLOCK	9	MINIDISC SYSTEM LIMITATIONS	45
SOUND CONTROL	10	TROUBLESHOOTING	45-46
COMPACT DISC OPERATION	11	ERROR MESSAGES	47
MINIDISC OPERATION	12	RESETTING THE MICROCOMPUTER	48
CONVENIENT CD AND MD OPERATIONS	13-15	MAINTENANCE	48
RADIO OPERATION	16-17	SPECIFICATIONS	49
RDS (Radio Data System) OPERATION ...	18-27		

TERMS OF GUARANTEE

Sharp Electronics (UK) Ltd. ("Sharp") guarantees to provide for the repair, or at its option the replacement, of this product subject to the conditions listed below:-

1. This guarantee shall only apply to faults which are due to inferior workmanship or materials. It does not cover faults or damage caused by accident, misuse, fair wear and tear, neglect, tampering with the product, or repair other than by a Service Facility appointed by Sharp.
2. As this product is intended for private domestic use only, the guarantee will not apply if the product is used in the course of a business, trade or profession.
3. To benefit from this guarantee, any fault which occurs must be notified to Sharp, or its appointed Service Facility within one year from the date this product was purchased. Proof of purchase must be provided.
4. The guarantee does not cover carriage costs, jewelled styli, audio tapes, compact discs or batteries.
5. In the unlikely event of this product requiring repair, please contact the supplier from whom it was purchased. Where this is not possible, please contact the Sharp Customer Information Centre on the telephone number given below.
6. No person has any authority to vary the terms or conditions of this guarantee.
7. This guarantee is offered as an additional benefit to your statutory rights, and does not affect these rights in any way.

If you have any difficulty operating this product, or would like information on other Sharp products, please telephone the Sharp Customer Information Centre on the number given below.

Sharp Customer Information Centre - Telephone 0345 125387

SHARP

SHARP ELECTRONICS (U.K.) LTD.

Sharp House, Thorp Road, Newton Heath, Manchester, M40 5BE

SHARP CORPORATION

TINSE0236AWZZ

A9903.YT

SPECIAL NOTES

NOTE FOR USERS IN THE U.K.

The mains lead of this product is fitted with a non-rewireable (moulded) plug incorporating a 3A fuse. Should the fuse need to be replaced, a BSI or ASTA approved BS 1362 fuse marked ♡ or ♣ and of the same rating as above, which is also indicated on the pin face of the plug must be used.

Always refit the fuse cover after replacing the fuse. Never use the plug without the fuse cover fitted.

In the unlikely event of the socket outlet in your home not being compatible with the plug supplied, cut-off the mains plug and fit an appropriate type.

DANGER:

The fuse from the cut-off plug should be removed and the cut-off plug destroyed immediately and disposed of in a safe manner.

Under no circumstances should the cut-off plug be inserted else-where into a 13A socket outlet as a serious electric shock may occur.

To fit an appropriate plug to the mains lead, follow the instructions below:

IMPORTANT:

The wires in the mains lead are coloured in accordance with the following code:

Blue : Neutral
Brown : Live

As the colours of the wires in the mains lead of this product may not correspond with the coloured markings identifying the terminals in your plug, proceed as follows:

- The wire which is coloured blue must be connected to the plug terminal which is marked N or coloured black.
- The wire which is coloured brown must be connected to the plug terminal which is marked L or coloured red.

Ensure that neither the brown nor the blue wire is connected to the earth terminal in your three pin plug.

Before replacing the plug cover, make sure that:

- If the new fitted plug contains a fuse, its value is the same as that removed from the cut-off plug.
- The cord grip is clamped over the sheath of the mains lead and not simply over the lead wires.

IF YOU HAVE ANY DOUBT, CONSULT A QUALIFIED ELECTRICIAN.

SERVICE INFORMATION

In the unlikely event of your equipment requiring repair, please contact the dealer or supplier from whom it was purchased. Where this is not possible, please contact the telephone number listed below.

You will then be given details of how to obtain service.

- 0345-125387 -

Please note; all calls will be charged at local rate.

Certain replacement parts and accessories may be obtained from our main parts distributor.

WILLOW VALE ELECTRONICS LTD.

MANCHESTER 0161-682-1415
READING 01189-876444

In the unlikely event of this equipment requiring repair during the guarantee period, you will need to provide proof of the date of purchase to the repairing company.

Please keep your invoice or receipt, which is supplied at the time of purchase.

- Recording and playback of any material may require consent, which SHARP is unable to give. Please refer particularly to the provisions of the Copyright Act 1956, the Dramatic and Musical Performers Protection Act 1958, the Performers Protection Acts 1963 and 1972 and to any subsequent statutory enactments and orders.

- This equipment complies with the requirements of Directives 89/336/EEC and 73/23/EEC as amended by 93/68/EEC.

- When the ON/STAND-BY button is set at STAND-BY position, mains voltage is still present inside the unit.

When the ON/STAND-BY button is set at STAND-BY position, the unit may be brought into operation by the timer mode or remote control.

Warning:



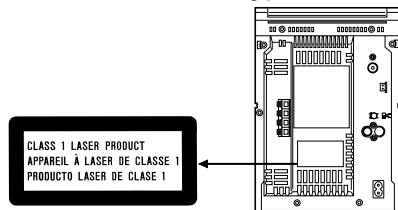

This unit contains no user serviceable parts. Never remove covers unless qualified to do so. This unit contains dangerous voltages, always remove mains plug from the socket before any service operation and when not in use for a long period.

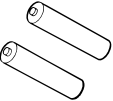
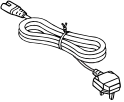

CAUTION

Use the MD micro system only in accordance with the instructions given in this manual and do not attempt to interfere with the interlock switch or make any other adjustment as this may result in expo-

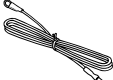
ACCESSORIES

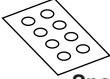
 Remote control × 1	 "AA" size battery (UM/SUM-3, R6, HP-7 or similar) × 2	 AC power lead × 1	
 AM loop aerial × 1	 FM aerial × 1	 Speaker wire × 2	 Speaker cushion × 8

Note:

Parts and accessories mentioned in this operation manual other than those in the drawing are not included.

PRECAUTIONS

■ General

- Please ensure that the equipment is positioned in a well ventilated area and ensure that there is at least 10cm (4") of free space along the sides and back. There must also be a minimum of 20cm (8") of free space on the top of the unit.
- Do not use oil, solvents, petrol, paint thinners or insecticides on the unit.
- Do not expose the unit to moisture, to temperatures higher than 60°C (140°F) or to extreme low temperatures.
- Keep the unit away from direct sunlight, strong magnetic fields, excessive dust, humidity and electronic/electrical equipment (home computers, facsimiles, etc.) which generates electrical noise.
- Hold the AC power plug by the head when removing it from the AC socket, since pulling the lead can damage internal wires.
- Do not remove the outer cover, as this may result in electric shock.
Refer internal service to your local SHARP service facility.
- Use the unit on a firm, level surface free from vibration, and do not place anything on the top of the unit.
- If the unit malfunctions whilst in use, press the ON/STAND-BY button to enter the stand-by mode, then disconnect the AC power lead from the AC socket. Plug the AC power lead back in, and then press the ON/STAND-BY button to turn the power on.
- If an electrical storm is taking place near you, it is suggested that you disconnect the AC power lead from the AC socket for safety.

Warning:

The voltage used must be the same as that specified on this unit. Using this product with a higher voltage other than which is specified is dangerous and may result in a fire or other type of accident causing damage. SHARP will not be held responsible for any damage resulting from use of this unit with a voltage other than that which is specified.

■ Volume control

The sound level at a given volume setting depends on a combination of speaker efficiency, location and various other factors.

It is advisable to avoid exposure to high volume levels, which occur whilst turning the unit on with the volume control setting up high, or whilst continually listening at high volumes.

■ Condensation

Sudden temperature changes, storage or operation in an extremely humid environment may cause condensation inside the cabinet (CD pickup, MD pickup, etc.) or on the transmitter LED on the remote control.

Condensation can cause the unit to malfunction. If this happens, leave the power on with no disc in the unit until normal playback is possible (about 1 hour). Wipe off any condensation on the transmitter LED with a soft cloth before operating the unit.

Warning:

CD players use a laser pickup which can damage the eyes if viewed directly. Do not look at the pickup, and do not touch the pickup directly.

NAMES OF CONTROLS AND INDICATORS

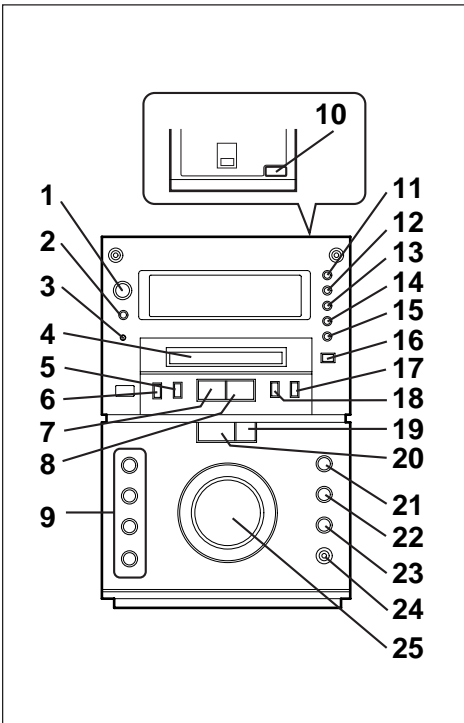

■ Front panel

1. Power On/stand-by Button
2. (MD) Display Button
3. Timer Stand-by Indicator
4. MD Component
5. (MD) Record Button
6. (CD/MD/TUNER) Memory Button
7. (CD/MD) Stop Button
(TUNER) Tuning Down Button
8. (CD/MD) Play/Pause Button
(TUNER) Tuning Up Button
9. Function Selector Buttons
10. CD Eject Button
11. (RDS) Programme Type/Traffic Information Search Button
12. (RDS) EON Button
13. (RDS) Auto Station Programme Memory Button
14. (RDS) Display Mode Button
15. (RDS) Station Selector Button
16. MD Eject Button
17. (CD/MD) Track Up/Cue Button
(TUNER) Preset Up Button
18. (CD/MD) Track Down/Review Button
(TUNER) Preset Down Button
19. CD ► MD Normal Speed Edit Button
20. CD ► MD High Speed Edit Button
21. Surround Button
22. Preset Equalizer Button
23. Extra Bass Button
24. Headphone Socket
25. Volume Control

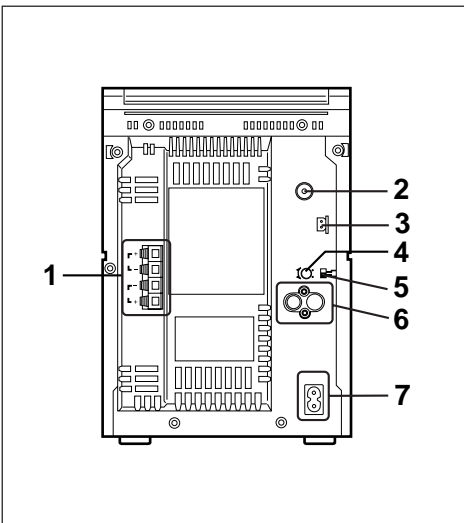

■ Rear panel

1. Speaker Terminals
2. FM 75 Ohms Aerial Socket
3. AM Loop Aerial Socket
4. Auxiliary Input (Analogue) Level Control
5. Demo Switch
6. Auxiliary Input (Analogue) Sockets
7. AC Input Socket

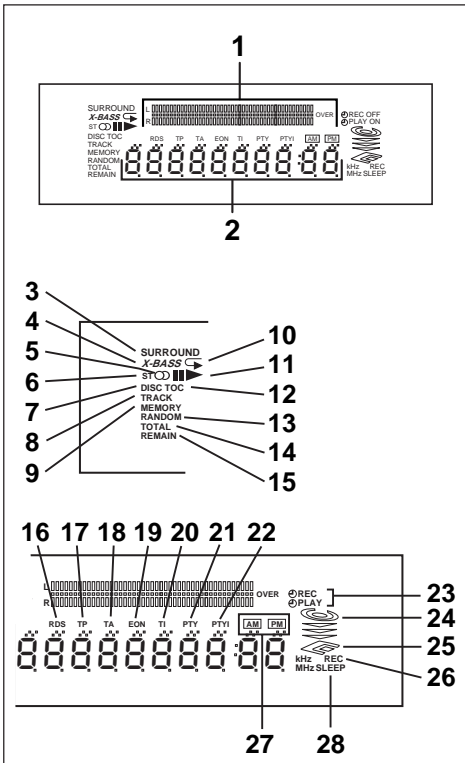

■ Display window

1. Level Meters
2. Character Information Display
3. Surround Indicator
4. Extra Bass Indicator
5. FM Stereo Indicator
6. FM Stereo Mode Indicator
7. (CD/MD) Disc Indicator
8. (CD/MD) Track Indicator
9. (CD/MD/TUNER) Memory Indicator
10. (CD/MD) Repeat Indicator
11. (CD/MD) Play/Pause Indicator
12. (MD) TOC Indicator
13. (CD/MD) Random Play Indicator
14. (CD/MD) Total Indicator
15. (CD/MD) Remaining Time Indicator
16. RDS Indicator
17. (RDS) Traffic Programme Indicator
18. (RDS) Traffic Announcement Indicator
19. (RDS) EON Indicator
20. (RDS) Traffic Information Indicator
21. (RDS) Programme Type Indicator
22. (RDS) Dynamic PTY Indicator
23. Timer Record /Timer Play Indicator
24. CD Indicator
25. MD Indicator
26. (MD) Record Indicator
27. AM/PM Indicator
28. Sleep Indicator

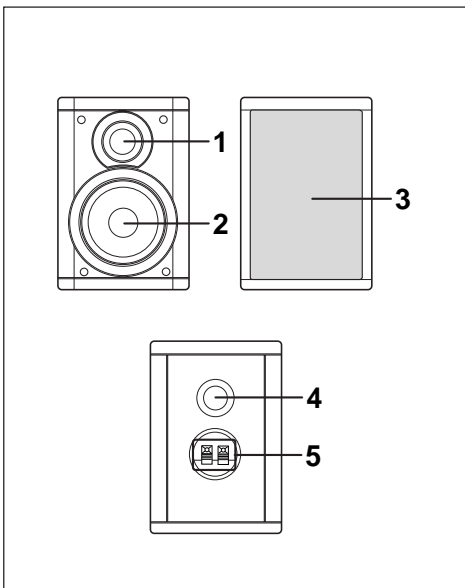

■ Speaker section

1. Tweeter
2. Woofer
3. Speaker Grille
4. Bass Reflex Duct
5. Speaker Terminals

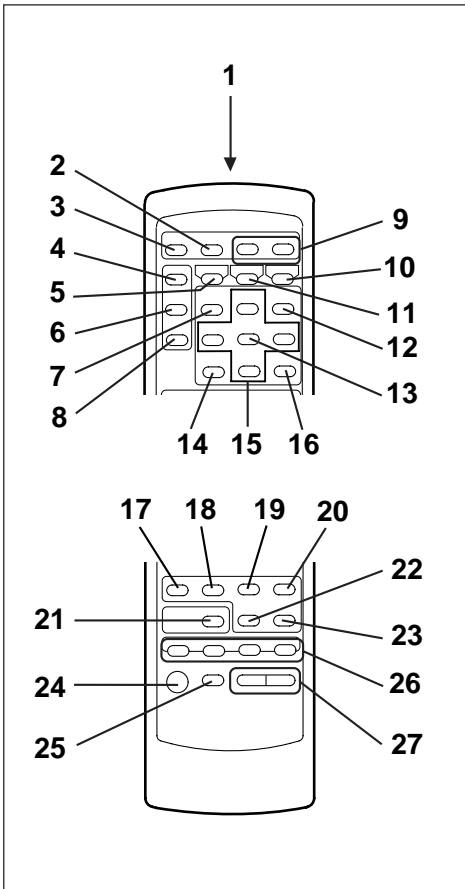

■ Remote control

1. Remote Control Transmitter LED
2. (RDS) Programme Type/Traffic Information Search Button
3. (RDS) Station Selector Button
4. Clock Button
5. Surround Button
6. Timer Button
7. Name/TOC Edit Button
8. Sleep Button
9. (TUNER) Preset Up/Down Buttons
10. Extra Bass Button
11. Preset Equalizer Button
12. (MD) Display Button
13. Enter Button
14. Clear Button
15. Character Select Buttons
16. (CD/MD/TUNER) Memory Button

● MD/CD Section

17. (CD/MD) Time Display Button
18. (CD/MD) Play Mode Button
19. (CD/MD) Track Down/Review Button
20. (CD/MD) Track Up/Cue Button
21. (MD) Record Button
22. (CD/MD) Stop Button
23. (CD/MD) Play/Pause Button
24. Power On/stand-by Button
25. Dimmer Button
26. Function Selector Buttons
27. Volume Button

PREPARATION FOR USE

- Unplug the AC power lead from the AC socket before connecting or disconnecting any component.

■ Aerial connection

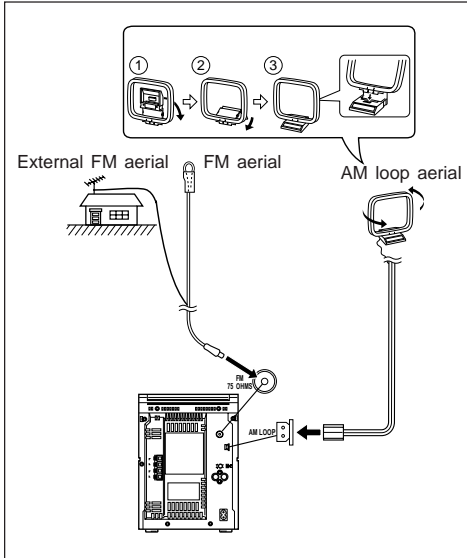

Supplied FM aerial

Connect the FM aerial wire to the FM 75 OHMS socket and position the FM aerial wire in the direction where the strongest signal can be received.

Supplied AM loop aerial

Connect the AM loop aerial wire to the AM ANTENNA socket.

Position the AM loop aerial for optimum reception. Place the AM loop aerial on a shelf, etc., or attach it to a stand or a wall with screws (not supplied).

Notes:

- Do not place the aerial on the main unit as it may result in noise pickup from the internal digital electronics. Place the aerial away from the unit for better reception.
- If the AM loop aerial and the FM aerial wire are placed near the AC power lead, interference may result.

External FM aerial

Use an external FM aerial if you require better reception.

Consult your dealer.

■ Speaker connection

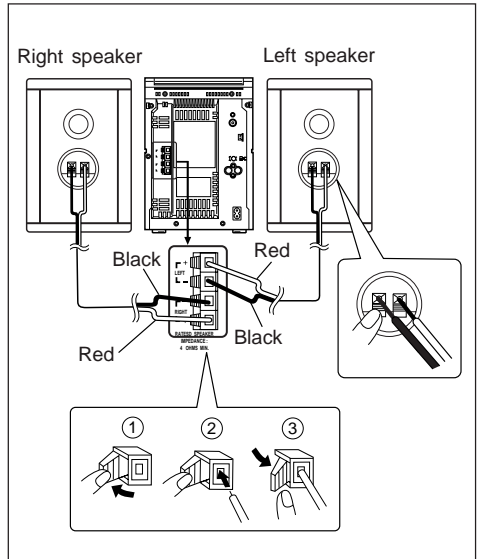

Connect each speaker wire to the SPEAKER terminals as shown.

Use speakers with an impedance of 4 ohms or more, as lower impedance speakers can damage the unit.

Caution:

- Before connecting the speakers to the unit, connect the speaker wires to the speakers first. Then, connect the speaker wire to the terminals on the unit.
- Connect the speakers to the main unit, and then use the system. If any of the speakers is not connected, the main unit or the speakers may malfunction or may be damaged.

Notes:

- Connect the black wire to the minus (–) terminal, and the red wire to the plus (+) terminal.
- Do not mix the right channel and left channel wiring when connecting the speakers to the unit.
- Do not let bare speaker wires touch each other as this may damage the amplifier and/or speakers.

■ Removing the speaker grilles

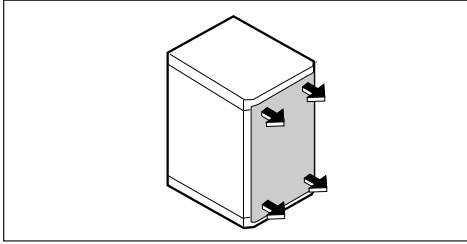

- 1 Remove the lower part of the speaker grille first.
- 2 Remove the upper part of the speaker grille.

Caution:

When the speaker grilles are removed, the speaker diaphragms are exposed. Make sure nothing comes into contact with the speaker diaphragms.

■ Speaker cushion

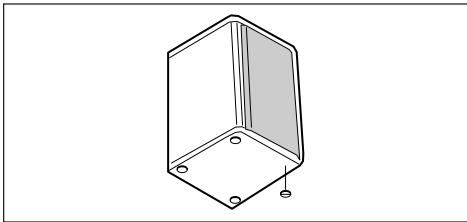

Attach the cushions to the bottom of the speaker to prevent it from sliding.

■ Placing the system

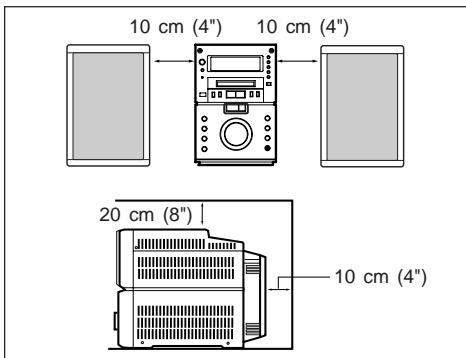

- Be sure to keep space between the units for ventilation.
- Keep the top of this unit at least 20 cm (8") away from the wall, and the back at least 10 cm (4") away.

Note:

- Do not place the system or speakers near the television set as the magnetic fields produced may cause irregular colours to be displayed.

■ Connecting the AC power lead

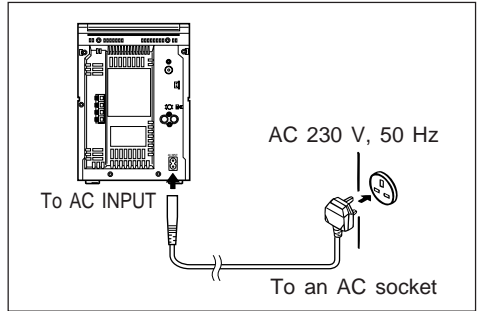

Connect the AC power lead to the AC INPUT socket, then connect the AC power lead plug to an AC socket.

Notes:

- Unplug the AC power lead from the AC socket if the unit will not be in use for a prolonged period of time.
- Never use a power lead other than the one supplied. Use of a power lead other than the one supplied may cause an electric shock or fire.

■ Demo mode

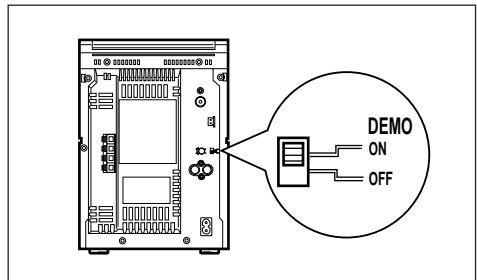

When the AC power lead is first connected, the unit will enter the demonstration mode and the words will scroll across the display continuously.

To cancel the demonstration mode:

When in the demonstration mode, set the DEMO switch to OFF. Then turn the power on and enter the stand-by mode to cancel the demonstration mode and to enter the low power consumption mode.

Note:

- When the unit is in the low power consumption mode, the display will disappear.

To return to the demonstration mode:

Set the DEMO switch to ON. Then turn the power on and enter the stand-by mode.

Remote control

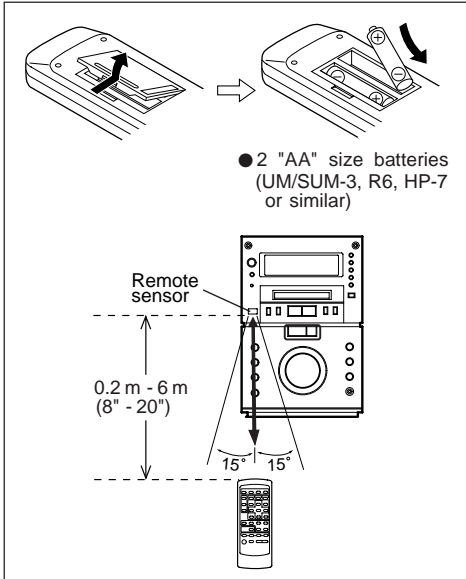

- When inserting or removing the batteries, push them towards the \ominus battery terminal.
- Installing the batteries incorrectly may cause the unit to malfunction.

Precautions for battery use:

- Insert the batteries according to the direction indicated in the battery compartment.
- Replace all old batteries with new ones at the same time.
- Do not mix old and new batteries.
- Remove the batteries if they are weak or if the unit will not be used for long periods of time. This will prevent potential damage due to battery leakage.

Caution:

Do not use rechargeable batteries (nickel-cadmium battery, etc.).

Notes concerning use:

- Replace the batteries if the operating distance is reduced or if the operation becomes erratic.
- Periodically clean the transmitter LED on the remote control and the sensor on the main unit with a soft cloth.
- Exposing the sensor on the main unit to strong light may interfere with operation. Change the lighting or the direction of the unit.
- Keep the remote control away from moisture, excessive heat, shock, and vibrations.

To change the brightness of the display

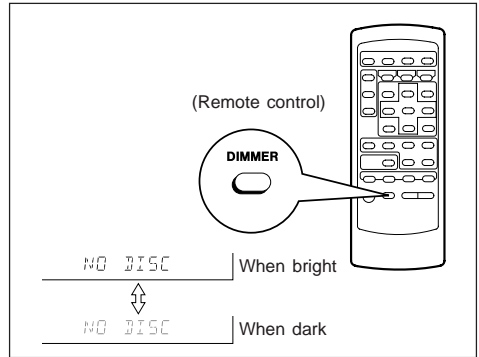

- 1 Press the ON/STAND-BY button to turn the power on.
- 2 Press the DIMMER button.
 - The display will become dimmer, and the display illumination will be dark.

To return to the original brightness:

Press the DIMMER button again.

SETTING THE CLOCK

In this example, the clock is set for the 24-hour (0:00) system.

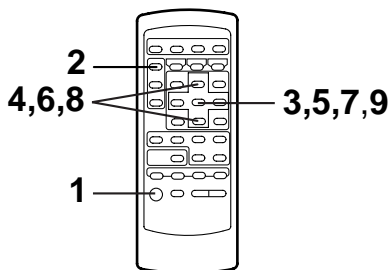

1 Press the ON/STAND-BY button to turn the power on.

2 Press the CLOCK button.

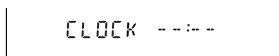

3 Within 5 seconds, press the ENTER button.



4 Press the Δ or ∇ button to select the time display mode.



"0:00" →The 24-hour display will appear. (0:00 - 23:59)

"12:00 AM" →The 12-hour display will appear. (AM or PM 12:00 - 11:59)

"0:00 AM" →The 12-hour display will appear. (AM or PM 0:00 - 11:59)

● Note that this can only be set when the unit is first installed or it has been reset (see page 46).

5 Press the ENTER button.

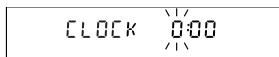

6 Adjust the hour by pressing the Δ or ∇ button.

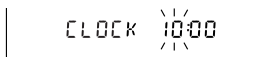

● When the Δ button is pressed once, the time will increase by 1 hour. When the ∇ button is pressed once, the time will decrease by 1 hour.

● When the 12-hour display selected, "AM" will change to "PM" automatically.

7 Press the ENTER button.

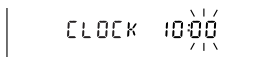

8 Adjust the minutes by pressing the Δ or ∇ button.

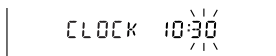

● When the Δ button is pressed once, the time will increase by 1 minute. When the ∇ button is pressed once, the time will decrease by 1 minute.

● The hour setting will not advance even if minutes advance from "59" to "00".

9 Press the ENTER button.

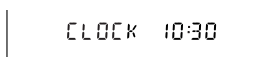

● The clock starts operating from "0" seconds. (Seconds are not displayed.)

To see the time display:

Press the CLOCK button.

● The time display will appear for about 5 seconds even if stand-by mode.

Note:

● The clock display will flash on and off at the push of the CLOCK button when the AC power supply is restored after a power failure occurs or after the AC power lead is disconnected.

If this happens, follow the procedure below to change the clock time.

To change the clock time:

- ① Press the CLOCK button.
- ② Within 5 seconds, press the ENTER button.
- ③ Perform steps 6 - 9 above.

To change the time display mode:

- ① Reset the microcomputer (see page 48).
- ② Perform steps 1 - 9 above.

SOUND CONTROL

■ Volume

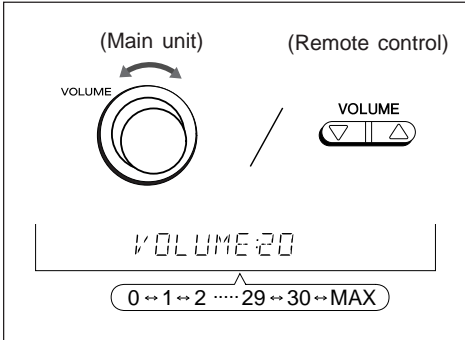

(Main unit operation)

When the VOLUME control is turned clockwise, the volume will increase. When it is turned anti-clockwise, the volume will decrease.

(Remote control operation)

Press the VOLUME Δ button to increase the volume and the VOLUME ∇ button to decrease the volume.

■ Pre-programmed equalizer

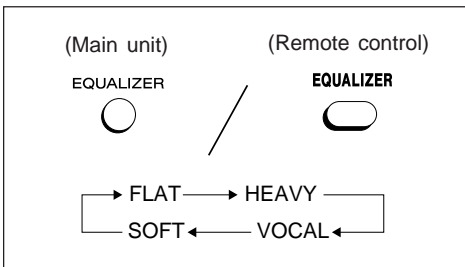

When the EQUALIZER button is pressed, the current mode setting will be displayed. To change to a different mode, press the EQUALIZER button repeatedly.

FLAT: The sound is not modified.

HEAVY: Bass and treble are emphasised.

VOCAL: Vocals (midrange tones) are emphasised.

SOFT: Treble is reduced.

■ Extra bass (X-BASS)

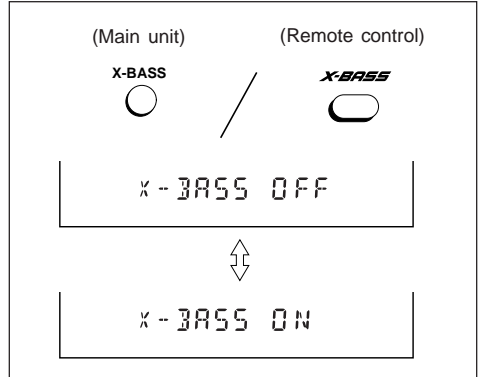

Press the X-BASS button to emphasise the bass region of the frequency spectrum.

"X-BASS ON" will appear.

Press the X-BASS button again to cancel the extra bass mode.

"X-BASS OFF" will appear.



■ Surround

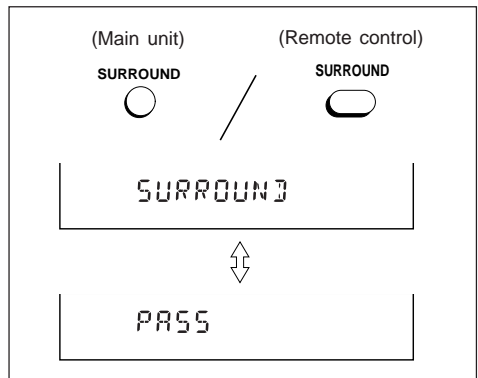

Press the SURROUND button to allow you to enjoy music that seems to surround you.

● "SURROUND" will appear.

Press the SURROUND button again to cancel the surround mode.

● "PASS" will appear.

COMPACT DISC OPERATION

■ CD playback

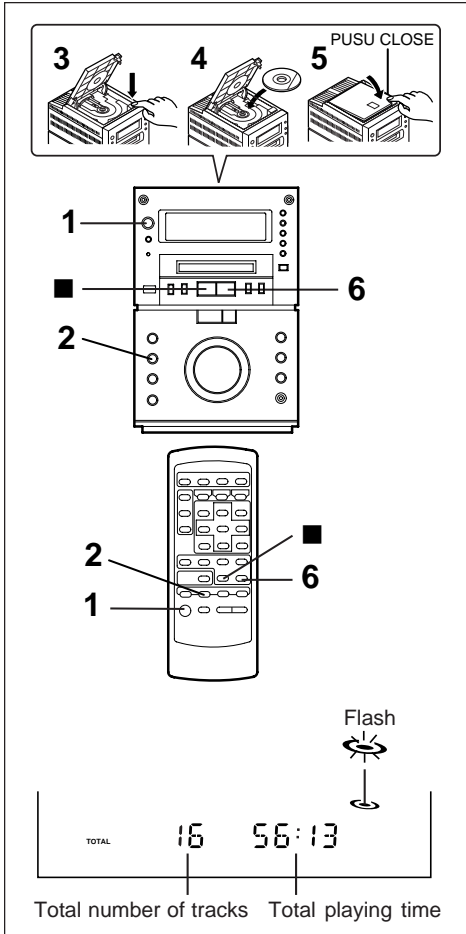

1 Press the ON/STAND-BY button to turn the power on.

2 Press the CD button.

3 Press the ▲ CD EJECT button to open the CD compartment.

4 Place the CD on the spindle, label side up.

5 Close the CD compartment by firmly pushing the corner marked "PUSH CLOSE".

● The total number of tracks and the total playing time will be displayed.

6 Press the ► || button to start playback from track 1.

● When the last track has been played back, the unit will stop automatically.

To interrupt playback:

Press the ► || button.

● "||" will appear.

● Press the 0 6 button again to resume playback from the same point.

To stop playback:

Press the ■ button.

After use:

Press the ON/STAND-BY button to enter the stand-by mode.

Caution:

● Do not open the CD compartment during playback (or whilst paused).

● Keep foreign objects out of the CD compartment.

● Subjecting the unit to shock or vibration may cause mistracking.

● When the unit is not being used, be sure to close the CD compartment. If it is left open, the lens may become covered with dust and the unit may not operate properly.

● Playing certain compact discs at a high volume may cause mistracking. In this case, listen at a lower volume.

● If TV or radio interference occurs during CD operation, move the unit away from the TV or radio.

MINIDISC OPERATION

■ MD playback

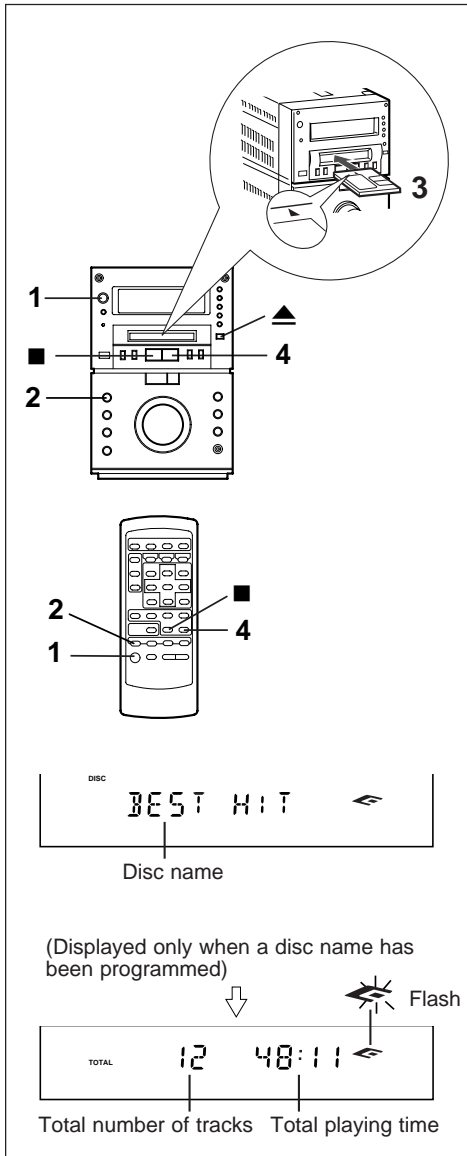

1 Press the ON/STAND-BY button to turn the power on.

2 Press the MD button.

3 Load a MiniDisc in the direction indicated by the arrow on the MiniDisc, with the labeled side facing up.

● The total number of tracks and the total playing time on the MiniDisc will be displayed.

4 Press the ► || button.

● If the MD has a track name, the name will appear and scroll across the display. Then, the elapsed playing time will appear.

● If the MD has no track names, the elapsed playing time will appear.

● When the last track has been played back, the unit will stop automatically.

To interrupt playback:

Press the ► || button.

● " || " will appear.

● Press the ► || button again to resume playback from the same point.

To stop playback:

Press the ■ button.

To remove a MiniDisc:

Press the ▲ MD EJECT button.

Notes:

● If TV or radio interference occurs when using the MD, move the unit away from the TV or radio.

● Although MiniDiscs will not normally skip due to vibration, you may hear a skip in the sound if there is continuous vibration.

If the volume is turned up too high, a skip may occur depending on the contents of the MD.

If this happens, turn the volume down and the skipping should stop.

● If any (or some) error messages is displayed during MD operation, see "ERROR MESSAGES" on page 47.

CONVENIENT CD AND MD OPERATION

■ APSS (Auto Program Search System)

APSS automatically locates the beginning of any track.

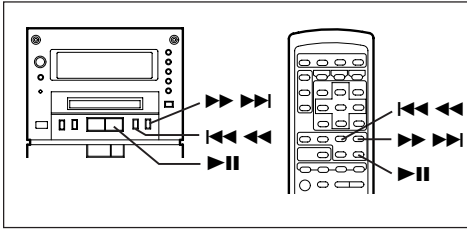

To listen again to the track being played:

Press the **◀◀◀** button for less than 0.5 seconds during playback.

To move to the beginning of the next track:

Press the **▶▶▶** button for less than 0.5 seconds during playback.

To skip a number of tracks at one time:

Press the **◀◀◀** or **▶▶▶** button repeatedly until the desired track number is shown.

To start playing at a desired track:

Press the **◀◀◀** or **▶▶▶** button whilst in the stop mode to select the track number, and then press the **▶||** button.

■ Cue and review

- 1 Load a disc and begin playback.
- 2 Hold the **▶▶▶** button down for audible fast forward, and hold the **◀◀◀** button down for audible fast reverse.
- 3 Normal playback will resume when the **▶▶▶** or **◀◀◀** button is released.

Notes:

- When the beginning of the first track is reached, normal playback will start.
- When the end of the last track is reached, "END" will light, and the unit will pause. If you want to listen to a portion of a track again, press the **◀◀◀** button to return to the point in the track you want to listen to. Normal playback will start from that point.

■ Repeat and random play

(Remote control operation)

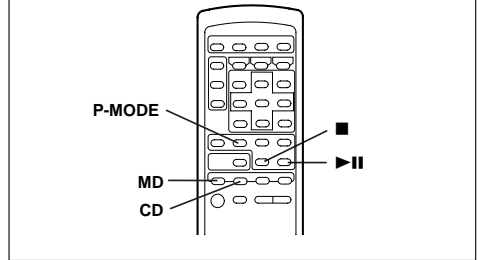

- 1 Select the desired programme source, CD or MD button.

- 2 Press the P-MODE button.

- Each time this button is pressed, the mode will change in the following order:



- 3 Press the **▶||** button to start playback.

Repeat play

After the last track has been played, playback will return to the first track and begin again.

Random play

When the **▶||** button is pressed, all of the tracks will be played at random, and then playback will stop. (The same track will not be played back twice.)

To cancel repeat or random play:

Press the P-MODE button until the "◁" or "RANDOM" display disappears.

To repeat playback of selected tracks:

Enter the programme for the tracks you want and start repeat play.

You can programme a single track and play it repeatedly (Refer to page 14).

Notes:

- During APMS play, random play is not possible.
- When random or repeat play is selected during CD or MD playback, random or repeat play will start at that point.
- When using repeat play, be sure to press the **▶||** button after you are through listening. Otherwise, the disc will play continuously.

■ APMS (Automatic Programmable Music Selector)

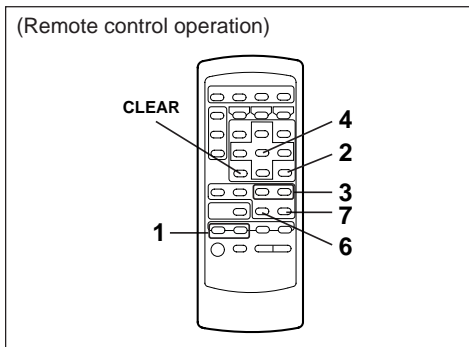

1 Select the desired programme source, CD or MD, by pressing the CD or MD button.

2 Press the MEMORY button.



3 Press the **◀◀** or **▶▶** button.

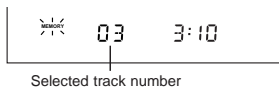

4 Press the ENTER button.

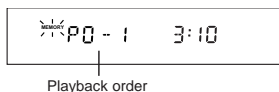

5 Repeat steps 3 and 4 for any other tracks up to 20 tracks (P-20) can be programmed.

6 Press the **■** button.

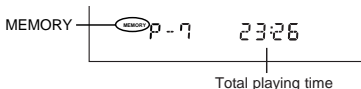

● The total playing time of the programmed tracks will be automatically displayed.

7 Press the **▶ ||** button to start playback of the programmed selections.

● After all of the programmed tracks have finished playback, the unit will automatically stop.

To clear the programmed selections:

Press the CLEAR button whilst the "MEMORY" indicator is flashing.

● Each time the button is pressed, one track will be cleared, beginning with the last track programmed.

To cancel the APMS:

Whilst the unit is stopped in the APMS mode, press the CLEAR button to turn off the "MEMORY" display.

● The programme contents will be erased.

● When you open the CD compartment or a MiniDisc is ejected, the APMS mode will be cancelled.

To check which tracks are programmed:

Whilst the unit is stopped in the APMS mode, press the **◀◀** or **▶▶** button.

Adding tracks to the programme

If a programme has been previously stored, the "MEMORY" indicator will be displayed. Then follow steps 2 - 6 to add additional tracks, the newly selected tracks will be stored after the last track of the original programme.

Notes:

● It is not possible to insert an additional track between programmed tracks that have already been entered.

● Programming and cancelling are not possible during playback or in the pause mode.

■ Switching the time display

Each time the TIME button is pressed during playback or when in the pause mode, the display will change.

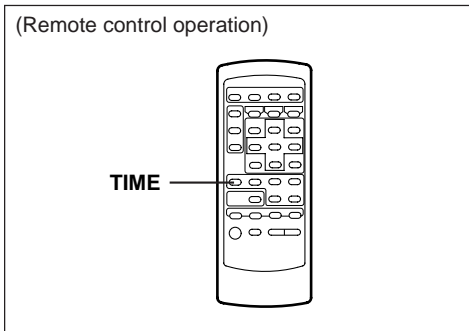

- ① The elapsed playing time for current track will be displayed.



- ② The remaining playing time for the current track will be displayed.

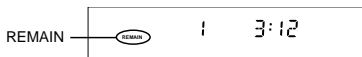

- ③ The total remaining playing time for the disc from the point being played at that time will be displayed.

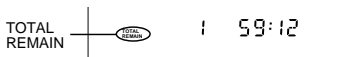

Notes:

- During random play, the total remaining playing time cannot be displayed.
- Depending on a CD or MD to be played, the playing time display may not match the total playing time which is indicated on the CD or MD jacket, as the time between the tracks is not included.

■ Changing the display during MD playback

Each time the DISPLAY button is pressed during playback or when in the pause mode, the display will change as described below.

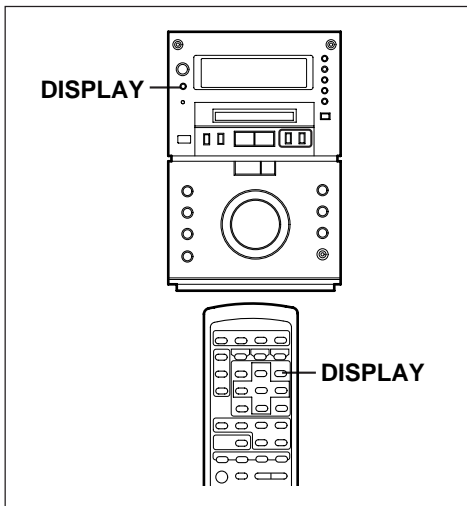

- ① The track name will be displayed.

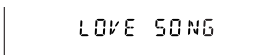

Notes:

- When the MD does not have a track name, this display does not appear.
- ② The total number of tracks and the remaining recording time will be displayed.

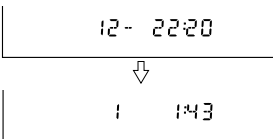

RADIO OPERATION

■ Tuning

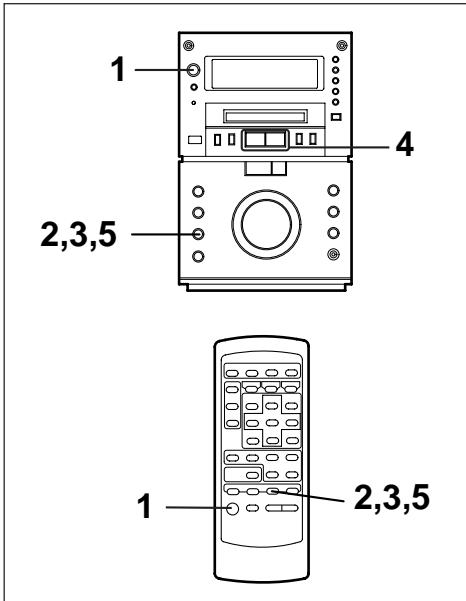

- 1 Press the ON/STAND-BY button to turn the power on.
- 2 Press the TUNER (BAND) button.
- 3 Press the TUNER (BAND) button to select the desired frequency band. (FM ST, FM or AM)
- 4 Press the TUNING (✓ or ^) button to tune into the desired station.

Manual tuning:

Press the TUNING (✓ or ^) button as many times as required to adjust the frequency shown on the display to the frequency of the desired station.

Auto tuning:

When the TUNING (✓ or ^) button is pressed for more than 0.5 seconds, scanning will start automatically and the tuner will stop at the first receivable broadcast station.

Notes:

- When radio interference occurs during auto scan tuning, auto scan tuning may stop automatically at that point.
- If a weak station signal is found during auto scan tuning, the station will be skipped.

- To stop the auto tuning, press the TUNING (✓ or ^) button again.
 - When an RDS (Radio Data System) station is tuned in, the frequency will be displayed first, and then the RDS indicator will light. Finally, the station name will appear.
- 5** To receive an FM stereo transmission, press the TUNER (BAND) button so that the "ST" indicator on the display lights up.
- "∞" will appear when an FM broadcast is in stereo.
 - If the FM reception is weak, press the TUNER (BAND) button so that the "ST" indicator goes out.
 - The reception changes to monaural, the sound becomes clearer.

After use:

Press the ON/STAND-BY button to enter the stand-by mode.

Notes:

- The last station tuned in will be recalled, even after changing the tuning band or the function, or after switching the unit to the stand-by mode.
- If the unit's tuner interferes with the reception of a nearby TV or radio, move the unit as far away from these items as possible.

■ Preset tuning

You can store up to 40 stations in memory (40 stations consisting of any combination of AM and FM stations you like) and recall them.

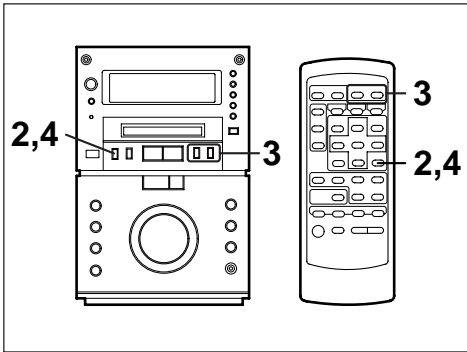

To enter stations into memory:

1 Perform steps 1 - 5 in the "Tuning" section.

2 Press the MEMORY button.

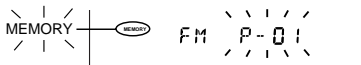

3 Within 5 seconds, press the PRESET (∨ or ∧) button to make the preset channel number flash in the display.

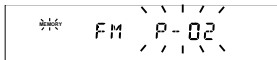

● Store the stations in memory, in order, starting with preset channel 1.
When * is displayed, a station has already been stored in this preset number memory.

4 Within 5 seconds, press the MEMORY button to store that station in the selected station preset number memory.

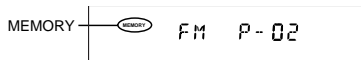

● If the "MEMORY" and preset number indicators go out before the station is memorised, repeat the operation from step 2.

5 Repeat steps 1 - 4 to set other preset stations, or to change a preset station.

● When a new station is stored in the selected station preset number memory, the contents previously memorised will be erased.

● To store an RDS station in memory, perform steps 2 - 4 whilst the RDS station name is being displayed.

To recall a memorised station:

Press the PRESET (∨ or ∧) button for less than 0.5 seconds to select the desired station.

● The stations (preset channel number, frequency and frequency band) which have been stored in memory will appear in the display in numerical order, irrespective of the frequency bands.

Backup function:

The backup function protects all station presets for a few hours should there be a power failure or the AC power lead is removed from the AC socket.

■ Preset memory scan

The stations saved in the preset memory can be scanned automatically.

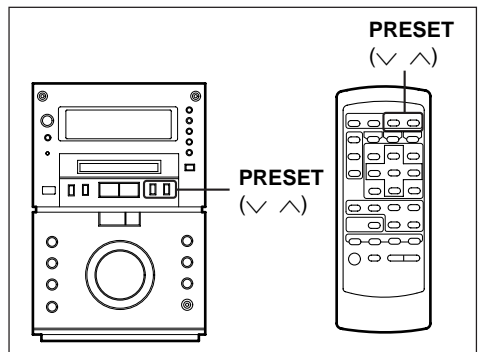

1 To scan the preset stations, press the PRESET (∨ or ∧) button for more than 0.5 seconds.

● The station preset number will flash and the programmed stations will be tuned in sequentially, for 5 seconds each.

2 Press the PRESET (∨ or ∧) button again to stop the memory scan at the desired station.

To erase all memorised stations:

When the unit is in the stand-by mode, hold and press the TUNER and TUNING ∨ buttons, and then press the ON/STAND-BY button.

● "PRESET CLR" will appear.

To erase the memorised station:

1 Recall the memorised station to erase by pressing the PRESET button.

2 Press the CLEAR button.

● "MEMORY" will flash.

3 Within 5 seconds, press the MEMORY button.

4 Repeat steps 1-3 to erase other memorised stations.

Note:

When the preset memory does not have any stations stored in it, the preset memory scan will not

RDS (Radio Data System) OPERATION

RDS is a broadcasting service which a growing number of FM stations are now providing. It allows these FM stations to send additional signals along with their regular programme signals. For example, the stations send their station names, and information about what type of programme they broadcast, such as sports or music, etc.

When tuned to an FM station which provide the RDS service, the RDS will appear, the station frequency (and then the station name if sent) is displayed.

The TP (Traffic Programme) will appear on the display when the received broadcast carries traffic announcements, and the TA (Traffic Announcement) will appear whilst a traffic announcement is being received.

EON will appear whilst the EON (Enhanced Other Networks information) data is being broadcast.

The PTYI (Dynamic PTY Indicator) will appear whilst the Dynamic PTY station is being received.

Note:

When the TP and TA appear at the same time, an announcement is being made.

When only the TA appears, an announcement is not being made. (See page 27.)

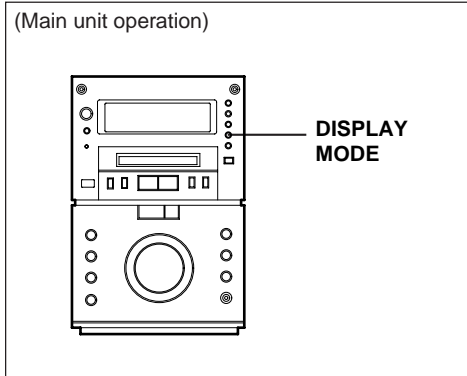

Information provided by RDS

With the this unit, you can display three types of RDS service.

To show them in the display, press the DISPLAY MODE button.

Each time you press the DISPLAY MODE button, the display will change to show the following information.

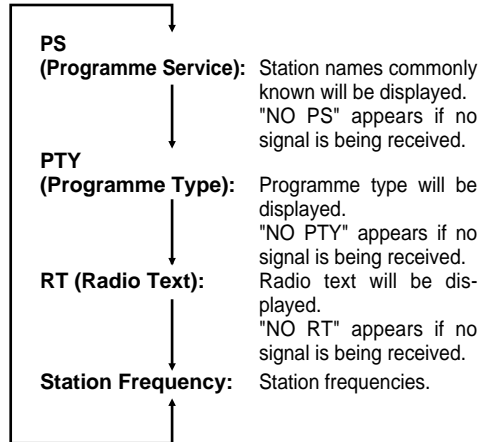

Descriptions of the PTY (Programme Type) codes, TP (Traffic Programme) and TA (Traffic Announcement) With the MD-M3H, you can search for and receive the following PTY, TP and TA signals.

NEWS: Short accounts of facts, events and publicly expressed views, reportage and actuality.

AFFAIRS: Topical programme expanding or enlarging upon the news, generally in different presentation style or concept, including debate, or analysis.

INFO: Programmes whose purpose is to impart advice in the widest sense.

SPORT: Programme concerned with any aspect of sport.

EDUCATE: Programme intended primarily to educate, of which the formal element is fundamental.

DRAMA: All radio plays and serials.

CULTURE: Programmes concerned with any aspect of national or regional culture, including language, theatre, etc.

(Continued)

- SCIENCE:** Programmes about the natural sciences and technology.
- VARIED:** Used for mainly speech-based programmes usually of light-entertainment nature, not covered by other categories. Examples include: quizzes, panel games, personality interviews.
- POP M:** Commercial music, which would generally be considered to be of current popular appeal, often featuring in current or recent record sales charts.
- ROCK M:** Contemporary modern music, usually written and performed by young musicians.
- EASY M:** Current contemporary music considered to be "easy-listening", as opposed to Pop, Rock or Classical, or one of the specialized music styles, Jazz, Folk or Country. Music in this category is often but not always, vocal, and usually of short duration.
- LIGHT M:** Classical Musical for general, rather than specialist appreciation. Examples of music in this category are instrumental music, and vocal or choral works.
- CLASSICS:** Performances of major orchestral works, symphonies, chamber music etc., and including Grand Opera.
- OTHER M:** Musical styles not fitting into any of the other categories. Particularly used for specialist music of which Rhythm & Blues and Reggae are examples.
- WEATHER:** Weather reports and forecasts and Meteorological information.
- FINANCE:** Stock Market reports, commerce, trading etc.
- CHILDREN:** For programmes targeted at a young audience, primarily for entertainment and interest, rather than where the objective is to educate.
- SOCIAL:** Programmes about people and things that influence them individually or in groups. Includes: sociology, history, geography, psychology and society.
- RELIGION:** Any aspect of beliefs and faiths, involving a God or Gods, the nature of existence and ethics.
- PHONE IN:** Involving members of the public expressing their views either by phone or at a public forum.
- TRAVEL:** Features and programmes concerned with travel to near and far destinations, package tours and travel ideas and opportunities. Not for use for Announcements about problems, delays, or roadworks affecting immediate travel where TP/TA should be used.
- LEISURE:** Programmes concerned with recreational activities in which the listener might participate. Examples include, Gardening, Fishing, Antique collecting, Cooking, Food & Wine etc.
- JAZZ:** Polyphonic, syncopated music characterised by improvisation.
- COUNTRY:** Songs which originate from, or continue the musical tradition of the American Southern States. Characterised by a straightforward melody and narrative story line.
- NATION M:** Current Popular Music of the Nation or Region in that country's language, as opposed to International 'Pop' which is usually US or UK inspired and in English.
- OLDIES:** Music from the so-called "golden age" of popular music.
- FOLK M:** Music which has its roots in the musical culture of a particular nation, usually played on acoustic instruments. The narrative or story may be based on historical events of the people.
- DOCUMENT:** Programme concerned with factual matters, presented in an investigative style.
- TEST:** Broadcast when testing emergency broadcast equipment or receivers.
- ALARM !:** Emergency announcement made under exceptional circumstances to give warning of events causing danger of a general nature.
- NONE:** No programme type (receive only).
- TP:** Broadcasts which carry traffic announcements.
- TA:** Traffic announcements are being broadcast at present.
- Note:**
- When the unit is in the EON stand-by mode and a programme is selected, the unit will display "T1" instead of "TA".

■ ASPM (Auto Station Program Memory)

It is recommended that you store stations in memory using ASPM.

(This memory can be used for PTY searches, station select and EON switching.)

When the ASPM button is pressed, whilst tuned to the FM band, the RDS (Radio Data System) function will automatically search for new RDS stations. Up to 40 stations can be stored in memory.

(If you have already stored some stations in memory, the number of new stations you can store will be less.)

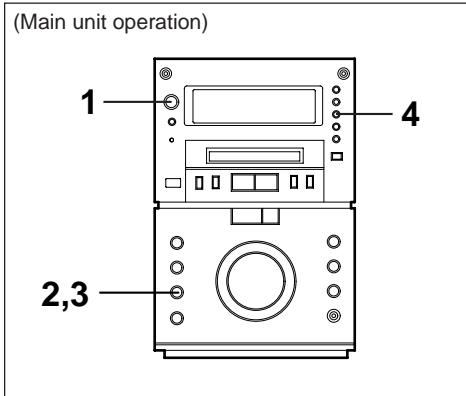

- 1 Press the ON/STAND-BY button to turn the power on.
- 2 Press the TUNER (BAND) button.
- 3 Press the TUNER (BAND) button to select the FM ST or FM band.
- 4 Press and hold down the ASPM button for at least 3 seconds.

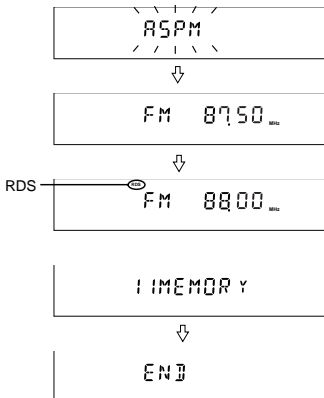

- ① After "ASPM" has flashed for about 4 seconds, scanning will start. (87.50 - 108.00 MHz)
- ② When an RDS station is found, the RDS will appear for a short time and the station will be stored in memory.
- ③ After scanning, the number of stations that have been automatically stored in memory will be displayed for 4 seconds, and then "END" will appear for 4 seconds.

To stop the ASPM operation before it is complete:

Press the ASPM button whilst it is scanning for stations.

- The stations that have already been stored in memory will be kept there.

To erase all of the contents of preset memory:

The unit is in the stand-by mode.

Hold down the TUNER button and the TUNING √ button, and then press the ON/STAND-BY button.

- "PRESET CLR." will appear.
- After performing this operation, all of the preset memory information will be erased.

Notes:

- Only RDS stations will be stored in memory in numerical order.
- If the same station is broadcasting on different frequencies, the transmission with the strongest broadcast frequency will be stored in memory.
- Any station which has the same frequency as one which has been already stored in memory will not be stored again.
- The ASPM operation can be repeated until "END" appears.
- If a 40th station is stored in memory during a scan, the scanning will stop at that station. The number of stations and "END" will each be displayed for 4 seconds.
- If no stations have been stored in memory, "END" will flash for about 4 seconds.
- If 40 stations have already been stored in memory and the ASPM button is pressed, "END" will appear immediately and the scan will be aborted.
If you want to redo the ASPM operation from the beginning, erase the preset memory, and then perform steps 1 - 4.
- If the RDS station broadcast signals are very weak, station names may not be stored in memory.

■ To specify station names and select stations manually (station select)

You can receive for a desired station by specifying the station name (BBC R1, BBC R2, etc.) from among the stations that have been stored in memory.

(ASPM is convenient for storing stations in memory.) Before starting this operation, you must store one or more station names in memory.

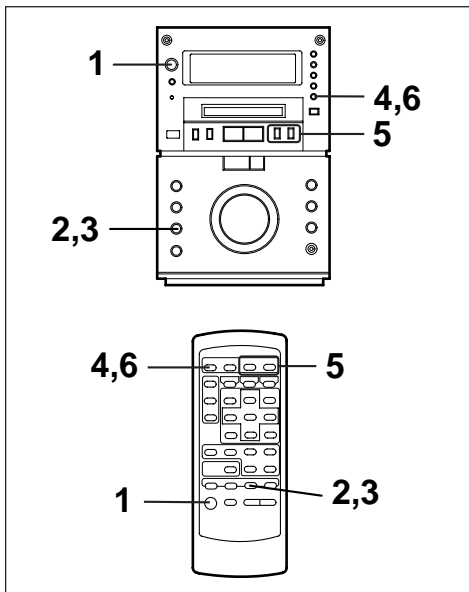

- 1 Press the ON/STAND-BY button to turn the power on.
- 2 Press the TUNER (BAND) button.
- 3 Press the TUNER (BAND) button to select the FM ST or FM band.
- 4 Press the STATION button.

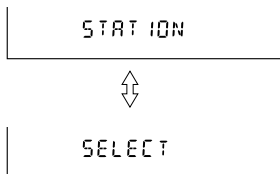

- "STATION" and "SELECT" will appear alternately for about 6 seconds.

- 5 Within 6 seconds, press the PRESET (∨ or ∧) button to select a desired station name you want.

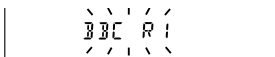

- Each time the button is pressed, the station name will appear. If the button is held down for more than 0.5 seconds, the station name will continuously change.

- 6 Whilst the selected station name is flashing (within 6 seconds), press the STATION button again.

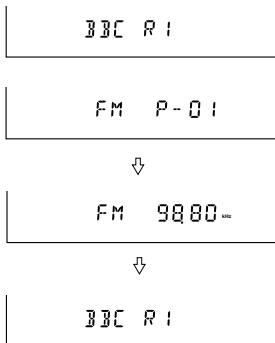

- After the selected station name has been lit for 1 second, the preset station which corresponds to the selected station name will be recalled.

To cancel the station select operation:

Press the STATION button whilst "STATION" and "SELECT" appear alternately.

(Continued)

To try to store a station name again, if the wrong name was stored in memory by mistake:

When you store station names in memory using the ASPM function, the correct station names may not actually be stored if there is lots of noise or if the RDS station signal is too weak. In this case, try storing station names in memory using the following procedure.

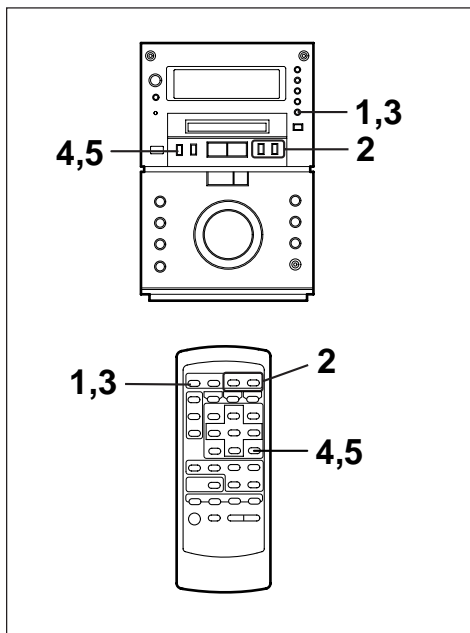

- 1 Press the STATION button.
 - 2 Within 6 seconds, press the PRESET (✓ or ^) button to check whether the station names are correct.
 - 3 If you find a station name that is wrong, press the STATION button again within 6 seconds to recall the preset station, which corresponds to the station name.
 - 4 After the preset station has been received and the correct station name has been displayed, press the MEMORY button.
 - 5 Within 5 seconds, Press the MEMORY button again whilst the preset channel number is flashing.
- The new station name has been stored in memory correctly.

Notes:

- When there are no station names stored in memory, you cannot use this function. In this case, when the STATION button is pressed, "NOTHING" will flash for 5 seconds, and the unit will return to the original display.
- This function can only be used when the FM band has been selected.
- The same station name can be stored in different preset channels. Therefore, when you are choosing a station name from the presets, the same station name may be encountered more than once.
- In a certain area or during certain time periods, the station names selected using the station select function may temporarily be different from the name of the station you are actually receiving.

■ To recall stations that have been stored in memory (PTY search)

You can search a desired stations by specifying the programme type (news, sports, traffic programme, etc. ... see page 18-19) from among the stations that have been stored in memory. (ASPM is convenient for storing stations in memory.)

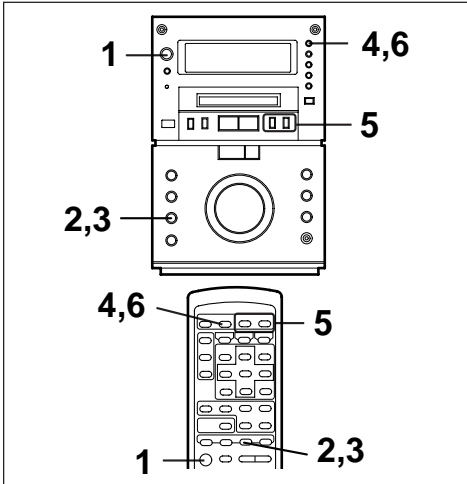

- 1 Press the ON/STAND-BY button to turn the power on.
- 2 Press the TUNER (BAND) button.
- 3 Press the TUNER (BAND) button to select the FM ST or FM band.
- 4 Press the PTY.TI SEARCH (PTY.TI) button.

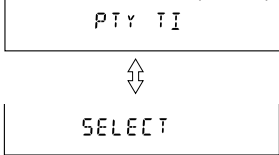

- "PTY TI" and "SELECT" will appear alternately for about 6 seconds.

- 5 Within 6 seconds, press the PRESET (∨ or ∧) button to select the programme type you want.

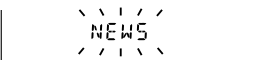

- Each time the button is pressed, the programme type will appear. If the button is held down for more than 0.5 seconds, the programme type will appear continuously.

- 6 Whilst the selected programme type is flashing (within 4 seconds), press the PTY.TI SEARCH (PTY.TI) button again.

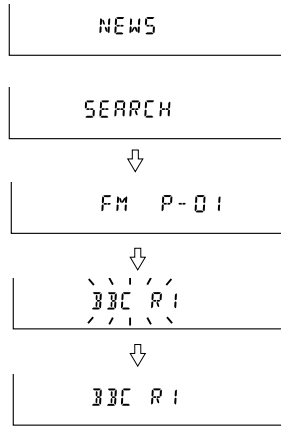

- After the name of the selected programme type has been lit for 2 seconds, "SEARCH" will appear, and the search operation will start.

Note:

If the display has stopped flashing, start again from step 4. If the unit could find out a desired programme type you want, corresponding channel number will flash for about 3 seconds, and then a station name will flash for 7 seconds, and then remain lit. The channel number will flash for about 3 seconds. The station name will flash for 7 seconds, and then remain lit.

- If you want to listen to same programmed type of another station, press the PTY.TI SEARCH (PTY.TI) button whilst the channel number or station name is flashing. The unit will look for the next station.

Note:

- If no station of the programme type you want can be found, "NOT FOUND" will appear for 4 seconds.

★ If you have selected the traffic programme:

If you select traffic programme (TP) as the programme type in step 5, to receive only radio stations which broadcast traffic programmes, the TP will appear. (However, this does not necessarily mean that you will hear any traffic announcements at that time.)

When a traffic announcement is actually being made, the TA will appear. (When both the TP and TA will appear, an announcement is being made.)

■ To manually recall the stations stored in memory

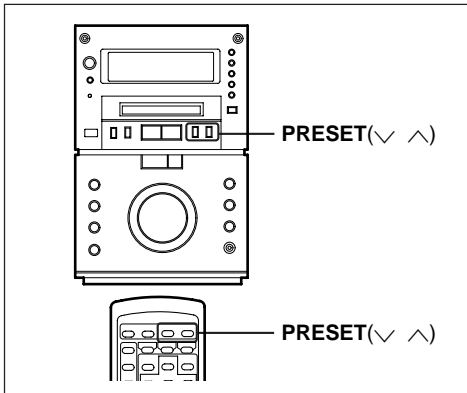

Each time you press the PRESET (∨ or ∩) button the channel number will change.

- After the channel number has been displayed for 2 seconds, the frequency for that channel will appear for 2 seconds, and then the station name will appear.

■ To switch the display

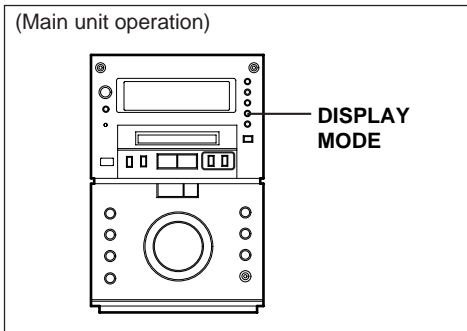

Each time the DISPLAY MODE button is pressed whilst an FM station is tuned in, the display will switch as follows:

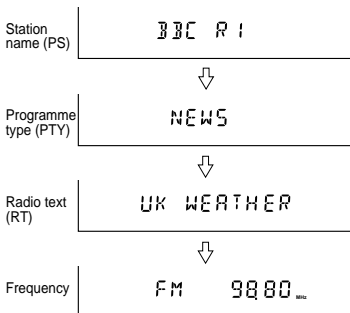

When the station you are tuning in is not an RDS station or even if it is an RDS station but it is very weak signal, the display will change in the following order:

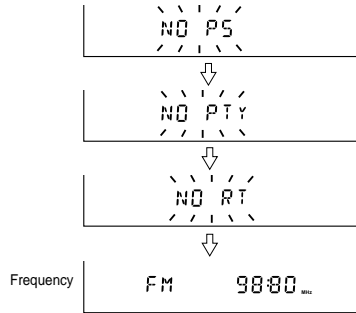

■ Notes for Radio text

- The radio text for 10 characters will be displayed steadily for 4 seconds and then it will scroll across the display.
- If you tune into a station which is not broadcasting any radio text, even if it is an RDS station, when you switch to the radio text position "NO RT" will be displayed.
- Whilst radio text data is being received or when the text contents change, "RT" will be displayed.

■ Notes for RDS operation

If any of the following events occur, it does not mean that the unit is faulty.

- "PS", "NO PS" and a station name appear alternately, and the unit does not operate properly.
- If a particular station is not broadcasting properly or a station is conducting tests, the RDS reception function may not work properly.
- When you receive an RDS station whose signal is too weak, information like the station name may not be displayed, even if "RDS" is lit.

Notes:

- "NO PS", "NO PTY" or "NO RT" will flash for about 5 seconds, and then the frequency will be displayed.
- The display can only be switched whilst tuned to the FM band.

■ EON-PTY

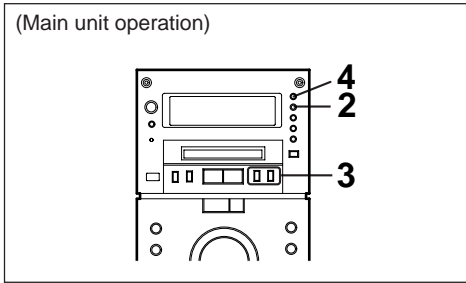

1 Tune in the desired RDS station (when a station name is being displayed).



2 Press the EON button when "EON" appears.



● "PTY TI" and "SELECT" will appear alternately for about 6 seconds.

3 Whilst they are being displayed, select the desired programme type pressing the PRESET (∨ or ∧) button.

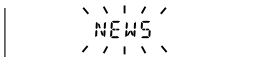

● The selected programme type will flash.

4 Within 4 seconds, press the PTY.TI SEARCH button.

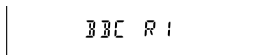

● The selected programme type and "WAITING" will be displayed for 2 seconds each.

● "PTY" will appear, and the unit will enter the EON-PTY stand-by mode.

5 When a programme of the type specified starts on an ON (other network) station, the unit will automatically switch to the station broadcasting the selected programme type, and "PTY" will flash.

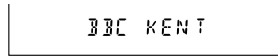

6 When the programme specified for the ON station is over, the unit will automatically return to the original station you were tuned to.

Note:

● If the EON button is pressed when "EON" is not displayed, "NO EON" will appear for 5 seconds to indicate that the unit cannot enter the EON stand-by mode.

Checking the stand-by mode setting:

When in the EON stand-by mode, press the EON button.

("Programme type" → "WAITING")

To cancel the EON stand-by mode:

When in the EON stand-by mode, press the EON button. Within 4 seconds, press it again. The EON stand-by mode will be cancelled.

("PTY" will go out.)

About the PTYI (Dynamic PTY Indicator):

PTYI (Dynamic PTY Indicator) will appear whilst the Dynamic PTY station is being received.

Dynamic PTY indicates that the PTY for the station tuned in, or the PTY referenced in the EON data, is assessed whenever the programme changes and may be changed.

PTYI	Meaning
Lights up	Tuned into a dynamic PTY station.
Goes out	Tuned into a static PTY.

Note:

● When "PTYI" appears, if you press the DISPLAY MODE button to display the programme type, you can check the type of programme you are actually receiving.

■ EON-TI

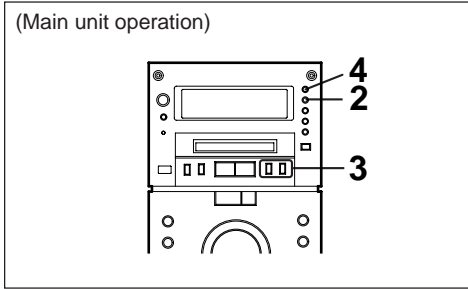

1 Tune in the desired RDS station (when a station name is being displayed).

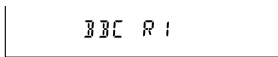

2 Press the EON button when "EON" appears.

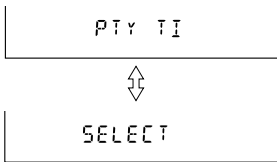

● "PTY TI" and "SELECT" will appear alternately for about 6 seconds.

3 Whilst they are being displayed, select the TI (Traffic Information) pressing the PRESET (∨ or ∧) button.

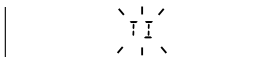

4 Within 4 seconds, press the PTY.TI SEARCH button.

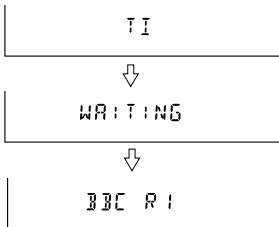

- "TI" and "WAITING" will appear for 2 seconds each.
- "TI" will appear, and the unit will enter the EON-TI stand-by mode.

5 When a TA specified starts on a other network station, the unit will automatically switch to that station, and "TI" will flash.

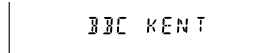

6 When the traffic announcement is over, the unit will automatically return to the original station you were tuned to.

Note:

- If the EON button is pressed when "EON" is not displayed, "NO EON" will appear for 5 seconds to indicate that the unit cannot enter the EON stand-by mode.

Checking the stand-by mode setting:

When in the EON stand-by mode, press the EON button.

("TI" → "WAITING")

To cancel the EON stand-by mode:

When in the EON stand-by mode, press the EON button. Within 4 seconds, press it again. The EON stand-by mode will be cancelled.

- "TI" will go out.

Note:

- If neither "TP" nor "TA" appear, then even if "EON" appears the unit cannot enter the EON-TI stand-by mode. In this condition, if the PTY.TI SEARCH (PTY.TI) button is press after TI is selected, "NO TI" will flash for 4 seconds.

About the TP and TA indicators

TP indicator	TA indicator	Meaning
Not lit	Not lit	This programme does not carry traffic announcements nor does it refer, via EON, to a programme that does.
Not lit	Lit	This programme carries EON information about another programme which gives traffic information.
Lit	Not lit	This programme carries traffic announcements but none are being broadcast at present and may also carry EON information about other traffic announcements.
Lit	Lit	A traffic announcement is being broadcast on this programme at present.

In the following cases, the EON stand-by mode will be cancelled.

- Press the ON/STAND-BY button to enter the stand-by mode.
- When the unit is switched to another band in the EON stand-by mode
- When you change the FM station whilst in the EON stand-by mode
- When a preset call is made

Notes:

- During the same programme as the specified PTY (or TA) is being broadcast on the station you are receiving, the unit will not switch to other network station.
- If there are more than two other network stations you want to listen to, compare the strength of each station's signal and tune in the station with the strongest signal. (EON-AF)
However, if the frequency of other network station has been stored in the preset channel memory, the unit will switch to that preset channel.
- If you want to cancel the reception of an ON (other network) station which was tuned in by the EON system and return to the original station you were receiving, press the EON button.
- After the unit returns to the original station, the stand-by mode will still be active. (The "TI" or "PTY" will remain lit.)
- The unit will not switch from the ON station to another network station. The unit returns to the original station.
- When the unit switches automatically to "other network" station, if there is any problem with this station or the station cannot be received properly "WEAK SIG" will appear and the unit will return to the original station.
- Even if the unit switches from the station you are listening to directly to one "other network" station which is in the preset memory, if the signals is very weak, the unit will search for another station of other net work and find out the station with the strongest signal and switch to it.
However, if the signals from all the other network stations are very weak, or if the tuning conditions are very bad (due to electrical noise), the unit will be displayed "WEAK SIG", and the unit will return to the original station you were receiving.

RECORDING

■ Differences from tape recordings

You cannot record music on the reverse side of a MiniDisc.

MiniDiscs are single sided and should only be inserted with the correct side up.

You don't need to search for the starting point at which to record.

The unit automatically finds the point at which recording can start. Recording will start from that point.

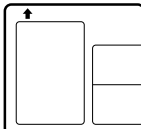

You can check the total or remaining recordable time (possible recording) before recording.

This lets you plan a recording session so that the last song will not come to an abrupt end before it has finished.

The date and time of a recording are automatically saved with the recording.

If you have set the date and time, they will be automatically recorded when a recording is made.

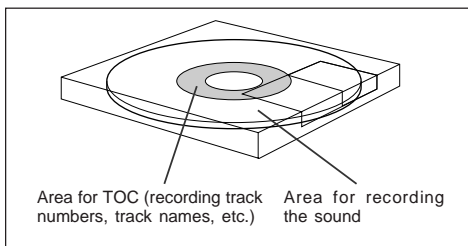

Area for TOC (recording track numbers, track names, etc.) Area for recording the sound

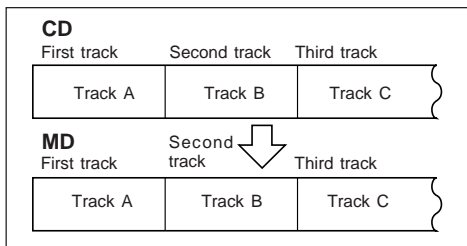

■ Disc writing (TOC)

The TOC (Table of Contents) is information on track numbers and recording areas to allow the unit to recognize musical selections or sounds.

The entire MD is controlled depending on this TOC, which enables the unit to find the beginning of a track quickly or to automatically record in a vacant area.

When you start recording or editing, "TOC" will appear in the display window.

This indicates that information in the TOC is now being changed according to recording or editing being performed. (The changed TOC is not yet recorded on the MiniDisc at this time.)

The TOC is recorded when

- you stop recording.
- you switch to another input source.
- you eject the MiniDisc.
- you enter the stand-by mode.

Do NOT unplug the power lead whilst the TOC is being recorded ("TOC" is flashing) and do NOT impart shock to the unit. Otherwise, TOC will not be correctly recorded, and consequently proper playback may not be possible.

■ About track numbers

When recording from a CD

New track numbers will be created automatically according to the original tracks (Synchro mark function).

- When you record from a CD to a MiniDisc, the track numbers recorded on the MiniDisc may not match the track numbers on the CD. If this happens, correct the track numbers using the DIVIDE (page 36) and COMBINE (page 36) functions after recording.

Recordings cannot be made in the following situations.

- If you try recording on a playback-only MiniDisc (commercially available music)
- If a MiniDisc is protected against accidental erasure (Page 44)
- If there is no more recording time left on the disc (Page 45)
- When the "TOC FULL *" message appears (Page 47)
- If a disc's TOC has been damaged
- If you are trying to copy a digital signal that has been encoded with the SCMS signal (Serial Copy Management System)

Notes:

- When recording important selections, be sure to make a pre-liminary test to ensure that the desired material is being properly recorded.

■ Recording from a CD onto a MiniDisc (One-Touch Editing)

A CD can be recorded to a MiniDisc, starting from the first track, with a one-touch operation.

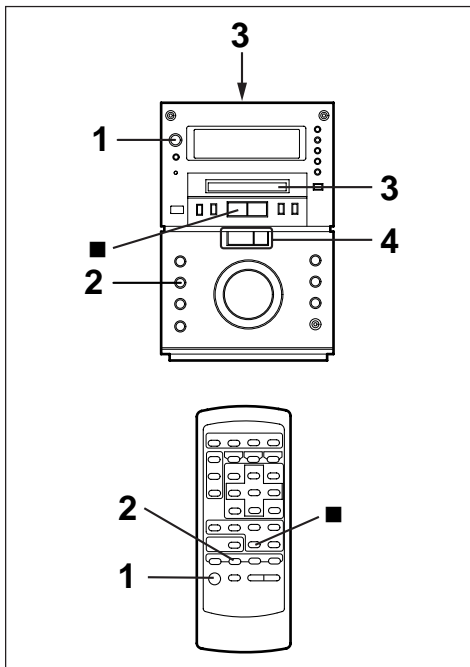

1 Press the ON/STAND-BY button to turn the power on.

2 Press the CD button.

3 Load a compact disc and a recordable MiniDisc.

● The total number of tracks and the total playing time on the CD will be displayed.

● When a new recordable MiniDisc is loaded, it will take about 15 seconds to enter the recording stand-by mode.

4 Press the CD ▶ MD EDIT (HIGH or NORMAL) button.

● Press the EDIT button to NORMAL for actual speed, HIGH for high-speed recording.

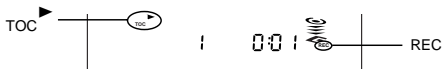

● The compact disc loaded will be recorded in order, starting from the first track. When a MiniDisc runs out of recording space or when a compact disc has been completely recorded, the CD and the MD will stop automatically.

Caution:

- Recording will begin, starting from the first track of CD.
- After recording (all of the tracks that can be recorded), the unit will stop automatically.
- When a recording is made at high speed, the playback sound will not be heard.
- When a damaged CD is recorded at high speed, the unit may stop whilst recording, or some noise or a drop out may be recorded. In this case, record the CD at normal speed.

Notes:

● When the CD playing time is longer than the available MD recording time, the recording process will not start even when the CD ▶ MD EDIT button is pressed.

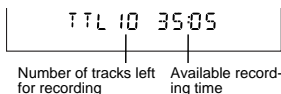

● To record as many tracks as are available, press the CD ▶ MD EDIT button again.

However, if the available recording time on the MD is less than the length of the first track on the CD, when the CD ▶ MD EDIT button is pressed, the following display will appear.

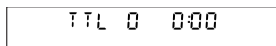

Then, when the CD ▶ MD EDIT button is pressed again, recording will start. However, when the MD runs out of space, "DISC FULL" will be displayed and the CD and MD will stop.

To check the remaining time available for recording:

- ① Press the MD button.
 - ② Load a MiniDisc.
 - ③ Press the DISPLAY button to find a time followed by hyhnone.
- The total the number of tracks previously recorded and the available time remaining will be displayed, 4 seconds later, the unit will return to the original display.

To cancel the operation:

Before pressing the CD ▶ MD EDIT (HIGH or NORMAL) button, press the ■ button.

To stop recording:

- Press the ■ button.
- Playback and recording will stop and the track numbers will be written to the MiniDisc. It is not possible to pause in the recording mode.

■ APMS recording

(Main unit operation)

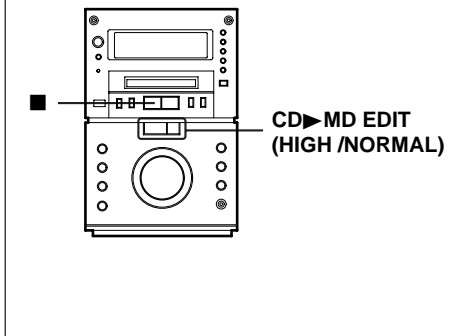

- 1 Select tracks for APMS playback. (Page 14)
- 2 Load a recordable MiniDisc.
- 3 Press the CD ► MD EDIT (HIGH or NORMAL) button.
 - APMS playback will start, and recording will start automatically.
 - Programmed tracks will be recorded in order. After the unit has finished recording the last track, recording will stop automatically.

Notes:

- If recording does not begin, press the CD ► MD EDIT (HIGH or NORMAL) button again. (See page 29.)
- When repeat play has been set, if you press the CD ► MD EDIT button, the repeat mode will be cancelled automatically, and APMS recording start.

To stop recording:

Press the ■ button.

- Playback and recording will stop and the track numbers will be written to the MiniDisc. It is not possible to pause in the recording mode.

■ To record without using One-Touch Editing

Without using one-touch recording, the following operation allows you to record from the first track.

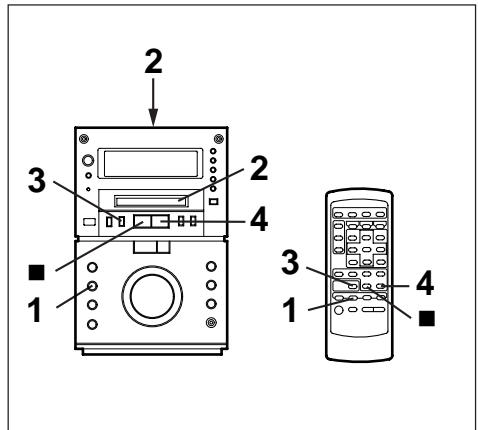

- 1 Press the CD button.
- 2 Load a compact disc and a recordable MiniDisc.
- 3 Press the ● REC button.
 - The unit will enter the recording stand-by mode.
- 4 Press the ► || button.

To stop recording:

Press the ■ button.

- After the track number has been written on the MiniDisc, the recording will stop. However, CD playback will continue.

■ Recording from the built-in radio onto a MiniDisc

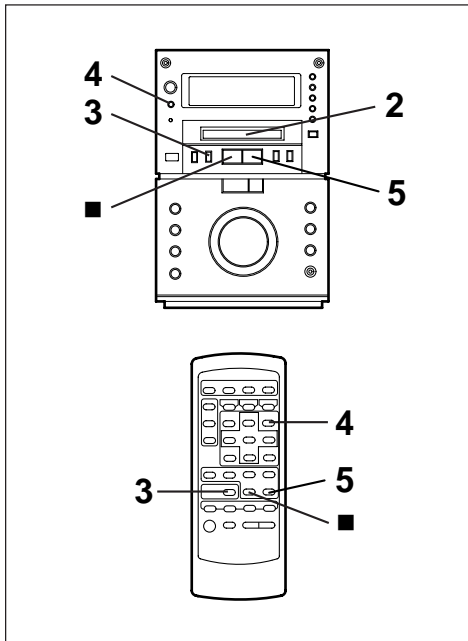

- 1 Tune in to the desired station. (pages 16 - 17.)
- 2 Load a recordable MiniDisc.
- 3 Press the ● REC button.
 - The unit will enter the recording stand-by mode.
- 4 Check the recordable time by pressing the DISPLAY button.

Note:

- Before recording an AM broadcast, enter the recording stand-by mode, and then separate the AM loop aerial from the main unit. Adjust it so that the AM broadcast can be tuned in most clearly.
- During recording, you cannot change the station.

- 5 Press the ► || button.

To stop recording:

Press the ■ button.

After the track number has been written on the MiniDisc, the recording will stop.

To record the track number whilst recording:

The recording is performed as a single track.

To identify different sections of a recording you can increase the track number at any point during the recording process.

To create a new track number, whilst in the recording mode, press the ● REC button.

- The track number will increase by one, and then the recording will continue.

■ What the editing function can do

You can create original discs using the MD editing function, on which you can change the order of the tracks and you can create disc or track names.

- Playback-only MiniDiscs cannot be edited.

DIVIDE

A single track can be divided into two at any desired position.

- The numbers of the tracks which come after the newly divided track will be automatically increased by one.

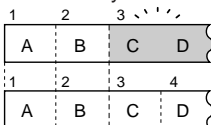

(Page 36)

COMBINE

Two consecutive tracks can be combined into one track.

- The numbers assigned to the tracks following the combined tracks will be decreased by one automatically.

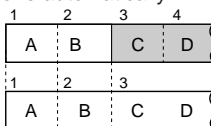

(Page 36)

ERASE/ALL ERASE

Tracks you want to erase can be erased one at a time or all at once.

- Once a track has been erased, it cannot be recovered. Double-check the track number before erasing it.

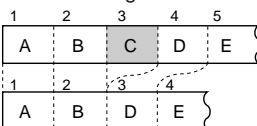

(Page 38)

MOVE

A designated track can be moved to any desired position.

- The numbers assigned to the tracks following the track which is moved will be adjusted automatically.

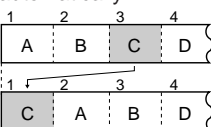

(Page 37)

TRACK/DISC NAME

Discs and tracks (up to 255 tracks per disc) can be named. Since track names are displayed when the beginning of each track is located or during playback, you can quickly check the name of each track.

- Capital letters, numbers and symbols can be used.

(Page 33,34)

■ Type of characters used

Type of characters	Characters symbols
Capital letters	A B C D E F G H I J K L M N O P Q R S T U V W X Y Z
Symbols	1 2 3 4 5 6 7 8 9 0 ! " # \$ % & ' * () * + , - . / ? @ < = > [] ^ _

Number of characters you can enter

● Disc names and track names

Up to 40 characters (including spaces) can be entered for each name.

● Total number of characters per MiniDisc

A total of approximately 1,700 characters can be used for all of the disc and track names. If more than 1,700 characters are entered, "TOC FULL *" will appear.

Whilst editing, the "TOC" indicator is displayed. This means the edit results have not been recorded on the MiniDisc.

To record the results, select another input or set the unit to the stand-by mode. During writing, the "TOC" goes out, all editing changes have been recorded to the disc.

Note:

- Storing the edited contents on the disc can be done after several pieces of editing have been finished.

■ To create a disc name

A name for the whole disc. Disc names are displayed when an MD is inserted.

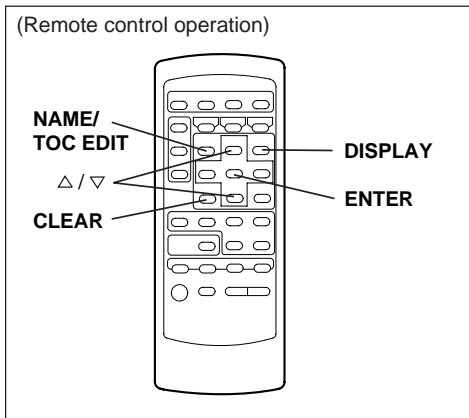

- 1** Press the ■ button after pressing MD button.
 - The total number of tracks and the total playing time on an MD will appear.
- 2** Press the NAME/TOC EDIT button, and then select "DISC NAME" pressing the Δ or ▽ button.

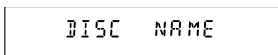

- 3** Within 10 seconds, press the ENTER button.



- The unit will enter the character input mode.

- 4** Press the DISPLAY button to select the type of characters you want to use.

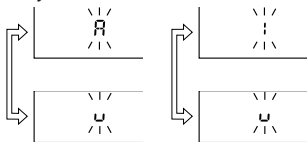

- 5** Select the character you want pressing the Δ or ▽ button.

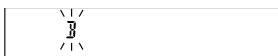

- 6** Press the ENTER button to enter the character.



- Repeat steps 4 to 6 above to enter the characters in the name. When the next character's type is the same as the previous character, step 4 can be skipped.

- 7** After entering all of the characters in the name, press the NAME/TOC EDIT button.

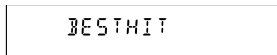

- The disc name will be recorded.

To erase a disc name:

After performing steps 1 to 3.

- 1** Press the CLEAR button for 2 seconds or more.
- "NAME CLEAR" will flash.
- 2** Press the ENTER button.

Notes:

- Up to 40 characters can be entered.
- This function cannot be used in the random play mode and APMS play mode.

To create a track name

Name each track.

A track's name will be displayed whenever you select it and during playback.

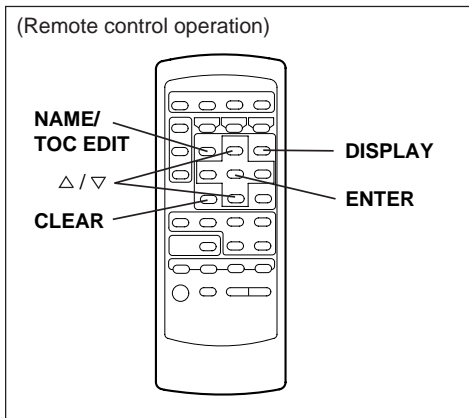

- 1 During playback or in the pause mode, press the NAME/TOC EDIT button.

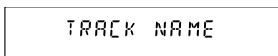

- 2 Within 10 seconds, press the ENTER button.



- The unit will enter the character input mode.
- The track you are listening to will be played repeatedly.

- 3 Press the DISPLAY button to select the type of characters.

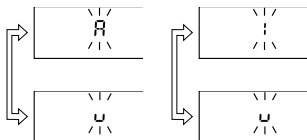

- 4 Select the character you want pressing the Δ or ▽ button.



- 5 Press the ENTER button to enter the character.



- Repeat steps 3 to 5 above to enter the characters in the name. When the next character's type is the same as the previous character, step 3 can be skipped.

- 6 After entering all of the characters in the name, press the NAME/TOC EDIT button.

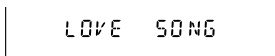

- The track name will be recorded.
- The unit will return to normal playback.
- Press the ► || button in the pause mode, the unit will return to normal playback.

To erase a track name:

After performing steps 1 to 2.

- 1 Press the CLEAR button for 2 seconds or more.
 - "NAME CLEAR" will flash.
- 2 Press the ENTER button.

Notes:

- Up to 40 characters can be entered.
- This function cannot be used in the random play mode and APMS play mode.
- If you create a track name whilst recording the track, make sure you finish entering the name before you finish recording the track. If the end of the recording is reached before you have entered the complete name, only the characters entered before the recording ended will be recorded.

■ To change disc names and track names

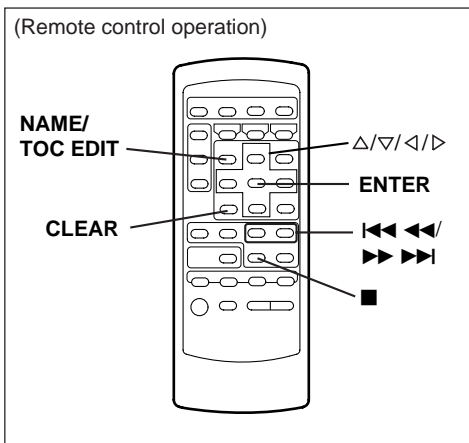

Example: To change “BESUT” to “BEST”

1 To change disc names, perform steps 1 - 3 on page 33.
To change track names, perform steps 1 - 2 on page 34.

2 Press the ◀ or ▶ button to make the character you want to erase begin flashing.



● To cancel the operation, press the ■ button.

3 Press the CLEAR button.

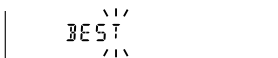

● After this step, if you are not going to enter a character, go to step 5.

4 Select the character you want to add, pressing the Δ or ▽ button. Then, press the ENTER button.

● The selected character will be added, and the original characters will move to the right by one.

5 After entering all of the characters in the name, press the NAME/TOC EDIT button.

To add a character:

Example: To change “BET” to “BEST”

1 To change disc names, perform steps 1 - 3 on page 33.
To change track names, perform steps 1 - 2 on page 34.

2 Press the ◀ or ▶ button to make the character at the place you want to add a letter begin flashing.

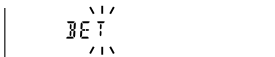

● To cancel the operation, press the ■ button.

3 Select the character you want to add, pressing the Δ or ▽ button. Then, press the ENTER button.

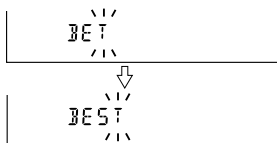

● The selected character will be added, and the original characters will move to the right by one.

4 After entering all of the characters in the name, press the NAME/TOC EDIT button.

Note:

● You cannot modify excess 40 characters if they were entered using some other equipment. In this case, erase the name and then enter a new name.

■ **Divide**

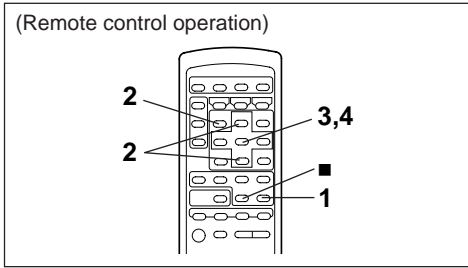

1 Play the track which you want to divide into two, and press the ► || button at the point where you want to divide the track.

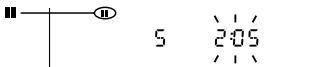

2 Press the NAME/TOC EDIT button, and within 10 seconds, select "DIVIDE" pressing the ▲ or ▼ button.

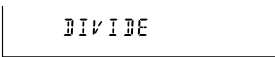

3 Within 10 seconds, press the ENTER button.



● To cancel the operation, press the ■ button.

4 Press the ENTER button again.



- The track is divided, and the unit is stopped at the beginning of the second of the two tracks.
- The numbers of the tracks which come after the divided track are automatically increased by one.
- When a track which has been given a name is divided, the two new tracks will have the same name and date. If the "TOC FULL" message is seen, the second track may not be given a name. (Page 45)

Notes:

- This unit can hold up to 255 tracks. However, even if the number of tracks assigned has not reached 255, it might not be possible to make any further divisions of tracks. (Page 45)
- This function cannot be used in the random play mode and APMS play mode.

■ **Combine**

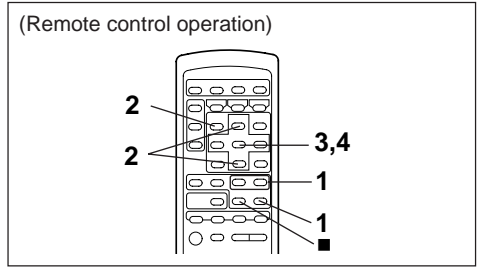

1 Whilst in the stop mode, select the second of the two adjacent tracks you want to combine pressing the ◀◀◀◀ or ▶▶▶▶ button. Or start playing the second of the two tracks you want to combine, and then press the ► || button.

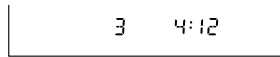

2 Press the NAME/TOC EDIT button, and within 10 seconds, select "COMBINE" pressing the ▲ or ▼ button.



3 Within 10 seconds, press the ENTER button.

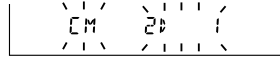

● To cancel the operation, press the ■ button.

4 Press the ENTER button again.



- The two tracks are combined, and the unit is stopped at the beginning of the combined track.
- The numbers assigned to the tracks following the combined track are automatically decreased by one.

When both tracks have a name:

- When only the first track has a name → That name will be used.
- When only the second of the two tracks has a name → That name will be used.
- When both tracks have a name → The name of the first track will be used.

(Continued)

To combine two non-contiguous tracks:

(Example: the first and third tracks)

Move the third track to the second track using the MOVE function.

Then, combine the first and second tracks using the COMBINE function.

Note:

- Tracks recorded from analogue inputs cannot be combined with tracks recorded from CDs or MDs using the digital inputs.
- Tracks recorded in the stereo mode cannot be combined with tracks recorded in the monaural long-play mode.
- Tracks where either track's recording time is less than 15 seconds may not be combined.
- This function cannot be used in the random play mode and APMS play mode.

■ Move

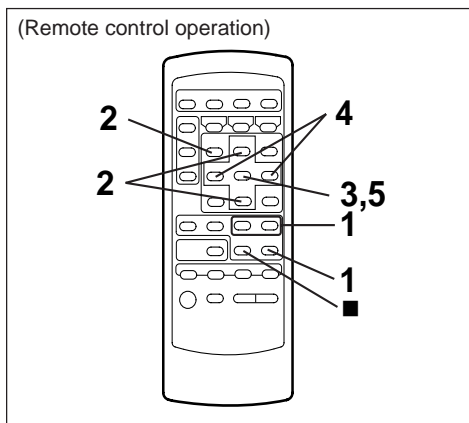

- 1 Whilst in the stop mode, select the track you want to move pressing the ◀◀◀◀ or ▶▶▶▶ button.

Or start playing the track to be moved, and then press the ▶|| button.

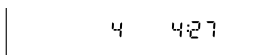

- 2 Press the NAME/TOC EDIT button, and within 10 seconds, select "MOVE" pressing the ▲ or ▼ button.

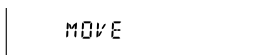

- 3 Within 10 seconds, press the ENTER button.

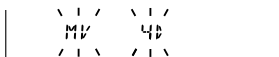

- 4 Select the new track position pressing the ◀ or ▶ button.

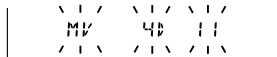

- To cancel the operation, press the ■ button.

- 5 Press the ENTER button again.



- The track is moved, and the unit is stopped at the beginning of the new track which has the same track number as selected number in step 1.

Note:

- When a track has been moved, the other tracks which are affected will be assigned new track numbers automatically.

Example:

When moving the fifth track to the third track, the old third track will become the new fourth track, and the old fourth track will become the new fifth track.

- This function cannot be used in the random play mode and APMS play mode.

■ Erase

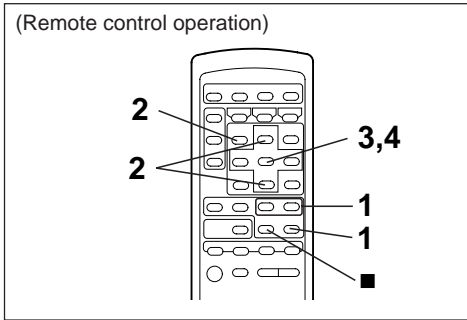

To erase tracks one at a time:

- 1 Whilst in the stop mode, select the track you want to erase pressing the ◀◀ or ▶▶ button.
Or start playing the track to be erased, and then press the ▶ || button.

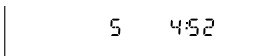

- 2 Press the NAME/TOC EDIT button, and within 10 seconds, select "ERASE" pressing the ▲ or ▼ button.

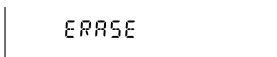

- 3 Within 10 seconds, press the ENTER button.

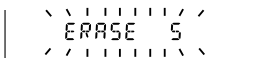

- To cancel the operation, press the ■ button.

- 4 Press the ENTER button again.



- The track is erased, and the unit is stopped at the beginning of the next track.

Note:

- Once a track has been erased, it cannot be recovered. Double-check the track number before erasing it.
- When a track is erased, the numbers assigned to the tracks following the erased track will be automatically decreased by one.
- When a track is erased, the track name will be erased at the same time.
- This function cannot be used in the random play mode and APMS play mode.

■ All Erase

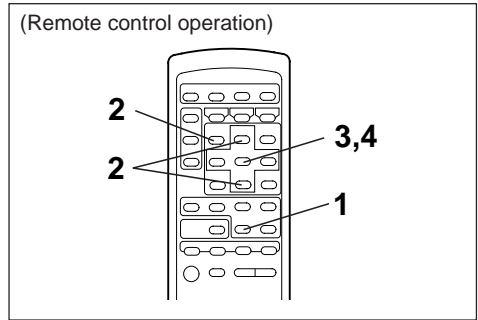

To erase all of the tracks at once:

- 1 Press the ■ button.
● The total number of tracks and the total playing time on an MD will appear.
- 2 Press the NAME/TOC EDIT button, and within 10 seconds, select "ALL ERASE" pressing the ▲ or ▼ button.



- 3 Within 10 seconds, press the ENTER button.



- To cancel the operation, press the ■ button.

- 4 Press the ENTER button again.



- All of the track numbers and track names will be erased.

Note:

- This function cannot be used in the random play mode and APMS play mode.

TIMER OPERATION

- Before setting the timer, make sure that the clock setting is correct. (Page 9)

■ Timer playback

Before timer playback, the following preparations are required.

- Load a CD, MD.
- Preset the radio station.

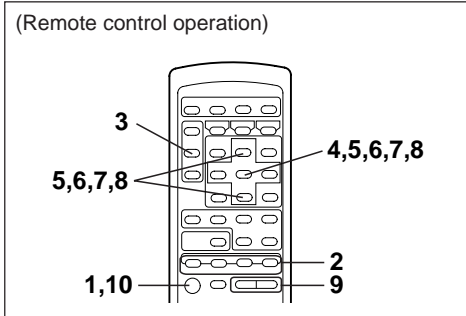

- 1 Press the ON/STAND-BY button to turn the power on.
- 2 Press the MD, CD, TUNER(BAND), AUX button to select desired function.
- 3 Press the TIMER button to select the timer playback mode.



- 4 During "Ⓣ PLAY" is flashing, press the ENTER button.

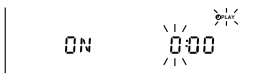

- 5 Press the Δ or ∇ button to set the hour to start, and then press the ENTER button.

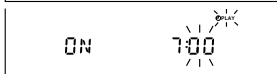

- 6 Press the Δ or ∇ button to set the minute to start, and then press the ENTER button.

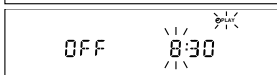

- If not set manually, the ending time will automatically be set for one hour after the starting time.

- 7 Press the Δ or ∇ button to set the hour to stop, then press the ENTER button.

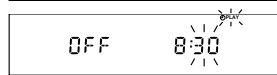

- 8 Press the Δ or ∇ button to set the minute to stop, then press the ENTER button.

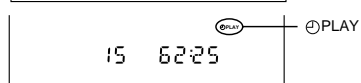
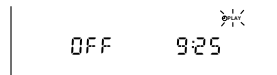

- 9 Rotate the VOLUME control to adjust the sound volume.

- Be careful not to turn the volume up too high.

- 10 Press the ON/STAND-BY button to enter the stand-by mode.

- The timer stand-by indicator will light up.

- 11 When the timer start time is reached, timer playback will start.

- 12 When the timer end time is reached, timer playback will stop.

- "Ⓣ PLAY" will disappear, and the timer mode will be cancelled.

The unit will enter the stand-by mode.

Notes:

- The timer cannot control the component connected to the Auxiliary Input sockets.

- When the CD or MD is played to the end, playback will stop before the stop time. If you wish to play to the stop time, set repeat play for the CD or MD.

To change the programmed contents:

Start again from step 1.

To stop playback during timer playback:

Press the ON/STAND-BY button to enter the stand-by mode.

To confirm the timer setting:

Press the TIMER button once.

- The turn-on time, the turn-off time and name of sound source will be displayed.

To cancel timer operation:

- ① Whilst in the timer stand-by mode, press the ON/STAND-BY button to turn the power on.

- ② Press the TIMER button repeatedly to turn off the timer, "Ⓣ PLAY" will go out.

- Before setting the timer, make sure that the clock setting is correct. (Page 9)

■ Timer recording

Before timer recording, the following preparations are required.

- Load a CD, a recordable MD.
- Preset the radio station.

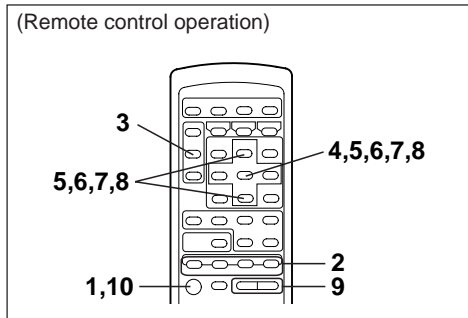

- 1 Press the ON/STAND-BY button to turn the power on.
- 2 Press the CD, TUNER(BAND), AUX button to select desired function.
- 3 Press the TIMER button to select the timer recording mode.
- 4 During "⊕ REC" is flashing, press the ENTER button.



- 5 Within 5 seconds, press the Δ or ∇ button to set the hour to start, and then press the ENTER button.



- 6 Press the Δ or ∇ button to set the minute to start, and then press the ENTER button.

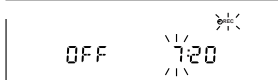

- If not set manually, the ending time will automatically be set for one hour after the starting time.

- 7 Press the Δ or ∇ button to set the hour to stop, then press the ENTER button.

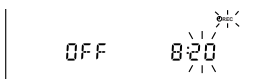
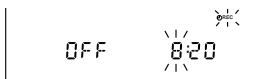

- 8 Press the Δ or ∇ button to set the minute to stop, then press the ENTER button.

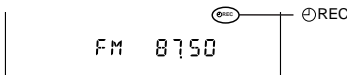

- 9 Rotate the VOLUME control to adjust the sound volume.

- Be careful not to turn the volume up too high.

- 10 Press the ON/STAND-BY button to enter the stand-by mode.

- The timer set indicator will light up.

- 11 When the timer start time is reached, timer recording will start.

- 12 When the timer end time is reached, timer recording will stop.

- "⊕ REC" will disappear, and the timer mode will be cancelled. The unit will enter the stand-by mode.

Notes:

- The timer cannot control the component connected to the Auxiliary Input sockets.
- When the available recording time has been consumed, the recording will stop.

To change the programmed contents:

Start again from step 1.

To confirm the timer setting:

Press the TIMER button once.

- The turn-on time, the turn-off time and name of sound source will be displayed.

To cancel timer operation:

- ① Whilst in the timer stand-by mode, press the ON/STAND-BY button to turn the power on.

- ② Press the ON/STAND-BY button repeatedly to turn off the timer, "⊕ REC" will go out.

Caution:

In the following cases, the timer recording function will not work.

- When a MiniDisc has not been inserted.
- When a playback-only MiniDisc is inserted.
- When the MiniDisc you inserted is protected against accidental erasure.
- When there is no recording space left on the MiniDisc you have inserted (when the "TOC FULL **" or "DISC FULL" messages appear).

■ Sleep operation

The radio, compact disc and MiniDisc can all be turned off automatically.

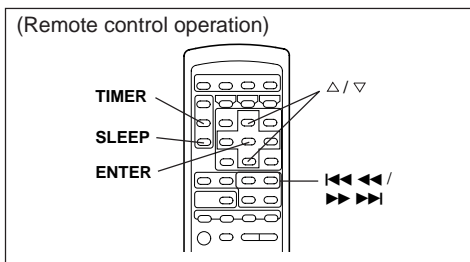

1 Play the desired sound source.

2 Press the SLEEP button.

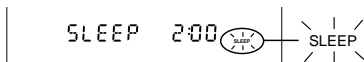

● If you do not need to change the time, the unit will enter the sleep mode automatically.

3 Within 5 seconds, press the ENTER button.

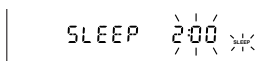

4 Press the Δ or ∇ button to adjust the time. (Maximum: 2 hours - Minimum: 1 minute)

The amount of sleep time can also be changed during the sleep operation.

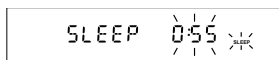

5 Press the ENTER button.

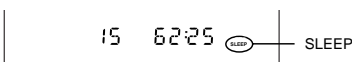

6 The unit will enter the stand-by mode automatically after the preset sleep time has elapsed.

To cancel the sleep operation:

Press the ON/STAND-BY button to enter the stand-by mode.

The sleep operation can also be cancelled as follows if you can not set the unit to the stand-by mode during recording.

① Press the SLEEP button.

● "SLEEP" will flash.

② Within 5 seconds, press the SLEEP button again.

● The sleep operation will be cancelled. ("SLEEP" will go off.)

Notes:

● Once the sleep time is set, it will remain the same duration until the setting is changed.

● The sleep functions of this unit cannot be used to control equipment connected to this unit. You must use the sleep functions of the other equipment, if it has them.

■ Simultaneous sleep and timer operation

To use sleep and timer playback in combination:

- ① Perform steps 1 - 9 on page 39 "Timer playback".
- ② Perform steps 1 - 5 of the "Sleep operation" on this page.

To use sleep and timer recording in combination:

- ① Perform steps 1 - 9 on page 40 "Timer recording".
- ② Perform steps 1 - 5 of the "Sleep operation" on this page.

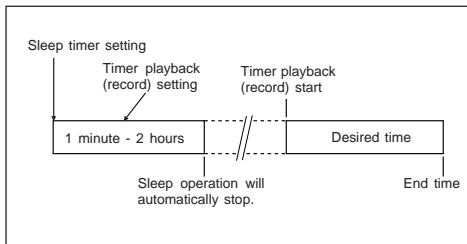

USING EXTERNAL UNITS

■ Connecting external units

Before connecting external units, set this unit to the stand-by mode and turn off the power to the external units.

Connecting to stereos or MD/CD players (equipment which can output analogue signals)

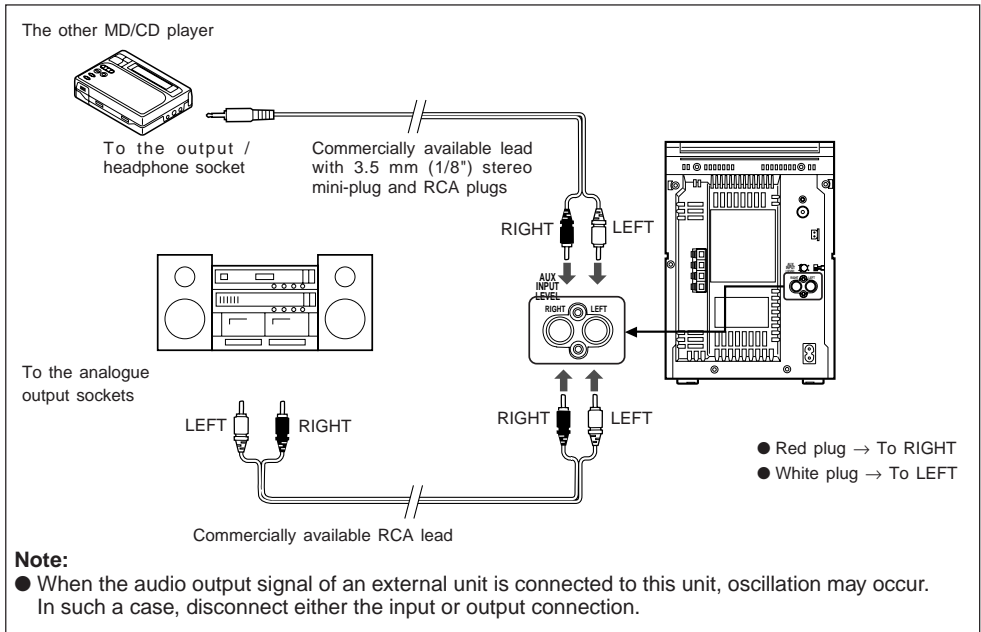

■ Headphones

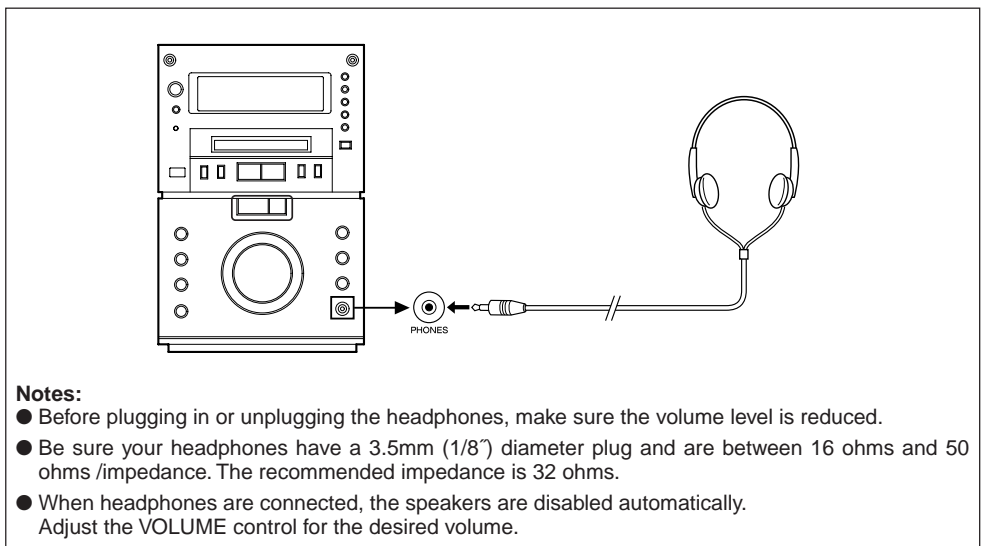

■ Listening to sound from an external unit

To listen to sound from an external unit connected to the analogue input terminals:

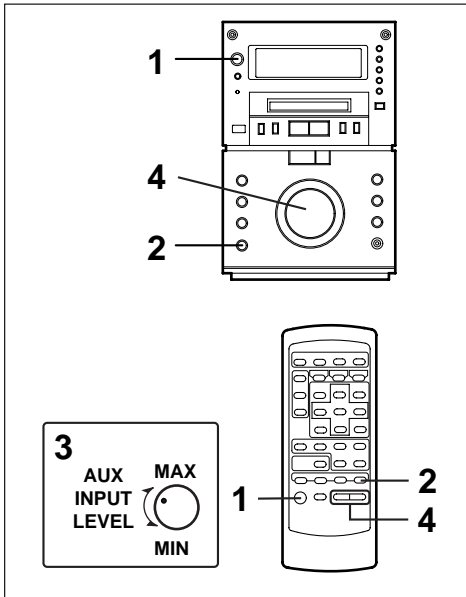

- 1 Press the ON/STAND-BY button to turn the power on.
- 2 Press the AUX button.
- 3 Start playback on the external unit, and adjust the input sound level using the AUX INPUT LEVEL control.
 - When the AUX INPUT LEVEL control is set to Min, no sound is obtained.
 - The maximum level should not exceed "0 dB".
- 4 Adjust the sound level using the VOLUME buttons on the remote control or the VOLUME control on this main unit.

■ Manual recording

You can start recording by yourself whilst listening to the playback from other equipment (tuner or CD).

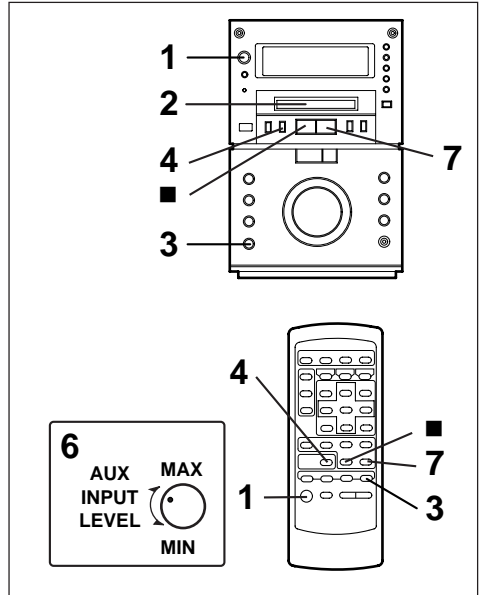

- 1 Press the ON/STAND-BY button to turn the power on.
- 2 Load a recordable MD.
- 3 Press the AUX button.
- 4 Press the ● REC button.
- 5 Start playback on the external unit.
- 6 Adjust the recording level using the AUX INPUT LEVEL control.
 - The maximum level should not exceed "0 dB".
- 7 Press the ►|| button.

To stop recording:

Press the ■ button.

WHAT IS A MINIDISC?

The disc is stored in a cartridge. You can handle it easily without worrying about dust, fingerprints, etc. However, dust entering the opening of the cartridge, dirt on the cartridge, warping, etc. may cause malfunctions. Please note the following.

■ Handling the MiniDisc

Do not touch the disc directly!

Do not open the shutter or touch the disc directly. If the shutter is opened forcibly, it may break.

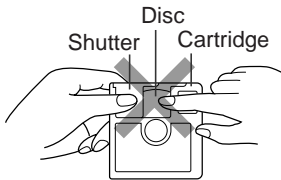

Where not to store discs:

Do not store discs in places with high temperatures or humidity. Specifically, do not leave discs in places exposed to direct sunlight or in cars with doors and windows closed. Do not leave discs in places where sand can get into the cartridge easily (e.g., beaches).

■ To prevent recorded discs from being erased accidentally

Slide the accidental erase prevention tab, located on the side of the disc, in the direction indicated by the arrow.

- The disc will then be protected against accidental erasure.
- To add a recording to such a disc, slide the accidental erase prevention tab back to its original position.

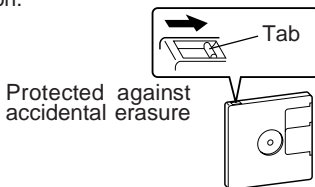

■ What is a MiniDisc?

- A MiniDisc is a 64 mm (2-1/2") diameter disc which is stored in a cartridge. MiniDiscs are easy to handle, compared to compact discs, because they are protected against dust and scratches.
- Recording and playback use a digital system with a sound quality that is similar to that found on compact discs. MiniDiscs cannot twist or stretch like tapes. The quality of sound will not deteriorate. MiniDiscs are extremely durable.
- Never disassemble MiniDiscs.

■ Adaptive Transform Acoustic Coding [ATRAC]

The ATRAC (Adaptive Transform Acoustic Coding) is a new technology that is designed to eliminate the information in sounds which you can not hear and to compress the remaining sound data so that the recording uses about 1/5 of the original sound information. Sound data is analysed and filtered to take advantage of psychoacoustic masking. The acoustic quality of the sound is not impaired.

■ Types of discs

There are two types of discs: playback-only and recordable type.

- Playback-only MiniDisc: This type of MiniDisc is used for commercially available pre-recorded music. This is the same kind of optical disc as CDs. Playback is performed using an optical pickup. (Recording and editing are not possible.)
- Recordable MiniDisc: This is a "raw disc" on which recording can be performed. A magneto optical disc is used. Recordings are made using a laser and magnetic field. Repeated recording is possible.



A Shutter will be used on only one side (back).



Shutters will be used on both sides.

■ How to apply labels

When sticking a label on an MD cartridge, be sure to observe the following. If a label is not affixed properly, an MD may become jammed in the unit such that it can not be removed.

- Stick a label correctly to the specified area. (Do not stick labels to areas other than the specified one.)
- Do not stick one label upon another.
- If a label is peeling off or starts to come loose, replace it with a new one.



■ Shock Resistant Memory

During playback, approximately 10 seconds of information is stored in the semiconductor memory. Therefore, even when the pickup cannot read information for a second or two due to an external shock, the sound continues without interruption because the information stored in memory is output.

MINI DISC SYSTEM LIMITATIONS

Even if the maximum recording time of a MiniDisc has not been reached, "TOC FULL" may be displayed.	In the MD system, the delimiter of the recording area on an MD is programme in a TOC. If partial erasing, recording and editing are repeated several times, TOC information will fill up, even though the number of tracks has not reached the limit (255 tracks), and further recording will be impossible. (If you use the all erase function, this MD can be used from the beginning.)
Even if the maximum recording time of a MiniDisc has not been reached, "DISC FULL" may be displayed.	If there is any flaw on the MiniDisc, that part is automatically excluded from the space available for recording. Therefore, the recording time becomes shorter.
Even if several short tracks are erased, the remaining recording time may not show an increase.	When the remaining recording time of a disc is displayed, short tracks less than 12 seconds long may not be included in the total.
Two tracks may not be combined in editing.	For MiniDiscs on which repeated recording and editing operations were performed, the COMBINE function may not work. A track recorded from a CD (digital recording) and a track recorded from a radio or other equipment (analogue recording) cannot be combined.
The total of the recorded time and time remaining on a disc may not add up to the maximum possible recording time.	A cluster (about 2 seconds) is normally the minimum unit of recording. So, even if a track is less than 2 seconds long, it will use about 2 seconds of space on the disc. Therefore, the time actually available for recording may be less than the remaining time displayed. If there are scratches on discs, those sections will be automatically avoided (no recording will be placed in those sections). Therefore, the recording time will be reduced.
If recorded tracks are fast reversed or fast forwarded, the sound may skip.	An MD which has been recorded or edited repeatedly may skip during fast reverse or fast forward.

TROUBLESHOOTING

■ If a problem occurs

If this unit functions abnormally during operation, first check the following items. If the unit continues to function abnormally, or if an abnormality appears other than listed below, set this unit to the stand-by mode and disconnect the AC power plug, then consult your SHARP dealer or service personnel.

General

Symptom	Possible cause	Remedy
● The clock is wrong.	● Did a power failure occur?	● Try setting it again.
● When a button is pressed, the unit does not respond.	_____	● Set this unit to the stand-by mode and then turn it back on. Then, retry the operation.
● No sound is heard.	● Is the volume level is set to "0"? ● Are the headphones connected? ● Are the speaker wires disconnected?	● Increase the volume level. ● Disconnect the headphones. ● Connect the wires securely.
● Radios make unusual noise or the picture on the TV screen is distorted.	● When a radio or TV which uses an indoor aerial is placed near the unit, the picture on the TV screen may be distorted or the radio may not function properly.	● It is recommended that you use an external aerial.

CD Playback

Symptom	Possible cause	Remedy
<ul style="list-style-type: none"> ● Even though a disc has been loaded, "NO DISC" or "ERR" is displayed. ● Playback stops in the middle of a track, or playback is not performed properly. ● Playback sounds are skipped. 	<ul style="list-style-type: none"> ● The disc is loaded up-side down. ● The disc is very dirty. ● The disc which does not satisfy the standards. ● Is the unit located near excessive vibrations? ● Has condensation formed inside the unit? 	<ul style="list-style-type: none"> ● Load the disc with the correct side up. ● Clean the disc. ● Load the correct disc. ● Place the unit on a firm, level surface free from vibration. ● Remove the disc and leave the power turned on. The unit should function properly in about 1 hour.

MD recording and playback

Symptom	Possible cause	Remedy
<ul style="list-style-type: none"> ● A recording cannot be made. 	<ul style="list-style-type: none"> ● Is the MiniDisc protected against accidental erasure? ● Did you try to make recording on a play-back only MiniDisc? ● Can you see the "DISC FULL" or "TOC FULL * " message in the display? ● (* :number or symbol) 	<ul style="list-style-type: none"> ● Slide the accidental erase prevention tab back to its original position. ● Replace it with a recordable disc. ● Put in another recordable disc with recording space on it.
<ul style="list-style-type: none"> ● Even though a disc has been loaded, "MD NO DISC" or "READ ERR" is displayed. ● Playback sounds are skipped. 	<ul style="list-style-type: none"> ● The disc is very dirty. ● Is the unit located near excessive vibrations? ● Has condensation formed inside the unit? 	<ul style="list-style-type: none"> ● Clean the disc. ● Place the unit on a firm, level surface free from vibration. ● Remove the disc and leave the power turned on. The unit should function properly in about 1 hour.

Radio reception

Symptom	Possible cause	Remedy
<ul style="list-style-type: none"> ● Radios make unusual noise consecutively. 	<ul style="list-style-type: none"> ● The unit is placed near the TV or computer. ● The aerial direction is not placed properly. 	<ul style="list-style-type: none"> ● When the unit receives a radio broadcast near a TV set, a computer or a word-processor, it may pick up noise. If this happens, try to move the unit from the place where the noise is picked up. ● Correct the aerial direction.
<ul style="list-style-type: none"> ● The preset channel cannot be recalled. 	<ul style="list-style-type: none"> ● Did you erase the programmed station? 	<ul style="list-style-type: none"> ● Preset the channel again. ● Redio programming.

Remote control

Symptom	Possible cause	Remedy
<ul style="list-style-type: none"> ● The remote control does not function or does not operate properly. 	<ul style="list-style-type: none"> ● The batteries (polarity) are not inserted properly. ● The batteries inside the remote control are dead. ● The remote control is operated from an incorrect distance or angle. 	<ul style="list-style-type: none"> ● Insert properly. ● Replace the batteries. ● Operate it within a range of 0.2 m (8") to 6 m (20') and within an angle of 15 ° to either side of centre.
<ul style="list-style-type: none"> ● The power cannot be turned on from the remote control. 	<ul style="list-style-type: none"> ● Is the AC power lead plugged in? 	<ul style="list-style-type: none"> ● Connect the AC power lead.

ERROR MESSAGES

When an error message is displayed, proceed as follows:

Error messages	Meaning	Remedy
BLANK MD	<ul style="list-style-type: none"> ● Nothing is recorded. 	<ul style="list-style-type: none"> ● Replace it with another disc.
CAN'T EDIT	<ul style="list-style-type: none"> ● A track cannot be edited. 	<ul style="list-style-type: none"> ● Change the stop position of the track and then try editing it.
CAN'T REC	<ul style="list-style-type: none"> ● Recording cannot be performed correctly due to vibra-tion or shock in the unit. ● Timer recording is impossible or there is no available space on the MD. 	<ul style="list-style-type: none"> ● Re-record or replace the MiniDisc. ● Replace it with another disc.
CD NO DISC	<ul style="list-style-type: none"> ● A CD has not been loaded. ● The disc data cannot be read. 	<ul style="list-style-type: none"> ● Load a CD. ● Reload the CD.
DISC FULL	<ul style="list-style-type: none"> ● The disc is out of recording space. 	<ul style="list-style-type: none"> ● Replace the disc with another recordable disc.
FOCUS ERR	<ul style="list-style-type: none"> ● A disc has not been loaded. ● The disc data cannot be read. 	<ul style="list-style-type: none"> ● Reload the MiniDisc.
MD ERR	<ul style="list-style-type: none"> ● Trouble is found. 	<ul style="list-style-type: none"> ● Contact the shop where you purchased the unit.
MD NO DISC	<ul style="list-style-type: none"> ● A MiniDisc has not been loaded. ● The disc data cannot be read. 	<ul style="list-style-type: none"> ● Load a MiniDisc. ● Reload the MiniDisc.
MECHA ERR* (*:Number or symbol)	<ul style="list-style-type: none"> ● The disc data cannot be read. ● There is a mechanical problem and the disc is not working properly. 	<ul style="list-style-type: none"> ● Set this unit to the stand-by mode and press the MD EJECT button.
NAME FULL	<ul style="list-style-type: none"> ● The number of characters for the disc name or track name exceeds 40. 	<ul style="list-style-type: none"> ● Shorten the disc or track name.
NOT AUDIO	<ul style="list-style-type: none"> ● The data recorded on this disc is not audio data. 	<ul style="list-style-type: none"> ● Select another track. ● Replace the disc.
PLAYBACK MD	<ul style="list-style-type: none"> ● You tried to record on a playback-only disc. 	<ul style="list-style-type: none"> ● Replace it with another recordable disc.
PROTECTED	<ul style="list-style-type: none"> ● The disc is write protected. 	<ul style="list-style-type: none"> ● Move the write protection tab back to its original position.
READ ERR	<ul style="list-style-type: none"> ● The disc is damaged. ● A TOC is not written on the MD or there is something wrong with data. 	<ul style="list-style-type: none"> ● Reload the disc or replace it.
TEMP OVER	<ul style="list-style-type: none"> ● The temperature is too high. 	<ul style="list-style-type: none"> ● Set this unit to the stand-by mode and wait for a while.
TOC ERR* (*:Number or symbol)	<ul style="list-style-type: none"> ● The disc is damaged. ● TOC information cannot be read. ● MD not specified. 	<ul style="list-style-type: none"> ● Replace it with another disc.
TOC FULL* (*:Number or symbol)	<ul style="list-style-type: none"> ● There is no space left for recording character information(track names, disc names, etc.). 	<ul style="list-style-type: none"> ● Replace it with another recordable disc.
TOC W ERR	<ul style="list-style-type: none"> ● Recording is impossible. 	<ul style="list-style-type: none"> ● Contact the shop where you purchased the unit.
U TOC ERR* (*:symbol)	<ul style="list-style-type: none"> ● TOC information recorded on the MD does not match the MD specifications or it cannot be read. 	<ul style="list-style-type: none"> ● Replace it with another disc. ● Erase all of the track, and try recording.
U TOC ERR W	<ul style="list-style-type: none"> ● The TOC information could not be created properly due to a mechanical shock or to scratches on the disc. 	<ul style="list-style-type: none"> ● Set this unit to the stand-by mode and try to write the TOC again. (Remove any source of shock or vibration whilst writing.)
? DISC	<ul style="list-style-type: none"> ● The data contains an error. 	<ul style="list-style-type: none"> ● Replace it with another disc.
00:00	<ul style="list-style-type: none"> ● Music is not being recorded. 	<ul style="list-style-type: none"> ● Replace the disc with another recordable disc.

RESETTING THE MICROCOM-PUTER

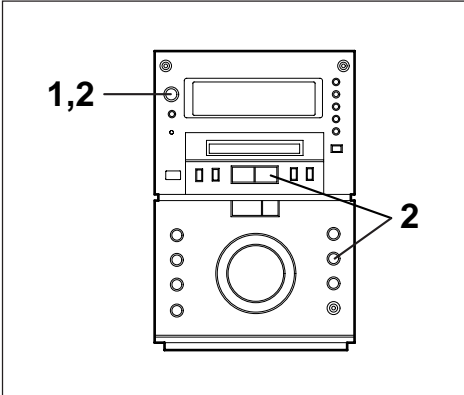

If this product is subjected to strong external interference (mechanical shock, excessive static electricity, abnormal supply voltage due to lightning, etc.) or if it is operated incorrectly, it may malfunction or the display may not function correctly. If such a problem occurs, do the following:

- 1 Press the ON/STAND-BY button to enter the stand-by mode.
- 2 Press the ON/STAND-BY button whilst holding down the EQUALIZER button and the PLAY button.

Caution:

- The operation explained above will erase all data stored in memory including clock and timer settings, and tuner, MD and CD presets.

MAINTENANCE

Internal care

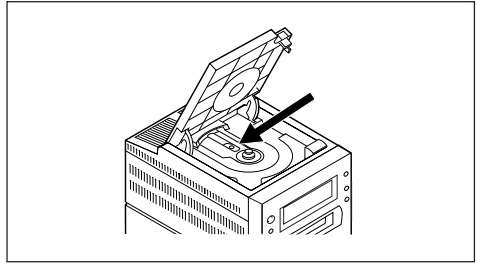

- Do not touch the Laser pickup lens. If fingerprints or dust accumulate on the pickup, clean it gently with a dry cotton swab.

External care

- Periodically wipe the cabinet with a soft cloth and a diluted soap solution, then wipe with a dry cloth.
- Do not use chemically treated cleaning cloths or other chemicals.

Care of compact discs

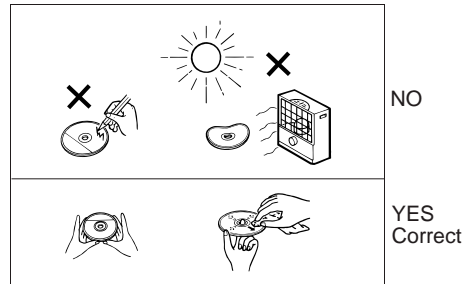

Compact discs are fairly resistant to damage, however mistracking can occur due to an accumulation of dirt on the disc surface.

Follow the guidelines below for maximum enjoyment from your CD collection and player.

- Do not write on either side of the disc, particularly the non-label side. Signals are read from the non-label side. Do not mark this surface.
- Keep your discs away from direct sunlight, heat, and excessive moisture.
- Always hold the CDs by the edges. Fingerprints, dirt, or water on the CDs can cause noise or mistracking. If a CD is dirty or does not play properly, clean it with a soft, dry cloth, wiping straight out from the centre, along the radius.

SPECIFICATIONS

As part of our policy of continuous improvement, SHARP reserves the right to make design and specification changes for product improvement without prior notice. The performance specification figures indicated are nominal values of production units. There may be some deviations from these values in individual units.

● General

Power source: AC 230 V, 50 Hz

Power consumption: 60 W

Dimensions: Width; 160 mm (6-5/16")
Height; 240 mm (9-1/2")
Depth; 300 mm (11-13/16")
Weight: 4.4 kg (9.7 lbs.)

● MiniDisc recorder section

Type: MiniDisc recorder

Signal readout: Non-contact, 3-beam semiconductor laser pickup

Rotation speed: 400 - 900 rpm CLV, Approx

Error correction: ACIRC (Advanced Cross Interleave Reed-Solomon Code)

Quantization: 20-bit linear (A/D converter)

Coding: ATRAC (Adaptive Transformed Acoustic Coding)

Sampling frequency: 44.1 kHz

Recording method: Magnetic modulation overwrite method

Frequency response: 20 - 20,000 Hz

D/A converter: 1-bit D/A converter

Wow and flutter: Unmeasurable (less than 0.001% W. peak)

Signal/noise ratio: 95 dB (1 kHz)

Dynamic range: 90 dB (1 kHz)

Audio channel: Stereo; 2 channels
Monaural; 1 channel (playback only)
(long-time recording mode)

● Compact disc player section

Type: Top open type compact disc player

Signal readout: Non-contact, 3-beam semiconductor laser pickup

Rotation speed: 200 - 500 rpm CLV, Approx.

Error correction: CIRC (Cross Interleave Reed-Solomon Code)

Quantization: 16-bit linear

Frequency response: 20 - 20,000 Hz

D/A converter: 1-bit D/A converter

Signal/noise ratio: 95 dB (1 kHz)

Dynamic range: 90 dB (1 kHz)

Wow and flutter: Unmeasurable (less than 0.001% W. peak)

● Tuner section

Frequency range: FM; 87.5 - 108.0 MHz
AM; 522 - 1,620 kHz

Sensitivity: FM; 2.5 μ V (75 ohms unbalanced)
AM; 650 μ V/m

● Amplifier section

Output power: RMS 20 W/CH (DIN 45 324)
MPO 30 W/CH (DIN 45 324)

Output terminals: Speaker; 4 ohms
Headphones; 16 - 50 ohms (recommended 32 ohms)

Input terminals: AUX; 500 mV/47 kohms

● Speaker section

Type: 2-way speaker system
12cm (4-3/4") woofer,
2cm (3/4") tweeter

Maximum input power: 40 W

Rated input power: 20 W

Impedance: 4 ohms

Dimensions: Width; 160 mm (6-5/16")
Height; 240 mm (9-1/2")
Depth; 198 mm (7-7/8")
Weight; 2.9 kg (6.4 lbs./each)

MEMO

Free Manuals Download Website

<http://myh66.com>

<http://usermanuals.us>

<http://www.somanuals.com>

<http://www.4manuals.cc>

<http://www.manual-lib.com>

<http://www.404manual.com>

<http://www.luxmanual.com>

<http://aubethermostatmanual.com>

Golf course search by state

<http://golfingnear.com>

Email search by domain

<http://emailbydomain.com>

Auto manuals search

<http://auto.somanuals.com>

TV manuals search

<http://tv.somanuals.com>