

SHARP®

MODEL

DK-KP82PH

SLIM MICRO SYSTEM

OPERATION MANUAL

Thank you for purchasing this SHARP product. To obtain the best performance from this product, please read this manual carefully. It will guide you in operating your SHARP product.

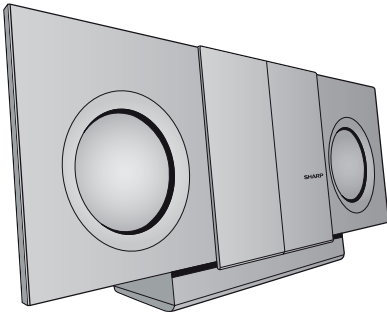

Made for

 iPod  iPhone  iPad

iPad, iPhone, iPod, iPod classic, iPod nano, and iPod touch are trademarks of Apple Inc., registered in the U.S. and other countries. Lightning is a trademark of Apple Inc.

"Made for iPod," "Made for iPhone," and "Made for iPad" mean that an electronic accessory has been designed to connect specifically to iPod, iPhone, or iPad respectively, and has been certified by the developer to meet Apple performance standards. Apple is not responsible for the operation of this device or its compliance with safety and regulatory standards. Please note that the use of this accessory with iPod, iPhone, or iPad may affect wireless performance.



MP3



X-BASS

Special Note

Supply of this product does not convey a license nor imply any right to distribute content created with this product in revenue-generating broadcast systems (terrestrial, satellite, cable and/or other distribution channels), revenue-generating streaming applications (via Internet, intranets and/or other networks), other revenue-generating content distribution systems (pay-audio or audio-on-demand applications and the like) or on revenue-generating physical media (compact discs, digital versatile discs, semiconductor chips, hard drives, memory cards and the like). An independent license for such use is required. For details, please visit <http://mp3licensing.com>
MPEG Layer-3 audio coding technology licensed from Fraunhofer IIS and Thomson.



SHARP CORPORATION

13B R MW ①

TINSEA420AWZZ Download from Www.Somanuals.com. All Manuals Search And Download.

Special Notes

WARNINGS





- When the ON/STAND-BY button is set at STAND-BY position, mains voltage is still present inside the unit. When the ON/STAND-BY button is set at STAND-BY position, the unit may be brought into operation by the timer mode or remote control.
- This unit contains no user serviceable parts. Never remove covers unless qualified to do so. This unit contains dangerous voltages, always remove mains plug from the socket before any service operation and when not in use for a long period.
- To prevent fire or shock hazard, do not expose this appliance to dripping or splashing. No objects filled with liquids, such as vases, shall be placed on the apparatus.
- Do not turn the volume on to full at switch on. Listen to music at moderate levels. Excessive sound pressure from earphones and headphones can cause hearing loss.

Caution:

- This product is classified as a CLASS 1 LASER PRODUCT.
- This product contains a low power laser device. To ensure continued safety do not remove any cover or attempt to gain access to the inside of the product. Refer all servicing to qualified personnel.

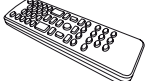
Accessories

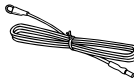
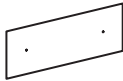
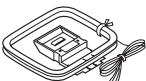
The following accessories are included.

 <p>Remote control x 1 (RRMCGA272AWSA)</p>	 <p>"AA" size battery (UM/SUM-3, R6, HP-7 or similar) x 1</p>	 <p>FM aerial x 1</p>	 <p>Pattern Paper</p>
 <p>AM loop aerial x 1</p>	 <p>Stand for iPad x 1</p>		

Precautions

■ General

- Please ensure that the equipment is positioned in a well ventilated area and ensure that there is at least 10 cm (4") of free space along the sides and top of the equipment.

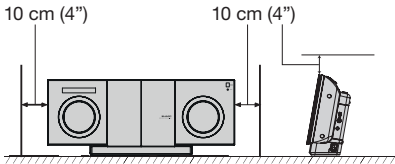

- Use the unit on a firm, level surface free from vibration.
- Place the unit at least 30 cm (12") away from any CRT TV to avoid colour variations across the TV screen. If the variations persist, move the unit further away from the TV. LCDTV is not prone to such variation.
- Keep the unit away from direct sunlight, strong magnetic fields, excessive dust, humidity and electronic/electrical equipment (home computers, facsimiles, etc.) which generate electrical noise.
- Do not place anything on top of the unit.
- Do not expose the unit to moisture, to temperatures higher than 40°C (104°F) or to extremely low temperatures.
- If your system does not work properly, disconnect the AC power lead from the wall socket. Plug the AC power lead back in, and then turn on your system.
- In case of an electrical storm, unplug the unit for safety.

- Hold the AC power plug by the head when removing it from the wall socket, as pulling the lead can damage internal wires.
- The AC power plug is used as a disconnect device and shall always remain readily operable.
- **Do not remove the outer cover, as this may result in electric shock. Refer internal service to your local SHARP service facility.**
- The ventilation should not be impeded by covering the ventilation openings with items, such as newspapers, tablecloths, curtains, etc.
- No naked flame sources, such as lighted candles, should be placed on the apparatus.
- Attention should be drawn to the environmental aspects of battery disposal.
- This unit should only be used within the range of 5°C - 35°C (41°F - 95°F).

Warning:

The voltage used must be the same as that specified on this unit. Using this product with a higher voltage other than that which is specified is dangerous and may result in a fire or other type of accident causing damage. SHARP will not be held responsible for any damage resulting from use of this unit with a voltage other than that which is specified.

■ Volume control

The sound level at a given volume setting depends on speaker efficiency, location, and various other factors. It is advisable to avoid exposure to high volume levels. Do not turn the volume on to full at switch on. Listen to music at moderate levels. Excessive sound pressure from earphones and headphones can cause hearing loss.

Controls and indicators

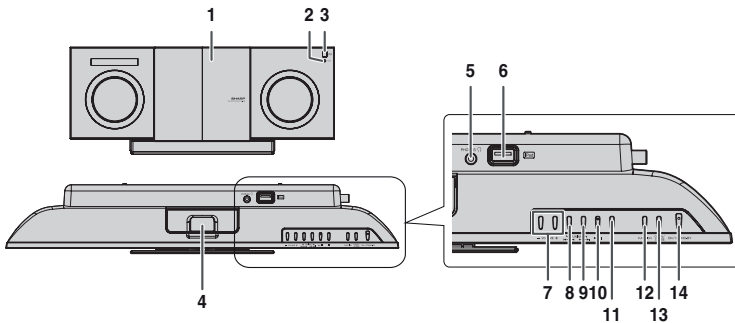

■ Front panel

1. Disc Compartment
2. Timer indicator
3. Remote sensor
4. Docking Station for iPod or iPhone
5. Headphone Terminal
6. USB Terminal
7. Volume buttons
8. Tuning Down, CD/USB Track Down, iPod/iPhone Skip Down
9. Tuning Up, CD/USB Track Up, iPod/iPhone Skip Up
10. Disc/USB/iPod/iPhone Play or Pause Button
11. Disc/USB Stop Button
12. FUNCTION Button
13. Disc Compartment Open/Close Button
14. On/Stand-by Button

Controls and indicators

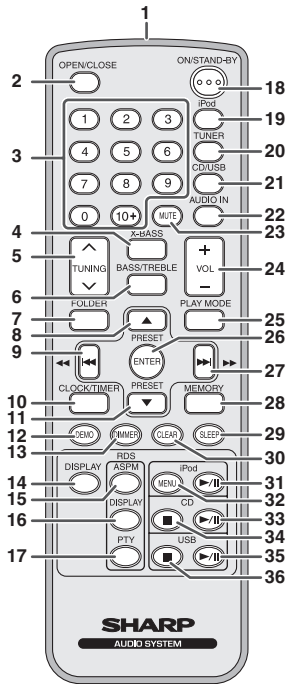

Remote control

- Remote Control Transmitter
- Open / Close Button
- Numeric Buttons
- X-Bass Button
- Tuning Up / Down Button
- Bass / Treble Button
- Folder Button
- Tuner Preset Up Button, iPod Cursor Up
- Skip Down, Fast Reverse, Time Down Button
- Clock/Timer Button
- Tuner Preset Down Button, iPod Cursor Down
- Demo Button
- Dimmer Button
- Display Button
- RDS ASPM Button
- RDS Display Button
- RDS PTY Button
- On/Stand-by Button
- iPod Button
- Tuner Button
- CD/USB Button
- Audio In Button
- Mute Button
- Volume Up/Down Button
- Play Mode Button
- Enter Button
- Skip Up, Fast Forward, Time Up Button
- Memory Button
- Sleep Button
- Clear Button
- iPod Play/Pause Button
- iPod Menu Button
- CD Play/Pause Button
- CD Stop Button
- USB Play/Pause Button
- USB Stop Button

Display

- USB Indicator
- iPod Indicators
- CD Indicator
- MP3 Indicator
- WMA Indicator
- RDM (Random) Indicator
- MEM (Memory) Indicator
- Repeat Indicator
- Play/Pause Indicator
- Tuning FM Indicator
- FM Stereo Mode Indicator
- Stereo Station Indicator
- RDS Indicator
- PTY Indicator
- TP Indicator
- TA Indicator
- Muting Indicator
- X-bass Indicator
- Title Indicator
- Artist Indicator
- Folder Indicator
- Album Indicator
- File Indicator
- Track Indicator
- Daily Timer Indicator
- Once Timer Indicator
- Disc Indicator
- Total Indicator
- Sleep Indicator

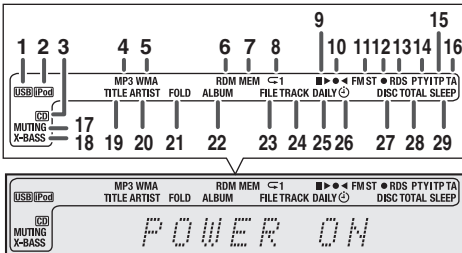

Wall mount preparation

To mount the unit on the wall

Caution:

- Be very careful to prevent the unit [2.45 kg (5.4 lbs.)] from falling when mounting on the wall.
- Before mounting, check the wall strength. (Do not put on the veneer plaster or whitewashed wall. The unit may fall.) If unsure, consult a qualified service technician.
- Mounting screws are not supplied. Use appropriate ones.
- Check all wall mount screws for looseness.
- Select a good location. If not, accidents may occur or the unit may get damaged.
- **SHARP is not responsible for accidents resulting from improper installation.**

■ Driving screws

SHARP designed the unit so you may hang it on the wall. Use proper screws (not supplied). See below for size and type.

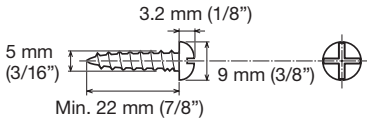

■ Installing the unit

- 1 Fix the pattern paper to the wall in horizontal position as below.

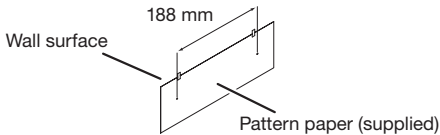

- 2 Make a hole on the wall following the screw point marks on the pattern paper by using a drill.

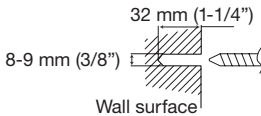

- 3 Fix a wall mount plug into the hole using a hammer, until it is flush with the wall surface.

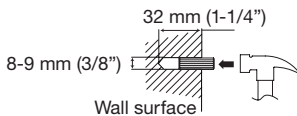

- 4 Fasten the screws to the wall as shown below. (Total screw is 2 pieces).

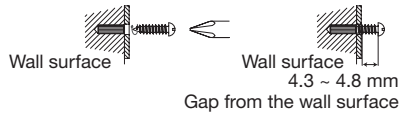

- 5 Hang the unit onto the screws.

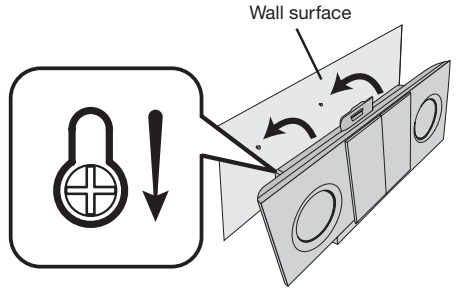

■ Falling prevention

Safety wires (not supplied) are useful to prevent the unit from falling off the wall.

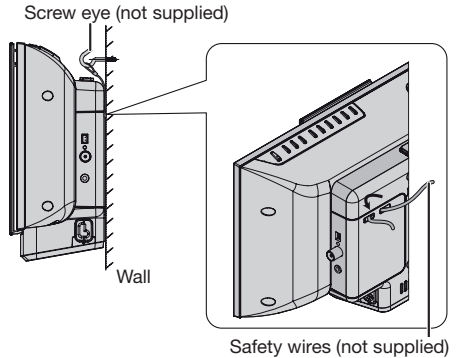

Loop the safety wires (not supplied) into each hole as shown and tie the safety wires to a hook (screw eye).

Ø wire > 1.5 mm

The diameter of wire/cable must be less than 1.5 mm.

System connections

Make sure to unplug the AC power lead before making any connections.

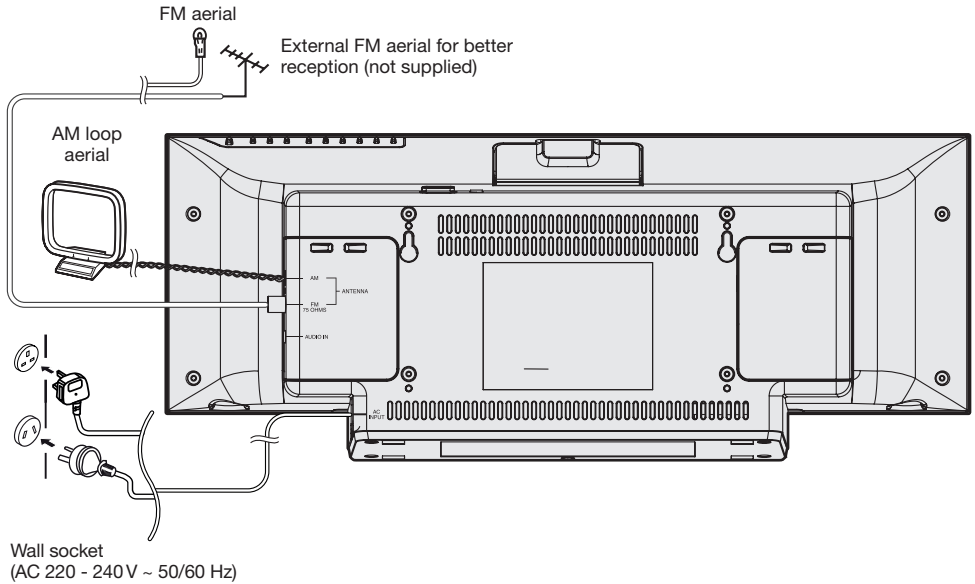

Wall socket
(AC 220 - 240V ~ 50/60 Hz)

■ Aerial connection

Supplied FM aerial:

Connect the FM aerial wire to the FM 75 OHMS socket and position the FM aerial wire in the direction where the strongest signal can be received.

External FM aerial:

Use an external FM aerial (75 ohms coaxial cable) for better reception. When an external FM aerial is used, disconnect the supplied FM aerial wire.

Installing the AM loop aerial:

<Assembling>

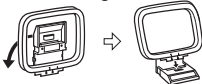

<Attaching to the wall>

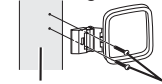

Wall Screws (not supplied)

Note:

Placing the aerial on the unit or near the AC power lead may cause noise pickup. Place the aerial away from the unit for better reception.

■ AC power connection

After checking all the connections have been made correctly, plug the AC power lead of this unit into the wall socket.

Note:

Unplug the AC power lead from the wall socket if the unit will not be in use for a prolonged period of time.

■ Demonstration mode

- The first time the unit is plugged in, the unit will enter the demonstration mode.
- To cancel the demonstration mode, press the DEMO button (remote control) during power stand-by mode. The unit will enter the low power consumption mode.
- To return to the demonstration mode, press the DEMO button again.
- If iPod or iPhone is docked, the unit will begin charging. "Charge Mode" will be displayed. Demonstration mode is invalid during charge mode.

Remote control

■ Battery installation

- 1 Open the battery cover.
- 2 Insert the supplied battery according to the terminal indicated in the battery compartment.
When inserting or removing the battery, push it towards the (-) battery terminals.
- 3 Close the cover.

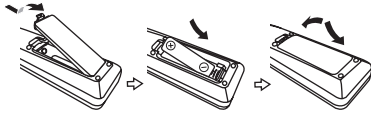

Caution:

- Remove the battery if the unit will not be used for a long period of time. This will prevent potential damage due to battery leakage.
- Do not use rechargeable battery (nickel-cadmium battery, etc.).
- Installing the battery incorrectly may cause the unit to malfunction.
- Batteries (battery pack or batteries installed) shall not be exposed to excessive heat such as sunshine, fire or the like.

Notes concerning use:

- Replace the battery if the operating distance is reduced or if the operation becomes erratic. Purchase an "AA" size battery (UM/SUM-3, R6, HP-7 or similar).
- Periodically clean the transmitter on the remote control and the sensor on the unit with a soft cloth.
- Exposing the sensor on the unit to strong light may interfere with operation. Change the lighting or the direction of the unit if this occurs.
- Keep the remote control away from moisture, heat, shock, and vibrations.

■ Test of the remote control

Check the remote control after checking all the connections. Point the remote control directly at the remote sensor on the unit. The remote control can be used within the range shown below:

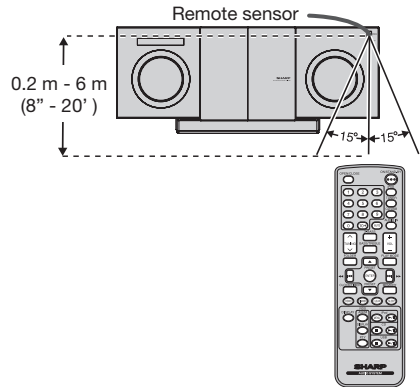

General control

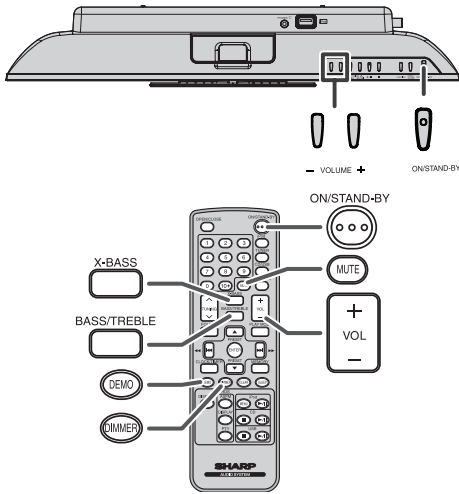

■ To turn the power on

Press the ON/STAND-BY button to turn the power on.

After use:

Press the ON/STAND-BY button to enter the power stand-by mode.

■ Display brightness control

To dim the display brightness, press the DIMMER button on the remote control.

- Dimmer 1 (Display is dim).
- ↓ Dimmer 2 (Display gets dimmer).
- ← Dimmer Off (Display is bright).

■ Volume auto fade-in

If you turn off and on the main unit with the volume set to 27 or higher, the volume starts at 12 and fades in to the last set level.

■ Volume control

Press VOLUME (+ or -) on the main unit or VOL +/- on the remote control to increase or decrease the volume.

■ Direct key power on function

When you press any of the following buttons, the unit turns on.

- iPod, CD/USB, AUDIO IN, TUNER on the remote control: Selected function is activated.
- ►/⏮ button on the main unit: The unit turns on and playback of the last function will start (CD, TUNER, USB, iPod, AUDIO IN)

■ Auto power off function

The main unit will enter the stand-by mode (when iPad, iPod or iPhone is not connected) after 15 minutes of inactivity during:

iPod: Not docked.

Audio In: No detection of input signal.

CD: In the stop mode or no disc.

USB: In the stop mode or no media.

Note:

However, if iPod or iPhone is docked, the unit will begin charging.

“Charge Mode” will be displayed.

■ Muting

The volume is muted temporarily when pressing the MUTE button on the remote control. Press again to restore the volume.

■ X-Bass control

When the power is first turned on, the unit will enter the extra bass mode which emphasises the bass frequencies, and “X-BASS” indicator will appear. To cancel the extra bass mode, press the X-BASS button on the remote control.

■ Bass control

- 1 Press the BASS/TREBLE button to select “Bass”.
- 2 Within 5 seconds, press the VOLUME (+ or -) button to adjust the bass. “X-BASS” indicator will disappear.

Bass 0
- 5 ↔ - 4 ↔ + 4 ↔ + 5

■ Treble control

- 1 Press the BASS/TREBLE button to select “Treble”.
- 2 Within 5 seconds, press the VOLUME (+ or -) button to adjust the treble. “X-BASS” indicator will disappear.

Treble 0
- 5 ↔ - 4 ↔ + 4 ↔ + 5

■ Function

When the FUNCTION button on main unit is pressed, the current function will change to different mode. Press the FUNCTION button repeatedly to select desired function.



Note:

The backup function will protect the memorised function mode for a few hours should there be a power failure or the AC power lead becomes disconnected.

Listening to the iPod, iPhone or iPad

Made for:

- iPhone 5
- iPhone 4S
- iPhone 4
- iPhone 3GS
- iPhone 3G
- iPhone
- iPad (4th generation)
- iPad mini
- iPad (3rd generation)
- iPad 2
- iPod
- iPod touch (5th generation)
- iPod touch (4th generation)
- iPod touch (3rd generation)
- iPod touch (2nd generation)
- iPod touch (1st generation)
- iPod classic
- iPod nano (7th generation)
- iPod nano (6th generation)
- iPod nano (5th generation)
- iPod nano (4th generation)
- iPod nano (3rd generation)
- iPod nano (2nd generation)

Caution:

Please update your iPod, iPhone and iPad unit to the latest software version before using it. Please visit Apple's homepage to download the latest version for your iPod, iPhone and iPad.

Notes:

- Charging terminal for iPod, iPhone and iPad:

CONDITION	DOCK	USB TERMINAL
USB function	NO	YES
Other function (iPod / CD / Tuner / Audio In)	YES	NO
Stand-by	YES	NO
DEMO	YES	NO

- The message "This accessory is not made to work with iPhone" or similar, may appear on the iPhone screen when:
 - battery is low.
 - the iPhone is not properly docked (eg. slanting).
- If this occurs, remove and re-dock the iPhone.
- You may also experience brief audio interference during incoming calls.

■ iPod, iPhone and iPad connection (USB only)

- 1 Insert the connector to the iPod, iPhone or iPad.

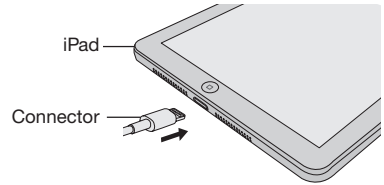

- 2 Place the iPad to the stand for iPad.

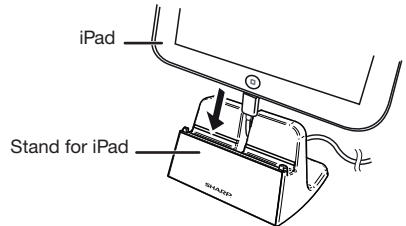

- 3 Connect the iPod, iPhone or iPad to the unit via USB connector.

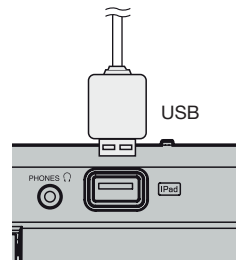

■ iPod, iPhone or iPad playback via USB terminal

- 1 Press the ON/STAND-BY button to turn the power on.
- 2 Press the CD/USB button on the remote control or FUNCTION button repeatedly on the main unit to select USB function.
- 3 Connect iPod, iPhone or iPad to the unit. "USB/iPod" will appear.

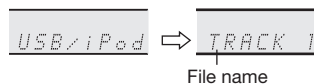

- 4 Press the ►/⏮ (USB ►/⏮) button to start playback.

Note:

Stop button (■) is invalid during iPod, iPhone or iPad playback

Listening to the iPod, iPhone or iPad (continued)

■ iPhone playback

- Sound will only switch from iPhone to the main unit after authentication process is completed in approximately 10 seconds.
- Incoming calls will pause the playback.
- Once the calls are answered, the conversation can only be heard through the built-in iPhone speaker. Turn on the iPhone speaker or undock the iPhone to start conversation.

■ iPod and iPhone connection (Dock only)

Caution:

Unplug all accessories from the iPod or iPhone before inserting it into the dock.

Note:

Docking station is for iPod touch (5th generation), iPod nano (7th generation) and iPhone 5 connection only. Other Apple products (iPod, iPhone and iPad) can be connected via USB terminal.

- 1 Open the docking station for iPod and iPhone by pulling up the cover.



- 2 Dock your iPod or iPhone into the unit.

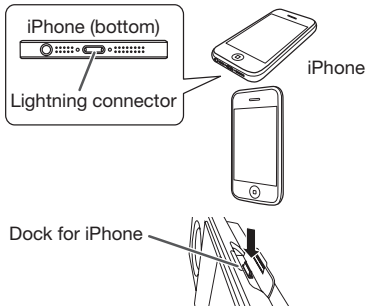

■ iPod or iPhone playback

- 1 Press the ON/STAND-BY button to turn the power on.
- 2 Press the iPod button on the remote control or FUNCTION button repeatedly on the main unit to select iPod function.
- 3 Insert iPod or iPhone unit into the dock of main unit. "Dock Ok" will appear.
- 4 Press the ▶/⏮ (iPod ▶/⏮) button to start playback.

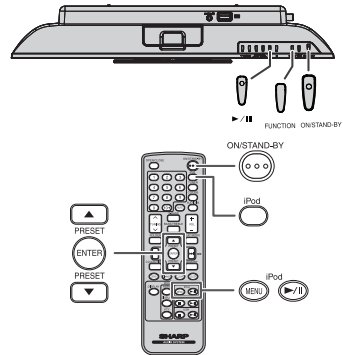

■ Navigating the iPod, iPhone or iPad menus

- 1 Press the MENU button to view the menu on iPod, iPhone or iPad unit. Press it again to go back to previous menu.
- 2 Use the PRESET (▼ or ▲) button to select an item on the menu and then press ENTER button.

Note:

When navigating the iPod, iPhone or iPad menu with remote control, do not operate any of the buttons on the iPod or iPhone unit. The volume level is adjusted by pressing the VOLUME (+ or -) on the main unit or VOL +/- on the remote control. Adjusting the volume on the iPod, iPhone or iPad units give no effect.

iPod, iPhone and iPad operations:

The operations described below depend on the generation of iPod, iPhone and iPad you are using.

System on operation:

When the main unit is powered on, the iPod, iPhone or iPad units will automatically power on when docked or connected in the unit.

System off (stand-by operation):

When the main unit is turned to stand-by mode, the docked iPod, iPhone or connected iPad unit will automatically turn to stand-by mode.

Listening to the iPod, iPhone or iPad (continued)

To disconnect iPod, iPhone or iPad

Simply remove the iPod or iPhone from the docking station or iPad connector from USB terminal. It is safe to do so even during playback.

Caution:

- Stop button (■) at main unit is invalid during iPod function.

Various iPod, iPhone and iPad functions

Function	Main unit	Remote control		Operation
	Dock/USB	Dock	USB	
Play		iPod	USB	Press in the pause mode.
Pause				Press in the playback mode.
Track up/down				Press in the playback or pause mode. If you press the button in the playback mode, press the button to start the desired track.
Fast forward/reverse				Press and hold down in the playback mode. Release the button to resume playback.
Repeat	—	PLAY MODE		Press to toggle repeat mode.
Shuffle	—			Press and hold to toggle shuffle mode.
Menu	—	iPod		Press to view the iPod menu during iPod function.
Enter	—			Press to confirm the selection.
Cursor Up/Down	—		PRESET	Press to select the iPod menu.

Listening to a CD or MP3/WMA disc

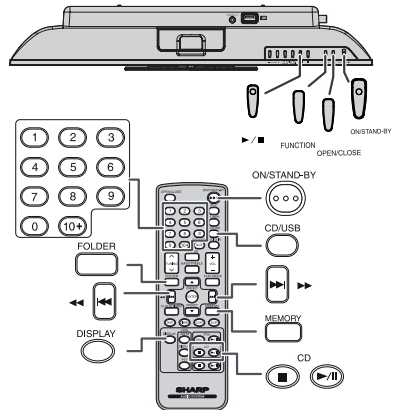

This system can play back a standard CD, CD-R/RW in the CD format and CD-R/RW with MP3 or WMA files, but cannot record on them. Some audio CD-R and CD-RW discs may not be playable due to the state of the disc or the device that was used for recording.

Disc playback

- 1 Press the ON/STAND-BY button to turn the power on.
- 2 Press the CD/USB button on the remote control or FUNCTION button repeatedly on the main unit to select CD function.
- 3 Press the OPEN/CLOSE button to open the disc compartment.
- 4 Place the disc in the disc compartment, label side front.

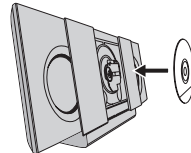

- 5 Press the OPEN/CLOSE button to close the disc compartment.
- 6 Press the (CD) button to start playback. After the last track is played, the unit will stop automatically.

Listening to a CD or MP3/WMA disc (continued)















Caution:

- Do not place two discs in the disc compartment.
- Do not play discs of special shapes (heart, octagon, etc). It may cause malfunctions.
- Do not push the disc compartment while it is moving.
- If the power fails while the compartment is open, wait until the power is restored.
- If TV or radio interference occurs during CD operation, move the unit away from the TV or radio.
- Be sure to place 8 cm (3") disc in the middle of the disc compartment.
- Due to the structure of the disc information, it takes longer to read an MP3/WMA disc than a normal CD (approximately 20 to 90 seconds).

Notes for CD or MP3/WMA disc:

- Rewritable multi-session discs with unfinished writing, can still be played.

■ Various disc functions

Function	Main unit	Remote control	Operation
Play 		CD 	Press in the stop mode.
Pause 			Press in the playback mode. Press the ▶/ button to resume playback from the paused point.
Stop 		CD 	Press in the playback mode.
Track up/down 			Press in the playback or stop mode. If you press the button in the stop mode, press the ▶/ button to start the desired track.
Fast forward/reverse 			Press and hold down in the playback mode. Release the button to resume playback.

Advanced CD or MP3/WMA disc playback

■ Direct track search

By using the Numeric buttons, the desired tracks on the current disc can be played.

Use the Numeric buttons on the remote control to select the desired track while playing the selected disc.

- The Numeric buttons allow you to select up to number 9.
- When selecting number 10 or higher, use the "10+" button.

A. For example, to choose 13

- 1 Press the "10+" button once.
- 2 Press the "1" button.
- 3 Press the "3" button.

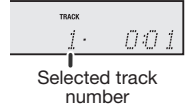

B. For example, to choose 130

- 1 Press the "10+" button twice.
- 2 Press the "1" button.
- 3 Press the "3" button.
- 4 Press the "0" button.

Notes:

- A track number higher than the number of tracks on the disc cannot be selected.
- During random play, direct search is not possible.

To stop playback:

- Press the **■** (CD **■**) button.

■ Repeat play

Repeat play can play one track, all tracks or a programmed sequence continuously.

To repeat one track:

Press the PLAY MODE button repeatedly until "Repeat One" appears. Press the **▶/||** (CD **▶/||**) button.

To repeat all tracks:

Press the PLAY MODE button repeatedly until "Repeat All" appears. Press the **▶/||** (CD **▶/||**) button.

To repeat desired tracks:

Perform steps 1 - 5 in "Programmed play" section on page 12 and then press the PLAY MODE button repeatedly until "Repeat All" appears.

To repeat one folder:

While in Folder mode on (MP3/WMA), press PLAY MODE button repeatedly until "Repeat Folder" appears. Press the **▶/||** (CD **▶/||**) button.

To cancel repeat play:

Press the PLAY MODE button repeatedly until "Normal" appears and **↺** disappears.



Caution:

After performing repeat play, be sure to press the **■** (CD **■**) button. Otherwise, the disc will play continuously.

Advanced CD or MP3/WMA disc playback (continued)

■ Random play

The tracks on the disc can be played in random order automatically.

To random play all tracks:

Press and hold the PLAY MODE button on the remote control until "Random" appears. Press the ►/II (CD ►/II) button.

To cancel random play:

Press the PLAY MODE button again. "RDM" indicator will disappear.



Notes:

- If you press the ►/II button during random play, you can move to the track selected next by the random operation. On the other hand, the ◀◀ button does not allow you to move to the previous track. The beginning of the track being played will be located.
- In random play, the unit will select and play tracks automatically. (You cannot select the order of the tracks.)

■ Programmed play (CD)

You can choose up to 32 selections for playback in the order you like.

- 1 While in the stop mode, press the MEMORY button on the remote control to enter the programming save mode.
- 2 Press the Numeric buttons or ◀◀ or ►► button on the remote control to select the desired track.



- 3 Press the MEMORY button to save the track number.
- 4 Repeat steps 2 - 3 for other tracks. Up to 32 tracks can be programmed. If you want to check the programmed tracks, press the MEMORY button repeatedly. If you make a mistake, the programmed tracks can be cleared by pressing the CLEAR button.
- 5 Press the ►/II (CD ►/II) button to start playback.

■ Programmed play (MP3/WMA)

- 1 While in the stop mode, press the MEMORY button to enter the programming save mode.
- 2 Press the PRESET (▼ or ▲) button on the remote control to select the desired folder.



Then press the ◀◀ or ►► button on the remote control to select the desired tracks.



- 3 Press the MEMORY button to save the folder and track number.
- 4 Repeat steps 2 - 3 for other folder/tracks. Up to 32 tracks can be programmed.
- 5 Press the ►/II (CD ►/II) button to start playback.

To cancel the programmed play mode:

During programmed stop mode, press the ■ (CD ■) button. The display will show "Memory Clear" and all the programmed contents will be cleared.

Adding tracks to the programme:

If a programme has been previously stored, the "MEM" indicator will be displayed. Press the MEMORY button. Then follow steps 2 - 3 to add tracks.

Notes:

- When the disc compartment is opened, the programme is automatically cancelled.
- If you press the ON/STAND-BY button to enter the stand-by mode or change the function from CD to another, the programmed selections will be cleared.
- During the programme operation, random play is not possible.

Advanced CD or MP3/WMA disc playback (continued)

■ Procedure to playback MP3/WMA disc with folder mode on

To play back CD-R/RW.

- 1 Press the CD/USB button on the remote control, and load an MP3/WMA disc. Press the FOLDER button and disc info will be displayed.

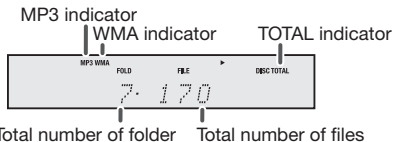

- 2 Press the PRESET (▼ or ▲) button to select desired playback folder. (Folder mode on)

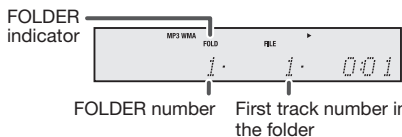

- 3 Select desired file to be played back by pressing the ◀◀ or ▶▶ button.
- 4 Press the ▶/|| (CD ▶/||) button. Playback will start and file name will be displayed.
 - Title, Artist and Album name are displayed if they are recorded on the disc.
 - In case of playback with the folder mode on, press the PRESET (▼ or ▲) button, and the folder can be selected even though it is in playback/pause mode. It will continue playback/pause mode in the 1st track of the selected folder.
 - Display content can be changed by pressing the DISPLAY button.

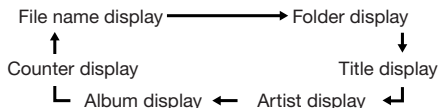

Note:

If "Not Support" is displayed, it means "Copyright protected WMA file" or "Not supported playback file" is selected.

Listening to USB mass storage device/MP3 player

Notes:

1. Remove the USB terminal cover before use. Keep it away from children as it may be swallowed.
2. Cover the USB terminal if it is not used for a long period of time to prevent dust or rust.

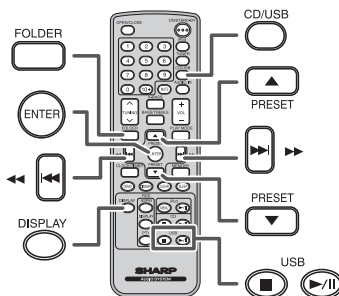
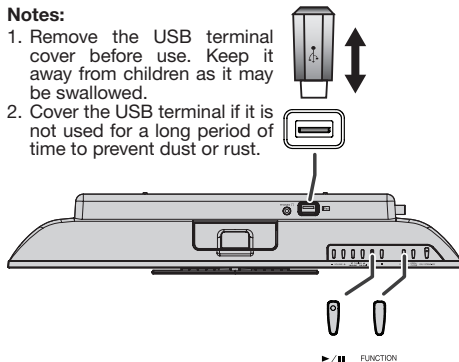

Note:

This product is not compatible with MTP and AAC file systems from USB mass storage device or MP3 player.

■ To play back USB/MP3 player with folder mode off

- 1 Press the CD/USB button on the remote control or FUNCTION button repeatedly on main unit to select USB function. Connect the USB memory device that has MP3/WMA format files on the unit. When the USB memory is connected to the main unit, the device information will be displayed.
- 2 Select desired file to be played back by pressing the ◀◀ or ▶▶ button.
- 3 Press the ▶/|| (USB ▶/||) button. Playback will start and the file name will be displayed.
 - Title, Artist and Album name are displayed if they are recorded in the USB memory device.
 - Display content can be changed by pressing the DISPLAY button.

Note:

To pause playback:

Press the ▶/|| (USB ▶/||) button.

Listening to USB mass storage device/MP3 player (continued)

■ To play back USB/MP3 player with folder mode on

- 1 Press the CD/USB button on the remote control or FUNCTION button repeatedly on main unit to select USB function. Connect the USB memory device that has MP3/WMA format files on the unit. When the USB memory is connected to the main unit, the device information will be displayed.
- 2 Press the FOLDER button, and press the PRESET (▼ or ▲) button to select desired playback folder. To start playback with folder mode on, go to step 4. To change the playback folder, press the PRESET (▼ or ▲) button to select another folder.
- 3 Select desired file to be played back by pressing the ◀◀ or ▶▶ button.
- 4 Press the ▶/⏏ (USB ▶/⏏) button. Playback will start and the file name will be displayed.
 - Title, Artist and Album name are displayed if they are recorded in the USB memory device.
 - Display content can be changed by pressing the DISPLAY button.

■ To remove USB memory device

- 1 Press the ■ (USB ■) button to stop playback.
- 2 Disconnect USB memory device from the USB terminal.

Notes:

- SHARP will not be held liable for the loss of data while the USB memory device is connected to the audio system.
- Files compressed in MP3 and/or WMA format can be played back when connected to the USB terminal.
- This USB memory's format supports FAT 16 or FAT 32.
- SHARP cannot guarantee that all USB memory devices will work on this audio system.
- USB cable is not recommended for use in this audio system to connect to USB memory device. Use of the USB cable will affect the performance of this audio system. iPod, iPhone and iPad is not prone to this condition.
- This USB memory cannot be operated via USB hub.
- The USB terminal in this unit is not intended for a PC connection but is used for music streaming with a USB memory device.
- External HDD-storage cannot be played back via USB terminal.
- If the data inside the USB memory is large, it may take longer time for the data to be read.
- This product can play WMA and MP3 files. It will automatically detect the file type being played. If unplayable file is played on this product, "Not Support" is indicated and the file will be automatically skipped. This will take a few seconds. If abnormal indications appear on the display due to the unspecified file, turn off the unit and then turn it on again.
- This product relates to USB mass storage devices and MP3 players. It may however face some irregularities due to various unforeseen reasons from some devices. Should this happen, turn off the unit and then turn it on again.
- During CD function, MP3 player will not be charging.

Advanced USB playback

The following functions are the same as CD operations:

	Page
Direct track search	11
Repeat play	11
Random play	12
Programmed play (MP3/WMA)	12

Notes:

If USB memory device is not connected, "USB No Media" will be shown on the display.

Notes:

- This unit only supports "MPEG-1 Audio Layer-3" format. (Sampling Frequency is 32, 44.1, 48kHz)
- Playback order for MP3 files may differ depending on the writing software used during file download.
- Bitrate which is supported by MP3 is 32~320 kbps, WMA is 64~160 kbps.
- For MP3/WMA files, please put ".MP3" ".WMA" extension. Files cannot be played back if there is no MP3/WMA extension.
- Playlists are not supported on this unit.
- This unit can display Folder Name or File Name up to 32 characters.
- Maximum total number of MP3/WMA files is 65025.
- Total number of folders read is 999 including folder with non-playable file. However, the display shows only folder with MP3 files.
- The display playback time may not be displayed correctly when playing back a variable bitrate file.
- The ID3TAG information supported are TITLE, ARTIST and ALBUM only. Title name, artist name and album name can be displayed by pressing the DISPLAY button during file playback or pause mode.
- WMA meta tag also supports title, artist and album name which are recorded in WMA files. Copyright protected WMA files cannot be played back.

Listening to the radio

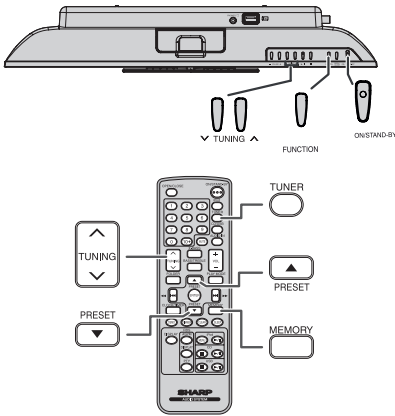

■ Tuning

- 1 Press the ON/STAND-BY button to turn the power on.
- 2 Press the FUNCTION button on the main unit or TUNER button on the remote control repeatedly to select FM Stereo, FM Mono or AM.
- 3 Press the TUNING (✓ or ⤵) button on main unit or remote control to tune in to the desired station.

● Manual tuning:

Press the TUNING (✓ or ⤵) button repeatedly to tune in to the desired station.

● Auto tuning:

When the TUNING (✓ or ⤵) button is pressed for more than 0.5 seconds, scanning will start automatically and the tuner will stop at the first receivable broadcast station.

Notes:

- When radio interference occurs, auto scan tuning may stop automatically at that point.
- Auto scan tuning will skip weak signal stations.
- To stop the auto tuning, press the TUNING (✓ or ⤵) button again.
- When an RDS (Radio Data System) station is tuned in, the frequency will be displayed first, and then the RDS indicator will light up. Finally, the station name will appear.
- Full auto tuning can be achieved for RDS stations "ASPM", see page 16.

To receive an FM stereo transmission:

- Press the TUNER button to select stereo mode and "ST" indicator will be displayed. "◀▶" and "•" will appear when an FM broadcast is in stereo.
- If the FM reception is weak, press the TUNER button to extinguish the "ST" indicator. The reception changes to monaural, and the sound becomes clearer.

■ Memorising a station

You can store 40 AM and FM stations in memory and recall them at the push of a button. (Preset tuning)

- 1 Perform steps 2 - 3 in "Tuning".
- 2 Press the MEMORY button.



- 3 Within 30 seconds, press the PRESET (✓ or ⤵) button to select the preset channel number. Store the stations in memory, in order, starting with preset channel 1.
- 4 Within 30 seconds, press the MEMORY button to store that station in memory. If the "MEMORY" and preset number indicators disappear before the station is memorised, repeat the operation from step 2.
- 5 Repeat steps 1 - 4 to set other stations, or to change a preset station. When a new station is stored in the memory, the station previously memorised for that preset channel number will be erased.

Note:

The backup function protects the memorised stations for a few hours should there be a power failure or the AC power lead becomes disconnected.

■ To recall a memorised station

Press the PRESET (✓ or ⤵) button for less than 0.5 seconds to select the desired station.

■ To scan the preset stations

The stations saved in the memory can be scanned automatically. (Preset memory scan)

- 1 Press the PRESET (✓ or ⤵) button for more than 0.5 seconds. The preset number will flash and the programmed stations will be tuned in sequentially, for 5 seconds each.
- 2 Press the PRESET (✓ or ⤵) button again when the desired station is located.

■ To erase entire preset memory

- 1 Press the FUNCTION button (main unit) repeatedly or TUNER button (remote control) to select Tuner function.
- 2 In Tuner function, press the CLEAR button until "Tuner Clear" appears.

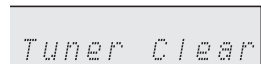

Using the Radio Data System (RDS)

RDS is a broadcasting service which a growing number of FM stations provide. These FM stations send additional signals along with their regular programme signals. They send their station names, and information about the type of programme such as sport, music, etc.

When tuned to an RDS station, "RDS" and the station name will be displayed.

"TP" (Traffic Programme) will appear on the display when the received broadcast carries traffic information, and "TA" (Traffic Announcement) will appear while a traffic information is on air.

"PTYI" (Dynamic PTY Indicator) will appear while the Dynamic PTY station is received.

RDS PTYI TP TA



You can control the RDS by using the buttons on the remote control only.

Information provided by RDS

Each time the RDS DISPLAY button is pressed, the display will switch as follows:

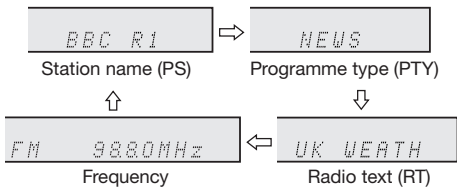
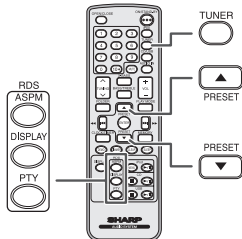

When tuning in to a station other than an RDS station or to an RDS station which sends weak signal, the display will change in the following order:

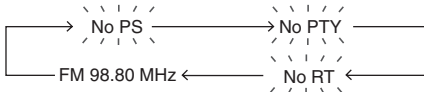

Using the Auto Station Programme Memory (ASPM)

While in the ASPM operation mode, the tuner will automatically search for new RDS stations. Up to 40 stations can be stored.

If you have already stored some stations in memory, the number of new stations you can store will be less.

1 Press the TUNER button on the remote control or FUNCTION button repeatedly on the main unit to select TUNER function.

2 Press and hold down the RDS ASPM button on the remote control.

1 After "ASPM" has flashed for about 4 seconds, scanning will start (87.50 - 108.00 MHz).

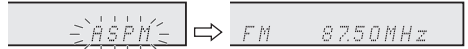

2 When an RDS station is found, "RDS" will appear for a short time and the station will be stored in memory.



3 After scanning, the number of stations stored in memory will be displayed for 4 seconds, and then "END" will appear for 4 seconds.



To stop the ASPM operation before it is complete:

Press the RDS ASPM button while it is scanning for stations. The stations which are already stored in memory will be kept there.

Notes:

- If the same station is broadcasting on different frequencies, the strongest frequency will be stored in memory.
- Any station which has the same frequency as the one stored in memory will not be stored.
- If 40 stations have already been stored in memory, the scan will be aborted. If you want to redo the ASPM operation, erase the preset memory.
- If no station has been stored in memory, "END" will appear for a short while.
- If the RDS signals are very weak, station names may not be stored in memory.
- The same station name can be stored in different channels.
- In a certain area or during certain time periods, the station names may temporarily be different.

Notes for RDS operation

If any of the following events occur, it does not mean that the unit is faulty:

- "PS", "No PS" and a station name appear alternately, and the unit does not operate properly.
- If a particular station is not broadcasting properly or a station is conducting tests, the RDS reception function may not work properly.
- When you receive an RDS station whose signal is too weak, information like the station name may not be displayed.
- "No PS", "No PTY" or "No RT" will flash for about 5 seconds, and then the frequency will be displayed.

Using the Radio Data System (RDS) (continued)

Notes for radio text:

- The first 14 characters of the radio text will appear for 4 seconds and then they will scroll across the display.
- If you tune in to an RDS station which is not broadcasting any radio text, "No RT" will be displayed when you switch to the radio text position.
- While radio text data is received or when the text contents change, "RT" will be displayed.

To recall stations in memory

To specify programmed types and select stations (PTY search):

You can search a station by specifying the programme type (news, sports, traffic programme, etc.) from the stations in memory.

- 1 Press the TUNER button on the remote control or FUNCTION button repeatedly on the main unit to select TUNER function.
- 2 Press the RDS PTY button on the remote control.



"SELECT" and "PTY TI" will appear alternately for about 6 seconds.

- 3 Within 6 seconds, press the TUNING (✓ or ^) button to select the programme type.



Each time the button is pressed, the programme type will appear.

- 4 While the selected programme type is flashing (within 6 seconds), press the RDS PTY button again.



After the selected programme type has been lit for 2 seconds, "SEARCH" will appear, and the search operation will start.

Notes:

- If the display has stopped flashing, start again from step 2. If the unit finds a desired programme type, the corresponding channel number will lit for about 8 seconds, and then the station name will remain lit.
- If you want to listen to the same programme type of another station, press the RDS PTY button while the channel number or station name is flashing. The unit will look for the next station.
- If no station can be found, "Not Found" will appear for a short while.

If you select the traffic programme:

If you select the traffic programme (TP) in step 3, "TP" will appear.

(This does not mean that you can listen to the traffic information at that time.)

When the traffic information is broadcast, "TA" will appear.

Descriptions of the PTY (Programme Type) codes, TP (Traffic Programme) and TA (Traffic Announcement)

You can search for and receive the following PTY, TP and TA signals.

NEWS	Short accounts of facts, events and publicly expressed views, reportage and actuality.
AFFAIRS	Topical programme expanding or enlarging upon the news, generally in different presentation style or concept, including debate, or analysis.
INFO	Programmes whose purpose is to impart advice in the widest sense.
SPORT	Programme concerned with any aspect of sport.
EDUCATE	Programme intended primarily to educate, of which the formal element is fundamental.
DRAMA	All radio plays and serials.
CULTURE	Programmes concerned with any aspect of national or regional culture, including language, theatre, etc.
SCIENCE	Programmes about the natural sciences and technology.
VARIED	Used for mainly speech-based programmes usually of light-entertainment nature, not covered by other categories. Examples include: quizzes, panel games, personality interviews.
POP M	Commercial music, which would generally be considered to be of current popular appeal, often featuring in current or recent record sales charts.
ROCK M	Contemporary modern music, usually written and performed by young musicians.
EASY M	Current contemporary music considered to be "easy-listening", as opposed to Pop, Rock or Classical, or one of the specialised music styles, Jazz, Folk or Country. Music in this category is often but not always, vocal, and usually of short duration.
LIGHT M	Classical music for general, rather than specialist appreciation. Examples of music in this category are instrumental music, and vocal or choral works.
CLASSICS	Performances of major orchestral works, symphonies, chamber music, etc., and including Grand Opera.
OTHER M	Musical styles not fitting into any of the other categories. Particularly used for specialist music of which Rhythm & Blues and Reggae are examples.
WEATHER	Weather reports and forecasts and meteorological information.
FINANCE	Stock Market reports, commerce, trading, etc.
CHILDREN	For programmes targeted at a young audience, primarily for entertainment and interest, rather than where the objective is to educate.

Using the Radio Data System (RDS) (continued)

SOCIAL	Programmes about people and things that influence them individually or in groups. Includes: sociology, history, geography, psychology and society.
RELIGION	Any aspect of beliefs and faiths, involving a God or Gods, the nature of existence and ethics.
PHONE IN	Involving members of the public expressing their views either by phone or at a public forum.
TRAVEL	Features and programmes concerned with travel to near and far destinations, package tours and travel ideas and opportunities. Not for use for announcements about problems, delays, or roadworks affecting immediate travel where TP/TA should be used.
LEISURE	Programmes concerned with recreational activities in which the listener might participate. Examples include, Gardening, Fishing, Antique collecting, Cooking, Food & Wine, etc.
JAZZ	Polyphonic, syncopated music characterised by improvisation.
COUNTRY	Songs which originate from, or continue the musical tradition of the American Southern States. Characterised by a straightforward melody and narrative story line.
NATION M	Current Popular Music of the Nation or Region in that country's language, as opposed to International "Pop" which is usually US or UK inspired and in English.
OLDIES	Music from the so-called "golden age" of popular music.
FOLK M	Music which has its roots in the musical culture of a particular nation, usually played on acoustic instruments. The narrative or story may be based on historical events or people.
DOCUMENT	Programme concerned with factual matters, presented in an investigative style.
TEST	Broadcast when testing emergency broadcast equipment or receivers.
ALARM	Emergency announcement made under exceptional circumstances to give warning of events causing danger of a general nature.
NONE	No programme type (receive only).
TP	Broadcasts which carry traffic announcements.
TA	Traffic announcements are being broadcast.

Setting the clock (Remote control only)

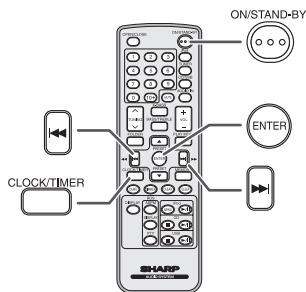

In this example, the clock is set for the 24-hour (0:00) display.

- 1 Press the ON/STAND-BY button to turn the power on.
- 2 Press the CLOCK/TIMER button.
- 3 Within 10 seconds, press the ENTER button. To adjust the day, press the ◀◀ or ▶▶ button and then press the ENTER button.
- 4 Press the ◀◀ or ▶▶ button to select 24-hour or 12-hour display and then press the ENTER button.

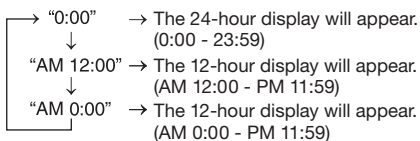

- 5 To adjust the hour, press the ◀◀ or ▶▶ button and then press the ENTER button. Press the ◀◀ or ▶▶ button once to advance the time by 1 hour. Hold it down to advance continuously.
- 6 To adjust the minutes, press the ◀◀ or ▶▶ button and then press the ENTER button. Press the ◀◀ or ▶▶ button once to advance the time by 1 minute. Hold it down to advance continuously.

To confirm the time display:

Press the CLOCK/TIMER button. The time display will appear for about 5 seconds.

Note:

When power supply is restored after unit is plugged in again or after a power failure time display will be blinking. Reset the clock.

To readjust the clock:

Perform "Setting the clock" from step 1.

Timer and sleep operation (Remote control only)

Timer playback:

The unit turns on and plays the desired source (CD, TUNER, USB, iPod, AUDIO IN) at a preset time.

This unit has 2 types of timer: **ONCE TIMER** and **DAILY TIMER**.

Once timer ("Ⓞ" indicator):

Once timer play works for one time only at a preset time.

Daily timer ("DAILY" indicator):

Daily timer play works at the same preset time every day that we set. For example, set the timer as a wake-up call every morning.

Using the once timer and daily timer in combination:

For example, use the once timer to listen a radio programme, and use the daily timer to wake up.

- 1 Set the daily timer.
- 2 Set the once timer.

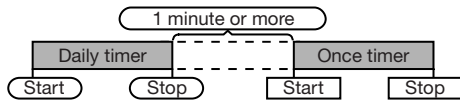

■ Timer playback

Before setting timer:

- Check that the clock is set to the correct time (refer to page 18). If it is not set, you cannot use the timer function.
- For timer playback: Plug in USB or load discs or dock iPod to be played.



- 1 Press the ON/STAND-BY button to turn the power on.
- 2 Press and hold the CLOCK/TIMER button.
- 3 Within 10 seconds, press the ◀▶ button to select "Once" or "Daily", and press the ENTER button.
- 4 Within 10 seconds, press the ◀▶ button to select "Timer Set", and press the ENTER button.
- 5 To select the timer playback source (CD, TUNER, USB, iPod, AUDIO IN), press the ◀▶ button. Press the ENTER button.

When you select the tuner, select a station by pressing the ◀▶ button, and then press the ENTER button. If a station has not been programmed, "No Preset" will be displayed and timer setting will be cancelled.

- 6 To adjust the day, press the ◀▶ button and then press the ENTER button.
- 7 Press the ENTER button to adjust the hour. Press the ◀▶ button and then press the ENTER button.
- 8 To adjust the minutes, press the ◀▶ button and then press the ENTER button.
- 9 Set the time to finish as in steps 7 and 8 above.
- 10 Adjust the volume using the VOLUME (+ or -) on the main unit or VOL +/- on the remote control, and then press the ENTER button. Do not turn the volume up too high.
- 11 Press the ON/STAND-BY button to enter the power stand-by mode. The "TIMER" indicator lights up and the unit is ready for timer playback.

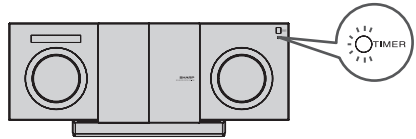

- 12 When the preset time is reached, playback will start. The volume will increase gradually until it reaches the preset volume. The timer indicator will blink during timer playback. When the timer end time is reached, the system will enter the power stand-by mode automatically.

Once timer:

The timer will be cancelled.

Daily timer:

The timer operates at the same time every selected day. It will continue until the daily timer setting is cancelled. Cancel the daily timer when it is not in use.

Notes:

- When performing timer playback using another unit connected to the USB terminal or AUDIO IN socket, select "USB" or "AUDIO IN" in step 5.
- This unit will turn on or enter the power stand-by mode automatically. However, the connected unit will not turn on or off. To stop the timer playback, follow step "Cancelling the timer setting" of this page.

Checking the timer setting:

- 1 Turn the power on and press and hold down the CLOCK/TIMER button.
- 2 Within 10 seconds, press the ◀▶ button to select "Once" or "Daily", and press the ENTER button.
- 3 Within 10 seconds, press the ◀▶ button to select "Timer Call", and press the ENTER button.

Cancelling the timer setting:

- 1 Turn the power on and press and hold down the CLOCK/TIMER button.
- 2 Within 10 seconds, press the ◀▶ button to select "Once" or "Daily", and press the ENTER button.
- 3 Within 10 seconds, press the ◀▶ button to select "Timer Off", and press the ENTER button. Timer will be cancelled (the setting will not be cancelled).

Reusing the memorised timer setting:

The timer setting will be memorised once it is entered. To reuse the same setting, perform the following operations.

- 1 Turn the power on and press and hold down the CLOCK/TIMER button.
- 2 Within 10 seconds, press the ◀▶ button to select "Once" or "Daily", and press the ENTER button.
- 3 Within 10 seconds, press the ◀▶ button to select "Timer On", and press the ENTER button.
- 4 Press the ON/STAND-BY button to enter the power stand-by mode.

Timer and sleep operation (Remote control only) (continued)

■ Sleep operation

The radio, compact disc, iPod, USB, Audio In can all be turned off automatically.

- 1 Play back the desired sound source.
- 2 Press the SLEEP button.
- 3 Within 5 seconds, press the Numeric buttons to set the time. (1 minute ~ 99 minutes)
- 4 "SLEEP" will appear.
- 5 The unit will enter the power stand-by mode automatically after the preset time has elapsed. The volume will be turned down 1 minute before the sleep operation finishes.

To confirm the remaining sleep time:

While "SLEEP" is indicated, press the SLEEP button.

To cancel the sleep operation:

Press the ON/STAND-BY button while "SLEEP" is indicated. To cancel the sleep operation without setting the unit to the stand-by mode, proceed as follows.

- 1 While "SLEEP" is indicated, press the SLEEP button.
- 2 Within 5 seconds, press the "0" button twice until "SLEEP 00" appears.

■ To use timer and sleep operation together

Sleep and timer playback:

For example, you can fall asleep listening to the radio and wake up to CD in the next morning.

- 1 Set the sleep time (see above, steps 1 - 5).
- 2 While the sleep timer is set, set the timer playback (steps 2 - 9, page 19).

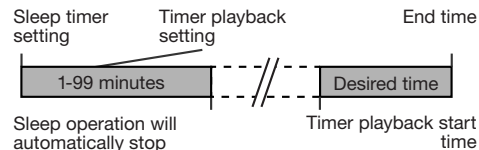

Enhancing your system

The connection lead is not included. Purchase a commercially available lead as shown below.

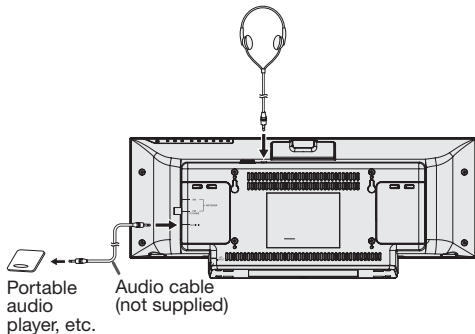

■ Listening to the playback sounds of portable audio player, etc.

- 1 Use a connection lead to connect the portable audio player etc. to the AUDIO IN socket. When using video equipment, connect the audio output to this unit and the video output to a television.
- 2 Press the ON/STAND-BY button to turn the power on.
- 3 Press the AUDIO IN button on the remote control or FUNCTION button repeatedly on main unit to select AUDIO IN function.
- 4 Play the connected equipment. If volume level of the connected device is too high, sound distortion may occur. Should this happen, lower the volume of the connected device. If volume level is too low, increase the volume of the connected device.

Note:

To prevent noise interference, place the unit away from the television.

■ Headphones

- Do not turn the volume on to full at switch on and listen to music at moderate levels. Excessive sound pressure from earphones and headphones can cause hearing loss.
- Be sure your headphone has a 3.5 mm (1/8") diameter plug and impedance between 16 and 50 ohms. The recommended impedance is 32 ohms.
- Before plugging in or unplugging the headphone, reduce the volume.
- Plugging in the headphone disconnects the speakers automatically. Adjust the volume using the VOLUME (+ or -) on the main unit or VOL +/- on the remote control.

Troubleshooting chart

Many potential problems can be resolved by the owner without calling a service technician.

If something is wrong with this product, check the following before calling your authorised SHARP dealer or service centre.

■ General

Symptom	Possible cause
● The clock is not set to the correct time.	● Did a power failure occur? ● Reset the clock. (Refer page 18)
● When a button is pressed, the unit does not respond.	● Set the unit to the power stand-by mode and then turn it back on. ● If the unit still malfunctions, reset it. (Refer page 21)
● No sound is heard.	● Is the volume level set to "Min"? ● Are the headphones connected?

Troubleshooting chart (continued)

■ CD player

Symptom	Possible cause
<ul style="list-style-type: none"> ● Playback does not start. ● Playback stops in the middle or is not performed properly. 	<ul style="list-style-type: none"> ● Is the disc loaded face down? ● Does the disc satisfy the standards? ● Is the disc distorted or scratched?
<ul style="list-style-type: none"> ● Playback sounds are skipped, or stopped in the middle of a track. 	<ul style="list-style-type: none"> ● Is the unit located near excessive vibrations? ● Is the disc very dirty? ● Has condensation formed inside the unit?

■ Remote control

Symptom	Possible cause
<ul style="list-style-type: none"> ● The remote control does not operate. 	<ul style="list-style-type: none"> ● Is the AC power lead of the unit plugged in? ● Is the battery polarity correct? ● Is the battery dead? ● Is the distance or angle incorrect? ● Does the remote control sensor receive strong light?

■ Tuner

Symptom	Possible cause
<ul style="list-style-type: none"> ● The radio makes unusual noises continuously. 	<ul style="list-style-type: none"> ● Is the unit placed near the TV or computer? ● Is the FM aerial or AM loop aerial placed properly? Move the aerial away from the AC power lead if it is located nearby.

■ iPod, iPhone or iPad

Symptom	Possible cause
<ul style="list-style-type: none"> ● No sound is produced. 	<ul style="list-style-type: none"> ● The iPod, iPhone or iPad is not playing. ● The iPod, iPhone or iPad is not properly connected to the unit. ● Is the AC power lead of the unit plugged in?
<ul style="list-style-type: none"> ● iPod, iPhone or iPad will not charge. 	<ul style="list-style-type: none"> ● The iPod, iPhone or iPad is not making full contact with the connector. ● Using iPod (3rd generation). ● The iPod or iPhone is not supported. Refer to page 8 for compatible models.
<ul style="list-style-type: none"> ● "This accessory is not made to work with iPhone" or "This accessory is not supported by iPhone" appears on iPhone screen. 	<ul style="list-style-type: none"> ● The iPhone battery is low. Please charge the iPhone. ● iPhone is not properly docked.

■ USB

Symptom	Possible cause
<ul style="list-style-type: none"> ● Device cannot be detected. 	<ul style="list-style-type: none"> ● Is there any MP3/WMA file available? ● Is the device properly connected? ● Is it an MTP device? ● Does the device contain AAC file only?
<ul style="list-style-type: none"> ● Playback does not start. 	<ul style="list-style-type: none"> ● Is it a copyright protected WMA file? ● Is it a false MP3 file?
<ul style="list-style-type: none"> ● Wrong time display. ● Wrong file name display. 	<ul style="list-style-type: none"> ● Is Variable Bitrate file being played back? ● Is the File Name written in Chinese or Japanese characters?

■ Condensation

Sudden temperature changes, storage or operation in an extremely humid environment may cause condensation inside the cabinet (CD pickup, etc.) or on the transmitter in the remote control. Condensation can cause the unit to malfunction. If this happens, leave the power on with no disc in the unit until normal playback is possible (about 1 hour). Wipe off any condensation on the transmitter with a soft cloth before operating the unit.

■ If problem occurs

When this product is subjected to strong external interference (mechanical shock, excessive static electricity, abnormal supply voltage due to lightning, etc.) or if it is operated incorrectly, it may malfunction.

If such a problem occurs, do the following:

- 1 Set the unit to the stand-by mode and turn the power on again.
- 2 If the unit is not restored in the previous operation, unplug and plug in the unit again, and then turn the power on.

Note:

If neither operation above restores the unit, clear all the memory by resetting it.

■ Factory reset, clearing all memory

- 1 Press FUNCTION button (main unit) repeatedly or AUDIO IN button (remote control) to enter Audio In mode.
- 2 Press ◀◀ button (main unit) once.
- 3 Press and hold ■ button (main unit) until "RESET" appears.



Caution:

This operation will erase all data stored in memory including clock, timer settings and tuner preset.

■ Before transporting the unit

Remove the iPod, iPhone, iPad, USB memory device and disc from the unit. Then, set the unit to the power stand-by mode. Carrying the unit with iPod, iPhone, iPad or USB memory device left connected or discs left inside might damage the unit.

Troubleshooting chart (continued)

Care of compact discs

Compact discs are fairly resistant to damage, however mistracking can occur due to an accumulation of dirt on the disc surface. Follow the guidelines below for maximum enjoyment from your CD collection and player.

- Do not write on either side of the disc, particularly the non-label side from which signals are read. Do not mark this surface.
- Keep your discs away from direct sunlight, heat, and excessive moisture.
- Always hold the CDs by the edges. Fingerprints, dirt, or water on the CDs can cause noise or mistracking. If a CD is dirty or does not play properly, clean it with a soft, dry cloth, wiping straight out from the centre, along the radius.

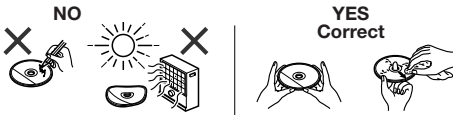

Maintenance

Cleaning the cabinet

Periodically wipe the cabinet with a soft cloth and a diluted soap solution, then with a dry cloth.

Caution:

- Do not use chemicals for cleaning (petrol, paint thinner, etc.). It may damage the cabinet.
- Do not apply oil to the inside of the unit. It may cause malfunctions.

Cleaning the CD pickup lens

Poor performance during CD playback (skipping or jumping) can be caused by a dirty or contaminated CD laser pick up lens. If this happens then the use of a commercially available CD lens cleaning disc may restore normal operation. Contact your supplier or local CD software dealer to obtain CD lens cleaning discs. Ensure all included instructions/documentation are carefully followed.

Specifications

As part of our policy of continuous improvement, SHARP reserves the right to make design and specification changes for product improvement without prior notice. The performance specification figures indicated are nominal values of production units. There may be some deviations from these values in individual units.

General

Power source	AC 220 - 240 V ~ 50/60 Hz
Power consumption	Power on: 24 W Power stand-by: 0.4 W (*)
Speaker	1-way speaker system Speaker: 10 cm (4") - 6 ohms - Full Range
Speaker maximum input power	50 W/channel
Speaker rated input power	25 W/channel

Dimensions	Width: 475 mm (18 - 11/16") Height: 191 mm (7 - 1/2") Depth: 83 mm (3 - 1/4")
Weight	2.45 kg (5.4 lbs.)

(*) This power consumption value is obtained when the demonstration mode is cancelled in the power stand-by mode. Refer to page 5 to cancel the demonstration mode.

Amplifier

Output power	MPO: 50 W (25 W + 25 W) (10% T.H.D.) RMS: 50 W (25 W + 25 W) (10% T.H.D.) RMS: 40 W (20 W + 20 W) (1% T.H.D.)
Output terminals	Headphones: 16 ohms (recommended: 32 ohms)
Input terminals	Audio In (audio signal): 500 mV/47 k ohms

CD player

Type	Single disc multi-play compact disc player
Signal readout	Non-contact, 3-beam semiconductor laser pickup
D/A converter	Multi bit D/A converter
Frequency response	20 - 20,000 Hz
Dynamic range	90 dB (1 kHz)

USB (MP3 / WMA)

USB host interface	Complies with USB 1.1 (Full Speed)/2.0 Mass Storage Class. Support Bulk only and CBI protocol.
Support file	MPEG 1 Layer 3 WMA (Non DRM)
Bitrate support	MP3 (32 ~ 320 kbps) WMA (64 ~ 160 kbps)
Other	Maximum total number of MP3/WMA files is 65025. Maximum total number of folders is 999 INCLUSIVE of root directory. The ID3TAG information supported are TITLE, ARTIST and ALBUM only. Supports ID3TAG version 1 and version 2.
File system support	Support USB devices with Microsoft Windows/DOS/FAT 12/FAT 16/ FAT 32. 2 kbyte block length for sector.

Tuner

Frequency range	FM: 87.5 - 108 MHz AM: 522 - 1,620 kHz
Preset	40 (FM and AM station)

SHARP

FOR LOCATION ENQUIRIES WITHIN

AUSTRALIA

REGARDING YOUR LOCAL

SHARP APPROVED SERVICE CENTRE

VISIT OUR WEBSITE AT

www.sharp.net.au

OR CALL SHARP CUSTOMER CARE

1300 135 022

(LOCAL CALL COSTS APPLY WITHIN AUSTRALIA)

SHARP CORPORATION OF AUSTRALIA PTY LTD

SHARP

FOR LOCATION ENQUIRIES WITHIN

NEW ZEALAND

REGARDING YOUR LOCAL

SHARP APPROVED SERVICE CENTRE

VISIT OUR WEBSITE AT

www.sharp.net.nz

CONTACT YOUR SELLING DEALER/RETAILER

OR CALL

SHARP CUSTOMER SERVICES

TELEPHONE: 09 573 0111

FACSIMILE: 09 573 0113

SHARP CORPORATION OF NEW ZEALAND LIMITED

SHARP

WARRANTY

Consumer Electronic Products

Congratulations on Your Purchase!

This Sharp product is warranted against faults in material and manufacture for the period as stated in the table below.

If service is required during the warranty period, please contact your nearest Sharp Approved Service Centre. These repairs would be carried out at no charge to the owner, subject to the conditions specified herein.

This warranty does not extend to defects or injuries caused by or resulting from causes not attributable to faulty parts or the manufacture of the product, including but not limited to, defect or injury caused by or resulting from misuse, abuse, neglect, lack of maintenance, accidental damage, improper voltage, liquid spillage, vermin infestation, software, or any alterations made to the product which are not authorised by Sharp.

Please retain your sales documentation, as this should be produced to validate a warranty claim. This warranty is in addition to and in no way limits, varies or excludes any implied rights and remedies under any relevant legislation in the country of sale.

This warranty does not cover transportation to and from the Sharp Approved Service Centre. Goods presented for repair may be replaced by refurbished goods of the same type rather than being repaired. Refurbished parts may be used to repair the goods. The repair of your goods may result in the loss of user generated data, please ensure that you have saved this data elsewhere prior to repair.

Australian customers: Our goods come with guarantees that cannot be excluded under the Australian Consumer Law. You are entitled to a replacement or refund for a major failure and for compensation for any other reasonably foreseeable loss or damage. You are also entitled to have the goods repaired or replaced if the goods fail to be of acceptable quality and the failure does not amount to a major failure. The criteria of a major failure is defined in the Australian Consumer Law. Should you require any assistance with a major failure please contact Sharp Customer Care.

WARRANTY PERIODS

Home Theatre Projector	12 months (excluding lamps and air filters)
Audio/Home Theatre	12 months
Microwave Oven	12 months
Steam Oven	12 months
Refrigerator	24 months
DVD/Blu-ray	12 months
Air Conditioner	60 months
Portable Air Conditioner	12 months
LCD Television	12 months
Air Purifier	12 months
Vacuum Cleaner	24 months



SHARP
SHARP CORPORATION OF AUSTRALIA PTY. LIMITED
ABN 40 003 639 405
1 Huntingwood Drive
Huntingwood NSW 2148
SHARP CORPORATION OF NEW ZEALAND LIMITED
89 Huggo Johnson Drive
Penrose, Auckland

SPForm 040 (JUNE 2012)

IMPORTANT NOTICE: This warranty applies only to products sold in Australia & New Zealand

If you require any advice or assistance regarding your Sharp product, please visit our web-site www.sharp.co.uk/customersupport.aspx Customers without Internet access may telephone 0845 880 0512 during office hours (or (01) 676 0648 if telephoning from Ireland).

NOTES FOR USERS IN THE U.K. AND IRELAND

The mains lead of this product is fitted with a non-rewireable (moulded) plug incorporating a 10A fuse. Should the fuse need to be replaced, a BSI or ASTA approved BS 1362 fuse marked  or  and of the same rating as above, which is also indicated on the pin face of the plug must be used.

Always refit the fuse cover after replacing the fuse. Never use the plug without the fuse cover fitted.

In the unlikely event of the socket outlet in your home not being compatible with the plug supplied, cut-off the mains plug and fit an appropriate type.

DANGER:

The fuse from the cut-off plug should be removed and the cut-off plug destroyed immediately and disposed of in a safe manner.

Under no circumstances should the cut-off plug be inserted elsewhere into a 13A socket outlet as a serious electric shock may occur.

To fit an appropriate plug to the mains lead, follow the instructions below:

IMPORTANT:

The wires in the mains lead are coloured in accordance with the following code:

Blue : Neutral
Brown : Live

As the colours of the wires in the mains lead of this product may not correspond with the coloured markings identifying the terminals in your plug, proceed as follows:

- The wire which is coloured blue must be connected to the plug terminal which is marked N or coloured black.
- The wire which is coloured brown must be connected to the plug terminal which is marked L or coloured red.

Ensure that neither the brown nor the blue wire is connected to the earth terminal in your three pin plug.

Before replacing the plug cover, make sure that:

- If the new fitted plug contains a fuse, its value is the same as that removed from the cut-off plug.
- The cord grip is clamped over the sheath of the mains lead and not simply over the lead wires.

IF YOU HAVE ANY DOUBT, CONSULT A QUALIFIED ELECTRICIAN.

SERVICE INFORMATION

In the unlikely event of your equipment requiring repair, please contact the dealer or supplier from whom it was purchased. Where this is not possible, please visit our web-site www.sharp.co.uk/customersupport.aspx Customers without internet access may telephone 0845 880 0512 during office hours (or (01) 676 0648 if telephoning from Ireland).

Please note; all calls will be charged at local rate.

Certain replacement parts and accessories may be obtained from our main parts distributor.

WILLOW VALE ELECTRONICS LTD.
0121 766 5414

In the unlikely event of this equipment requiring repair during the guarantee period, you will need to provide proof of the date of purchase to the repairing company.

Please keep your invoice or receipt, which is supplied at the time of purchase.

Information on Proper Disposal



Attention: Your product is marked with this symbol. It means that used electrical and electronic products should not be mixed with general household waste. There is a separate collection system for these products.

A. Information on Disposal for Users (private households)

1. In the European Union

Attention: If you want to dispose of this equipment, please do not use the ordinary dustbin! Used electrical and electronic equipment must be treated separately and in accordance with legislation that requires proper treatment, recovery and recycling of used electrical and electronic equipment.

Following the implementation by member states, private households within the EU states may return their used electrical and electronic equipment to designated collection facilities free of charge*.

In some countries* your local retailer may also take back your old product free of charge if you purchase a similar new one.

*) Please contact your local authority for further details.

If your used electrical or electronic equipment has batteries or accumulators, please dispose of these separately beforehand according to local requirements.

By disposing of this product correctly you will help ensure that the waste undergoes the necessary treatment, recovery and recycling and thus prevent potential negative effects on the environment and human health which could otherwise arise due to inappropriate waste handling.

2. In other Countries outside the EU

If you wish to discard this product, please contact your local authorities and ask for the correct method of disposal.

For Switzerland: Used electrical or electronic equipment can be returned free of charge to the dealer, even if you don't purchase a new product. Further collection facilities are listed on the homepage of www.swico.ch or www.sens.ch.

B. Information on Disposal for Business Users

1. In the European Union

If the product is used for business purposes and you want to discard it:

Please contact your SHARP dealer who will inform you about the take-back of the product. You might be charged for the costs arising from take-back and recycling. Small products (and small amounts) might be taken back by your local collection facilities.

For Spain: Please contact the established collection system or your local authority for take-back of your used products.

2. In other Countries outside the EU

If you wish to discard of this product, please contact your local authorities and ask for the correct method of disposal.

Information on Battery Disposal

The battery supplied with this product contains traces of Lead.

For EU: The crossed-out wheeled bin implies that used batteries should not be put to the general household waste! There is a separate collection system for used batteries, to allow proper treatment and recycling in accordance with legislation. Please contact your local authority for details on the collection and recycling schemes.

For Switzerland: The used battery is to be returned to the selling point.

For other non-EU countries: Please contact your local authority for correct method of disposal of the used battery.



Pb

TERMS OF GUARANTEE

Sharp Electronics (UK) Ltd. ("Sharp") guarantees to provide for the repair, or at its option the replacement, of this product subject to the conditions listed below:-

1. This guarantee shall only apply to faults which are due to inferior workmanship or materials. It does not cover faults or damage caused by accident, misuse, fair wear and tear, neglect, tampering with the product, or repair other than by a Service Facility appointed by Sharp.
2. As this product is intended for private domestic use only, the guarantee will not apply if the product is used in the course of a business, trade or profession.
3. To benefit from this guarantee, any fault which occurs must be notified to Sharp, or its appointed Service Facility within one year from the date this product was purchased. Proof of purchase must be provided.
4. The guarantee does not cover carriage costs, audio tapes, compact discs or batteries.
5. In the unlikely event of this product requiring repair, please contact the supplier from whom it was purchased. Where this is not possible, please contact the Sharp Customer Information Centre on the telephone number given below.
6. No person has any authority to vary the terms or conditions of this guarantee.
7. This guarantee is offered as an additional benefit to your statutory rights, and does not affect these rights in any way.

If you have any difficulty operating this product, or would like information on other Sharp products, please telephone the Sharp Customer Information Centre on the number given below.

Sharp Customer Information Centre - Telephone 0845 880 0512
(or (01) 676 0648 if telephoning from Ireland)

Customer support website address - www.sharp.co.uk/customersupport.aspx

SHARP

SHARP ELECTRONICS (U.K) LTD.

4 Furzeground Way, Stockley Park, Uxbridge, Middlesex, UB11 1EZ.

SHARP CORPORATION

Free Manuals Download Website

<http://myh66.com>

<http://usermanuals.us>

<http://www.somanuals.com>

<http://www.4manuals.cc>

<http://www.manual-lib.com>

<http://www.404manual.com>

<http://www.luxmanual.com>

<http://aubethermostatmanual.com>

Golf course search by state

<http://golfingnear.com>

Email search by domain

<http://emailbydomain.com>

Auto manuals search

<http://auto.somanuals.com>

TV manuals search

<http://tv.somanuals.com>