

Quick Guide

DVD Recorder DVR95DF

Playable discs

This unit is compatible to play the following discs.

Disc	Logo	Disc	Logo
DVD-VIDEO		CD-DA (AUDIO CD)	
DVD-RW (VIDEO/VR mode)		CD-RW (CD-DA FORMAT, MP3 files)	
DVD-R (VIDEO mode)		CD-R (CD-DA FORMAT, MP3 files)	

is a trademark of DVD Format/Logo Licensing Corporation.

• DVD+R/+RW discs are supported for playback only. *Some DVD+R/+RW discs are not compatible with this unit.

Region codes



The number inside the globe refers to region of the world. This unit can play DVDs that are labeled for ALL regions or for Region 1.

Recordable discs

This unit can record on DVD-R and DVD-RW discs.

DVD-R discs allow you to record programs only once. DVD-RW discs allow you to record programs repeatedly, and the recorded contents can be erased.

You can record programs on DVD-R discs only in Video mode, while recording format for DVD-RW discs can choose either Video mode or VR mode.

Disc type	Disc format	Functions	Attributes
 DVD-RW: 1-4x	Video mode 	Playing, limited recording, limited editing	8cm/12cm, single-sided, single layer disc Approx. max. recording time (SEP mode): 600 minutes (4.7GB) (for 12cm) 180 minutes (1.4GB) (for 8cm)
	VR mode 	Playing, recording, Original/Playlist editing	
 DVD-R: 1-16x	Video mode 	Playing, limited recording, limited editing	8cm/12cm, single-sided, single layer disc Approx. max. recording time (SEP mode): 600 minutes (4.7GB) (for 12cm) 180 minutes (1.4GB) (for 8cm)

1

Connections

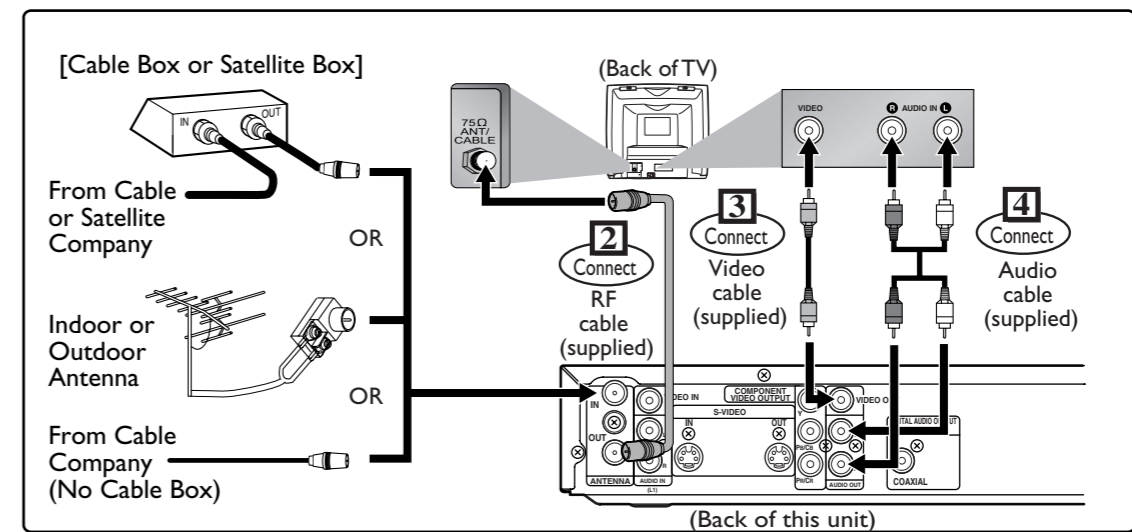

- Both A/V and RF cables must be connected to the TV for operation.
- See front page of the Owner's Manual for the connection with the RF modulator.

2

Watching TV

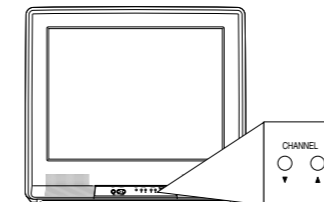

(Example of a TV)

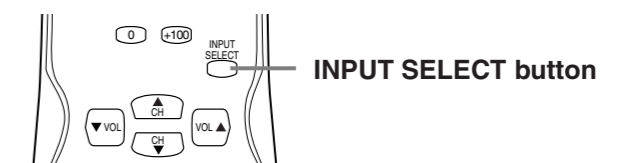

(Example of a TV remote control)

1. Switch the input selector on your TV to an appropriate external input channel (usually near channel 0).
2. Hit a button on the TV's original remote control (see the table below) to select an external input channel until the DVD recorder's picture appears.

Input Mode Names for Common TV Brands (Example)

Admiral	AUX	LXI-Series	00	Sharp	00
Curtis Mathis	LINE1, LINE2, 00, 90, 91, 92, 93	Magnavox	AUX CHANNEL	Sony	VIDEO1, VIDEO2, VIDEO3
GE	INPUT, TV/VCR, 00, 90, 91, 92, 93	Panasonic	TV/VIDEO	Toshiba	TV/GAME
Hitachi	INPUT, AUX	RCA	INPUT, TV/VCR, 00, 90, 91, 92, 93	Zenith	00
JVC	A/V CHANNEL, INPUT1, SVIDEO, INPUT2	Samsung	TV/VIDEO		
Kenwood	AUX	Sanyo	VIDEO		

Hit [SETUP].

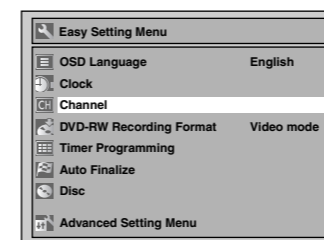

Using [▲/▼], select "Channel" from the Menu.

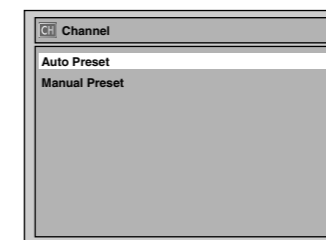

Select "Auto Preset" and the unit will start getting available channels in your area.

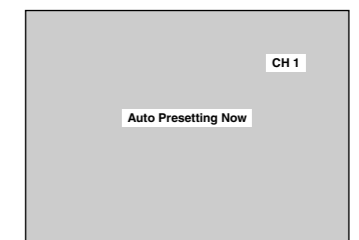

Follow to the back side of this sheet.

3

DVD Recording

3-1 Easy Recording

Select the recording speed

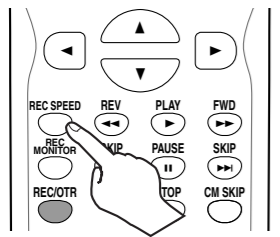

How to select the recording speed:

Disc Size	Recording speed	Recording time *	Video/Sound Quality
8cm Disc	XP (1H)	18 min	☆☆☆☆☆ (good)
	SP (2H)	36 min	☆☆☆☆
	LP (4H)	72 min	☆☆☆
	EP (6H)	108 min	☆☆
	SLP (8H)	144 min	☆☆
12 cm Disc	SEP (10H)	180 min	☆ (poor)
	XP (1H)	60 min	☆☆☆☆☆ (good)
	SP (2H)	120 min	☆☆☆☆
	LP (4H)	240 min	☆☆☆
	EP (6H)	360 min	☆☆
SLP (8H)	480 min	☆☆	
SEP (10H)	600 min	☆ (poor)	

Select the desired TV channel

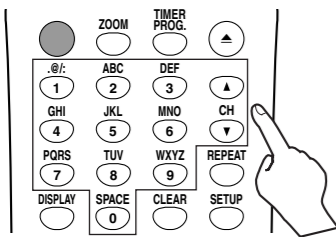

Record!

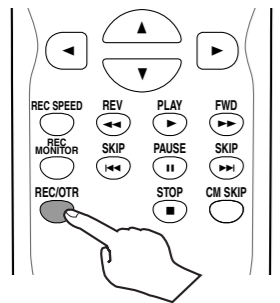

Hit repeatedly to select desired recording time

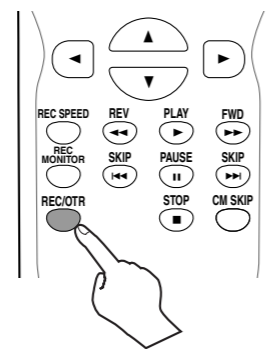

Recording times appear on the TV screen (30 minutes to 4 hours).
Recording will start.

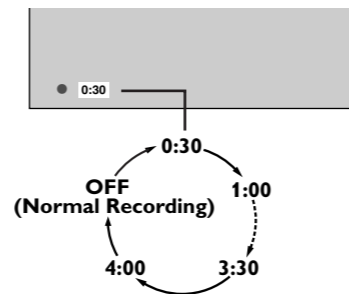

When the unit reaches the specified time, recording will stop automatically.

After all recordings, finalize your disc!

After recording, you must finalize the disc in order to play on other units.

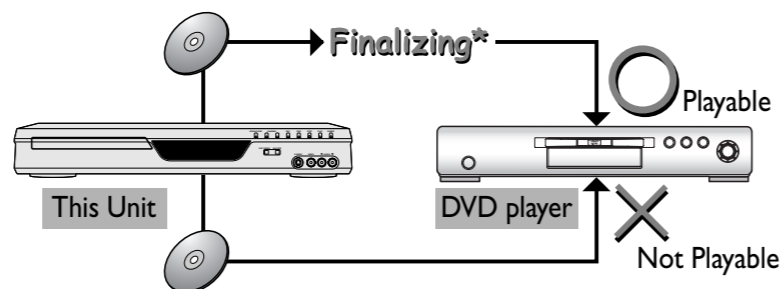

* You cannot finalize discs recorded on other DVD recorders.

To stop recording

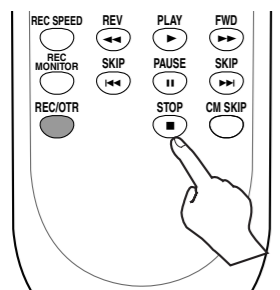

3-2 Timer Recording

- You can set up to 8 programs (once, daily or weekly).
- Be sure to set the clock before starting a timer programming.

Display the Timer Programming Screen

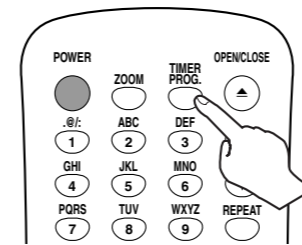

Timer Programming display appears. Select any blank line and hit [ENTER].

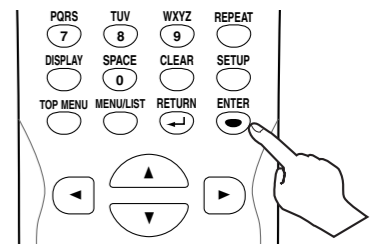
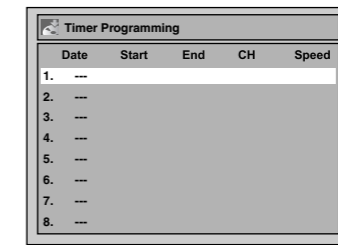

Set the date

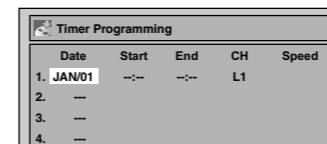

Move to next

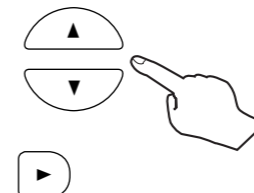

When hitting at the current date, Timer Recording mode will change as follows: e.g. January 1st at present

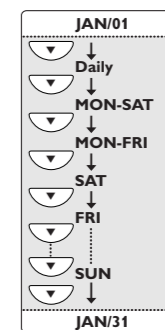

Set start and end time

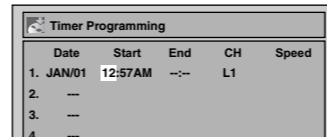

Move to next

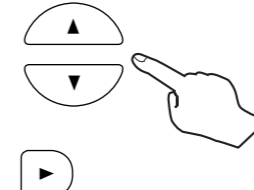

Select the channel number to record

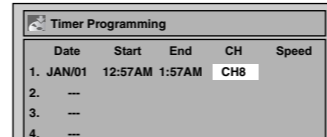

Move to next

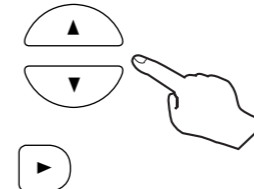

Select the recording speed

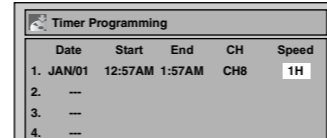

ENTER!

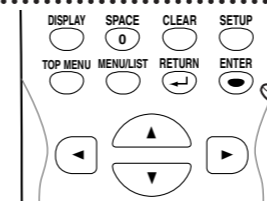

Timer Recording is now set.

Set the Timer Standby mode Turn the unit off

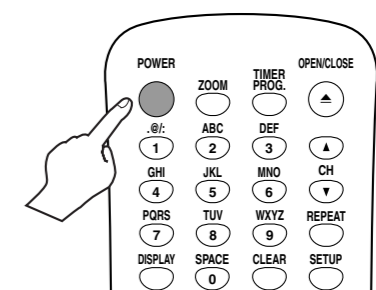

indicator will appear on the front display.

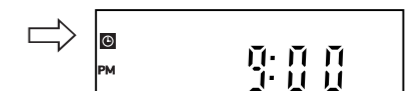

Hints for DVD Recording

- Formatting is not needed when inserting a blank disc. **UNIT AUTOMATICALLY PREPARES THE DISC FOR RECORDING.**
- You need to record in Video mode and finalize the disc to play it back on other players. **OTHER PLAYER MUST BE COMPATIBLE WITH DVD-R or DVD-RW.**

Owner's Manual

DVD Recorder

DVR95DF

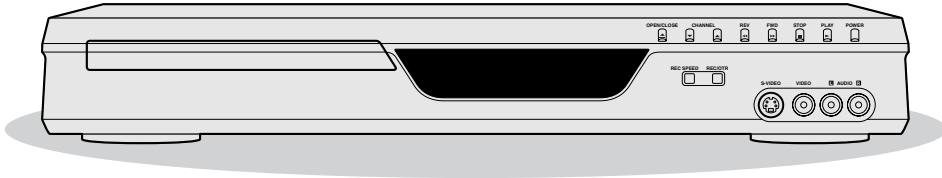

INSTRUCCIONES EN ESPAÑOL INCLUIDAS

Please read before using this equipment.
If you need additional operating assistance after reading this owner's manual or to order replacement accessories, please call
TOLL FREE : 1-800-605-8453
or visit our web site at <http://www.SylvaniaConsumerElectronics.com>

Connection to a TV (Before you use this unit, you need to complete connections.)

If your TV has AUDIO/VIDEO input jacks, see the section "Connections" on pages 13-15. If not, it is still possible to connect this unit to your TV by using a STEREO AUDIO/VIDEO RF Modulator (commercially available.) In this case, follow the instructions below.

- 1) The antenna input jack of your TV may have been already occupied. If so, disconnect the RF cable from your TV, and then connect the RF cable to the ANTENNA IN jack of this unit.
 - 2) Connect the ANTENNA OUT jack of this unit to your RF Modulator (usually marked "ANT IN") by the RF cable.
 - 3) Connect your RF modulator to your TV by another RF cable.
 - 4) Connect the AUDIO/VIDEO output jacks of this unit to the AUDIO/VIDEO input jacks of your RF Modulator by audio and video cables.
 - 5) Set your RF modulator's channel 3/4 switch to either 3 or 4, whichever the TV channel is least used in your area. If your RF modulator has a Modulator/Antenna switch, set it according to your RF modulator's manual.
 - 6) Turn on your TV and choose the same channel as you set the RF modulator's channel 3/4 switch to.
- For more details, follow the instructions supplied with the RF Modulator.

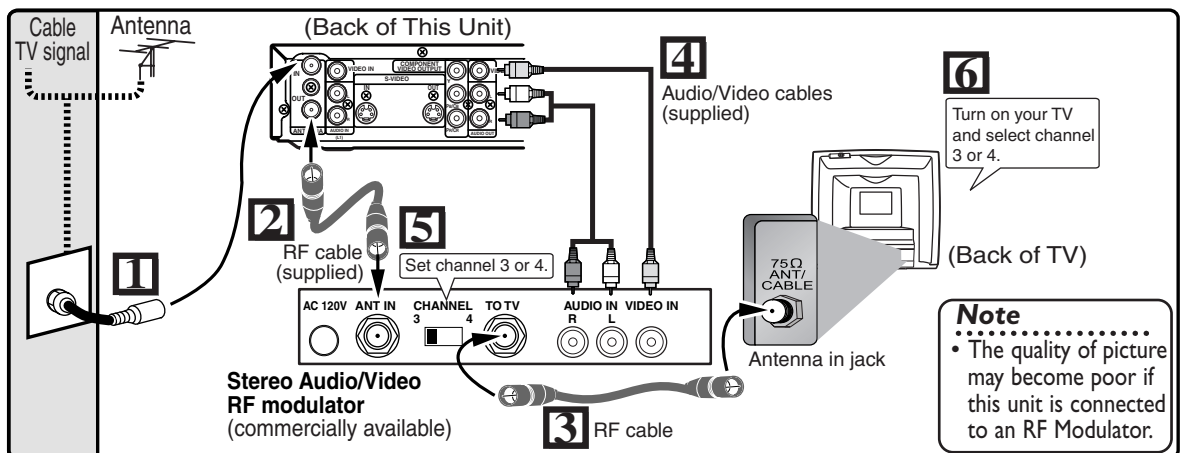

To record a program easily, refer to "Easy DVD recording" on pages 16-17 after connections are completed.
(You CANNOT record on any copyright protected DVD disc with this unit.)

Before you start

Precautions

WARNING: TO REDUCE THE RISK OF FIRE OR ELECTRIC SHOCK, DO NOT EXPOSE THIS APPLIANCE TO RAIN OR MOISTURE.



CAUTION

**RISK OF ELECTRIC SHOCK
DO NOT OPEN**



CAUTION:

TO REDUCE THE RISK OF ELECTRIC SHOCK, DO NOT REMOVE COVER (OR BACK). NO USER SERVICEABLE PARTS INSIDE. REFER SERVICING TO QUALIFIED SERVICE PERSONNEL.



The lightning flash with arrowhead symbol, within an equilateral triangle, is intended to alert the user to the presence of uninsulated "dangerous voltage" within the product's enclosure that may be of sufficient magnitude to constitute a risk of electric shock to persons.



The exclamation point within an equilateral triangle is intended to alert the user to the presence of important operating and maintenance (servicing) instructions in the literature accompanying the appliance.

Laser Safety

This unit employs a laser. Only a qualified service person should remove the cover or attempt to service this device, due to possible eye injury.

CAUTION: USE OF CONTROLS OR ADJUSTMENTS OR PERFORMANCE OF PROCEDURES OTHER THAN THOSE SPECIFIED HEREIN MAY RESULT IN HAZARDOUS RADIATION EXPOSURE.

CAUTION: VISIBLE AND INVISIBLE LASER RADIATION WHEN OPEN AND INTERLOCK DEFEATED. DO NOT STARE INTO BEAM.

LOCATION: INSIDE, NEAR THE DECK MECHANISM.

FCC WARNING- This equipment may generate or use radio frequency energy. Changes or modifications to this equipment may cause harmful interference unless the modifications are expressly approved in the instruction manual. The user could lose the authority to operate this equipment if an unauthorized change or modification is made.

RADIO-TV INTERFERENCE

This equipment has been tested and found to comply with the limits for a Class B digital device, pursuant to Part 15 of the FCC Rules. These limits are designed to provide reasonable protection against harmful interference in a residential installation. This equipment generates, uses, and can radiate radio frequency energy and, if not installed and used in accordance with the instructions, may cause harmful interference to radio communications. However, there is no guarantee that interference will not occur in a particular installation. If this equipment does cause harmful interference to radio or television reception, which can be determined by turning the equipment off and on, the user is encouraged to try to correct the interference by one or more of the following measures:

- 1) Reorient or relocate the receiving antenna.
- 2) Increase the separation between the equipment and receiver.
- 3) Connect the equipment into an outlet on a circuit different from that to which the receiver is connected.
- 4) Consult the dealer or an experienced radio/TV technician for help.

This Class B digital apparatus complies with Canadian ICES-003.

Cet appareil numérique de la classe B est conforme à la norme NMB-003 du Canada.

CAUTION: TO PREVENT ELECTRIC SHOCK, MATCH WIDE BLADE OF PLUG TO WIDE SLOT, FULLY INSERT.

ATTENTION: POUR ÉVITER LES CHOC ÉLECTRIQUES, INTRODUIRE LA LAME LA PLUS LARGE DE LA FICHE DANS LA BORNE CORRESPONDANTE DE LA PRISE ET POUSSER JUSQU'AU FOND.

A NOTE ABOUT RECYCLING

This product's packaging materials are recyclable and can be reused. Please dispose of any materials in accordance with your local recycling regulations.

Batteries should never be thrown away or incinerated but disposed of in accordance with your local regulations concerning chemical wastes.

Make your contribution to the environment!!!

- Used up batteries do not belong in the dust bin.
- You can dispose of them at a collection point for used up batteries or special waste. Contact your council for details.



For Customer Use:

Read carefully the information located at the back of this unit and enter below the Serial No. Retain this information for future reference.

Model No. _____

Serial No. _____

IMPORTANT SAFEGUARDS

1. Read Instructions - All the safety and operating instructions should be read before the appliance is operated.
2. Retain Instructions - The safety and operating instructions should be retained for future reference.
3. Heed Warnings - All warnings on the appliance and in the operating instructions should be adhered to.
4. Follow Instructions - All operating and use instructions should be followed.
5. Cleaning - Unplug this product from the wall outlet before cleaning. Do not use liquid cleaners or aerosol cleaners. Use a damp cloth for cleaning.
EXCEPTION: A product that is meant for uninterrupted service and, that for some specific reason, such as the possibility of the loss of an authorization code for a CATV converter, is not intended to be unplugged by the user for cleaning or any other purpose, may exclude the reference to unplugging the appliance in the cleaning description otherwise required in item 5.
6. Attachments - Do not use attachments not recommended by the product manufacturer as they may cause hazards.
7. Water and Moisture - Do not use this product near water; for example, near a bath tub, wash bowl, kitchen sink, or laundry tub, in a wet basement, or near a swimming pool, and the like.
8. Accessories - Do not place this product on an unstable cart, stand, tripod, bracket, or table. The product may fall, causing serious injury to a child or adult, and serious damage to the appliance. Use only with a cart, stand, tripod, bracket, or table recommended by the manufacturer, or sold with the product. Any mounting of the appliance should follow the manufacturer's instructions and should use a mounting accessory recommended by the manufacturer. An appliance and cart combination should be moved with care. Quick stops, excessive force, and uneven surfaces may cause the appliance and cart combination to overturn.
PORTABLE CART WARNING
(Symbol provided by RETAC)

SS125A
9. Ventilation - Slots and openings in the cabinet are provided for ventilation and to ensure reliable operation of the product and to protect it from overheating, and these openings must not be blocked or covered. The openings should never be blocked by placing the product on a bed, sofa, rug, or other similar surface. This product should not be placed in a built-in installation such as a bookcase or rack unless proper ventilation is provided or the manufacturer's instructions have been adhered to.
10. Power Sources - This product should be operated only from the type of power source indicated on the marking label. If you are not sure of the type of power supply to your home, consult your appliance dealer or local power company. For products intended to operate from battery power, or other sources, refer to the operating instructions.
11. Grounding or Polarization - This product is equipped with a polarized alternating-current line plug (a plug having one blade wider than the other). This plug will fit into the power outlet only one way. This is a safety feature. If you are unable to insert the plug fully into the outlet, try reversing the plug. If the plug should still fail to fit, contact your electrician to replace your obsolete outlet. Do not defeat the safety purpose of the polarized plug.
12. Power Cord Protection - Power supply cords should be routed so that they are not likely to be walked on or pinched by items placed upon or against them, paying particular attention to cords at plugs, convenience receptacles, and the point where they exit from the appliance.
13. Outdoor Antenna Grounding - If an outside antenna or cable system is connected to the product, be sure the antenna or cable system is grounded so as to provide some protection against voltage surges and built-up static charges. Article 810 of the National Electrical Code, ANSI/NFPA No. 70, provides information with regard to proper grounding of the mast and sup-

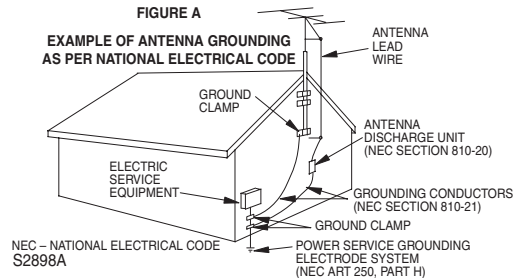
porting structure, grounding of the lead-in wire to an antenna discharge unit, size of grounding conductors, location of antenna-discharge unit, connection to grounding electrodes, and requirements for the grounding electrode. (Fig. A)



14. Lightning - For added protection for this product during a lightning storm, or when it is left unattended and unused for long periods of time, unplug it from the wall outlet and disconnect the antenna or cable system. This will prevent damage to the product due to lightning and power-line surges.
15. Power Lines - An outside antenna system should not be located in the vicinity of overhead power lines or other electric light or power circuits, or where it can fall into such power lines or circuits. When installing an outside antenna system, extreme care should be taken to keep from touching such power lines or circuits as contact with them might be fatal.
16. Overloading - Do not overload wall outlets and extension cords as this can result in a risk of fire or electric shock.
17. Object and Liquid Entry - Never push objects of any kind into this product through any openings as they may touch dangerous voltage points or short-out parts that could result in a fire or electric shock. Never spill liquid of any kind on the product.
18. Servicing - Do not attempt to service this product yourself as opening or removing covers may expose you to dangerous voltage or other hazards. Refer all servicing to qualified service personnel.
19. Damage Requiring Service - Unplug this product from the wall outlet and refer servicing to qualified service personnel under the following conditions:
 - a. When the power-supply cord or plug is damaged.
 - b. If liquid has been spilled, or objects have fallen into the product.
 - c. If the product has been exposed to rain or water.
 - d. If the product does not operate normally by following the operating instructions. Adjust only those controls that are covered by the operating instructions as an improper adjustment of other controls may result in damage and will often require extensive work by a qualified technician to restore the product to its normal operation.
 - e. If the product has been dropped or damaged in any way.
 - f. When the product exhibits a distinct change in performance this indicates a need for service.
20. Replacement Parts - When replacement parts are required, be sure the service technician has used replacement parts specified by the manufacturer or have the same characteristics as the original part. Unauthorized substitutions may result in fire, electric shock or other hazards.
21. Safety Check - Upon completion of any service or repairs to this product, ask the service technician to perform safety checks to determine that the product is in proper operating condition.
22. Heat - This product should be situated away from heat sources such as radiators, heat registers, stoves, or other products (including amplifiers) that produce heat.

Before you start

Precautions (cont'd)

Installation Location

For safety and optimum performance of this unit:

- Install the unit in a horizontal and stable position. Do not place anything directly on top of the unit. Do not place the unit directly on top of the TV.
- Shield it from direct sunlight and keep it away from sources of intense heat. Avoid dusty or humid places. Avoid places with insufficient ventilation for proper heat dissipation. Do not block the ventilation holes on the sides of the unit. Avoid locations subject to strong vibration or strong magnetic fields.

Avoid the Hazards of Electrical Shock and Fire

- Do not handle the power cord with wet hands.
- Do not pull on the power cord when disconnecting it from AC wall outlet. Grasp it by the plug.
- If, by accident, water is spilled on this unit, unplug the power cord immediately and take the unit to our Authorized Service Center for servicing.

Moisture Condensation Warning

Moisture condensation may occur inside the unit when it is moved from a cold place to a warm place or after heating a cold room or under conditions of high humidity. Do not use this unit at least for 2 hours until its inside gets dry.

About Copyright

Unauthorized copying, broadcasting, public performance and lending of discs are prohibited. This product incorporates copyright protection technology that is protected by U.S. patents and other intellectual property rights. Use of this copyright protection technology must be authorized by Macrovision, and is intended for home and other limited viewing uses only unless otherwise authorized by Macrovision. Reverse engineering or disassembly is prohibited.

Notice for progressive scan output

Consumers should note that not all high definition television sets are fully compatible with this product and may cause artifacts to be displayed in the picture. In case of picture problems with 525 progressive scan output, it is recommended that the user switch the connection to the 'standard definition' output. If there are questions regarding your TV set compatibility with this 525p DVD recorder, please contact our customer service center.

Supplied Accessory

- Remote control (NB010UD) with two AA batteries
- RF cable (WPZ0901CAB01 or WPZ0901TM002)
- Audio/Video cables (WPZ0102TM015 or WPZ0102LTE01)
- Owner's Manual (1VMN20869)
- Quick Use Guide (1VMN20870)

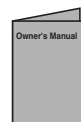
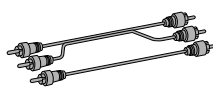
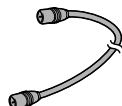

Before you start

Precautions (cont'd)

Maintenance

SERVICING

- Please refer to relevant topics on the Troubleshooting Guide on pages 72-75 before returning the product.
- If this unit becomes inoperative, do not try to correct the problem by yourself. There are no user-serviceable parts inside. Turn off, unplug the power plug and please call our help line mentioned on the front page to locate an Authorized Service Center.

CLEANING THE CABINET

- Use a soft cloth slightly moistened with a mild detergent solution. Do not use a solution containing alcohol, spirits, ammonia or abrasive.

CLEANING DISCS

- When a disc becomes dirty, clean it with a cleaning cloth. Wipe the disc from the center out. Do not wipe in a circular motion.
- Do not use solvents such as benzine, thinner, commercially available cleaners, detergent, abrasive cleaning agents or antistatic spray intended for analogue records.

CLEANING THE DISC LENS

- If this unit still does not perform properly although you refer to the relevant sections and to "TROUBLESHOOTING GUIDE" in this Owner's Manual, the laser optical pickup unit may be dirty. Consult your dealer or an Authorized Service Center for inspection and cleaning of the laser optical pickup unit.

DISC HANDLING

- Handle the discs so that fingerprints and dust do not adhere to the surfaces of the discs.
- Always store the disc in its protective case when it is not used.

Manufactured under license from Dolby Laboratories. "Dolby" and the double-D symbol are trademarks of Dolby Laboratories.

Dolby Digital Recording

"Dolby® Digital Recording enables consumers to record high-quality video with stereo sound on recordable DVD discs. The technology, when utilized instead of PCM recording, also saves recordable disc space, allowing for higher video resolution or extended recording time on each DVD. DVDs created using Dolby Digital Recording will play back on all DVD-Video players."

Note: This is true when the players are compatible with actual recordable DVD discs.

Before you start

Table of contents

Before you start	2	Fast forward / Fast reverse	41
Precautions	2	Skipping TV commercials during playback	41
Table of contents	6	Pause	42
Features	7	Step by step playback	42
Functional overview	8	Slow forward / Slow reverse playback	42
Installing batteries in the remote control	10	Zoom	43
Using a remote control	10	Marker Setup	43
DISPLAYS	10	Follow Playback during Recording	44
On-screen displays	10	Simultaneous Playback and Recording	44
Front panel display	12	Search	45
Connections	13	Title/Chapter search	45
Connection to a TV	13	Track search	46
Connection to a cable box or satellite box	14	Time search	46
Connection to an Audio System	15	Repeat/Random/Program playback	47
Getting started	16	Repeat playback	47
Easy DVD recording	16	Random playback	47
Channel setting	18	Program playback	48
Getting channels automatically	18	Selecting a format of audio and video	48
Adding/deleting channels	19	Switching subtitles	48
Selecting the TV stereo or SAP	20	Switching audio soundtrack	49
Setting the clock	21	Switching camera angles	50
Auto Clock Setting	21	Reducing block noise	50
Manual Clock Setting	22	Editing	51
Setting the daylight saving time	23	Information on disc editing	51
Selecting the TV aspect ratio	23	Guide to a title list	51
Recording	24	Editing discs in Video mode	51
Information on DVD recording	24	Editing discs in VR mode	51
Information	24	Editing discs in Video mode	52
Recordable disc	24	Deleting titles	52
Recording speed	24	Putting names on titles	53
Restrictions on recording	25	Setting or clearing chapter markers	54
Information on copy control	25	Editing discs in VR mode (Original)	55
Making discs playable in other DVD player (Finalize)	25	Deleting titles	55
Formatting a disc	26	Setting titles to protect	56
Choosing the recording format of a blank disc	26	Releasing titles from protecting	56
Reformatting a disc	27	Editing discs in VR mode (Playlist)	57
Basic recording	28	Deleting titles	57
Checking the recording picture and sound quality	28	Deleting parts of titles	58
One-touch Timer Recording	29	Putting names on titles	59
Timer Recording	30	Setting or clearing chapter markers	60
Hints for Timer Recording	32	Setting pictures for thumbnails	61
Settings for an external source	33	Dividing a title	62
Connection to an external source	33	Combining titles	63
Recording from an external source	34	Adding titles to a Playlist	64
Setting a disc to protect	34	Deleting a Playlist	64
Finalizing the discs	35	Changing the Setting menu	65
Auto finalize	36	Tour of the Setting menu	65
Disc playback	37	Language setting	66
Information on DVD playback	37	Display setting	67
Guide to displays	37	Audio setting	68
Basic playback	38	Settings for Parental lock level	70
Playback	38	Others	72
Playing back MP3 disc	39	Troubleshooting	72
Playing back discs using the disc menu	40	Language code	75
Playing back discs using the title menu	40	Glossary	76
Special playback	41	Frequently Asked Questions	76
Resume playback	41	Specifications	77
		Español	78

Before you start

Features

This DVD unit not only plays back DVDs and CDs but also offers features for you to record on DVD discs and edit them after that.

The following features are offered with this unit.

Recording

This unit is compatible with both DVD-RW, which is rewritable repeatedly, and DVD-R, which is available for one-time recording only. You can choose either one for your convenience.

Recording up to 8 programs:

You can program the unit to record up to 8 programs within a month in advance. Daily or weekly program recordings are also available.

One-touch Timer Recording:

You can easily set recording time as you prefer. Every time [REC/OTR] is hit during recording, the recording time will be increased by 30 minutes up to 4 hours. The recording automatically stops when it reached to the recording time you set.

[REC MONITOR]:

You can confirm the picture and sound quality for recording for the current recording speed which you set. If you want to change the recording speed, hit [REC SPEED] to set the desired recording mode.

Automatic Chapter marker setting:

You can mark each title of recording by chapter markers as you set in the Setting menu before recording.

Automatic Title menu making (Video mode):

The unit makes title menus automatically when finalizing the disc.

Automatic PLAYLIST making (VR mode):

A Playlist will be prepared from an Original list, so that you can edit titles on a Playlist as you prefer.

An Original list is kept as it is.

Automatic finalizing (Video mode):

The unit can finalize discs automatically after finishing all Timer Recordings or when the disc runs out recordable space as you set in the Setting menu.

Left channel stereo recording:

This unit can record the Left channel monaural sound as Left and Right channel sound automatically (the input from the LINE 2 only).

Playback

Theater surround sound in your home:

When connecting the unit to an amplifier or a decoder which is compatible with Dolby Digital, you can experience the theater-quality surrounding recorded sound.

Follow Playback during Recording and Simultaneous Playback and Recording:

You can play the already recorded part of the current recording or another title during recording.

Quick search for what you want to watch:

You can easily find the part you want to watch using the search function. Search for a desired point on a disc by title, chapter or time.

Start Playback from Original and Playlist:

You can play back titles from either the Original list or the Playlist.

Editing

Deleting titles:

You can delete titles which you do not need anymore.

Making your own Playlist (VR mode):

With the Original remains as it is, you can edit titles on various Playlist as you prefer.

Putting names on titles

Setting pictures for thumbnails

Setting / clearing chapter markers

Dividing / combining titles

Deleting parts of titles etc

Protecting titles (VR mode):

You can prevent accidental editing or title erasing, with this function.

Compatibility

Playback of discs recorded in Video mode on a regular DVD player (Video mode):

Discs recorded in Video mode can be played back on regular DVD players, including computer DVD drives compatible with DVD-Video playback*. You will need to finalize the discs recorded in Video mode to play back on other DVD players.

** DVD-Video Format (Video mode) is a new format for recording on DVD-RW/R discs that was approved by the DVD Forum in 2000. Adoption of this format is optional for manufacturers of DVD playback devices, and there are DVD-Video players, DVD-ROM drives or other DVD playback devices that do not play back DVD-RW/R discs recorded in the DVD-Video Format.*

Others







Progressive Scan system

Unlike conventional interlace scanning, the progressive scan system provides less flickering and images in higher resolution than that of traditional television signals.

Symbol in this Owner's Manual

The available functions depend on the type of disc or the recording mode.

To specify disc type or recording mode for each function, we put the following symbols at the beginning of each item to operate.

Symbol	Description
	Available to DVD Video discs
	Available to DVD-RW in Video mode
	Available to DVD-RW in VR mode
	Available to DVD-R discs
	Available to Audio CDs
	Available to CD-RW/R discs with MP3 files

Before you start

Functional overview

Front Panel

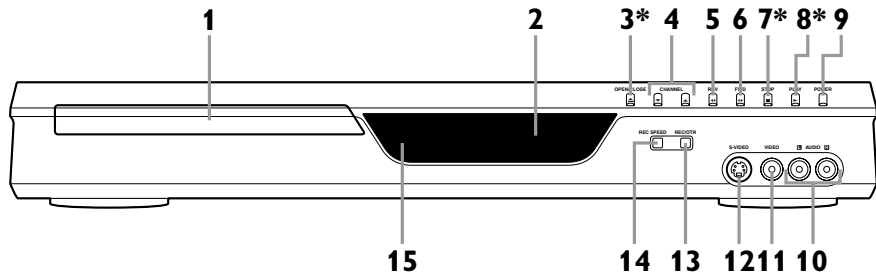

(*) The unit can also be turned on by pressing these buttons.

1. **Disc tray**
Place a disc when open.
2. **Display**
Refer to "Front Panel Display" on page 12.
3. **OPEN/CLOSE ▲ button***
Hit to open or close the disc tray.
4. **CHANNEL ▼ / ▲ button**
Press to change the channel up and down.
5. **REV ◀◀ button**
During playback, hit to skip to the previous chapter or track.
During playback, press and hold for 1.5 seconds for fast reverse.
When playback is paused, hit repeatedly for slow reverse.
6. **FWD ▶▶ button**
During playback, hit to skip to the next chapter or track.
During playback, press and hold for 1.5 seconds for fast forward.
When playback is paused, hit repeatedly for slow forward.
7. **STOP ■ button***
Hit to stop playback or recording.
8. **PLAY ▶ button***
Hit to start or resume playback.
9. **POWER button**
Hit to turn on and off the unit.
Hit to set the timer-standby mode.
10. **AUDIO input jacks (LINE2)**
Use to connect external equipment with standard audio cables.
11. **VIDEO input jack (LINE2)**
Use to connect external equipment with a standard video cable.
12. **S-VIDEO input jack (LINE2)**
Use to connect the S-Video output of external equipment with an S-Video cable.
13. **REC/OTR button**
Hit once to start a recording. Hit repeatedly to start a one-touch Timer Recording.
14. **REC SPEED button**
Hit to switch the recording speed.
15. **Remote control sensor**
Receive signals from your remote control so that you can control the unit from a distance.

Rear Panel

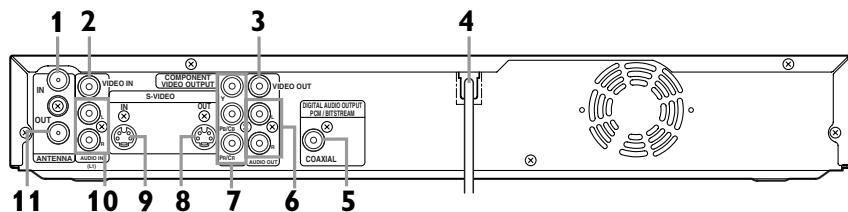

1. **ANTENNA IN jack**
Use to connect an antenna.
2. **VIDEO IN jack (LINE1)**
Use to connect external equipment with a standard video cable.
3. **VIDEO OUT jack**
Use to connect a TV monitor, AV receiver or other equipment with a standard video cable.
4. **AC Power Cord**
Connect to a standard AC outlet to supply power to this unit.
5. **COAXIAL DIGITAL AUDIO OUTPUT jack**
Use to connect an AV receiver, Dolby Digital decoder or other equipment with a coaxial digital input jack with a digital coaxial cable.
6. **AUDIO OUT jacks**
Use to connect a TV monitor, AV receiver or other equipment with standard audio cables.
7. **COMPONENT VIDEO OUTPUT jacks**
Use to connect a TV monitor with component video inputs with component video cables.
8. **S-VIDEO OUT jack**
Use to connect the S-Video input of a TV monitor, AV receiver or other equipment with an S-Video cable.
9. **S-VIDEO IN jack (LINE1)**
Use to connect the S-Video output of external equipment with an S-Video cable.
10. **AUDIO IN jacks (LINE1)**
Use to connect external equipment with standard audio cables.
11. **ANTENNA OUT jack**
Use to connect an antenna cable to pass the signal from the TV ANTENNA IN to your TV monitor.

Note

- Do not touch the inner pins of the jacks on the rear panel. Electrostatic discharge may cause permanent damage to the unit.
- This unit does not have the RF modulator.

Remote Control

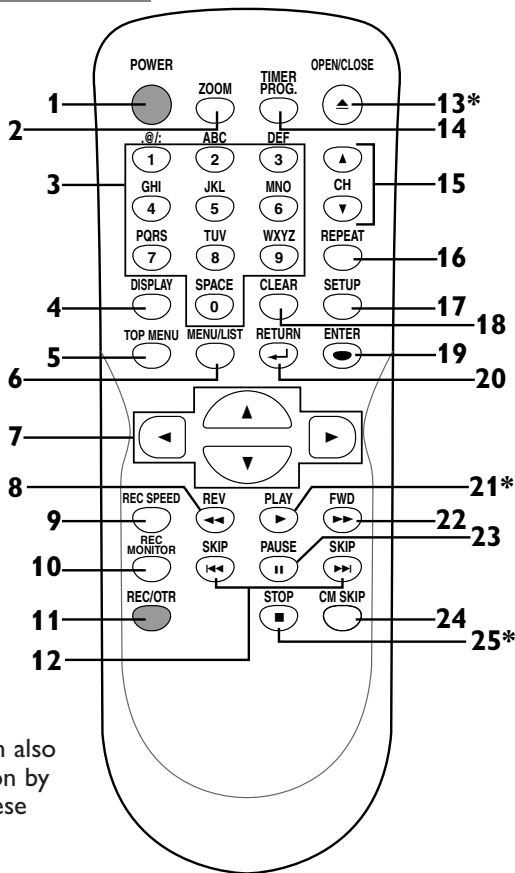

(* The unit can also be turned on by pressing these buttons.

1. **POWER button**
Hit to turn on and off the unit.
Hit to set the timer-standby mode.
2. **ZOOM button**
During playback, hit to enlarge the picture on the screen.
3. **Number buttons**
Hit to select channel numbers.
Hit to select a title/chapter/track on display.
Hit to enter values for the settings in the Setting menu.
4. **DISPLAY button**
Hit to display the on-screen menu.
5. **TOP MENU button**
Hit to display the top menu.
6. **MENU/LIST button**
Hit to display the Disc menu.
To change ORIGINAL and PLAYLIST on the TV screen. (VR mode only)
7. **Cursor ▲ / ▼ / ◀ / ▶ buttons**
Hit to select items or settings.
8. **REV ◀◀ button**
During playback, hit to play back in fast reverse.
Or when playback is paused, hit to play back in slow reverse.
9. **REC SPEED button**
Hit to change the recording speed.
10. **REC MONITOR button**
Hit to check the video and audio signals for recording.
11. **REC/OTR button**
Hit once to start a recording.
Hit repeatedly to start a One-Touch Timer Recording.
12. **SKIP ◀◀ button**
During playback, hit to skip to the previous chapter or track. Or when playback is paused, hit to play back in reverse step by step.
SKIP ▶▶ button
During playback, hit to skip to the next chapter or track.
Or when playback is paused, hit to play back in forward step by step.
- 13.* **OPEN/CLOSE ▲ button***
Hit to open or close the disc tray.
14. **TIMER PROG. button**
Hit to display the timer program setting menu.
15. **CH ▲ / ▼ buttons**
Press to change the channel up and down.
16. **REPEAT button**
Hit to display the repeat setting menu.
17. **SETUP button**
Hit to display the setup menu.
During DVD playback, press and hold for more than 3 seconds to switch to the progressive scanning mode or the interlace mode.
18. **CLEAR button**
Hit to clear the password entered, to cancel the programming for CD, to clear the highlighted marker number in the marker setup mode or to clear the program once entered in the Timer Recording setting mode, etc.
19. **ENTER button**
Hit to confirm or select menu items.
20. **RETURN ↵ button**
Hit to return to the previously displayed menu screen.
- 21.* **PLAY ▶ button***
Hit to start or resume playback.
22. **FWD ▶▶ button**
During playback, hit to play back in fast forward.
Or when playback is paused, hit to play back in slow forward.
23. **PAUSE || button**
Hit to pause playback or recording.
24. **CM SKIP button**
During playback, hit to skip to the 30 second advanced point.
- 25.* **STOP ■ button***
Hit to stop playback or recording.

Before you start

Functional overview (cont'd)

Installing batteries in the remote control

Install two “AA” size batteries (supplied) to match the polarity as indicated inside battery compartment of the remote control.

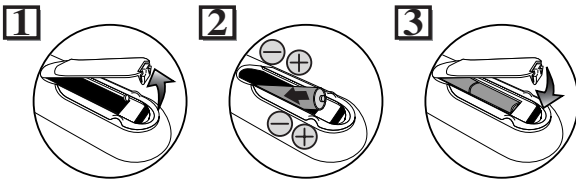

Note:

Incorrect use of batteries can result in hazards such as leakage and bursting. Please follow the instruction below:

- Do not mix new and old batteries together.
- Do not use different kinds of batteries together. Although they may look similar, different batteries may have different voltages.
- Make sure that the plus and minus ends of each battery match the indications in the battery compartment.
- Remove batteries from equipment that is not going to be used for a month or more.
- When disposing used batteries, please comply with governmental regulations or public rules for environmental protection that apply in your country or area.
- Do not recharge, short-circuit, heat, burn or disassemble batteries.

Using a remote control

Keep in mind the followings when using the remote control:

- Make sure that there is no obstacle between the remote control and the remote sensor on the unit.
- Remote operation may become unreliable if strong sunlight or fluorescent light is on the remote sensor of the unit.
- Remote control for different devices can interfere with each other. Avoid using remote control for other equipment located close to the unit.
- Replace the batteries when you notice a fall-off of the operating range of the remote control.
- The maximum operable ranges from the unit are as follows.
 - **Beeline:** approx. 23 feet (7m)
 - **Either side of the center:** approx. 16 feet (5m) within 30°
 - **Above:** approx. 16 feet (5m) within 15°
 - **Below:** approx. 10 feet (3m) within 30°

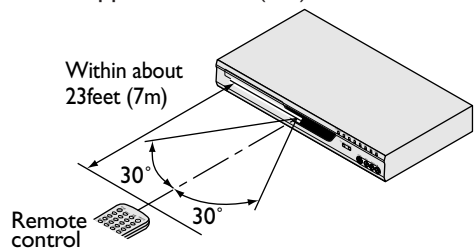

Displays

On-screen displays

DISPLAY menu

Hit **[DISPLAY]** to call up the display menu. This menu will give you the information on the playing disc. Some operations are available while disc is playing.

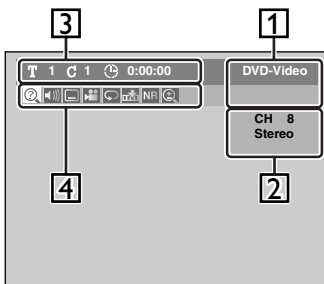

1. Indicates a disc type and a format mode.
NOTE: In some descriptions on this manual, only one disc type is indicated as an example.
2. Indicates a channel number and the audio status.
3. Indicates a title number, chapter number and the time lapse of disc play.

4. Each icon means:

- : Search
- : Audio
- : Subtitle
- : Angle (except VR mode)
- : Repeat
- : Marker
- : Noise Reduction
- : Zoom

Note:

- This is an example screen only for explanation. Displayed items will change depending on the actual mode.
- DISPLAY function is not available when no disc is inserted.

Before you start

Displays (cont'd)

Setting menu

Hit **[SETUP]** to display Easy Setting Menu or Hit Advanced Setting Menu. Choose either Menu using **[▲ / ▼]**, then hit **[ENTER]** to display it.

These menus allow you to perform all main functions and change setting for them.

Easy Setting Menu and Advanced Setting Menu are available. Easy Setting Menu consists of those frequently needed. You can make all required setting using Advanced Setting Menu. Items with  mark can be set in both menus.

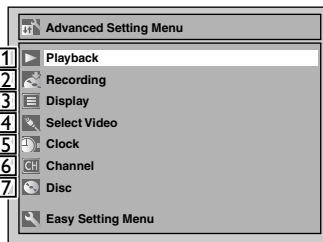
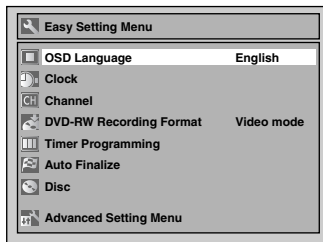

1. Playback:

To set up the unit to play back discs as you prefer.

2. Recording:

To set up the unit to record on discs as you prefer.

3. Display:

To set up the OSD screen and the front display of the unit as you prefer.

4. Select Video:

To choose a line input to record on DVD discs from other video equipment.

5. Clock:

To set up the clock of the unit.

6. Channel:

To adjust the channel setting of the unit as you prefer.

7. Disc / CD Playback Mode: “Disc” is available only when a DVD-RW/R disc is inserted into the unit. When a DVD-Video disc (commercially available), a new DVD-R disc or a finalized DVD-R disc is inserted into the unit, you cannot select “Disc”.

“CD Playback Mode” is available only when an Audio CD disc or a CD-RW/R disc with MP3 files is inserted into the unit.

<DVD-R, DVD-RW (Video mode)>

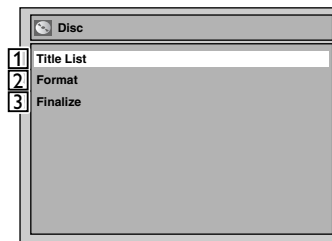

<DVD-RW (VR mode)>



<CD, MP3>

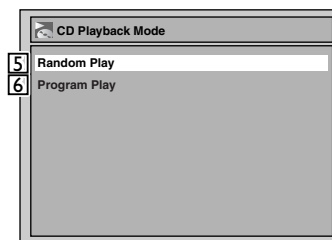

1. Title List / Playlist / Original:

Turns on a title list, playlist or Original, which shows the recorded titles on the disc.

2. Format (DVD-RW only):

Allows you to erase all of the recorded content on the disc. The disc will be completely blank.

- Erased content cannot be called back.
- A DVD-RW disc formatted with this unit cannot be used in other DVD recorders for recording.
- If you want to use a disc formatted with this unit on another DVD recorder, you have to re-format the disc on that recorder.

3. Finalize:

Allows you to finalize a disc with titles recorded on this unit only.

4. Disc Protect (VR mode only):

Allows you to protect a disc from accidental editing or recording.

5. Random Play:

To activate the random playback.

6. Program Play (Audio CD only):

To activate the programmed playback.

Before you start

Displays (cont'd)

Front Panel Display

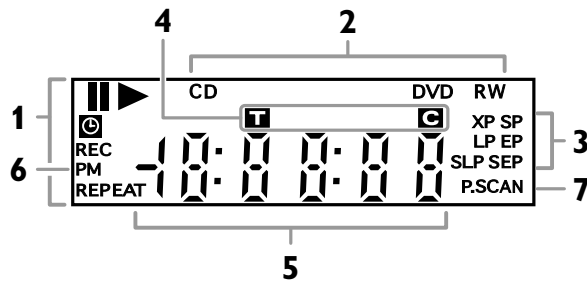

1. Current status of the unit

- ||** : Appears when disc playback is paused.
- ▶** : Appears when playing back a disc.
- ⌚** : Appears when the timer programming has been set and is proceeding. Flashes when all Timer Recordings have been finished, or when a program cannot be performed by some reasons.
- REC** : Appears during recording process.
- REPEAT** :
Appears during repeat playback.

2. Disc type

- CD** : Appears when an audio CD or a disc with MP3 files is inserted in the disc tray.
- DVD** : Appears when a DVD disc is inserted in the disc tray.
- DVD R** :
Appears when a DVD-R disc is inserted in the disc tray.
- DVD RW** :
Appears when a DVD-RW disc is inserted in the disc tray.

3. Recording speed

Indicates the recording speed of the disc.

4. Title/Track and Chapter mark

- T** : Appears when indicating a title/track number.
- C** : Appears when indicating a chapter number.

5. Displays the following

- Playing time / remaining time
- Current title / chapter / track number
- Recording time
- Clock
- Channel number
- OTR (One-touch Timer Recording) remaining time

6. PM : Appears in the afternoon with the clock displaying.

7. P.SCAN :

Appears when the progressive scan system is activated.

Display message



Appears when the unit is turned on.



Appears when the disc tray is closing.



Appears when the unit is turned off.



Appears when a disc is loaded on the disc tray.



Appears when the disc tray is opening.



Appears when data is being recorded on a disc.

Connections

Connection to a TV

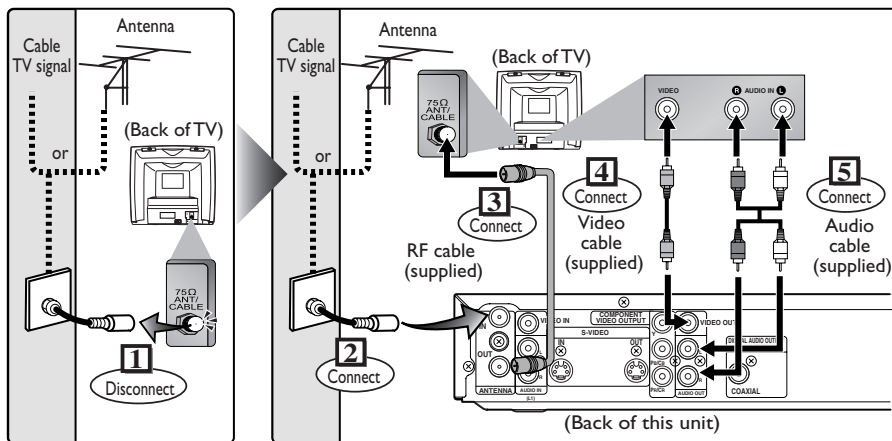

6 Plug in the AC power cord of this unit.

Note

- You must use both A/V cables and coaxial to operate this unit.

Choose one of the following connections, depending on the capabilities of the equipment you possess.

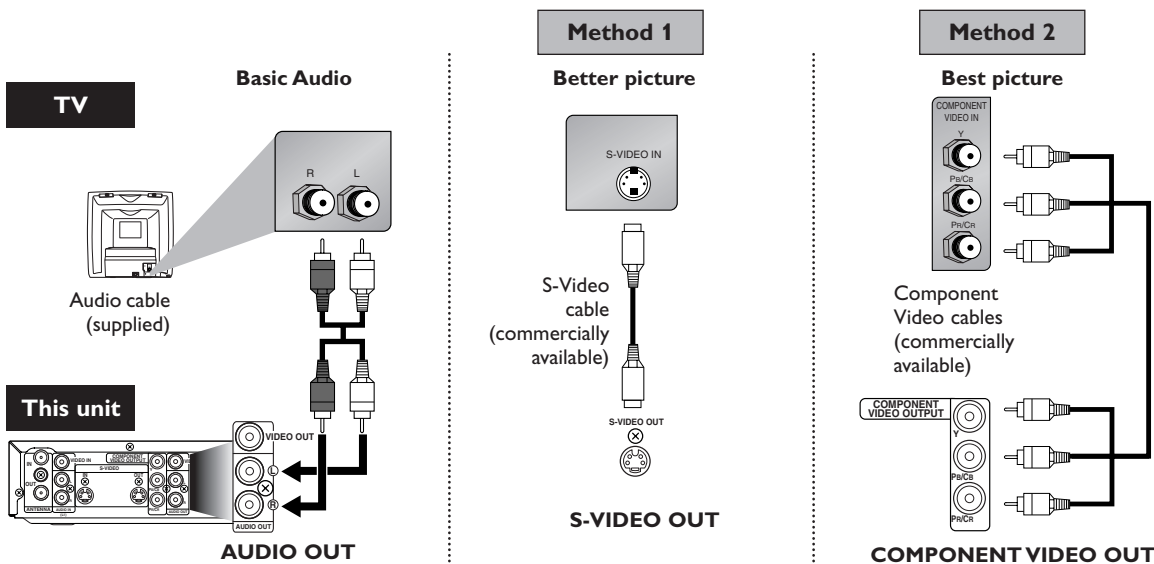

After you have completed connections

- Switch the input selector on your TV to an appropriate external input channel (usually near channel 0). Press a button on the TV's original remote control that selects an external input channel until the DVD recorder's picture appears. Check your TV owner's manual for details.

Input Mode Names for Common TV Brands (Example)

Admiral	AUX	Panasonic	TV/VIDEO
Curtis Mathis	LINE1, LINE2, 00, 90, 91, 92, 93	RCA	INPUT, TV/VCR, 00, 90, 91, 92, 93
GE	INPUT, TV/VCR, 00, 90, 91, 92, 93	Samsung	TV/VIDEO
Hitachi	INPUT, AUX	Sanyo	VIDEO
JVC	A/V CHANNEL, INPUT1, SVIDEO, INPUT2	Sharp	00
Kenwood	AUX	Sony	VIDEO1, VIDEO2, VIDEO3
LXI-Series	00	Toshiba	TV/GAME
Magnavox	AUX CHANNEL	Zenith	00

Note

- Connect this unit directly to the TV. If the A/V cables are connected to a VCR, pictures may be distorted due to the copy protection system.
- When **Progressive Scan mode** is selected, no video signal will be output from the **VIDEO OUT** or **S-VIDEO OUT** jack.

Connections

Connection to a TV (cont'd)

If your TV is compatible with Progressive Scan (525p / 480p) and you want to enjoy that high quality picture;

You must select the connection Method 2 on page 13 and Progressive Scan mode. To set the mode, press and hold **[SETUP]** on the remote control for more than 3 seconds during DVD playback, so that "PSCAN" will appear on the display of this unit.

If your TV is not compatible with Progressive Scan;

Use this unit in Interlace mode. Make sure that no "PSCAN" is on the display of this unit. If not, press and hold **[SETUP]** on the remote control for more than 3 seconds during DVD playback, so that "PSCAN" on the display of this unit will disappear.

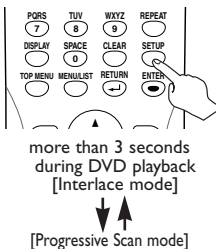

Connection to a cable box or satellite box

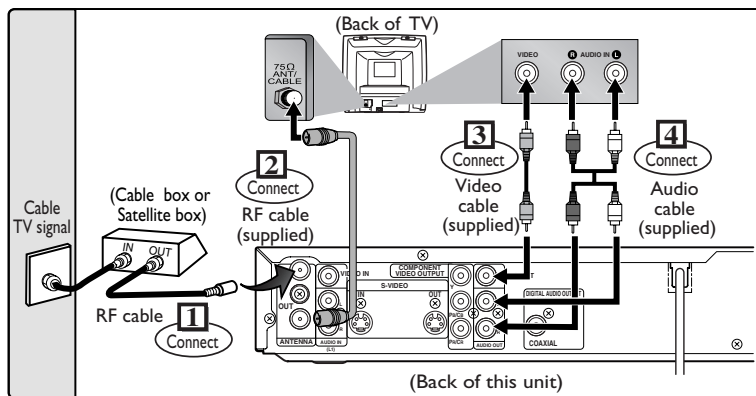

With this setup:

- You can record any unscrambled channel by selecting the channel on the cable box or satellite box. Be sure that the cable box or satellite box is turned on.
- **You cannot record one channel while watching another channel.**

Note to the Cable TV System Installer :

This reminder is provided to call the Cable TV system installer's attention to Article 820-40 of the National Electrical Code, which provides guidelines for proper grounding - in particular, specifying that the cable ground shall be connected to the grounding system of the building, as close to the point of cable entry as possible.

Connections

Connection to an Audio System

- When you change the connections, all devices should be turned off.
- Refer to the operation manual accompanying external devices for more information.

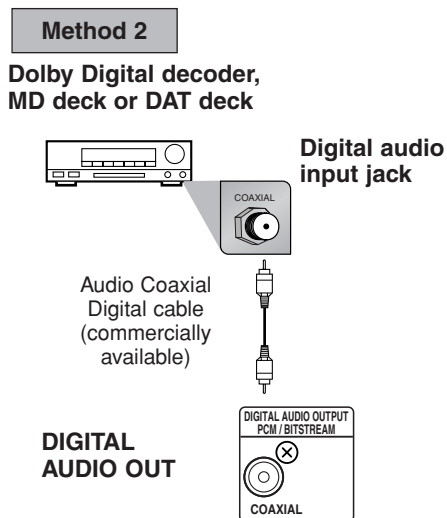
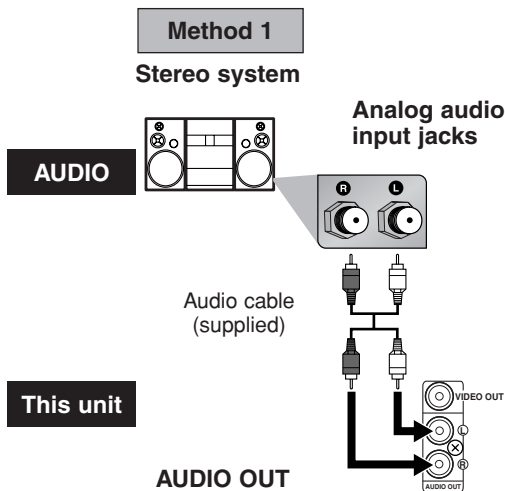

Connection	Setting	Setting > Playback > Digital Out >	
		PCM	Dolby Digital
If output is Dolby Digital encoded audio, connect to a Dolby Digital decoder.		-	Stream
Unless connected to a Dolby Digital decoder.		-	PCM
Connecting to an MD deck or DAT deck.		-	PCM

* To complete these settings, refer to pages 68-69.

Note

- By hooking this unit up to a Multi-channel Dolby Digital decoder, you can enjoy high-quality Dolby Digital 5.1 channel surround sound as heard in the movie theaters.
- The audio source on a disc in a Dolby Digital 5.1 channel surround format cannot be recorded as digital sound by an MD or DAT deck.
- Playing back a DVD using incorrect settings may generate noise distortion and may also damage the speakers.

Getting started

Easy DVD recording

The following will help you to understand easily how to record on DVD discs.

Note:

Make sure batteries are in the remote control and you have connected this unit and the TV correctly.

Step 1: Choose a disc type

There are several types of recordable DVD discs to choose from. Choose a recordable DVD disc type based on your playback/recording/editing needs. See "DVD disc types" at the bottom of this page for more information on the differences among various compatible media.

This unit can record on the following type of discs.

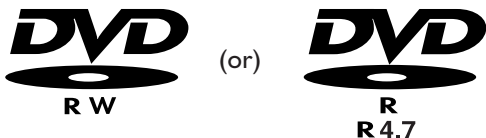

For example, when you want to record repeatedly on the same disc or when you want to edit the disc after recording, select the rewritable DVD-RW type disc.

When you want to save recordings without any alteration, a non-rewritable DVD-R can be your choice.

Step 2: Insert a blank disc

Remote Control

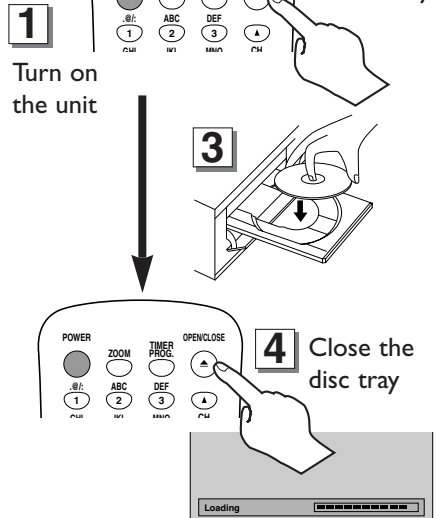

This operation may take a while to be recognized.

DVD disc types

☆☆☆ : Most suitable. ☆☆☆ : Can be used. ☆☆☆ : Some functions are limited. — : Cannot be used.

You want to	DVD-RW VR	DVD-RW Video	DVD-R
Record TV programs	☆☆☆	☆☆☆	☆☆
Reuse by deleting unwanted contents	☆☆☆	☆☆	—
Edit recorded contents	☆☆☆	☆☆	☆☆
Edit/Record from connected equipment	☆☆☆	☆☆☆	☆☆☆
Copy discs for distribution	☆☆ ^{*1}	☆☆☆	☆☆☆
Play on other DVD equipment	☆☆ ^{*1}	☆☆☆	☆☆☆

Features

Features	DVD-RW VR	DVD-RW Video	DVD-R
Recording			
Rewritable?	Yes	Yes	No
Can create chapters at fixed intervals (auto.)	Yes	Yes	Yes
Can create chapters wherever you like (manual)	Yes	No	No
Can record 16:9 size pictures	Yes	Yes	Yes
Can record Copy-Once programs	Yes	No	No
Editing			
Can perform basic edit functions	Yes	Yes	Yes
Can perform advanced edit functions (Playlist edit)	Yes	No	No

^{*1} DVD-RW (VR mode) can only be played on DVD equipment that is VR compatible.

Note:
For details of the above functions and implied restrictions, see the explanations inside the manual.

Format the disc

When inserting a disc that has already been recorded on, you can delete those contents by formatting that disc. **It is necessary to prepare the disc for recording. Details are on pages 26-27.**

- * When you format a disc, the entire contents on that disc will be erased.
- The unit automatically starts initializing when a brand new disc is inserted.

Getting started

Easy DVD recording (Cont'd)

Step 3: Select the recording speed

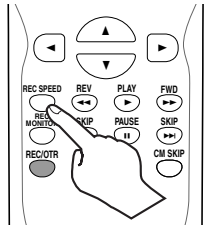

Step 4: Select the desired channel

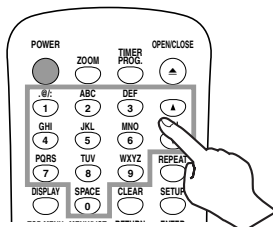

Step 5: Record to DVD discs

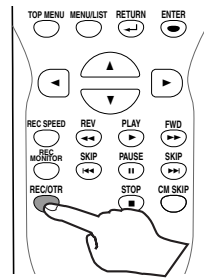

Hint 1: Play back the recorded contents

You can select the title you want to play back from a displayed menu, and immediately start to play back. Recorded contents are easily accessible, with simple procedure of choosing a title on a chapter on the menu screen.

What are titles and chapters?

The contents of DVD disc are generally divided into titles. Titles may be further divided into chapters.

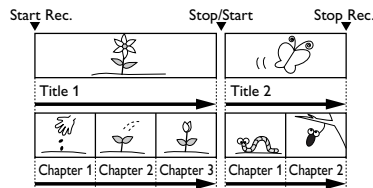

Hint 2: Edit the recorded disc

You will find editing discs is easy. This unit offers convenient editing functions which are possible only with DVD-R/RW discs.

You can edit the following from a title list.

- Putting names on titles
- Setting pictures for thumbnails
- Setting/clearing chapter markers
- Deleting titles or scenes

(Possible editing functions depend on the recording format and editing method.)

Original and Playlist (VR mode)

You can edit the recordings in Playlist without changing the original recordings. Playlist does not take up much disc space.

What "Original" or "Playlist" is for?

Throughout this manual, you will find *Original* and *Playlist* to refer to the actual content and the edited version.

- **Original** content refers to what's actually recorded on the disc.
- **Playlist** content refers to the edited version of the original content.

Finalizing a Disc

- You need to record in video mode and finalize the disc to play it back on other players.
- Once you finalize a disc recorded in video mode, you cannot record or edit any information on the disc.
- Discs recorded in VR mode can still be edited after finalization.

Step 6: Stop the record

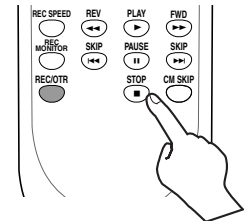

(Appears only in the VR mode)

This operation may take a while to be completed.

Getting started

Channel setting

Right after the purchase of the unit and whenever you move to a new area, we recommend to program available channels in your area using "Auto Preset" in the Channel Preset of the Setting menu.

Getting channels automatically



1
Hit [POWER].

2
Turn the TV on. Select the input to which the unit is connected.
Refer to the table on page 13.

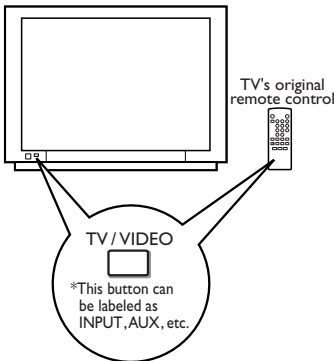

3
Hit [SETUP].
Easy Setting Menu or Advanced Setting Menu will appear.

4
Using [▲ / ▼], select "Channel". Hit [ENTER].
Channel menu will appear.

5
Using [▲ / ▼], select "Auto Preset". Hit [ENTER].
The unit will start getting channels available in your area.

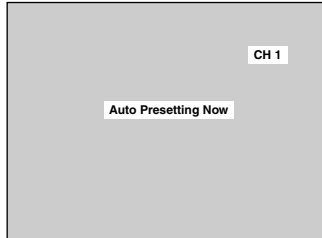

6
Hit [SETUP] to exit.
• [CH ▲ / ▼] will switch among the memorized channels.

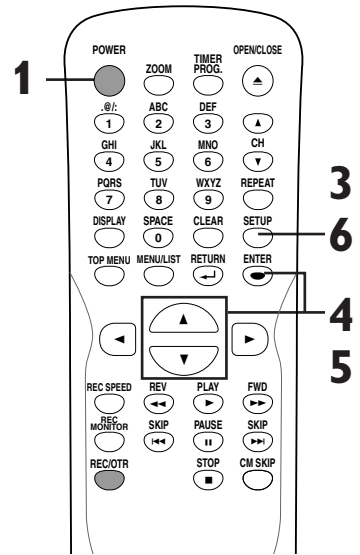

To select a channel

You can select a channel by directly entering channel number using the **Number buttons** on the remote control.

Notes for using the Number buttons:

- When selecting cable channels which are higher than 99, enter channel numbers as a three-digit number. (For example: 117, hit [1], [1], [7])
- You must precede single-digit channel numbers with a zero (For example: 02, 03, 04 and so on).
- You can select the line input mode ("L1" or "L2"). To select "L1" by hitting [0], [0], [1]. To select "L2" by hitting [0], [0], [2]. Details are on page 34.

Note

- If the auto presetting is cancelled during presetting, some channels not yet preset may not be received.
- The selection will depend on how you receive the TV channels.

To cancel the auto presetting during scanning:

Press [RETURN ←] or [SETUP] to cancel.

Adding/deleting channels



The channels you no longer receive or seldom watch can be deleted from the memory. You can also add channels into memory.

1
Hit [SETUP] in the stop mode.

Easy Setting Menu or Advanced Setting Menu will appear.

2
Using [▲ / ▼], select "Channel". Hit [ENTER].
Channel menu will appear.

3
Using [▲ / ▼], select "Manual Preset". Hit [ENTER].
Manual Preset menu will appear.

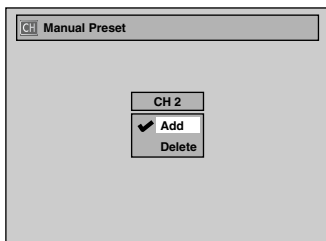

4
Select the channel number to add or delete.

Press [◀] or CH [▼] to move to a smaller channel number.

Press [▶] or CH [▲] to move to a larger channel number.

- Use [◀ / ▶] to move through the channels one by one, including the ones not in the channel memory, while use [CH ▲ / ▼] to move through the channels only in the channel memory.

Press the **Number buttons** to select a channel number directly.

5
Using [▲ / ▼], select "Add" or "Delete". Hit [ENTER].

The channel number will be added or deleted from the channel memory. Then the next channel number will appear so that you can continue adding or deleting channels.

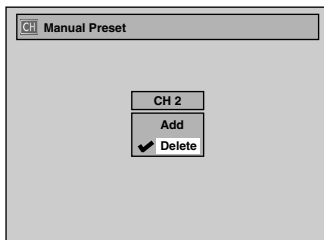

6
Hit [SETUP] to exit.

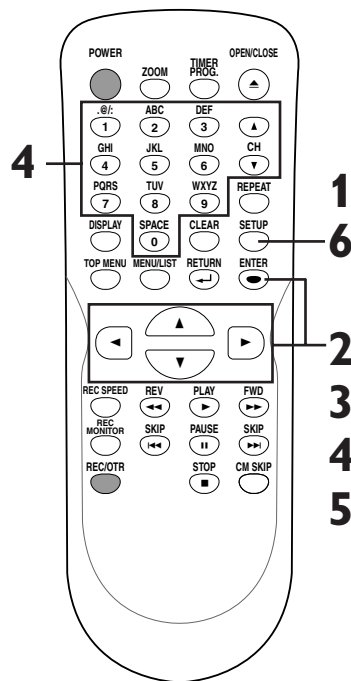

Getting started

Selecting the TV stereo or SAP

You can select an audio channel to output from TV.

1
Hit [SETUP] in the stop mode.

Easy Setting Menu or Advanced Setting Menu will appear. If Advanced Setting Menu is displayed, proceed to STEP 3.

2
Using [▲ / ▼], select "Advanced Setting Menu". Hit [ENTER].

Advanced Setting Menu will appear.

3
Using [▲ / ▼], select "Channel". Hit [ENTER].
Channel menu will appear.

4
Using [▲ / ▼], select "TV Audio Select". Hit [ENTER].
Option window will appear.

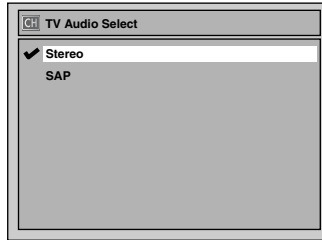

The default is set as "Stereo".

5
Using [▲ / ▼], select "Stereo" or "SAP". Hit [ENTER].

Stereo:
Outputs main-audio.
SAP (Secondary Audio Program):
Outputs Sub-audio.
Refer to the item in "Glossary" on page 76 for more information.

6
Hit [SETUP] to exit.

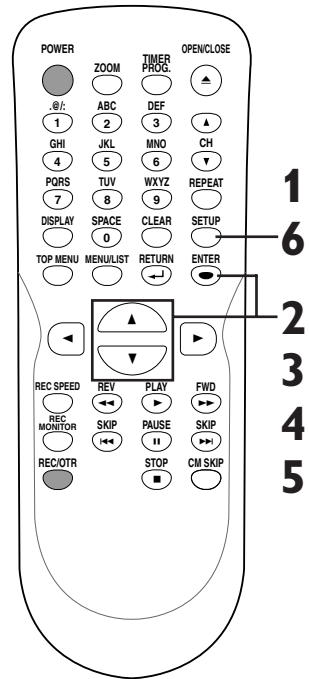

Notes on TV channel audio

- If you want to record a TV program available in second audio or stereo on a DVD-RW/R, you have to select either Stereo or SAP in the Channel Preset screen beforehand. Refer to the following table to check an appropriate setting.

Selected audio	Broadcast audio	Disc recording	Audio output
Stereo	STEREO+SAP	STEREO	STEREO
	STEREO	STEREO	STEREO
	MONO+SAP	MONO	MONO
	MONO	MONO	MONO
SAP	STEREO+SAP	SAP	SAP
	STEREO	STEREO	STEREO
	MONO+SAP	SAP	SAP
	MONO	MONO	MONO

- You can only play back the disc in second audio if a TV program is available in second audio and you set "TV Audio Select" to "SAP".

Getting started

Setting the clock

Set the clock before you try the Timer Recording. If a Public Broadcasting Service (PBS) is available in your area, follow the Auto Clock Setting below. If not, follow the Manual Clock Setting on page 22.

Auto Clock Setting

Make sure:

- The antenna/Cable TV connections are correct.
- If this unit is connected to a Cable Box or Satellite Box, select the local PBS station on them to set the clock automatically.

1

Hit **[SETUP]** in the stop mode.

Easy Setting Menu or Advanced Setting Menu will appear. If Advanced Setting Menu is displayed, proceed to STEP 3.

2

Using **[▲ / ▼]**, select “Advanced Setting Menu”. Hit **[ENTER]**.

Advanced Setting Menu will appear.

3

Using **[▲ / ▼]**, select “Clock”. Hit **[ENTER]**.

Clock menu will appear.

4

Using **[▲ / ▼]**, select “Auto Clock Setting”. Hit **[ENTER]**.

Option window will appear.

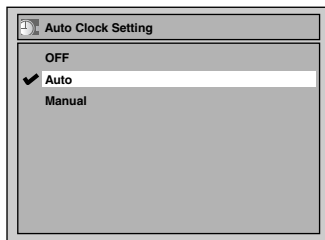

5

• If you do not know the PBS channel number in your area:

Using **[▲ / ▼]**, select “Auto”. Hit **[ENTER]**.

The setting will be activated.

• If you know the PBS channel number in your area:

Using **[▲ / ▼]**, select “Manual”. Hit **[ENTER]**.

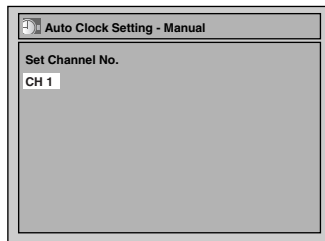

Using the Number buttons or **[▲ / ▼]**, enter the PBS channel number. Hit **[ENTER]**.

The setting will be activated.

• If you want to set the clock manually and cancel the auto clock setting:

Using **[▲ / ▼]**, select “OFF”. Hit **[ENTER]**.

The auto clock setting will be canceled.

6

Hit **[SETUP]** to exit.

7

Hit **[POWER]** to turn off the unit.

This unit will search for the clock time only when the power is off. Leave it off for several minutes to give this unit time to set the clock on the front display panel.

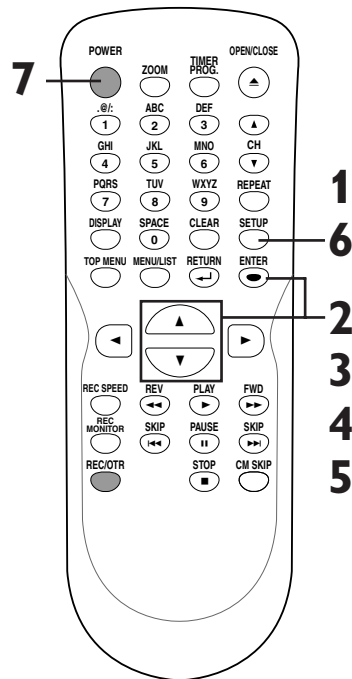

Note

- The clock may set itself automatically after you connect the antenna/cable signal to this unit and plug in the power cord. In this case, the current time will appear on the front panel display.
- If the current time is not displayed or the displayed clock time is not correct, set the clock manually.

Getting started

Setting the clock (cont'd)

Manual Clock Setting

1

Hit [SETUP] in the stop mode.

Easy Setting Menu or Advanced Setting Menu will appear.

2

Using [▲ / ▼], select "Clock". Hit [ENTER].

When entering from Advance Setting Menu, clock menu will appear.

3

When entering from Advance Setting Menu, using [▲ / ▼], select "Clock Setting". Hit [ENTER].

A clock setting window will appear.

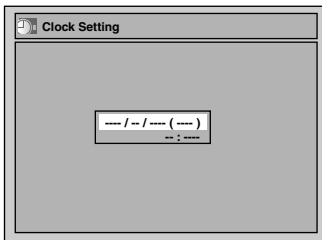

Hit [ENTER] again.
Default date will appear.

4

Using [▲ / ▼], enter the date (month / day / year).

Press [◀ / ▶] to move the cursor.

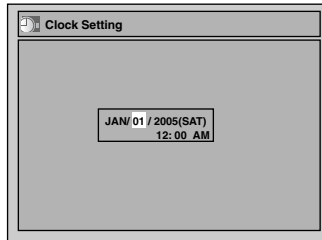

5

Using [▲ / ▼], enter the time (hour / minute). Press [◀ / ▶].

A cursor will move on AM or PM.

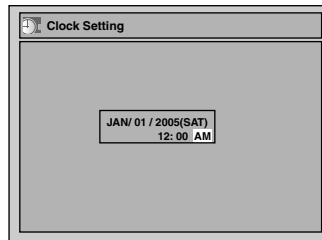

6

Press [▲ / ▼] to select "AM" or "PM". Hit [ENTER].

Clock menu will appear, then the settings will be activated. Although seconds are not displayed, they will be counted from zero.

7

Hit [SETUP] to exit.

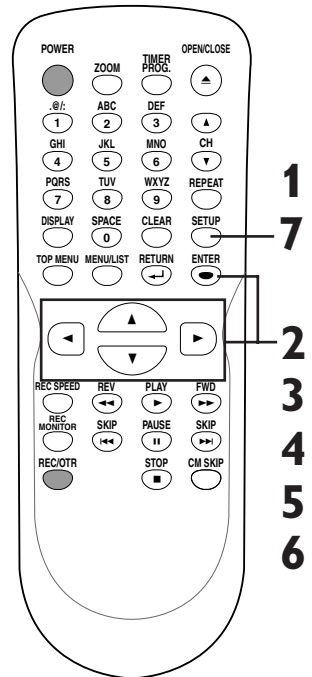

Note

- Your clock setting will be lost if either there is a power failure or this unit has been unplugged for more than 30 seconds.

Getting started

Setting the clock (cont'd)

Setting the daylight saving time

When Daylight Saving Time is ON, the unit clock will automatically move forward one hour on the first Sunday in April and move back one hour on the last Sunday in October.

1

Hit [SETUP] in the stop mode.

Easy Setting Menu or Advanced Setting Menu will appear. If Advanced Setting Menu is displayed, proceed to step 3.

2

Using [▲ / ▼], select "Advanced Setting Menu". Hit [ENTER]. Advanced Setting Menu will appear.

3

Using [▲ / ▼], select "Clock". Hit [ENTER]. Clock menu will appear.

4

Using [▲ / ▼], select "Daylight Saving Time". Hit [ENTER].

Option window will appear.

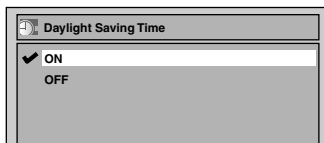

5

Using [▲ / ▼], select "ON" or "OFF". Hit [ENTER].

Choose "ON" when currently observing the daylight saving time.

6

Hit [SETUP] to exit.

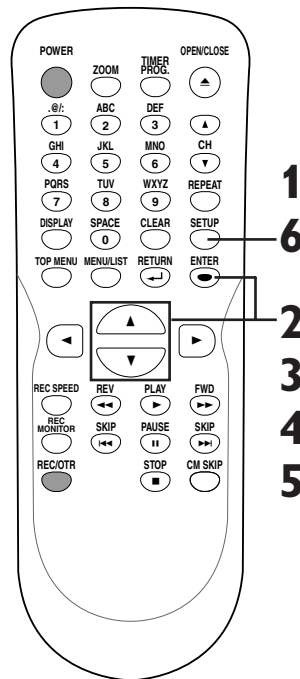

Selecting the TV aspect ratio

You can select the TV aspect ratio to match the formats of what you are playing back on the unit and your TV screen (4:3 standard or 16:9 widescreen TV). The default is set as "4:3 Letter Box".

1

Hit [SETUP] in the stop mode.

Easy Setting Menu or Advanced Setting Menu will appear. If Advanced Setting Menu is displayed, proceed to step 3.

2

Using [▲ / ▼], select "Advanced Setting Menu". Hit [ENTER].

Advanced Setting Menu will appear.

3

Using [▲ / ▼], select "Playback". Hit [ENTER]. Playback menu will appear.

4

Using [▲ / ▼], select "TV Aspect". Hit [ENTER].

Option window will appear.

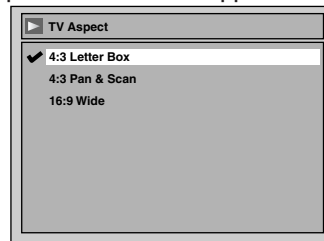

Refer to the Note on this page.

5

Using [▲ / ▼], select a desired option. Hit [ENTER].

6

Hit [SETUP] to exit.

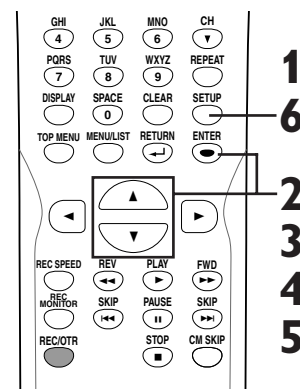

Note

If you have a standard TV:

Select "4:3 Letter Box", so that black bars appear on the top and bottom of the screen. Select "4:3 Pan & Scan" for a full height picture with both sides trimmed.

If you have a widescreen TV:



Select "16:9 Wide".

Recording

Information on DVD recording

Information





This unit can record on DVD-R and DVD-RW discs. DVD-R discs allow you to record programs only once. DVD-RW discs allow you to record programs repeatedly, and the recorded contents can be erased. You can record programs on DVD-R discs only in Video mode, while recording format for DVD-RW discs can choose either Video mode or VR mode.

Logo	Attributes
	8cm/12cm, single-sided, single layer disc Approx. max. recording time (SEP mode): 600 minutes (4.7GB) (for 12cm)
DVD-RW	180 minutes (1.4GB) (for 8cm)
	8cm/12cm, single-sided, single layer disc Approx. max. recording time (SEP mode): 600 minutes (4.7GB) (for 12cm)
DVD-R	180 minutes (1.4GB) (for 8cm)

Recordable disc

- **Discs can be used with this recorder:**
DVD-R: up to 16x (4x disc is recommended)
DVD-RW: 2x and 4x (2x disc is recommended)
- **Discs that have been tested and are proven to be compatible with this recorder:**
MAXELL DVD-R TDK DVD-RW 2x
JVC DVD-RW 4x MITSUBISHI DVD-R 8x
- **About Video mode and VR (Video Recording) mode:**
Video mode is the same recording format as DVD-Video discs purchased locally and played back on most DVD players.
To play back the disc on other DVD players, you will need to finalize the disc (see page 35). Before finalization, you can record additionally or edit disc with this unit.
VR (Video Recording) mode is a basic recording format for DVD-RW. You can edit, record and delete repeatedly.

DVD players with **RW COMPATIBLE** are capable of playing DVD-RW recorded in VR mode.

Disc type	Disc format	Functions
	Video mode 	Playback, limited recording, limited editing
DVD-RW	VR mode 	Playback, recording, Original/Playlist editing
	Video mode 	Playback, limited recording, limited editing
DVD-R		

Recording speed

You can select a recording speed among 6 options. The recording time will depend on the recording speed you select as follows.

Disc Size	Recording speed	Recording time *	Video/Sound Quality
8cm Disc	XP (1H)	18 min	☆☆☆☆☆☆
	SP (2H)	36 min	☆☆☆☆☆
	LP (4H)	72 min	☆☆☆☆
	EP (6H)	108 min	☆☆☆
	SLP (8H)	144 min	☆☆
	SEP (10H)	180 min	☆
12 cm Disc	XP (1H)	60 min	☆☆☆☆☆☆
	SP (2H)	120 min	☆☆☆☆☆
	LP (4H)	240 min	☆☆☆☆
	EP (6H)	360 min	☆☆☆
	SLP (8H)	480 min	☆☆
	SEP (10H)	600 min	☆

- * The recording time are estimates and actual recording time may differ.
- * The audio and video quality is getting poorer as the recording time becomes longer.
- * Each time **[REC SPEED]** is hit, allowed recording time will be displayed.

Note

- **This recorder cannot record on CD-RW or CD-R discs.**
- DVD-RW/R and CD-RW/R discs recorded on a personal computer or a DVD or CD recorder may not be played back if the disc is damaged or dirty or if there is dirt of condensation on the player's lens.
- If you record a disc using a personal computer, there are cases in which it may not be played back because of the settings of the application software used to create the disc, even if it is recorded in a compatible format. (Check with the software publisher for more detailed information.)
- Discs recorded in Video mode on this unit cannot record additionally using other DVD recorders.
- A DVD-RW disc formatted with this unit cannot be used on other DVD recorders.
- Since the recording is made by the variable bit rate (VBR) method, the actual remaining time for recording may be a little shorter than the remaining time displayed on the OSD, depending on the picture you are recording.

Information on DVD recording (cont'd)

Restrictions on recording

You cannot record copy-protected material using this unit. Copy-protected material includes DVD-Video discs and some satellite broadcasts.

If copy-protected material is encountered during a recording, recording will pause or stop automatically and an error message will be displayed onscreen. Material that is "copy-once only" can only be recorded using a DVD-RW disc in VR mode with CPRM (see below).

When recording a TV broadcast or through an external input, you can display copy control information on screen.



What is "CPRM"?

This is a format used to record copy-once programs. By recording coded data on the area of DVD discs that ordinary writing software cannot write on, it prevents copy-once programs from being recorded repeatedly on different media.

This unit is CPRM compatible, which means that you can record copy-once broadcast programs, but then you cannot make a copy of those recordings. CPRM recordings can only be made on DVD-RW discs formatted in VR mode, and CPRM recordings can only be played back on DVD players that are specifically compatible with CPRM.

Information on copy control

Some satellite broadcasts include copy-protected information. For recording these, refer to the following.

Disc type / format	Copy-free	Copy-once	Copy-prohibited
 ver.1.1,1.2 ver.1.1,1.2 CPRM compatible	☆	—	—
	☆	☆	—
 ver.1.1,1.2 ver.1.1,1.2 CPRM compatible	☆	—	—
	☆	—	—
 ver.2.0	☆	—	—

☆ Recordable

— Not Recordable

Making discs playable in other DVD player (Finalize)

After recording, you must finalize the disc in order to play back on other units. (Refer to page 35.)

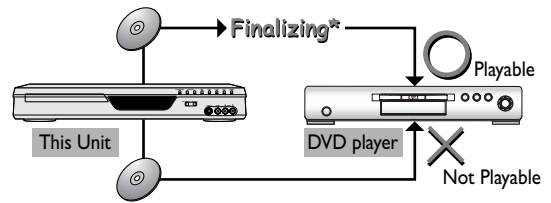

* You cannot finalize discs in other DVD recorders.

After finalizing:

- Once DVD-RW/R (Video mode) is finalized, you cannot record additionally or edit.
- DVD-RW disc recorded with VR mode can record additionally and edit contents even after you finalized the disc.
- When DVD-RW/R (Video mode) is finalized, title menu will be created automatically.

Finalize discs recorded on this unit in order to play them back on other DVD players.

Recording

Formatting a disc

Choosing the recording format of a blank disc



When inserting a blank disc, the unit starts to initialize it automatically.

After that, you can record on the disc with a recording format selected in the Setting menu. You can set specific time points for chapter marks.

1
Hit **[SETUP]** in the stop mode.

Easy Setting Menu or Advanced Setting Menu will appear. If Easy Setting Menu is displayed, proceed to step 3.

2 (Advanced Setting Menu only)

Using **[▲ / ▼]**, select **“Recording”**. Hit **[ENTER]**. Recording menu will appear.

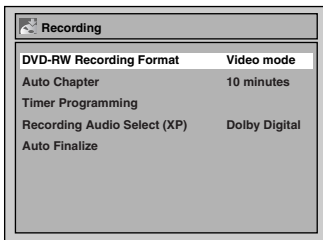

3
Using **[▲ / ▼]**, select **“DVD-RW Recording Format”**. Hit **[ENTER]**.

Option window will appear.

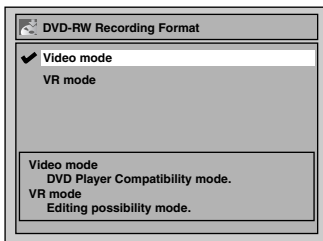

The default is set as “Video mode”.

4

Using **[▲ / ▼]**, select **“Video mode”** or **“VR mode”**. Hit **[ENTER]**.

The recording format will be set.

5 (Advanced Setting Menu only)

Using **[▲ / ▼]**, select **“Auto Chapter”**. Hit **[ENTER]**.

Option window will appear.

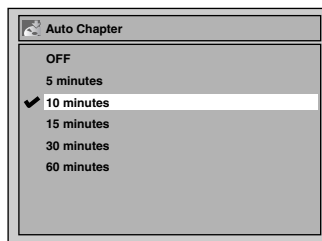

The default is set as “10 minutes”.

6 (Advanced Setting Menu only)

Using **[▲ / ▼]**, select a desired time option. Hit **[ENTER]**.

Chapter marks will be put as you specified.

7

Hit **[SETUP]** to exit.

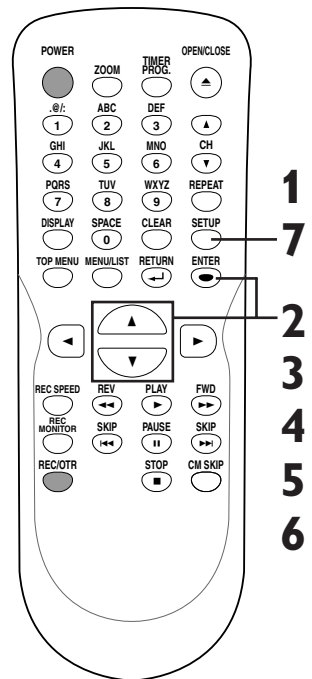

Note

- The recording format setting is effective only for DVD-RW discs. You cannot change the recording format on a DVD-R disc. DVD-R discs will always be in Video mode.
- You cannot mix two formats on one DVD-RW disc. When you load a disc once recorded before, the recording format cannot be changed even if you change it in the Setting menu.
- When inserting a blank DVD+R or DVD+RW disc, the error message (“Disc Error”) will appear. This unit is not compatible with a DVD+RW/R disc.
- PLAYLIST will be created automatically when recording on DVD-RW in VR mode.
- In Video mode, Auto Chapter may not show up as you specified.
- A blank chapter may be created depending on the remaining time of the disc.

Reformatting a disc



Video mode is set as the default recording format for DVD-RW. You can change it to VR mode from the Setting Menu.

1
Hit [SETUP] in the stop mode.

Easy Setting Menu or Advanced Setting Menu will appear.

2
Using [▲ / ▼], Select "Disc". Hit [ENTER].

Disc menu will appear.

3
Using [▲ / ▼], select "Format". Hit [ENTER].

Confirmation window will appear.

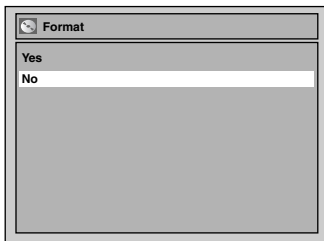

4
Using [▲ / ▼], select "Yes". Hit [ENTER].

Final confirmation window will appear.

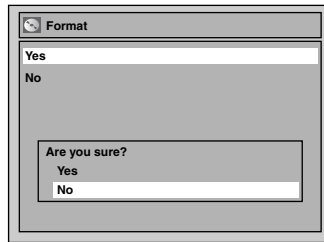

5
Using [▲ / ▼], select "Yes". Hit [ENTER].

Formatting will start.

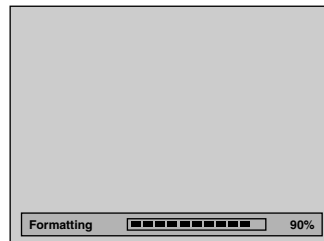

6
Formatting is complete. 100% will be indicated.

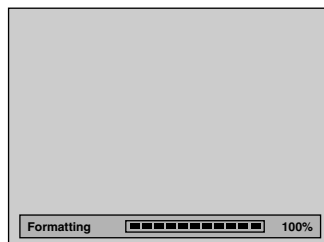

This operation may take a while to be completed.

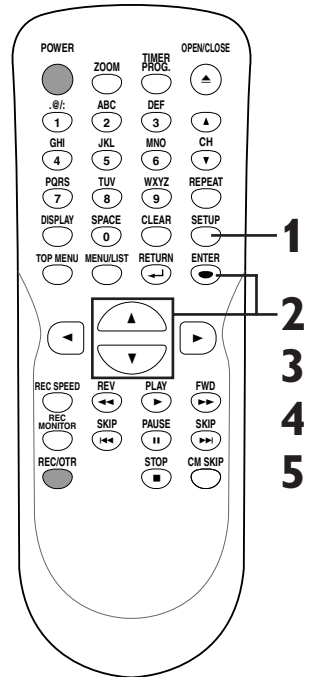

Note

- When you reformat the disc, all contents of the disc will be erased.
- If you want to cancel format at step 3 or 4, select "No".

Recording

Basic recording



Follow steps below to record TV programs.

1

Turn on the unit. Load a recordable disc.

Make sure that the TV input is set on the unit.

This operation may take a while to be recognized.

2

Using [REC SPEED], select a recording speed.



Refer to "Recording speed" on page 24.

3

Make sure that the recording format is set to the desired mode.

Refer to "Formatting a disc" on pages 26-27.

When a DVD-RW disc is loaded:

You can choose Video mode or VR mode from the Setting menu.

Checking the recording picture and sound quality



You can confirm the recording picture and sound quality with the recording speed you have selected before attempting to record to a DVD disc.

1

While in STOP or REC, hit [REC MONITOR].

The TV program will be on the screen in the recording picture quality and the sound will be output in the recording sound quality with the recording speed you have selected.

"Video mode" has been selected as the default. Refer to "Choosing the recording format of a blank disc" on page 26.

When a DVD-R disc is loaded: DVD-R discs will always be in Video mode.

4

Using [CH ▲ / ▼] or the Number buttons, select a desired channel to record.



5

Hit [REC/OTR] to start recording.

"•" mark will be displayed for 5 seconds.



Hit [PAUSE II] to pause. Hit [REC/OTR] (or [PAUSE II]) to resume.

6

Hit [STOP ■] to stop recording.

This operation may take a while to be completed.



Hit [REC SPEED] repeatedly to change the recording speed.

The recording speed will be changed as you hit the button as shown below. Refer to "Recording speed" on page 24.

• You cannot change the recording speed during recording.

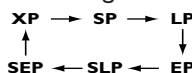

2

Hit [REC MONITOR] again to exit.

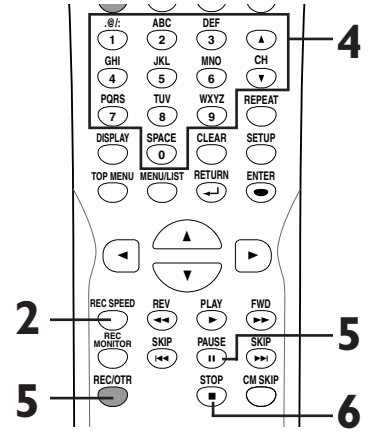

Note

- Recording starts immediately after you hit [REC/OTR] and continues until the disc is full or you stop recording.
- When the clock setting has not been made, the space for a date and time of title names in the Original or Playlist will be blank.
- When you record a TV program which has Stereo and SAP audio on a DVD-RW/R, you have to select the TV channel audio (Stereo or SAP) beforehand. Only the selected channel audio will be recorded. Refer to "Selecting the TV stereo or SAP" on page 20 for more details.
- **You cannot mix two formats on one DVD-RW disc.** When you load a disc once recorded before, the recording format cannot be changed even if you change it in the Setting menu.
- You cannot change the recording speed during the REC pause mode.
- You can change a channel during the REC pause mode.

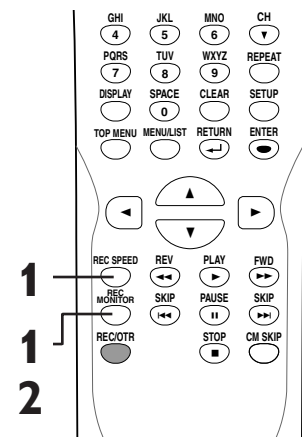



This is a simple way to set the recording time in blocks of 30 minutes. Check that the disc you are recording onto has enough space for the time you set. After finishing the recording, the recorder automatically goes into standby.

1

Turn on the unit and load a recordable disc.

Make sure that the TV input is set on the unit.

This operation may take a while to be recognized.

2

Using [REC SPEED], select a recording speed.

Refer to "Recording speed" on page 24.

3

Make sure that the recording format is set to the desired mode.

Refer to "Formatting a disc" on pages 26-27.

When a DVD-RW disc is loaded:

You can choose Video mode or VR mode from the Setting menu. "Video mode" has been selected as the default. Refer to page 26 "Choosing the recording format of a blank disc."

When a DVD-R disc is loaded:
DVD-R discs will always be in Video mode.

4

Using [CH ▲ / ▼] or the Number buttons, select a desired channel to record.

5

Hit [REC/OTR] repeatedly to select a desired recording time. Recording times appear on the TV screen (30 minutes to 4 hours). Recording will start.

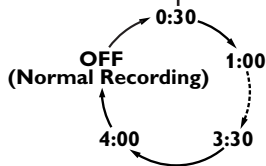

When the unit reaches the specified time, it will be turned off automatically.

To change the recording time during the One-touch Timer Recording, hit [REC/OTR] repeatedly until the desired time appear.

To cancel the One-touch Timer Recording within the specified time, hit [STOP ■] .

This operation may take a while to be completed.

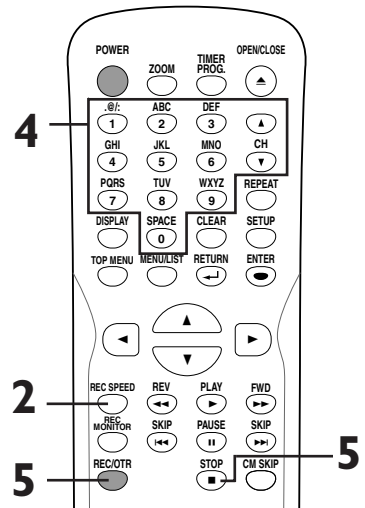

Note

- The remaining recording time will appear on the display panel during an One-touch Timer Recording. Hit [DISPLAY] to see it on the TV screen.
- You cannot pause a One-touch Timer Recording.
- Unlike a Timer Recording, you can perform the following operations during a One-touch Timer Recording.
 - Turning off the power.
 - Using [REC/OTR] and [STOP ■].
- The unit will be turned off automatically under the following conditions.
 - 1) No space remained on the disc.
 - 2) When a power failure occurs.
- When OTR is finished and the power is turned off, the unit will switch to the standby mode automatically if a Timer Recording has been programmed. Hit [POWER] to cancel the standby mode for using the unit continuously.

Recording

Timer Recording



You can program the unit to record up to 8 programs within a month in advance. Daily or weekly program recordings are also available.

- Be sure to set the clock before programming a timer recording.
- Insert a recordable disc.

1 Hit [SETUP].

Easy Setting Menu or Advanced Setting Menu will appear. If Easy Setting Menu is displayed, proceed to step 3.

2 (Advanced Setting Menu only)

Using [▲ / ▼], select "Recording". Hit [ENTER]. Recording menu will appear.

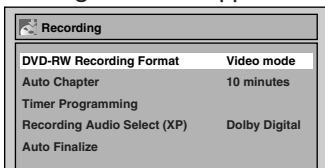

3 Using [▲ / ▼], select "Timer Programming". Hit [ENTER].

Timer Programming list will appear.

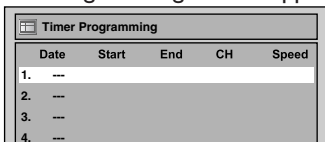

4 Using [▲ / ▼], select a program number. Hit [ENTER].

5 Using [▲ / ▼], enter the date. Hit [▶].

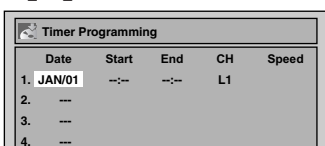

When hitting [▼] at the current date, Timer Recording mode will change as follows.

e.g. January 1st

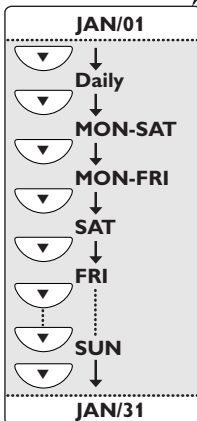

6 Using [▲ / ▼], enter start and end. Hit [▶].

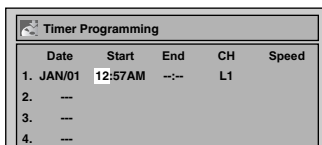

7 Using [▲ / ▼], select the channel number to record. Hit [▶].

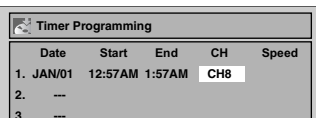

To record from external input, select L1 or L2.

8 Using [▲ / ▼], select a recording speed.

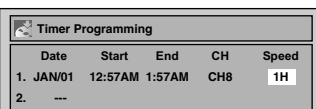

Refer to "Recording speed" on page 24.

You can choose the timer programming menu by hitting [TIMER PROG.]. In this case, continue with step 4.

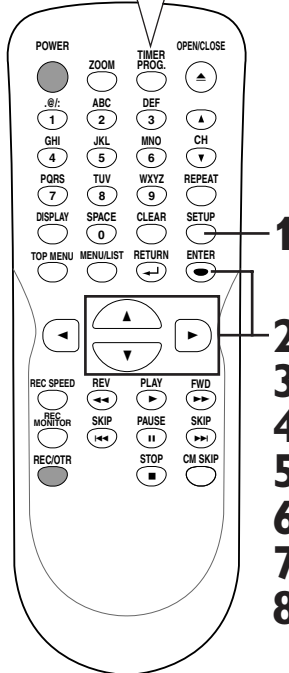

Note

- If you have not set the clock yet:
A clock setting window will appear after step 3. Continue with step 4 in "Auto Clock Setting" on page 21 or "Manual Clock Setting" on page 22 before setting a timer programming.
- Press [◀ / ▶] to move the cursor to the left and the right on the timer programming menu.
- After step 10, the recording will start immediately before the recording time you set.

Recording

Timer Recording (cont'd)

- 9** Hit **[ENTER]** when information is entered. Your program setting will be stored.
- To set another program, repeat steps 4 to 9.
 - To exit, hit **[SETUP]**.
 - When programs are overlapped, "Overlap" and the overlapped program number will appear on the display.

- 10** Hit **[POWER]** to turn off. **Ⓢ** indicator will appear on the front display.

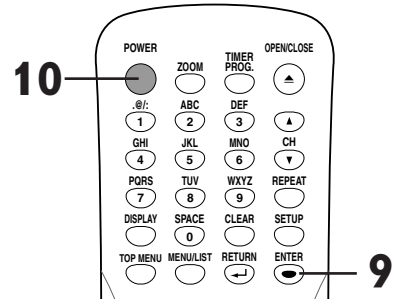

Checking, canceling, or correcting the timer programming information

- 1** Hit **[POWER]**. **Ⓢ** indicator disappears from the front display.

- 2** Hit **[TIMER PROG.]**. Timer Programming list will appear.

Timer Programming					
Date	Start	End	CH	Speed	
1.	---				
2.	---				

- 3** Check the information on the list you will need.

- 4** To clear the timer programming: Using **[▲ / ▼]**, select your desired program. Hit **[CLEAR]**.

- To correct the timer programming: Using **[▲ / ▼]**, select your desired program. Hit **[ENTER]**. Next, correct the timer programming by using **[▲ / ▼ / ◀ / ▶]**. Finally, hit **[ENTER]** again.

- 5** Hit **[TIMER PROG.]** to exit.

- 6** Hit **[POWER]** to return to the timer standby mode.

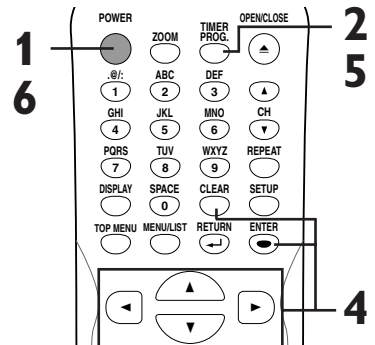

Note

- When all the Timer Recording is completed, the **Ⓢ** indicator flashes. To play or eject the recorded disc, hit **[POWER]** first and then press **[PLAY ▶]** or **[OPEN/CLOSE ▲]**.
- Hit **[TIMER PROG.]** to check the timer programming in progress.
 - When a Timer Recording is in progress, that program will be red highlighted. In this case, you cannot select any other programs.
- The unit will be turned on automatically before the recording time.

To stop the Timer Recording in progress

- Hit **[STOP ■]** on the front panel of the unit. **[STOP ■]** on the remote control is not effective.

If the timer program did not complete correctly, the error number appears on the timer programming list.

Timer Programming					
Date	Start	End	CH	Speed	
*JAN01	12:57AM	1:57AM	CH8	E22	
2.	---				
3.	---				
4.	---				
5.	---				
6.	---				
7.	---				
8.	---				

Each error number means:

- | | | | |
|---------------|----------------------------------|-----|---|
| E1-22, E37-39 | Recording error other than below | E35 | PCA full |
| E23-24 | Unrecordable disc | E36 | Already finalized Video format disc |
| E25-28 | Copy prohibited program | E40 | Some portion has not been recorded because of program overlapping. Recording did not start at the start time. |
| E29 | Disc protected | E41 | Power failed |
| E30 | Disc full | E42 | No disc when recording |
| E31-32 | Already 99 titles recorded | | |
| E33 | Already 999 chapters recorded | | |
| E34 | No space for Control information | | |





- Hit **[CLEAR]** to erase the selected program.

- A program with the error number is highlighted with gray and labeled with an asterisk in the timer programming list.
- Once the timer programming list with error indication is displayed, the program line(s) with error will be cleared only after the programs are cancelled and reset to the timer standby mode.

Recording

Timer Recording (cont'd)

Hints for Timer Recording

- If there is a power failure or this unit has been unplugged for more than 30 seconds, the clock setting and all timer settings will be lost.
- If a recordable disc is not on the tray, the  indicator flashes and Timer Recording cannot be performed. In some cases, the  indicator appears momentarily around the start point as the unit attempts to record. Please insert a recordable disc.
- When all the Timer Recording is completed, the  indicator flashes. To play or eject the recorded disc, hit **[POWER]** first, and then press **[PLAY▶]** or **[OPEN/CLOSE ▲]**.
- During Timer Recording or timer standby ( indicator is on the front display), any operations on the unit will not be available. To make these operations available, cancel the Timer Recording or timer standby first ( indicator disappears).
- To cancel the timer standby mode, hit **[POWER]**.
- When the Start and the End time are the same, the length of the recording will be set for 24 hours.
- When the disc reaches at the end during the Timer Recording, the unit turns itself off.
- When the programmed Start and End time are earlier than the current time, the setting will not be accepted and be cleared for redoing.
- If the Start time is earlier and the End time is later than the current time, the recording will start right after you hit **[POWER]**.

The priority of overlapped settings

This unit records the programs according to priority if the timer programmings are overlapped. The timer programming set previously has priority.

A Timer Recording of lower priority will be canceled, start from the middle or stop on the way. Check the overlapped timer programmings and change the priority if necessary.

■ A programming set previously has priority

□ When the starting time is same:

A program set previously (PROG. 1) has priority.

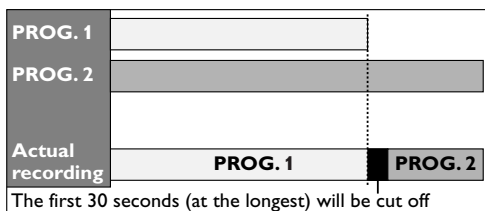

□ When some programming have been made at the end time of the programming currently being recorded:

A program set previously (PROG. 2) has priority.

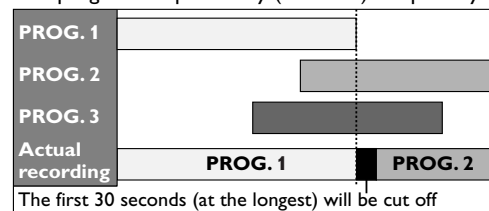

■ When the recording time is partially overlapped: PROG. 1 will start after PROG. 2 is complete to be recorded.

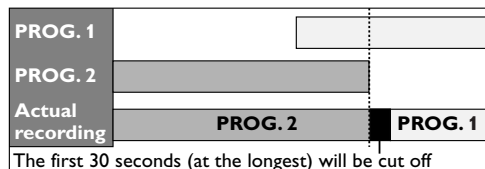

■ When the recording time is entirely overlapped: PROG. 1 will not be recorded.

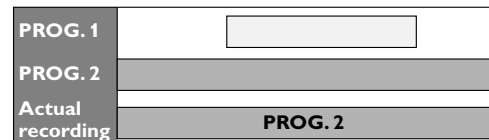

Note for DVD recording

- When the recording time of two programs are overlapped, or the End time of a program and the Start time of another is the same, the first 30 seconds (at the longest) of the subsequent program will be cut off.
- If the cut-off portion comes up to one minute or more, this program will be displayed with error number E40 in the timer programming list.

■ When the End time of the programming currently being recorded and the Start time of the subsequent program are same:

If PROG. 1 is a DVD recording program, the beginning of the PROG. 2 may be cut off.

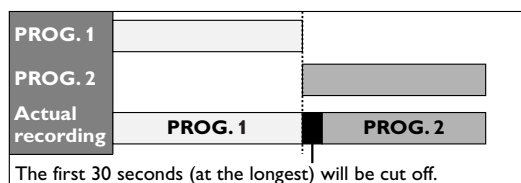

Settings for an external source

Connection to an external source



Connect the external source properly to the unit by using input jacks either LINE2 (Front) or LINE1 (Rear). When connecting an external equipment of monaural output to this unit, use AUDIO L jack of LINE2 (Front). Use commercially available S-Video or Video cable and an Audio cable for this type of connection.

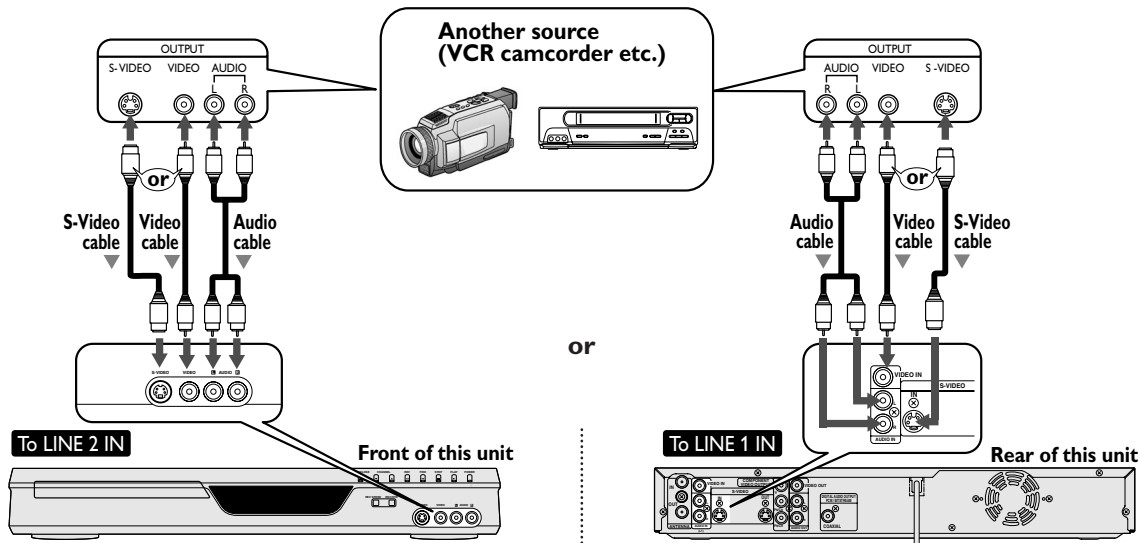

1. Hit [SETUP] to display Easy Setting Menu or Advanced Setting Menu.
If Advanced Setting Menu is displayed, proceed to step 3.
2. Using [▲ / ▼], select "Advanced Setting Menu". Hit [ENTER].
3. Using [▲ / ▼], select "Select Video". Hit [ENTER].

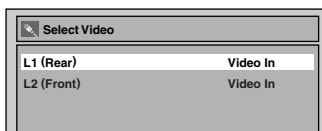

4. Using [▲ / ▼], select "L2 (Front)". Hit [ENTER].

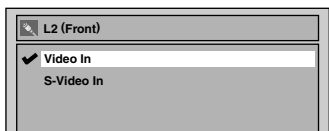

5. Using [▲ / ▼], select the input jack type to connect. Hit [ENTER].
If you want to use S-VIDEO input, select "S-Video In".
If you want to use VIDEO input (Composite), select "Video In".

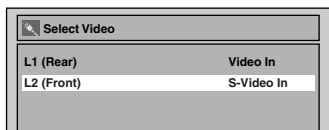

4. Using [▲ / ▼], select "L1 (Rear)". Hit [ENTER].

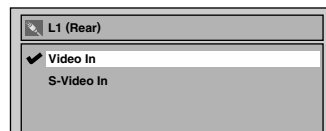

5. Using [▲ / ▼], select the input jack type to connect. Hit [ENTER].
If you want to use S-VIDEO IN, select "S-Video In".
If you want to use VIDEO IN (Composite), select "Video In".

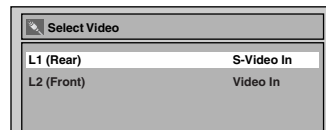

Recording

Settings for an external source (cont'd)

Recording from an external source



Before recording from an external source, see the instructions for the connection on page 33.

1. Turn on the TV and the unit and be sure to select the input of the TV to which the unit is connected.

Refer to the table on page 13.

2. Hit [OPEN/CLOSE ▲] to open the disc tray. Place the disc to record properly.

3. Hit [OPEN/CLOSE ▲] to close the disc tray.

This operation may take a while to be recognized.

4. Select the input of the unit which the external equipment is connected. (L2 or L1)

- To use the input jacks on the back of this unit, select "L1" position by pressing [0], [0], [1] on the remote control or [CHANNEL ▼ / ▲].
- To use the input jacks on the front of this unit, select "L2" position by pressing [0], [0], [2] on the remote control or [CHANNEL ▼ / ▲].

5. Select a recording speed by hitting [REC SPEED].

Refer to "Recording speed" on page 24.

6. Hit [REC/OTR] on the unit to start recording.

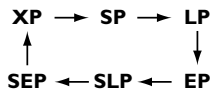

7. Press "Play" on the external source to record from.

8. Hit [STOP ■] on the unit to stop recording.

This operation may take a while to be completed.

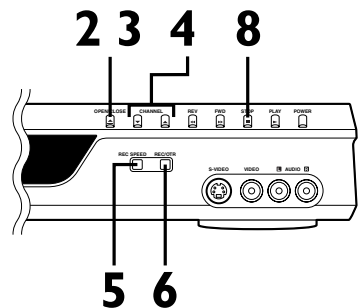
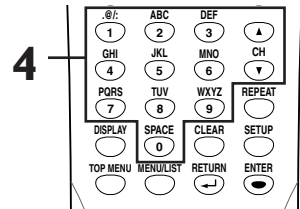

Setting a disc to protect



To prevent accidental recording, editing or erasing of the titles, you can protect them from the Setting menu.

1
Hit [SETUP] in the stop mode.

Easy Setting Menu or Advanced Setting Menu will appear.

2
Using [▲ / ▼], select "Disc".
Hit [ENTER].

Disc menu will appear.

3
Using [▲ / ▼], select "Disc Protect OFF → ON". Hit [ENTER].

Confirm window will appear.

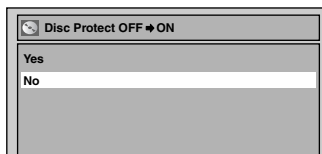

4
Using [▲ / ▼], select "Yes".
Hit [ENTER].

A disc will be protected.



This operation may take a while to be completed.

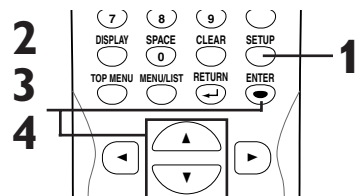

Note

- The Disc Protect setting is available only for a DVD-RW disc recorded in VR mode.
- You can select only Disc Protect off when a protected disc is inserted.

To cancel the disc protect:

- When you insert a disc protected with this unit, "Disc Protect ON → OFF" will appear .

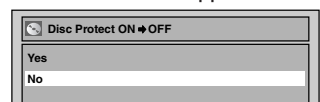

To reverse the protection for the disc, select "Disc Protect ON → OFF" at step 3, then select "Yes".

Recording

Finalizing the discs



You will need to finalize discs recorded in Video mode to play back on other DVD players. Finalizing may take several minutes up to an hour. (It can take up to 15 minutes for a disc recorded in Video mode and 60 minutes for a disc recorded in VR mode.)

A shorter recording period on the disc will require a longer time period for finalization. Do not unplug the power cord during finalization. Details are on pages 25.

1

Hit **[SETUP]** in the stop mode.

Easy Setting Menu or Advanced Setting Menu will appear.

2

Using **[▲ / ▼]**, select “Disc”. Hit **[ENTER]**.

Disc menu will appear.

3

Using **[▲ / ▼]**, select “Finalize”. Hit **[ENTER]**.

Confirmation window will appear.

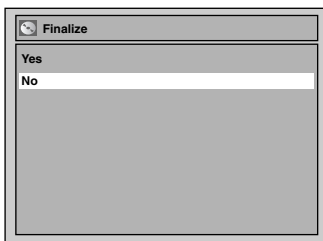

4

Using **[▲ / ▼]**, select “Yes”. Hit **[ENTER]**.

Finalizing will start.



To cancel finalizing...

(DVD-RW only)

- To cancel finalizing at step 4, hit **[STOP ■]**, select “Yes”, then hit **[ENTER]**. Finalizing is cancelled and the unit will be in stop mode.

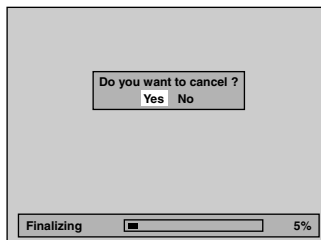

- If **⊙** appear when hitting **[STOP ■]**, you cannot cancel finalizing because the finalizing has progressed a certain point.
- When selecting “No” and press **[ENTER]** or **[RETURN ↵]**, finalizing will be continued.
- You cannot cancel finalizing the DVD-R disc once it has started.

This operation may take a while to be completed.

5

Finalizing is complete.

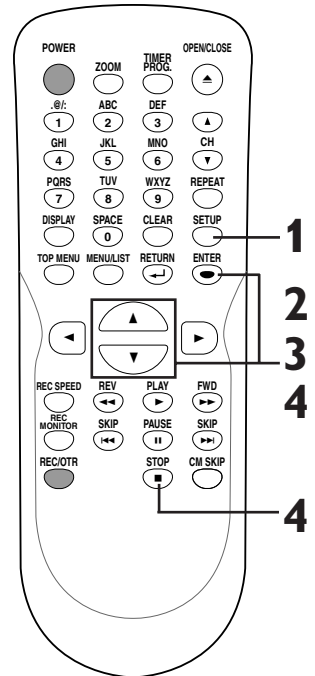
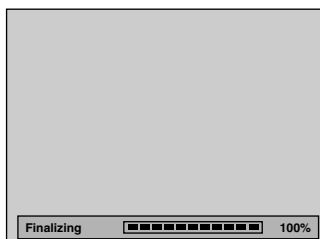

Note

- Finalizing discs in Video mode automatically creates title menus.
- Once you have finalized a disc recorded in Video mode, you cannot edit or record anything else on that disc. Discs recorded in VR mode can still be recorded and edited on this recorder even after finalization.
- When you insert a DVD-RW disc finalized with this unit, “Undo Finalize” will appear instead of “Finalize”.

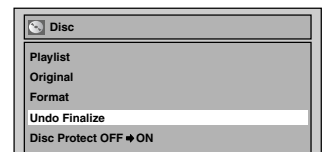

To reverse the finalization of the disc, select “Undo Finalize” at step 3.

*DO NOT power off during finalization. This will result in malfunction.

Recording

Finalizing the discs (cont'd)

Auto finalize



This function automatically finalizes discs after finishing all Timer Recordings and when the disc space runs out.

.....
1

Hit [SETUP] in the stop mode.

Easy Setting Menu or Advanced Setting Menu will appear.
If Easy Setting Menu is displayed, proceed to step 3.

.....
2 (Advanced Setting Menu only)

Using [▲ / ▼], select "Recording". Hit [ENTER].

Option window will appear.

.....
3

Using [▲ / ▼], select "Auto Finalize". Hit [ENTER].

Option window will appear.

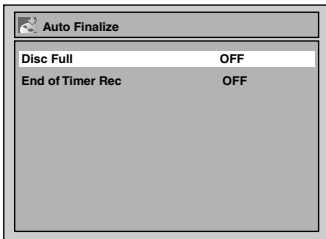

.....
4

Using [▲ / ▼], select "Disc Full" or "End of Timer Rec".

Hit [ENTER].

Option window will appear.

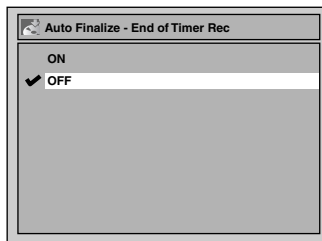
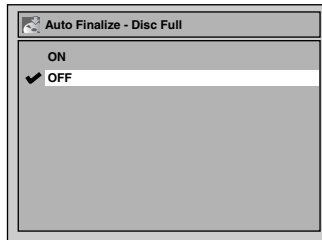

.....
5

Using [▲ / ▼], select "ON".

Hit [ENTER].

Your setting will be activated.

.....
6

Hit [SETUP] to exit.

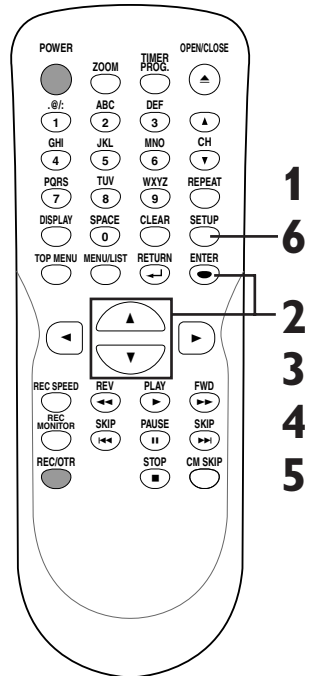

Note

- Auto Finalize is not available for VR format discs.

Disc Playback

Information on DVD playback

Before you play back DVD discs, read the following information.

Playable discs

This unit is compatible with the following discs. To play back a DVD, make sure that it meets the requirements for Region Codes and Color Systems as described below. Discs with the following logos can be played back on the unit. Other Disc types are not guaranteed to be played back.

Disc	Logo
DVD-VIDEO	
DVD-RW (VIDEO/VR mode)	
DVD-R (VIDEO mode)	
CD-DA (AUDIO CD)	
CD-RW (CD-DA FORMAT, MP3 files)	
CD-R (CD-DA FORMAT, MP3 files)	

DVD is a trademark of DVD Format/Logo Licensing Corporation.

Color systems

DVDs are recorded in different color systems throughout the world. The most common color system is NTSC (which is used primarily in the United States and Canada).

This unit uses NTSC, so DVDs you play must be recorded in the NTSC system. You cannot play back DVDs recorded in other color systems.

Region codes

This unit has been designed to play back DVD discs with Region One (1). DVDs must be labeled for ALL regions or for Region 1 in order to be played back on the unit. You cannot play back DVDs labeled for other regions. Look for the symbols below on your DVDs. If these region symbols are not on your DVD, you cannot play back the DVD in this unit.



The number inside the globe refers to region of the world.

A DVD labeled for a specific region can only be played back on the unit with the same region code.

Hint for DVD playback

The contents of DVD disc are generally divided into titles. Titles may be further subdivided into chapters.

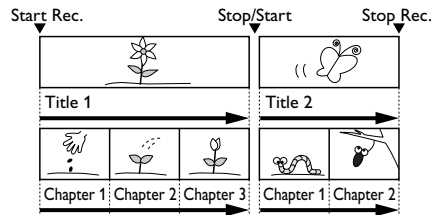

Guide to displays

Hit **[DISPLAY]** to call up the display menu. This menu will give you the information on the disc currently played back. Some operations are available during disc playback.

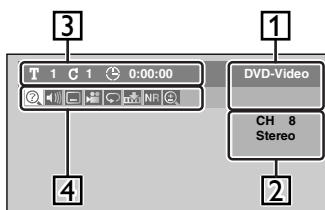

Note:

- This is an example screen only for explanation. Displayed items will change depending on the actual mode.
- DISPLAY function is not available when no disc is inserted.

1. Indicates a disc type and a format mode.
2. Indicates a channel number and the audio status.
3. Indicates a title number, chapter number and the time lapse of disc playback.

4. Each icon means:

- : Search
- : Audio
- : Subtitle
- : Angle (except VR mode)
- : Repeat
- : Marker
- : Noise Reduction
- : Zoom

Disc Playback

Basic playback

Playback



1

Hit **[POWER]**.

When you are playing a DVD, turn the TV on and be sure to select the input to which the unit is connected.

2

Hit **[OPEN/CLOSE ▲]**.

The disc tray will open.

3

Insert your disc with its label facing up. Align the disc to the disc tray guide.

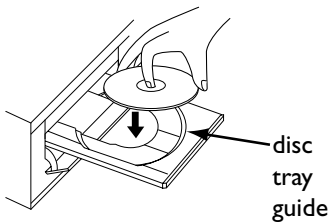

4

Hit **[OPEN/CLOSE ▲]** to close the disc tray.

This operation may take a while to be recognized.

5

Hit **[TOP MENU]** to display the title menu.

When a VR mode disc with Playlist is inserted, Playlist is displayed automatically.

You can change "Original" or "Playlist" of VR mode using **[MENU / LIST]**.

Video mode:

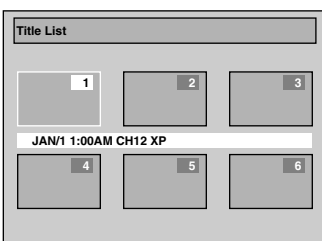

VR mode:

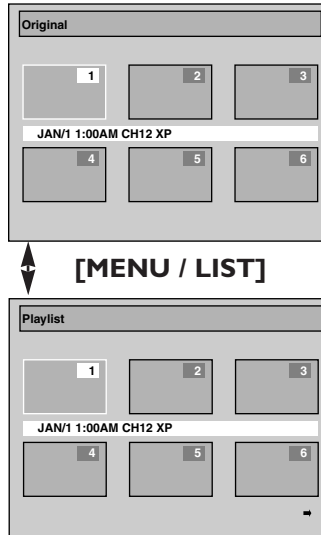

To exit the title menu, hit **[TOP MENU]** again.

6

Using **[▲ / ▼ / ◀ / ▶]**, select a desired title. Hit **[ENTER]**. Playback will start.

7

Hit **[STOP ■]** to stop playback.

To eject the disc, hit **[OPEN/CLOSE ▲]** to open the disc tray, then remove the disc before turning the unit off.

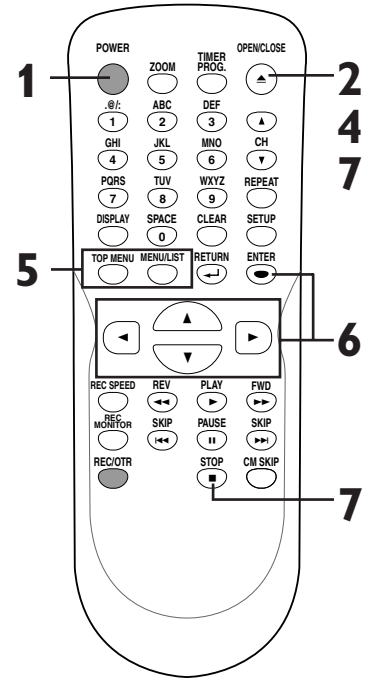

Note

- For DVD-R (Video mode) and DVD-RW (Video mode) discs which are already finalized, a title list will be displayed instead of thumbnails.

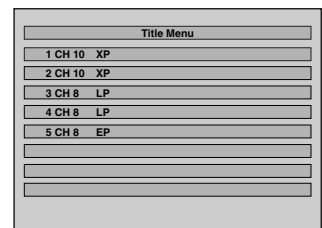

- You can resume playback from where you stopped playing the disc. (Resume playback) Refer to page 41 for details about resume playback.
- Some discs may start playback automatically.

Disc Playback

Basic playback (cont'd)



1

Hit [POWER].

When you are playing a DVD, turn the TV on and be sure to select the input to which the unit is connected.

2

Hit [OPEN/CLOSE ▲] to open the disc tray.

The disc tray will open.

3

Insert your with its label facing up. Align the disc to the disc tray guide.

4

Hit [PLAY▶] to start playback.

Playback will start.

If you are playing a DVD-Video disc, a menu may appear. Refer to page 40 for details about a disc menu.

5

Hit [STOP■] to stop playback.

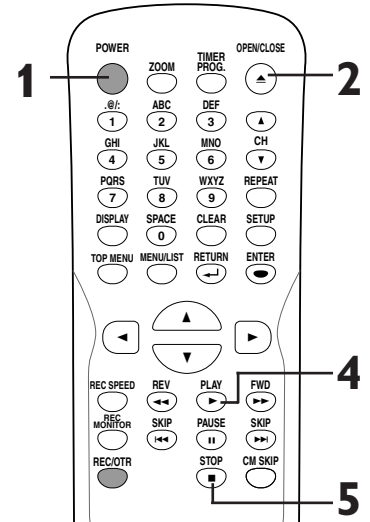

Note

- Some discs may start playback automatically.

Playing back MP3 disc



1

In stop mode, hit [TOP MENU] to call up the MP3 menu.

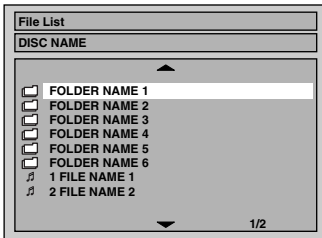

- To exit the menu, hit [TOP MENU] again.

2

Press [▲ / ▼] to select a desired folder (group) or track. Hit [ENTER].

When selecting track:
Playback will start.

When selecting the folder:
The files in folder will appear. Press [▲ / ▼] to select the track or folder you want, then hit [ENTER].

- Press [PLAY▶], [ENTER] or [▶] to move to the lower hierarchies.
- Press [◀] or [RETURN ↵] to the previous hierarchy.
- Hit [STOP■] to return to the first item.

Hints for MP3 files:

- Folders are known as Groups, files are known as Tracks.
- Folders are accompanied by folder icon.
- MP3 files are accompanied by music icon.
- Reproduction will start from the selected track and go to the next one in turn.
- The system can recognize up to 255 groups (or folders) and up to 255 tracks.
- The name of group and track can be displayed in up to 29 characters. Unrecognizable characters will be replaced with asterisks.
- If there are no files in the folder, "No Files" will be displayed.

This unit recommends the files recorded under the following circumstances:

- Sampling frequency: 44.1kHz or 48kHz.
- Constant bit rate: 112kbps - 320kbps.

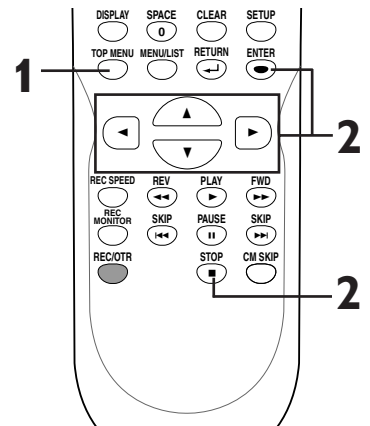

Note

- The audio source of MP3 files cannot be recorded as digital sound by an MD or DAT deck.
- Files whose extension is other than ".mp3(MP3)" will not be listed in the MP3 menu.
- Some unplayable folders or tracks may be listed in the MP3 menu due to the recording status.

Disc Playback

Basic playback (cont'd)

Playing back discs using the disc menu



A DVD disc contains a disc menu that describes the contents or allows you to customize the playback. For example, the menu may offer choices for subtitle languages, special features, or chapter selection. Some discs display them automatically when you start playback. For others, they only appear when you hit **[MENU / LIST]**.

1

Hit **[MENU / LIST]**.

The disc menu will appear.

If the feature is not available, may appear on the TV screen.

2

Using **[▲ / ▼ / ◀ / ▶]**, select an item. Hit **[ENTER]** to confirm.

Continue this step to set up all the features you want or to start playing back the disc from the menu.

MENU / LIST button:

Displays a DVD disc menu. It may be the same with the 'Title menu.'

Cursor ▲ / ▼ / ◀ / ▶ buttons:

Moves the cursor on the screen.

ENTER button:

Selects the currently highlighted menu option.

Number buttons:

Selects a numbered menu option (some discs only). (Hit **[ENTER]** after.)

3

Hit **[MENU / LIST]** to exit the disc menu.

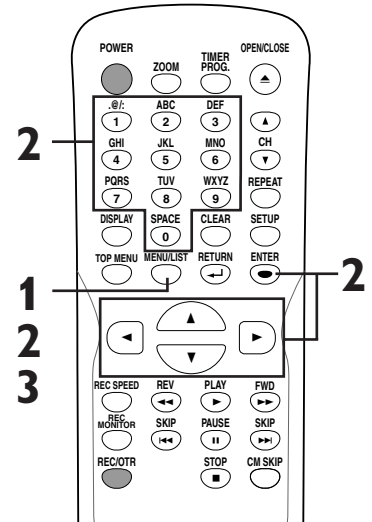

Note

- Menus vary among discs. Refer to the information accompanying the disc for details.

Playing back discs using the title menu



Some DVDs have a title menu, which lists the titles available on them. It helps you to start playback of a specific title.

1

Hit **[TOP MENU]**.

The title menu will appear.

If the feature is not available, may appear on the TV screen.

2

Using **[▲ / ▼ / ◀ / ▶]**, select a title to play. Hit **[ENTER]**.

Playback will begin at the title you selected.

TOP MENU button:

Displays the 'Title menu' of a DVD disc.

Cursor ▲ / ▼ / ◀ / ▶ buttons:

Moves the cursor on the screen.

ENTER button:

Selects the currently highlighted menu option.

Number buttons:

Selects a numbered menu option (some discs only). (Hit **[ENTER]** after.)

3

Hit **[TOP MENU]** to exit the title menu.

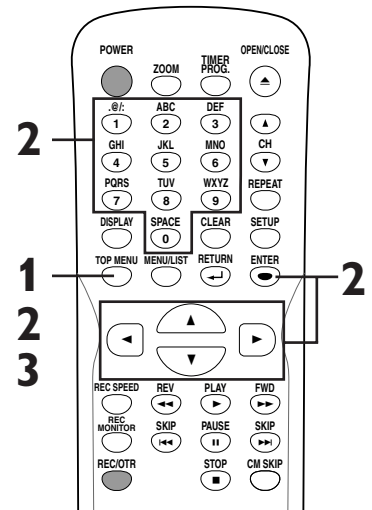

Note

- **[TOP MENU]** will not always be active with all DVDs.
- Menus vary among discs. Refer to the information accompanying the disc for details.

Disc Playback

Special playback

Resume playback



You can resume playback from where you stopped it last time.

1

During playback, hit **[STOP ■]**.
The resume message will appear.



2

Hit **[PLAY▶]**.
In a few seconds, playback will resume from the point at which it stopped last. You can resume playback at the same point even if you turn off the unit.

To cancel resuming and start disc playback from the beginning, hit **[STOP ■]** again while the play is stopped.

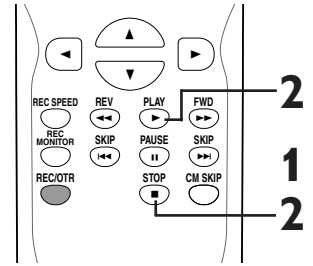

Note

- For MP3 files, playback will resume from the beginning of the track which you stopped playing back.

Fast forward / Fast reverse



1

During playback, press **[FWD▶▶]** or **[REV◀◀]**.

Every time you press **[FWD▶▶]** or **[REV◀◀]**, approximate speed will be changed as follows. For DVD discs, sound will be output during fast forward in x1.5 only if you set "Fast Forward with Audio" to "ON" at the "Playback" setting in the Setting menu.

Fast forward or fast reverse playback across titles (for DVD discs) or tracks (for MP3) is not possible.

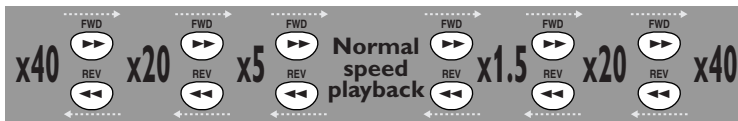

For Audio CDs, approximate speed is fixed at x8 with sound.

For MP3 files, approximate speed is fixed at x16.

To return to the normal play, hit **[PLAY▶]**.

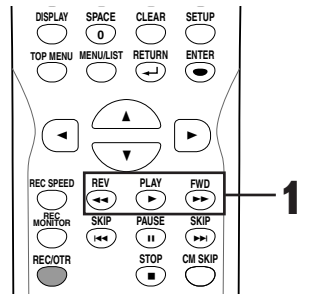

Note

- Forward/reverse speed will be indicated with icons as follows.
Forward (Approx. Speed)
x1.5: ▶▶
x20: ▶▶▶
x40: ▶▶▶▶
Reverse (Approx. Speed)
x5: ◀◀
x20: ◀◀◀
x40: ◀◀◀◀

Skipping TV commercials during playback



You can skip TV commercials by hitting **[CM SKIP]**, in order to enjoy the recorded programs without interruption.

1

During playback, hit **[CM SKIP]**.
Normal playback will start at 30-second advanced from where you hit **[CM SKIP]**.

Every time you hit **[CM SKIP]**, the playback starting point will be extended by 30 seconds ahead. You can hit up to 6 times (180 seconds).

e.g. Hit **[CM SKIP]** once



(forwarding 30 seconds.)



Playback will restart automatically.

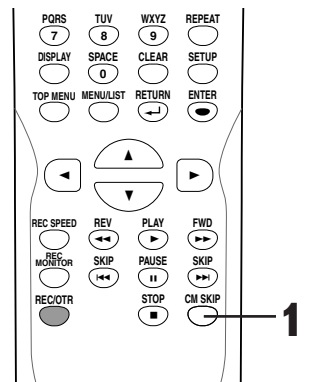

Disc Playback

Special playback (cont'd)

Pause



1

During playback, hit [PAUSE II].

Play will pause and sound will be muted.



2

Hit [PLAY ▶] to resume play.

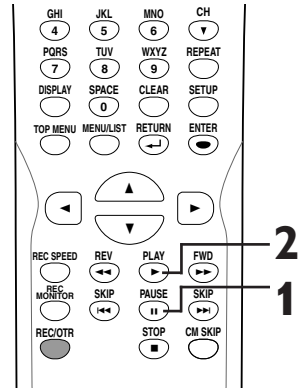

Step by step playback



1

During playback, hit [PAUSE II].

Play will pause and sound will be muted.



To play step by step backward:

Hit [SKIP ◀◀] repeatedly. Every time you hit the button, the play will go backward by one frame.

- Press and hold [SKIP ◀◀ / ▶▶] to reverse/advance continuously.

2

Hit [SKIP ▶▶] repeatedly.

The play will advance one frame (or step) at a time when you hit [SKIP ▶▶] with the sound muted.

3

Hit [PLAY ▶] to resume play.

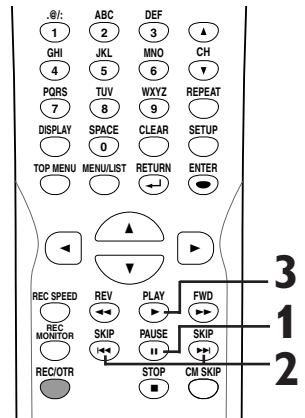

Slow forward / Slow reverse playback



1

During playback, hit [PAUSE II]. Press [FWD ▶▶] or [REV ◀◀].

Every time you press [FWD ▶▶] or [REV ◀◀], approximate speed will be changed as follows. (The sound will remain muted.)

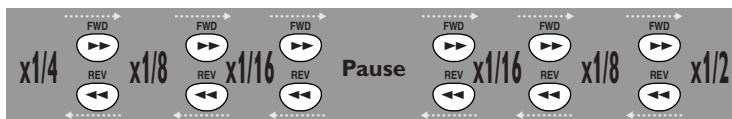

To return to the normal playback, hit [PLAY ▶].

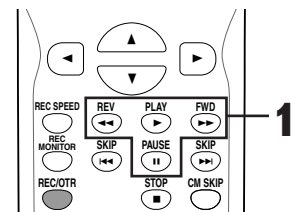

Note

- Forward/reverse speed will be indicated with icons as follows.
- Forward (Approx. Speed)
- x1/16: ▶▶▶▶
 - x1/8: ▶▶▶▶▶
 - x1/2: ▶▶▶▶▶▶▶▶
- Reverse (Approx. Speed)
- x1/16: ◀◀◀◀
 - x1/8: ◀◀◀◀◀
 - x1/4: ◀◀◀◀◀◀

Zoom



1

During playback, hit **[ZOOM]**.

Zoom menu will appear.

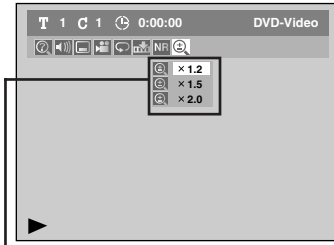

There are four options (x1.0, x1.2, x1.5 and x2.0), these are displayed excluding the current zoom rate.

2

Using **[▲ / ▼]**, select a desired zoom factor to zoom. Hit **[ENTER]**.

The zoom area will be displayed.

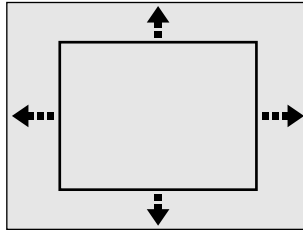

3

Using **[▲ / ▼ / ◀ / ▶]**, select a desired zoom position. Hit **[ENTER]**.

The zoom play will start.

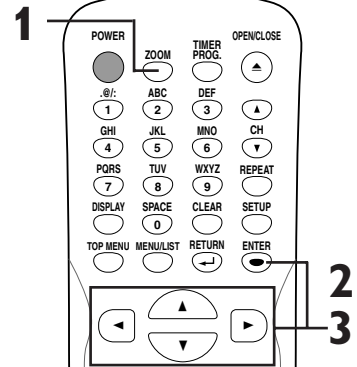

Note

- When selecting a smaller factor than the current one, the zoom area will not be displayed.
- To cancel the zoom menu, hit **[ZOOM]** again at step 1.
- To cancel the zoom, select x1.0 using **[▲ / ▼]**, then hit **[ENTER]**.

Marker Setup



This function allows you to assign a specific point on a disc to be called back later.

1

During playback, hit **[DISPLAY]**.

The display menu will appear.

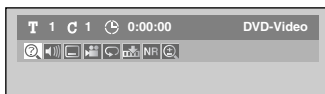

2

Using **[◀ / ▶]**, select **Ⓜ** icon. Hit **[ENTER]**.

Marker setup menu will appear.

Screen for DVD:

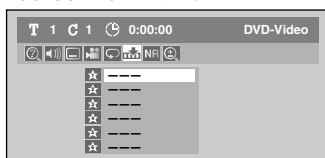

Screen for CD:

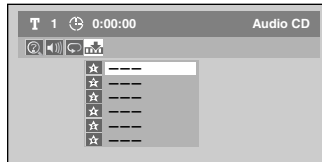

3

Using **[▲ / ▼]**, select a desired marker number. When it reaches the desired point, hit **[ENTER]**.

The title (track) number and the time will be displayed.

4

To return to the marker later: Using **[▲ / ▼]**, select the desired marker number. Hit **[ENTER]**.

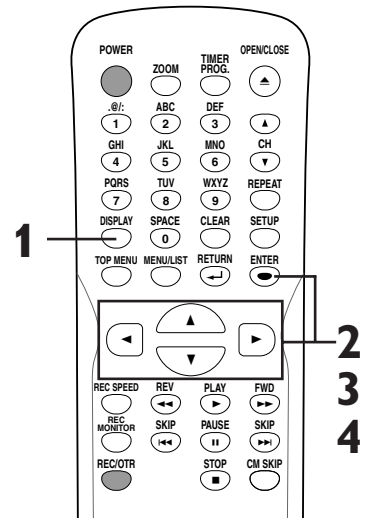

Note

- To clear a marker, select the marker number to be cleared, then hit **[CLEAR]**.
- All markers will be erased when you operate these operations listed below.
 - Opening the disc tray.
 - Turning off the power.
 - Recording to a recordable disc.
 - Changing the mode between Original and Playlist (VR mode).
- You can mark up to 6 points.

Disc Playback

Special playback (cont'd)

Follow Playback during Recording



You can play back the already recorded part of the currently recording program without waiting for the recording to end. This function works from 1 minute after the start of the recording.

1

During recording, hit [PLAY ►]. Playback will start from the beginning of the program that you are currently recording.

Screen for the current playback:



If you play the fast forward playback and the playback reaches the scene recorded 1 minute ago, the forwarding playback will automatically return to the normal playback.

2

Hit [STOP ■] once to stop playback.

The resume message will appear.

Screen for the current recording:

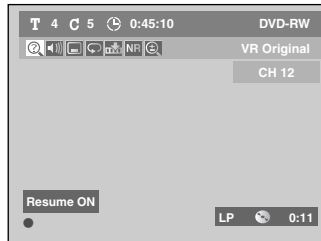

To cancel the resume, hit [STOP ■] once.

To stop recording, hit [STOP ■] again.

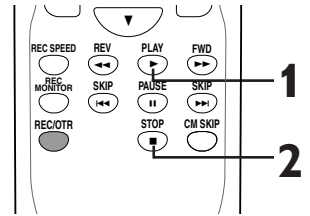

Note

- Playback image may freeze momentarily during the Follow Playback. However this does not affect the recording.
- The x1.5 fast forward is not available.
- You cannot change the recording time length during the Follow Playback.
- "Wait for a moment." will be displayed on the screen if you hit [PLAY ►] within 1 minute of the start of the recording.
- This function is available only when you are recording with DVD-RW in VR mode and the recording speed of LP, EP, SLP, or SEP.

Simultaneous Playback and Recording



You can also play back a recorded title during current recording or the Timer Recording on the same disc.

1

During recording, hit [DISPLAY]. The display menu will appear.

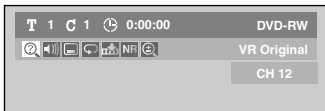

2

Select [?] icon using [◀ / ▶], then hit [ENTER].

The title number next to T will be highlighted.

Title:

Enter a desired title number to search using [▲ / ▼] or the Number buttons, then hit [ENTER].

Selected title will start playback.

Chapter:

To move to C for chapter, hit [▶].

Enter a desired chapter number to search using [▲ / ▼] or the Number buttons, then hit [ENTER].

Selected chapter will start playback.

3

Hit [STOP ■] once to stop playback.

The resume message will appear.

Screen for the current recording:

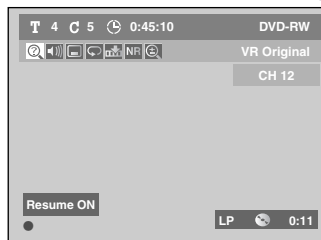

To cancel the resume, hit [STOP ■] once.

To stop recording, hit [STOP ■] again.

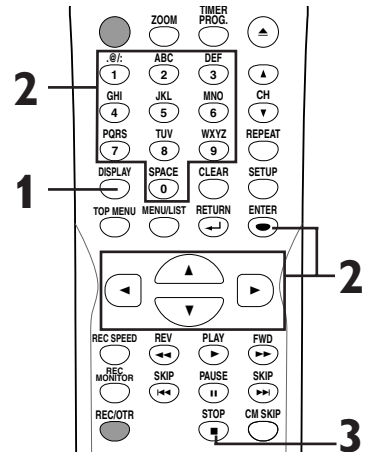

Note

- Only titles (chapters) in the "Original" can be selected. You cannot select titles from the Titles List.
- When you stop the playback after the Timer Recording is completed, the unit will be switched to the timer standby mode if another program has been set (refer to "Hints for Timer Recording" on page 32).

Disc Playback

Search

Title/Chapter search



Using [SKIP <<< / >>>]

1

During playback, hit [SKIP >>>] to skip the current title or chapter and move to the next.

The title or chapter will move forward by one at a time.

To go back to the beginning of the current title or chapter, hit [SKIP <<<].

Hit it repeatedly to go to the previous title or chapter. The title or chapter will move backward one title at a time.

Using [DISPLAY]

1

During playback, hit [DISPLAY].

The display menu will appear.

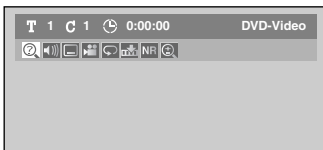

2

Using [◀ / ▶], select icon. Hit [ENTER].

The title number next to **T** will be highlighted.

Title:

Using [▲ / ▼] or the Number buttons, enter a desired title number to search. Hit [ENTER].

Title search will start.

Chapter:

Hit [▶] to move to **C** for chapter.

Using [▲ / ▼] or the Number buttons, enter a desired chapter number to search. Hit [ENTER].

Chapter search will start.

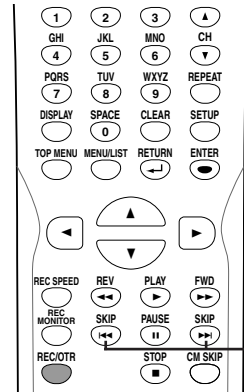

1

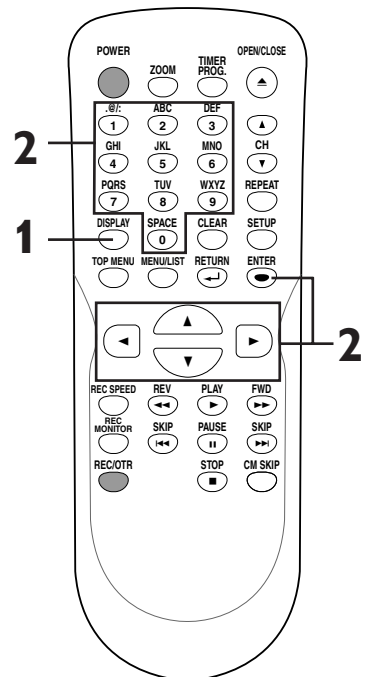

Note

- In search mode display, total numbers of each search contents (title/chapter/time) are shown as a denominator.

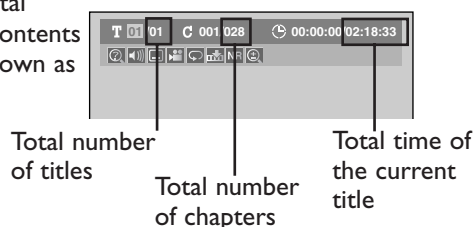

Track search



Using [SKIP <<< / >>>]

1

During playback, hit [SKIP >>>] to skip the current track and move to the next.

The track will move forward one at a time.

To go back to the beginning of the current track, hit [SKIP <<<].

Hit it repeatedly to go to the previous track. The track will move backward one at a time.

Using [DISPLAY]

1

During playback, hit [DISPLAY].

The display menu will appear.

Screen for CD:

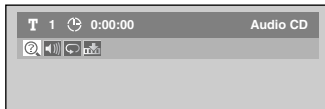

Screen for MP3:

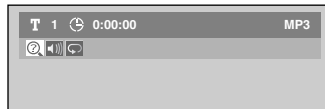

2

Using [◀ / ▶], select icon. Hit [ENTER].

The track number next to **T** will be highlighted.

3

Using [▲ / ▼] or the Number buttons, enter a desired track number to search. Hit [ENTER].

Track search will start.

Time search



1

During playback, hit [DISPLAY].

The display menu will appear.

Screen for DVD:

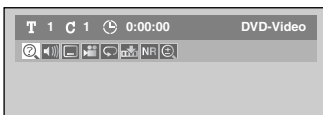

Screen for CD:



2

Using [◀ / ▶], select icon. Hit [ENTER].

The number next to **T** will be highlighted.

To move to the clock icon , hit [▶].

When time search is not available, "--:--:--/--:--:--" ("0:00:00/0:00:00" for CD) is displayed instead of time count.

3

Using [▲ / ▼] or the Number buttons, enter a desired time to search. Hit [ENTER].

Time search will start.

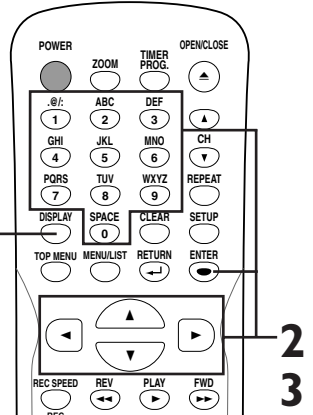
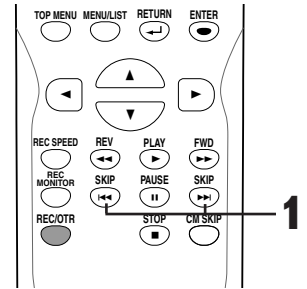

Note

- During CD playback you can enter a track number directly using the **Number buttons** for track search without displaying the menu (except during random and program playback).

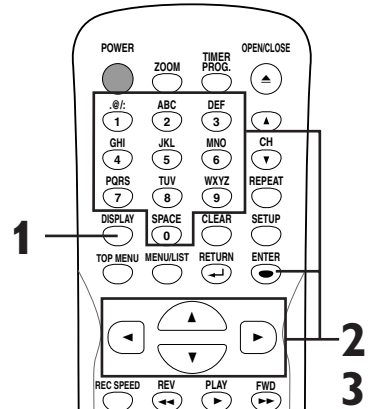

Note

- Time search is available only in the same track or title.

Repeat/Random/Program playback

Repeat playback



1

During playback, hit **[REPEAT]**. Repeat menu will appear.

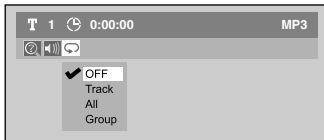
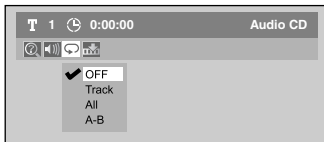
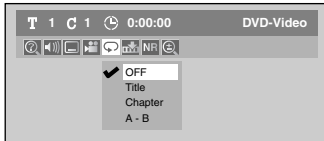

2

Using **[▲ / ▼]**, select a desired option to repeat. Hit **[ENTER]**.

The selected repeat playback will start.

Title:

The current title will be played back repeatedly. (DVD only)

Chapter:

The current chapter will be played back repeatedly. (DVD only)

All:

The current disc will be played back repeatedly. (CD, MP3, DVD-RW (VR mode) only)

A-B:

The A-B point will be played back repeatedly.

When hitting **[ENTER]** while A-B is highlighted, the unit becomes ready for the input.

Hit **[ENTER]** again to decide the starting point (A).

Hit **[ENTER]** after setting point A to select the ending point (B).

Track:

The current track will be played back repeatedly. (CD, MP3 only)

Group:

The current group will be played back repeatedly. (MP3 only)

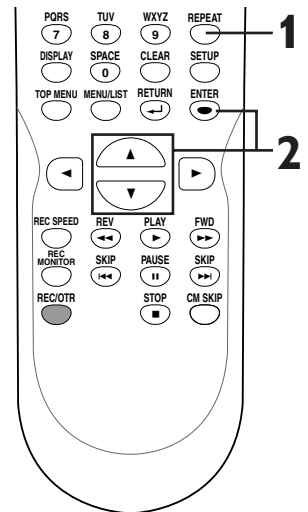

Note

- The A-B Repeat playback can only be set with in the current title (for DVDs), or current track (for Audio CDs).
- To cancel the repeat playback, select OFF at step 2. The repeat setting will be also cleared when you stop playback.
- You cannot select "Group" for repeat playback during the random playback of MP3 files.

Random playback



You can play back a disc randomly instead of playing back in the original order.

1

Hit **[SETUP]** in the stop mode.

Easy Setting Menu or Advanced Setting Menu will appear.

2

Using **[▲ / ▼]**, select "CD Playback Mode". Hit **[ENTER]**. CD Playback Mode menu will appear.

3

Using **[▲ / ▼]**, select "Random Play". Hit **[ENTER]**.

Random playback will start.

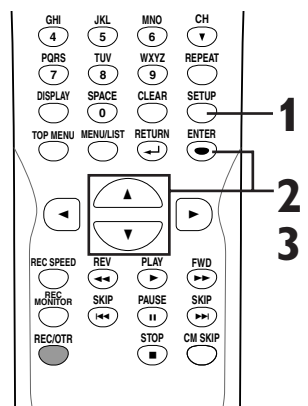

Note

- To cancel random playback, hit **[STOP ■]** twice during random playback. "Play mode OFF" appears on the screen.

Disc Playback

Repeat/Random/Program playback (cont'd)

Program playback



You can program the disc to be played back in your desired order.

1

Hit **[SETUP]** in the stop mode.

Easy Setting Menu or Advanced Setting Menu will appear.

2

Using **[▲ / ▼]**, select “CD Playback Mode”. Hit **[ENTER]**.

CD Playback Mode menu will appear.

3

Using **[▲ / ▼]**, select “Program Play”. Hit **[ENTER]**.

Program play list will appear.

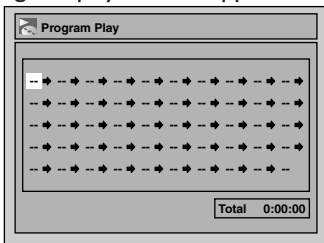

4

Using **[▲ / ▼]**, select a desired track. Hit **[ENTER]** or **[▶]**.

A cursor will move to next.

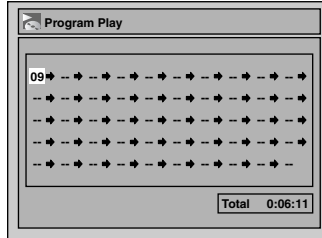

5

Hit **[PLAY ▶]** to start program playback.

Program playback will start.

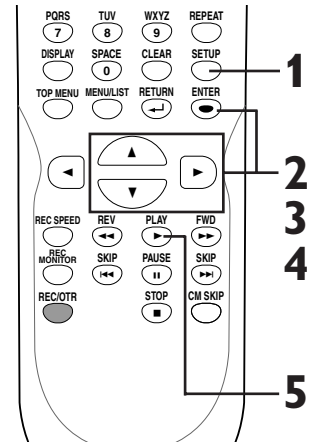

Note

- To erase tracks you selected, hit **[CLEAR]**.
- You can make program settings up to 50.
- To cancel program playback, hit **[STOP ■]** twice during program playback. “Play mode OFF” appears on the screen.
- You may also select a desired track using the **Number buttons** at step 4.

Selecting a format of audio and video

You can select a desired audio and video format. Selections depend on the contents of the disc you are playing back.

Switching subtitles



Many DVD-Video discs have subtitles in one or more languages – they usually tell you which subtitle languages are available. You can switch subtitle languages anytime during playback.

1

During playback, hit **[DISPLAY]**.

Display menu will appear.

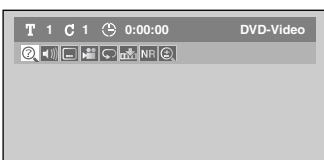

2

Using **[◀ / ▶]**, select  icon. Hit **[ENTER]**.

Subtitle menu will appear.

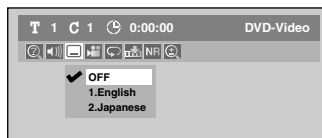

3

Using **[▲ / ▼]**, select a desired subtitle language. Hit **[ENTER]**.

Subtitles will be displayed in the selected language.

When selecting “OFF,” subtitles will disappear.

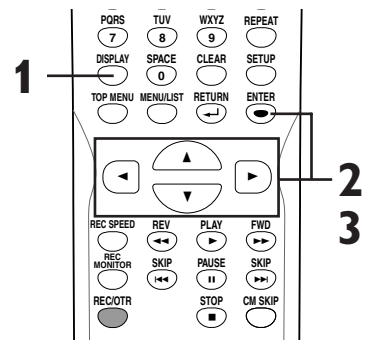

Note

- Some discs will only allow you to change subtitles from the disc menu. Press **[TOP MENU]** or **[MENU / LIST]** to display the disc menu.
- If a 4-digit language code appears in the subtitle menu at step 2, refer to the Language code on page 75.

Selecting a format of audio and video (cont'd)

Switching audio soundtrack



When playing back a DVD-Video disc recorded with two or more soundtracks (these are often in different languages), you can switch between them during playback.

On DVD-RW discs recorded in VR mode, you can switch to main (L), sub audio (R) or a mix of both (L/R).

When playing back Audio CDs or MP3 files, you can switch between stereo, the left channel only and the right channel only.

1
During playback, hit [DISPLAY].

Display menu will appear.

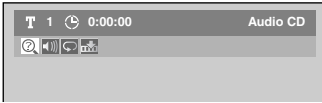
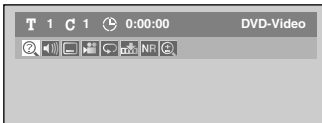

2
Using [◀ / ▶], select  icon. Hit [ENTER].

Audio menu will appear.

<DVD-Video>



<DVD-RW VR mode>

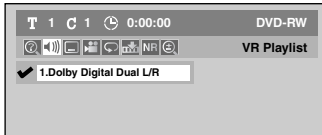

<Audio CD, MP3 files>

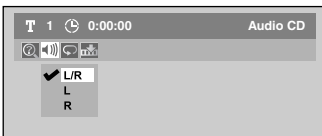

3
Using [▲ / ▼], select a desired audio soundtrack or audio channel. Hit [ENTER].

<DVD-Video>

Audio soundtrack will change.

<DVD-RW VR mode>

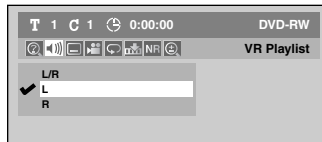

Audio channel menu will appear. Follow step 4.

<Audio CD, MP3 files>

Audio channel will change.

4
Using [▲ / ▼], select a desired audio channel. Hit [ENTER].
Audio channel will change.

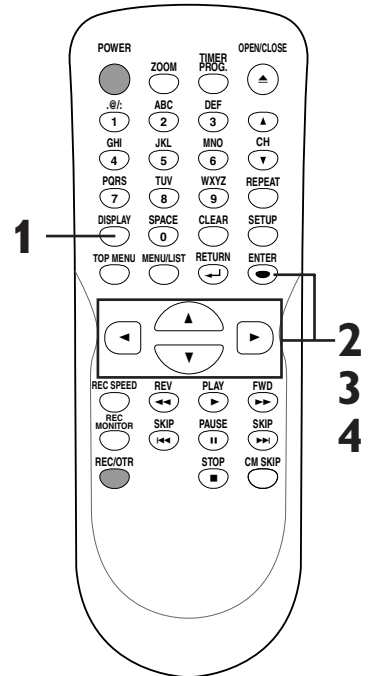

Note

- Some discs will only allow you to change the soundtrack from the disc menu. Press [TOP MENU] or [MENU / LIST] to display the disc menu.
- On DVD-RW discs recorded in VR mode with both main and sub audio, you can switch to main (L), sub audio (R) or a mix of both (L/R).
- This unit CANNOT record in both stereo and SAP (Secondary Audio Program) at the same time.

Disc Playback

Selecting a format of audio and video (cont'd)

Switching camera angles



Some DVD-Video discs feature scenes shot from two or more angles. The disc package should be marked with an angle icon if it contains multi-angle scenes.

1

During playback, hit **[DISPLAY]**.

Display menu will appear.

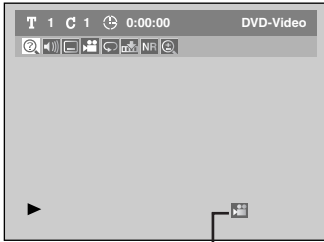

Angle icon appears when different camera angles are available.

2

Using **[◀ / ▶]**, select  icon. Hit **[ENTER]**.

Angle will change each time you hit **[ENTER]**.

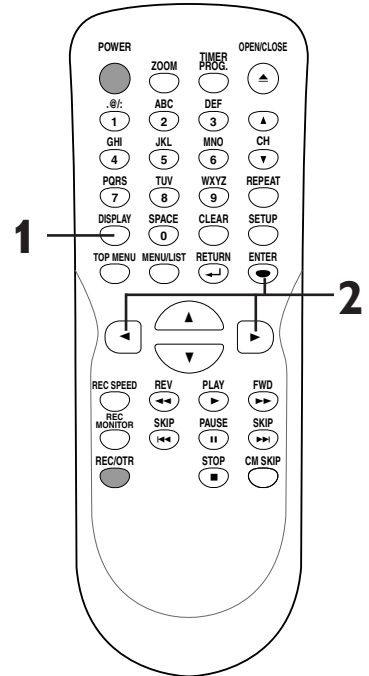

Reducing block noise



1

During playback, hit **[DISPLAY]**.

Display menu will appear.

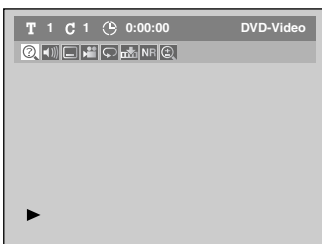

2

Using **[◀ / ▶]**, select **NR** icon. Hit **[ENTER]**.

Noise Reduction menu will appear.

3

Using **[▲ / ▼]**, select a desired option. Hit **[ENTER]**.

Your setting will be activated.

This function reduces noise in the playback picture. When playing back discs recorded in long time mode such as SLP or SEP mode, select "Type 1" or "Type 2". ("Type 2" is more effective.)

When playing back discs with a few noises such as DVD-Video discs, select "OFF".

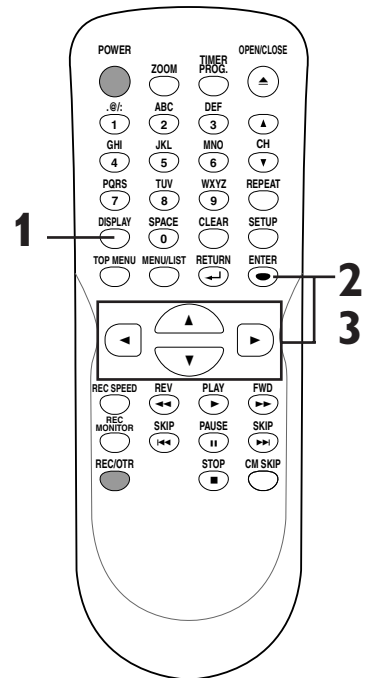

Guide to a title list

Title list allows you to check the titles recorded on the disc easily. You can choose a title to play back from this screen and easily edit the titles as you prefer.

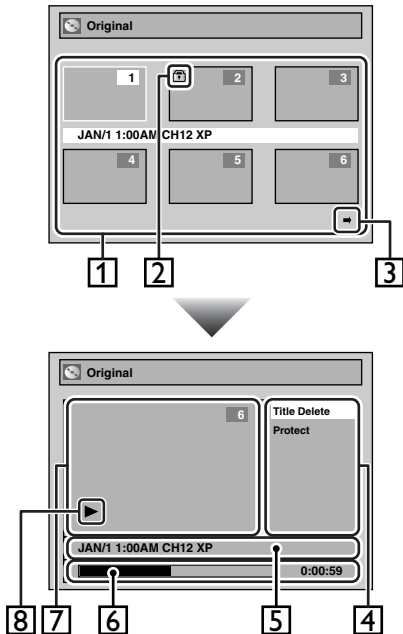

1. Titles recorded on the disc can be selected for editing by hitting **[ENTER]** with the cursor on the title.
2. Protect icon, which appears when the title has been protected. (original titles only)
3. The arrow icon, which means the title list has a next or a previous page. Press **[◀/▶]** by following direction of the icon.
4. Features for editing titles. The available menus depend on the disc type and the format type. An unavailable item is grayed out.
5. The details of the title. Its name can be changed on the Playlist.
6. Time status bar of the title.
After exiting the edit mode, you can resume playback from the point you stopped for editing.
7. The thumbnail of the title selected from the title list.
 - The selected title will be played back automatically.
8. Playback status of the current disc.

Editing discs in Video mode

You can edit discs in Video mode for the following items. Be sure that once you edit titles, you cannot change them back to the original ones.

- Deleting titles (Refer to page 52)
- Putting names on titles (Refer to page 53)
- Setting or clearing chapter markers (Refer to page 54)

Note

- Once a disc is finalized, editing the disc or recording to the disc will not be available. (Except DVD-RW discs in VR mode.)
- A playlist is not available with the DVD-R discs and DVD-RW discs in Video mode.

Editing discs in VR mode

For discs in VR mode, you can use either “Original” menu or “Playlist” menu, which is created from the original, for editing.

Editing original titles

The following items are available to edit the original titles.

- Deleting titles (Refer to page 55)
- Setting titles to protect (Refer to page 56)
- Releasing titles from protecting (Refer to page 56)

Editing playlists

You can create a playlist from original titles, in order to edit as you prefer without losing original titles.

The following items are available to edit with a playlist.

- Deleting titles (Refer to page 57)
- Deleting parts of titles (Refer to page 58)
- Putting names on titles (Refer to page 59)
- Setting or clearing chapter markers (Refer to page 60)
- Setting pictures for thumbnails (Refer to page 61)
- Dividing a title (Refer to page 62)
- Combining titles (Refer to page 63)
- Adding titles to a playlist (Refer to page 64)
- Deleting a playlist (Refer to page 64)

Note

- Once-edited original titles will not remain as recorded originally. When you want to leave the original as it is, edit the playlist as you prefer.

After you finish all editing, hit **[SETUP]** to exit the editing mode. “Writing to Disc” appears momentarily. If you open the disc tray, or hit **[POWER]** to turn the unit off, or when a recording error occurs after editing, “Writing to Disc” also appears.

Deleting titles



You can delete titles which you do not need anymore.

Be advised that the titles once deleted cannot be recovered. In Video mode, recordable disc space of DVD-RW disc will increase when the last title on the title list is deleted. However, deleting the last title will not change recordable disc space of DVD-R discs.

1 Hit [SETUP] in the stop mode. Using [▲ / ▼], select “Disc”. Hit [ENTER].

Disc menu will appear.

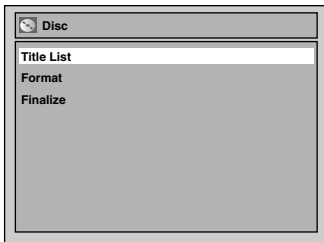

2 Using [▲ / ▼], select “Title List”. Hit [ENTER].

Title list will appear.

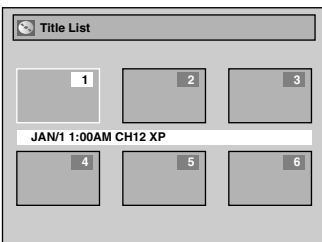

3 Using [▲ / ▼ / ◀ / ▶], select a desired title. Hit [ENTER].

Edit menu will appear.

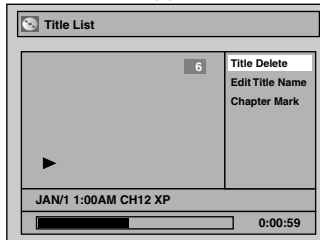

You cannot select “Chapter Mark” when a DVD-R disc is inserted into the unit.

4 Using [▲ / ▼], select “Title Delete”. Hit [ENTER].

Confirmation window will appear.

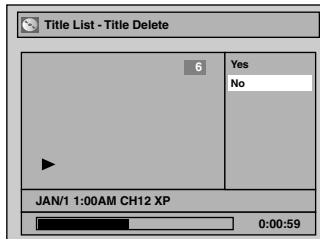

5 Using [▲ / ▼], select “Yes”. Hit [ENTER].

Title will be deleted.

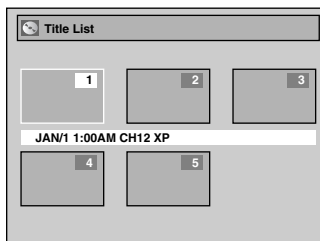

6 After this operation is completed, hit [SETUP] to exit. Data will be written onto the disc momentarily.

This operation may take a while to be completed.

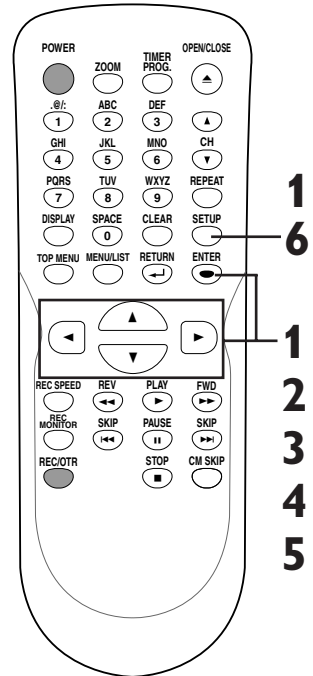

Putting names on titles



You can name titles and change the names from this menu. The names you put on the titles will be displayed on a titlelist.

1
Follow steps 1 to 3 on page 52 to display the Edit menu.

Using **[▲ / ▼]**, select “Edit Title Name”. Hit **[ENTER]**. A window for entering a title name will appear.

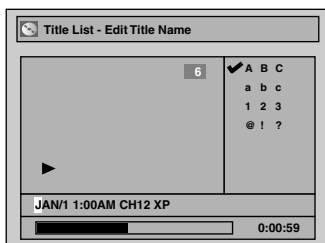

2
To enter a title name, follow steps of “Guide to edit title name” on this page.

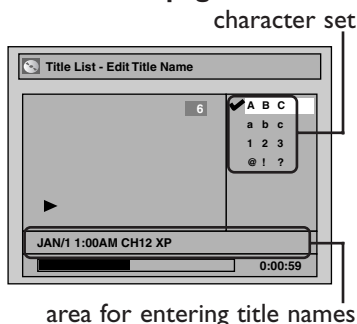

When you finish entering a title name, hit **[ENTER]**. Confirm window will appear.

3
Using **[▲ / ▼]**, select “Yes”. Hit **[ENTER]**.

The name you entered will be activated for the title.

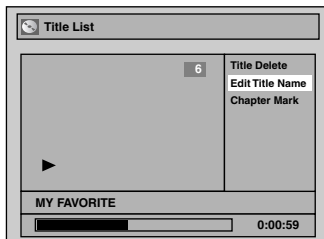

4
After this operation is completed, hit **[SETUP]** to exit. Data will be written onto the disc momentarily.

This operation may take a while to be completed.

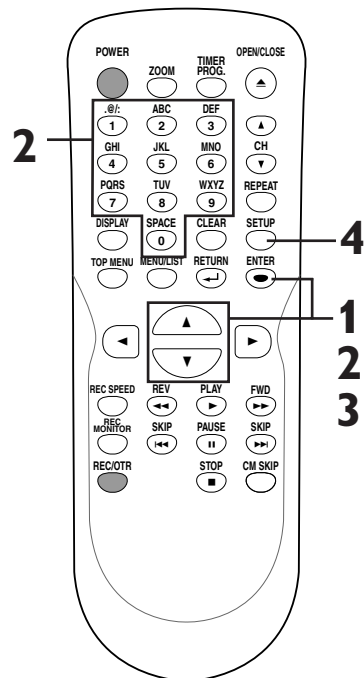

[Guide to edit title name]

[Step1]: Select a desired character set using **[▲/▼]**, then hit **[ENTER]**.

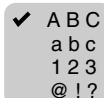

[Step2]: Follow the list below, press the **Number buttons** repeatedly until the desired letter appears. e.g. character set : **A B C**

Select Press	ABC	abc	123	@ ! ?
0	<space>	<space>	0	<space>
1	-	-	1	! " # \$ % & ' () * + , - . / : ; < = > ? @ [] ^ _ { }
2	ABC	abc	2	-
3	DEF	def	3	-
4	GHI	ghi	4	-
5	JKL	jkl	5	-
6	MNO	mno	6	-
7	PQRS	pqrs	7	-
8	TUV	tuv	8	-
9	WXYZ	wxyz	9	-

Note: Undefined letters in a title name are shown by “*”. If you delete them, adjoining letters may change to “*” or other.

- Character set will be changed to the “ @!?” automatically if you hit **1** after you selected the “ABC” or “abc” mode.
- If you want to mix different character sets in one title, repeat Step [1] and [2] above.
- To delete letters, hit **[CLEAR]** repeatedly. Hold **[CLEAR]** to delete all letters.
- To go on to the next entering area for letters, hit **[▶]**.
- You can enter up to 30 letters.

Editing discs in Video mode (cont'd)

Setting or clearing chapter markers



You can put chapter markers on each title. Once a chapter is marked, you can use it for the chapter search.

You can specify time interval for chapter markers for titles last more than 5 minutes.

1

Follow steps 1 to 3 on page 52 to display the Edit menu.

Using [\blacktriangle / \blacktriangledown], select “Chapter Mark”. Hit [ENTER].

Option window will appear.

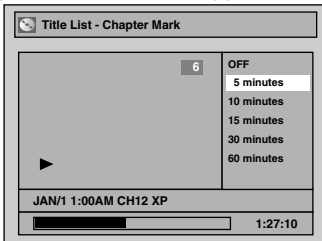

2

Using [\blacktriangle / \blacktriangledown], select a desired time. Hit [ENTER].

Confirmation window will appear.

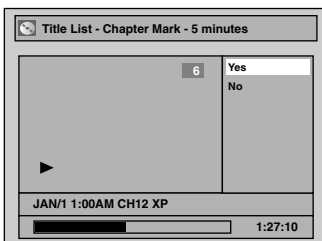

3

Using [\blacktriangle / \blacktriangledown], select “Yes”. Hit [ENTER].

Chapter markers will be added. If you select “OFF” at step 2, all the chapter markers will be erased.

4

After this operation is completed, hit [SETUP] to exit. Data will be written onto the disc momentarily.

This operation may take a while to be completed.

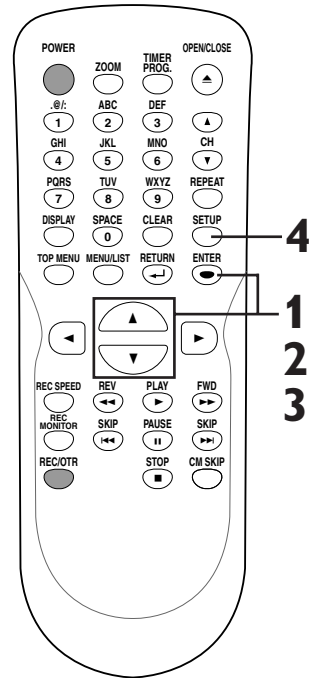

Note

- You cannot select a time interval for markers beyond a length of a title.
- The length of chapters may be slightly deviate from the one specified at step 2.
- A chapter marker may be delayed according to the recording content.

Deleting titles



When a title is deleted from an original list in VR mode, recordable disc space will increase. Be advised that the titles once deleted cannot be recovered.

1
Hit [SETUP] in the stop mode. Using [▲ / ▼], select “Disc”. Hit [ENTER].
Disc menu will appear.

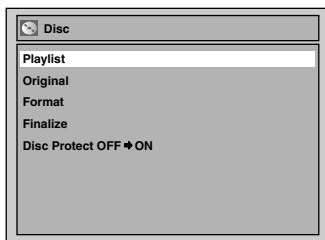

2
Using [▲ / ▼], select “Original”. Hit [ENTER].
Original list will appear.

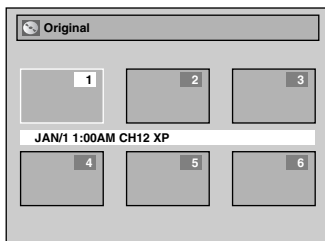

3
Using [▲ / ▼ / ◀ / ▶], select a desired title. Hit [ENTER].
Original menu will appear.

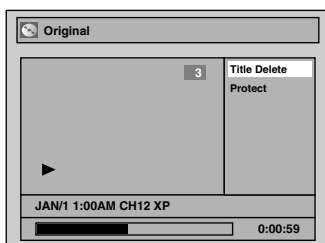

4
Using [▲ / ▼], select “Title Delete”. Hit [ENTER].
Confirm window will appear.

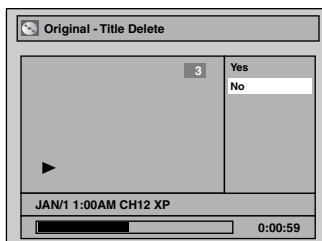

5
Using [▲ / ▼], select “Yes”. Hit [ENTER].
Title will be deleted.

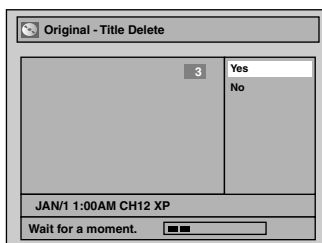

6
After this operation is completed, hit [SETUP] to exit.
Data will be written onto the disc momentarily.

This operation may take a while to be completed.

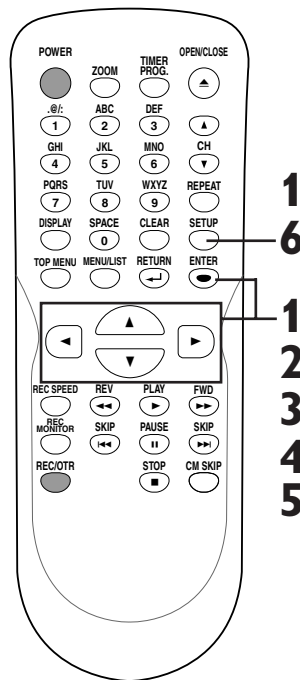

Note

- When a title is deleted from an original list, corresponding Playlist(s) will be also deleted.

Editing

Editing discs in VR mode (Original) (cont'd)

Setting titles to protect



To prevent accidental editing or title erasing, you can protect the contents in the original menu.

1

Follow steps 1 to 3 on page 55 to display the Original menu.

Using [**▲** / **▼**], select “Protect”. Hit [**ENTER**].

Option window will appear.

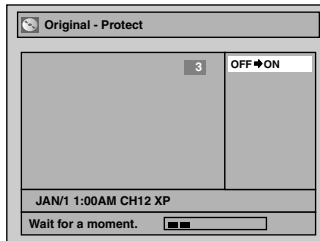
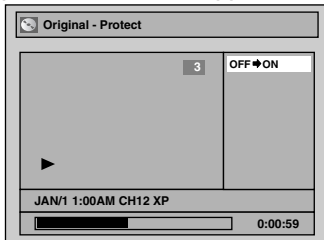

The key icon will appear on the title in the original list.

3

After this operation is completed, hit [**SETUP**] to exit. Data will be written onto the disc momentarily.

This operation may take a while to be completed.

2

Confirm the indication “OFF → ON”. Hit [**ENTER**].

To protect a whole disc (DVD-RW VR mode Only): Select “Disc Protect” from Disc menu, then select “Yes”. Refer to “Setting a disc to protect” on page 34.

Note

- The protected title will be marked with a key icon on the original list.

Releasing titles from protecting



You can cancel the title-protecting.

1

Follow steps 1 to 3 on page 55 to display the Original menu.

• “Protect” is already highlighted.

2

Hit [**ENTER**].

Confirmation window will appear.

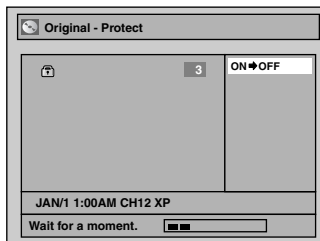

The key icon will disappear from the title in the original list.

4

After this operation is completed, hit [**SETUP**] to exit. Data will be written onto the disc momentarily.

This operation may take a while to be completed.

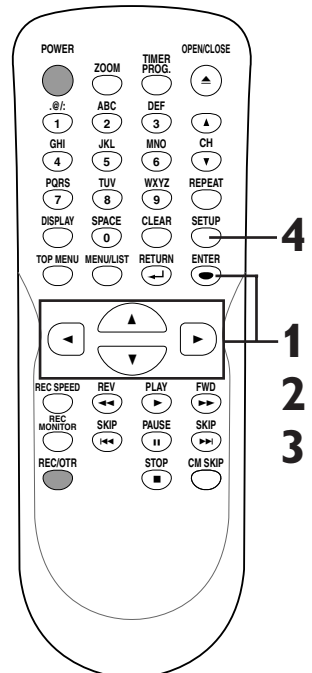
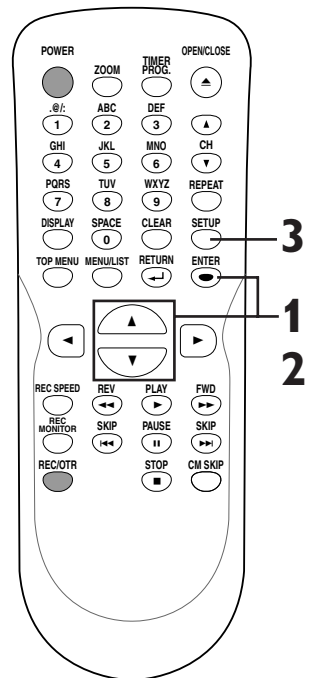

Deleting titles



In VR mode, even if a title is deleted from a Playlist, the original title will remain on the Original list, and recordable disc space will not increase.

1
Hit [SETUP] in the stop mode. Using [▲ / ▼], select "Disc". Hit [ENTER].

Disc menu will appear.

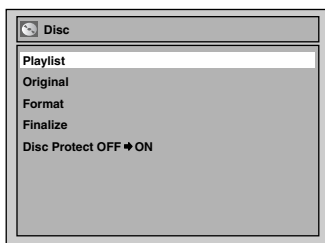

2
Using [▲ / ▼], select "Playlist". Hit [ENTER].
Playlist will appear.

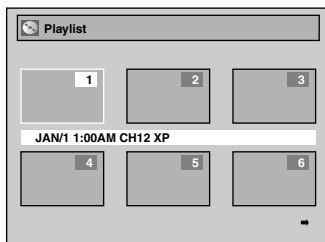

3
Using [▲ / ▼ / ◀ / ▶], select a desired title. Hit [ENTER].
Playlist menu will appear.

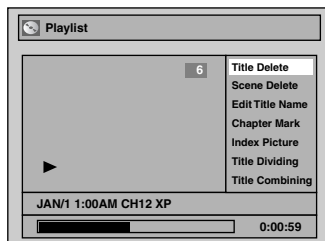

4
Using [▲ / ▼], select "Title Delete". Hit [ENTER].
Confirmation window will appear.

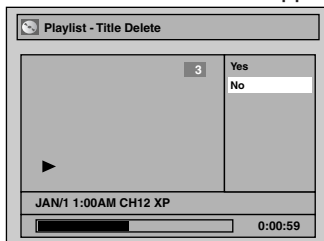

5
Using [▲ / ▼], select "Yes". Hit [ENTER].
Title will be deleted.

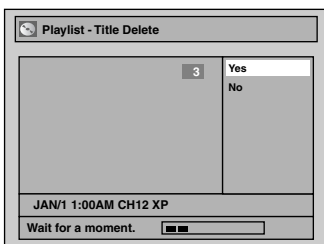

6
After this operation is completed, hit [SETUP] to exit.
Data will be written onto the disc momentarily.

This operation may take a while to be completed.

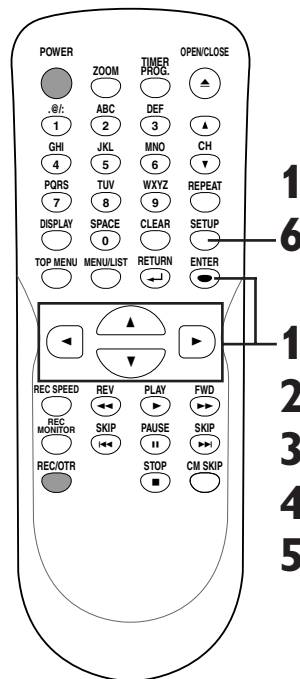

Deleting parts of titles



You can delete a specific part of a title.

Even if a part of a title is deleted from the playlist, the original title will remain as it was, and recordable disc space will not increase.

1

Follow steps 1 to 3 on page 57 to display the Playlist menu.

Using [**▲** / **▼**], select “Scene Delete”. Hit [**ENTER**].

Option window will appear.

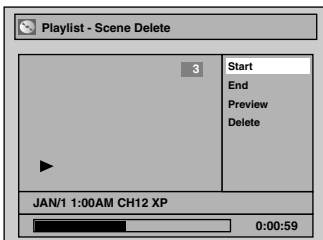

2

Use [**SKIP** **◀◀** / **▶▶**], [**REV** **◀◀**], [**FWD** **▶▶**], [**PLAY** **▶**] and [**PAUSE** **||**] to decide the start point, then hit [**ENTER**].

Then use [**SKIP** **◀◀** / **▶▶**], [**REV** **◀◀**], [**FWD** **▶▶**], [**PLAY** **▶**] and [**PAUSE** **||**] again to move to the end point, and hit [**ENTER**].

A cursor will move to “Preview.”

The bar at the bottom of the screen indicates the total and the elapsed time of the title. The area selected for deletion will be indicated in red.

Hit [**ENTER**] again to start the preview.

You can check the result of deletion by preview.

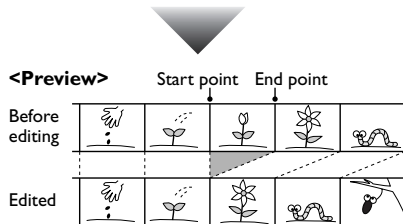

3

Using [**▲** / **▼**], select “Delete”. Hit [**ENTER**].

Confirmation window will appear.

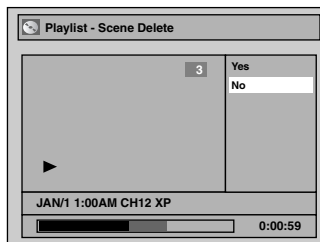

4

Using [**▲** / **▼**], select “Yes”. Hit [**ENTER**].

Part of a title will be deleted.

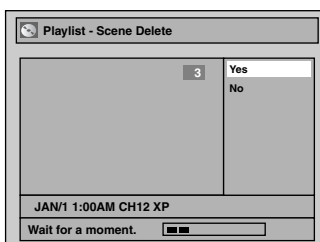

5

After this operation is completed, hit [**SETUP**] to exit.

Data will be written onto the disc momentarily.

This operation may take a while to be completed.

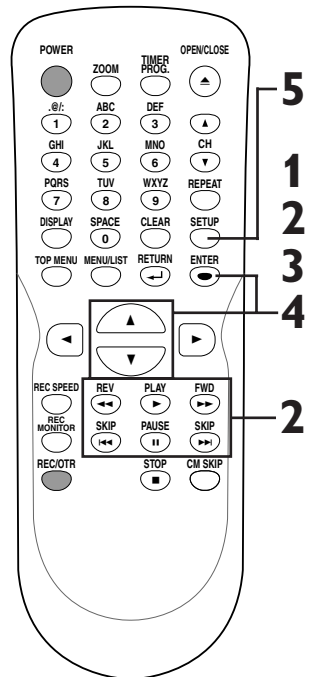

Note

- You cannot select “Scene Delete” when the number of chapter markers exceeds 900.

Putting names on titles



You can name titles and change the names in this menu. The names you put on the titles will be displayed on a titlelist.

1 Follow steps 1 to 3 on page 57 to display the Playlist menu.

Using **[▲ / ▼]**, select **"Edit Title Name"**. Hit **[ENTER]**.

A window for entering a title name will appear.

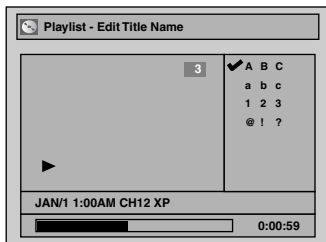

2 To enter a title name, follow steps of "Guide to edit title name" on this page.

character set

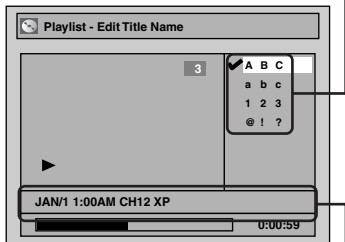

area for entering title names

When you finish entering a title name, hit **[ENTER]**. Confirm window will appear.

3 Using **[▲ / ▼]**, select **"Yes"**. Hit **[ENTER]**.

The name you entered will be activated for the title.



4 After this operation is completed, hit **[SETUP]** to exit. Data will be written onto the disc momentarily.

This operation may take a while to be completed.

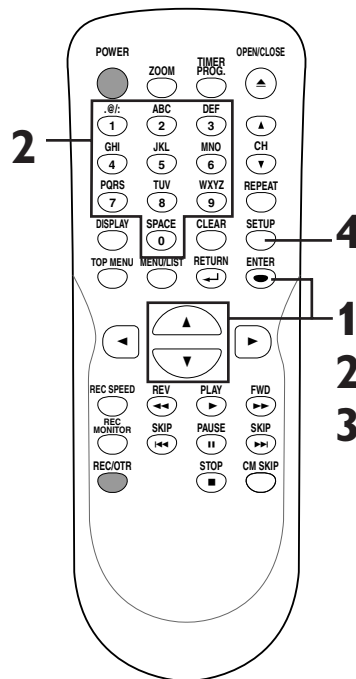

[Guide to edit title name]

[Step1]: Select a desired character set using **[▲/▼]**, then hit **[ENTER]**.

A B C
a b c
1 2 3
@ ! ?

[Step2]: Follow the list below, press the **Number buttons** repeatedly until the desired letter appears. e.g. character set : **A B C**

Select Press	ABC	abc	123	@ ! ?
0	<space>	<space>	0	<space>
1	-	-	1	! " # \$ % & ' () * + , - . / : ; < = > ? @ [] ^ _ { }
2	ABC	abc	2	-
3	DEF	def	3	-
4	GHI	ghi	4	-
5	JKL	jkl	5	-
6	MNO	mno	6	-
7	PQRS	pqrs	7	-
8	TUV	tuv	8	-
9	WXYZ	wxyz	9	-

Note: Undefined letters in a title name are shown by **"*"**. If you delete them, adjoining letters may change to **"*"** or other.

- Character set will be changed to the **"@!?"** automatically if you hit **1** after you selected the "ABC" or "abc" mode.
- If you want to mix different character sets in one title, repeat Step [1] and [2] above.
- To delete letters, hit **[CLEAR]** repeatedly. Hold **[CLEAR]** to delete all letters.
- To go on to the next entering area for letters, hit **[▶]**.
- You can enter up to 30 letters.

Setting or clearing chapter markers



You can put chapter markers on each title. Once a chapter is marked, you can use it for the chapter search.

You can put a chapter marker anywhere you want until the total number of the markers reaches 999.

1

Follow steps 1 to 3 on page 57 to display the Playlist menu.

Using **[▲ / ▼]**, select **"Chapter Mark"**. Hit **[ENTER]**.

Option window will appear.

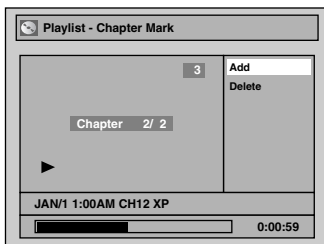

2

Use **[SKIP ◀◀ / ▶▶]**, **[REV ◀◀]**, **[FWD ▶▶]**, **[PLAY ▶]** and **[PAUSE ||]** to decide the point at which you will create a new chapter marker.

Or, use **[SKIP ◀◀ / ▶▶]** to decide a chapter marker that you will delete. Select **"Add"** or **"Delete"** accordingly using **[▲ / ▼]**. Hit **[ENTER]**.

Confirmation window will appear.

<Add>:

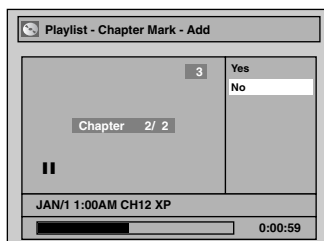

<Delete>:

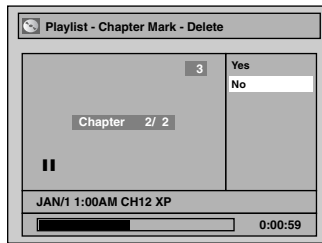

- You cannot delete the first chapter of each title.

3

Using **[▲ / ▼]**, select **"Yes"**. Hit **[ENTER]**.

When you select **"Add"** at step 2, a new chapter marker will be created at the point you have decided.

<Add>:

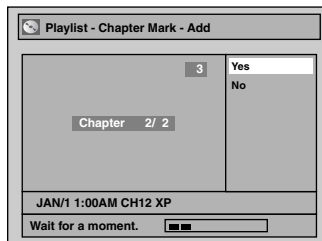

When you select **"Delete"** at step 2, the chapter marker you have selected will be deleted.

<Delete>:

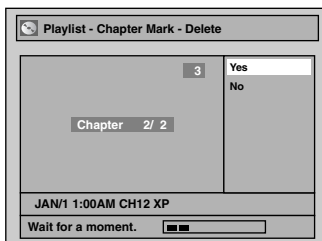

4

After this operation is completed, hit **[SETUP]** to exit.

Data will be written onto the disc momentarily.

This operation may take a while to be completed.

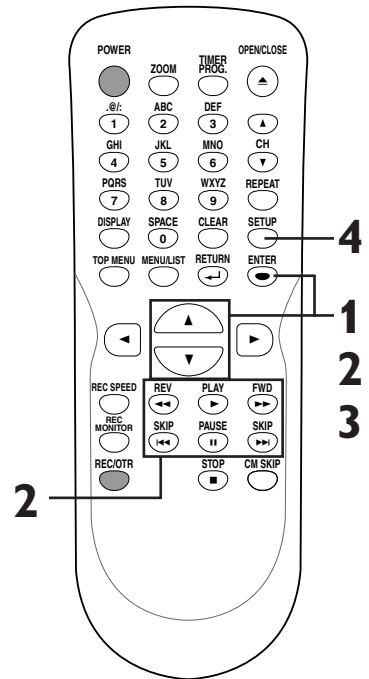

Setting pictures for thumbnails



You can set an image picture for each title as a thumbnail. It helps you remember the contents of the title during playback. The default setting chooses the first scene of each title as the thumbnail.

1

Follow steps 1 to 3 on page 57 to display the Playlist menu.

Using [**▲** / **▼**], select “Index Picture”.

Use [**SKIP** **◀◀** / **▶▶**], [**REV** **◀◀**], [**FWD** **▶▶**], [**PLAY** **▶**] and [**PAUSE** **⏸**] to decide the picture you want to select as a thumbnail. Hit [**ENTER**].

Confirmation window will appear.



2

Using [**▲** / **▼**], select “Yes”. Hit [**ENTER**].

A picture for thumbnail will be set.

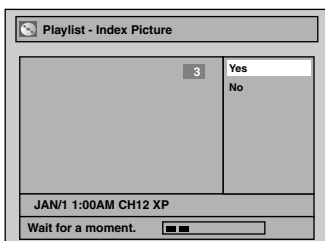

3

After this operation is completed, hit [**SETUP**] to exit.

Data will be written onto the disc momentarily.

This operation may take a while to be completed.

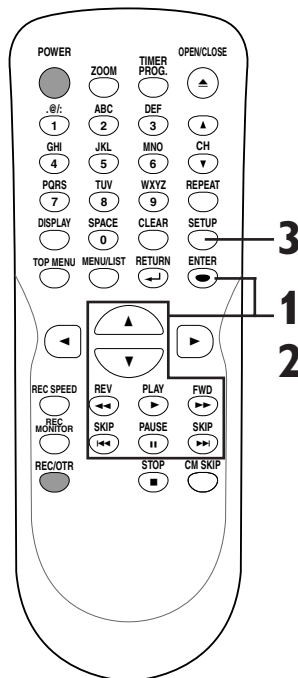

Note

- If a selected picture for a thumbnail is deleted by deleting a part of a title, a default picture will automatically replace it.

Dividing a title



You can divide a title into two new titles.

1

Follow steps 1 to 3 on page 57 to display the Playlist menu.

Use [SKIP |◀◀ / ▶▶|], [REV ◀◀], [FWD ▶▶], [PLAY ▶] and [PAUSE II] to decide the point at which you will divide the title.

Using [▲ / ▼], select “Title Dividing”. Hit [ENTER].

Confirmation window will appear.

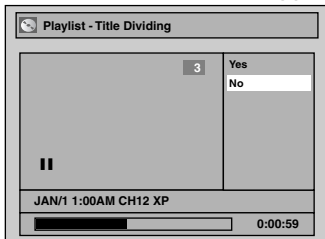

2

Using [▲ / ▼], select “Yes”. Hit [ENTER].

The title will be divided into two new titles.

Both title names are identical, and index pictures are reset to the first scene of each title.

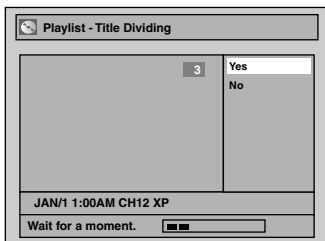

3

After this operation is completed, hit [SETUP] to exit.

Data will be written onto the disc momentarily.

This operation may take a while to be completed.

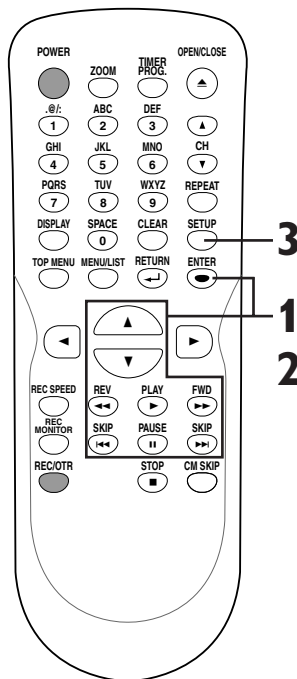

Note

- If a disc contains the maximum number of recordings (99), you cannot divide any titles.
- You cannot divide the titles if the total number of the chapters have already reached 999.

Combining titles



You can combine two titles into a single title.

1

Follow steps 1 to 3 on page 57 to display the Playlist menu.

Using [**▲** / **▼**], select "Title Combining". Hit [**ENTER**].

Title Combining setting window will appear.

The selected title grays out, and the frame of the next title becomes yellow.

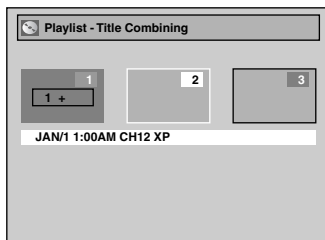

2

Using [**▲** / **▼** / **◀** / **▶**], select another title to combine. Hit [**ENTER**].

Confirmation window will appear.

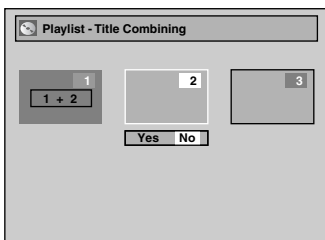

3

Using [**◀** / **▶**], select "Yes". Hit [**ENTER**].

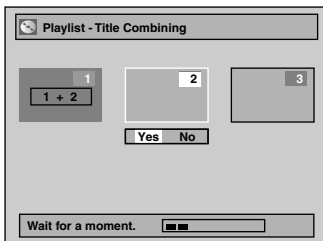

Two titles will be combined into a single title.

4

After this operation is completed, hit [**SETUP**] to exit.

Data will be written onto the disc momentarily.

This operation may take a while to be completed.

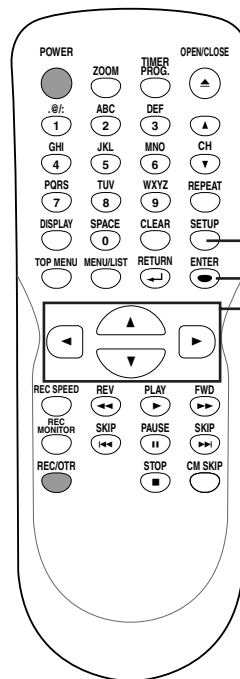

Note

- If the number of chapter markers in the combined title exceeds 999, the combination will be rejected.
- If one of two titles in the original is deleted, the combined new title will be deleted.
- The name of the title selected first will become the name of the combined title.
- The title selected first will be the first point of the combined title.

Adding titles to a Playlist



You can add or delete a title on the playlist as you prefer.

You can add up to 99 titles to a Playlist.

1

Follow steps 1 to 2 on page 57 to display the Playlist.

“Add New Title” “Delete Playlist” menu will appear next to the last title.

Using [**▲** / **▼** / **◀** / **▶**], select “Add New Title”. Hit [**ENTER**].

Original list will appear.

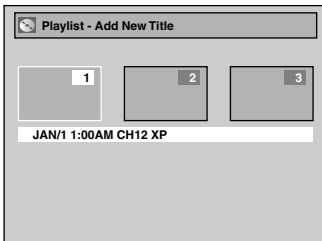

2

Using [**▲** / **▼** / **◀** / **▶**], select a desired title. Hit [**ENTER**].



The selected title will be added to the Playlist.

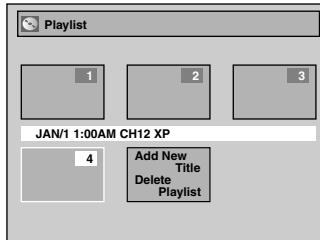

3

After this operation is completed, hit [**SETUP**] to exit. Data will be written onto the disc momentarily.

This operation may take a while to be completed.

To delete a title from Playlist, refer to “Deleting titles” on page 57. To delete a Playlist, refer to “Deleting a Playlist” on this page.

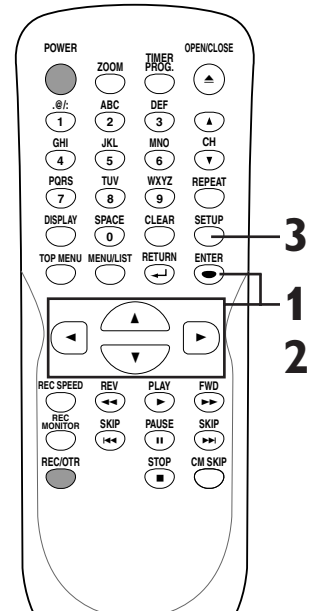

Note

- When a Playlist contains 99 titles or more, or 999 chapters or more, “Add New Title” cannot be selected.

Deleting a Playlist



A Playlist can be deleted if it is no longer needed.

1

Follow steps 1 to 2 on page 57 to display the Playlist.

“Add New Title” “Delete Playlist” menu will appear next to the last title.

Using [**▲** / **▼** / **◀** / **▶**], select “Delete Playlist”. Hit [**ENTER**].

Confirmation window will appear.

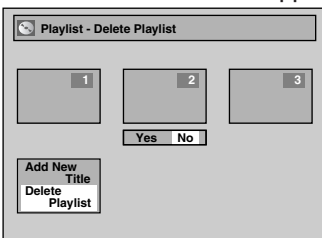

2

Using [**◀** / **▶**], select “Yes”. Hit [**ENTER**].

A Playlist will be deleted.

3

After this operation is completed, hit [**SETUP**] to exit. Data will be written onto the disc momentarily.

This operation may take a while to be completed.

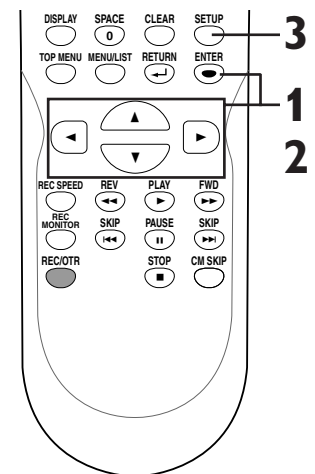

Note

- Deleting a Playlist will not increase the recording disc space.

Changing the Setting menu

Tour of the Setting menu

The following table shows the items which you can change the settings and their default settings. Refer to the following table for your convenience.

Setting menu	Items (highlight is the default)	Contents	
1. Language setting ➡ Pages 66-67	Disc Menu Language	English French Spanish ⋮	Set the language for disc menu.
	Audio Language	Original English French ⋮	Set the language for audio.
	Subtitle Language	OFF English French ⋮	Set the language for subtitles.
2. Display setting ➡ Pages 67-68	OSD Language	English Français Español	Set the language for OSD (On-Screen Display).
	FL Dimmer	Auto Bright Dark	Set the brightness of front display.
	Screen Saver	OFF 5 minutes 10minutes ⋮	Set the idling time before the screen saver starts.
3. Audio setting ➡ Pages 68-70	Digital Out	Dolby Digital PCM Stream	Set the type of sound signal output from the digital audio output jack.
		PCM 48kHz 96kHz	Set whether the sound recorded in 96kHz will be down sampled in 48kHz.
	Dynamic Range Control	ON OFF	Compressing the range of sound volume.
	Fast Forward with Audio	ON OFF	Outputting the sound during playback in fast forward.
4. Parental setting ➡ Pages 70-71	Parental Lock	All level 8 to 1	Set the parental level for DVD disc playback.
	(Change password)	Enter the current four-digit password	Set and change the password.

Note

- If you change the settings in the Setting menu, the information of contents stays on even after the power is switched off or the disc tray is opened or closed.
- An item which is not currently available is grayed out in Setting menus.

Changing the Setting menu

Language setting

Hit **[STOP ■]** if you are playing back a disc.

1

Hit **[SETUP]** in the stop mode.

Easy Setting Menu or Advanced Setting Menu will appear.
If Advanced Setting Menu is displayed, proceed to step 3.

2

Using **[▲ / ▼]**, select “Advanced Setting Menu”. Hit **[ENTER]**.

Advanced Setting Menu will appear.

3

Using **[▲ / ▼]**, select “Playback”. Hit **[ENTER]**.

Option window will appear.

4

Using **[▲ / ▼]**, select a desired item. Hit **[ENTER]**.

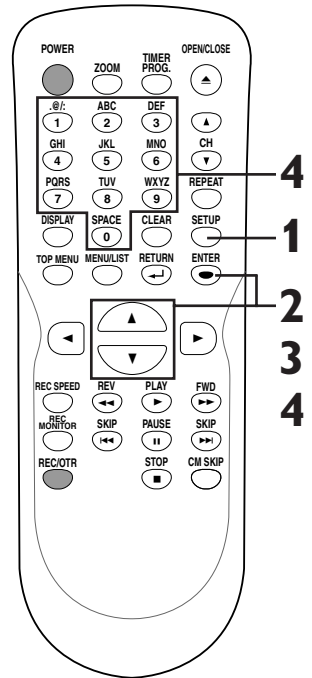

Disc Menu Language (Default : English)

Set the language for Disc Menu.

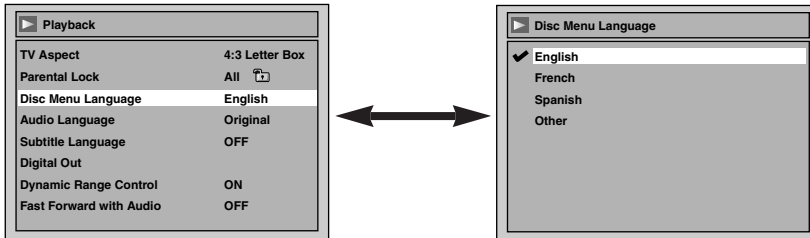

• Using **[▲ / ▼]**, select a language. Hit **[ENTER]**.

Your setting will be activated.

Audio Language (Default : Original)

Set the Audio language.

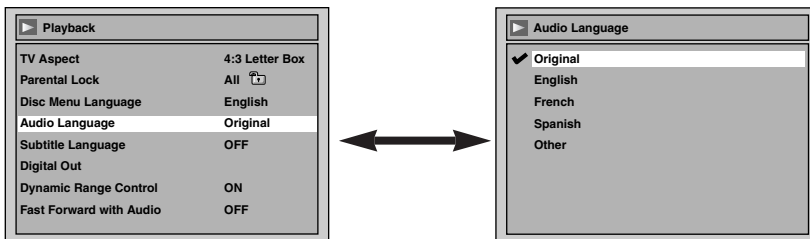

• Using **[▲ / ▼]**, select a language. Hit **[ENTER]**.

Your setting will be activated.

• When Original is selected, the audio language will be the disc's default language.

Changing the Setting menu

Language setting (cont'd)

Subtitle Language (Default : OFF)

Set the Subtitle language.

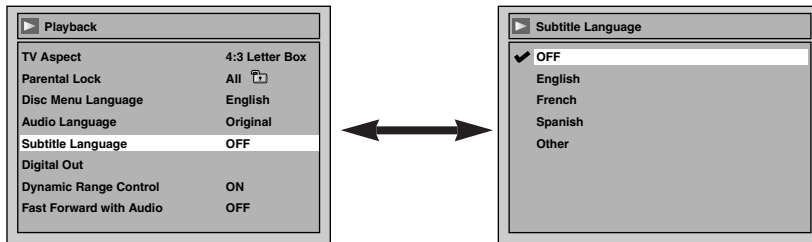

- Using [▲ / ▼], select a language. Hit [ENTER]. Your setting will be activated.

If "Other" is selected, press 4-digit code using the **Number buttons**.

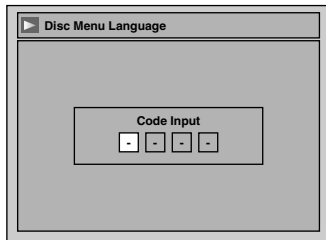

- When you finish entering the code, hit [ENTER]. Refer to the language code table on page 75.

Note

- Only the languages supported by the disc can be selected.
- Audio Language setting may not be available on some discs.
- You can also change or switch off the subtitles on a DVD disc also from the disc menu if it is available.
- Press [CLEAR] or [◀] to erase numbers entered incorrectly.

5

Hit [SETUP] to exit.

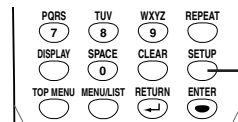

5

Display setting

Hit [STOP ■] if you are playing back a disc.

1

Hit [SETUP] in the stop mode.

Easy Setting Menu or Advanced Setting Menu will appear. If Advanced Setting Menu is displayed, proceed to step 3.

2

Using [▲ / ▼], select "Advanced Setting Menu". Hit [ENTER].

Advanced Setting Menu will appear.

3

Using [▲ / ▼], select "Display". Hit [ENTER].

Option window will appear.

4

Using [▲ / ▼], select a desired item. Hit [ENTER].

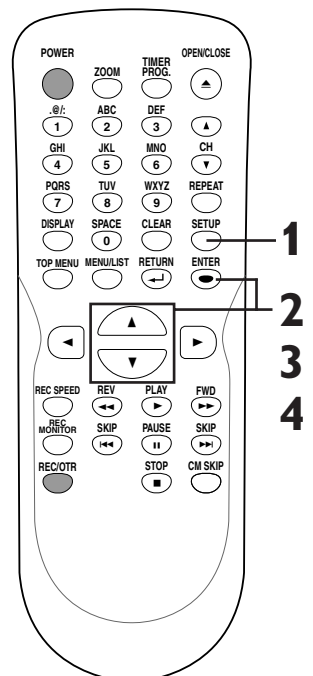

Instructions continue on the next page.

Changing the Setting menu

Display setting (cont'd)

OSD Language (Default : English)

Set the language for OSD.

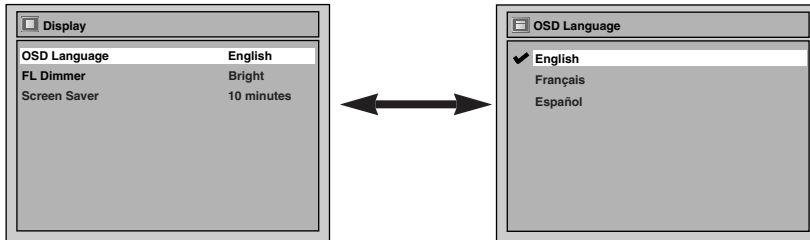

- Using [**▲** / **▼**], select a language. Hit [**ENTER**].
Your setting will be activated.

FL Dimmer (Default : Bright)

Set the brightness of front display.

You can choose one among "Auto", "Bright" and "Dark".

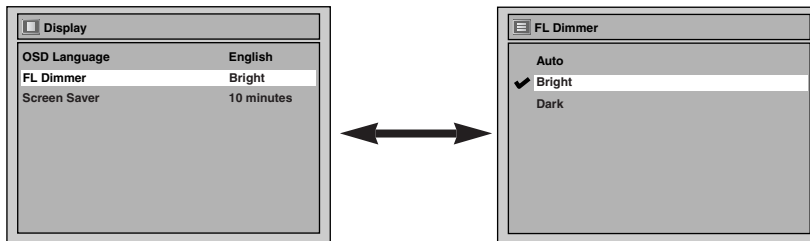

- Using [**▲** / **▼**], select a setting. Hit [**ENTER**].
Your setting will be activated.
- If "Auto" is selected, the display will be brighter when the power is on, and darker when the power is off.

Screen Saver (Default : 10 minutes)

Set the idling time before the screen saver starts.

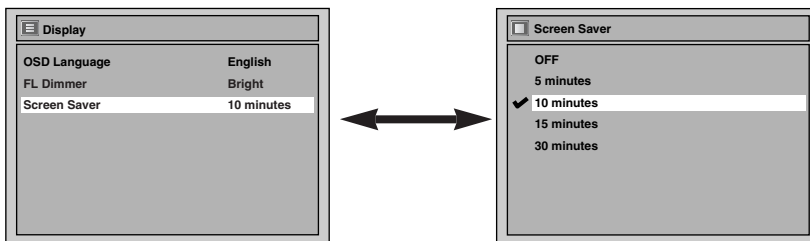

- Using [**▲** / **▼**], select a setting. Hit [**ENTER**].
Your setting will be activated.

.....
5
Hit [**SETUP**] to exit.

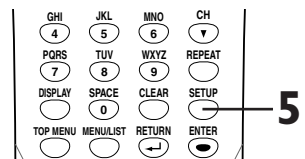

Audio setting

Choose the appropriate Audio settings for your equipment.

Hit [**STOP** 

.....
1
Hit [**SETUP**] in the stop mode.
Easy Setting Menu or Advanced Setting Menu will appear.
If Advanced Setting Menu is displayed, proceed to step 3.

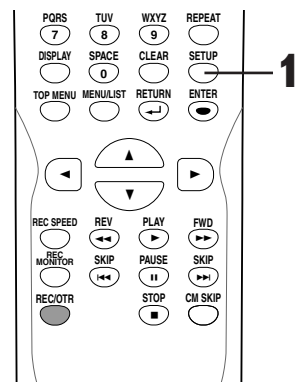

Changing the Setting menu

Audio setting (cont'd)

2

Using [▲ / ▼], select “Advanced Setting Menu”. Hit [ENTER].

Advanced Setting Menu will appear.

3

Using [▲ / ▼], select “Playback”. Hit [ENTER].

Option window will appear.

4

Using [▲ / ▼], select a desired item. Hit [ENTER].

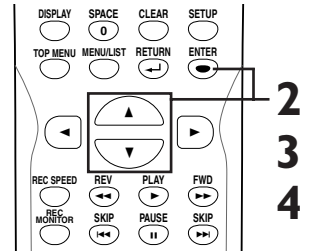

Note

- Dynamic Range Control is available only on the discs which are recorded in Dolby Digital format.

Digital Out

Set the digital audio output.

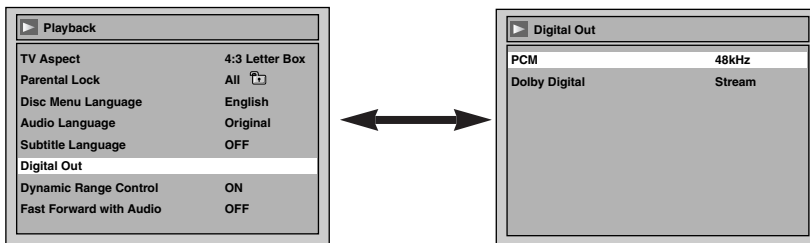

- Using [▲ / ▼], select a setting. Hit [ENTER]. Option window will appear. Proceed to steps A or B.

A Settings for PCM (Default : 48kHz)

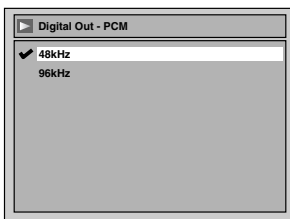

- Using [▲ / ▼], select a setting. Hit [ENTER].

Your setting will be activated.

48kHz : If your amplifier/decoder is NOT compatible with 96kHz PCM, select “48kHz”. 96kHz sound will be output in 48kHz.

96kHz : If your amplifier/decoder is compatible with 96kHz PCM, select “96kHz”. 96kHz sound will be output.

Note

When playing back disc with copyright protection

- Even if you select “96kHz”, the sound will be down sampled at 48kHz.

B Settings for Dolby Digital (Default : Stream)

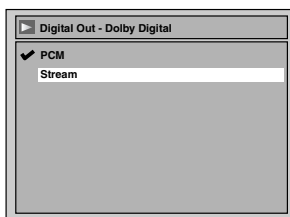

- Using [▲ / ▼], select a setting. Hit [ENTER].

Your setting will be activated.

PCM : Convert the Dolby Digital into PCM (2 channel). When your amplifier/decoder is NOT compatible with Dolby Digital, set to “PCM”.

Stream : Outputs Dolby Digital signals. When your amplifier/decoder is compatible with Dolby Digital, set to “Stream”.

Note

When playing back a DVD-RW disc recorded in VR mode

- If the audio on a disc is recorded in Dolby Digital format, set “Dolby Digital” to “PCM” so that you can switch to main (L), sub audio (R), or a mix of both (L/R) with your amplifier/decoder.

Instructions continue on the next page.

Changing the Setting menu

Audio setting (cont'd)

Dynamic Range Control (Default : ON)

Set to ON to compress the range between soft and loud sounds.

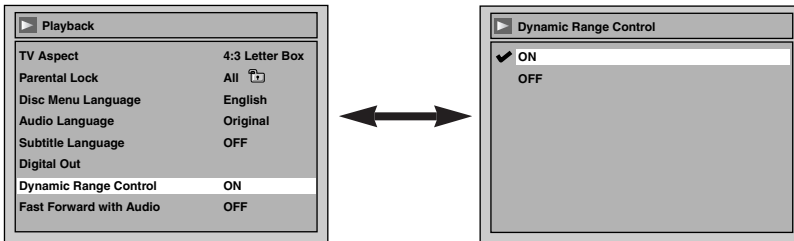

- Using [**▲** / **▼**], select a setting. Hit [**ENTER**]. Your setting will be activated.

Fast Forward with Audio (Default : OFF)

Set to ON to output the sound during playback in x1.5 fast forward.

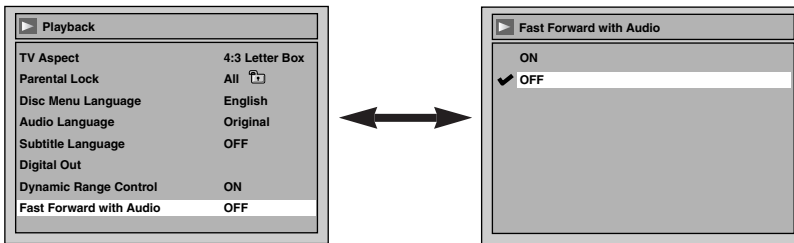

- Using [**▲** / **▼**], select a setting. Hit [**ENTER**]. Your setting will be activated.

5

Hit [**SETUP**] to exit.

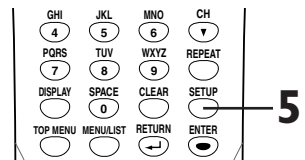

Settings for Parental lock level

Some DVD-Video discs feature a Parental Lock level. Playback will stop if the disc's general rating exceeds the level you set. The unit will require you to enter a password before the disc will be played back. This function prevents your children from viewing inappropriate materials.

Hit [**STOP** ■] if you are playing a disc.

1

Hit [**SETUP**] in the stop mode.

Easy Setting Menu or Advanced Setting Menu will appear. If Advanced Setting Menu is displayed, proceed to step 3.

2

Using [**▲** / **▼**], select "Advanced Setting Menu". Hit [**ENTER**].

Advanced Setting Menu will appear.

3

Using [**▲** / **▼**], select "Playback". Hit [**ENTER**]. Option window will appear.

4

Using [**▲** / **▼**], select "Parental Lock". Hit [**ENTER**].

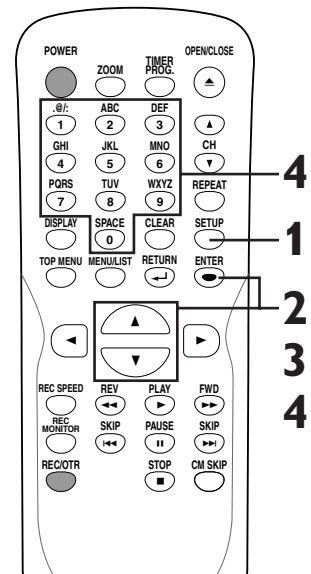

Note

- Parental lock may not be available on some discs.
- For some DVDs, it may be difficult to find if they are compatible with parental lock. Be sure to check if the parental lock operates in the way that you have set.
- Record the password in case you forget it.

Changing the Setting menu

Settings for Parental lock level (cont'd)

Parental Lock (Default :All)

Set the Parental Lock level.

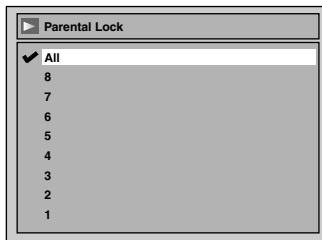
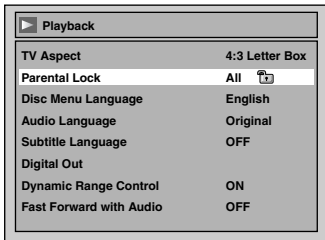

- Using **[▲ / ▼]**, change the parental level. Hit **[ENTER]**.

Option window will appear
Proceed to step A or B.

A A password has not been set yet

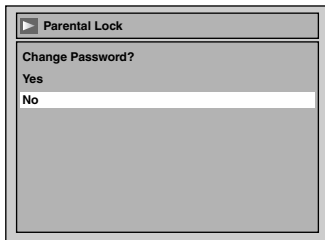

Yes

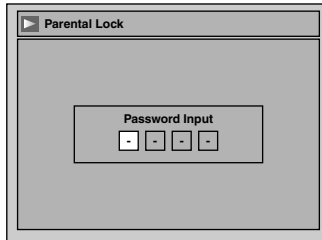

- Using **[▲ / ▼]**, select "Yes". Using the **Number buttons**, enter a new password. Hit **[ENTER]**.

Your setting will be activated.

- If you select "No", proceed to Step 5.

B A password has been set already

Change the password

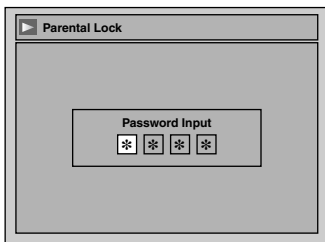

Yes

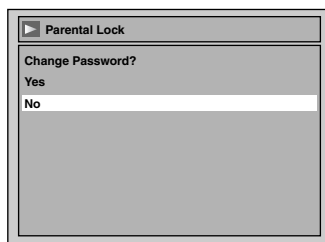

Yes

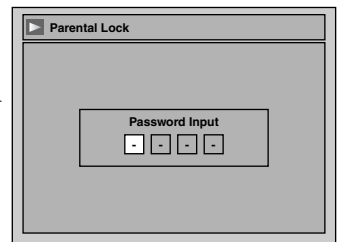

- Using the **Number buttons**, enter the current password.
- If you select "No", proceed to Step 5.
- Using **[▲ / ▼]**, select "Yes". Using the **Number buttons**, enter a new password. Hit **[ENTER]**

Your setting will be activated.

5

Hit **[SETUP]** to exit.

Note

- Hit **[CLEAR]** to erase numbers entered incorrectly.
- Do not use 4, 7, 3, 7 as password.
- When you forget the password or you want to clear all settings in Parental lock, enter 4,7,3,7 using the **Number buttons** in input window at step B. Password will be cleared and parental levels will be set to All.

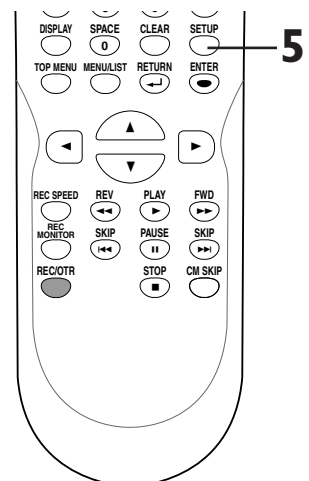

Troubleshooting

Before requesting service for this unit, check the table below for a possible cause of the problem you are experiencing. Some simple checks or a minor adjustment on your part may eliminate the problem and restore proper performance.

Symptom	Remedy
Power The power does not turn on.	<ul style="list-style-type: none"> • Check that the AC power cord is connected securely. • (In case of power failure) Check the breaker.
Picture There is no picture.	<ul style="list-style-type: none"> • Re-connect the connecting cord securely. • The connecting cords are damaged. • The Setup Display appears. Hit [RETURN ←] to turn off the display. • Check the connection to your TV (page 13). • Check if the INTERLACE/PROGRESSIVE mode is set correctly according to your TV (page 14). • Switch the input selector on your TV (such as to "LINE1") so that the signal from this unit appears on the TV screen.
Picture noise appears.	<ul style="list-style-type: none"> • The disc is dirty or flawed. • If the picture output signal from the unit passes through your VCR before reaching your TV, or if you are connected to a combination TV/VIDEO player, the copy-protection signal applied to some DVD programs could affect picture quality. If you still experience this problem even when you connect the unit directly to your TV, try connecting the unit to your TV's S-VIDEO input.
TV program reception does not fill the screen.	<ul style="list-style-type: none"> • Try to set the channels with "Auto Preset" in the Setting menu (page 18). • Select a channel of any TV program using [CH ▲ / ▼].
TV program pictures are distorted.	<ul style="list-style-type: none"> • Adjust TV antenna. • Adjust the picture (see the TV's instruction manual). • Place the unit and TV farther apart. • Place the TV and any bunched antenna cables farther apart.
TV channels cannot be changed.	<ul style="list-style-type: none"> • Switch the input to TV. • Connect the antenna cable correctly (page 13).
Playback picture is distorted	<ul style="list-style-type: none"> • Keep the equipment which may cause electrical disturbances, such as a cellular phone, away.
The playback picture or TV program from the equipment connected through the unit is distorted.	<ul style="list-style-type: none"> • If the playback picture output from a DVD player, VCR or tuner goes through the unit before reaching your TV, the copy-protection signal applied to some programs could affect picture quality. Disconnect the playback equipment in question and connect it directly to your TV.
Sound There is no sound.	<ul style="list-style-type: none"> • The disc is dirty or flawed. • Re-connect all connections securely. • The connecting cord is damaged. • Check the connections to the amplifier input. • The input source setting on the amplifier is incorrect. • The recorder is in pause mode or in Slow-motion Play mode. • The recorder is in fast forward or fast reverse mode. • If the audio signal does not come through the DIGITAL OUT (COAXIAL) jack, check the Audio settings (pages 68-70).
Sound is noisy.	<ul style="list-style-type: none"> • The disc is dirty or flawed.
No DTS sound is output.	<ul style="list-style-type: none"> • This unit is not compatible with DTS sound.
Remote control The remote control does not function.	<ul style="list-style-type: none"> • Batteries are weak. • There are obstacles between the remote control and the unit. • The remote control is far from the unit. • There are no batteries in the remote control. • Turn on the unit. • The remote control is not pointed at the remote sensor on the unit. • If above remedies do not solve the problem, please call the Service Center for help.

Troubleshooting (cont'd)

Symptom	Remedy
Playback The unit does not play back the disc.	<ul style="list-style-type: none"> • No disc is inserted. • A blank disc is inserted. • The disc is upside down. Insert the disc with the labeled side facing up. • The disc is not correctly inserted. • The unit cannot play back certain discs (such as a CD-ROM) (page 37). • The region code on the DVD-Video does not match the ones on the unit (page 37). • Moisture has condensed inside the unit. Remove the disc and leave the unit turned on for about two hours until the moisture evaporates (page 4). • If the disc was recorded on another recorder, the unit cannot play back the disc unless it is finalized (page 35).
Playback image freezes for a second.	<ul style="list-style-type: none"> • During the playback of two layered disc, picture may freeze for a moment when the 1st layer switches to the 2nd layer. This is not a malfunction.
The disc does not start playback from the beginning.	<ul style="list-style-type: none"> • Resume playback was activated (page 41). Hit [STOP ■] twice. • You have inserted a disc whose Title menu or DVD menu automatically appears on the TV screen when it is inserted for the first time.
The unit starts playing back the disc automatically.	<ul style="list-style-type: none"> • The DVD-Video provides an auto playback function.
Some functions such as Stop, Search, or Slow-motion Play cannot be performed.	<ul style="list-style-type: none"> • Depending on the disc, you may not be able to do some of these operations. See the instruction manual supplied with the disc.
The language for the sound track cannot be changed.	<ul style="list-style-type: none"> • Multilingual tracks are not recorded on the DVD-Video, DVD-R or DVD-RW being played back. • The DVD-Video prohibits the changing of the language for the sound track. • Try changing the language using the DVD-Video's menu.
The subtitle language cannot be changed or turned off.	<ul style="list-style-type: none"> • Multilingual subtitle are not recorded on the DVD-Video. • The DVD-Video prohibits changing of the subtitles. • Try changing the subtitles using the DVD-Video's menu.
The angles cannot be changed.	<ul style="list-style-type: none"> • Multi-angles are not recorded on the DVD-Video being played back. • The angle-change operation is possible as long as the disc contains a multi-angle portion. Actual change can be performed when the portion has come up. • The DVD-Video prohibits changing angles. • Try changing the angles using the DVD-Video's menu.
Recording/Timer Recording/Editing	
The channel cannot be changed from the channel you are recording.	<ul style="list-style-type: none"> • Set the TV's input to "TV."
Recording does not start immediately after you hit [REC/OTR] .	<ul style="list-style-type: none"> • An unused DVD-R or DVD-RW was inserted. It takes a while for the unit to automatically format a DVD-RW.
Nothing was recorded even though you set the timer setting correctly.	<ul style="list-style-type: none"> • There was a power failure during recording. • The unit's internal clock stopped due to a power failure that lasted for more than 30 seconds. Reset the clock (pages 21, 22). • Disconnect the AC power cord from the AC outlet, and connect it again. • The program contains copy protection signals that restricts copying. • The timer setting overlapped with another setting that was set later or has priority.
Recording does not stop immediately after you hit [STOP ■] .	<ul style="list-style-type: none"> • It will take a few seconds for the unit to input disc data before recording can stop.
Timer Recording is not completed or did not start from the beginning.	<ul style="list-style-type: none"> • The timer setting overlapped with another setting that was set later or has priority (page 32). • Disc space was not enough.

Before you start

Connections

Getting started

Recording

Disc Playback

Editing

Changing the Setting menu

Others

Español

Troubleshooting (cont'd)

Symptom

Remedy

Others

The unit does not operate properly.

- When static electricity, etc., causes the unit to operate abnormally, unplug the unit and then plug it again.

The disc tray does not open when you press **[OPEN/CLOSE ▲]**.

- It may take a few seconds for the disc tray to open after you have recorded or edited a disc. This is because the unit is adding disc data to the disc.

"Repairing" appears on the display.



- If there is a power failure or unplugging during recording, finalizing, formatting or editing (even after "Wait for a moment." message is disappeared), a Repairing process will begin automatically soon after turning the unit on again. It may take several minutes up to about four hours.

Error message	Cause	Solution
<div style="border: 1px solid black; padding: 2px; text-align: center;">Disc Error</div> <p>— Please eject the disc. — Playback feature may not be available on this Disc.</p>	<p>Unplayable disc is inserted in the unit. The disc is upside down.</p>	<p>Insert the standardized disc which bears the marks on page 37. Insert the disc with the labeled side facing up.</p>
<div style="border: 1px solid black; padding: 2px; text-align: center;">Region Error</div> <p>— Please eject the disc. — Playback is not authorized in your region.</p>	<p>The region of the DVD-Video disc does not match the ones on the unit.</p>	<p>Insert the DVD-Video disc with region code 1 or ALL.</p>
<div style="border: 1px solid black; padding: 2px; text-align: center;">Parental Lock On</div> <p>The current selected parental level prohibits playback.</p>	<p>The current selected parental level in the SETUP Menu prohibits playback.</p>	<p>Check the "Parental Lock" setting (pages 70-71).</p>
<div style="border: 1px solid black; padding: 2px; text-align: center;">Recording Error</div> <p>This program is not allowed to be recorded.</p>	<p>The recording function encountered a copy prohibited program.</p>	<p>You cannot record copy prohibited programs.</p>
<div style="border: 1px solid black; padding: 2px; text-align: center;">Recording Error</div> <p>This program is not recordable in Video mode.</p>	<p>You are trying to record a copy-once program onto the DVD-RW disc in Video mode.</p>	<p>Set "DVD-RW Recording Format" to "VR mode"(page 26).</p>
<div style="border: 1px solid black; padding: 2px; text-align: center;">Recording Error</div> <p>Can not record on this disc.</p>	<p>You are trying to record onto the disc which is unrecordable, or the disc status is unable to record. The disc is dirty. The disc is damaged.</p>	<p>Insert a recordable disc, and ensure the disc status satisfies the recording requirements (pages 24-25). Clean the disc with a cleaning cloth. Replace the disc.</p>
<div style="border: 1px solid black; padding: 2px; text-align: center;">Recording Error</div> <p>This program is not allowed to be recorded on this disc.</p>	<p>You are trying to record a copy-once program onto the DVD-RW disc which is not compatible with CPRM.</p>	<p>Insert a ver:1.1 or 1.2 CPRM compatible DVD-RW disc.</p>
<div style="border: 1px solid black; padding: 2px; text-align: center;">Recording Error</div> <p>This disc is protected and not recordable.</p>	<p>You are trying to record onto the protected disc.</p>	<p>Cancel the disc protect setting in the Disc Setting menu (page 34).</p>
<div style="border: 1px solid black; padding: 2px; text-align: center;">Recording Error</div> <p>Disc is full. (No area for new recording)</p>	<p>You are trying to record onto the disc with no recording space left.</p>	<p>Insert the recordable disc with enough recording space.</p>

Troubleshooting (cont'd)

Error message	Cause	Solution
<div style="border: 1px solid black; padding: 2px; margin-bottom: 5px;">Recording Error</div> You cannot record more than 99 titles on one disc. (The maximum is 99)	You are trying to record onto the disc on which the number of recording titles already reached the maximum (99).	Delete unnecessary titles (pages 52, 55).
<div style="border: 1px solid black; padding: 2px; margin-bottom: 5px;">Recording Error</div> You cannot record more than 999 chapters on one disc. (The maximum is 999)	You are trying to record onto the VR mode DVD-RW disc on which the number of recording chapters already reached to the maximum (999).	This unit cannot delete the original chapter. Delete unnecessary chapter marker using other DVD recorders. Delete unnecessary titles from the Original list (page 55).
<div style="border: 1px solid black; padding: 2px; margin-bottom: 5px;">Recording Error</div> You cannot record on this disc as Control Information is full.	This disc has no space to write the Control Information when recording or deleting contents. When editing has been repeatedly performed, the control Information area may become full even if the recording area still has enough space.	Delete unnecessary titles (pages 52, 55).
<div style="border: 1px solid black; padding: 2px; margin-bottom: 5px;">Recording Error</div> You cannot record on this disc as Power Calibration Area is full.	When recordings are performed repeatedly onto an unstable disc, this area may become full. Every time you insert a disc for recording, the disc's working area will be taken up. And if you repeat this frequently, it will be used up sooner and you may not be able to record full 99 titles.	Insert a new disc.
<div style="border: 1px solid black; padding: 2px; margin-bottom: 5px;">Recording Error</div> This disc is already finalized.	You are trying to record onto the disc already finalized.	Undo finalizing of the disc (page 35).

* If you are still having trouble with the unit after checking Troubleshooting, write down the error code and the error description, and call our help line mentioned on the front page to locate an Authorized service center.

Language code

Language	Code	Language	Code	Language	Code	Language	Code
Afan) Oromo	6159	Finnish	5255	Lingala	5860	Sindhi	6550
Abkhazian	4748	French	5264	Lithuanian	5866	Singhalese	6555
Afar	4747	Frisian	5271	Macedonian	5957	Siswat	6565
Afrikaans	4752	Galician	5358	Malagasy	5953	Slovak	6557
Albanian	6563	Georgian	5747	Malay	5965	Slovenian	6558
Amharic	4759	German	5051	Malayalam	5958	Somali	6561
Arabic	4764	Greek	5158	Maltese	5966	Spanish	5165
Armenian	5471	Greenlandic	5758	Maori	5955	Sundanese	6567
Assamese	4765	Guarani	5360	Marathi	5964	Swahili	6569
Aymara	4771	Gujarati	5367	Moldavian	5961	Swedish	6568
Azerbaijani	4772	Hausa	5447	Mongolian	5960	Tagalog	6658
Bashkir	4847	Hebrew	5569	Nauru	6047	Tajik	6653
Basque	5167	Hindi	5455	Nepali	6051	Tamil	6647
Bengali; Bangla	4860	Hungarian	5467	Norwegian	6061	Tatar	6666
Bhutani	5072	Icelandic	5565	Occitan	6149	Telugu	6651
Bihari	4854	Indonesian	5560	Oriya	6164	Thai	6654
Bislama	4855	Interlingua	5547	Panjabi	6247	Tibetan	4861
Breton	4864	Interlingue	5551	Pashto; Pushto	6265	Tigrinya	6655
Bulgarian	4853	Inupiak	5557	Persian	5247	Tonga	6661
Burmese	5971	Irish	5347	Polish	6258	Tsonga	6665
Byelorussian	4851	Italian	5566	Portuguese	6266	Turkish	6664
Cambodian	5759	Japanese	5647	Quechua	6367	Turkmen	6657
Catalan	4947	Javanese	5669	Rhaeto-Romance	6459	Twi	6669
Chinese	7254	Kannada	5760	Romanian	6461	Ukrainian	6757
Corsican	4961	Kashmiri	5765	Russian	6467	Urdu	6764
Croatian	5464	Kazakh	5757	Samoan	6559	Uzbek	6772
Czech	4965	Kinyarwanda	6469	Sangho	6553	Vietnamese	6855
Danish	5047	Kirghiz	5771	Sanskrit	6547	Volapuk	6861
Dutch	6058	Kirundi	6460	Scots Gaelic	5350	Welsh	4971
English	5160	Korean	5761	Serbian	6564	Wolof	6961
Esperanto	5161	Kurdish	5767	Serbo-Croatian	6554	Xhosa	7054
Estonian	5166	Laothian	5861	Sesotho	6566	Yiddish	5655
Faroese	5261	Latin	5847	Setswana	6660	Yoruba	7161
Fiji	5256	Latvian; Lettish	5868	Shona	6560	Zulu	7267

Glossary

Analog audio

An electrical signal that directly represents sound. In contrast, digital audio can be an electrical signal, but is an indirect representation of sound. See also Digital audio.

Aspect ratio

The width of a TV screen relative to its height. Conventional TVs are 4:3 (in other words, the screen is almost square); widescreen models are 16:9 (the screen is almost twice as wide as it is high).

Chapter

Just as a book is split up into several chapters, a title on a DVD disc is usually divided into chapters. See also Title.

Component video output

This is a video signal format that conveys each of three principal colors of light (red, blue and green) through different signal lines. This allows the viewers to experience picture colors as original as it is. There are several signal formats, including Y/Pb/Pr and Y/Cb/Cr.

CPRM**(Content Protection for Recordable Media)**

This is a format used to record copy-once programs. By recording coded data on the area of DVD discs that ordinary writing software cannot write on, it prevents copy-once programs from being recorded repeatedly on different media.

Digital audio

An indirect representation of sound by numbers. During recording, the sound is measured at discrete intervals (44,100 times a second for CD audio) by an analog-to-digital converter, generating a stream of numbers. On playback, a digital-to-analog converter generates an analog signal based on these numbers. See also Sampling frequency and Analog audio.

Dolby Digital

The system developed by Dolby Laboratories to compress digital sound. It offers you sound of stereo(2ch) or multi-channel audio (up to 5.1ch).

Finalize

To make recorded contents on DVD discs possible to be played back on DVD players. With this unit, it is possible to finalize DVD-R/DVD-RW discs.

MP3 (MPEG Audio Layer 3)

MP3 is a method of compressing files. You can copy MP3 files on CD-RW/R discs from the computer and play back the files on this unit.

PCM**(Pulse Code Modulation)**

PCM is a format that converts audio into digital data. It is mainly used for Audio CDs and DAT. This unit can play back sounds as realistic as possible by converting even compressed Dolby Digital and MPEG audio to PCM.

Playlist

From this list you can play back contents of a disc in your desired order or sequence. Also it allows to search a specific scene directly.

Progressive Scan (525p/480p)

A type of display that does not split each frame into fields, and instead scans directly through all the scanlines of each frame in order. Progressive Scan provides less flickering and higher image resolution than traditional (525i/480i) TV signals. Refer to page 14 for instructions on selective Progressive Scan mode.

Regions code

Regions associate discs and players with particular areas of the world. This unit will only play back discs that have compatible region codes. You can find the region code of your unit by looking at the rear panel. Some discs are compatible with more than one region (or all regions).

Sampling frequency

The rate which sound is measured by a specified interval to turn it into digital audio data. The numbers of sampling in one second defines as sampling frequency. The higher the rate, the better the sound quality is.

SAP**(Secondary Audio Program)**

Sub-audio channel which is delivered separately from main-audio channel. This audio channel is used as an alternate in bilingual broadcasting.

S-Video output

It delivers independently each signal of color(C) and luminance(Y) to TV as video signals, so that higher-quality picture will be materialized.

Title (DVD only)

A collection of chapters on DVD disc. See also chapter.

Track

Audio CDs use tracks to divide the content of a disc. The DVD equivalent is called a chapter. See also Chapter.

Frequently Asked Questions

- Can I record on CD-R/RW?
No, this unit records only DVDs.
- Can I play back DVD-Video that is bought in another country?
Possible only if the region code of the disc is 1 or ALL.
- Is this unit JPEG compatible?
No.
- Can I connect the unit to my PC?
No, you cannot control the unit by PCs.

Specifications

General

System	DVD-Video, DVD-RW/R, CD-DA, CD-RW/R
Power requirements	AC120V, 60 Hz
Power consumption	20 W (standby: 3.6 W)
Weight	5.06 lbs (2.3 kg)
Dimensions (width x height x depth)	17 3/16" x 2 5/8" x 9 5/8" (435 x 66 x 244 mm)
Operating temperature	41F° to 104F° (5°C to 40°C)
Operating humidity	less than 80% (no condensation)
TV format	NTSC

Recording

Recording format	Video Recording format (DVD-RW only), Video format (DVD-RW, DVD-R)
Recordable discs	DVD-Rewritable, DVD-Recordable
Video recording format	
Sampling frequency	13.5MHz
Compression format	MPEG
Audio recording format	
Sampling frequency	48kHz
Compression format	Dolby Digital

Tuner

Receivable channels	
VHF	2-13ch
UHF	14-69ch
CATV	C1-C125ch

Input/Output

VHF/UHF antenna input/output terminal	VHF/UHF set 75Ω
Video input	Input 1 (rear), 2 (front)
Input level	1 Vp-p (75Ω)
Jacks	RCA jack
Video output	Output 1
Output level	1 Vp-p (75Ω)
Jack	RCA jack
S-Video input	Input 1 (rear), 2 (front)
Y (luminance) - Input level	1 Vp-p (75Ω)
C (color) - Input level	286 mVp-p (75Ω)
Jacks	4 pin mini DIN
S-Video output	
Y (luminance) - Output level	1 Vp-p (75Ω)
C (color) - Output level	286 mVp-p (75Ω)
Jack	4 pin mini DIN
Component video output	
Output level	Y: 1.0 Vp-p (75Ω), Pb/Cb, Pr/Cr: 0.7 Vp-p (75Ω)
Jacks	RCA jacks
Audio input	Input 1 (rear), 2 (front) L/R
During audio input	2V rms (Input impedance: more than 22kΩ)
Jacks	RCA jacks
Audio output	Output 1 L/R
During audio output	2V rms (Output impedance: less than 1kΩ)
Jacks	RCA jacks
Digital audio output	
Output level	500 mVp-p (75Ω)
Jacks	RCA jack

Note:

The specifications and design of this product are subject to change without notice.

Fácil grabación de DVD

Estas instrucciones le ayudarán a entender fácilmente cómo grabar discos DVD.

Nota:

Asegúrese que las pilas están en el mando a distancia y que ha conectado correctamente esta unidad y el TV.

Paso 1: Elija un tipo de disco

Puede elegir entre distintos tipos de discos DVD grabables. Elija un tipo de disco DVD grabable de acuerdo con sus necesidades de reproducción/grabación. Vea los "tipos de discos DVD" en la parte inferior de esta página para más detalles sobre las diferencias entre los distintos medios compatibles.

Este grabador de DVD puede grabar los siguientes tipos de discos.

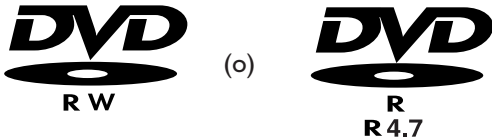

Por ejemplo, cuando desea grabar repetidamente en el mismo disco o cuando desea editar el disco después de grabar, seleccione el disco de tipo regrabable DVD-RW.

Cuando desea guardar grabaciones sin alterarlos, un DVD no regrabable DVD-R puede ser más conveniente.

Paso 2: Coloque un disco en blanco

Mando a distancia

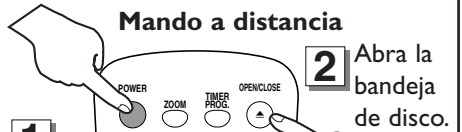

1 Encienda la unidad.

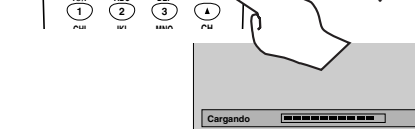
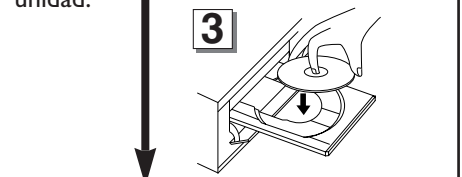

Esta operación puede demorar en reconocerse.

Tipos de discos DVD

☆☆☆ : Más adecuado ☆☆☆ : Puede utilizar ☆ : Algunas funciones son limitadas — : No puede utilizar

Desea	DVD-RW VR	DVD-RW Video	DVD-R
Grabar programas de TV	☆☆☆	☆☆☆	☆☆
Volver a utilizar borrando partes no deseadas	☆☆☆	☆☆	—
Editar las grabaciones	☆☆☆	☆	☆
Editar/grabar de equipos conectados	☆☆☆	☆☆☆	☆☆☆
Copiar discos para distribución	☆☆ ^{*1}	☆☆☆	☆☆☆
Reproducir en otro equipo de DVD	☆☆ ^{*1}	☆☆☆	☆☆☆

Detalles DVD-RW VR DVD-RW Video DVD-R

Grabación	DVD-RW VR	DVD-RW Video	DVD-R
¿Regrabable?	Sí	Sí	No
Puede crear capítulos a intervalos fijos (auto.)	Sí	Sí	Sí
Puede crear capítulos donde desee (manual)	Sí	No	No
Puede grabar imágenes de tamaño 16:9	Sí	Sí	Sí
Puede grabar un programa de Copia-una-vez	Sí	No	No
Edición			
Puede hacer funciones de edición básica	Sí	Sí	Sí
Puede hacer funciones de edición avanzadas (edición de lista a reproducir)	Sí	No	No

*1 El DVD-RW (modo VR) sólo puede reproducirse en equipos de DVD compatibles con VR.

Nota:
Para más detalles sobre las funciones anteriores y las limitaciones implícitas, lea las explicaciones en este manual.

Formato del disco

Cuando coloque un disco que fue grabado, puede borrar todo el contenido formateando el disco.

Esto es necesario para preparar el disco para grabación. Vea los detalles en las páginas 26-27.

* Al formatear, todo el contenido de ese disco se borrará.

- La unidad empieza a iniciar automáticamente cuando se inserta un disco no usado.

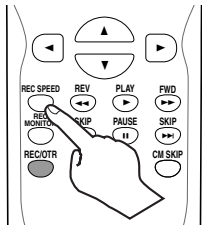
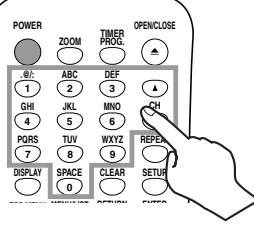
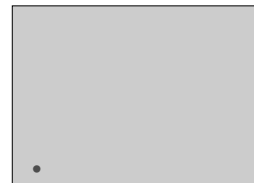
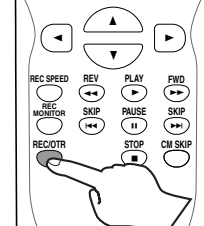
Paso 3: Seleccione la velocidad de grabación**Paso 4: Seleccione el canal deseado****Paso 5: Grabe en discos DVD****Sugerencia 1: Reproduzca el contenido grabado**

Puede seleccionar el título que desea reproducir de un menú indicado y empiece a reproducir inmediatamente. El contenido grabado se puede acceder fácilmente con un simple procedimiento de elegir un título en un capítulo en la pantalla del menú.

¿Qué son títulos y capítulos?

El contenido de un disco DVD se divide generalmente en títulos. Los títulos pueden dividirse a su vez en capítulos.

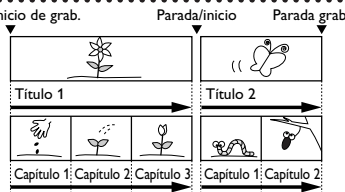
**Sugerencia 2: Edite el disco grabado**

La edición de discos es fácil. Esta unidad ofrece convenientes funciones de edición que sólo son posibles con discos DVD-R/RW.

Puede editar lo siguiente de la lista de títulos.

- Poniendo nombres en títulos
- Seleccionando imágenes para índices
- Seleccionando/borrando marcadores de capítulos
- Borrado de títulos o escenas

(Las funciones editables dependen del modo de grabación y forma de edición.)

Original y Playlist (modo VR)

Puede editar las grabaciones en la lista a reproducir sin cambiar las grabaciones originales. Cualquier lista a reproducir no ocupa mucho espacio en el disco.

¿Qué significa "Original" o "Playlist"?

A lo largo de este manual encontrará *Original* y *Playlist* que se refieren a las grabaciones reales y la versión editada.

- La grabación **Original** se refiere a la grabación real en el disco.
- El **Playlist** se refiere a la versión editada del disco; cómo se va a reproducir la versión Original.

Finalización de un disco

- Para reproducir el disco en un reproductor DVD diferente, grabe el disco en el modo de vídeo y finalizelo.
- Después de finalizar un disco grabado en el modo de vídeo, no puede grabar y editar la información que se encuentre en este disco.
- Para un disco grabado en el modo VR, la edición podrá realizarse incluso después de la finalización.

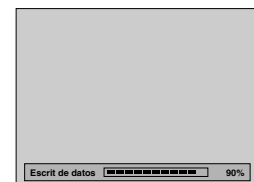
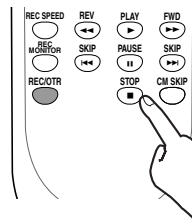
Paso 6: Pare la grabación

(Aparece sólo en el modo VR)

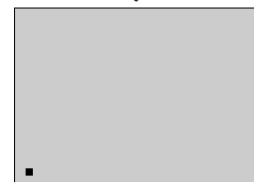

Esta operación puede demorar en completarse.

SYLVANIA

LIMITED WARRANTY

FUNAI CORP. will repair this SYLVANIA product, free of charge in the USA in the event of defect in materials or workmanship as follows:

DURATION:

PARTS: FUNAI CORP. will provide parts to replace defective parts without charge for one (1) year from the date of original retail purchase. Certain parts are excluded from this warranty.

LABOR: FUNAI CORP. will provide the labor without charge for a period of ninety (90) days from the date of original retail purchase.

LIMITS AND EXCLUSIONS:

This warranty is extended only to the original retail purchaser. A purchase receipt or other proof of original retail purchase will be required together with the product to obtain service under this warranty.

This warranty shall not be extended to any other person or transferee.

This warranty is void and of no effect if any serial numbers on the product are altered, replaced, defaced, missing or if service was attempted by an unauthorized service center. This SYLVANIA Limited warranty does not apply to any product not purchased and used in the United States.

This product is produced for home use and this warranty only covers failures due to defects in material or workmanship which occurs during normal use. It does not cover damage which occurs in shipment, or failures which are caused by repairs, alterations or product not supplied by FUNAI CORP., or damage which results from accident, misuse, abuse, mishandling, misapplication, alteration, faulty installation, improper maintenance, commercial use such as hotel, rental or office use of this product or damage which results from fire, flood, lightning or other acts of God.

THIS WARRANTY DOES NOT COVER PACKING MATERIALS, ANY ACCESSORIES (EXCEPT REMOTE CONTROL), ANY COSMETIC PARTS, COMPLETE ASSEMBLY PARTS, DEMO OR FLOOR MODELS.

FUNAI CORP. AND ITS REPRESENTATIVES OR AGENTS SHALL IN NO EVENT BE LIABLE FOR ANY GENERAL, INDIRECT OR CONSEQUENTIAL DAMAGES ARISING OUT OF OR OCCASIONED BY THE USE OF OR THE INABILITY TO USE THIS PRODUCT. THIS WARRANTY IS MADE IN LIEU OF ALL OTHER WARRANTIES, EX OR IMPLIED, AND OF ALL OTHER LIABILITIES ON THE PART OF FUNAI, ALL OTHER WARRANTIES INCLUDING THE WARRANTY OF MERCHANTABILITY AND FITNESS FOR A PARTICULAR PURPOSE, ARE HEREBY DISCLAIMED BY FUNAI AND ITS REPRESENTATIVES IN THE UNITED STATES. ALL WARRANTY INSPECTIONS AND REPAIRS MUST BE PERFORMED BY A FUNAI AUTHORIZED SERVICE CENTER. THIS WARRANTY IS ONLY VALID WHEN THE UNIT IS CARRIED-IN TO A FUNAI AUTHORIZED SERVICE FACILITY.

IMPORTANT:

THIS LIMITED WARRANTY GIVES YOU SPECIFIC LEGAL RIGHTS. YOU MAY HAVE OTHER RIGHTS THAT VARY FROM STATE TO STATE. IF, AT ANY TIME DURING THE WARRANTY PERIOD, YOU ARE UNABLE TO OBTAIN SATISFACTION WITH THE REPAIR OF THIS PRODUCT, PLEASE CONTACT FUNAI CORP.

ATTENTION:

FUNAI CORP. RESERVES THE RIGHT TO MODIFY ANY DESIGN OF THIS PRODUCT WITHOUT PRIOR NOTICE.

To locate your nearest Authorized Service Center or for general service inquiries, please call or write to the following:

FUNAI CORPORATION, INC. SERVICE CENTER

19900 Van Ness Avenue, Torrance, CA 90501

Tel :1-800-605-8453

<http://www.SylvaniaConsumerElectronics.com>

Head Office: 100 North Street, Teterboro, NJ 07608

PLEASE DO NOT SHIP YOUR UNIT TO THE TETERBORO ADDRESS.

Free Manuals Download Website

<http://myh66.com>

<http://usermanuals.us>

<http://www.somanuals.com>

<http://www.4manuals.cc>

<http://www.manual-lib.com>

<http://www.404manual.com>

<http://www.luxmanual.com>

<http://aubethermostatmanual.com>

Golf course search by state

<http://golfingnear.com>

Email search by domain

<http://emailbydomain.com>

Auto manuals search

<http://auto.somanuals.com>

TV manuals search

<http://tv.somanuals.com>