

SYLVANIA

SDPF1089



USER'S MANUAL

Table of Contents

Safety Precaution	1
Introduction	3
Installing Your Unit	3
Main Unit Controls	4
System Connection	4
Using Your Remote Control	5
Using Your Digital Picture Frame On The Remote Control	6
Browsing Images	6
Setting	6
Troubleshooting	9
Specifications	9

Safety Precaution

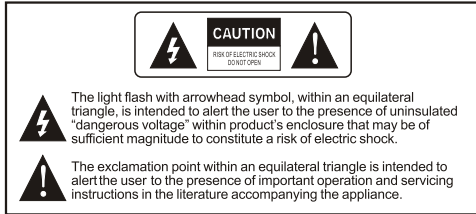

Warning: To reduce the risk of fire or electric shock, do not expose this apparatus to rain or moisture.

- 1) Please read the instruction manual carefully and follow all the requirements of safe operation to operate the device.
- 2) Do not use this unit near water. Do not place over the unit any container with liquid inside.
- 3) Do not install near any heat sources such as radiators, heat registers, stoves, or other apparatus (including amplifiers) that produce heat.
- 4) Unplug this unit during lightning storms or when unused for long time.
- 5) About Cleaning: Unplug the system, use only wet cloth to clean. Do not use liquid detergent or aerosol.
- 6) Only use accessories specified by the manufacturer.
- 7) Refer all servicing to qualified service personnel, servicing is required when the unit has been damaged in any way, such as power supply cord or plug is damaged, liquid has been spilled or objects have fallen into the unit, exposed to moisture, does not operate normally. Don't try to repair the machine by yourself because of the danger of high voltage and electric shock.

This device complies with Part 15 of the FCC Rules. Operation is subject to the following two conditions: (1) This device may not cause harmful interference, and (2) This device must accept any interference received, including interference that may cause undesired operation.

Warning: Changes or modifications to this unit not expressly approved by the party responsible for compliance could void the user's authority to operate the equipment.

NOTE: This equipment has been tested and found to comply with the limits for a Class B digital device, pursuant to Part 15 of the FCC Rules. These limits are designed to provide reasonable protection against harmful interference in a residential installation. This equipment generates, uses and can radiate radio frequency energy and, if not installed and used in accordance with the instructions, may cause harmful interference to radio communications.

However, there is no guarantee that interference will not occur in a particular installation. If this equipment does cause harmful interference to radio or television reception, which can be determined by turning the equipment off and on, the user is encouraged to try to correct the interference by one or more of the following measures:

- .. Reorient or relocate the receiving antenna.
- .. Increase the separation between the equipment and receiver.
- .. Connect the equipment into an outlet on a circuit different from that to which the receiver is connected.
- .. Consult the dealer or an experienced radio/TV technician for help.



Energy Verified
Rendement
Énergétique Vérifié

Introduction

Congratulations on your purchase of Digital Photo Frame, model SDPF1089. Before operating the units, please read this manual thoroughly, and retain it for future reference. This manual will help you use many of the exciting and useful features that will make your Digital Photo Frame viewing more enjoyable.

This Digital Photo Frame lets you view digital pictures directly from your camera's memory cards. You will be able to create a slideshow using multiple transition effects or display one picture at a time.

This Digital Photo Frame is compatible with the following popular memory card formats: USB, SD, MultiMedia Card, and Memory Stick.

Package Contents

- Power Adaptor
- Digital Photo Frame
- User's Manual
- Remote Control
- Stand

Installing Your Unit

Locate the removable easel and place in the corresponding holes at the back of the unit.

Plug in the AC adaptor into power outlet. Plug the other end into the unit.

After the connect is stored on the target flash device. Insert the device into the correct slot.

Note: Please ensure that you have one photo file loaded onto the memory card.

Main Unit Controls

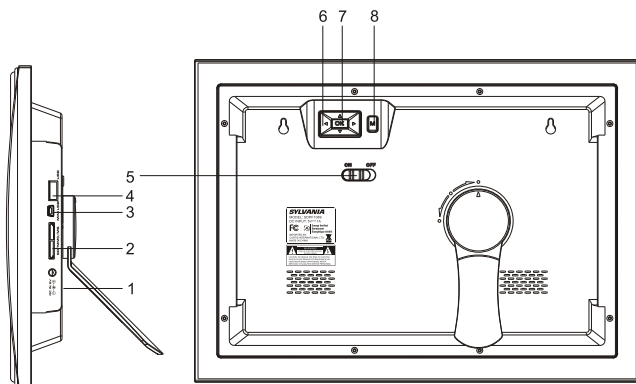

1. **DC in 5V**
2. **SD card slot**
3. **MINI USB port**
4. **USB port**
5. **ON/OFF** :turn on and turn off the unit
6. **▲▼** :Use this button to move cursor up and down when at setting menu, and at main menu,you can use this button to select media device.
 - ◀▶ : Use this button to move cursor left and right when at setting menu and main menu. when playing JPEG files,press it to play prev/next JPEG file.
7. **OK**: To confirm.
8. **M**: Press it to return the main menu at once.

System Connection

Power connection

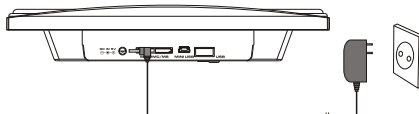

Plug one end of the supplied AC/DC power adaptor into the DC input jack of the machine, then plug the other end into the AC power receptacle. Please refer to the illustration above.

Using your SD card

Upon using an SD card, insert it to the corresponding slot flatly with the label side backward.

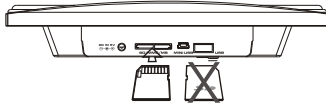

Note: Please do not disconnect USB device or plug out SD/MMC/MS card while they are working with the unit. Functional failure may occur in case of wrong operations.

Using Your Remote Control

Button Description and Function:

Setup: To enter into setup menu

▲▼ : Use this button to move cursor up and down when at setting menu, and at main menu, you can use this button to select media device.

◀▶ : Use this button to move cursor left and right when at setting menu and main menu. when playing JPEG files, press it to play prev/next JPEG file.

Esc: Return to the previous step.

OK : To confirm and play/pause.

ZOOM: when the picture is displaying, press "zoom" to zoom out the picture to 125%, 150%, 175%, 200%, 225%, 250%.

ROTATE: when displaying pictures, press it to rotate the picture to 90°, 180°, 270°, 0°.

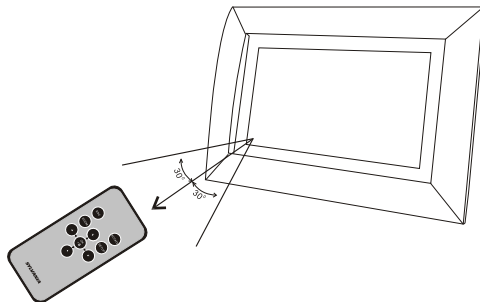

Using Your Digital Picture Frame on the remote control

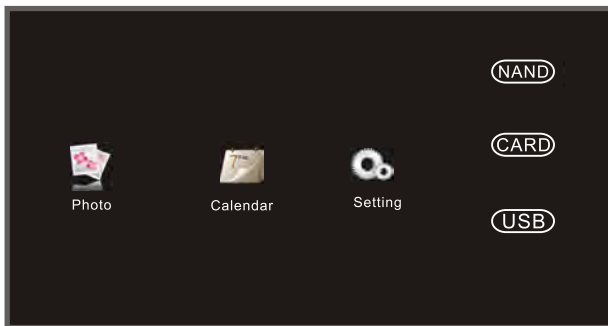



Using the directional arrows ▲ ▼ ◀ ▶, highlight the desired SD/MMC/MS-USB media device. Press  button to select one device, then you can enter into Photo/Calendar/Setting interface by press  button.

Browsing Images

When displaying the pictures, you can press "Esc" button to return to thumbnail. And you can use ▲ ▼ ◀ ▶ to select the picture, press  button to browse the picture, you have selected.

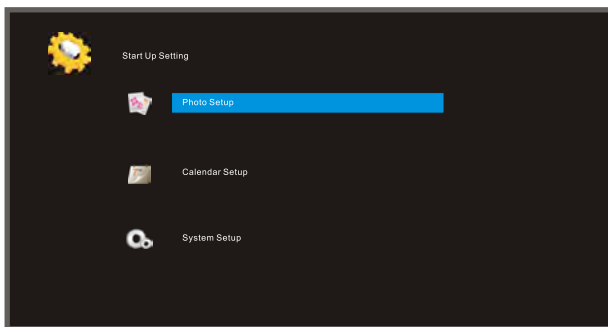
Setting



Press "◀▶" to select setting icon, press  to enter

Press "Setup" button on the remote control to enter setup menu when you are at other menu.

In the Setup menu, press ▲ ▼ button to highlight the item. Press  button to access. Press ESC to exit.

PHOTO SETUP



In the Photo Setup menu, press ▲ ▼ to highlight the item. Press ◀ ▶ to change the settings. Press ESC to return the Setup menu.

Display Mode: Select image display mode (Slideshow,Thumbnail,Browse Mode)

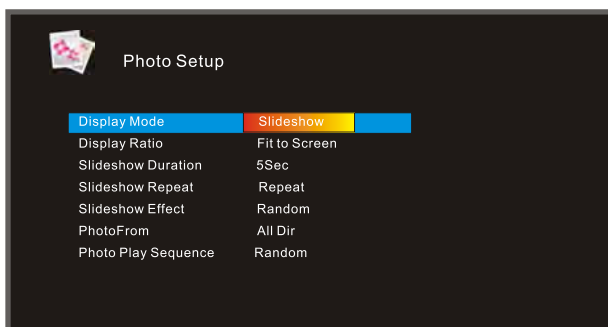
Display Ratio:Select image display size(Fit to Screen,Crop to Fill,Full Screen)

Slideshow Duration: Select the duration of time (5Sec,15Sec,30Sec,60Sec,5Min,15Min)

Slideshow Repeat : Select the manner of repeating photos (Once,Repeat)

Slideshow effect: Adjust the transition effect between eachimage in a slideshow. Optional effect includes Random/S-curve/Partition/Erase/Blinds/Random lines/Grid/Gross/Rect/Spiral/Close.

Photo From: select the resource of the Photo(All Dir/Current Dir).

Photo paly sequence: Random/sequence

Calendar Setup

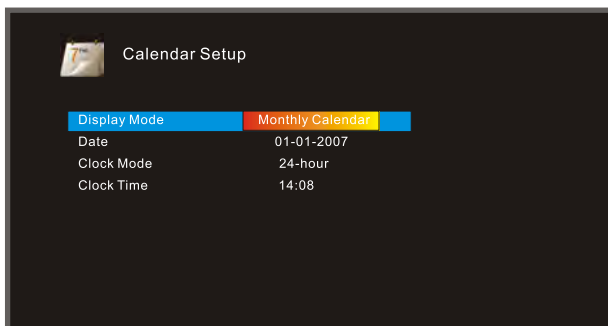

Display Mode : Select calendar display mode (Monthly calendar/Calendar/Clock)

Date : When the cursor position moving to the Icon,using the directional arrows ▲ ▼ ◀ ▶ to adjust the date.

Clock Mode : When the cursor position moving to the Icon,using the directional ◀ ▶ to adjust the Clock Mode(24hr, 12hr).

Clock :When the cursor position moving to the Icon,using the directional ▲ ▼ ◀ ▶ to adjust the time.

System Setup

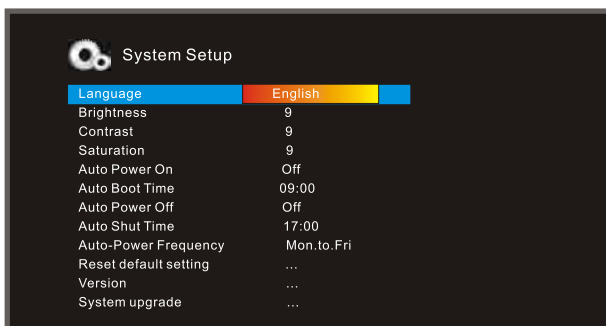

Language : Select the on screen display language English/French/Deutsch/Italian.

Brightness :Adjust screen brightness(between 1~16).

Contrast : Adjust screen contrast(between 1~16).

Saturation : Adjust screen saturation (between 1~16).

Auto Power On : When the cursor position moving to the Icon,using the directional ◀ ▶ to select the unit auto Power on mode(on/off).

Auto Boot Time : When the cursor position moving to the Icon,using the directional ▲ ▼ ◀ ▶ to select the unit auto Power on time.

Auto Power Off : When the cursor position moving to the Icon,using the directional ◀ ▶ to select the unit auto Power off mode(on/off).

Auto Shut Time : When the cursor position moving to the Icon,using the directional ▲ ▼ ◀ ▶ to select the unit auto Power off time.

Auto-Power Frequency : When the cursor position moving to the Icon,using the directional ◀ ▶ to select the unit Auto-Power Frequency mode(Everyday/Mon.to Fri./Weekend/Once),

Reset default setting : When the cursor position moving to the Icon, pressing “” to show the dialog, and select “YES”, press “” to revert to the factory settings.

Version : When the cursor position moving to the Icon, pressing “” to show the dialog of the software version number.

System upgrade: using it to upgrad the system.

Troubleshooting

Symptom	Cause	Corrective Actions
Digital Photo Frame doesn't power on	The power connector to the unit is not securely inserted.	Make sure you connect the AC adaptor to the frame properly. When you connect the AC adaptor to the frame and power on the unit, even without a memory card, you should see the main menu. If you don't see it, check if the power is connected to the Digital Photo Frame and make sure it is securely attached.
No photo files on the memory card	Card is wrongly inserted	Verify if the way you inserted the card is correct. Make sure the front label of the memory card is facing AWAY from the front of the unit. Do not force the memory card into the slot.
The file doesn't play.	Incompatible file format	Make sure there is at least one supported image file on the memory card. Compatible photo format: JPEG

Specifications

Type	10.1 inch Digital Photo Frame
Resolution	1024*600 Pixel
Output	5V 1.0 A
Input	AC100-240V~50/60Hz
Working Temperature	0-40°C
Display Mode	16:9
File Format	JPEG/BMP
Cards	SD/MMC/MS
Dimension	320*229*50.6 mm
Weight	0.943 kg

Copy and Delete

User can copy or delete images from the storage device(SD card, USB stick) to the photo frame, when the image is displayed on the screen, press the "▲" button on the remote, the screen will display four options as follow:

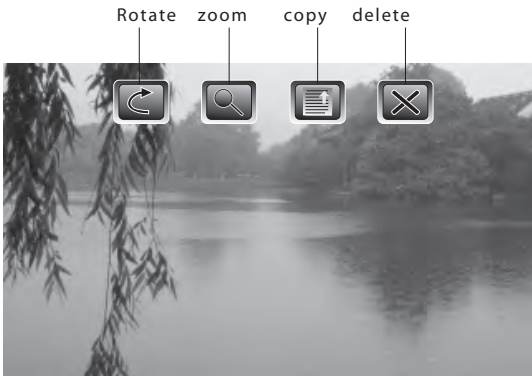

Press the "◀▶" and "OK" button to select the options.

Also, you can connect the photo frame to the PC, by using a mini USB cable to copy photos into the internal memory.

Free Manuals Download Website

<http://myh66.com>

<http://usermanuals.us>

<http://www.somanuals.com>

<http://www.4manuals.cc>

<http://www.manual-lib.com>

<http://www.404manual.com>

<http://www.luxmanual.com>

<http://aubethermostatmanual.com>

Golf course search by state

<http://golfingnear.com>

Email search by domain

<http://emailbydomain.com>

Auto manuals search

<http://auto.somanuals.com>

TV manuals search

<http://tv.somanuals.com>