

# Lighting and Fan Speed Controls

## INDEX

### Architectural Lighting Control Systems

Dimensions™ D3200 .....	C2-C5
Dimensions™ D4200 .....	C6, C7
Power Extenders .....	C8
Dimensions™ a-2000 Modular Dimming Cabinets .....	C9

### Architectural Specification

Overview .....	C10
Monet® Controls .....	C11, C12
Monet® Multi-Gang Wallplates .....	C13
Renoir® Preset Slide Controls .....	C14, C15
Van Gogh® Rotary Dimmers .....	C16

### Ganging and Derating Lighting Controls

.....	C17
-------	-----

### Mural Lighting Controls

Overview .....	C18
Mural® L/S Preset Decora Digital Dimmers .....	C19
Mural® Decora Digital Dimmers .....	C20
Mural® Decora Scene Controls .....	C21, C22

### Touch Lighting Controls

Overview .....	C23
TouchPoint™ Decora Preset Dimmer .....	C24
True Touch™ Decora Digital Touch Dimmer .....	C25
ToggleTouch™ Touch Pad Dimmer .....	C26

### Traditional Lighting Controls

Overview .....	C27
IllumaTech™ Decora Preset Slide Controls .....	C28
IllumaTech™ Decora Rotary Controls .....	C29
IllumaTech™ Decora Slide-To-Off Slide Controls .....	C30
SureSlide™ Decora Controls .....	C31
Trimatron™ Deluxe Rotary Controls .....	C32

### Incandescent Lighting Controls

Toggle Dimmers .....	C33
Decora 911 Flasher Switch .....	C33
4-Level Step Dimmer .....	C34
Feed-Through Lamp Cord Dimmers .....	C34
Tabletop Dimmer .....	C34
Full-Range Dimmer Socket .....	C34





# DIMENSIONS™ ARCHITECTURAL LIGHTING CONTROL SYSTEM FEATURES

## Commercial Grade Lighting Controls

WHETHER IT'S ADVANCED ARCHITECTURAL LIGHTING CONTROL SYSTEMS THAT CAN BE CUSTOM-MANUFACTURED FOR ANY SITE-SPECIFIC REQUIREMENT OR INNOVATIVE BOX-MOUNTED CONTROLS FOR INCANDESCENT, LOW-VOLTAGE AND FLUORESCENT LIGHTING, LEVITON HAS THE PRODUCTS YOU CAN DEPEND ON.

Our designer preset systems and distributed programmable computer-controlled systems are ideal for large-scale, multi-use environments. Leviton's innovative line of box-mounted controls includes digital multi-location devices that provide maximum performance in architectural, commercial and residential settings.

### Dimensions Architectural Lighting Control Systems

Each Dimensions® System combines ease of operation with a wide range of entry stations and accessories to provide a powerful and flexible control solution. The bright LCD readout displays functions and scene information in plain English, and guides you step-by-step through setup and operation. They enable the optimal mix of lighting to be selected—to evoke the right mood—without the guesswork.

Triac with generous 1000W zone capacity

LCD with intuitive, menu-driven Wizard interface guides setup and operation

Zone information buttons display zone name and brightness level

Interchangeable covers

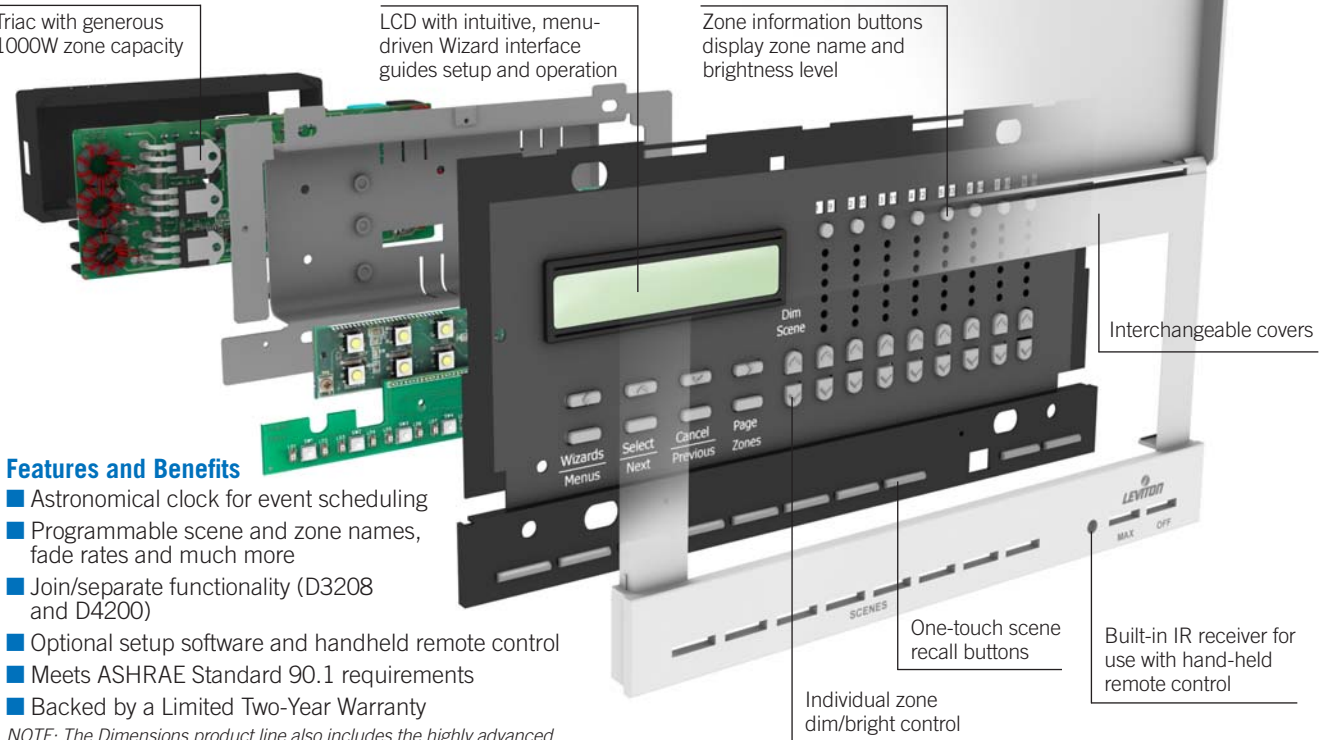

#### Features and Benefits

- Astronomical clock for event scheduling
- Programmable scene and zone names, fade rates and much more
- Join/separate functionality (D3208 and D4200)
- Optional setup software and handheld remote control
- Meets ASHRAE Standard 90.1 requirements
- Backed by a Limited Two-Year Warranty

NOTE: The Dimensions product line also includes the highly advanced D8000 system. Consult your Leviton representative for more information.

#### DIMENSIONS D3200 SYSTEM



##### D3200 Multizone Controller/Dimmer

Advanced, multipoint scene control and dimming with 4 to 6 dimming loads and 8 scene buttons. D3208 features join/separate for partitioning and the addition of two auxiliary zones via network power extenders.

**D3206-ILS shown**



##### D3200 Scene Controller

Four-scene Decora® wall controller with Off switch. Ideal for secondary entranceways and residential applications.

**NE505 shown**



##### D3200 LCnet SmartJack

(with Software) PC/laptop-to-network jack that enables D3200 Data Manager software.

**NE100-00C shown**



##### D3200 Infrared Remote Control

Handheld remote control for use with any IR-receiving D3200 controller.

**NE210 shown**

#### DIMENSIONS D4200 SYSTEM



##### D4200 Multizone Controller

32-zone digital lighting controller and entry station used with dimming cabinets, relay cabinets remote receivers, and accessory stations.

**D4200-00W shown**



##### D4200 Remote Station

Decora-style wall controllers in 15 versions, each with unique range of D4200 functionality.

**D42PB-00W shown**



### Dimensions D3200 Architectural Lighting Control System

The Dimensions D3200 is a component-based lighting system flexible enough for a wide range of commercial and high-end residential lighting applications. The essential component is the Multizone Controller/Dimmer, a self-contained programmable dimmer and scene controller that will control up to eight zones of lighting. The unit will also function as a control unit for other devices attached to the Leviton Control Network (LCnet). By adding wall mounted scene controllers, a hand-held remote and a SmartJack for PC-based programming, the D3200 offers a comprehensive lighting control solution that can be expanded at any time.

#### Dimensions D3200 Multizone Controller/Dimmers

DESCRIPTION	CAT. NO.	LOAD RATING	COLOR
D3204 Multizone Controller/ Dimmer—Self-contained dimmer with learning IR receiver. Controls up to 4 local zones and a maximum of 248 remote zones. Features 8 scene buttons and 32-scene capability. LCD with wizard menus. Supplies 24VDC @ 150mA power to hardwired control devices.	<b>D3204-1LW</b>	120V AC 60Hz: 1920W/VA total output, 1000W/VA max. per zone, 1200W/VA max. per side. For use with Incandescent, Tungsten, Magnetic Low Voltage Transformer, Advance Mark 10™ <i>Powerline</i> Electronic Fluorescent Dimming Ballast, Neon, Cold Cathode and non-dimming loads. Electronic Low Voltage and 0-10V DC Fluorescent Hi-Lume and Eco-10 controlled with optional power extenders.	W
Dimensions D3206 Multizone Controller/Dimmer—Self-contained dimmer with learning IR receiver. Controls up to 6 local zones and a maximum of 186 remote zones. Features 8 scene buttons and 32-scene capability. LCD with wizard menus. Supplies 24VDC @ 150mA power to hardwired control devices.	<b>D3206-1LW</b>	Same as D3204-1LW	W
Dimensions D3208 Multizone Controller/Dimmer—All features of the D3206 plus: Combine/separate functionality for 8 partitioned spaces in up to 256 configurations. Up to 64 scheduled scene changes. Easy access to 2 auxiliary loads from front panel. Controls 62 additional remote zones (248 max).	<b>D3208-1LW</b>	Same as D3204-1LW	W
D3204 Multizone Controller/Dimmer—same as D3204-1L except rated for 230V loads.	<b>D3204-2LW</b>	230V AC 50–60Hz: 2400W/VA total output, 800W/VA max. per zone. For use with Incandescent, Tungsten, Magnetic Low Voltage Transformer, Advance Mark 10™ <i>Powerline</i> Electronic Fluorescent Dimming Ballast, Neon, Cold Cathode and non-dimming loads.	W
D3206 Multizone Controller/Dimmer—same as D3206-1L except rated for 230V loads.	<b>D3206-2LW</b>	Same as D3204-2LW	W
Dimensions D320x Color Change Kits	<b>D32CK</b>	—	II, WW, AA, GG, EE, SW



#### \*COLOR/CONTROLLERS

Available with White Frame/White Cover (-1LW) or -2LW. For other colors, order Cat. No. D32CK Color Change Kit and add suffix as follows: Ivory Frame/Ivory Cover (-II), White Frame/White Cover (-WW), Almond Frame/Almond Cover (-AA), Gray Frame/Gray Cover (-GG), Black Frame/Black Cover (-EE), White Frame/Smoke Cover (-SW).



# DIMENSIONS™ ARCHITECTURAL LIGHTING CONTROL SYSTEM FEATURES

## Commercial Grade Lighting Controls

### Dimensions D3200 Architectural Lighting Control System

Leviton's D3204, D3206 and D3208 provide advanced, multipoint dimming and scene control for commercial and high-end residential lighting applications within a comprehensive D3200 system or as a standalone dimmer. The units feature menu Wizards for easy programming and lighting control, an IR receiver for use with a handheld remote control, and a comprehensive suite of functionality including event scheduling, partitioning, and networking. Models vary in the number of zones, availability of certain features, and voltage capacities.

#### Dimensions D3200 Architectural Lighting Control System

##### Specifications & Features

###### D3204 and D3206

- 41 internally-driven dimming loads (D3206); 4 for D3204
- Controls up to 186 remote zones via Leviton Control Network (LCnet) bus (D3206); D3204 controls up to 248
- 6 (D3206) and 4 (D3204) Scene buttons and 32-scene capability
- 2-line, 32-character LCD with Wizards for easy setup
- LED Light-level indicators
- Group raise/lower buttons for changing all zone light levels at same time
- Learning IR Receiver
- Powers LCnet controllers and Leviton SmartJack

- Mounts in 4-gang box with 4-gang device cover
- UL Listed, CSA Certified
- California Title 24 compliant and meets ASHRAE Standard 90.1 requirements
- Backed by a Limited Two-Year Warranty

###### D3208 Additional Features

- Up to 64 scheduled scene changes based on time of day or astronomical clock
- Combine/Separate functionality for 8 partitions in up to 256 different configurations
- Controls up to 248 remote zones
- Easy front panel access to 2 auxiliary LCnet dimming zones or switching loads

##### Applications

- Home Theaters
- Great Rooms
- Ballrooms
- Conference Rooms
- Restaurants
- Executive Offices
- Surgical Suites
- Houses of Worship
- Light Commercial Applications

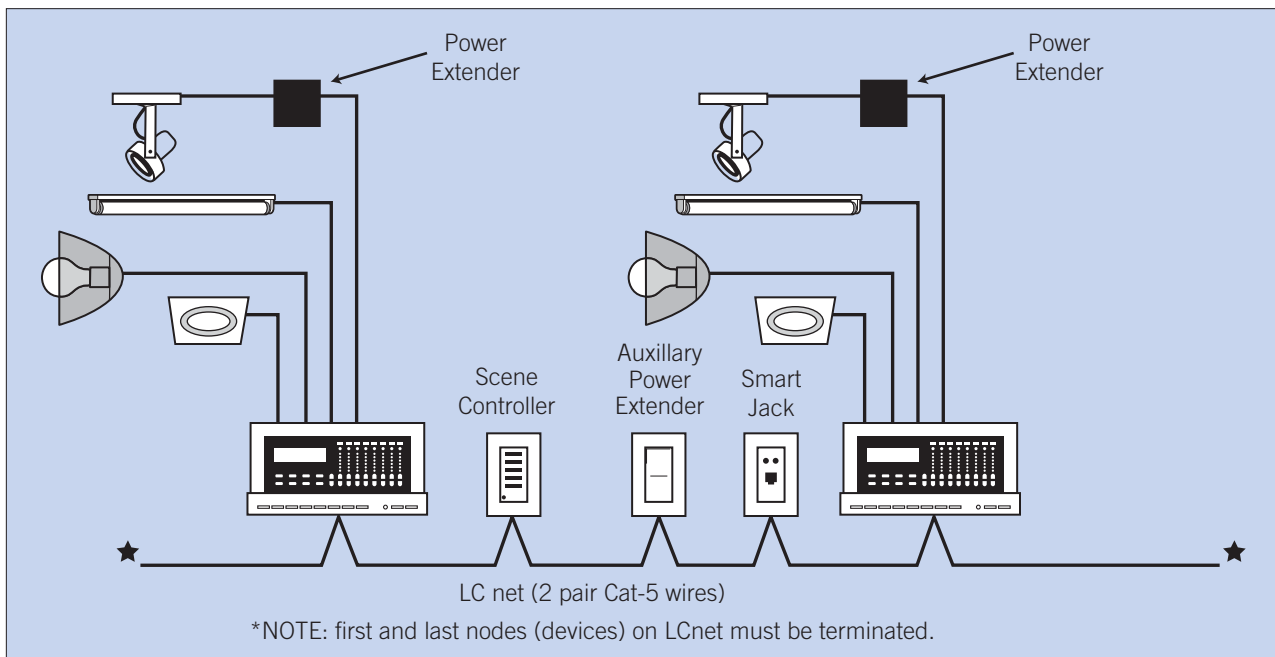

Typical Dimensions D3200 System using a single LCNet bus

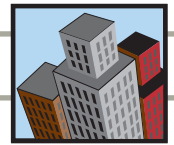

**Dimensions D3200 Architectural Lighting Control System**

**Dimensions D3200 System Components**

DESCRIPTION	CAT. NO.	LOAD RATING	COLOR
Scene Controller—Decora-style 5-button wall controller with 4 scene recall buttons plus OFF. Features learning IR receiver.	<b>NE505</b>	Input Voltage: 24VDC Input Current: 24mA	White with Ivory Color option*
NE505 Color Change Kit with Customizable Labels (wallplates sold separately)	<b>DCK05-0C</b>	—	I, W, A, G, E
Decora Partition Controller—with 5 buttons (4 walls and Reset). For use in D3208 system.	<b>NE515</b>	Input Voltage: 24VDC Input Current: 24mA	White with Ivory Color option*
Infrared Remote Control—Handheld remote for use with any IR-receiving D3200 Controller. Provides 8 scene selections, group DIM/BRIGHT, Max and OFF buttons.	<b>NE210</b>	No load rating— for use with any IR-receiving D3200 Controller	Black
Terminator Block—For use with LCnets not terminated with D3200s and with total wire length greater than 10 ft.	<b>NE600</b>	No load rating	White
SmartJack—Decora-style jack enables D3200 Setup Software to be run from PC or laptop. Includes PC cable and Software CD. Essential for any LCnet system where PC interface is desired.†	<b>NE100-00C</b>	No load rating	White with Ivory Color option*
Power Extenders—Extend the power handling capacity of any D3206/D3208 dimming zone or activates auxiliary zones.	See page C8 for complete listing	Models available for incandescent, magnetic-low voltage, electronic low-voltage, Advance Mark 7™ 0-10V or equivalent and 0-10VDC dimmable electronic fluorescent ballasts. See page C8 for ratings.	See page C8

†Software can be downloaded from [www.leviton.com/D3200](http://www.leviton.com/D3200)

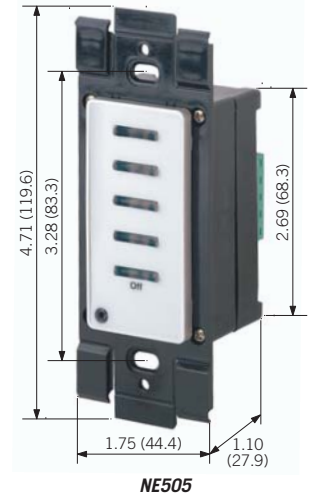

**\*COLOR/COMPONENTS**

Cat Nos. NE505, NE515 and NE100 come in White with matching wallplate. Include snap-on Ivory Color Change Kit. (Ivory wallplate sold separately). With DCK05-0C Color Change Kits add to suffix as follows: Ivory (I), White (W), Almond (A), Gray (G), and Black (E).

**TESTING AND CODE COMPLIANCE**

- UL Listed, CSA Certified, FCC Part 15 (where applicable)
- Backed by a Limited Two-Year Warranty



# DIMENSIONS™ ARCHITECTURAL LIGHTING CONTROL SYSTEMS

## Commercial Grade Lighting Controls



**D42P8-00W**

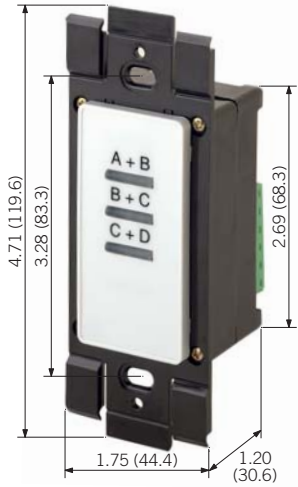

**D42CS-03W**



**D42IR-16L**

### Dimensions D4200 Architectural Lighting Controller

The Dimensions D4200 puts total lighting control at your fingertips. This single panel can create and save lighting scenes, switch lights and scenes instantly or with gradual fades, and provide complete control of up to 32 lighting zones per unit (320 per system).

#### Dimensions D4200 Lighting Controller

DESCRIPTION	CAT. NO.
Eight preset buttons, each with indicator pilot light. Controls virtually any type of lighting. Works with up to 127 devices. Pushbutton recall of 8 scenes with 8 additional scenes accessible from remote entry stations. Fade time can be set for each scene. Astronomical time clock allows sequenced events based on time of day. LCD readout shows zone and scene labels plus intensity settings. Built-in IR receiver for use with optional handheld remotes. Electronic lock prevents unauthorized operation. Available with white frame/white cover or white frame/black translucent cover.	<b>D4200-00W</b>
White D4200 Color Change Kit (White cover and frame)	<b>D42CK-00W</b>
Smoke D4200 Color Change Kit (Smoke cover and White frame)	<b>D42CK-05W</b>

#### Dimensions D4200 Wall-Mounted Remote Stations

One-button Start/Stop Sequencer	<b>D42SQ-00W</b>
One-button Start/Stop Event Timer	<b>D42ET-00W</b>
One-button Join/Separate Link	<b>D42LI-NKW</b>
One-button Lock/Unlock	<b>D42LO-CKW</b>
Two-button: Preset Scene 1 and OFF, built-in IR receiver	<b>D42P1-00W</b>
Two-button: Master Raise and Lower, built-in IR receiver	<b>D42RL-00W</b>
Two-button: Preset Scene Max and OFF, built-in IR receiver	<b>D42M0-00W</b>
Three-button: Preset Scene 1, Max and OFF, built-in IR receiver	<b>D42P1-MOW</b>
Four-button: Max, OFF, Master Raise and Lower, built-in IR receiver	<b>D42M0-RLW</b>
Five-button: Preset Scenes 1-4 and OFF, built-in IR receiver	<b>D42P4-00W</b>
Five-button: Preset Scene 1, Max, OFF, Master Raise and Lower, built-in IR receiver	<b>D42P1-RLW</b>
Eight-button: Preset Scenes 1-4, Max, OFF, Raise and Lower, built-in IR receiver	<b>D42P4-RLW</b>
Eight-button: Preset Scenes 9-16	<b>D42P9-16W</b>
Ten-button: Preset Scenes 1-8, Max and OFF, built-in IR receiver	<b>D42P8-00W</b>
Ten-button: Preset Scenes 9-16, Raise and Lower, built-in receiver	<b>D42P9-RLW</b>

#### Dimensions D4200 Room-Combine Stations

One-button: Combines 2 rooms with 1 partition	<b>D42CS-01W</b>
Three-button: Combines 3 rooms with 3 partitions	<b>D42CS-3AW</b>
Four-button: Combines 4 rooms with 4 partitions	<b>D42CS-04W</b>
Two-button: Combines 3 rooms with 2 partitions	<b>D42CS-02W</b>
Three-button: Combines 4 rooms with 3 partitions	<b>D42CS-03W</b>

#### Dimensions D4200 IR Handheld Controls†

Four Preset Scenes	<b>D42IR-04L</b>
Eight Preset Scenes	<b>D42IR-08L</b>
Sixteen Preset Scenes	<b>D42IR-16L</b>

†Remote IR Ceiling-Mount Receivers available in single-gang and 2-gang models. Consult your Leviton representative for more information.

See page C7 For Dimensions D4200 Specifications and Features

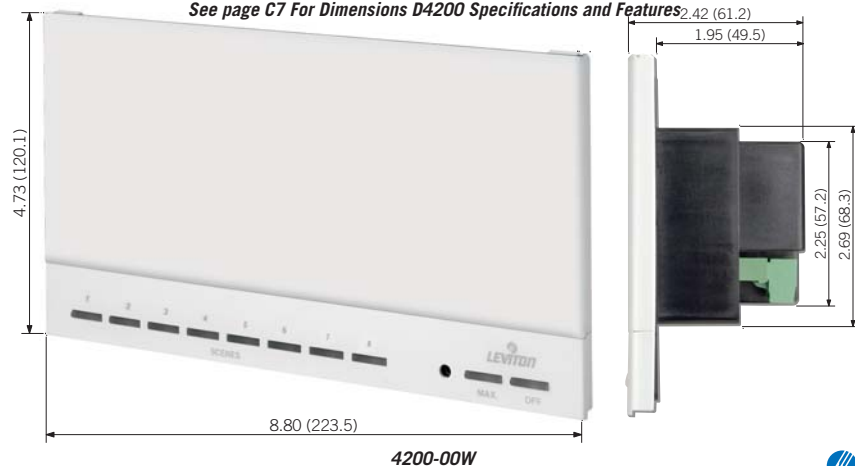

**4200-00W**

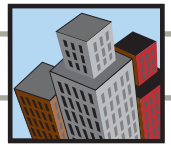

### Dimensions D4200 Architectural Lighting Control System

#### Specifications & Features

##### D4200 Controller

- Controls virtually any light source when used with Leviton a-2000 Dimming Panels, MDS Dimming Cabinets, i Series e Dimming Racks, and any DMX512 Dimming Rack (in conjunction with an NPC XP or DLR)
- Controls up to 32 zones and maximum of 320 zones via Luma-Net system
- 8 Scene buttons and 16-scene capability
- LED light-level indicators
- 2-line, LCD for time, setup screens, scene labels, zone labels, and zone intensity settings from 0 to 100%
- Individual raise/lower buttons for each zone
- Master raise/lower buttons for changing all zone light levels at same time
- Works with up to 127 devices (Controllers and Remote Stations, Luma-Net Hubs and Combine/Closure Interface)

- Built-in IR Receiver
- Built-in schedule and sequence functions
- Astronomical time clock allows preset or sequence events to be called up according to time of day
- Mounts in 4-gang box with 4-gang device cover

##### D4200 Remote Stations

- Available in 15 configurations—most have built-in IR receiver for use with handheld remote control
- Backlighting and tactile clicking indicate scene selection
- Wired via Luma-Net to D4200 Controller
- Mount in single-gang deep switchbox
- Attractive styling accepts Decora wallplates or Decora Plus screwless wallplates

##### D4200 Room-Combine Stations

- Accommodates room partitions by combining and separating lighting controls
- Must be wired via Luma-Net to D4200 Controller
- Minimal programming required
- Comes with snap-on Monet-style wallplate with silk-screened room configuration



D4200

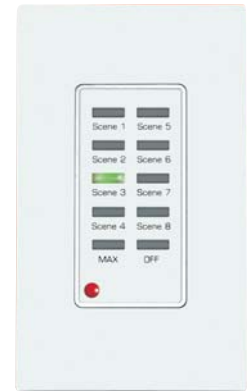

D42P8-00W

#### Applications

- Ballrooms
- Cafeterias
- Auditoriums
- Lecture Halls
- Conference Rooms
- Hotel Suites
- Restaurants
- Museums
- Houses of Worship

D4200 System Wiring Diagram, Daisy Chain Scheme

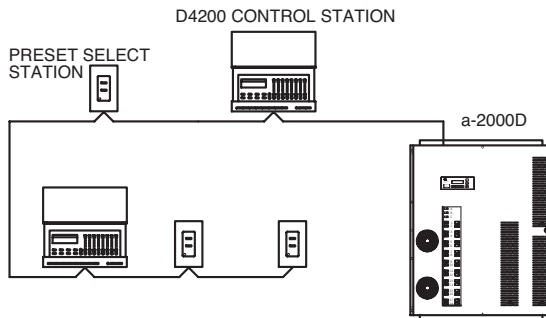

Note: a-2000-24 Cabinet can be in the middle of a daisy chain

D4200 System Wiring Diagram, Hub

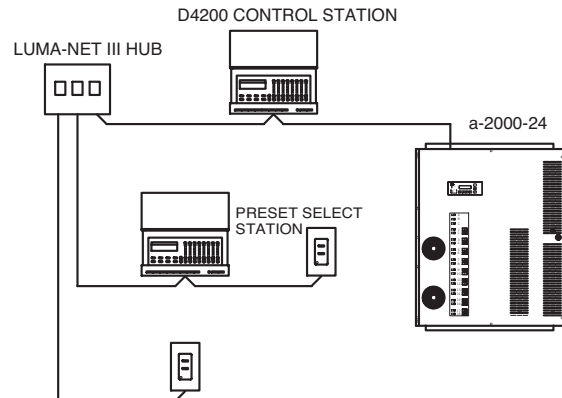

#### \*COLOR/WALL STATIONS

Wall stations come in white with matching, screwless wallplates.

#### TESTING AND CODE COMPLIANCE

- Meets ASHRAE Standard 90.1 requirements
- Backed by a Limited Two-Year Warranty

For more information about the devices on this page and Leviton's complete line of Architectural Lighting Control Systems, call 1-503-404-5500.



# POWER EXTENDERS for ARCHITECTURAL LIGHTING CONTROL SYSTEMS

## Commercial Grade Lighting Controls



PE100/200/400/AUX/AU7



PE300-DOW

### Standard Power Extenders

#### Power Extenders—PE100, PE200, PE300, PE400

DESCRIPTION	CAT. NO.	RATING
Extends dimming zone capacity to full 1920W/VA @ 120V for incandescent, magnetic low-voltage, halogen or neon/cold cathode lighting. Aluminum heat sink with snap-on white cover	PE100-10W	Input Voltage: 120V 50/60Hz Load Rating: 1920W/VA Load Output Power: phase independent of control device Dimmer Input: 120V 50/60Hz
Extends dimming zone capacity to full 1920VA @ 120V for Mark 10™ Powerline, Hi-Lume®, or equivalent dimmable fluorescent ballast. Aluminum heat sink with snap-on white cover	PE200-10W	Input Voltage: 120V 50/60Hz Load Rating: 1920VA Load Output Power: phase independent of control device Dimmer Input: 120V 50/60Hz
Extends dimming zone capacity to full 3000VA @ 277V for Mark 10™ Powerline, Hi-Lume®, or equivalent dimmable fluorescent ballast. Aluminum heat sink with snap-on white cover	PE200-70W	Input Voltage: 277V 50/60Hz Load Rating: 3000VA Load Output Power: phase independent of control device Dimmer Input: 120V 50/60Hz
Extends dimming zone capacity to full control of a 20A circuit with 0–10 V DC Mark 7® 0–10V, Lutron 0–10V, OSRAM Sylvania Quicktronic® Helios™ or equivalent ballast. Metallic silver color.	PE300-DOW	Input Voltage: 120V AC to 277V AC, 60Hz Load Rating: 20A–2400VA @ 120V AC, 5500VA @ 277V AC Power Consumption: 6W @ 120V AC, 18W @ 277V AC Output Ballast Control: 0–10V DC Dimmer Input: 120V 60Hz
Extends dimming zone capacity to full control of a 1000W/VA @ 120V AC for electronic low voltage or incandescent lighting. Aluminum heat sink with snap-on white cover	PE400-10W	Input Voltage: 120V AC 50/60Hz Load Rating: 1000W/VA Load Output Power: phase independent of control device Dimmer Input: 120V 60Hz

Mark 10™ and Mark 7™ are trademarks of the Advance Transformer Company.  
Hi-Lume® is a registered trademark of the Lutron Electronic Co., Inc.

### Auxiliary-Zone Network Power Extenders (for D3200 Systems only)

DESCRIPTION	CAT. NO.	RATING
Enables 2 auxiliary zones on a D3200 Controller/Dimmer for full control over incandescent, magnetic low-voltage, or neon/cold cathode lighting. Aluminum heat sink with snap-on white cover	PEAUX-12W	Input Voltage: 120V AC 50/60Hz Load Rating: 1920W/VA total, or 1000W/VA max. per zone Load Output Power: phase independent of control device Dimmer Input: D3200
Enables 1 auxiliary zone on a D3200 Controller/Dimmer for full control over incandescent, magnetic low-voltage, or neon/cold cathode lighting Aluminum heat sink with snap-on white cover	PEAUX-AUW	Input Voltage: 230V AC 50/60Hz Load Rating: 2400 W/VA total Load Output Power: phase independent of control device Dimmer Input: D3200
Enables 1 auxiliary zone on a D3200 Controller/Dimmer for full control over Mark 7™ 0-10V, OSRAM Sylvania Quicktronic Helios, Lutron 0-10V, or equivalent ballasts. Aluminum heat sink with snap-on white cover	PEAU7-M1W	Input Voltage: 120-230V 50-60Hz Output Ballast Control: 0-10V DC Load Rating: 20A-120V & 10A-230V Load Output Power: phase independent of control device Dimmer Input: D3200

#### SPECIFICATIONS AND FEATURES

##### Standard Power Extenders

- Emulates characteristics of dimmer it is connected to in terms of dimming range and resolution
- Low-end trim available for setting minimum brightness level (PE100, PE200, PE300)
- PE100, PE200 and PE400 can be surface or flush mounted using 1900 Box and 2-gang raised cover
- PE300 mounts in 4" square box

#### APPLICATIONS

##### Standard Power Extenders

- Works with any D3200 Multizone Controller/Dimmer to extend load capacity of any zone
- Extends load capacity of box-mounted dimmers (see compatibility chart)
- Works with all families of Leviton Architectural Systems

##### Network Power Extenders

- Enables a D3200 Multizone Controller/Dimmer to accommodate extra loads
- Works with any D3200 Multizone Controller/Dimmer to extend load capacity of any zone

#### TESTING AND CODE COMPLIANCE

- UL Listed (except PEAUX-AUW), CSA Certified and NOM Certified
- Backed by a Limited Two-Year Warranty

### Power Extender Compatibility

Standard Power Extenders work with any Dimensions Multizone Controller/Dimmer and all Architectural Systems. Refer to the chart below for compatibility with Leviton Box-Mounted Dimmers.

POWER EXTENDER	BOX-MOUNTING DIMMER COMPATIBILITY
PE100-10W	Must use 120V 600W Incandescent version of Acenti, IllumaTech, Mural, True Touch, TouchPoint, ToggleTouch, Sure Slide and Home Controls. (or 600VA version of Acenti). For Monet, use 120V 600VA Magnetic Low-Voltage version (requires Neutral wire). For dimmers that include a Neutral wire, the dimmer Neutral wire must be connected.
PE200-10W PE200-70W	Must use 120V 600VA Mark 10 version Acenti, of Monet, IllumaTech, Mural and TouchPoint. For dimmers that include a Neutral wire, the dimmer Neutral wire must be connected. For Hi-Lume ballasts, use incandescent dimmers. PE200-70W is compatible with all 600VA-220V box-mounted dimmers.
PE300-DOW	Must use 120V 600W Incandescent version of Acenti, IllumaTech, Mural, True Touch, TouchPoint, ToggleTouch, Sure Slide and Home Controls. For Monet, use 120V 600VA Magnetic Low-Voltage version (requires Neutral wire). For dimmers that include a Neutral wire, the dimmer Neutral wire must be connected.
PE400-DOW	Must use 120V 600W Incandescent version of Acenti, IllumaTech, Mural, True Touch, TouchPoint, Trimatron and Sure Slide Home Controls. For Monet, use 120V 600VA Magnetic Low-Voltage version (requires Neutral wire). For dimmers that include a Neutral wire, the dimmer Neutral wire must be connected.



# ARCHITECTURAL DIMMING CABINETS

## Commercial Grade Lighting Controls

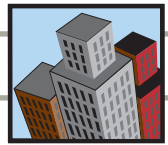

### a-2000 Architectural Grade Modular Dimming Cabinets

This expanded line of a-2000 Dimming Cabinets is available in numerous configurations for use in architectural applications. These modular cabinets deliver robust precision performance typically found only in high-end theatrical dimming systems. This user-friendly line of modular cabinets can be equipped with a wide variety of 15A or 20A 120V, or 277V dimming modules. Relay cabinets are also available, as are bussing and flush kits. All a-2000 cabinets integrate seamlessly with any of Leviton's Lighting Controls.

#### a-2000 Dimming Cabinets

DESCRIPTION	CAT. NO.	RATING
12-Channel 120V Architectural-Grade Single-Phase Modular Dimming Cabinet—also available optional analog card, and in 3-phase versions with without analog card	A2D1L-2A0	2400W per channel. with Individual dimmers rated 15A or 20A. For incandescent, magnetic low voltage, or tungsten, halogen, and cold cathode. Compatible fluorescent dimming ballasts: 0-10VDC Advance Mark 7™, OSRAM Sylvania Quicktronic® Helios™ and Triad® Ballastar®; 2-wire types such as Advance Mark 10™; and 3 wire Lutron Hi-Lume® and Eco-10
24-Channel 120V Architectural-Grade Single-Phase Modular Dimming Cabinet (with main lugs only)—also available in 3-phase models, and with optional analog card, with main breaker setup, or with both options	A2D1L-4A0	Same as A2D1L-2A0 (above)
18-Channel 277V Architectural-Grade 3-Phase Modular Dimming Cabinet (with 15A breakers)—also available with 20A breakers and with or without analog card	A2D3L-857	Same as A2D1L-2A0 (top)
Relay Cabinet—Holds up to 12 relays for straight rated control of fluorescent and non-fluorescent loads. Bolts directly to a-2000 cabinet to make a single easy-to-mount cabinet.	Consult your Leviton representative	Up to 12 relays. relay Individual relays for 20A 120V, 277V and 347V applications.

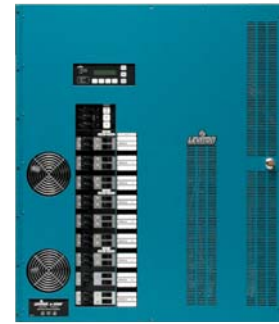

a-2000-24



a-2000-24 with Relay Cabinet

#### SPECIFICATIONS AND FEATURES

- 4" Depth allows surface or recess mounting
- Compact 30<sup>1</sup>/<sub>8</sub> inch cabinet width fits between two stud widths
- Relay Cabinet (14.25" width) bolts directly to Dimmer Cabinet to form single compact unit
- Contractor-friendly design with ample wiring space
- Stackable to provide 36 or 48 dimmer channels
- Top, bottom or side feed
- Plug-in dual dimmer modules for rapid field replacement
- Bypass switch for each dimmer allows full-ON operation
- Theatrical-grade dual SCR dimming circuits outperform standard triac-based dimmers
- Operates at 97% efficiency
- Toroidal filter with 350 usec rise time
- UL and cUL Listed
- Backed by a Limited Two-Year Warranty

#### APPLICATIONS

- Ballrooms
- Cafeterias
- Auditoriums
- Lecture Halls
- Conference Rooms
- Houses of Worship

For more information about the devices on this page and Leviton's complete line of Architectural Lighting Control Systems, call 1-503-404-5500.

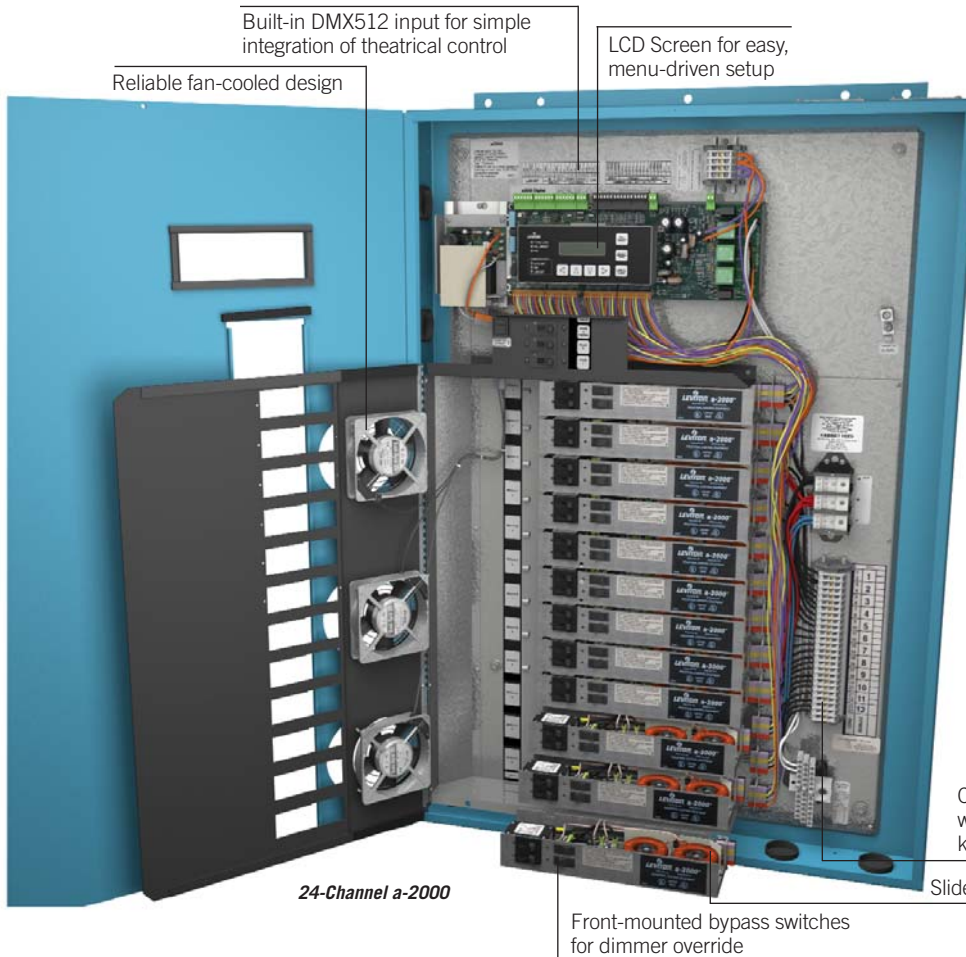

Built-in DMX512 input for simple integration of theatrical control

Reliable fan-cooled design

LCD Screen for easy, menu-driven setup

24-Channel a-2000

Front-mounted bypass switches for dimmer override

Contractor friendly wireways with generous knuckle room

Slide-in dimmer modules for tool-free service

For answers to technical questions, call Leviton's Techline at 1-800-824-3005





# ARCHITECTURAL SPECIFICATIONS LIGHTING CONTROLS FEATURES

## Commercial Grade Lighting Controls

### Architectural Specification Lighting Controls

Inspired by the great painters, Leviton's Monet®, Renoir® and Van Gogh® dimmers and fan speed controls accent today's most beautiful interiors. Leviton's premiere line of architectural lighting controls can accommodate high wattage loads and mate with screwless narrow- and wide-fin wallplates—for the ultimate flexibility in design.

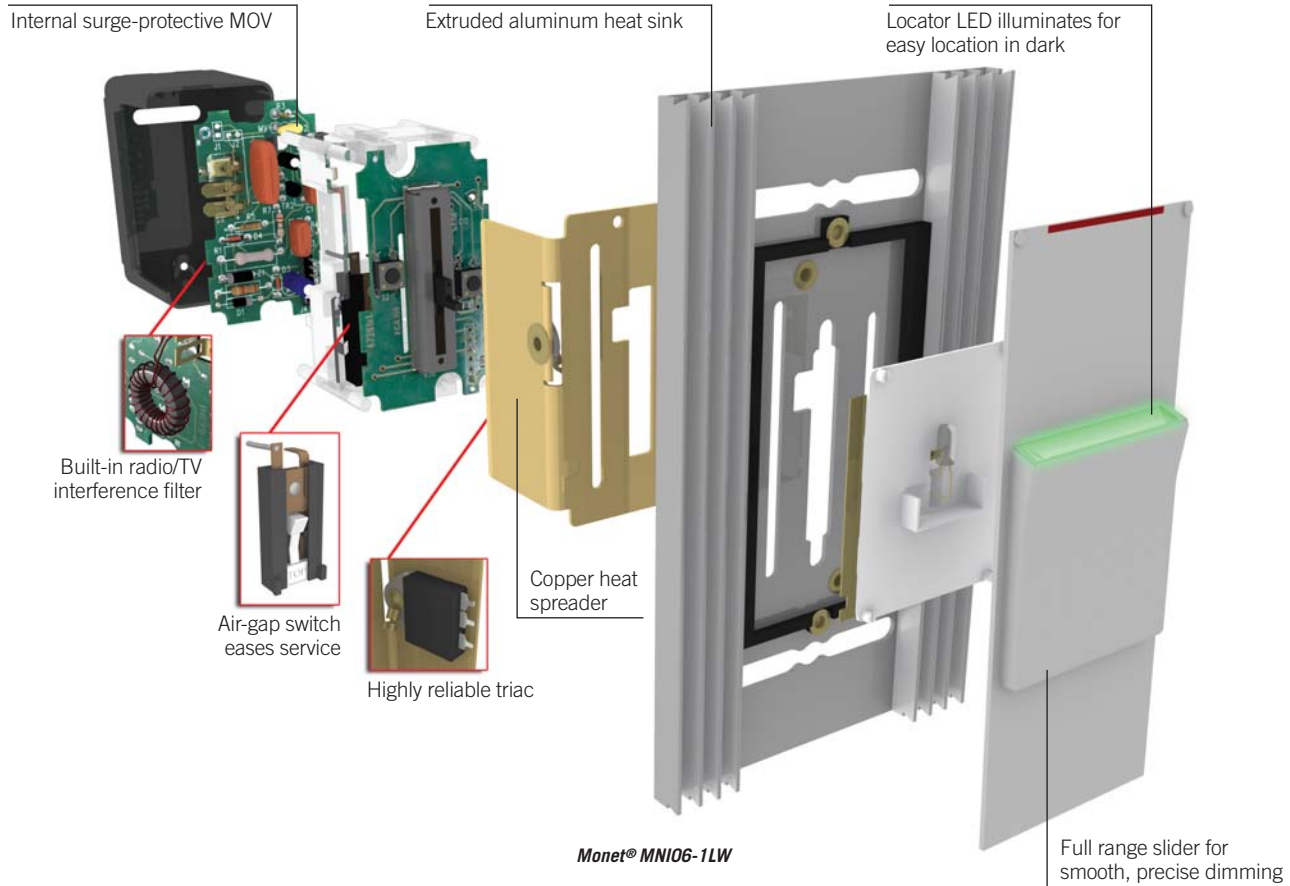

#### Features and Benefits

- Full-range dimming for both single-pole and multi-location control
- Accommodates high-power loads
- Low profile, designer styling; mates with narrow- and wide-fin screwless wallplates
- Wide range of colors available through convenient color change kits
- UL and CSA Listed
- Backed by a Limited Five-Year Warranty

### ARCHITECTURAL SPECIFICATION DIMMING AND FAN SPEED CONTROLS



**Monet® Slide Dimmer**  
Low-profile architectural controls with advanced features. With narrow or wide fin. Matte finish. Custom-engraved wallplates available.  
**MNI06-1LW shown**



**Renoir® Slide Dimmer**  
Rugged, full-range preset slide dimmer for high-power loads. With narrow or wide fin.  
**81000-W shown**



**Van Gogh® Rotary Dimmer**  
Architectural yet classic full-range rotary dimmer for high-power incandescent loads. Rugged design.  
**60800-W shown**

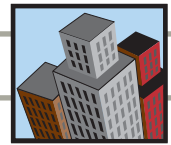

**Monet Architectural Specification Grade Preset Controls  
120V and 277V AC 60Hz**

Low-profile Architectural Decora Digital Preset Slide Dimmers with LED locator light. Most Monet dimmers provide single-pole (1 location) and 3-way (multi-location) control with Switching Remote.

**Incandescent 120V AC**

DESCRIPTION	CAT. NO.	RATING	COLOR CHANGE KIT
Monet Dimmer (narrow fin)	MNIO6-1LW	600W	I, W, A, G, E, B
Monet Dimmer (narrow fin)	MNI10-1LW	1000W	I, W, A, G, E, B
Monet Dimmer (wide fin)	MNI15-1LW	1500W	I, W, A, G, E, B
Monet Incandescent Dimmer, Single-Pole, Unlighted (narrow fin)	MNIO6-10W	600W	I, W, A, G, E
Monet Incandescent Dimmer, Single-Pole, Unlighted (narrow fin)	MNI10-10W	1000W	I, W, A, G, E

**Low-Voltage 120V AC**

DESCRIPTION	CAT. NO.	RATING	COLOR CHANGE KIT
Monet Dimmer (narrow fin) Electronic	MNEO4-1LW	400VA (320W)	I, W, A, G, E, B
Monet Dimmer (narrow fin) Magnetic	MNMO6-1LW	600VA (450W)	I, W, A, G, E, B
Monet Dimmer (narrow fin) Magnetic	MNM10-1LW	1000VA (800W)	I, W, A, G, E, B
Monet Dimmer (wide fin) Magnetic	MNM15-1LW	1500VA (1200W)	I, W, A, G, E, B

**Mark 10™ Fluorescent Ballast 120 and 277V AC**

For Advance Mark 10™ Powerline fluorescent dimming ballasts.

DESCRIPTION	CAT. NO.	RATING	COLOR CHANGE KIT
Monet Mark 10 Fluorescent Dimmer (narrow fin)	MXN10-1LW	1000VA 120V AC	I, W, A, G, E, B
Monet Mark 10 Fluorescent Dimmer (wide fin)	MXN15-1LW	1500VA 120V AC	I, W, A, G, E, B
Monet Mark 10 277V Fluorescent Dimmer (narrow fin)	MXN20-7LW	2000VA 277V AC	I, W, A, G, E, B
Monet Mark 10 277V Fluorescent Dimmer (wide fin)	MXN30-7LW	3000VA 277V AC	I, W, A, G, E, B

**Fan Speed Controls 120V AC**

DESCRIPTION	CAT. NO.	RATING	COLOR CHANGE KIT
Monet Fan Speed Control (narrow fin)	MNF07-1LW	7.5A 120V AC	I, W, A, G, E, B
Monet Fan Speed Control (wide fin)	MNF10-1LW	10A 120V AC	I, W, A, G, E, B

**Monet Accessory Products**

DESCRIPTION	CAT. NO.	RATING	COLOR CHANGE KIT
Monet Remote Non-Dimming Switching Unit for 3-Way Applications (Unlighted)	MNOOR-DOW	No load rating, use with 120V & 277V Monet dimmers only	I, W, G, E, A
Color Change Kits for MNOOR-DOW Monet 3-Way Switching Unit	MNKOR-00	—	I, W, G, E, A
Color Change Kit for Narrow Fin Monet Lighted Controls	MNKIT-SL	—	I, W, A, G, E, B
Color Change Kit for Wide Fin Monet Lighted Controls	MNKIT-1L	—	I, W, A, G, E, B
Color Change Kit for Monet Unlighted Dimmers	MNKIT-SO	—	I, W, A, G, E
Monet Adapter Plate: Allows any Decora strap-mount device to be ganged with either small or large-size Monet controls. In multi-gang installations, must use on ends	MNOLA-000 (large) MNOSA-000 (small)	—	Metal Heat Sink

Note: Mark 10™ is a trademark of the Advance Transformer Company.

NOTE: Multi-gang wallplates are available for combining narrow and wide dimmers, with or without fins removed. Refer to page C13.

Note: Sharing a neutral wire may cause flickering. Connect all dimmers to the same phase or run a separate neutral to each phase. Consult Leviton Techline if problems persist.  
Digital Lighting and Fan Speed Controls are polarity sensitive devices. Always follow the wiring instructions included with each device. They can be used in conventional 3-way and 4-way wiring circuits only when the Control is properly connected to the load as indicated by the device's wiring instructions.

See page C12 for Monet Specifications and Features



**Monet Architectural Fin Width**  
Narrow: 2.75" (69.9 mm)  
Wide: 4.25" (108.0 mm)

**CAUTION ON RETROFITS:** When retrofitting Mark 10™ Powerline dimming ballasts into fixtures that originally had Instant Start ballasts, the sockets MUST be replaced with Rapid Start sockets to allow proper dimmer operation and prevent damage to the dimming ballast. Refer to the instructions provided with the ballast and the Leviton Mark 10™ dimmer.





MNS20-1LW

Monet Architectural Specification Grade Controls

Monet Switches

DESCRIPTION	CAT. NO.	RATING	COLOR*
Monet Single-Pole Rocker Switch with Screw Terminals, Lighted (narrow fin)	MNS20-1L	20A 120V AC	I, W, A, G, E
Monet 3-Way Rocker Switch with Screw Terminals, Unlighted (narrow fin)	MNS20-D3	20A 120/277V AC	I, W, A, G, E
Monet 4-Way Rocker Switch with Screw Terminals, Unlighted (narrow fin)	MNS20-D4	20A 120/277V AC	I, W, A, G, E

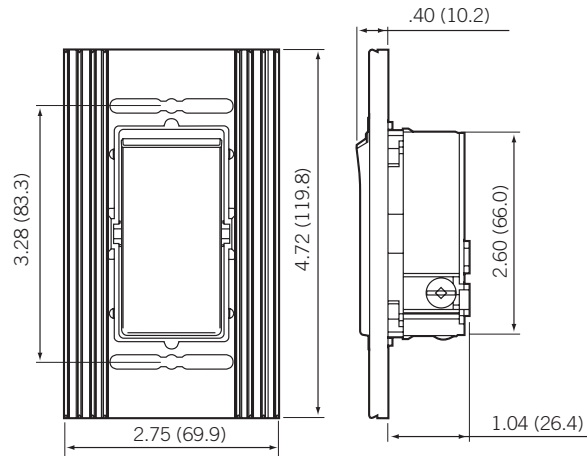

MNS20 shown

SPECIFICATIONS AND FEATURES

- Premier Architectural Specification Grade dimmer combines high load capability, esthetic appearance, digital circuitry and Scene Lighting capabilities
- Provides single-pole and 3-way switching with Monet Non-Dimming Remote Unit
- Low-profile architectural fins, even on wide-fin models, for a flush fit appearance
- Smooth slide-dimming operation. Push slider for ON/OFF preset
- Digital circuit provides Soft-ON/Fade-OFF for eye-pleasing effect and prolonged bulb life
- Specially designed to minimize shadows with non-reflective, easy-to-clean matte finish. Ideal for museums, art galleries, showrooms
- Soft, green locator LED discretely positioned on slider
- Square Law Dimming ensures linear slide control across entire dim and bright output range
- Hidden air-gap switch; slider moves into hidden key-way to access air-gap switch for servicing needs. When air gap switch is open, red line appears at top
- Small and large size adapter plates fit all Leviton Decora straps to make them compatible with Monet wallplates

- Screwless, designer Monet wallplates with matte finish included. Multi-gang wallplates also available for combining narrow and wide dimmers, with or without fins removed (see page C13)
- Customized wallplate engravings available—See your Leviton representative for more information
- Built-in radio/TV interference filter
- Protected memory during temporary power failures
- Internal MOV for surge protection

TESTING AND CODE COMPLIANCE

- UL Listed (File #E-31373)
- CSA Certified (File #LR-3413)
- Backed by a Limited Two-Year Warranty

Cat. No. denotes White device. For other colors, order Color Change Kits and add suffix as follows: Ivory (-I), White (-W), Gray (-G), Black (-E), Brown (-B) and Almond (-A). Monet Rocker Switches listed above do not use Color Change Kits—Add suffix to basic Cat. No. for color selection.

MATERIAL CHARACTERISTICS

Environmental: Flammability UL-94, V2 Rating  
 Operating Temperature: 32°F to 130°F

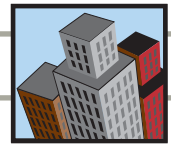

### Monet Multi-Gang Wallplates

**TABLE 1 — FOR INSTALLATIONS WITH NO FINNS BROKEN OFF**

Wallplate Cat. No.	Number of Narrow Fin/Wide Fin Controls	Wallbox Requirements
MNW10-00	1 Narrow	1-Gang
MNW20-00	2 Narrow	3-Gang
MNW30-00	3 Narrow	5-Gang
MNW40-00	4 Narrow	6-Gang
MNW50-00	5 Narrow	9-Gang
MNW60-00	6 Narrow	10-Gang
MNW01-00	1 Wide	1-Gang
MNW02-00	2 Wide	4-Gang
MNW03-00	3 Wide	7-Gang
MNW04-00	4 Wide	9-Gang
MNW11-00	1 Narrow/1 Wide	4-Gang
MNW21-00	2 Narrow/1 Wide	5-Gang
MNW31-00	3 Narrow/1 Wide	7-Gang
MNW41-00	4 Narrow/1 Wide	8-Gang
MNW51-00	5 Narrow/1 Wide	10-Gang
MNW12-00	1 Narrow/2 Wide	6-Gang
MNW22-00	2 Narrow/2 Wide	8-Gang
MNW32-00	3 Narrow/2 Wide	9-Gang
MNW13-00	1 Narrow/3 Wide	9-Gang
MNW23-00	2 Narrow/3 Wide	10-Gang

**TABLE 2 — FOR INSTALLATIONS WITH FINNS BROKEN OFF**

Wallplate Cat. No.	Number of Narrow Fin/Wide Fin Controls	Wallbox Requirements
MNW20-FB	2 Narrow	2-Gang
MNW30-FB	3 Narrow	3-Gang
MNW40-FB	4 Narrow	4-Gang
MNW50-FB	5 Narrow	5-Gang
MNW60-FB	6 Narrow	6-Gang
MNW70-FB	7 Narrow	7-Gang
MNW80-FB	8 Narrow	8-Gang
MNW90-FB	9 Narrow	9-Gang
MNW02-FB	2 Wide	3-Gang
MNW03-FB	3 Wide	5-Gang
MNW04-FB	4 Wide	7-Gang
MNW05-FB	5 Wide	9-Gang
MNW11-FB	1 Narrow/1 Wide	3-Gang
MNW21-FB	2 Narrow/1 Wide	4-Gang
MNW31-FB	3 Narrow/1 Wide	5-Gang
MNW41-FB	4 Narrow/1 Wide	6-Gang
MNW51-FB	5 Narrow/1 Wide	7-Gang
MNW61-FB	6 Narrow/1 Wide	8-Gang
MNW71-FB	7 Narrow/1 Wide	9-Gang
MNW81-FB	8 Narrow/1 Wide	10-Gang
MNW12-FB	1 Narrow/2 Wide	5-Gang
MNW22-FB	2 Narrow/2 Wide	6-Gang
MNW32-FB	3 Narrow/2 Wide	7-Gang
MNW42-FB	4 Narrow/2 Wide	8-Gang
MNW52-FB	5 Narrow/2 Wide	9-Gang
MNW62-FB	6 Narrow/2 Wide	10-Gang
MNW13-FB	1 Narrow/3 Wide	7-Gang
MNW23-FB	2 Narrow/3 Wide	8-Gang
MNW33-FB	3 Narrow/3 Wide	9-Gang
MNW43-FB	4 Narrow/3 Wide	10-Gang
MNW14-FB	1 Narrow/4 Wide	9-Gang
MNW24-FB	2 Narrow/4 Wide	10-Gang

Monet multi-gang wallplates are available for every permissible combination of small fin and large fin dimmers. Tables 1 and 2 can be used to determine if a specific combination of devices is possible. When small and large fin devices are combined, all the large fin devices must be placed to one side and all the small fin devices must be placed to the other side. In an installation where all the fins are broken off, do not remove the fins from the dimmers at each of the extreme ends of the installation.

#### MONET MULTI-GANG WALLPLATE CATALOG NUMBER SYSTEM

Example: **MNW31-00W**

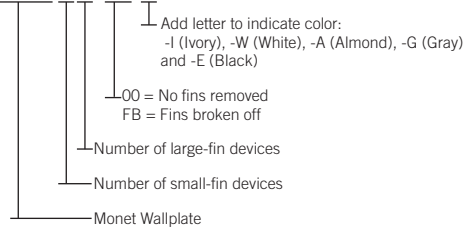

#### Maximum Load per Monet Dimmer Multi-Gang with Fins Broken Off

Cat. No.	Single	2-Gang	More Than 2-Gang
MNE04	400VA (320W)	300VA (240W)	250VA (200W)
MNF07	7.5A	6A	5.3A
MNF10	10A	8A	7A
MNI06	600W	500W	400W
MNI10	1000W	800W	700W
MNI15	1500W	1250W	1000W
MNM06	600VA (450W)	500VA (375W)	400VA (300W)
MNM10	1000VA (800W)	800VA (640W)	700VA (560W)
MNM15	1500VA (1200W)	1250VA (1000W)	1000VA (800W)
MNX10	1000VA (980W)	800VA (784W)	700VA (686W)
MNX15	1500VA (1470W)	1250VA (1225W)	1000VA (980W)
MNX20-7	2000VA (1960W)	1600VA (1568W)	1400VA (1372W)
MNX30-7	3000VA (2940W)	2500VA (2450W)	2000VA (1960W)

**Note:** For more information on Fin Removal, refer to the instruction sheet provided with each Monet device.

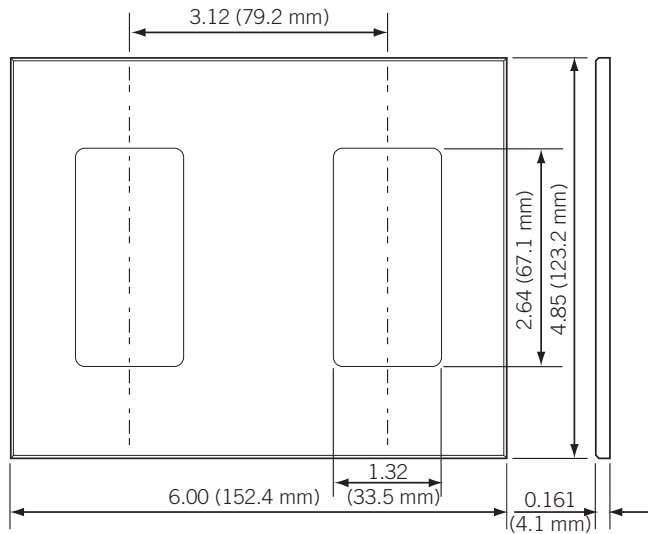

**MNW20-00**



**Commercial Grade Lighting Controls**

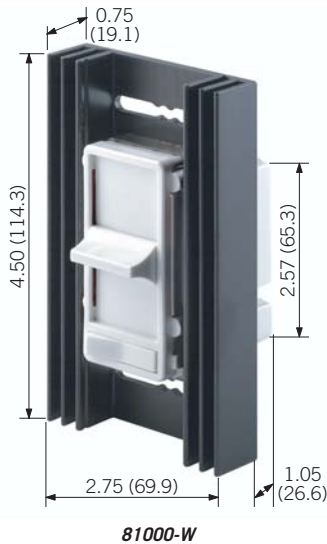

**81000-W**



**82000-W**

**Renoir Architectural Fin Width**  
Narrow: 2.75" (69.9 mm)  
Wide: 4.50" (108.0 mm)

**CAUTION ON RETROFITS:** When retrofitting Mark 10™ Powerline dimming ballasts into fixtures that originally had Instant Start ballasts, the sockets MUST be replaced with Rapid Start sockets to allow proper dimmer operation and prevent damage to the dimming ballast. Refer to the instructions provided with the ballast and the Leviton Mark 10™ dimmer.

**Renoir Architectural Specification Preset Slide Dimmers**

**Renoir Incandescent 120V AC 60Hz Only**

DESCRIPTION	CAT. NO.	RATING	COLOR*
Renoir Single-Pole (narrow fin)	<b>80800</b>	800W	I, W, GY, B
Renoir 3-Way (narrow fin)	<b>80800-3</b>	800W	I, W, GY, B
Renoir Single-Pole (narrow fin)	<b>81000</b>	1000W	I, W, A, GY, B
Renoir Single-Pole, Illuminated (narrow fin)	<b>81000-L</b>	1000W	I, W
Renoir 3-Way (narrow fin)	<b>81000-3</b>	1000W	I, W, A, GY, B
Renoir 3-Way, Illuminated (narrow fin)	<b>81000-L3</b>	1000W	I, W
Renoir Single-Pole (wide fin)	<b>81500</b>	1500W	I, W, A, GY, B
Renoir 3-Way (wide fin)	<b>81500-3</b>	1500W	I, W, A, GY, B
Renoir Single-Pole (wide fin)	<b>82000</b>	2000W	I, W, A, GY, B
Renoir Single-Pole, Illuminated (wide fin)	<b>82000-L</b>	2000W	I, W
Renoir 3-Way (wide fin)	<b>82000-3</b>	2000W	I, W, A, GY
Renoir 3-Way, Illuminated (wide fin)	<b>82000-L3</b>	2000W	I, W

**Renoir Magnetic Low-Voltage 120V AC 60Hz Only**

DESCRIPTION	CAT. NO.	RATING	COLOR*
Renoir Single Pole (narrow fin)	<b>71111</b>	1000VA (800W)	I, W, GY, B
Renoir 3-Way (narrow fin)	<b>71113</b>	1000VA (800W)	I, W, B
Renoir Single Pole (wide fin)	<b>71511</b>	1500VA (1200W)	I, W
Renoir 3-Way (wide fin)	<b>71513</b>	1500VA (1200W)	I

**Renoir Fluorescent Dimming Ballasts 120V and 277V AC 60Hz Only**

DESCRIPTION	CAT. NO.	RATING	COLOR*
Renoir Fluorescent Dimmer, Single-Pole and 3-Way (wide-fin)	<b>26666-31</b>	1200VA (900W) 120V AC Advance Mark 10™ Powerline fluorescent dimming ballast	White
Renoir Fluorescent Dimmer, Single-Pole and 3-Way (wide-fin)	<b>26666-37</b>	1200VA (900W) 277V AC Advance Mark 10™ Powerline fluorescent dimming ballast	White

*Note: For complete information on installation, ganging and derating of High Wattage Dimmers, consult Leviton's Lighting Controls Product Selection Guide or the Dimmer Instruction Sheet provided with the device.*

**When ganging these units, no derating is necessary except on those units which have had both sets of snap-off, fins removed. These shall be derated as follows:**

Maximum Load per Renoir Dimmer Multi-Gang with Fins Broken Off			
Cat. No.	Single	2-Gang	More Than 2-Gang
26666-31	1200VA	1100VA	1050VA
26666-37	1200VA	1200VA	1200VA
71111/3	1000VA (800W)	800VA (800W)	700VA (640W)
71511/3	1500VA (1200W)	1300VA (1200W)	1100VA (1040W)
80800	800W	700W	600W
81000	1000W	800W	700W
81500	1500W	1300W	1000W
82000	2000W	1800W	1500W

**NOTE: For fin removal and switchbox requirements for ganging Leviton Renoir dimmers, refer to page C17.**

**Note: Sharing a neutral wire may cause flickering. Connect all dimmers to the same phase or run a separate neutral to each phase. Consult Leviton Techline if problems persist.**

**SPECIFICATIONS AND FEATURES**

- ON/OFF rocker switch turns lights ON at last selected brightness level
- Smooth-action, linear slide control for easy, precise operation
- Available in single-pole (one location) and 3-way (multi-location) versions. 3-way dimmer is used with standard 3-way ON/OFF switch
- Decora-styling coordinates with Leviton's extensive line of Decora devices
- Decora-style screwless snap-on wallplates present an attractive appearance in any application
- Slim, compact housing easily fits in standard wall boxes
- Fins are easily removed for multi-gang applications
- Large radio/TV interference filter
- Illuminated versions available

**TESTING AND CODE COMPLIANCE**

- UL Listed (File #E-31373)
- CSA Certified (File #LR-3413)
- Backed by a Limited Five-Year Warranty

**\*COLOR**

Add suffix to catalog numbers as follows for color selection: Ivory (-I) White (-W), Almond (A), Gray (-GY), Brown (-B)

**MATERIAL CHARACTERISTICS**

Environmental: Flammability UL-94, V2 Rating  
Operating Temperature: 32°F to 130°F





**Renoir Architectural Specification Preset Slide Fan Speed Controls**

Renoir Fan Speed Controls 120V AC 60Hz Only

DESCRIPTION	CAT. NO.	RATING	COLOR*
Renoir Single-Pole (narrow-fin)	80827	7.5 Amps	I, W
Renoir Single-Pole (wide-fin)	81127	10 Amps	I, W
Renoir Single-Pole (wide-fin)	81527	15 Amps	I, W

**NOTE:** For fin removal and switchbox requirements for ganging Leviton Renoir fan speed controls, refer to page C17.

**Note:** Sharing a neutral wire may cause flickering. Connect all dimmers to the same phase or run a separate neutral to each phase. Consult Leviton Techline if problems persist.

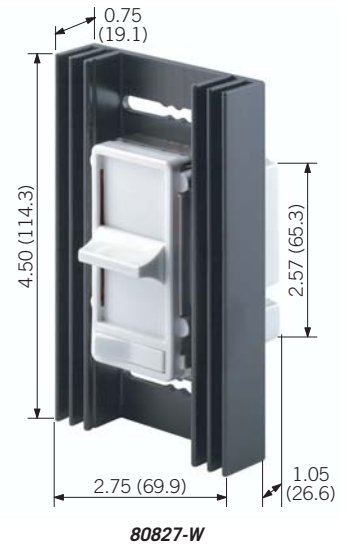

**Renoir Architectural Fin Width**  
 Narrow: 2.88" (73.2 mm)  
 Wide: 4.69" (119.1 mm)

Architectural Specification Lighting Controls

**SPECIFICATIONS AND FEATURES**

- Smooth-action, linear slide control for easy, precise operation
- Manual low-end trim adjustment feature on fan speed controls allows precise adjustment of low-end fan settings when installing device
- Decora-styling coordinates with Leviton's extensive line of Decora devices
- Decora-style screwless snap-on wallplate present an attractive appearance in any application
- Slim, compact housing easily fits in standard wall boxes
- Fins are easily removed for multi-gang applications

**TESTING AND CODE COMPLIANCE**

- UL Listed (File # E-31373)
- CSA Certified (File #LR-3413)
- Backed by a Limited Five-Year Warranty

**\*COLOR**

Add suffix to catalog numbers as follows for color selection: Ivory (-I) White (-W).

**MATERIAL CHARACTERISTICS**

Environmental: Flammability UL-94, V2 Rating  
 Operating Temperature: 32°F to 130°F



**Van Gogh Architectural Specification Rotary Dimmers**

**Van Gogh Incandescent 120V AC 60Hz Only**

DESCRIPTION	CAT. NO.	RATING	COLOR*
Van Gogh Single-Pole Rotary (narrow fin)	<b>60800</b>	800W	I, W
Van Gogh 3-Way Push ON/Push OFF (narrow fin)	<b>60800-3</b>	800W	I, W
Van Gogh Single-Pole Rotary (narrow fin)	<b>61000</b>	1000W	I, W
Van Gogh 3-Way Push ON/Push OFF (narrow fin)	<b>61000-3</b>	1000W	I, W
Van Gogh Single-Pole Rotary (wide fin)	<b>61500</b>	1500W	I, W
Van Gogh Single-Pole Rotary (wide fin)	<b>62000</b>	2000W	I, W

*Note: Sharing a neutral wire may cause flickering. Connect all dimmers to the same phase or run a separate neutral to each phase. Consult Leviton Techline if problems persist.*

**When ganging these units, no derating is necessary except on those units which have had both sets of snap-off, fins removed. These shall be derated as follows:**

Maximum Load per Van Gogh Dimmer Multi-Gang with Fins Broken Off			
Cat. No.	Single	2-Gang	More Than 2-Gang
60800	800W	700W	600W
61000	1000W	800W	700W
61500	1500W	1300W	1100W
62000	2000W	1800W	1500W

**NOTE: For fin removal and switchbox requirements for ganging Leviton Van Gogh dimmers, refer to page C17.**

**Color Change Kits for 60800, 61000 Dimmer Units**

DESCRIPTION	CAT. NO.
Brown Cover and Matching Knob w/Gold Insert	<b>60001</b>
Ivory Cover and Matching Knob w/Gold Insert	<b>60001-I</b>
White Cover and Matching Knob w/ Silver Insert	<b>60001-W</b>

**Color Change Kits for 61500, 62000 Dimmer Units**

DESCRIPTION	CAT. NO.
Brown Cover and Matching Knob w/Gold Insert	<b>60002</b>
Ivory Cover and Matching Knob w/Gold Insert	<b>60002-I</b>
White Cover and Matching Knob w/ Silver Insert	<b>60002-W</b>

**Van Gogh™ Architectural Rotary Fan Speed Control 120V AC 60Hz Only**

DESCRIPTION	CAT. NO.	RATING	COLOR*
Van Gogh Single-Pole (wide fin)	61027	10 Amps	I, W

*Note: When more than one ceiling fan is controlled, make sure the blades are rotating on all fans.*

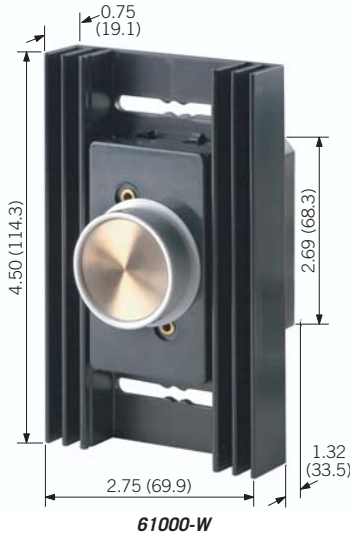

**61000-W**



**62000-W**

**Van Gogh Architectural Fin Width**  
Narrow: 2.75" (69.9 mm)  
Wide: 4.56" (115.8 mm)

**SPECIFICATIONS AND FEATURES**

- Classic rotary architectural-style dimmer is a popular choice in many installations
- Available in Rotary ON/OFF (single pole only) and Push-ON/Push-OFF (3-way).
- 3-way version is used with a standard 3-way ON/OFF switch
- Snap-on cover conceals heat fins
- Color-matched dimmer control knob with gold insert for an attractive appearance in any installation
- Snap-off fins permit easy ganging with other devices
- Slim, compact housing easily fits in standard wall box
- Large radio/TV interference filter

**TESTING AND CODE COMPLIANCE**

- UL Listed (File #E-31373, 62000 File #E-66800)
- CSA Certified (File #LR-3413)
- Backed by a Limited Five-Year Warranty

**\*COLOR**

Add suffix to catalog number as follows for colors: Ivory cover with Gold insert (-I), White cover with Silver insert (-W).

**MATERIAL CHARACTERISTICS**

Environmental: Flammability UL-94, V2 Rating  
Operating Temperature: 32°F to 130°F



# GANGING AND DERATING LIGHTING CONTROLS

## Commercial Grade Lighting Controls

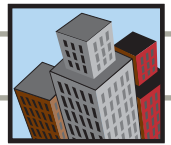

### Ganging and Derating Box-Mounted Lighting Controls

Ganging is an installation practice where two or more lighting controls are mounted side-by-side using the required number of connected wallboxes. Ganging may require the removal of part of the fins on Architectural Dimmers or part of the mounting strap on strap-mounted devices. In Architectural Dimmers, the metallic fins help dissipate heat from within the device. Strap mounted dimmers use the mounting strap for the same purpose. Therefore, removing a portion of the fins or strap for ganging purposes will require derating the dimmers to prevent them from overheating.

### Ganging and Derating Leviton Lighting Controls

When ganging Mural, True Touch, TouchPoint, ToggleTouch and IllumaTech controls, the side sections of the mounting strap must be removed. Use pliers to carefully bend side sections back and forth until they break off. The side sections of the strap dissipate heat, so removing them requires derating the dimmer's capacity. See Chart 1.

Note that Leviton SureSlide and Trimatron lighting controls can be ganged without removing any sections of their mounting straps. However, SureSlide and Trimatron controls must also be derated when they're ganged.

### Maximum Load Per Dimmer for Multi-Ganging All Strap-Mounted Dimmers

Chart 1			
Dimmer Rating	Single	2-Gang	More Than 2-Gang
500W	500W	400W	300W
600W	600W	500W	400W
1000W	1000W	800W	700W
400VA	400VA	350VA	250VA
600VA*	600VA	500VA	400VA
1000VA	1000VA	800VA	700VA

\*Except IPX06-7, which requires no derating

### Maximum Bulb Wattage for Magnetic Low-Voltage Lighting

The capacity of a magnetic low-voltage dimmer is its VA rating. If a wattage rating is also listed (as in this book), it is merely an estimate of the lamp wattage that can be placed on a UL-approved magnetic low-voltage transformer without exceeding the dimmer's VA rating. (This is, in turn, based on an estimate of transformer efficiency.)

Chart 2		
Power To Transformer	Transformer Efficiency	Lamp Load
1000VA	X 80%	= 800W
600VA	X 75%	= 450W

### Ganging and Leviton Renoir® and Van Gogh® Architectural Lighting Controls

When fins are broken off on wide and narrow controls for ganging purposes, the number of switch boxes required can be quickly determined by referring to the two charts below.

#### Ganging

Switch boxes required for ganging Leviton architectural controls when no fins are removed:

Number of Wide Controls	Number of Narrow Controls*				
	0	1	2	3	4
0	•	•	•	•	•
1	1	3	5	7	8
2	4	6	7	9	11
3	7	9	10	11	13
4	9	11	12	14	16

Switch boxes required for ganging Leviton architectural controls when all inside fins are removed:

Number of Wide Controls	Number of Narrow Controls						
	0	1	2	3	4	5	6
0	0	1	2	3	4	5	6
1	1	3	4	5	6	7	8
2	3	5	6	7	8	9	10
3	5	7	8	9	10	11	12
4	7	9	10	11	12	13	14
5	9	11	12	13	14	15	16
6	11	13	14	15	16	17	18

\*Narrow controls must have fins broken off to be ganged.



# MURAL® LIGHTING CONTROL FEATURES

## Commercial Grade Lighting Controls

### Mural Lighting Controls

The Leviton Mural® line is a comprehensive collection of dimmers, fan speed controls, and scene-capable dimmers and enhancement products. These rocker style devices provide full-range digital dimming in a sleek, Decora body that will enhance any décor.

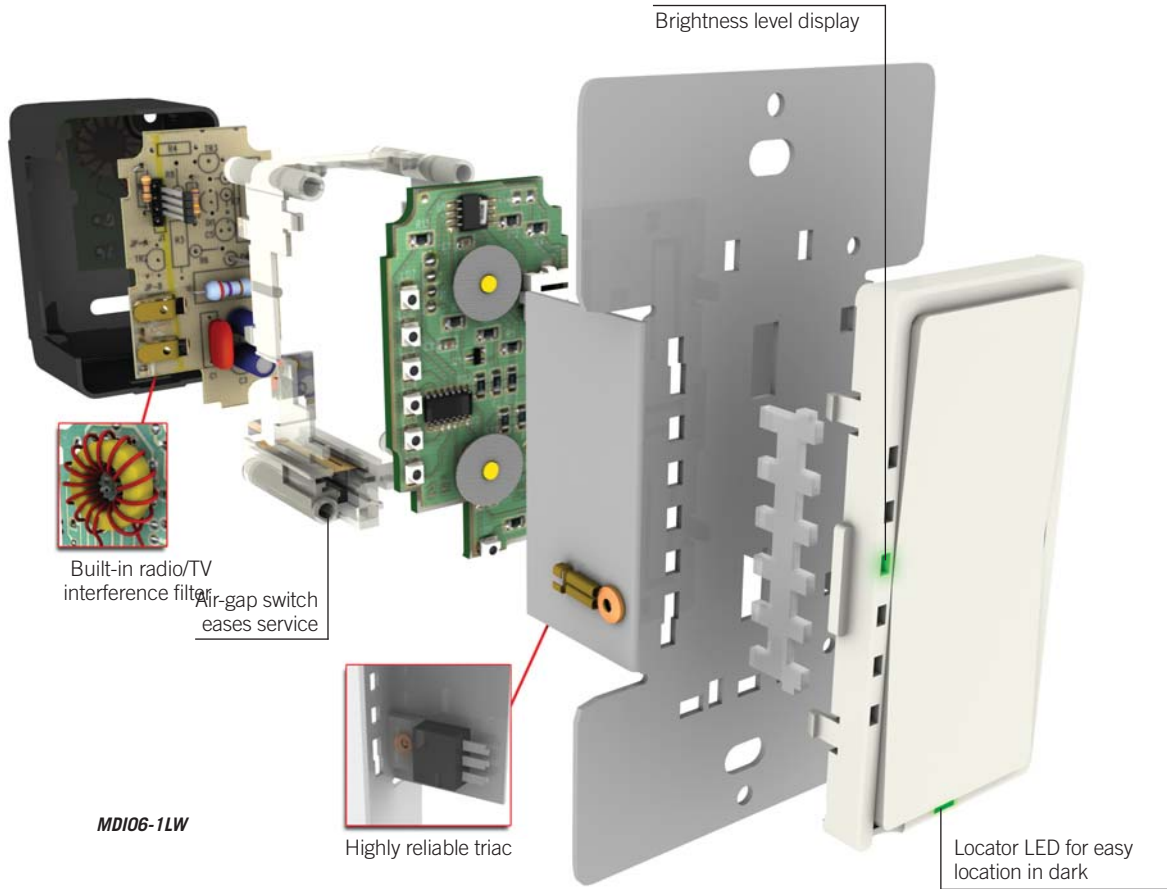

#### Features and Benefits

- Easy for people of all ages and abilities to operate
- Digital circuitry provides eye-pleasing soft-ON/fade-OFF that extends lamp life
- Compatible with Decora® screwless and Decora standard designer wallplates
- Wide range of colors available through convenient color change kits
- UL and CSA Listed
- Backed by a Limited Five-Year Warranty

#### THE COMPREHENSIVE LINE OF MURAL DIMMING, SCENE AND FAN SPEED CONTROLS



**Mural L/S Preset Dimmer**  
Decora rocker style digital dimmer with LED brightness level indicators. With inner rocker for setting brightness when lights are off. Color-change kits available.  
**ML106-1LW shown**



**Mural Preset Dimmer**  
Decora rocker-style digital dimmer with LED brightness level indicators. Convenient color-change kits available.  
**MD106-1LW shown**



**Mural Remote Unit**  
Enables multi-location dimming when used in conjunction with Mural Dimmer.  
**MS00R-10W shown**



**Mural 7-Scene Controller**  
Decora style controller sends commands for up to 7 distinct scenes to individual Mural Scene-Capable Controllers.  
**MN00C-1LW shown**

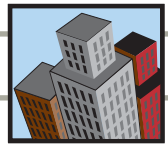

**Mural L/S (Level Set) Decora-Style Preset Digital Dimmer**

All Mural L/S dimmers provide single-pole (1 location) and 3-way (multi-location) control when used with Multi-Remote unit.

**Mural L/S Preset Digital Dimmer 120V AC 60Hz Only**

DESCRIPTION	CAT. NO.	RATING	COLOR*
Mural L/S Incandescent LED Locator and Brightness Display	<b>MLI06-1L</b>	600W	I, W, A (G, E, B with Kit)
Mural L/S Incandescent LED Locator and Brightness Display	<b>MLI10-1L</b>	1000W	I, W, A (G, E, B with Kit)
Mural L/S Magnetic Low-Voltage LED locator and Brightness Display	<b>MLM06-1L</b>	600VA (450W)	I, W, A (G, E, B with Kit)
Mural L/S Magnetic Low-Voltage LED locator and Brightness Display	<b>MLM10-1L</b>	1000VA (800W)	I, W, A (G, E, B with Kit)
Mural L/S Electronic Low-Voltage LED Locator and Brightness Display	<b>MLE03-1LW</b>	350VA (280W)	W (I, A, G, E, B with Kit)
Mural L/S Advance Mark 10™ Powerline Fluorescent Dimming Ballast LED Locator and Brightness Display	<b>MLX06-1L</b>	600VA	I, W, A (G, E, B with Kit)
Mural L/S Quiet Fan Speed Control LED Locator and Brightness Display	<b>MLF01-1L</b>	1.5A	I, W, A (G, E, B with Kit)
Mural L/S Incandescent LED Locator (no brightness display)	<b>MRI06-1L</b>	600W	I, W, A (G, E with Kit)
Mural L/S Incandescent LED Locator (no brightness display)	<b>MRI10-1L</b>	1000W	I, W, A (G, E with Kit)
Mural L/S Magnetic Low-Voltage LED Locator (no brightness display)	<b>MRM10-1L</b>	1000VA (800W)	I, W, A (G, E with Kit)
Multi-Remote Unit for Multi-Location Dimming (no LED locator or display)	<b>MSOOR-10</b>	No load rating	I, W, A (G, E, B with Kit)
Multi-Remote Unit for Electronic Low-Voltage Multi-Location Dimming (no LED locator or display)	<b>MSEOR-10W</b>	No load rating	W (I, A, G, E, B with Kit)
Color Change Kits for Mural L/S (ML versions)	<b>DLKDD-1L</b>	—	I, W, A, G, E, B
Color Change Kits for Multi-Remote Units (no LED locator or display)	<b>DRKOR-00</b>	—	I, W, A, G, E, B
Color Change Kit for Mural L/S (MR versions)	<b>MRKOD-OL</b>	—	I, W, A, G, E

See Page C8 for more information on Leviton Power Extenders

**Note: Sharing a neutral wire may cause flickering. Connect all dimmers to the same phase or run a separate neutral to each phase. Consult Leviton Techline if problems persist.**  
**Digital Lighting and Fan Speed Controls are polarity sensitive devices. Always follow the wiring instructions included with each device. They can be used in conventional 3-way and 4-way wiring circuits only when the Control is properly connected to the load as indicated by the device's wiring instructions.**

**CAUTION ON RETROFITS:** When retrofitting Mark 10™ Powerline dimming ballasts into fixtures that originally had Instant Start ballasts, the sockets MUST be replaced with Rapid Start sockets to allow proper dimmer operation and prevent damage to the dimming ballast. Refer to the instructions provided with the ballast and the Leviton Mark 10™ dimmer.

**SPECIFICATIONS AND FEATURES**

- Smooth Decora rocker-action for Preset ON/OFF switching with built-in arrow-shaped rocker for DIM/BRIGHT control
- Arrow rocker allows user to set brightness level when lights are off
- Second tap on top half of rocker for full bright. Gently double tap bottom half of rocker for fast OFF
- Easy to operate for people of all ages and abilities
- Provides single-pole (one-location) and multi-location full range dimming when used with Multi-Remote units
- Streamlined, popular Decora styling enhances any interior and adds a “family look” when ganged with any Decora device
- Digital circuitry provides SOFT-ON/FADE-OFF operation for an eye-pleasing effect and prolonged lamp life
- Square green LED display alongside rocker indicates selected brightness level on ML models
- Locator LED illuminates when lights are OFF
- Color change kits available in a wide range of choices, making it easy and economical to change decorating schemes
- Color change kits simplify inventory for distributors and contractors who can offer a complete range of colors without stocking a different device for each one

- Minimum brightness adjustment sets comfortable minimum light level
- Power failure recovery assures retention of lighting levels during long-term power interruptions.
- Built-in radio/TV interference filter
- ON/OFF AC air-gap switch completely disconnects power to unit for bulb changing or removal from service

**TESTING AND CODE COMPLIANCE**

- UL Listed (File #E-31373)
- CSA Certified (File #LR-3413)
- Backed by a Limited Five-Year warranty

**\*COLOR**

To order colors, add suffix to basic catalog number. Colors in parentheses must be ordered as Color Change Kits. Color suffixes are: Ivory (-I), White (-W), Almond (-A), Gray (-G), Black (-E) and Brown (-B).

**MATERIAL CHARACTERISTICS**

Environmental: Flammability UL-94, V2 Rating  
 Operating Temperature: 32°F to 130°F

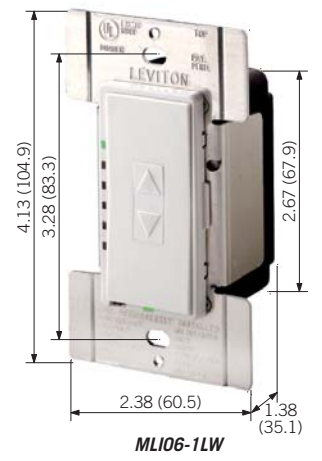

MLI06-1LW



MRI06-1LW

Use Leviton Power Extenders to extend the load capacity of box-mounted dimmers. Leviton Power Extenders are available for incandescent, magnetic low-voltage, electronic low-voltage, Advance Mark 10™ Powerline fluorescent dimming ballasts or equivalents, and 0–10 VDC dimmable fluorescent ballasts such as Advance Mark V7™, OSRAM Sylvania Quicktronic Helios or equivalent ballasts.



# MURAL® LIGHTING CONTROLS • 600–1000 WATTS • 120V AC 60Hz

## Commercial Grade Lighting Controls

### Mural Decora-Style Preset Digital Dimmer

All Mural dimmers provide single-pole (1 location) and 3-way (multi-location) control when used with Multi-Remote unit.

#### Mural Digital Dimmer 120V AC 60Hz Only

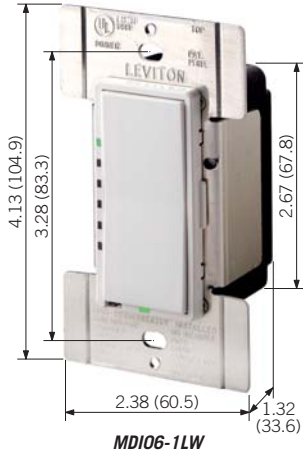

MDI06-1LW

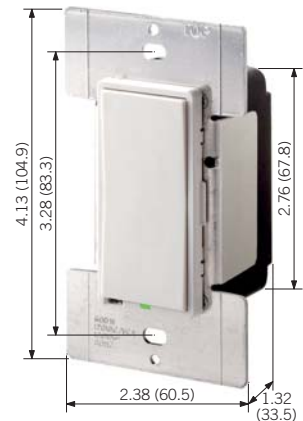

MSI06-1LW

DESCRIPTION	CAT. NO.	RATING	COLOR*
Mural Incandescent LED Locator and Brightness Display	MDI06-1L	600W	I, W, A (G, E, B with Kit)
Mural Incandescent LED Locator and Brightness Display	MDI10-1L	1000W	I, W, A (G, E, B with Kit)
Mural Magnetic Low-Voltage LED Locator and Brightness Display	MDM06-1L	600VA (450W)	I, W, A (G, E, B with Kit)
Mural Magnetic Low-Voltage LED Locator and Brightness Display	MDM10-1L	1000VA (800W)	I, W, A (G, E, B with Kit)
Mural Electronic Low-Voltage LED Locator and Brightness Display	MDE03-1LW	350VA (280W)	W (I, A, G, E, B with Kit)
Mural Quiet Fan Speed Control LED Locator and Brightness Display	MDFO1-1L	1.5A	I, W, A (G, E, B with Kit)
Mural Incandescent LED Locator (no Brightness Display)	MSI06-1L	600W	I, W, A (G, E with Kit)
Mural Incandescent LED Locator (no Brightness Display)	MSI10-1LW	1000W	W (I, A, G, E with Kit)
Mural Magnetic Low-Voltage LED Locator (no Brightness Display)	MSM10-1LW	1000VA (800W)	W (I, A, G, E with Kit)
Multi-Remote Unit for Multi-Location Dimming (no LED locator or display)	MSOOR-10	No load rating	I, W, A (G, E with Kit)
Multi-Remote Unit for Electronic Low-Voltage Multi-Location Dimming (no LED locator or display)	MSEOR-10W	No load rating	W (I, A, G, E with Kit)

#### Color Change Kits for Mural Dimmers

DESCRIPTION	CAT. NO.	COLOR*
Mural MD with LED Locator and Brightness Display	DRKDD-1L	I, W, A, G, E, B
Mural MS with LED Locator (no Brightness Display)	DRKOD-1L	I, W, A, G, E
Multi-Remote Units (no LED Locator or Display)	DRKOR-00	I, W, A, G, E

*Digital Lighting and Fan Speed Controls are polarity sensitive devices. Always follow the wiring instructions included with each device. They can be used in conventional 3-way and 4-way wiring circuits only when the Control is properly connected to the load as indicated by the device's wiring instructions.*

See Page C8 for more information on Leviton Power Extenders

#### SPECIFICATIONS AND FEATURES

- Provides single-pole (one-location) and multi-location full range dimming when used with MSOOR remote unit
- Streamlined popular Decora styling enhances any interior and adds a family look when ganged with other Decora devices
- Smooth ON/OFF and DIM/BRIGHT Decora rocker action provides ease of operation for people of all ages and abilities
- Digital circuitry provides Soft-ON/Fade-OFF switching for and eye-pleasing effect and extended lamp life
- Compatible with Decora screwless and Decora standard designer wallplates
- Locator LED illuminated when lights are OFF
- Color change kits available in a wide range of choices, making it easy and economical to change decorating schemes
- Color change kits simplify inventory for distributors and contractors who can offer a complete range of colors without stocking a different device for each one
- Protected memory and voltage compensation maintain light levels after short-term power outages and during minor power fluctuations

- Square green LED display alongside rocker indicates selected brightness level on MD models
- Built-in radio/TV interference filter
- ON/OFF AC air gap switch completely disconnects power to unit for bulb changing or removal from service

#### TESTING AND CODE COMPLIANCE

- UL Listed (File #E-31373)
- CSA Certified (File #LR-3413)
- Backed by a Limited Five-Year Warranty

#### \*COLOR

To order colors, add suffix to basic catalog number. Colors in parentheses must be ordered as Color Change Kits. Color suffixes are: Ivory (-I), White (-W), Almond (-A), Gray (-G), Black (-E) and Brown (-B).

#### MATERIAL CHARACTERISTICS

Environmental: Flammability UL-94, V2 Rating  
Operating Temperature: 32°F to 130°F

Use Leviton Power Extenders to extend the load capacity of box-mounted dimmers. Leviton Power Extenders are available for incandescent, magnetic low-voltage, electronic low-voltage, Advance Mark 10™ Powerline fluorescent dimming ballasts or equivalents, and 0–10 VDC dimmable fluorescent ballasts such as Advance Mark 7™ 0–10V, OSRAM Sylvania Quicktronic Helios or equivalent ballasts.

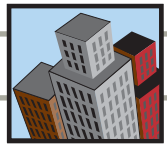

### Mural Scene Capable Decora-Style Digital Dimmer

Compatible with Scene Controller and Scene Enhancement Products — See page C22.

#### Mural Scene Capable Digital Dimmer 120V AC 60Hz Only

DESCRIPTION	CAT. NO.	RATING	COLOR*
Mural Scene Capable Incandescent/Magnetic Low-Voltage Dimmer with LED Locator and LED Brightness Display	MCM06-1L	600W/VA	I, W, A (G, E, B with Kit)
Mural Scene Capable Incandescent/Magnetic Low-Voltage Dimmer with LED Locator and LED Brightness Display	MCM10-1L	1000W/VA	I, W, A (G, E, B with Kit)
Mural Scene Capable Mark 10™ Preset Dimmer for 120V AC Advance Mark 10™ Powerline Fluorescent Dimming Ballast with LED Locator and LED Brightness Display	MCX10-1LW	1000VA (750W)	W (I, A, G, E, B with Kit)
Color Change Kits for Mural MC Scene Capable Dimmer	DRKDD-1L	—	I, W, A, G, E, B

See Page C8 for more information on Leviton Power Extenders

**Note: Sharing a neutral wire may cause flickering. Connect all dimmers to the same phase or run a separate neutral to each phase. Consult Leviton Techline if problems persist.**  
**Digital Lighting and Fan Speed Controls are polarity sensitive devices. Always follow the wiring instructions included with each device. They can be used in conventional 3-way and 4-way wiring circuits only when the Control is properly connected to the load as indicated by the device's wiring instructions.**

**CAUTION ON RETROFITS:** When retrofitting Mark 10™ Powerline dimming ballasts into fixtures that originally had Instant Start ballasts, the sockets MUST be replaced with Rapid Start sockets to allow proper dimmer operation and prevent damage to the dimming ballast. Refer to the instructions provided with the ballast and the Leviton Mark 10™ dimmer.

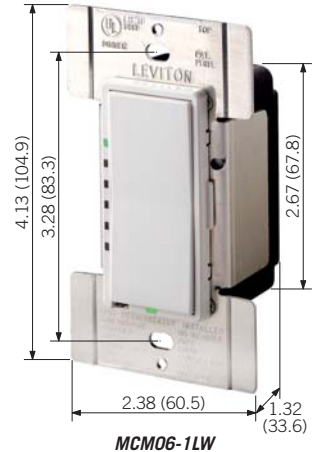

#### SPECIFICATIONS AND FEATURES

- Responds to lighting level commands sent by the Cat. No. MNOOC-1LW Scene Controller. Users can program the desired lighting level for individual Mural Scene Dimmers in up to seven distinct lighting scenes, which are easily accessed by one or more Scene Controllers
- Smooth ON/OFF and Dim/Bright Decora rocker action provides ease of operation for people of all ages and abilities
- Scene Controller also provides an OFF button and two arrow-shaped buttons for group Dim and Bright control
- Local Dim/Bright adjustment on individual scene dimmers will not affect programmed scene lighting settings
- Compatible with Scene Enhancement Products including Contact Closure Interface, Infrared Hand-Held Remote and Infrared Receiver, and one-way and two-way Signal Repeater
- Streamlined, popular Decora styling enhances any interior and adds a “family look” when ganged with any Decora device
- Digital circuitry provides SOFT-ON/FADE-OFF operation for an eye-pleasing effect and prolonged lamp life
- Square green LED display alongside rocker indicates selected brightness level
- Locator LED illuminates when lights are OFF
- Color change kits available in a wide range of choices, making it easy and economical to change decorating schemes

- Color change kits simplify inventory for distributors and contractors who can offer a complete range of colors without stocking a different device for each one
- Minimum Brightness Adjustment sets comfortable minimum light level
- Protected memory and voltage compensation maintain light levels after power outages and during minor power fluctuations
- Built-in radio/TV interference filter
- ON/OFF AC air-gap switch completely disconnects power to unit for bulb changing or removal from service

#### TESTING AND CODE COMPLIANCE

- UL Listed (File #E-31373)
- CSA Certified (File #LR-3413)
- Backed by a Limited Five-Year warranty

#### \*COLOR

To order colors, add suffix to basic catalog number. Colors in parentheses must be ordered as Color Change Kits. Color suffixes are: Ivory (-I), White (-W), Almond (-A), Gray (-G), Black (-E) and Brown (-B).

#### MATERIAL CHARACTERISTICS

Environmental: Flammability UL-94, V2 Rating  
 Operating Temperature: 32°F to 130°F

Use Leviton Power Extenders to extend the load capacity of box-mounted dimmers. Leviton Power Extenders are available for incandescent, magnetic low-voltage, electronic low-voltage, Advance Mark 10™ Powerline fluorescent dimming ballasts or equivalents, and 0–10 VDC dimmable fluorescent ballasts such as Advance Mark 7™ 0–10V, OSRAM Sylvania Quicktronic Helios or equivalent ballasts.



# MURAL® SCENE CONTROLS • NO LOAD RATING

## Commercial Grade Lighting Controls



### Mural Scene Controller and Accessories

#### Scene Controller for Mural Scene Capable Lighting Controls

DESCRIPTION	CAT. NO.	RATING	COLOR*
VScene Controller: 7 Lighting-Scene Buttons plus and OFF and Group DIM BRIGHT Buttons	<b>MNOOC-1LW</b>	No load rating, use with 120V Mural Scene dimmers only	White, for other colors use Color Change Kits
Color Change Kits with Text for MNOOC-1LW Scene Controller	<b>DCKS7-00</b>	—	I, W, A, G, E
Color Change Kit with Customizable Labels for Scene Controller	<b>DCKS7-OC</b>	No load rating	I, W, A, G, E

#### Scene Enhancement Products—

#### Compatible with Monet Scene Capable Lighting Controls

DESCRIPTION	CAT. NO.	RATING	COLOR*
Signal Repeater—Must be used if controlling lighting on more than one circuit. One-Way and Two-Way versions available	<b>17100-1WY, 17100-2WY</b>	No load rating	(Non-color item)
Contact Closure Interface—Allows control of Mural Scene Capable devices from home theater and building control systems via momentary contact inputs	<b>177BI</b>	No load rating	(Non-color item)
Infrared Receiver—Available with Wall Mount and Ceiling Mount Bezels	<b>177IR-IWA</b>	No load rating	Supplied with Ivory, White and Almond bezels
Hand-Held Infrared Remote Control— with 4 Scene Buttons plus OFF	<b>177RC</b>	No load rating	Black

*Note: A Repeater must be used on any installation that uses more than one circuit.*

#### SPECIFICATIONS AND FEATURES

##### Scene Controller

- Sends commands for up to seven distinct scenes to individual Mural Scene Capable Dimmers
- Multiple Scene Controllers can be used for multi-point access to scenes.
- Provides OFF button and two arrow-shaped buttons for group Dim and Bright control
- Local Dim/Bright adjustment on individual scene dimmers will not affect programmed scene settings.
- Green LED display for each scene button indicates selected scene
- Fast, easy scene programming: Press scene button on MNOOC, adjust individual level on Mural Scene Capable dimmer, press program button on dimmer
- Controls up to 20 scene dimmers per circuit
- Streamlined, popular Decora styling enhances any interior and adds a “family look” when ganged with any Decora device
- Use Decora Plus or any standard Decora wallplate
- Color change kits available in ivory, white, almond, gray, and black allow fast color changeover and simplify stocking inventory
- Internal MOV for surge protection

- Customized lettering for each scene button available (maximum of 8 characters and spaces) — see your Leviton representative for ordering information

##### Scene Enhancement Products

- Two-Way Repeater provides scene control communication link between branch circuits. One-Way Repeater allows the creation of separate scene control zones

#### TESTING AND CODE COMPLIANCE

- UL Listed (File #E-31373 – Cat. Nos. MN00C and 177IR; File #E-66800 – Cat. Nos. 17100-1WY and 17100-2WY; File #E-600800 – Cat. No. 177BI )
- CSA Certified (File #LR-3413)
- Backed by a Limited Five-Year Warranty

#### \*COLOR

Basic Cat. No. denotes White device. For other colors, order Color Change Kits and add suffix as follows: Ivory (-I), White (-W), Gray (-G), Black (-E), and Almond (-A).

#### MATERIAL CHARACTERISTICS

Environmental: Flammability UL-94, V2 Rating  
Operating Temperature: 32°F to 130°F

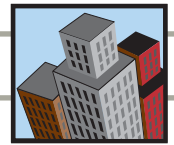

### Touch Lighting Controls

The Leviton Touch series includes three full-range dimming lines that use digital touch pad technology to enable dimming and switching with a touch of a finger: True Touch™, TouchPoint™, and ToggleTouch™.

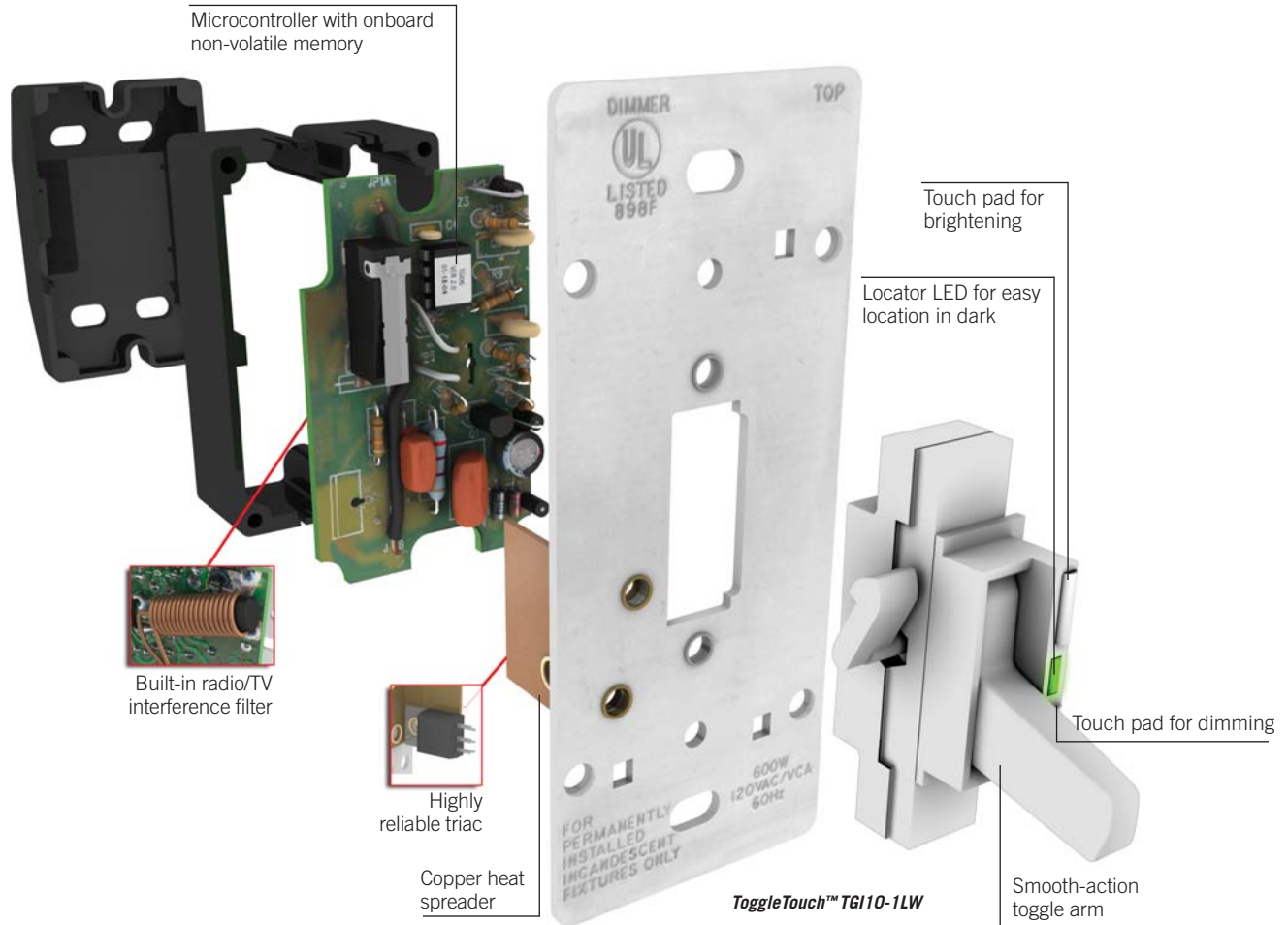

### Features and Benefits

- Preset dimmers incorporate touchpad technology
- Digital circuitry provides eye-pleasing soft-ON and fade-OFF that extends lamp life (most models)
- Single-point and multi-point control available
- Wide range of colors coordinates with any décor
- UL and CSA Listed
- Backed by a Limited Five-Year Warranty

### LEVITON TOUCH DIMMERS FOR FULL-RANGE DIMMING



**True Touch™ Dimmer**  
Decora-style digital touch dimmer. Provides fingertip full-range single-pole and multi-location dimming. Convenient color-change kits available.  
**TT110-10W shown**



**TouchPoint™ Dimmer**  
Decora full-range multi-location touch dimmer responds to where finger is placed on pad. With Preset switch, LED locator, and LED brightness indicators.  
**TPI06-1LW shown**



**ToggleTouch™ Dimmer**  
Unique design features toggle-style ON/OFF switch with bright and dim digital touch pads alongside toggle. Available with LED locator light.  
**TGI10-1LW shown**



# TOUCHPOINT™ LIGHTING CONTROLS • 600–1000 WATTS • 120V AC 60Hz

## Commercial Grade Lighting Controls

### TouchPoint Decora-Style Preset Digital Touch-Pad Dimmer

All TouchPoint dimmers provide single-pole (1 location) and 3-way (multi-location) control when used with Multi-Remote unit. All dimmers feature Brightness LEDs and a Locator LED.

#### TouchPoint Digital Touch-Pad Dimmer 120V AC 60Hz Only

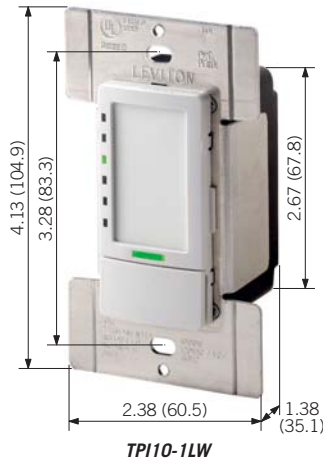

TPI10-1LW

DESCRIPTION	CAT. NO.	RATING	COLOR*
TouchPoint Incandescent	TPI06-1L	600W	I, W, A, G, E
TouchPoint Incandescent	TPI10-1L	1000W	I, W, A, G, E
TouchPoint Magnetic Low-Voltage	TPM06-1L	600VA (450W)	I, W, A, G, E
TouchPoint Magnetic Low-Voltage	TPM10-1L	1000VA (800W)	I, W, A, G, E
TouchPoint Advance Mark 10™ Fluorescent Dimming Ballast	TPX06-1L	600VA	I, W, A, G, E
TouchPoint Advance Mark 10™ Fluorescent Dimming Ballast	TPX10-1L	1000VA	I, W, A, G, E
Multi-Remote Unit for Multi-Location Dimming (no LED locator or display)	MSOOR-10W	No load rating	White, for other colors use Color Change Kits
Color Change Kits for Multi-Remote Units (no LED locator or display)	DRKOR-00	—	I, W, A, G, E

See Page C8 for more information on Leviton Power Extenders

**Note:** Sharing a neutral wire may cause flickering. Connect all dimmers to the same phase or run a separate neutral to each phase. Consult Leviton Techline if problems persist.  
**Digital Lighting and Fan Speed Controls are polarity sensitive devices. Always follow the wiring instructions included with each device. They can be used in conventional 3-way and 4-way wiring circuits only when the Control is properly connected to the load as indicated by the device's wiring instructions.**

**CAUTION ON RETROFITS:** When retrofitting Mark 10™ Powerline dimming ballasts into fixtures that originally had Instant Start ballasts, the sockets MUST be replaced with Rapid Start sockets to allow proper dimmer operation and prevent damage to the dimming ballast. Refer to the instructions provided with the ballast and the Leviton Mark 10™ dimmer.

#### SPECIFICATIONS AND FEATURES

- New advanced digital touch pad technology provides full range dimming by responding to where your finger is placed on the pad
- Provides single-pole (one-location) and multi-location full range dimming when used with MSOOR remote unit
- Attractive Decora styling blends with any interior
- Digital circuitry provides Soft-ON/Fade-OFF switching for an eye-pleasing effect and extended lamp life
- Compatible with Decora screwless and Decora standard designer wallplates
- Locator LED is illuminated when lights are OFF (no LED on Remote Unit)
- Easy-to-read LED display alongside touch pad indicates selected brightness level
- Minimum Brightness Adjustment sets comfortable minimum light level
- Protected memory maintains light levels after power outages and during minor power fluctuations
- Built-in radio/TV interference filter

#### TESTING AND CODE COMPLIANCE

- UL Listed (File #E-31373)
- CSA Certified (File #LR-3413)
- Backed by a Limited Five-Year Warranty

#### \*COLOR

Add suffix to catalog number as follows for colors: Ivory (-I), White (-W), Gray (-G), Black (-E), and Almond (-A).

#### MATERIAL CHARACTERISTICS

Environmental: Flammability UL-94, V2 Rating  
 Operating Temperature: 32°F to 130°F

Use Leviton Power Extenders to extend the load capacity of box-mounted dimmers. Leviton Power Extenders are available for incandescent, magnetic low-voltage, electronic low-voltage, Advance Mark 10™ Powerline fluorescent dimming ballasts or equivalents, and 0–10 VDC dimmable fluorescent ballasts such as Advance Mark 7™ 0–10V, OSRAM Sylvania Quicktronic Helios or equivalent ballasts.





### True Touch Decora-Style Digital Touch Dimmer

All True Touch dimmers provide single-pole (1 location) and 3-way (multi-location) control when used with TrueTouch Remote.

#### True Touch Digital Touch Dimmer 120V AC 60Hz Only

DESCRIPTION	CAT. NO.	RATING	COLOR*
True Touch Incandescent	TTI06-1AW	600W	W + A, (I, WS, GI, GY, E, BG with kit)
True Touch Incandescent	TTI06-1EI	600W	I + E, (W, A, WS, GI, GY, BG with kit)
True Touch Incandescent	TTI06-1GS	600W	WS + GI, (W, I, A, GY, E, BG with kit)
True Touch Incandescent	TTI10-1	1000W	W, I, A, WS, GI, (GY, E, BG with Kit)
True Touch Magnetic Low-Voltage	TTM10-1	1000VA (800W)	W, I, A, WS, GI, (GY, E, BG with Kit)
True Touch Remote Unit (no LED)	TT00R-1	No load rating	W, I, A, WS, GI, (GY, E, BG with Kit)
True Touch Dimmer Color Change Kit	TTKIT-0	—	W, I, A, WS, GI, GY, E, BG
True Touch Remote Unit Color Change Kit	TTKTR-0	—	W, I, A, WS, GI, GY, E, BG

See Page C8 for more information on Leviton Power Extenders

Digital Lighting and Fan Speed Controls are polarity sensitive devices. Always follow the wiring instructions included with each device. They can be used in conventional 3-way and 4-way wiring circuits only when the Control is properly connected to the load as indicated by the device's wiring instructions.

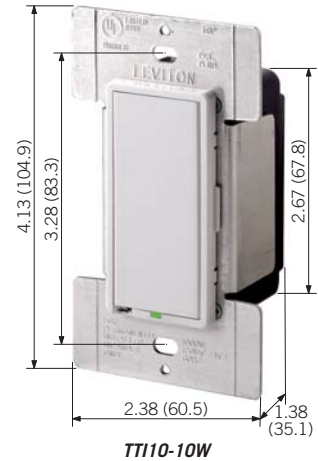

TTI10-10W

#### SPECIFICATIONS AND FEATURES

- Provides fingertip ease of use and precise adjustment of lighting levels. Simple one-touch for ON at Preset level, or again for OFF. Touch and hold for BRIGHT/DIM lighting control
- Provides single-pole (one-location) and multi-location full range dimming when used with TT00R remote unit
- Attractive Decora styling blends with any interior
- Digital circuitry provides Soft-ON/Fade-OFF switching for and eye-pleasing effect and extended lamp life
- Compatible with Decora screwless and Decora standard designer wallplates
- Locator LED is illuminated when lights are OFF (no LED on Remote Unit)
- Color change kits offered in a wide range of colors, making it easy and economical to change decorating schemes
- Minimum Brightness Adjustment sets comfortable minimum light level
- Protected memory maintains light levels after short-term power outages and during minor power fluctuations
- Built-in radio/TV interference filter
- ON/OFF AC air gap switch completely disconnects power to unit for bulb changing or removal from service

#### TESTING AND CODE COMPLIANCE

- UL Listed (File #E-31373)
- CSA Certified (File #LR-3413)
- Backed by a Limited Five-Year Warranty

#### \*COLOR

TTI06 comes packaged two-in-one: all White and all Almond (AW), all Ivory and all Black (EI), and White frame/Silver touch and Ivory frame/Gold touch (GS). The TTI10 and TTM10 can be ordered in all White (OW), all Ivory (OI), all Almond (OA), White frame/Silver touch (WS), and Ivory frame/Gold touch (GI). Color change kits include these and other colors, add to end of catalog number as follows: all White (OW), all Ivory (OI), all Almond (OA), White frame/Silver touch (WS), Ivory frame/Gold touch (GI), all Gray (GY), all Black (OE), and Brown frame/Gold touch (BG).

#### MATERIAL CHARACTERISTICS

Environmental: Flammability UL-94, V2 Rating  
Operating Temperature: 32°F to 130°F

Use Leviton Power Extenders to extend the load capacity of box-mounted dimmers. Leviton Power Extenders are available for incandescent, magnetic low-voltage, electronic low-voltage, Advance Mark 10™ Powerline fluorescent dimming ballasts or equivalents, and 0–10 VDC dimmable fluorescent ballasts such as Advance Mark 7™ 0–10V, OSRAM Sylvania Quicktronic Helios or equivalent ballasts.

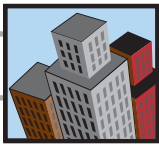

Commercial Grade Lighting Controls

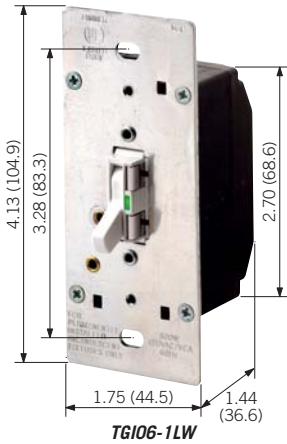

ToggleTouch Toggle Digital Preset Touch Dimmer

All ToggleTouch Preset Dimmers provide single-pole (one-location) and 3-way (multi-location) control when used with a 3-way switch, except where noted.

ToggleTouch Digital Touch Dimmer 120V AC 60Hz Only  

DESCRIPTION	CAT. NO.	RATING	COLOR*
ToggleTouch Incandescent (No LED locator, single-pole only)	TG106-10	600W	W, I, A
ToggleTouch Incandescent	TG106-1L	600W	W, I, A, T, B
ToggleTouch Incandescent	TG110-1L	1000W	W, I, A, T, G
ToggleTouch Magnetic Low-Voltage	TGM10-1L	1000VA (800W)	W, I, A, T, G

Note: Leviton does not recommend using the ToggleTouch Dimmer with metal wallplates.

See Page C8 for more information on Leviton Power Extenders

Digital Lighting and Fan Speed Controls are polarity sensitive devices. Always follow the wiring instructions included with each device. They can be used in conventional 3-way and 4-way wiring circuits only when the Control is properly connected to the load as indicated by the device's wiring instructions.

Use Leviton Power Extenders to extend the load capacity of box-mounted dimmers. Leviton Power Extenders are available for incandescent, magnetic low-voltage, electronic low-voltage, Advance Mark 10™ Powerline fluorescent dimming ballasts or equivalents, and 0–10 VDC dimmable fluorescent ballasts such as Advance Mark 7™ 0–10V, OSRAM Sylvania Quicktronic Helios or equivalent ballasts.

SPECIFICATIONS AND FEATURES

- Provides a unique combination of toggle-style ON/OFF switching and digital Touch Pad technology
- Designed for smooth ON/OFF toggle action and fingertip-control touch dimming that's easy to operate
- Provides single-pole (one-location) and multi-location 3-way control when used with a 3-way switch
- Touch pads match color of toggle switch
- Fits perfectly with Leviton standard toggle wallplates; gangs perfectly with all Leviton toggle switches
- Provides preset dimming with soft-ON feature (does not provide fade OFF)
- Available with Locator LED that is illuminated when lights are OFF
- Protected memory during temporary power failures ensures that ToggleTouch will retain last setting before power interruption
- Built-in radio/TV interference filter

TESTING AND CODE COMPLIANCE

- UL Listed (File #E-31373)
- CSA Certified (File #LR-3413)
- Backed by a Limited Five-Year Warranty

\*COLOR

Add suffix to catalog number as follows for other colors: Brown (-B), Ivory (-I), White (-W), Almond (-A), Light Almond (-T) and Gray (-G).

MATERIAL CHARACTERISTICS

Environmental: Flammability UL-94, V2 Rating  
Operating Temperature: 32°F to 130°F

# TRADITIONAL LIGHTING CONTROL FEATURES

## Commercial and Residential Grade Lighting Controls

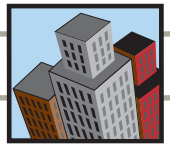

### Traditional Lighting Controls

Leviton offers a full line of slide, rotary and toggle dimmers and fan speed controls ideally suited to traditional interiors. The line includes Leviton IllumaTech™, SureSlide™, and Trimatron® brand devices as well as a number of specialty lighting devices. Leviton Traditional Controls are offered in a variety of colors.

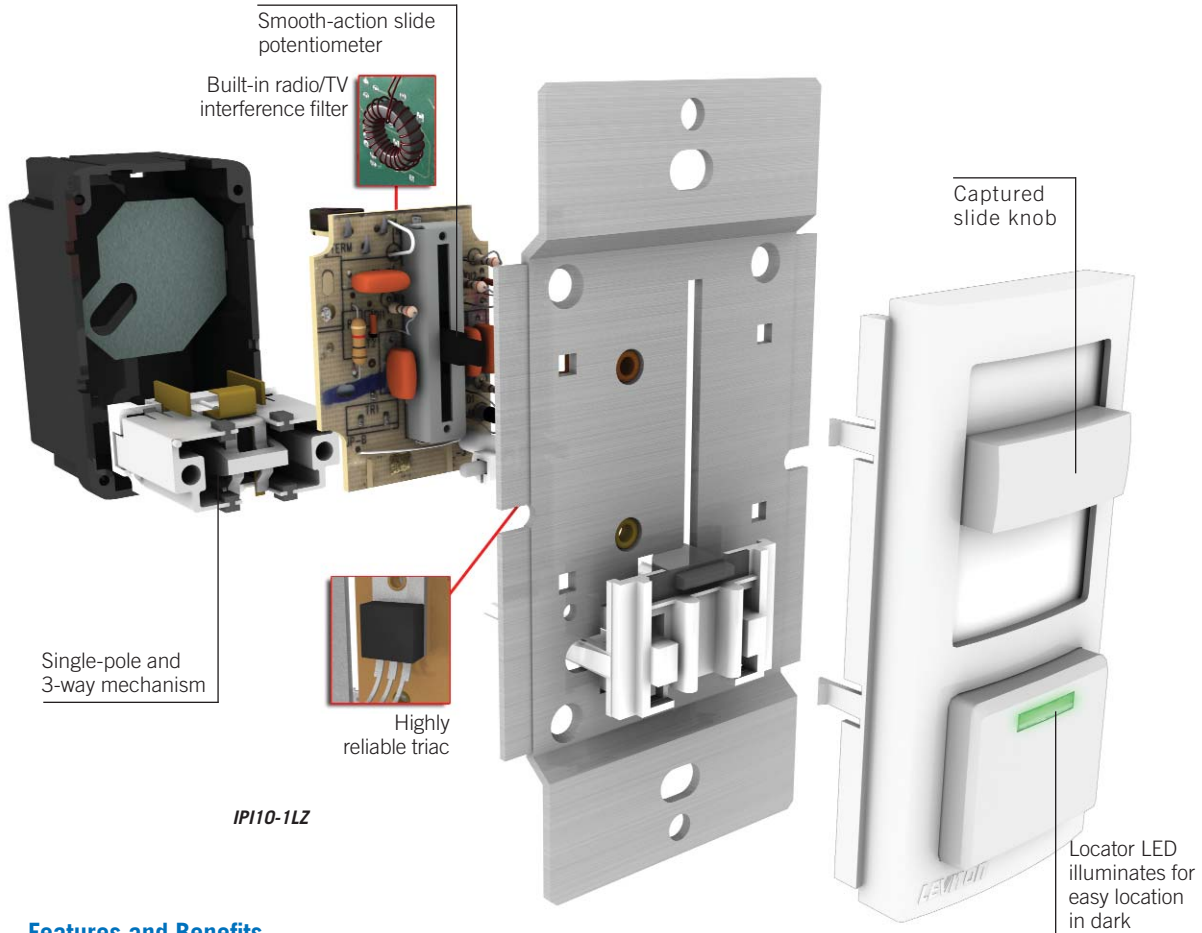

IPI10-1LZ

### Features and Benefits

- Features slide-, rotary- and toggle-style dimmers
- Most with full-range dimming and built-in radio/TV interference filter
- Single-point and multi-point control available
- UL and CSA Listed
- Backed by a Limited Five-Year Warranty

### TRADITIONAL STYLE SLIDE AND ROTARY LIGHTING CONTROLS



#### IllumaTech™ Slide and Rotary Dimmers

Decora-style digital dimmer with full-range, single- and multi-location dimming in a touch of a finger. Convenient color change kits available.  
**IPI06-1LZ shown**



#### SureSlide™ Slide Dimmer

Smooth-action slide control for easy, precise operation. Slim design ideal for multi-gang installations. Preset and slide-to-off versions.  
**6633-PLW shown**



#### Trimatron® Rotary Dimmer

Ultra-compact, full-range rotary dimmers.  
**6681-W shown**



#### Specialty Lighting Controls

Specialty dimmers, sockets and switches. Emergency switch flashes lights on and off. Lamp-cord and 4-step dimmers also available.  
**911-W shown**



**Commercial Grade Lighting Controls**

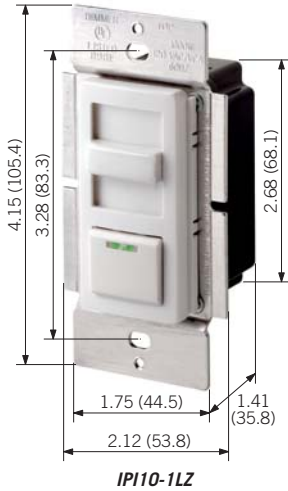

**IllumaTech Decora-Style Preset Slide Controls**

All IllumaTech Preset Dimmers provide single-pole (one-location) and 3-way (multi-location) control when used with a 3-way switch.

**IllumaTech Colors**—All IllumaTech Preset Slide Controls are available in Ivory (-I), White (-W), Almond (-T), Light Almond (-T), Gray (-G), Black (-E), Brown (-B) and Red (-R). Devices come packaged with three colors as indicated in the chart below. Color change Kits can also be ordered separately for every color.

**IllumaTech Slide Controls—Single Pole and 3-Way**  

DESCRIPTION	CAT. NO.	RATING	COLOR*
IllumaTech Incandescent with LED Locator	<b>IPI06-1LZ</b>	600W	I + W + T
	<b>IPI06-1LX</b>	120V AC 60Hz	I + W + A
IllumaTech Incandescent with LED Locator	<b>IPI10-1LZ</b>	1000W	I + W + T
	<b>IPI10-1LX</b>	120V AC 60Hz	I + W + A
IllumaTech Electronic Low-Voltage with LED Locator	<b>IPE04-1LZ</b>	400VA (320W)	I + W + T
	<b>IPE04-1LX</b>	120V AC 60Hz	I + W + A
IllumaTech Magnetic Low-Voltage with LED Locator	<b>IPM06-1LZ</b>	600VA (450W)	I + W + T
	<b>IPM06-1LX</b>	120V AC 60Hz	I + W + A
IllumaTech Magnetic Low-Voltage with LED Locator	<b>IPM10-1LZ</b>	1000VA (800W)	I + W + T
	<b>IPM10-1LX</b>	120V AC 60Hz	I + W + A
IllumaTech Advance Mark 7™ 0-10V Fluorescent Dimming Ballast with LED Locator	<b>IP710-DLZ</b>	1200VA @ 120V AC 60Hz, 1500VA @ 277V AC 60Hz	I + W + T
	<b>IP710-DLX</b>		I + W + A
IllumaTech Advance Mark 10™ Powerline Fluorescent Dimming Ballast (no LED Locator)	<b>IPX06-1LZ</b>	600VA	I + W + T
	<b>IPX06-1LX</b>	120V AC 60Hz	I + W + A
IllumaTech Advance Mark 10™ Powerline Fluorescent Dimming Ballast (no LED Locator)	<b>IPX10-1LZ</b>	1000VA	I + W + T
	<b>IPX10-1LX</b>	120V AC 60Hz	I + W + A
IllumaTech Advance Mark 10™ Powerline Fluorescent Dimming Ballast (no Locator LED)	<b>IPX06-7LZ</b>	600VA	I + W + T
	<b>IPX06-7LX</b>	277V AC 60Hz	I + W + A
IllumaTech Advance Mark 10™ Powerline Fluorescent Dimming Ballast (no Locator LED)	<b>IPX12-7LZ</b>	1200VA	I + W + T
	<b>IPX12-7LX</b>	277V AC 60Hz	I + W + A
IllumaTech Quiet Fan Speed Control with LED Locator	<b>IPF01-1LZ</b>	1.5 Amps	I + W + T
	<b>IPF01-1LX</b>	120V AC 60Hz	I + W + A
IllumaTech Fan Speed Control with LED Locator	<b>IPF05-1LZ</b>	5 Amps	I + W + T
	<b>IPF05-1LX</b>	120V AC 60Hz	I + W + A
IllumaTech Color Change Kit (with LED window) with LED Locator	<b>IPKIT-00</b>	—	I, W, A, T, G, E, B, R
	<b>IPKIT-0N</b>	—	I, W, A, T, G, E, B, R
IllumaTech Color Change Kit (no LED window) with LED Locator	<b>IPKIT-00</b>	—	I, W, A, T, G, E, B, R
	<b>IPQFK-00</b>	—	I, W, A, T, G, E, B, R

See Page C8 for more information on Leviton Power Extenders

**Note: Sharing a neutral wire may cause flickering. Connect all dimmers to the same phase or run a separate neutral to each phase. Consult Leviton Techline if problems persist.**

**CAUTION ON RETROFITS:** When retrofitting Mark 10™ Powerline dimming ballasts into fixtures that originally had Instant Start ballasts, the sockets MUST be replaced with Rapid Start sockets to allow proper dimmer operation and prevent damage to the dimming ballast. Refer to the instructions provided with the ballast and the Leviton Mark 10™ dimmer.

**SPECIFICATIONS AND FEATURES**

- Fluid slide movement allows fine adjustment of light level with minimum effort
- Captured, wrap-around slide bar stays in place and cannot fall off during use
- Provide easy-to-use pushbutton switch with locator LED conveniently positioned on it, making the pushbutton easier to find in the dark
- Provide single-pole (one-location) and multi-location lighting control when used with a 3-way switch
- Attractive Decora styling blends with any interior
- Compatible with Decora screwless and Decora standard designer wallplates
- Power failure recovery ensures retention of last setting before power interruption
- Built-in radio/TV interference filter
- Quiet 1.5 Amp Fan Speed Controls are ideal for libraries, study rooms and any area where ceiling fan noise could become distracting. Full range 5-amp fan speed controls also available
- Color change kits feature a self-aligning mechanism that automatically connects it to internal slider

- Snap-On Color Change Kits allow color changes on any device, eliminating the need to stock a separate device for every available color

**TESTING AND CODE COMPLIANCE**

- UL Listed (File #E-31373)
- CSA Certified (File #LR-3413)
- Backed by a Limited Five-Year Warranty

**\*COLOR**

IllumaTech Preset Controls come packaged with three colors. Controls with suffix (-Z) include Ivory, White and Light Almond; controls with suffix (-X) include Ivory, White and Almond. Color Change Kits are available in all colors. Add suffix to the Color Change Kit catalog number as follows: Ivory (-I), White (-W), Almond (-T), Light Almond (-T), Gray (-G), Black (-E), Brown (-B) and Red (-R).

**MATERIAL CHARACTERISTICS**

Environmental: Flammability UL-94, V2 Rating  
Operating Temperature: 32°F to 130°F

Use Leviton Power Extenders to extend the load capacity of box-mounted dimmers. Leviton Power Extenders are available for incandescent, magnetic low-voltage, electronic low-voltage, Advance Mark 10™ Powerline fluorescent dimming ballasts or equivalents, and 0–10 VDC dimmable fluorescent ballasts such as Advance Mark 7™ 0–10V, OSRAM Sylvania Quicktronic Helios or equivalent ballasts.



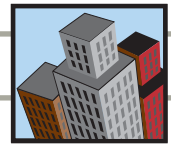

**IlumaTech Decora-Style Rotary Controls**

All IlumaTech Rotary Controls combine the ease of a traditional rotary dial with the contemporary look of Leviton Decora®.

**IlumaTech Rotary Controls 120V AC 60Hz Only**  

DESCRIPTION	CAT. NO.	RATING	COLOR*
IlumaTech Rotary Incandescent, Single-Pole and 3-way, Illuminated	<b>RPIO6-LAW</b>	600W	W+A
IlumaTech Rotary Incandescent, Single-Pole and 3-way, Illuminated	<b>RPIO6-LEI</b>	600W	I+E
IlumaTech Rotary Incandescent, Single-Pole and 3-way, Non-Illuminated	<b>RPIO6-OAW</b>	600W with kit)	W+A
IlumaTech Rotary Incandescent, Single-Pole and 3-way, Non-Illuminated	<b>RPIO6-OEI</b>	600W	I+E
IlumaTech Rotary Quiet Fan Speed Control, Single-Pole, Non-Illuminated	<b>RTFO1-OAW</b>	1.5 Amp	W+A
IlumaTech Rotary Quiet Fan Speed Control, Single-Pole, Non-Illuminated	<b>RTFO1-OEI</b>	1.5 Amp	I+E
IlumaTech Rotary Dual Quiet Fan Speed Control and Fixture Dimmer, Single-Pole, Non-Illuminated	<b>RTDO1-OAW</b>	1.5 Amp Fan Control/ 300W Dimmer	W+A
IlumaTech Rotary Dual Quiet Fan Speed Control and Fixture Dimmer, Single-Pole, Non-Illuminated	<b>RTDO1-OEI</b>	1.5 Amp Fan Control/ 300W Dimmer	I+E

See Page C8 for more information on Leviton Power Extenders

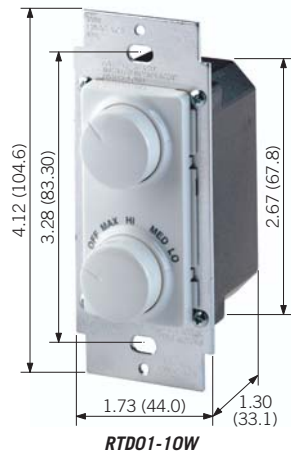
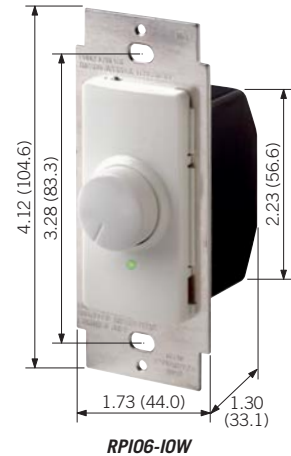

**SPECIFICATIONS AND FEATURES**

- Combines traditional rotary dial with contemporary Decora styling
- Dimmers provide single-pole (one-location) or multi-location (3-way) control when used with a 3-way switch
- Dimmers available in illuminated and non-illuminated versions
- Quiet 1.5 Amp Fan Speed Controls are perfect for libraries, study rooms and any area where ceiling fan noise could become distracting
- Dual fan speed control and dimmer is ideal for ceiling fans with built-in light fixtures
- Attractive Decora styling coordinates perfectly with Leviton's complete line of Decora wiring devices
- Compatible with Decora Plus screwless and Decora standard designer wallplates
- Built-in radio/TV interference filter
- Slim, compact housing fits easily into a standard wallbox and is suitable for multi-gang installations

**TESTING AND CODE COMPLIANCE**

- UL Listed (File #E-31373)
- CSA Certified (File #LR-3413)
- Backed by a Limited Five-Year Warranty

**\*COLOR**

Controls with suffix (-AW) are assembled with Almond (-A) and White (-W) kits; controls with suffix (-EI) are assembled with Black (-E) and Ivory (-I) kits.

**MATERIAL CHARACTERISTICS**

Environmental: Flammability UL-94, V2 Rating  
Operating Temperature: 32°F to 130°F

Use Leviton Power Extenders to extend the load capacity of box-mounted dimmers. Leviton Power Extenders are available for incandescent, magnetic low-voltage, electronic low-voltage, Advance Mark 10™ Powerline fluorescent dimming ballasts or equivalents, and 0-10 VDC dimmable fluorescent ballasts such as Advance Mark 7™ 0-10V, OSRAM Sylvania Quicktronic Helios or equivalent ballasts.



Commercial Grade Lighting Controls

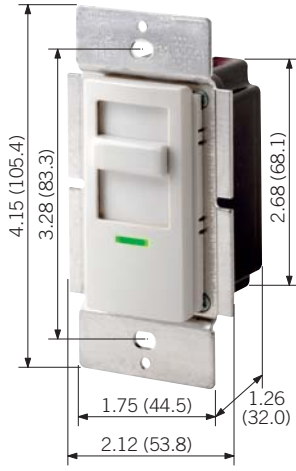

IINI10-1LW

IllumaTech Decora-Style Slide-To-Off Controls

Single Pole Only, with LED Locator— 120V AC 60Hz Only  

DESCRIPTION	CAT. NO.	RATING	COLOR CHANGE KIT*
IllumaTech Incandescent	INI06-1L	600W	I, W, A (T, G, E, B with Kit)
IllumaTech Incandescent (no LED locator)	INI06-10	600W	I, W, A
IllumaTech Incandescent	INI10-1L	1000W	I, W, A (T, G, E, B with Kit)
IllumaTech Magnetic Low-Voltage	INM06-1L	600VA (450W)	I, W, A (T, G, E, B with Kit)
IllumaTech Magnetic Low-Voltage	INM10-1L	1000VA (800W)	I, W (A, T, G, E, B with Kit)
IllumaTech Quiet Fan Speed Control	INF01-1L	1.5 Amps	I, W, A (G, E, B with Kit)
IllumaTech Fan Speed Control	INF05-1L	5 Amps	I, W, A (T, G, E, B with Kit)
IllumaTech Color Change Kit	INKIT-00	—	I, W, A, T, G, E, B
IllumaTech Color Change Kit for Quiet Fan Speed Control	INQFK-00	—	I, W, A, G, E, B

See Page C8 for more information on Leviton Power Extenders

SPECIFICATIONS AND FEATURES

- Fluid slide movement allows fine adjustment of light level with minimum effort
- Captured, wrap-around slide bar stays in place and cannot fall off during use
- Attractive Decora styling blends with any interior
- Compatible with Decora screwless and Decora standard designer wallplates
- Locator LED is illuminated when lights are OFF. LED is positioned in the same location on both Preset and Slide-To-Off versions, giving a true “family look” to IllumaTech
- Power failure recovery ensures retention of last setting before power interruption
- Built-in radio/TV interference filter
- Quiet 1.5 Amp Fan Speed Controls are ideal for libraries, study rooms and any area where ceiling fan noise could become distracting. Full range 5-amp fan speed controls also available
- Color change kits feature a self-aligning mechanism that automatically connects it to internal slider
- Snap-On Color Change Kits allow color changes on any device, eliminating the need to stock a separate device for every available color

TESTING AND CODE COMPLIANCE

- UL Listed (File #E-31373)
- CSA Certified (File #LR-3413)
- Backed by a Limited Five-Year Warranty

\*COLOR

To order colors, add suffix to basic catalog number. Colors in parentheses must be ordered as Color Change Kits. Color suffixes are: Ivory (-I), White (-W), Almond (-A), Light Almond (-T), Gray (-G), Black (-E) and Brown (-B).

MATERIAL CHARACTERISTICS

Environmental: Flammability UL-94, V2 Rating  
Operating Temperature: 32°F to 130°F

Use Leviton Power Extenders to extend the load capacity of box-mounted dimmers. Leviton Power Extenders are available for incandescent, magnetic low-voltage, electronic low-voltage, Advance Mark 10™ Powerline fluorescent dimming ballasts or equivalents, and 0–10 VDC dimmable fluorescent ballasts such as Advance Mark 7™ 0–10V, OSRAM Sylvania Quicktronic Helios or equivalent ballasts.





Residential Grade Lighting Controls

SureSlide Decora-Style Full Range Slide Controls 120V AC 60HzOnly

Incandescent

DESCRIPTION	CAT. NO.	RATING	COLOR*
SureSlide Single-Pole Slide-To-Off, Illuminated option	6631-L	600W	I, W, A, T
SureSlide Single-Pole and 3-Way with Preset On/OFF Switch	6623-P	600W	I, W, GY, E, B
SureSlide Single-Pole and 3-Way with Preset On/OFF Switch, Illuminated option	6633-PL	600W	I, W, A, T
SureSlide Dual Slide-To-Off Dimmer—(2) Single-Pole Loads, Incandescent or Magnetic Low-Voltage	6628	300W or 300VA per circuit; 600W/600VA Total	I, W, A, GY

Low Voltage

DESCRIPTION	CAT. NO.	RATING	COLOR*
SureSlide Magnetic Low-Voltage Single-Pole with Preset ON/OFF Switch	6611-P	600VA (450W)	I, W, A, GY, E, B,
SureSlide Magnetic Low-Voltage Single-Pole and 3-Way with Preset On/OFF Switch, Illuminated option	6613-PL	600VA (450W)	I, W, A, T
SureSlide Electronic Low-Voltage Single-Pole and 3-Way with Preset On/OFF Switch	6615-P	300W	W, T

Advance Mark 10™ Powerline/Philips Marathon™

DESCRIPTION	CAT. NO.	RATING	COLOR*
SureSlide Single-Pole	6668	Mark 10 500W-120V, Philips Dimmable Marathon—350W-120V	I, W

Full-Range Fan Speed Control

DESCRIPTION	CAT. NO.	RATING	COLOR*
SureSlide Single-Pole	6627-1	5 Amps	I, W, B
SureSlide Single-Pole with Preset ON/OFF	6627-P	5 Amps	I, W, A, T, G, E, B
SureSlide 3-Way with Preset ON/OFF	6637-P	5 Amps	I, W, A

Quiet Step Fan Speed Controls

DESCRIPTION	CAT. NO.	RATING	COLOR* (Brown Not Available)
SureSlide Single-Pole Quiet Step	6629-P	1.5 Amps	I, W, A, T, GY
SureSlide 3-way Quiet Step with Preset ON/OFF	6629-3	1.5 Amps	I, W, A, GY
SureSlide Dual Quiet Fan Speed and Fixture Dimmer	6630	1.5A Fan/300W Fixture	I, W, A, T, GY

See Page C8 for more information on Leviton Power Extenders

CAUTION ON RETROFITS: When retrofitting Mark 10™ Powerline dimming ballasts into fixtures that originally had Instant Start ballasts, the sockets MUST be replaced with Rapid Start sockets to allow proper dimmer operation and prevent damage to the dimming ballast. Refer to the instructions provided with the ballast and the Leviton Mark 10™ dimmer.

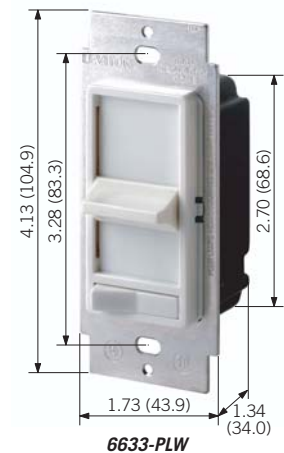
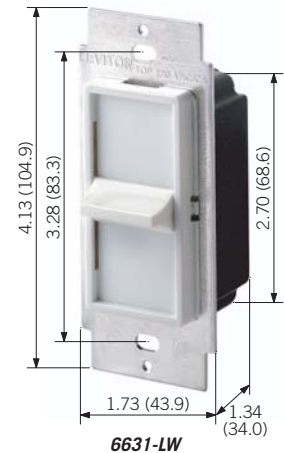

SPECIFICATIONS AND FEATURES

- All SureSlide devices have a permanently mounted smooth-action integrated linear slide control for easy, precise operation
- SureSlide features a slim, compact housing that fits easily into a standard wallbox and is suitable for multi-gang installations
- Preset versions provide single-pole (one-location) and multi-location lighting control when used with a 3-way switch
- Illuminated versions feature optional-use Locator LED.
- SureSlide's attractive Decora styling coordinates perfectly with Leviton's complete line of Decora wiring devices
- Compatible with Decora screwless and Decora standard designer wallplates
- Built-in radio/TV interference filter
- Quiet 1.5 Amp Fan Speed Controls are ideal for libraries, study rooms and any area where ceiling fan noise could become distracting. Full range 5-amp fan speed controls also available

- SureSlide Cat. No. 6668 is specially designed to work with the Philips Dimmable Marathon™
- Preset versions provide a low-end trim adjustment for precise lamp brightness and fan speed at the low-end settings

TESTING AND CODE COMPLIANCE

- UL Listed (File #E-31373)
- CSA Certified (File #LR-3413)
- Backed by a Limited Five-Year Warranty

\*COLOR

Basic Cat. No. denotes Brown where Brown is available. Add suffix to catalog number as follows for other colors: Ivory (-I), White (-W), Gray (-GY), Black (-E), Almond (-A), and Light Almond (-T).

MATERIAL CHARACTERISTICS

Environmental: Flammability UL-94, V2 Rating  
Operating Temperature: 32°F to 130°F

Use Leviton Power Extenders to extend the load capacity of box-mounted dimmers. Leviton Power Extenders are available for incandescent, magnetic low-voltage, electronic low-voltage, Advance Mark 10™ Powerline fluorescent dimming ballasts or equivalents, and 0-10 VDC dimmable fluorescent ballasts such as Advance Mark 7™ 0-10V, OSRAM SYLVANIA Quicktronic Helios or equivalent ballasts.

For answers to technical questions, call Leviton's Techline at 1-800-824-3005





# TRIMATRON™ LIGHTING CONTROLS • 600 WATTS • 120V AC 60Hz

## Residential Grade Lighting Controls

### Trimatron™ Deluxe Full Range Rotary Dimmers and Fan Speed Controls

#### Trimatron Incandescent Rotary Dimmers 600 Watts 120V AC 60Hz Only

DESCRIPTION	CAT. NO.	RATING	COLOR*
Trimatron Deluxe Push-ON/Push-OFF Single-Pole	<b>6681</b>	600W	I, W, A
Trimatron Deluxe Push-ON/Push-OFF 3-Way	<b>6683</b>	600W	I, W, A
Trimatron Single-Pole Deluxe Rotary	<b>6602</b>	600W	I, W
Trimatron Single-Pole Deluxe Rotary★ (Not UL Listed or CSA Certified)	<b>6602-220</b>	600W-220V 50Hz AC	W
Decora Plastic Adapter for Rotary Dimmers — Plastic, Standard size; fits over .406" dimmer shaft	<b>80400</b>	—	I, W, A, E, B
Dimmer Knobs with metal insert (packed 25 per box)	<b>26115</b>	—	I, W, A, T, E, B

Note: All dimmers have a ground wire.

All devices are UL Listed and CSA Certified except where indicated by★

#### Trimatron Fan Speed Controls 120V AC 60Hz Only

DESCRIPTION	CAT. NO.	RATING	COLOR*
Trimatron Full-Range Fan Speed Control	<b>6616-X</b>	5 Amps	I, W
Trimatron Quiet Fan Speed Control	<b>6639</b>	1.5 Amps	I, W

See Page C8 for more information on Leviton Power Extenders

Use Leviton Power Extenders to extend the load capacity of box-mounted dimmers. Leviton Power Extenders are available for incandescent, magnetic low-voltage, electronic low-voltage, Advance Mark 10™ Powerline fluorescent dimming ballasts or equivalents, and 0-10 VDC dimmable fluorescent ballasts such as Advance Mark 7™ 0-10V, OSRAM Sylvania Quicktronic Helios or equivalent ballasts.

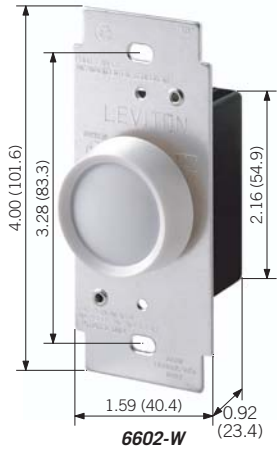

6602-W

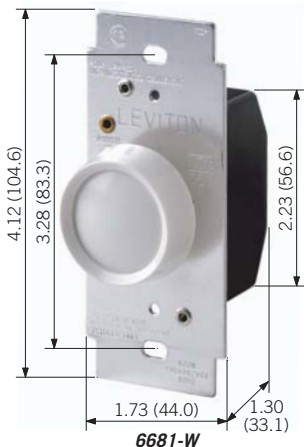

6681-W

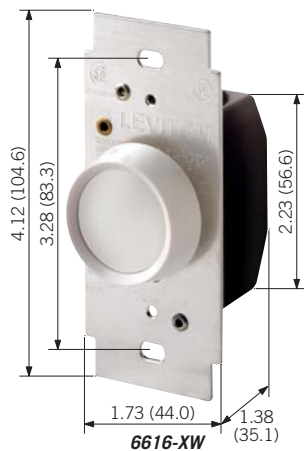

6616-XW

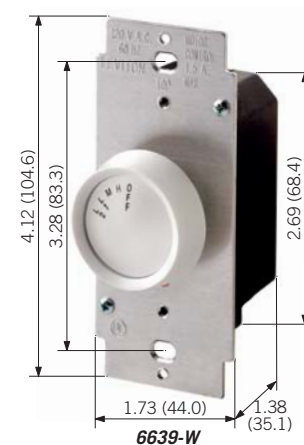

6639-W

#### SPECIFICATIONS AND FEATURES

- Leviton Trimatron lighting controls are traditional rotary-style dimmers featuring an ultra-compact design that fits in even the tightest single-gang wallboxes and is suitable for multi-gang installations
- Built-in radio/TV interference filter
- Quiet 1.5 Amp Trimatron Fan Speed Controls are ideal for libraries, study rooms and any area where ceiling fan noise could become distracting. Full range 5-amp fan speed controls also available
- Wire leads provided for fast, easy assembly and wiring

#### TESTING AND CODE COMPLIANCE

- UL Listed (File #E-31373)
- CSA Certified (File #LR-3413)
- Backed by a Limited Five-Year Warranty

#### \*COLOR

Add suffix to catalog numbers as follows to select colors: Ivory (-I), White (-W), Almond (-A), Light Almond (-T) and Black (-E). Cat. Nos. 80400 and 26115 also available in Brown (no suffix).

#### MATERIAL CHARACTERISTICS

Environmental: Flammability UL-94, V2 Rating  
Operating Temperature: 32°F to 130°F





Residential Grade Lighting Controls

Incandescent Lighting Controls

Toggle Dimmers 600 Watts 120V AC 60Hz Only  

DESCRIPTION	CAT. NO.	COLOR* (Basic Cat. No. Denotes Brown)
Single Pole Toggle Dimmer	6641	I, W,
3-Way Toggle Dimmer	6643	I, W
Single Pole Illuminated Toggle Dimmer	6691	Clear
3-Way Illuminated Toggle Dimmer	6693	Clear

Decora® 911 Flasher 500 Watts 120V AC 60Hz Only  

DESCRIPTION	CAT. NO.	COLOR*
Decora 3-Position Emergency Flasher Rocker Switch	911	I, W, A

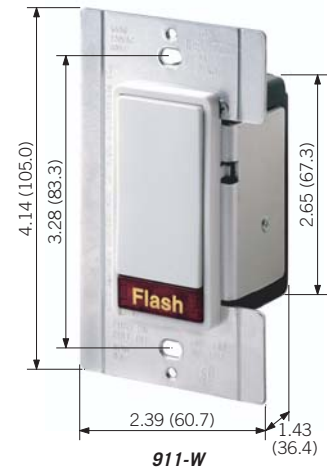
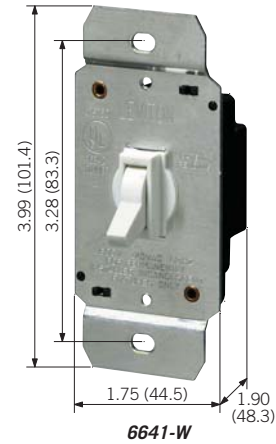

SPECIFICATIONS AND FEATURES

Toggle Dimmers

- Easy-to-install shallow design replaces standard switch in single wallbox
- Built-in radio/TV interference filter
- Positive ON/OFF action with smooth, full-range brightness control

911 Switch

- 911 replaces standard single-pole switch and alerts neighbors and helps emergency personnel locate a house quickly
- 911 Switch has standard ON/OFF operation plus a special illuminated "FLASH" position that causes controlled lighting to flash ON and OFF at one second intervals

TESTING AND CODE COMPLIANCE

- UL Listed (File #E-31373)
- CSA Certified (File #LR-3413)
- Backed by a Limited Five-Year Warranty

\*COLOR

Basic Cat. No. denotes Brown where indicated. Add suffix to catalog number as follows for other colors: Ivory (-I), White (-W), and Almond (-A).

MATERIAL CHARACTERISTICS

Environmental: Flammability UL-94, V2 Rating  
Operating Temperature: 32°F to 130°F



Residential Grade Lighting Controls

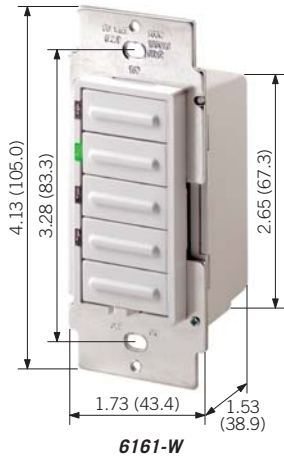

6161-W



6151

Specialty Dimmers and Sockets

Incandescent Dimmers 120V AC 60Hz Only

DESCRIPTION	CAT. NO.	RATING	COLOR*
Decora 4-Level Step Dimmer	6161	500W	W, I, A
HI-LO Feed-through Lamp-Cord Dimmer	1420	200W	W, I (Basic Cat. No. Denotes Brown)
Full-Range Feed-through Lamp-Cord Dimmer (Individually boxed)★	6250-3	200W	W (Basic Cat. No. Denotes Brown)
Tabletop Dimmer for plug-in lamps	TB103	300W	W

Dimmer Socket 120V AC 60Hz Only

DESCRIPTION	CAT. NO.	RATING	COLOR*
Full-Range Compact Dimmer Socket (1/8 I.P.S Thread and Set Screw)	6151	150W	(Non-color item)
Full-Range Compact Dimmer Socket (1/8 I.P.S Thread and Set Screw)—Blister Pak Carded	6151-BP	150W	(Non-color item)

All devices are UL Listed and CSA Certified except where indicated by★

SPECIFICATIONS AND FEATURES

Four-Level Step Dimmer

- Eliminates guesswork — user selects one of four preset lighting levels (25%, 50%, 75%, 100%)
- Easily installs in place of single-pole switch
- LED indicates selected level of brightness
- Sleek designer styling; can be ganged with other Decora devices

Lamp Cord and Socket Dimmers

- Compact Dimmer Socket interchangeable with standard lampholder for dimmer conversion (eliminates need for expensive 3-way bulbs)
- Full-Range Feed-Through Lamp Cord Dimmer provides full-range dimming with positive ON/OFF action in a completely insulated plastic housing

TESTING AND CODE COMPLIANCE

- UL Listed (File #E-3810) – 6151; (File #E-7458) – 1420; (File #E-7442) – 6250-3
- CSA Certified (File #LR-1863) – 6151; (File #LR-3413) – 1420
- Backed by a Limited Five-Year Warranty

\*COLOR

Basic Cat. No. denotes Brown where indicated. Add suffix to catalog number as follows for other colors: Ivory (-I), White (-W).

MATERIAL CHARACTERISTICS

Environmental: Flammability UL-94, V2 Rating  
Operating Temperature: 32°F to 130°F



## Free Manuals Download Website

<http://myh66.com>

<http://usermanuals.us>

<http://www.somanuals.com>

<http://www.4manuals.cc>

<http://www.manual-lib.com>

<http://www.404manual.com>

<http://www.luxmanual.com>

<http://aubethermostatmanual.com>

Golf course search by state

<http://golfingnear.com>

Email search by domain

<http://emailbydomain.com>

Auto manuals search

<http://auto.somanuals.com>

TV manuals search

<http://tv.somanuals.com>