

AP-5131 Access Point

Product Reference Guide

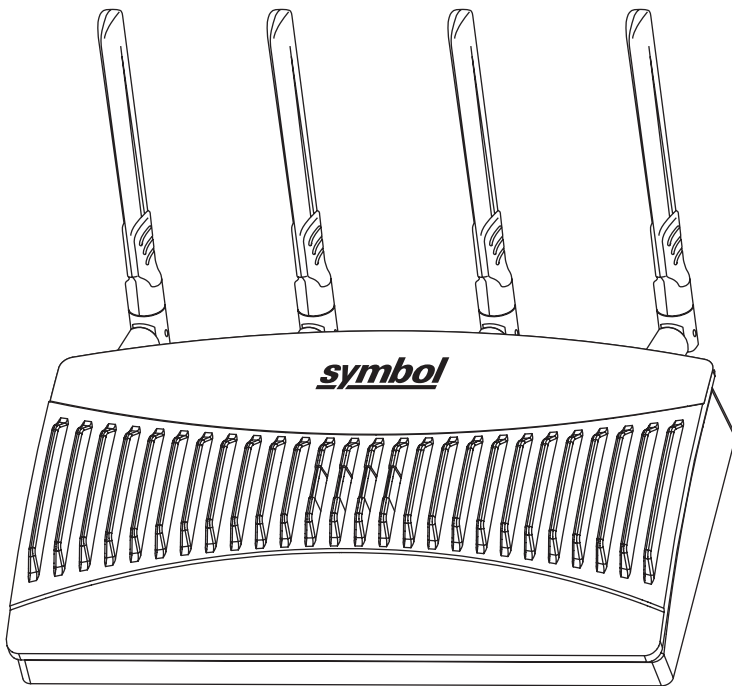

symbol[®]
The Enterprise Mobility Company™

AP-5131 Access Point Product Reference Guide

72E-94168-01

Revision A

November 2006

© 2006 by Symbol Technologies, Inc. All rights reserved.

No part of this publication may be reproduced or used in any form, or by any electrical or mechanical means, without permission in writing from Symbol. This includes electronic or mechanical means, such as photocopying, recording, or information storage and retrieval systems. The material in this manual is subject to change without notice.

The software is provided strictly on an "as is" basis. All software, including firmware, furnished to the user is on a licensed basis. Symbol grants to the user a non-transferable and non-exclusive license to use each software or firmware program delivered hereunder (licensed program). Except as noted below, such license may not be assigned, sublicensed, or otherwise transferred by the user without prior written consent of Symbol. No right to copy a licensed program in whole or in part is granted, except as permitted under copyright law. The user shall not modify, merge, or incorporate any form or portion of a licensed program with other program material, create a derivative work from a licensed program, or use a licensed program in a network without written permission from Symbol. The user agrees to maintain Symbol's copyright notice on the licensed programs delivered hereunder, and to include the same on any authorized copies it makes, in whole or in part. The user agrees not to decompile, disassemble, decode, or reverse engineer any licensed program delivered to the user or any portion thereof.

Symbol reserves the right to make changes to any software or product to improve reliability, function, or design.

Symbol does not assume any product liability arising out of, or in connection with, the application or use of any product, circuit, or application described herein.

No license is granted, either expressly or by implication, estoppel, or otherwise under any Symbol Technologies, Inc., intellectual property rights. An implied license only exists for equipment, circuits, and subsystems contained in Symbol products.

Symbol, Spectrum One, and Spectrum24 are registered trademarks of Symbol Technologies, Inc. Other product names mentioned in this manual may be trademarks or registered trademarks of their respective companies and are hereby acknowledged.

Symbol Technologies, Inc.
One Symbol Plaza
Holtsville, New York 11742-1300
<http://www.symbol.com>

Contents

About This Guide

Introduction	vii
Document Conventions	vii
Notational Conventions	viii
Service Information	viii

Chapter 1. AP-5131 Introduction

New AP-5131 Features	1-2
Mesh Networking	1-2
Additional LAN Subnet	1-3
On-board Radius Server Authentication	1-4
Hotspot Support	1-4
Routing Information Protocol (RIP)	1-5
Manual Date and Time Settings	1-5
Feature Overview	1-6

Single or Dual Mode Radio Options	1-6
Separate LAN and WAN Ports	1-7
Multiple Mounting Options	1-7
Antenna Support for 2.4 GHz and 5.2 GHz Radios	1-7
Sixteen Configurable WLANs	1-8
Support for 4 BSSIDs per Radio	1-8
Quality of Service (QoS) Support	1-9
Industry Leading Data Security	1-9
Kerberos Authentication	1-10
EAP Authentication	1-10
WEP Encryption	1-11
KeyGuard Encryption	1-12
Wi-Fi Protected Access (WPA) Using TKIP Encryption	1-12
WPA2-CCMP (802.11i) Encryption	1-12
Firewall Security	1-13
VPN Tunnels	1-13
Content Filtering	1-13
VLAN Support	1-13
Multiple Management Accessibility Options	1-14
Updatable Firmware	1-14
Programmable SNMP v1/v2/v3 Trap Support	1-14
Power-over-Ethernet Support	1-15
MU-MU Transmission Disallow	1-15
Voice Prioritization	1-16
Support for CAM and PSP MUs	1-16
Statistical Displays	1-16
Transmit Power Control	1-17
Advanced Event Logging Capability	1-17
Configuration File Import/Export Functionality	1-17
Default Configuration Restoration	1-17
DHCP Support	1-18
Multi-Function LEDs	1-18
Theory of Operations	1-18
Cellular Coverage	1-19
MAC Layer Bridging	1-20
Media Types	1-21
Direct-Sequence Spread Spectrum	1-21

MU Association Process	1-22
Operating Modes	1-23
Management Access Options	1-23

Chapter 2. Hardware Installation

Precautions	2-2
Package Contents	2-2
Available Product Configurations	2-2
Requirements	2-4
Placement of the AP-5131	2-4
Site Surveys	2-5
Antenna Options	2-5
Power Options	2-8
Symbol Power Injector System	2-8
Installing the Power Injector	2-9
Preparing for Site Installation	2-9
Cabling the Power Injector	2-9
Power Injector LED Indicators	2-10
Mounting the AP-5131	2-11
Desk Mounted Installations	2-11
Wall Mounted Installations	2-13
Suspended Ceiling T-Bar Installations	2-15
Above the Ceiling (Plenum) Installations	2-17
LED Indicators	2-20
Setting Up MUs	2-22

Chapter 3. Getting Started

Installing the AP-5131	3-1
Configuration Options	3-2
Default Configuration Changes	3-3
Initially Connecting to the Access Point	3-3
Connecting to the Access Point using the WAN Port	3-3
Connecting to the Access Point using the LAN Port	3-4
Basic Device Configuration	3-5
Configuring Device Settings	3-6
Configuring WLAN Security Settings	3-11

Testing Connectivity	3-13
Where to Go from Here?	3-14

Chapter 4. System Configuration

Configuring System Settings	4-2
Configuring Data Access	4-6
Managing Certificate Authority (CA) Certificates	4-9
Importing a CA Certificate	4-9
Creating Self Certificates for Accessing the VPN	4-10
Creating a Certificate for Onboard Radius Authentication	4-13
Configuring SNMP Settings	4-17
Configuring SNMP Access Control	4-23
Enabling SNMP Traps	4-25
Configuring Specific SNMP Traps	4-28
Configuring SNMP RF Trap Thresholds	4-30
Configuring Network Time Protocol (NTP)	4-32
Logging Configuration	4-35
Importing/Exporting Configurations	4-37
Updating Device Firmware	4-41
Upgrade/Downgrade Considerations	4-46

Chapter 5. Network Management

Configuring the LAN Interface	5-1
Configuring VLAN Support	5-4
Configuring LAN1 and LAN2 Settings	5-8
Configuring Advanced DHCP Server Settings	5-11
Setting the Type Filter Configuration	5-13
Configuring WAN Settings	5-14
Configuring Network Address Translation (NAT) Settings	5-19
Configuring Port Forwarding	5-21
Enabling Wireless LANs (WLANs)	5-22
Creating/Editing Individual WLANs	5-24
Configuring WLAN Security Policies	5-29
Configuring a WLAN Access Control List (ACL)	5-31
Setting the WLAN Quality of Service (QoS) Policy	5-34
Configuring WLAN Hotspot Support	5-40

Setting the WLAN's Radio Configuration	5-45
Configuring the 802.11a or 802.11b/g Radio	5-48
Configuring Bandwidth Management Settings	5-55
Configuring Router Settings	5-57
Setting the RIP Configuration	5-59

Chapter 6. Configuring Access Point Security

Configuring Security Options	6-2
Setting Passwords	6-3
Resetting the AP-5131 Password	6-4
Enabling Authentication and Encryption Schemes	6-5
Configuring Kerberos Authentication	6-9
Configuring 802.1x EAP Authentication	6-11
Configuring WEP Encryption	6-16
Configuring KeyGuard Encryption	6-18
Configuring WPA Using TKIP	6-20
Configuring WPA2-CCMP (802.11i)	6-22
Configuring Firewall Settings	6-25
Configuring LAN to WAN Access	6-28
Available Protocols	6-31
Configuring Advanced Subnet Access	6-32
Configuring VPN Tunnels	6-34
Configuring Manual Key Settings	6-38
Configuring Auto Key Settings	6-42
Configuring IKE Key Settings	6-44
Viewing VPN Status	6-48
Configuring Content Filtering Settings	6-50
Configuring Rogue AP Detection	6-53
Moving Rogue APs to the Allowed AP List	6-56
Displaying Rogue AP Details	6-58
Using MUs to Detect Rogue Devices	6-60
Configuring User Authentication	6-62
Configuring the Radius Server	6-62
Configuring LDAP Authentication	6-65
Configuring a Proxy Radius Server	6-67
Managing the Local User Database	6-69

Mapping Users to Groups	6-71
Defining the User Access Policy	6-72

Chapter 7. Monitoring Statistics

Viewing WAN Statistics	7-2
Viewing LAN Statistics	7-6
Viewing a LAN's STP Statistics	7-9
Viewing Wireless Statistics	7-11
Viewing WLAN Statistics	7-13
Viewing Radio Statistics Summary	7-17
Viewing Radio Statistics	7-18
Retry Histogram	7-22
Viewing MU Statistics Summary	7-23
Viewing MU Details	7-25
Pinging Individual MUs	7-27
MU Authentication Statistics	7-28
Viewing the Mesh Statistics Summary	7-29
Viewing Known Access Point Statistics	7-30

Chapter 8. Command Line Interface Reference

Connecting to the CLI	8-1
Accessing the CLI through the Serial Port	8-1
Accessing the CLI via Telnet	8-2
Admin and Common Commands	8-3
Network Commands	8-11
Network LAN Commands	8-12
Network LAN, Bridge Commands	8-16
Network LAN, WLAN-Mapping Commands	8-19
Network LAN, DHCP Commands	8-28
Network Type Filter Commands	8-34
Network WAN Commands	8-39
Network WAN NAT Commands	8-42
Network WAN, VPN Commands	8-48
Network Wireless Commands	8-57
Network WLAN Commands	8-58
Network Security Commands	8-71

Network ACL Commands	8-80
Network Radio Configuration Commands	8-85
Network Quality of Service (QoS) Commands	8-102
Network Bandwidth Management Commands	8-107
Network Rogue-AP Commands	8-110
Network Firewall Commands	8-120
Network Router Commands	8-125
System Commands	8-131
System Debug and Last Password Commands	8-135
System Access Commands	8-136
System Certificate Management Commands	8-139
System SNMP Commands	8-152
System SNMP Access Commands	8-153
System SNMP Traps Commands	8-158
System Network Time Protocol (NTP) Commands	8-164
System Log Commands	8-169
System Configuration-Update Commands	8-175
Firmware Update Commands	8-182
Statistics Commands	8-186

Chapter 9. Configuring Mesh Networking

Mesh Networking Overview	9-1
The AP-5131 Client Bridge Association Process	9-3
Spanning Tree Protocol (STP)	9-4
Defining the Mesh Topology	9-4
Mesh Networking and the AP-5131's Two Subnets	9-5
Normal Operation	9-5
Impact of Importing/Exporting Configurations to a Mesh Network	9-5
Configuring Mesh Networking Support	9-6
Setting the LAN Configuration for Mesh Networking Support	9-6
Configuring a WLAN for Mesh Networking Support	9-8
Configuring the AP-5131 Radio for Mesh Networking Support	9-12
Usage Scenario - Trion Enterprises	9-18
Trion's Initial Deployment	9-18
Adding 2 Client Bridges to Expand the Coverage Area	9-29
Adding 2 More Client Bridges to the Trion Network	9-36

Appendix A. Technical Specifications

Physical Characteristics	A-2
Electrical Characteristics	A-2
Radio Characteristics	A-3
Antenna Specifications.....	A-4
2.4 GHz Antenna Matrix.....	A-4
5.2 GHz Antenna Matrix.....	A-4
Additional Antenna Components	A-5
Antenna Accessory Connectors, Cable Type and Length.....	A-5
Country Codes.....	A-6

Appendix B. AP-5131 Usage Scenarios

Configuring Automatic Updates using a DHCP or Linux BootP Server	
Configuration	B-1
Windows - DHCP Server Configuration	B-2
Embedded Options - Using Option 43	B-2
Global Options - Using Extended/Standard Options	B-4
DHCP Priorities	B-5
Linux - BootP Server Configuration	B-6
BootP Options.....	B-7
BootP Priorities.....	B-9
Configuring an IPSEC Tunnel and VPN FAQs	B-9
Configuring a VPN Tunnel Between Two AP-5131s	B-10
Configuring a Cisco VPN Device.....	B-13
Frequently Asked VPN Questions.....	B-14
Replacing an AP-4131 with an AP-5131.....	B-19

Appendix C. Customer Support

About This Guide

Introduction

This guide provides configuration and setup information for the AP-5131 model access point.

Document Conventions

The following document conventions are used in this document:



NOTE Indicate tips or special requirements.



CAUTION Indicates conditions that can cause equipment damage or data loss.



WARNING! Indicates a condition or procedure that could result in personal injury or equipment damage.

Notational Conventions

The following notational conventions are used in this document:

- Italics are used to highlight specific items in the general text, and to identify chapters and sections in this and related documents.
- Bullets (•) indicate:
 - action items
 - lists of alternatives
 - lists of required steps that are not necessarily sequential
- Sequential lists (those describing step-by-step procedures) appear as numbered lists.

Service Information

If a problem is encountered with the AP-5131, contact the [Symbol Customer Support](#). Refer to [Appendix C](#) for contact information. Before calling, have the model number and serial number at hand.

If the problem cannot be solved over the phone, you may need to return your equipment for servicing. If that is necessary, you will be given specific instructions.

Symbol Technologies is not responsible for any damages incurred during shipment if the approved shipping container is not used. Shipping the units improperly can possibly void the warranty. If the original shipping container was not kept, contact Symbol to have another sent to you.

1

AP-5131 Introduction

The Symbol AP-5131 Access Point (AP) provides a bridge between Ethernet wired LANs or WANs and wireless networks. It provides connectivity between Ethernet wired networks and radio-equipped mobile units (MUs). MUs include the full line of Symbol terminals, bar-code scanners, adapters (PC cards, Compact Flash cards and PCI adapters) and other devices.

The AP-5131 provides a maximum 54Mbps data transfer rate via each radio. It monitors Ethernet traffic and forwards appropriate Ethernet messages to MUs over the network. It also monitors MU radio traffic and forwards MU packets to the Ethernet LAN.

The AP-5131 is available in two models:

- A single-radio version (Part No. AP-5131-4002X-WW), that can be configured as either an 802.11a access point or an 802.11b/g access point.
- A dual-radio version (Part No. AP-5131-1304X-WW), allowing both the 802.11a radio and the 802.11b/g radio to function simultaneously.

If you are new to using an access point for managing your network, refer to [Theory of Operations on page 1-18](#) for an overview on wireless networking fundamentals.

1.1 New AP-5131 Features

With this most recent 1.1 release of the AP-5131 firmware, the following new features have been introduced to the existing AP-5131 feature set:

- *Mesh Networking*
- *Additional LAN Subnet*
- *On-board Radius Server Authentication*
- *Hotspot Support*
- *Routing Information Protocol (RIP)*
- *Manual Date and Time Settings*

1.1.1 Mesh Networking

Utilize the AP-5131's new mesh networking functionality to allow the AP-5131 to function as a bridge to connect two Ethernet networks or as a repeater to extend your network's coverage area without additional cabling. The AP-5131 mesh networking functionality is configurable in two modes. It can be set in a wireless client bridge mode and/or a wireless base bridge mode (which accepts connections from client bridges). These two modes are not mutually exclusive.

In client bridge mode, the AP-5131 scans to find other access points using the selected WLAN's ESSID. The AP-5131 must go through the association and authentication process to establish a wireless connection. The mesh networking association process is identical to the AP-5131's MU association process. Once the association/authentication process is complete, the wireless client adds the connection as a port on its bridge module. This causes the AP-5131 (in client bridge mode) to begin forwarding configuration packets to the base bridge. An AP-5131 in base bridge mode allows the AP-5131 radio to accept client bridge connections.

The two bridges communicate using the *Spanning Tree Protocol* (STP). The spanning tree determines the path to the root and detects if the current connection is part of a network loop with another connection. Once the spanning tree converges, both access points begin learning which destinations reside on which side of the network. This allows them to forward traffic intelligently.

After the AP-5131 (in client bridge mode) establishes at least one wireless connection, it will begin beaconing and accepting wireless connections (if configured to support mobile users). If the AP-5131 is configured as both a client bridge and a base bridge, it begins accepting client bridge connections. In this way, the mesh network builds itself over time and distance.

Once the AP-5131 (in client bridge mode) establishes at least one wireless connection, it establishes other wireless connections in the background as they become available. In this way, the AP-5131 is able to establish simultaneous redundant links. An AP-5131 (in client bridge mode) can establish up to 3 simultaneous wireless connections with other AP-5131s. A client bridge always initiates the connections and the base bridge is always the acceptor of the mesh network data proliferating the network.

Since each AP-5131 can establish up to 3 simultaneous wireless connections, some of these connections may be redundant. In that case, the STP algorithm establishes which links are the redundant links and disables the links from forwarding.

For an overview on mesh networking as well as details on configuring the AP-5131's mesh networking functionality, see [Configuring Mesh Networking on page 9-1](#).

1.1.2 Additional LAN Subnet

In a typical retail or small office environment (wherein a wireless network is available along with a production WLAN) it is frequently necessary to segment a LAN into two subnets. Consequently, a second LAN is necessary to "segregate" wireless traffic.

The AP-5131 now has a second LAN subnet enabling administrators to segment the AP-5131's LAN connection into two separate networks. The main AP-5131 LAN screen now allows the user to select either LAN1 or LAN2 as the active LAN over the AP-5131's Ethernet port. Both LANs can still be active at any given time, but only one can transmit over the AP-5131 physical LAN connection. Each LAN has a separate configuration screen (called LAN 1 and LAN 2 by default) accessible under the main LAN screen. The user can rename each LAN as necessary. Additionally, each LAN can have its own Ethernet Type Filter configuration, and subnet access (HTTP, SSH, SNMP and telnet) configuration.

For detailed information on configuring the AP-5131 for additional LAN subnet support, see [Configuring the LAN Interface on page 5-1](#).

1.1.3 On-board Radius Server Authentication

The AP-5131 now has the ability to work as a Radius Server to provide user database information and user authentication. Several new screens have been added to the AP-5131's menu tree to configure Radius server authentication and configure the local user database and access policies. A new Radius Server screen allows an administrator to define the data source, authentication type and associate digital certificates with the authentication scheme. The LDAP screen allows the administrator to configure an external LDAP Server for use with the AP-5131. A new Access Policy screen enables the administrator to set WLAN access based on user groups defined within the User Database screen. Each user is authorized based on the access policies applicable to that user. Access policies allow an administrator to control access to a user groups based on the WLAN configurations.

For detailed information on configuring the AP-5131 for AAA Radius Server support, see [Configuring User Authentication on page 6-62](#).

1.1.4 Hotspot Support

The AP-5131 now allows hotspot operators to provide user authentication and accounting without a special client application. The AP-5131 uses a traditional Internet browser as a secure authentication device. Rather than rely on built-in 802.11 security features to control AP-5131 association privileges, you can configure a WLAN with no WEP (an open network). The AP-5131 issues an IP address to the user using a DHCP server, authenticates the user and grants the user to access the Internet.

If a tourist visits a public hotspot and wants to browse a Web page, they boot their laptop and associate with a local Wi-Fi network by entering a valid SSID. They start a browser, and the hotspot's access controller forces the un-authenticated user to a Welcome page (from the hotspot operator) that allows the user to login with a username and password. In order to send a redirected page (a login page), a TCP termination exists locally on the AP-5131. Once the login page displays, the user enters their credentials. The AP-5131 connects to the Radius server and determines the identity of the connected wireless user. Thus, allowing the user to access the Internet once successfully authenticated.

For detailed information on configuring the AP-5131 for Hotspot support, see [Configuring WLAN Hotspot Support on page 5-40](#).

1.1.5 Routing Information Protocol (RIP)

With the release of the 1.1 version AP-5131, *Routing Information Protocol*(RIP) functionality has been added to the AP-5131's existing Router screen. RIP is an interior gateway protocol that specifies how routers exchange routing-table information. The parent Router screen also allows the administrator to select the type of RIP and the type of RIP authentication used.

For detailed information on configuring RIP functionality as part of the AP-5131's Router functionality, see [Setting the RIP Configuration on page 5-59](#).

1.1.6 Manual Date and Time Settings

As an alternative to defining a NTP server to provide AP-5131 system time, the AP-513 can now have its date and time set manually. A new Manual Date/Time Setting screen can be used to set the [AP-5131](#) time using a Year-Month-Day HH:MM:SS format.

For detailed information on manually setting the AP-5131's system time, see [Configuring Network Time Protocol \(NTP\) on page 4-32](#).

1.2 Feature Overview

The Symbol AP-5131 has the following existing features carried forward from its initial 1.0 release:

- *Single or Dual Mode Radio Options*
- *Separate LAN and WAN Ports*
- *Multiple Mounting Options*
- *Antenna Support for 2.4 GHz and 5.2 GHz Radios*
- *Sixteen Configurable WLANs*
- *Support for 4 BSSIDs per Radio*
- *Quality of Service (QoS) Support*
- *Industry Leading Data Security*
- *VLAN Support*
- *Multiple Management Accessibility Options*
- *Updatable Firmware*
- *Programmable SNMP v1/v2/v3 Trap Support*
- *Power-over-Ethernet Support*
- *MU-MU Transmission Disallow*
- *Voice Prioritization*
- *Support for CAM and PSP MUs*
- *Statistical Displays*
- *Transmit Power Control*
- *Advanced Event Logging Capability*
- *Configuration File Import/Export Functionality*
- *Default Configuration Restoration*
- *DHCP Support*
- *Multi-Function LEDs*

1.2.1 Single or Dual Mode Radio Options

One or two possible configurations are available on the AP-5131 depending on which model is purchased. If the AP-5131 is manufactured as a single radio access point, the AP-5131 enables you to configure the single radio for either 802.11a or 802.11b/g.

If the AP-5131 is manufactured as a dual-radio access point, the AP-5131 enables you to configure one radio for 802.11a, and the other 802.11b/g.

For detailed information on configuring your AP-5131, see [Setting the WLAN's Radio Configuration on page 5-45](#).

1.2.2 Separate LAN and WAN Ports

The AP-5131 has one LAN port and one WAN port, each with their own MAC address. The AP-5131 must manage all data traffic over the LAN connection carefully as either a DHCP client, BOOTP client, DHCP server or using a static IP address. The AP-5131 can only use a Power-over-Ethernet device when connected to the LAN port.

For detailed information on configuring the AP-5131 LAN port, see [Configuring the LAN Interface on page 5-1](#).

A *Wide Area Network (WAN)* is a widely dispersed telecommunications network. In a corporate environment, the WAN port might connect to a larger corporate network. For a small business, the WAN port might connect to a DSL or cable modem to access the Internet. Regardless, network address information must be configured for the AP-5131's intended mode of operation.

For detailed information on configuring the AP-5131's WAN port, see [Configuring WAN Settings on page 5-14](#).

The LAN and WAN port MAC addresses can be located within the LAN and WAN Stats screens.

For detailed information on locating the AP-5131 MAC addresses, see [Viewing WAN Statistics on page 7-2](#) and [Viewing LAN Statistics on page 7-6](#).

1.2.3 Multiple Mounting Options

The AP-5131 rests on a flat surface, attaches to a wall, mounts under a ceiling or above a ceiling (attic). Choose a mounting option based on the physical environment of the coverage area. Do not mount the AP-5131 in a location that has not been approved in an AP-5131 radio coverage site survey.

For detailed information on the mounting options available for the AP-5131, see [Mounting the AP-5131 on page 2-11](#).

1.2.4 Antenna Support for 2.4 GHz and 5.2 GHz Radios

The AP-5131 supports several 802.11a and 802.11b/g radio antennas. Select the antenna best suited to the radio transmission requirements of your coverage area.

For an overview of the Radio 1 (2.4 GHz) and Radio 2 (5.2 GHz) antennas supported on the AP-5131's *Reverse SMA (RSMA)* connectors, see [Antenna Specifications on page A-4](#).

1.2.5 Sixteen Configurable WLANs

A *Wireless Local Area Network (WLAN)* is a data-communications system that flexibly extends the functionalities of a wired LAN. A WLAN does not require lining up devices for line-of-sight transmission, and are thus, desirable for wireless networking. Roaming users can be handed off from one AP-5131 to another like a cellular phone system. WLANs can therefore be configured around the needs of specific groups of users, even when they are not in physical proximity. Sixteen WLANs are configurable on each AP-5131.

To enable and configure WLANs on an AP-5131 radio, see [Enabling Wireless LANs \(WLANs\) on page 5-22](#).

1.2.6 Support for 4 BSSIDs per Radio

The AP-5131 supports four BSSIDs per radio. Each BSSID has a corresponding MAC address. The first MAC address corresponds to BSSID #1. The MAC addresses for the other three BSSIDs (BSSIDs #2, #3, #4) are derived by adding 1, 2, 3, respectively, to the radio MAC address.

If the radio MAC address displayed on the Radio Settings screen is 00:A0:F8:72:20:DC, then the BSSIDs for that radio will have the following MAC addresses:

BSSID	MAC Address	Hexadecimal Addition
BSSID #1	00:A0:F8:72:20:DC	Same as Radio MAC address
BSSID #2	00:A0:F8:72:20:DD	Radio MAC address +1
BSSID #3	00:A0:F8:72:20:DE	Radio MAC address +2
BSSID #4	00:A0:F8:72:20:DF	Radio MAC address +3

For detailed information on strategically mapping BSSIDs to WLANs, see [Configuring the 802.11a or 802.11b/g Radio on page 5-48](#).

1.2.7 Quality of Service (QoS) Support

The AP-5131 QoS implementation provides applications running on different wireless devices a variety of priority levels to transmit data to and from the AP-5131. Equal data transmission priority is fine for data traffic from applications such as Web browsers, file transfers or email, but is inadequate for multimedia applications.

Voice over Internet Protocol (VoIP), video streaming and interactive gaming are highly sensitive to latency increases and throughput reductions. These forms of higher priority data traffic can significantly benefit from the AP-5131 QoS implementation. The *WiFi Multimedia QoS Extensions (WMM)* implementation used by the AP-5131 shortens the time between transmitting higher priority data traffic and is thus desirable for multimedia applications. In addition, U-APSD (WMM Power Save) is also supported.

WMM defines four access categories—*voice*, *video*, *best effort* and *background*—to prioritize traffic for providing enhanced multimedia support.

For detailed information on configuring QoS support for the AP-5131, see [Setting the WLAN Quality of Service \(QoS\) Policy on page 5-34](#).

1.2.8 Industry Leading Data Security

The AP-5131 supports numerous encryption and authentication techniques to protect the data transmitting on the WLAN.

The following authentication techniques are supported on the AP-5131:

- [Kerberos Authentication](#)
- [EAP Authentication](#)

The following encryption techniques are supported on the AP-5131:

- [WEP Encryption](#)
- [KeyGuard Encryption](#)
- [Wi-Fi Protected Access \(WPA\) Using TKIP Encryption](#)
- [WPA2-CCMP \(802.11i\) Encryption](#)

In addition, the AP-5131 supports the following additional security features:

- [Firewall Security](#)
- [VPN Tunnels](#)

- [Content Filtering](#)

For an overview on the encryption and authentication schemes available on the AP-5131, refer to [Configuring Access Point Security on page 6-1](#).

1.2.8.1 Kerberos Authentication

Authentication is a means of verifying information that is transmitted from a secure source. If information is *authentic*, you know who created it and you know that it has not been altered in any way since it was originated. Authentication entails a network administrator employing a software “supplicant” on their computer or wireless device.

Authentication is critical for the security of any wireless LAN device. Traditional authentication methods are not suitable for use in wireless networks where an unauthorized user can monitor network traffic and intercept passwords. The use of strong authentication methods that do not disclose passwords is necessary. Symbol uses the *Kerberos* authentication service protocol (specified in RFC 1510), to authenticate users/clients in a wireless network environment and to securely distribute the encryption keys used for both encrypting and decrypting.

A basic understanding of *RFC 1510 Kerberos Network Authentication Service (V5)* is helpful in understanding how Kerberos functions. By default, WLAN devices operate in an *open system network* where any wireless device can associate with an AP without authorization. Kerberos requires device authentication before access to the wired network is permitted.

For detailed information on Kerberos configurations, see [Configuring Kerberos Authentication on page 6-9](#).

1.2.8.2 EAP Authentication

The *Extensible Authentication Protocol (EAP)* feature provides access points and their associated MU's an additional measure of security for data transmitted over the wireless network. Using EAP, authentication between devices is achieved through the exchange and verification of certificates.

EAP is a mutual authentication method whereby both the MU and AP are required to prove their identities. Like Kerberos, the user loses device authentication if the server cannot provide proof of device identification

Using EAP, a user requests connection to a WLAN through the AP-5131. The AP-5131 then requests the identity of the user and transmits that identity to an authentication server. The server prompts the AP for proof of identity (supplied to the AP-5131 by the user) and then transmits the user data back to the server to complete the authentication.

An MU is not able to access the network if not authenticated. When configured for EAP support, the access point displays the MU as an EAP station.

EAP is only supported on mobile devices running Windows XP, Windows 2000 (using Service Pack #4) and Windows Mobile 2003. Refer to the system administrator for information on configuring a Radius Server for EAP (802.1x) support.

For detailed information on EAP configurations, see [Configuring 802.1x EAP Authentication on page 6-11](#).

1.2.8.3 WEP Encryption

All WLAN devices face possible information theft. Theft occurs when an unauthorized user eavesdrops to obtain information illegally. The absence of a physical connection makes wireless links particularly vulnerable to this form of theft. Most forms of WLAN security rely on encryption to various extents. Encryption entails scrambling and coding information, typically with mathematical formulas called *algorithms*, before the information is transmitted. An algorithm is a set of instructions or formula for scrambling the data. A *key* is the specific code used by the algorithm to encrypt or decrypt the data. *Decryption* is the decoding and unscrambling of received encrypted data.

The same device, host computer or front-end processor, usually performs both encryption and decryption. The data transmit or receive direction determines whether the encryption or decryption function is performed. The device takes plain text, encrypts or scrambles the text typically by mathematically combining the key with the plain text as instructed by the algorithm, then transmits the data over the network. At the receiving end, another device takes the encrypted text and decrypts, or unscrambles, the text revealing the original message. An unauthorized user can know the algorithm, but cannot interpret the encrypted data without the appropriate key. Only the sender and receiver of the transmitted data know the key.

Wired Equivalent Privacy (WEP) is an encryption security protocol specified in the IEEE Wireless Fidelity (Wi-Fi) standard, 802.11b and supported by the AP-5131 AP. WEP encryption is designed to provide a WLAN with a level of security and privacy comparable to that of a wired LAN. The level of protection provided by WEP encryption is determined by the encryption key length and algorithm. An encryption key is a string of case sensitive characters used to encrypt and decrypt data packets transmitted between a mobile unit (MU) and the AP-5131. An AP-5131 and associated wireless clients must use the same encryption key (typically 1 through 4) to interoperate.

For detailed information on WEP configurations, see [Configuring WEP Encryption on page 6-16](#).

1.2.8.4 KeyGuard Encryption

Use KeyGuard to shield the master encryption keys from being discovered through hacking. KeyGuard negotiation takes place between the access point and MU upon association. The access point can use KeyGuard with Symbol MUs. KeyGuard is only supported on Symbol MUs making it a Symbol proprietary security mechanism.

For detailed information on KeyGuard configurations, see [Configuring KeyGuard Encryption on page 6-18](#).

1.2.8.5 Wi-Fi Protected Access (WPA) Using TKIP Encryption

Wi-Fi Protected Access (WPA) is a security standard for systems operating with a Wi-Fi wireless connection. WEP's lack of user authentication mechanisms is addressed by WPA. Compared to WEP, WPA provides superior data encryption and user authentication.

WPA addresses the weaknesses of WEP by including:

- a per-packet key mixing function
- a message integrity check
- an extended initialization vector with sequencing rules
- a re-keying mechanism

WPA uses an encryption method called *Temporal Key Integrity Protocol* (TKIP). WPA employs 802.1X and *Extensible Authentication Protocol* (EAP).

For detailed information on WPA using TKIP configurations, see [Configuring WPA Using TKIP on page 6-20](#).

1.2.8.6 WPA2-CCMP (802.11i) Encryption

WPA2 is a newer 802.11i standard that provides even stronger wireless security than Wi-Fi Protected Access (WPA) and WEP. *Counter-mode/CBC-MAC Protocol* (CCMP) is the security standard used by the *Advanced Encryption Standard* (AES). AES serves the same function TKIP does for WPA-TKIP. CCMP computes a *Message Integrity Check* (MIC) using the proven *Cipher Block Message Authentication Code* (CBC-MAC) technique. Changing just one bit in a message produces a totally different result.

WPA2-CCMP is based on the concept of a *Robust Security Network* (RSN), which defines a hierarchy of keys with a limited lifetime (similar to TKIP). Like TKIP, the keys the administrator provides are used to derive other keys. Messages are encrypted using a 128-bit secret key and a 128-bit block of data. the end result is an encryption scheme as secure as any the AP-5131 provides.

For detailed information on WPA2-CCMP configurations, see [Configuring WPA2-CCMP \(802.11i\) on page 6-22](#).

1.2.8.7 Firewall Security

A firewall keeps personal data in and hackers out. The AP-5131 firewall prevents suspicious Internet traffic from proliferating the AP-5131 managed network. The AP-5131 performs network address translation (NAT) on packets passing to and from the WAN port. This combination provides enhanced security by monitoring communication with the wired network.

For detailed information on configuring the AP-5131 firewall, see [Configuring Firewall Settings on page 6-25](#).

1.2.8.8 VPN Tunnels

Virtual Private Networks (VPNs) are IP-based networks using encryption and tunneling providing users remote access to a secure LAN. In essence, the trust relationship is extended from one LAN across the public network to another LAN, without sacrificing security. A VPN behaves like a private network; however, because the data travels through the public network, it needs several layers of security. The AP-5131 can function as a robust VPN gateway.

For detailed information on configuring VPN security support, see [Configuring VPN Tunnels on page 6-34](#).

1.2.8.9 Content Filtering

Content filtering allows system administrators to block specific commands and URL extensions from going out through the AP-5131 WAN port only. Therefore, content filtering affords system administrators selective control on the content proliferating the network and is a powerful screening tool. Content filtering allows the blocking of up to 10 files or URL extensions and allows blocking of specific outbound HTTP, SMTP, and FTP requests.

For detailed information on configuring content filtering support, see [Configuring Content Filtering Settings on page 6-50](#).

1.2.9 VLAN Support

A *Virtual Local Area Network (VLAN)* is a means to electronically separate data on the same AP-5131 from a single broadcast domain into separate broadcast domains. By using a VLAN, you can group by logical function instead of physical location. There are 16 VLANs supported on the AP-5131. An administrator can map up to 16 WLANs to 16 VLANs and enable or disable dynamic VLAN

assignment. In addition to these 16 VLANs, the AP-5131 supports dynamic, user-based, VLANs when using EAP authentication.

VLANs enable organizations to share network resources in various network segments within large areas (airports, shopping malls, etc.). A VLAN is a group of clients with a common set of requirements independent of their physical location. VLANs have the same attributes as physical LANs, but they enable administrators to group clients even when they are not members of the same network segment.

For detailed information on configuring VLAN support, see [Configuring VLAN Support on page 5-4](#).

1.2.10 Multiple Management Accessibility Options

The AP-5131 can be accessed and configured using one of the following methods:

- Java-Based Web UI
- Human readable config file (imported via FTP or TFTP)
- MIB (Management Information Base)
- *Command Line Interface (CLI)* accessed via RS-232 or Telnet. Use the AP-5131 DB-9 serial port for direct access to the command-line interface from a PC. Use Symbol's Null-Modem cable (Part No. 25-632878-0) for the best fitting connection.

1.2.11 Updatable Firmware

Symbol periodically releases updated versions of the AP-5131 device firmware to the Symbol Web site. If the AP-5131 firmware version displayed on the System Settings page (see [Configuring System Settings on page 4-2](#)) is older than the version on the Web site, Symbol recommends updating the AP-5131 to the latest firmware version for full feature functionality.

For detailed information on updating the AP-5131 firmware using FTP or TFTP, see [Updating Device Firmware on page 4-41](#).

1.2.12 Programmable SNMP v1/v2/v3 Trap Support

Simple Network Management Protocol (SNMP) facilitates the exchange of management information between network devices. SNMP uses *Management Information Bases (MIBs)* to manage the device configuration and monitor Internet devices in remote locations. MIB information accessed via SNMP is defined by a set of managed objects called *object identifiers (OIDs)*. An object identifier (OID) is used to uniquely identify each object variable of a MIB.

SNMP allows a network administrator to configure the AP-5131, manage network performance, find and solve network problems, and plan for network growth. The AP-5131 supports SNMP management functions for gathering information from its network components. The AP-5131 CDROM and the (AP-5131 downloads site) contains the following 2 MIB files:

- Symbol-CC-WS2000-MIB-2.0 (standard Symbol MIB file)
- Symbol-AP-5131-MIB (AP-5131 specific MIB file)

The AP-5131 SNMP agent functions as a command responder and is a multilingual agent responding to SNMPv1, v2c and v3 managers (command generators). The factory default configuration maintains SNMPv1/2c support of the community names, hence providing backward compatibility.

For detailed information on configuring SNMP traps, see [Configuring SNMP Settings on page 4-17](#).

1.2.13 Power-over-Ethernet Support

When users purchase a Symbol WLAN solution, they often need to place access points in obscure locations. In the past, a dedicated power source was required for each access point in addition to the Ethernet infrastructure. This often required an electrical contractor to install power drops at each access point location.

An approved power injector solution merges power and Ethernet into one cable, reducing the burden of installation and allows optimal AP-5131 placement in respect to the intended radio coverage area. The AP-5131 can only use a Power-over-Ethernet device when connected to the LAN port.

The Symbol Power Injector (Part No. AP-PSBIAS-T-1P-AF) is a single-port, 802.3af compliant Power over Ethernet hub combining low-voltage DC with Ethernet data in a single cable connecting to the AP-5131. The Power Injector's single DC and Ethernet data cable creates a modified Ethernet cabling environment on the AP-5131's LAN port eliminating the need for separate Ethernet and power cables.

For detailed information on using the Symbol Power Injector, see [Symbol Power Injector System on page 2-8](#).

1.2.14 MU-MU Transmission Disallow

The AP-5131's MU-MU Disallow feature prohibits MUs from communicating with each other even if they are on different WLANs, assuming one of the WLAN's is configured to disallow MU-MU communication. Therefore, if an MU's WLAN is configured for MU-MU disallow, it will not be able to communicate with any other MUs connected to this AP-5131.

For detailed information on configuring an AP-5131 WLAN to disallow MU to MU communications, see [Creating/Editing Individual WLANs on page 5-24](#).

1.2.15 Voice Prioritization

Each AP-5131 WLAN has the capability of having its QoS policy configured to prioritize the network traffic requirements for associated MUs. A WLAN QoS page is available for each enabled WLAN on either the AP-5131 802.11a or 802.11b/g radio.

Use the QoS page to enable voice prioritization for devices to receive the transmission priority they may not normally receive over other data traffic. Voice prioritization allows the AP-5131 to assign priority to voice traffic over data traffic, and (if necessary) assign legacy voice supported devices (non WMM supported voice devices) additional priority.

For detailed information on configuring voice prioritization over other voice enabled devices, see [Setting the WLAN Quality of Service \(QoS\) Policy on page 5-34](#).

1.2.16 Support for CAM and PSP MUs

The AP-5131 supports both CAM and PSP powered MUs. *CAM (Continuously Aware Mode)* MUs leave their radios on continuously to hear every beacon and message transmitted. These systems operate without any adjustments by the AP-5131.

A beacon is a uniframe system packet broadcast by the AP to keep the network synchronized. A beacon includes the ESSID, AP-5131 MAC address, Broadcast destination addresses, a time stamp, a *DTIM (Delivery Traffic Indication Message)* and the *TIM (Traffic Indication Map)*.

PSP (Power Save Polling) MUs power off their radios for short periods. When a Symbol MU in PSP mode associates with an AP-5131, it notifies the AP-5131 of its activity status. The AP-5131 responds by buffering packets received for the MU. PSP mode is used to extend an MU's battery life by enabling the MU to "sleep" during periods of inactivity.

1.2.17 Statistical Displays

The AP-5131 can display robust transmit and receive statistics for the WAN and LAN ports. WLAN stats can be displayed collectively and individually for enabled WLANs. Transmit and receive statistics are available for the AP-5131's 802.11a and 802.11b/g radios. An advanced radio statistics page is also available to display retry histograms for specific data packet retry information.

Associated MU stats can be displayed collectively and individually for specific MUs. An echo (ping) test is also available to ping specific MUs to assess association strength. Finally, the AP-5131 can detect and display the properties of other APs detected within the AP-5131's radio coverage area. The type of AP detected can be displayed as well as the properties of individual APs.

For detailed information on available AP-5131 statistical displays and the values they represent, see [Monitoring Statistics on page 7-1](#).

1.2.18 Transmit Power Control

The AP-5131 has a configurable power level for each radio. This enables the network administrator to define the antenna's transmission power level in respect to the AP-5131's placement or network requirements as defined in the AP-5131 site survey.

For detailed information on setting the radio transmit power level, see [Configuring the 802.11a or 802.11b/g Radio on page 5-48](#).

1.2.19 Advanced Event Logging Capability

The AP-5131 provides the capability for periodically logging system events. Logging events is useful in assessing the throughput and performance of the AP-5131 or troubleshooting problems on the AP-5131 managed Local Area Network (LAN).

For detailed information on AP-5131 events, see [Logging Configuration on page 4-35](#).

1.2.20 Configuration File Import/Export Functionality

Configuration settings for an AP-5131 can be downloaded from the current configuration of another AP-5131. This affords the administrator the opportunity to save the current configuration before making significant changes or restoring the default configuration.

For detailed information on importing or exporting configuration files, see [Importing/Exporting Configurations on page 4-37](#).

1.2.21 Default Configuration Restoration

The AP-5131 has the ability to restore its default configuration or a partial default configuration with the exception of current WAN and SNMP settings. Restoring the default configuration is a good way to create new WLANs if the MUs the AP-5131 supports have been moved to different radio coverage areas.

For detailed information on restoring a default or partial default configuration, see [Configuring System Settings on page 4-2](#).

1.2.22 DHCP Support

The AP-5131 can use *Dynamic Host Configuration Protocol (DHCP)* to obtain a leased IP address and configuration information from a remote server. DHCP is based on the BOOTP protocol and can coexist or interoperate with BOOTP. Configure the AP-5131 to send out a *DHCP request* searching for a *DHCP/BOOTP* server to acquire HTML, firmware or network configuration files when the AP-5131 boots. Because BOOTP and DHCP interoperate, whichever responds first becomes the server that allocates information.

The AP-5131 can be set to only accept replies from DHCP or BOOTP servers or both (this is the default setting). Disabling DHCP disables BOOTP and DHCP and requires network settings to be set manually. If running both DHCP and BOOTP, do not select BOOTP Only. BOOTP should only be used when the server is running BOOTP exclusively.

The DHCP client automatically sends a DHCP request at an interval specified by the DHCP server to renew the IP address lease as long as the AP-5131 is running (this parameter is programmed at the DHCP server). For example: Windows 2000 servers typically are set for 3 days.

1.2.23 Multi-Function LEDs

The AP-5131 houses seven LED indicators. Four LEDs exist on the top of the AP-5131 and are visible from wall, ceiling and table-top orientations. Three of these four LEDs are single color activity LEDs, and one is a multi-function red and white status LED. Two LEDs exist on the rear of the AP-5131 and are viewable using a single (customer installed) extended light pipe, adjusted as required to suit above the ceiling installations.

For detailed information of the AP-5131 LEDs and their functionality, see [LED Indicators on page 2-20](#).

1.3 Theory of Operations

To understand AP-5131 management and performance alternatives, users need familiarity with [AP-5131](#) functionality and configuration options. The AP-5131 includes features for different interface connections and network management.

The AP-5131 uses electromagnetic waves to transmit and receive electric signals without wires. Users communicate with the network by establishing radio links between *mobile units (MUs)* and access points.

The AP-5131 uses *DSSS (direct sequence spread spectrum)* to transmit digital data from one device to another. A radio signal begins with a carrier signal that provides the base or center frequency. The

digital data signal is encoded onto the carriers using a DSSS *chipping algorithm*. The AP-5131 radio signal propagates into the air as electromagnetic waves. A receiving antenna (on the MU) in the path of the waves absorbs the waves as electrical signals. The receiving MU interprets (demodulates) the signal by reapplying the direct sequence chipping code. This demodulation results in the original digital data.

The AP-5131 uses its environment (the air and certain objects) as the transmission medium. The [AP-5131](#) can either transmit in the 2.4 to 2.5-GHz frequency range (802.11b/g radio) or the 5.2 GHz frequency range (802.11a radio), the actual range is country-dependent. Symbol devices, like other Ethernet devices, have unique, hardware encoded *Media Access Control (MAC)* or IEEE addresses. MAC addresses determine the device sending or receiving data. A MAC address is a 48-bit number written as six hexadecimal bytes separated by colons. For example: 00:A0:F8:24:9A:C8

Also see the following sections:

- [Cellular Coverage](#)
- [MAC Layer Bridging](#)
- [Content Filtering](#)
- [DHCP Support](#)
- [Media Types](#)
- [Direct-Sequence Spread Spectrum](#)
- [MU Association Process](#)
- [Operating Modes](#)
- [Management Access Options](#)

1.3.1 Cellular Coverage

An AP-5131 establishes an average communication range with MUs called a *Basic Service Set (BSS)* or cell. When in a particular cell, the MU associates and communicates with the AP-5131 supporting the radio coverage area of that cell. Adding AP-5131's to a single LAN establishes more cells to extend the range of the network. Configuring the same *ESSID (Extended Service Set Identifier)* on all AP-5131s makes them part of the same Wireless LAN.

AP-5131s with the same ESSID defines a coverage area. A valid ESSID is an alphanumeric, case-sensitive identifier up to 32 characters. An MU searches for an AP-5131 with a matching ESSID and synchronizes (associates) to establish communications. This device association allows MUs within the coverage area to move about or *roam*. As the MU roams from cell to cell, it associates with a

different AP-5131. The roam occurs when the MU analyzes the reception quality at a location and determines a different AP-5131 provides better signal strength and lower MU load distribution.

If the MU does not find an AP-5131 with a workable signal, it can perform a scan to find any AP. As MUs switch APs, the AP updates its association statistics.

The user can configure the ESSID to correspond to up to 16 WLANs on each 802.11a or 802.11b/g radio. A *Wireless Local Area Network (WLAN)* is a data-communications system that flexibly extends the functionalities of a wired LAN. A WLAN does not require lining up devices for line-of-sight transmission, and are thus, desirable. Within the WLAN, roaming users can be handed off from one AP-5131 to another like a cellular phone system. WLANs can therefore be configured around the needs of specific groups of users, even when they are not in physical proximity.

1.3.2 MAC Layer Bridging

The AP-5131 provides *MAC layer bridging* between its interfaces. The AP-5131 monitors traffic from its interfaces and, based on frame address, forwards the frames to the proper destination. The [AP-5131](#) tracks source and destination addresses to provide intelligent bridging as MUs roam or network topologies change. The AP-5131 also handles broadcast and multicast messages and responds to MU association requests.

The AP-5131 listens to all packets on its LAN and WAN interfaces and builds an address database using MAC addresses. An address in the database includes the interface media that the device uses to associate with the AP-5131. The AP-5131 uses the database to forward packets from one interface to another. The bridge forwards packets addressed to unknown systems to the *Default Interface* (Ethernet).

The AP-5131 internal stack interface handles all messages directed to the AP-5131. Each AP-5131 stores information on destinations and their interfaces to facilitate *forwarding*. When a user sends an *ARP (Address Resolution Protocol)* request packet, the AP-5131 forwards it over all enabled interfaces except over the interface the ARP request packet was received.

On receiving the ARP response packet, the AP-5131 database keeps a record of the destination address along with the receiving interface. With this information, the AP-5131 forwards any directed packet to the correct destination. Transmitted ARP request packets echo back to other MUs. The [AP-5131](#) removes from its database the destination or interface information that is not used for a specified time. The AP refreshes its database when it transmits or receives data from these destinations and interfaces.

1.3.3 Media Types

The AP-5131 radio interface conforms to IEEE 802.11a/b/g specifications. The interface operates at a maximum 54Mbps (802.11a radio) using direct-sequence radio technology. The AP-5131 supports multiple-cell operations with fast roaming between cells. Within a direct-sequence system, each cell can operate independently. Adding cells to the network provides increased coverage area and total system capacity.

The RS-232 serial port provides a *Command Line Interface (CLI)* connection. The serial link supports a direct serial connection. The AP-5131 is a *Data Terminal Equipment (DTE)* device with male pin connectors for the RS-232 port. Connecting the AP-5131 to a PC requires a null modem serial cable.

1.3.4 Direct-Sequence Spread Spectrum

Spread spectrum (broadband) uses a narrowband signal to spread the transmission over a segment of the radio frequency band or spectrum. Direct-sequence is a spread spectrum technique where the transmitted signal is spread over a particular frequency range. The Symbol AP-5131 uses *Direct-Sequence Spread Spectrum (DSSS)* for radio communication.

Direct-sequence systems communicate by continuously transmitting a redundant pattern of bits called a *chipping sequence*. Each bit of transmitted data is mapped into chips by the AP-5131 and rearranged into a pseudorandom spreading code to form the chipping sequence. The chipping sequence is combined with a transmitted data stream to produce the AP-5131's output signal.

MUs receiving a direct-sequence transmission use the spreading code to map the chips within the chipping sequence back into bits to recreate the original data transmitted by the AP-5131. Intercepting and decoding a direct-sequence transmission requires a predefined algorithm to associate the spreading code used by the transmitting AP-5131 to the receiving MU. This algorithm is established by IEEE 802.11b specifications. The bit redundancy within the chipping sequence enables the receiving MU to recreate the original data pattern, even if bits in the chipping sequence are corrupted by interference.

The ratio of chips per bit is called the *spreading ratio*. A high spreading ratio increases the resistance of the signal to interference. A low spreading ratio increases the bandwidth available to the user. The AP-5131 uses different modulation schemes to encode more bits per chip at higher data rates. The AP-5131 is capable of a maximum 54Mbps data transmission rate (802.11a radio), but the coverage area is less than that of AP-5131 operating at lower data rates since coverage area decreases as bandwidth increases.

1.3.5 MU Association Process

An AP-5131 recognizes MUs as they begin the association process with the AP-5131. An AP-5131 keeps a list of the MUs it services. MUs associate with an AP-5131 based on the following conditions:

- Signal strength between the AP-5131 and MU
- Number of MUs currently associated with the AP-5131
- MUs encryption and authentication capabilities
- MUs supported data rate

MUs perform pre-emptive roaming by intermittently scanning for AP-5131's and associating with the best available AP-5131. Before roaming and associating, MUs perform full or partial scans to collect AP-5131 statistics and determine the direct-sequence channel used by the AP-5131.

Scanning is a periodic process where the MU sends out probe messages on all channels defined by the country code. The statistics enable an MU to reassociate by synchronizing its channel to the [AP-5131](#). The MU continues communicating with that AP-5131 until it needs to switch cells or roam.

MUs perform partial scans at programmed intervals, when missing expected beacons or after excessive transmission retries. In a partial scan, the MU scans AP-5131's classified as proximate on the AP-5131 table. For each channel, the MU tests for *Clear Channel Assessment* (CCA). The MU broadcasts a probe with the ESSID and broadcast BSS_ID when the channel is transmission-free. It sends an ACK to a directed probe response from the AP-5131 and updates the table.

An MU can roam within a coverage area by switching AP-5131s. Roaming occurs when:

- Unassociated MU attempts to associate or reassociate with an available AP-5131
- Supported rate changes or the MU finds a better transmit rate with another AP-5131
- *RSSI* (*received signal strength indicator*) of a potential AP-5131 exceeds the current [AP-5131](#)
- Ratio of good-transmitted packets to attempted-transmitted packets falls below a threshold.

An MU selects the best available AP-5131 and adjusts itself to the AP-5131 direct-sequence channel to begin association. Once associated, the AP-5131 begins forwarding frames addressed to the target MU. Each frame contains fields for the current direct-sequence channel. The MU uses these fields to resynchronize to the AP-5131.

The scanning and association process continues for active MUs. This process allows the MUs to find new AP-5131's and discard out-of-range or deactivated AP-5131's. By testing the airwaves, the MUs can choose the best network connection available.

1.3.6 Operating Modes

The AP-5131 can operate in a couple of configurations.

- **Access Point** - As an *Access Point*, the AP-5131 functions as a layer 2 bridge (similar to Symbol's existing AP-4131 access point). The wired uplink can operate as a trunk and support multiple VLANs. Up to 16 WLANs can be defined and mapped to AP-5131 WLANs. Each WLAN can be configured to be broadcast by one or both AP-5131 radios (unlike the [AP-4131](#)). The AP-5131 can operate in both an Access Point mode and Wireless Gateway/Router mode simultaneously. The network architecture and AP-5131 configuration define how the Access Point and Wireless Gateway/Router mode are negotiated.
- **Wireless Gateway/Router** - If operating as a *Wireless Gateway/Router*, the AP-5131 functions as a router between two layer 2 networks: the WAN uplink (the ethernet port) and the Wireless side. The following options are available providing a solution for single-cell deployment:
 - **PPPoE** - The WAN interface can terminate a PPPoE connection, thus enabling the [AP-5131](#) to operate in conjunction with a DSL or Cable modem to provide WAN connectivity.
 - **NAT** - (*Network Address Translation*) on the Wireless interface. Using NAT, the AP-5131 router is able to manage a private IP scheme. NAT allows translation of private addresses to the WAN IP address.
 - **DHCP** - On the Wireless side, the AP-5131 can assign private IP addresses.
 - **Firewall** - In between the WAN and Wireless interfaces, a Firewall protects against a number of known attacks.

1.3.7 Management Access Options

Managing the AP-5131 includes viewing network statistics and setting configuration options. Statistics track the network activity of associated MUs and data transfers on the AP interfaces.

The AP-5131 requires one of the following connection methods to perform a custom installation and manage the network:

- *Secure Java-Based WEB UI* - (use *Sun Microsystems' JRE 1.5* or higher available from Sun's Web site and be sure to disable Microsoft's Java Virtual Machine if installed)
- *Command Line Interface (CLI)* via Serial, Telnet and SSH
- *Config file* - Human-readable; Importable/Exportable via FTP and TFTP

- *MIB (Management Information Base)* accessing the AP-5131 SNMP function using a MIB Browser. The AP-5131 CDROM contains the following 2 MIB files:
 - Symbol-CC-WS2000-MIB-2.0 (standard Symbol MIB file)
 - Symbol-AP-5131-MIB (AP-5131 specific MIB file)

Make configuration changes to AP-5131's individually. Optionally, use the AP-5131 import/export configuration function to download AP-5131's settings to other AP-5131s.

For detailed information, see [Importing/Exporting Configurations on page 4-37](#).

Hardware Installation

An AP-5131 installation includes mounting the AP-5131 on a table-top, wall, ceiling T-bar or above the ceiling (attic or plenum), connecting the AP-5131 to the network (LAN or WAN port connection), connecting antennae and applying power. Installation procedures vary for different environments.

See the following sections for more details:

- [*Precautions*](#)
- [*Package Contents*](#)
- [*Requirements*](#)
- [*Placement of the AP-5131*](#)
- [*Power Options*](#)
- [*Symbol Power Injector System*](#)
- [*Mounting the AP-5131*](#)
- [*LED Indicators*](#)
- [*Setting Up MUs*](#)



CAUTION Symbol recommends conducting a radio site survey prior to installing the AP-5131. A site survey is an excellent method of documenting areas of radio interference and providing a tool for AP-5131 placement.

2.1 Precautions

Before installing the AP-5131 verify the following:

- Do not install in wet or dusty areas without additional protection. Contact a Symbol representative for more information.
- Verify the environment has a continuous temperature range between -20° C to 50° C.

2.2 Package Contents

Check package contents for the correct model AP-5131 and applicable AP-5131 accessories. Each available configuration (at a minimum), contains the following:

- AP-5131 (two models available)
 - Single 802.11a/g radio, external antenna (Part No. AP-5131-4002X-WW)
 - Dual 802.11a+g radios, external antenna (Part No. AP-5131-1304X-WW)
- Software and Documentation CD-ROM
- AP-5131 Install Guide (Part No. 72-70931-01)
- Accessories Bag (4 rubber feet for desk mounting and a LED light pipe, badge and label for above the ceiling installations).

2.2.1 Available Product Configurations

An AP-5131 can be ordered in the following access point and accessory combinations:

Symbol Part #	Description
AP-5131-13040-WW	AP-5131 802.11a+g Dual Radio Access Point AP-5131 Install Guide Software and Documentation CD-ROM Accessories Bag

Symbol Part #	Description
AP-5131-13041-WWR	AP-5131 802.11a+g Dual Radio Access Point AP-5131 Install Guide Power Injector (Part No. AP-PSBIAS-1P2-AFR) Software and Documentation CD-ROM Accessories Bag
AP-5131-13042-WW	AP-5131 802.11a+g Dual Radio Access Point AP-5131 Install Guide Software and Documentation CD-ROM (4) Dual-Band Antennae (Part No. ML-2452-APA2-01) Accessories Bag
AP-5131-13043-WWR	AP-5131 802.11a+g Dual Radio Access Point AP-5131 Install Guide Software and Documentation CD-ROM Power Injector (Part No. AP-PSBIAS-1P2-AFR) (4) Dual-Band Antennae (Part No. ML-2452-APA2-01) Accessories Bag
AP-5131-40020-WW	AP-5131 802.11a/g Single Radio Access Point AP-5131 Install Guide Software and Documentation CD-ROM Accessories Bag
AP-5131-40021-WWR	AP-5131 802.11a/g Single Radio Access Point AP-5131 Install Guide Software and Documentation CD-ROM Power Injector (Part No. AP-PSBIAS-1P2-AFR) Accessories Bag
AP-5131-40022-WW	AP-5131 802.11a/g Single Radio Access Point AP-5131 Install Guide Software and Documentation CD-ROM (2) Dual-Band Antennae (Part No. ML-2452-APA2-01) Accessories Bag
AP-5131-40023-WWR	AP-5131 802.11a/g Single Radio Access Point AP-5131 Install Guide Software and Documentation CD-ROM Power Injector (Part No. AP-PSBIAS-1P2-AFR) (2) Dual-Band Antennae (Part No. ML-2452-APA2-01) Accessories Bag

Verify the model indicated on the bottom of the AP-5131 is correct. Contact the Symbol Support Center to report missing or improperly functioning items.

The Symbol power injector (Part No. AP-PSBIAS-1P2-AFR) is included in certain orderable configurations, but can be added to any configuration. For more information on the Symbol power injector, see [Symbol Power Injector System on page 2-8](#).



NOTE A standard Symbol 48 Volt Power Adapter (Part No. 50-24000-050) is recommended with AP-5131 product SKUs that do not include the Symbol power injector.

For an overview on the optional antennae available for the AP-5131, see [Antenna Options on page 2-5](#). For detailed specifications on the 2.4 GHz and 5.2 GHz antenna suite, see [2.4 GHz Antenna Matrix on page A-4](#) and [5.2 GHz Antenna Matrix on page A-4](#).



CAUTION Using an antenna other than the Dual-Band Antenna (Part No. ML-2452-APA2-01) could render the AP-5131's Rogue AP Detector Mode feature inoperable. Contact your Symbol sales associate for specific information.

2.3 Requirements

The minimum installation requirements for a single-cell, peer-to-peer network:

- AP-5131 (either the dual or single radio model)
- AP-5131 48 Volt Power Supply (Part No. 50-24000-050) or Symbol power injector (Part No. AP-PSBIAS-1P2-AFR)
- a power outlet
- Dual-Band Antennae (Part No. ML-2452-APA2-01).



NOTE The AP-5131 optimally uses 2 antennae for the single-radio model and 4 antennae for the dual-radio model.

2.4 Placement of the AP-5131

For optimal performance, install the AP-5131 away from transformers, heavy-duty motors, fluorescent lights, microwave ovens, refrigerators and other industrial equipment. Signal loss can occur when

metal, concrete, walls or floors block transmission. Install the AP-5131 in open areas or add access points as needed to improve coverage.

Antenna coverage is analogous to lighting. Users might find an area lit from far away to be not bright enough. An area lit sharply might minimize coverage and create *dark areas*. Uniform antenna placement in an area (like even placement of a light bulb) provides even, efficient coverage.

Place the AP-5131 using the following guidelines:

- Install the AP-5131 at an ideal height of 10 feet from the ground.
- Orient the AP-5131 antennae vertically for best reception.
- Point the AP-5131 antenna(s) downward if attaching to the ceiling.

Symbol recommends conducting a site survey to define and document radio interference obstacles before installing the AP-5131 to maximize its radio coverage area.

2.4.1 Site Surveys

A site survey analyzes the installation environment and provides users with recommendations for equipment and placement. The optimum placement of 802.11a access points differs from 802.11b/g access points, because the locations and number of access points required are different to support the radio coverage area.

Symbol recommends conducting a new site survey and developing a new coverage area floor plan when switching from 2 or 11Mbps access points (AP-3021 or AP-4131 models) to 54Mbps access points (AP-5131 models), as the device placement requirements are significantly different.

2.4.2 Antenna Options

Both Radio 1 and Radio 2 require one antenna and can optimally use two antennae per radio (4 antennae total for dual-radio models). Two antennae per radio provides diversity that can improve performance and signal reception. Symbol supports two antenna suites for the AP-5131. One antenna

suite supporting the 2.4 GHz band and another antenna suite supporting the 5.2 GHz band. Select an antenna model best suited to the intended operational environment of your AP-5131.



NOTE On a single-radio AP-5131, Radio 1 can be configured to be either a 2.4 GHz or 5.2 GHz radio. On a dual-radio model, Radio 1 refers to the AP-5131's 2.4 GHz radio and Radio 2 refers to the AP-5131 5.2 GHz radio. However, there could be some cases where a dual-radio AP-5131 is performing a Rogue AP detector function. In this scenario, the AP-5131 is receiving in either 2.4 GHz or 5.2 GHz over the Radio 1 or Radio 2 antennae depending on which radio is selected for the scan.

Antenna connectors for Radio 1 are located in a different location from the Radio 2 antenna connectors. On single radio versions, the R-SMA connectors can support both bands and should be connected to a R-SMA dual-band antenna or an appropriate single band antenna. If necessary a R-SMA to R-BNC adapter (Part No. 25-72178-01) can be purchased separately from Symbol.

The 2.4 GHz antenna suite includes the following models:

Symbol Part Number	Antenna Type	Nominal Net Gain (dBi)
ML-2499-11PNA2-01R	Wide Angle Directional	8.5
ML-2499-HPA3-01R	Omni-Directional Antenna	3.3
ML-2499-BYGA2-01R	Yagi Antenna	13.9
ML-2452-APA2-01	Dual-Band	3.0



NOTE An additional adapter is required to use ML-2499-11PNA2-01 and ML-2499-BYGA2-01 model antennae. Please contact Symbol for more information.

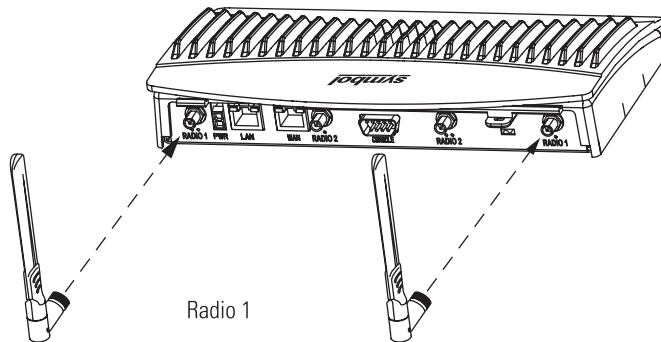

The 5.2 GHz antenna suite includes the following models:

Symbol Part Number	Antenna Type	Nominal Net Gain (dBi)
ML-5299-WPNA1-01R	Panel Antenna	13.0
ML-5299-HPA1-01R	Wide-Band Omni-Directional Antenna	5.0
ML-2452-APA2-0	Dual-Band	4.0

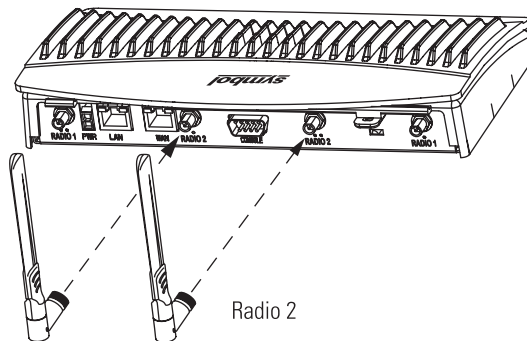

For detailed specifications on the 2.4 GHz and 5.2 GHz antennae mentioned in this section, see [section 2.4 GHz Antenna Matrix on page A-4](#) and [section 5.2 GHz Antenna Matrix on page A-4](#).

2.5 Power Options

The power options for the AP-5131 include:

- Symbol Power Injector (Part No. AP-PSBIAS-1P2-AFR)
- Symbol 48-Volt Power Supply (Part No. 50-24000-050)
- Any standard 802.3af compliant device.

2.6 Symbol Power Injector System

The AP-5131 can receive power either directly from a Symbol 48V AC-DC power supply (Part No. 50-24000-050) or via an Ethernet cable connected to the LAN port (using the 802.3af standard).

When users purchase a Symbol WLAN solution, they often need to place access points in obscure locations. In the past, a dedicated power source was required for each access point in addition to the Ethernet infrastructure. This often required an electrical contractor to install power drops at each access point location. An approved power injector solution merges power and Ethernet into one cable, reducing the burden of installation and allows optimal AP-5131 placement in respect to the intended radio coverage area.

The Symbol Power Injector is included in certain AP-5131 kits. The Symbol Power Injector (Part No. AP-PSBIAS-1P2-AFR) is an integrated AC-DC converter and 802.3af power injector which requires 110-220V AC power to combine low-voltage DC with Ethernet data in a single cable connecting to the AP-5131. The AP-5131 can only use a Power Injector when connected to the LAN port.

The Symbol AP-5131 Power Supply (Part No. 50-24000-050) is not included in the kit and is orderable separately as an accessory.



CAUTION The AP-5131 supports any standards-based 802.3af compliant power source (including non-Symbol power sources). However, using the wrong solution (including a POE system used on a legacy Symbol access point) could severely damage the AP-5131 and void the product warranty.

A separate power injector is required for each AP-5131 comprising the network.

2.6.1 Installing the Power Injector

Refer to the following sections for information on planning, installing, and validating the power injector installation:

- [Preparing for Site Installation](#)
- [Cabling the Power Injector](#)
- [Power Injector LED Indicators](#)

2.6.1.1 Preparing for Site Installation

The power injector can be installed free standing, on an even horizontal surface or wall mounted using the power injector's wall mounting key holes. The following guidelines should be adhered to before cabling the power injector to an Ethernet source and an AP-5131:

- Do not block or cover airflow to the power injector.
- Keep the power injector away from excessive heat, humidity, vibration and dust.
- The power injector is not a repeater, and does not amplify the Ethernet data signal. For optimal performance, ensure the power injector is placed as close as possible to the network data port.

2.6.1.2 Cabling the Power Injector

To install the power injector to an Ethernet data source and AP-5131:



CAUTION Ensure AC power is supplied to the power injector using an AC cable with an appropriate ground connection approved for the country of operation.

1. Connect the power injector to an AC outlet (110VAC to 220VAC).
2. Connect an RJ-45 Ethernet cable between the network data supply (host) and the power injector **Data In** connector.
3. Connect an RJ-45 Ethernet cable between the power injector **Data & Power Out** connector and the Symbol AP-5131 LAN port.



CAUTION Cabling the power injector to the AP-5131's WAN port renders the AP-5131 non-operational. Only use a AP-PSBIAS-1P2-AFR model power injector with the AP-5131's LAN port.

Ensure the cable length from the Ethernet source (host) to the power injector and AP-5131 does not exceed 100 meters (333 ft.)

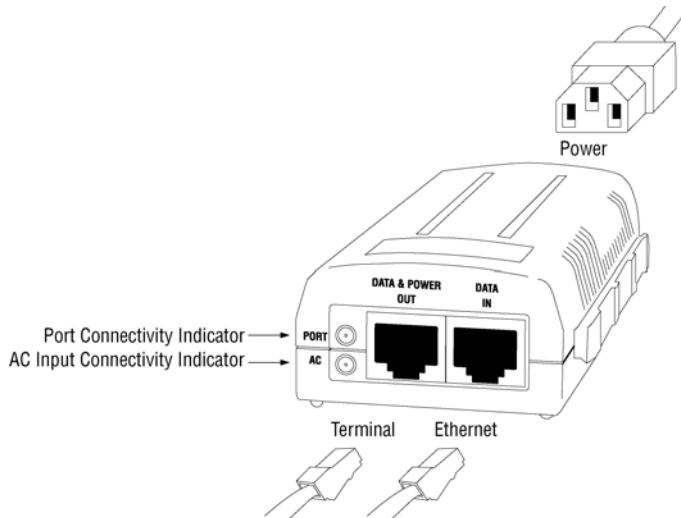

The power injector has no On/Off power switch. The power injector receives power and is ready for AP-5131 device connection and operation as soon as AC power is applied.

2.6.1.3 Power Injector LED Indicators

The power injector demonstrates the following LED behavior under normal and/or problematic operating conditions:

LED	AC (Main)	Port
Green (Steady)	Power injector is receiving power from AC outlet.	Indicates a device is connected to the power injector's outgoing Data & Power cable.
Green (Blinking)	Output voltage source is out of range.	The power injector is overloaded or has a short circuit.

For more information and device specifications for the Symbol power injector, refer to the *Power Injector Quick Install Guide* (Part No. 72-70762-01) available from the Symbol Web site or the AP-5131 Software and documentation CDROM.

2.7 Mounting the AP-5131

The AP-5131 can rest on a flat surface, attach to a wall, mount under a suspended T-Bar or above a ceiling (plenum or attic). Choose one of the following mounting options based on the physical environment of the coverage area. Do not mount the AP-5131 in a location that has not been approved in a site survey.

Refer to the following, depending on how you intend to mount the AP-5131:

- [Desk Mounted Installations](#)
- [Wall Mounted Installations](#)
- [Suspended Ceiling T-Bar Installations](#)
- [Above the Ceiling \(Plenum\) Installations](#)

2.7.1 Desk Mounted Installations

The desk mount option uses rubber feet allowing the unit to sit on most flat surfaces. The four (4) round rubber feet can be found in the AP-5131 (main) box in a separate plastic bag.

To install the AP-5131 in a desk mount orientation:

1. Turn the AP-5131 upside down.
2. Attach the radio antennae to their correct connectors.

The antenna protection plate cannot be used in a desk mount configuration, as the plate only allows antennas to be positioned in a downward orientation.



CAUTION Both the Dual and Single Radio model AP-5131's use RSMA type antenna connectors. On the Dual Radio AP-5131, a single dot on the antenna connector indicates the primary antenna for both Radio 1 (2.4 GHz) and Radio 2 (5.2 GHz). Two dots designate the secondary antenna for both Radio 1 and Radio 2. On Single Radio models, a single dot on the antenna connector indicates the primary antenna for Radio 1, and two dots designate the secondary antenna for Radio 1.

3. Remove the backings from the four (4) rubber feet and attach them to the four rubber feet recess areas on the AP-5131.

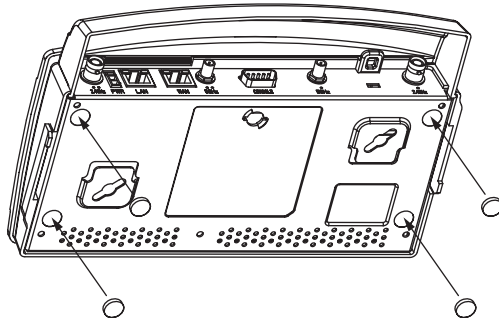

4. Cable the AP-5131 using either the Symbol power injector solution or an approved line cord and power supply.



CAUTION Do not supply power to the AP-5131 until the cabling of the unit is complete.

For Symbol power injector installations:

- a. Connect a RJ-45 Ethernet cable between the network data supply (host) and the power injector **Data In** connector.
- b. Connect a RJ-45 Ethernet cable between the power injector **Data & Power Out** connector and the Symbol AP-5131 LAN port.
- c. Ensure the cable length from the Ethernet source (host) to the power injector and AP-5131 does not exceed 100 meters (333 ft). The power injector has no On/Off power switch. The power injector receives power as soon as AC power is applied. For more information on using the power injector, see [Symbol Power Injector System on page 2-8](#).

For standard Symbol 48-Volt power adapter (Part No. 50-24000-050) and line cord installations:

- a. Connect RJ-45 Ethernet cable between the network data supply (host) and the AP-5131 LAN port.
- b. Verify the power adapter is correctly rated according the country of operation.
- c. Connect the power supply line cord to the power adapter.
- d. Attach the power adapter cable into the power connector on the AP-5131.
- e. Plug the power adapter into an outlet.

5. Verify the behavior of the AP-5131 LEDs. For more information, see [LED Indicators on page 2-20](#).
6. Return the AP-5131 to an upright position and place it in the location you wish it to operate. Ensure the AP-5131 is sitting evenly on all four rubber feet.

The AP-5131 is ready to configure. For information on an AP-5131 default configuration, see [Getting Started on page 3-1](#). For specific details on AP-5131 system configurations, see [System Configuration on page 4-1](#).

2.7.2 Wall Mounted Installations

Wall mounting requires hanging the AP-5131 along its width (or length) using the pair of slots on the bottom of the unit and using the AP-5131 itself as a mounting template for the screws. The AP-5131 can be mounted onto any plaster or wood wall surface.

The mounting hardware and tools (customer provided) required to install the AP-5131 on a wall consists of:

- Two Phillips pan head self-tapping screws (ANSI Standard) #6-18 X 0.875in. Type A or AB Self-Tapping screw, or (ANSI Standard Metric) M3.5 X 0.6 X 20mm Type D Self-Tapping screw
- Two wall anchors
- Security cable (optional)

To mount the AP-5131 on a wall:

1. Orient the AP-5131 on the wall by its width or length.
2. Using the arrows on one edge of the case as guides, move the edge to the midline of the mounting area and mark points on the midline for the screws.
3. At each point, drill a hole in the wall, insert an anchor, screw into the anchor the wall mounting screw and stop when there is 1mm between the screw head and the wall.

If pre-drilling a hole, the recommended hole size is 2.8mm (0.11in.) if the screws are going directly into the wall and 6mm (0.23in.) if wall anchors are being used.

4. If required, install and attach a security cable to the AP-5131 lock port.
5. Place the large corner of each of the mount slots over the screw heads.
6. Slide the AP-5131 down along the mounting surface to hang the mount slots on the screw heads.
7. Attach the radio antennae to their correct connectors.



CAUTION Both the Dual and Single Radio model AP-5131s use RSMA type antenna connectors. On the Dual Radio AP-5131, a single dot on the antenna connector indicates the primary antenna for both Radio 1 (2.4 GHz) and Radio 2 (5.2 GHz). Two dots designate the secondary antenna for both Radio 1 and Radio 2. On Single Radio models, a single dot on the antenna connector indicates the primary antenna for Radio 1, and two dots designate the secondary antenna for Radio 1.

8. Cable the AP-5131 using either the Symbol power injector solution or an approved line cord and power supply.



NOTE The AP-5131 must be mounted with the RJ45 cable connector oriented upwards to ensure proper operation.



CAUTION Do not supply power to the AP-5131 until the cabling of the unit is complete.

For Symbol power injector installations:

- a. Connect a RJ-45 Ethernet cable between the network data supply (host) and the Power Injector **Data In** connector.
- b. Connect a RJ-45 Ethernet cable between the power injector **Data & Power Out** connector and the AP-5131 LAN port.
- c. Ensure the cable length from the Ethernet source (host) to the power injector and AP-5131 does not exceed 100 meters (333 ft). The power injector has no On/Off power switch. The power injector receives power as soon as AC power is applied. For more information on using the power injector, see [Symbol Power Injector System on page 2-8](#).

For standard Symbol 48-Volt Power Adapter (Part No. 50-24000-050) and line cord installations:

- a. Connect RJ-45 Ethernet cable between the network data supply (host) and the AP-5131 LAN port.
- b. Verify the power adapter is correctly rated according the country of operation.
- c. Connect the power supply line cord to the power adapter.
- d. Attach the power adapter cable into the power connector on the AP-5131.

- e. Plug the power adapter into an outlet.



NOTE If the AP-5131 is utilizing remote management antennae, a wire cover can be used to provide a clean finished look to the installation. Contact Symbol for more information.

9. Verify the behavior of the AP-5131 LEDs. For more information, see [LED Indicators on page 2-20](#).

The AP-5131 is ready to configure. For information on an AP-5131 default configuration, see [Getting Started on page 3-1](#). For specific details on AP-5131 system configurations, see [System Configuration on page 4-1](#).

2.7.3 Suspended Ceiling T-Bar Installations

A suspended ceiling mount requires holding the AP-5131 up against the T-bar of a suspended ceiling grid and twisting the AP-5131 chassis onto the T-bar.

The mounting hardware and tools (customer provided) required to install the AP-5131 on a ceiling T-bar consists of:

- Safety wire (recommended)
- Security cable (optional)

To install the AP-5131 on a ceiling T-bar:

1. If required, loop a safety wire —with a diameter of at least 1.01 mm (.04 in.), but no more than 0.158 mm (.0625 in.) —through the tie post (above the AP-5131's console connector) and secure the loop.
2. If required, install and attach a security cable to the AP-5131 lock port.
3. Attach the radio antennae to their correct connectors.



CAUTION Both the Dual and Single Radio model AP-5131s use RSMA type antenna connectors. On the Dual Radio AP-5131, a single dot on the antenna connector indicates the primary antenna for both Radio 1 (2.4 GHz) and Radio 2 (5.2 GHz). Two dots designate the secondary antenna for both Radio 1 and Radio 2. On Single Radio models, a single dot on the antenna connector indicates the primary antenna for Radio 1, and two dots designate the secondary antenna for Radio 1

4. Cable the AP-5131 using either the Symbol power injector solution or an approved line cord and power supply.



CAUTION Do not supply power to the AP-5131 until the cabling of the unit is complete.

For Symbol power injector installations:

- a. Connect a RJ-45 Ethernet cable between the network data supply (host) and the Power Injector **Data In** connector.
- b. Connect a RJ-45 Ethernet cable between the power injector **Data & Power Out** connector and the AP-5131 LAN port.
- c. Ensure the cable length from the Ethernet source (host) to the power injector and AP-5131 does not exceed 100 meters (333 ft). The power injector has no On/Off power switch. The power injector receives power as soon as AC power is applied. For more information on using the power injector, see [Symbol Power Injector System on page 2-8](#).

For standard Symbol 48-Volt Power Adapter (Part No. 50-24000-050) and line cord installations:

- a. Connect RJ-45 Ethernet cable between the network data supply (host) and the AP-5131 LAN port.
 - b. Verify the power adapter is correctly rated according the country of operation.
 - c. Connect the power supply line cord to the power adapter.
 - d. Attach the power adapter cable into the power connector on the AP-5131.
 - e. Plug the power adapter into an outlet.
5. Verify the behavior of the AP-5131 LEDs. For more information, see [LED Indicators on page 2-20](#).
 6. Align the bottom of the ceiling T-bar with the back of the AP-5131.
 7. Orient the AP-5131 chassis by its length and the length of the ceiling T-bar.
 8. Rotate the AP-5131 chassis 45 degrees clockwise, or about 10 o'clock.
 9. Push the back of the AP-5131 chassis on to the bottom of the ceiling T-bar.



CAUTION Ensure the safety wire and cabling used in the T-Bar AP-5131 installation is securely fastened to the building structure in order to provide a safe operating environment.

10. Rotate the AP-5131 chassis 45 degrees counter-clockwise. The clips click as they fasten to the T-bar.

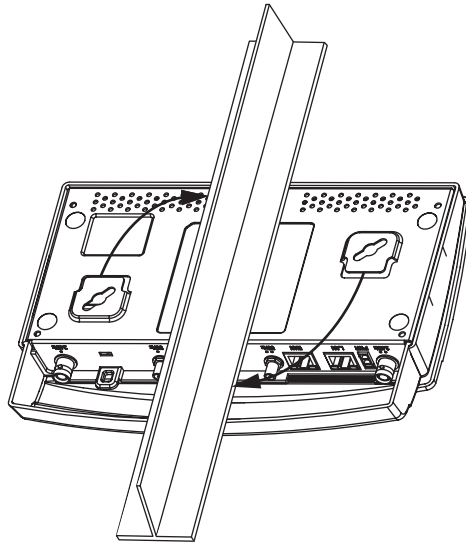

11. The AP-5131 is ready to configure. For information on an AP-5131 default configuration, see [Getting Started on page 3-1](#). For specific details on AP-5131 system configurations, see [System Configuration on page 4-1](#).



NOTE If the AP-5131 is utilizing remote management antennae, a wire cover can be used to provide a clean finished look to the installation. Contact Symbol for more information.

2.7.4 Above the Ceiling (Plenum) Installations

An AP-5131 above the ceiling installation requires placing the AP-5131 above a suspended ceiling and installing the provided light pipe under the ceiling tile for viewing the rear panel status LEDs of the unit. An above the ceiling AP-5131 installation enables installations compliant with drop ceilings, suspended ceilings and industry standard tiles from .625 to .75 inches thick.



NOTE The AP-5131 is Plenum rated to UL2043 and NEC1999 to support above the ceiling installations.



CAUTION Symbol does not recommend mounting the AP-5131 directly to any suspended ceiling tile with a thickness less than 12.7mm (0.5in.) or a suspended ceiling tile with an unsupported span greater than 660mm (26in.). Symbol strongly recommends fitting the AP-5131 with a safety wire suitable for supporting the weight of the device. The safety wire should be a standard ceiling suspension cable or equivalent steel wire between 1.59mm (.062in.) and 2.5mm (.10in.) in diameter.

The mounting hardware required to install the AP-5131 above a ceiling consists of:

- Light pipe
- Badge for light pipe
- Decal for badge
- Safety wire (strongly recommended)
- Security cable (optional)

To install the AP-5131 above a ceiling:

1. If possible, remove the adjacent ceiling tile from its frame and place it aside.
2. Install a safety wire, between 1.5mm (.06in.) and 2.5mm (.10in.) in diameter, in the ceiling space.
3. If required, install and attach a security cable to the AP-5131's lock port.
4. Mark a point on the finished side of the tile where the light pipe is to be located.
5. Create a light pipe path hole in the target position on the ceiling tile.
6. Use a drill to make a hole in the tile the approximate size of the AP-5131 LED light pipe.



CAUTION Symbol recommends care be taken not to damage the finished surface of the ceiling tile when creating the light pipe hole and installing the light pipe.

7. Remove the light pipe's rubber stopper before installing the light pipe.
8. Connect the light pipe to the bottom of the AP-5131. Align the tabs and rotate approximately 90 degrees. Do not over tighten

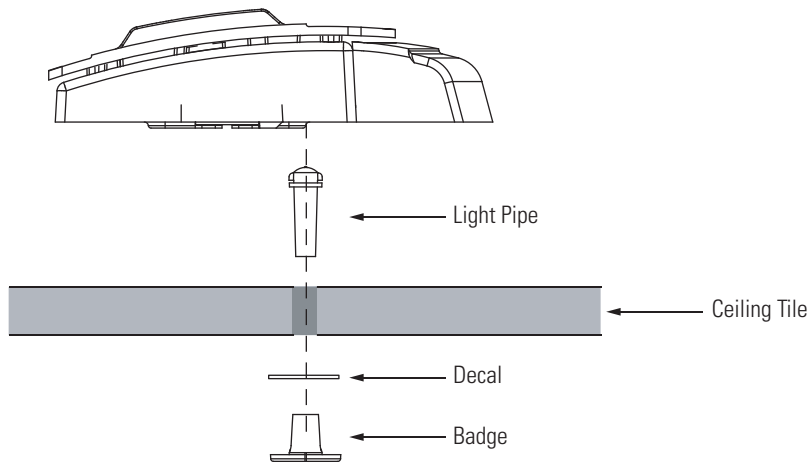

9. Snap the clips of the light pipe into the bottom of the AP-5131.
10. Fit the light pipe into hole in the tile from its unfinished side.
11. Place the decal on the back of the badge and slide the badge onto the light pipe from the finished side of the tile.
12. Attach the radio antennae to their correct connectors.



CAUTION Both the Dual and Single Radio model AP-5131s use RSMA type antenna connectors. On the Dual Radio AP-5131, a single dot on the antenna connector indicates the primary antenna for both Radio 1 (2.4 GHz) and Radio 2 (5.2 GHz). Two dots designate the secondary antenna for both Radio 1 and Radio 2. On Single Radio models, a single dot on the antenna connector indicates the primary antenna for Radio 1, and two dots designate the secondary antenna for Radio 1.

13. Attach safety wire (if used) to the AP-5131 safety wire tie point or security cable (if used) to the AP-5131's lock port.
14. Align the ceiling tile into its former ceiling space.
15. Cable the AP-5131 using either the Symbol power injector solution or an approved line cord and power supply.



CAUTION Do not supply power to the AP-5131 until the cabling of the unit is complete.

For Symbol power injector installations:

- a. Connect a RJ-45 Ethernet cable between the network data supply (host) and the Power Injector **Data In** connector.
- b. Connect a RJ-45 Ethernet cable between the power injector **Data & Power Out** connector and the AP-5131 LAN port.
- c. Ensure the cable length from the Ethernet source (host) to the power injector and AP-5131 does not exceed 100 meters (333 ft). The power injector has no On/Off power switch. The power injector receives power as soon as AC power is applied. For more information on using the power injector, see [Symbol Power Injector System on page 2-8](#).

For standard Symbol 48-Volt Power Adapter (Part No. 50-24000-050) and line cord installations:

- a. Connect RJ-45 Ethernet cable between the network data supply (host) and the AP-5131 LAN port.
 - b. Verify the power adapter is correctly rated according the country of operation.
 - c. Connect the power supply line cord to the power adapter.
 - d. Attach the power adapter cable into the power connector on the AP-5131.
 - e. Plug the power adapter into an outlet.
16. Verify the behavior of the AP-5131 LED lightpipe. For more information, see [LED Indicators on page 2-20](#).
17. Place the ceiling tile back in its frame and verify it is secure.

The AP-5131 is ready to configure. For information on an AP-5131 default configuration, see [Getting Started on page 3-1](#). For specific details on AP-5131 system configurations, see [System Configuration on page 4-1](#).

2.8 LED Indicators

The AP-5131 utilizes seven LED indicators. Five LEDs display within four LED slots on the front of the AP-5131 (on top of the AP-5131 housing) and two LEDs (for above the ceiling installations) are located on the back of the device (the side containing the LAN, WAN and antenna connectors).

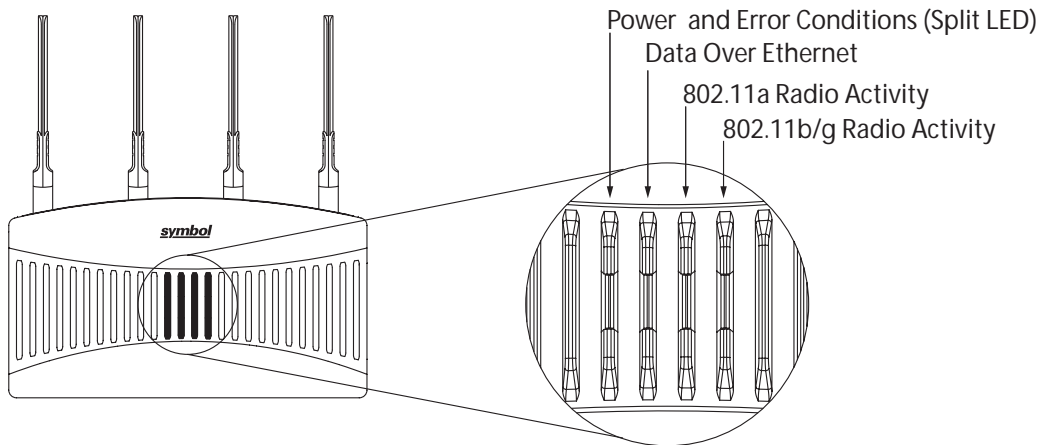

The five LEDs on the top housing of the AP-5131 are clearly visible in table-top, wall and below ceiling installations. The five AP-5131 top housing LEDs have the following display and functionality:

Power Status

Solid **white** indicates the AP-5131 is adequately powered.

Error Conditions

Solid **red** indicates the AP-5131 is experiencing a problem condition requiring immediate attention.

Ethernet Activity

Flashing **white** indicates data transfers and Ethernet activity.

802.11a Radio Activity

Flickering **amber** indicates beacons and data transfers over the AP-5131 802.11a radio.

802.11b/g Radio Activity

Flickering **green** indicates beacons and data transfers over the AP-5131 802.11b/g radio.

The LEDs on the rear of the AP-5131 are viewed using a single (customer installed) extended lightpipe, adjusted as required to suit above the ceiling installations. The LEDs displayed using the lightpipe have the following color display and functionality:

Boot and Power Status Solid **white** indicates the AP-5131 is adequately powered.

Error Conditions Solid **red** indicates the AP-5131 is experiencing a problem condition requiring immediate attention.

Power and Error Conditions Blinking **red** indicates the AP-5131 Rogue AP Detection feature has located a rogue device

2.9 Setting Up MUs

For a discussion of how to initially test the AP-5131 to ensure it can interoperate with the MUs intended for its operational environment, see [Basic Device Configuration on page 3-5](#) and specifically [Testing Connectivity on page 3-13](#).

Refer to the *LA-5030 & LA-5033 Wireless Networker PC Card and PCI Adapter Users Guide*, available from the Symbol Web site, for installing drivers and client software if operating in an 802.11a/g network environment.

Refer to the *Spectrum24 LA-4121 PC Card, LA-4123 PCI Adapter & LA-4137 Wireless Networker User Guide*, available from the Symbol Web site, for installing drivers and client software if operating in an 802.11b network environment.

Use the default values for the ESSID and other configuration parameters until the network connection is verified. MUs attach to the network and interact with the AP transparently.

3

Getting Started

The AP-5131 should be installed in an area tested for radio coverage using one of the site survey tools available to the Symbol field service technician. Once an installation site has been identified, the installer should carefully follow the hardware precautions, requirements, mounting guidelines and power options outlined in [Appendix 2, Hardware Installation on page 2-1](#).

See the following sections for more details:

- [Installing the AP-5131](#)
- [Configuration Options](#)
- [Basic Device Configuration](#)

3.1 Installing the AP-5131

Make the required cable and power connections before mounting the AP-5131 in its final operating position. Test the AP-5131 with an associated MU before mounting and securing the AP-5131. Carefully follow the mounting instructions in one of the following sections to ensure the AP-5131 is installed correctly:

- For instructions on installing the AP-5131 on a table top, see [Desk Mounted Installations on page 2-11](#).
- For instructions on AP-5131 wall mounting, see [Wall Mounted Installations on page 2-13](#).
- For instructions on mounting an AP-5131 to a ceiling T-bar, see [Suspended Ceiling T-Bar Installations on page 2-15](#).
- For instructions on installing the AP-5131 in an above the ceiling attic space, see [Above the Ceiling \(Plenum\) Installations on page 2-17](#).

For information on the 802.11a and 802.11b/g radio antenna suite available to the AP-5131, see [Antenna Options on page 2-5](#). For more information on using a Symbol Power Injector to combine Ethernet and power in one cable to the AP-5131, see [Symbol Power Injector System on page 2-8](#). To verify the behavior of the AP-5131 LEDs once installed, see [LED Indicators on page 2-20](#).

3.2 Configuration Options

Once installed and powered, the AP-5131 can be configured using one of several connection techniques. Managing the AP-5131 includes viewing network statistics and setting configuration options. The AP-5131 requires one of the following connection methods to manage the network:

- *Secure Java-Based WEB UI* - (use *Sun Microsystems' JRE 1.5* or higher available from Sun's Web site. Disable Microsoft's Java Virtual Machine if installed). For information on using the Web UI to set AP-5131 default configuration values, see [Basic Device Configuration on page 3-5](#) or chapters 4 through 7 of this guide.
- *Command Line Interface (CLI)* via Serial, Telnet and SSH. The AP-5131 CLI is accessed through the AP-5131 RS232 port, via Telnet or SSH. The CLI follows the same configuration conventions as the device user interface with a few documented exceptions. For details on using the CLI to manage the AP-5131, see [Appendix 8, Command Line Interface Reference on page 8-1](#).
- *Config file* - Readable text file; Importable/Exportable via FTP, TFTP and HTTP. Configuration settings for an AP-5131 can be downloaded from the current configuration of another AP-5131 meeting the import/export requirements. For information on importing or exporting configuration files, see [Importing/Exporting Configurations on page 4-37](#).
- *MIB (Management Information Base)* accessing the AP-5131 SNMP functions using a MIB Browser. The AP-5131 CDROM contains the following 2 MIB files:
 - Symbol-CC-WS2000-MIB-2.0 (standard Symbol MIB file)
 - Symbol-AP-5131-MIB (AP-5131 specific MIB file)

3.3 Default Configuration Changes

The following table illustrates the changes made to the AP-5131 version 1.1 configuration as compared to the 1.0 version configuration:

	Version 1.0	Version 1.1
WAN	DHCP client Auto-Update Enabled	Static IP: 10.1.1.1 Static Mask: 255.0.0.0
LAN 1	Static IP: 192.168.0.1 Static Mask: 255.255.255.0 DHCP Server Enabled	DHCP Client Auto-Update Enabled Default Gateway Ethernet Port Enabled
LAN 2	Not applicable in 1.0 release	Static IP: 192.168.1.1 Static Mask: 255.255.255.0 DHCP Server Enabled
Access via WAN port	HTTPS, SSH, SNMP: Enabled	HTTP, HTTPS, SSH, SNMP, Telnet: Enabled

3.4 Initially Connecting to the Access Point



NOTE The procedures described below assume this is the first time you are connecting to the access point.

3.4.1 Connecting to the Access Point using the WAN Port

To initially connect to the AP-5131 using the access point's WAN port:

1. Connect AC power to the AP-5131, as Power-Over-Ether support is not available on the WAN port.
2. Start a browser and enter the AP-5131's static IP WAN address (10.1.1.1). The default password is "symbol."
3. Refer to [Basic Device Configuration on page 3-5](#) for instructions on the initial (basic) configuration of the AP-5131.

3.4.2 Connecting to the Access Point using the LAN Port

To initially connect to the AP-5131 using the access point's LAN port:

1. The LAN port default is set to DHCP. Connect the AP-5131's LAN port to a DHCP server.
The AP-5131 will receive its IP address automatically.
2. To view the AP-5131's IP address, connect one end of a null modem serial cable to the AP-5131 and the other end to the serial port of a computer running HyperTerminal or similar emulation program.
3. Configure the following settings:
 - Baud Rate - 19200
 - Data Bits - 8
 - Stop Bits - 1
 - No Parity
 - No Flow Control
4. Press <ESC> or <Enter> to access the AP-5131 CLI.
5. Enter the default username of "**admin**" and the default password of "**symbol.**"
As this is the first time you are logging into the AP-5131, you are prompted to enter a new password and set the county code. Refer to [Country Codes on page A-6](#) for a list of each available countries two digit country code.
6. At the CLI prompt (admin>), type "**summary.**"
The AP-5131's LAN IP address will display.
7. Using a Web browser, use the AP-5131's IP address to access the AP-5131.
8. Refer to [Basic Device Configuration on page 3-5](#) for instructions on the initial (basic) configuration of the AP-5131.

3.5 Basic Device Configuration

For the basic setup described in this section, the Java-based Web UI will be used to configure the AP-5131. Use the AP-5131's LAN interface for establishing a link with the AP-5131. Configure the AP-5131 as a DHCP client. For optimal screen resolution, set your screen resolution to 1024 x 768 pixels or greater.

1. Log in using **admin** as the default user ID and **symbol** as the default password. Use your new password if it has been updated from default.



NOTE For optimum compatibility, use Sun Microsystems' JRE 1.5 or higher (available from Sun's Website), and be sure to disable Microsoft's Java Virtual Machine if installed.

AP-5131
ACCESS POINT

Username
admin

Password
#####

Login

symbol

2. If the default login is successful, the **Change Admin Password** window displays. Change the password.

Enter the current password and a new admin password in fields provided, and click **Apply**. Once the admin password has been updated, a warning message displays stating the AP-5131 must be set to a country.

The export function will always export the encrypted Admin User password. The import function will import the Admin Password only if the AP-5131 is set to factory default. If the AP-5131 is not configured to factory default settings, the Admin User password WILL NOT get imported.



NOTE Though the AP-5131 can have its basic settings defined using a number of different screens, Symbol recommends using the AP-5131 **Quick Setup** screen to set the correct country of operation and define its minimum required configuration from one convenient location.

3.5.1 Configuring Device Settings

Configure a set of minimum required device settings within the AP-5131 **Quick Setup** screen. The values defined within the Quick Setup screen are also configurable in numerous other locations within the AP-5131 menu tree. When you change the settings in the Quick Setup screen, the values also change within the screen where these parameters also exist. Additionally, if the values are updated in these other screens, the values initially set within the Quick Setup screen will be updated.

To define a basic AP-5131 configuration:

1. Select **System Configuration** -> **Quick Setup** from the AP-5131 menu tree, if the Quick Setup screen is not already displayed.

2. Enter a **System Name** for the AP-5131.
The System Name is useful if multiple Symbol devices are being administered.
3. Select the **Country** for the AP-5131's country of operation from the drop-down menu
The AP-5131 prompts the user for the correct country code on the first login. A warning message also displays stating that an incorrect country settings may result in illegal radio operation. Selecting the correct country is central to legally operating the AP-5131. Each country has its own regulatory restrictions concerning electromagnetic emissions and the maximum RF signal strength that can be transmitted. To ensure compliance with national and local laws, be sure to set the Country accurately. CLI and MIB users cannot configure their AP-5131 until a two character country code (for example, United States - us) is set. Refer to [Appendix A, Country Codes on page A-6](#) for the two character country codes.



NOTE The System Name and Country are also configurable within the **System Settings** screen. Refer to [Configuring System Settings on page 4-2](#) (if necessary) to set a system location and admin email address for the AP-5131 or to view other default settings.

4. Optionally enter the IP address of the server used to provide system time to the AP-5131 within the Time Server field.



NOTE DNS names are not supported as a valid IP address. The user is required to enter a numerical IP address.

Once the IP address is entered, the AP-5131's *Network Time Protocol (NTP)* functionality is engaged automatically. Refer to the AP-5131 *Product Reference Guide* for information on defining alternate time servers and setting a synchronization interval for the AP-5131 to adjust its displayed time. Refer to [Configuring Network Time Protocol \(NTP\) on page 4-32](#) (if necessary) for information on setting alternate time servers and setting a synchronization interval for the AP-5131 to adjust its displayed time.

5. Click the **WAN** tab to set a minimum set of parameters for using the WAN interface.
 - a. Select the **Enable WAN Interface** checkbox to enable a connection between the AP-5131 and a larger network or outside world through the WAN port. Disable this option to effectively isolate the AP-5131's WAN connection. No connections to a larger network or the Internet will be possible. MUs cannot communicate beyond the configured subnets.
 - b. Select the **This Interface is a DHCP Client** checkbox to enable DHCP for the AP-5131 WAN connection. This is useful, if the larger corporate network or *Internet Service Provider (ISP)* uses DHCP. DHCP is a protocol that includes mechanisms for IP address allocation and delivery of host-specific configuration parameters from a DHCP server to a host. Some of these parameters are IP address, network mask, and gateway.



NOTE Symbol recommends that the WAN and LAN ports should not both be configured as DHCP clients.

- c. Specify an **IP address** for the AP-5131's WAN connection. An IP address uses a series of four numbers expressed in dot notation, for example, 190.188.12.1 (no DNS names supported).
- d. Specify a **Subnet Mask** for the AP-5131's WAN connection. This number is available from the ISP for a DSL or cable-modem connection, or from an administrator if the AP-5131 connects to a larger network. A subnet mask uses a series of four numbers expressed in dot notation. For example, 255.255.255.0 is a valid subnet mask.

- e. Define a **Default Gateway** address for the AP-5131's WAN connection. The ISP or a network administrator provides this address.
 - f. Specify the address of a **Primary DNS Server**. The ISP or a network administrator provides this address.
6. Optionally, use the **Enable PPP over Ethernet** checkbox to enable *Point-to-Point over Ethernet (PPPoE)* for a high-speed connection that supports this protocol. Most DSL providers are currently using or deploying this protocol. PPPoE is a data-link protocol for dialup connections. PPPoE will allow the AP-5131 to use a broadband modem (DSL, cable modem, etc.) for access to high-speed data networks.
- a. Select the **Keep Alive** checkbox to enable occasional communications over the WAN port even when client communications to the WAN are idle. Some ISPs terminate inactive connections, while others do not. In either case, enabling Keep-Alive maintains the WAN connection, even when there is no traffic. If the ISP drops the connection after the idle time, the AP-5131 automatically reestablishes the connection to the ISP.
 - b. Specify a **Username** entered when connecting to the ISP. When the Internet session begins, the ISP authenticates the username.
 - c. Specify a **Password** entered when connecting to the ISP. When the Internet session starts, the ISP authenticates the password.

For additional AP-5131 WAN port configuration options, see [Configuring WAN Settings on page 5-14](#).

7. Click the **LAN** tab to set a minimum set of parameters to use the AP-5131 LAN interface.
- a. Select the **Enable LAN Interface** checkbox to forward data traffic over the AP-5131 LAN connection. The LAN connection is enabled by default.
 - b. Use the **This Interface** drop-down menu to specify how network address information is defined over the AP-5131's LAN connection. Select **DHCP Client** if the larger corporate network uses DHCP. DHCP is a protocol that includes mechanisms for IP address allocation and delivery of host-specific configuration parameters from a DHCP server to a host. Some of these parameters are IP address, network mask, and gateway. Select **DHCP Server** to use the AP-5131 as a DHCP server over the LAN connection. Select the **Bootp client** option to enable a diskless system to discover its own IP address.



NOTE Symbol recommends that the WAN and LAN ports should not both be configured as DHCP clients.

- c. If using the static or DHCP Server option, enter the network-assigned **IP Address** of the AP-5131.



NOTE DNS names are not supported as a valid IP address for the AP-5131. The user is required to enter a numerical IP address.

- d. The **Subnet Mask** defines the size of the subnet. The first two sets of numbers specify the network domain, the next set specifies the subset of hosts within a larger network. These values help divide a network into subnetworks and simplify routing and data transmission.
- e. If using the static or DHCP Server option, enter a **Default Gateway** to define the numerical IP address of a router the AP-5131 uses on the Ethernet as its default gateway.
- f. If using the static or DHCP Server option, enter the **Primary DNS Server** numerical IP address.
- g. If using the DHCP Server option, use the **Address Assignment Range** parameter to specify a range of IP address reserved for mapping clients to IP addresses. If a manually (static) mapped IP address is within the IP address range specified, that IP address could still be assigned to another client. To avoid this, ensure all statically mapped IP addresses are outside of the IP address range assigned to the DHCP server.

For additional AP-5131 LAN port configuration options, see [Configuring the LAN Interface on page 5-1](#).

8. Enable the radio(s) using the **Enable** checkbox(es) within the Radio Configuration field. If using a single radio AP-5131, enable the radio, then select either 2.4 GHz or 5.2 GHz from the **RF Band of Operation** field. Only one RF band option at a time is permissible in a single-radio AP-5131. If using a dual-radio AP-5131, the user can enable both RF bands. For additional AP-5131 radio configuration options, see [Configuring the 802.11a or 802.11b/g Radio on page 5-48](#).
9. Select the **WLAN #1** tab (WLANs 1 - 4 are available within the Quick Setup screen) to define its ESSID and security scheme for basic operation.



NOTE A maximum of 16 WLANs are configurable within the AP-5131 Wireless Configuration screen. The limitation of 16 WLANs exists regardless of whether the AP-5131 is a single or dual-radio model.

- a. Enter the *Extended Services Set Identification (ESSID)* and name associated with the WLAN. For additional information on creating and editing up to 16 WLANs per AP-5131, see [Creating/Editing Individual WLANs on page 5-24](#).
 - b. Use the **Available On** checkboxes to define whether the target WLAN is operating over the 802.11a or 802.11b/g radio. Ensure the radio selected has been enabled (see step 8).
 - c. Even an AP-5131 configured with minimal values must protect its data against theft and corruption. A security policy should be configured for WLAN1 as part of the basic configuration outlined in this guide. A security policy can be configured for the WLAN from within the **Quick Setup** screen. Policies can be defined over time and saved to be used as needed as the AP-5131's security requirements change. Symbol recommends you familiarize yourself with the security options available on the AP-5131 before defining a security policy. Refer to [Configuring WLAN Security Settings on page 3-11](#).
10. Click **Apply** to save any changes to the AP-5131 Quick Setup screen. Navigating away from the screen without clicking Apply results in all changes to the screens being lost.
 11. Click **Undo Changes** (if necessary) to undo any changes made. Undo Changes reverts the settings displayed on the AP-5131 Quick Setup screen to the last saved configuration.

3.5.1.1 Configuring WLAN Security Settings

To configure a basic security policy for a WLAN:

1. From the AP-5131 Quick Setup screen, click the **Create** button to the right of the Security Policy item.

The **New Security Policy** screen displays with the **Manually Pre-shared key/No authentication** and **No Encryption** options selected. Naming and saving such a policy (as is) would provide no security and might only make sense in a guest network wherein no sensitive data is either transmitted or received. Consequently, at a minimum, a basic security scheme (in this case WEP 128) is recommended in a network environment wherein sensitive data is transmitted.



NOTE For information on configuring the other encryption and authentication options available to the AP-5131, see [Configuring Security Options on page 6-2](#).

2. Ensure the **Name** of the security policy entered suits the intended configuration or function of the policy.

Multiple WLANs can share the same security policy, so be careful not to name security policies after specific WLANs or risk defining a WLAN to single policy. Symbol recommends naming the policy after the attributes of the authentication or encryption type selected.

3. Select the **WEP 128 (104 bit key)** checkbox.

The **WEP 128 Settings** field displays within the New Security Policy screen.

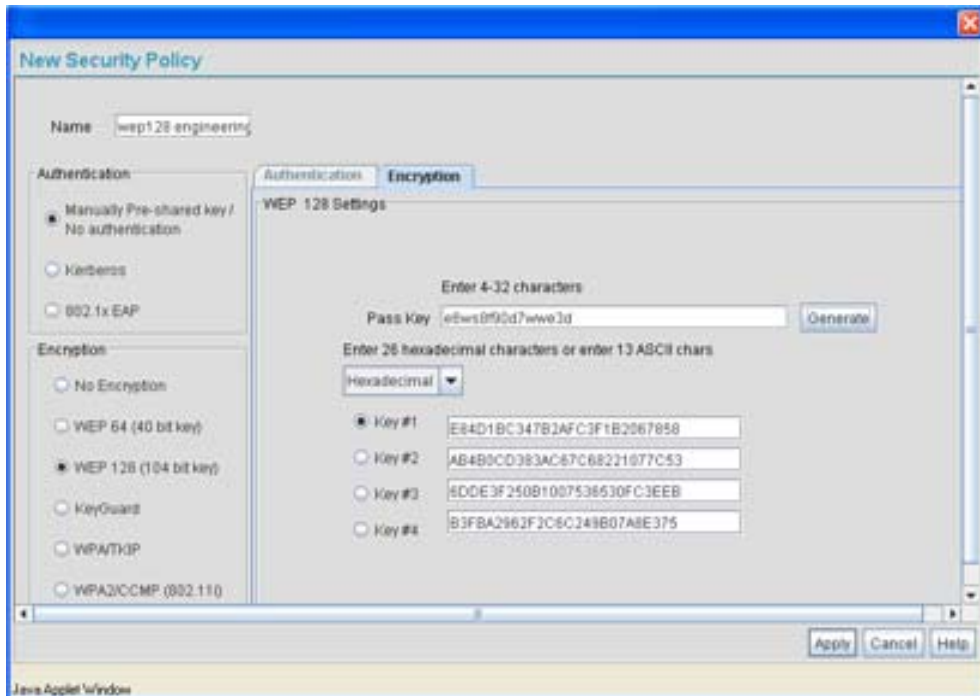

4. Configure the **WEP 128 Settings** field as required to define the Pass Key used to generate the WEP keys.

Pass Key

Specify a 4 to 32 character pass key and click the **Generate** button. The AP-5131, other proprietary routers and Symbol MUs use the same algorithm to convert an ASCII string to the same hexadecimal number. Non-Symbol clients and devices need to enter WEP keys manually as hexadecimal numbers. The AP-5131 and its target client(s) must use the same pass key to interoperate.

Keys #1-4

Use the **Key #1-4** fields to specify key numbers. The key can be either a hexadecimal or ASCII depending on which option is selected from the drop-down menu. For WEP 64 (40-bit key), the keys are 10 hexadecimal characters in length or 5 ASCII characters. For WEP 128 (104-bit key), the keys are 26 hexadecimal characters in length or 13 ASCII characters. Select one of these keys for activation by clicking its radio button. The AP-5131 and its target client(s) must use the same key to interoperate.

5. Click the **Apply** button to save the security policy and return to the AP-5131 **Quick Setup** screen.

At this point, you can test the AP-5131 for MU interoperability.

3.5.2 Testing Connectivity

Verify the AP-5131's link with an MU by sending *Wireless Network Management Protocol* (WNMP) ping packets to the associated MU. Use the Echo Test screen to specify a target MU and configure the parameters of the test. The WNMP ping test only works with Symbol MUs. Only use a Symbol MU to test AP-5131 connectivity using WNMP.



NOTE Before testing for connectivity, the target MU needs to be set to the same ESSID as the AP-5131. Since WEP 128 has been configured for the AP-5131, the MU also needs to be configured for WEP 128 and use the same WEP keys. Ensure the MU is associated with the AP-5131 before testing for connectivity.

To ping a specific MU to assess its connection with an AP-5131:

1. Select **Status and Statistics** -> **MU Stats** from the AP-5131 menu tree.
2. Select the **Echo Test** button from within the **MU Stats Summary** screen.
3. Define the following parameters for the test.

Station Address The station address is the IP address of the target MU. Refer to the MU Stats Summary screen for associated MU IP address information.

Number of pings Defines the number of packets to be transmitted to the MU. The default is 100.

Packet Length Specifies the length of each packet transmitted to the MU during the test. The default length is 100 bytes.

4. Click the **Ping** button to begin transmitting packets to the specified MU address.

Refer to the Number of Responses value to assess the number of responses from the MU versus the number of ping packets transmitted by the AP-5131. Use the ratio of packets sent versus the number of packets received the link quality between the MU and the AP-5131.

Click the **OK** button to exit the Echo Test screen and return to the MU Stats Summary screen.

3.5.3 Where to Go from Here?

Once basic connectivity has been verified, the AP-5131 can be fully configured to meet the needs of the network and the users it supports. Refer to the following:

- For detailed information on AP-5131 device access, SNMP settings, network time, importing/exporting device configurations and device firmware updates, see [Chapter 4, System Configuration on page 4-1](#).
- For detailed information on configuring AP-5131 LAN interface (subnet) and WAN interface see, [Chapter 5, Network Management on page 5-1](#).
- For detailed information on configuring specific encryption and authentication security schemes for individual AP-5131 WLANs, see [Chapter 6, Configuring Access Point Security on page 6-1](#).
- To view detailed statistics on the AP-5131 and its associated MUs, see [Chapter 7, Monitoring Statistics on page 7-1](#).

4

System Configuration

The Symbol AP-5131 contains a built-in browser interface for system configuration and remote management using a standard Web browser such as Microsoft Internet Explorer, Netscape Navigator or Mozilla Firefox. The browser interface also allows for system monitoring of the AP-5131.

Web management of the AP-5131 requires either Microsoft Internet Explorer 5.0 or later or Netscape Navigator 6.0 or later.



NOTE For optimum compatibility, use *Sun Microsystems' JRE 1.5* or higher (available from Sun's Web site), and be sure to disable Microsoft's Java Virtual Machine if installed.

To connect to the AP, the AP-5131 IP is required. If connected to the AP-5131 using the WAN port, the default static IP address is 10.1.1.1. The default password is "symbol." If connected to the AP-5131 using the LAN port, the default setting is DHCP client. The user is must know the IP address in order to access the AP-5131 using a Web browser.



NOTE DNS names are not supported as a valid IP address for the AP-5131. The user is required to enter a numerical IP address.

System configuration topics include:

- [Configuring System Settings](#)
- [Configuring Data Access](#)
- [Managing Certificate Authority \(CA\) Certificates](#)
- [Configuring SNMP Settings](#)
- [Configuring Network Time Protocol \(NTP\)](#)
- [Logging Configuration](#)
- [Importing/Exporting Configurations](#)
- [Updating Device Firmware](#)

4.1 Configuring System Settings

Use the **System Settings** screen to specify the name and location of the AP-5131, assign an email address for the network administrator, restore the AP's default configuration or restart the AP.

To configure System Settings for the AP-5131:

1. Select **System Configuration** -> **System Settings** from the AP-5131 menu tree.

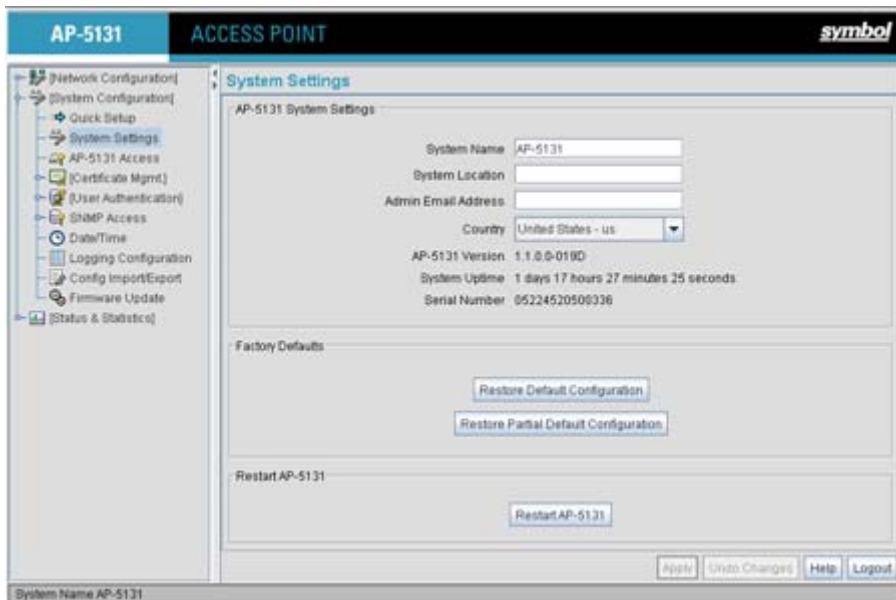

- Configure the AP-5131 **System Settings** field to assign a system name and location, set the country of operation and view device version information.

- System Name* Specify a device name for the AP-5131. Symbol recommends selecting a name serving as a reminder of the user base the AP-5131 supports (engineering, retail, etc.).
- System Location* Enter the location of the AP-5131. The **System Location** parameter acts as a reminder of where the AP can be found. Use the System Name field as a specific identifier of device location. Use the System Name and System Location fields together to optionally define the AP name by the radio coverage it supports and specific physical location. For example, "second floor engineering"
- Admin Email Address* Specify the AP administrator's email address.

<i>Country</i>	<p>The AP-5131 prompts the user for the correct country code after the first login. A warning message also displays stating that an incorrect country setting will lead to an illegal use of the AP-5131. Use the pull-down menu to select the country of operation. Selecting the correct country is extremely important. Each country has its own regulatory restrictions concerning electromagnetic emissions (channel range) and the maximum RF signal strength transmitted. To ensure compliance with national and local laws, be sure to set the Country field correctly.</p> <p>If using the AP-5131 configuration file, CLI or MIB to configure the AP-5131's country code, see Country Codes on page A-6.</p>
<i>AP-5131 Version</i>	<p>The displayed number is the current version of the AP-5131 device firmware. Use this information to determine if the AP is running the most recent firmware available from Symbol. Use the Firmware Update screen to keep the AP's firmware up to date. For more information, see Updating Device Firmware on page 4-41.</p>
<i>System Uptime</i>	<p>Displays the current uptime of the AP-5131 defined in the System Name field. <i>System Uptime</i> is the cumulative time since the AP-5131 was last rebooted or lost power.</p>
<i>Serial Number</i>	<p>Displays the AP-5131 <i>Media Access Control (MAC)</i> address. The AP-5131 MAC address is hard coded at the factory and cannot be modified. The LAN and WAN port MAC addresses can be located within the LAN and WAN Stats screens. For information on locating the AP-5131 MAC addresses, see Viewing WAN Statistics on page 7-2 and Viewing LAN Statistics on page 7-6.</p>

3. Refer to the **Factory Defaults** field to restore either a full or partial default configuration.



CAUTION Restoring the AP-5131's configuration back to default settings changes the administrative password back to "symbol." If restoring the configuration back to default settings, be sure you change the administrative password accordingly.

Restore Default Configuration

Select the **Restore Default Configuration** button to reset the AP's configuration to factory default settings. If selected, a message displays warning the user the current configuration will be lost if the default configuration is restored. Before using this feature, Symbol recommends using the **Config Import/Export** screen to export the current configuration for safekeeping, see [Importing/Exporting Configurations on page 4-37](#).

Restore Partial Default Configuration

Select the **Restore Partial Default Configuration** button to restore a default configuration with the exception of the current LAN, WAN, SNMP settings and IP address used to launch the browser. If selected, a message displays warning the user all current configuration settings will be lost with the exception of WAN and SNMP settings. Before using this feature, Symbol recommends using the **Config Import/Export** screen to export the current configuration for safekeeping, see [Importing/Exporting Configurations on page 4-37](#).

- Use the **Restart AP-5131** field to restart the AP (if necessary).

Restart AP-5131

Click the **Restart AP-5131** button to reboot the AP. Restarting the AP-5131 resets all data collection values to zero. Symbol does not recommend restarting the AP during significant system uptime or data collection activities.



CAUTION After a reboot, static route entries disappear from the AP Route Table if a LAN Interface is set to DHCP Client. The entries can be retrieved (once the reboot is done) by performing an Apply operation from the WEB UI or a save operation from the CLI.

- Click **Apply** to save any changes to the System Settings screen. Navigating away from the screen without clicking the Apply button results in all changes to the screen being lost.



NOTE The **Apply** button is not needed for restoring the AP-5131 default configuration or restarting the AP-5131.

- Click **Undo Changes** (if necessary) to undo any changes made. Undo Changes reverts the settings displayed on the System Settings screen to the last saved configuration.

- Click **Logout** to securely exit the AP-5131 Symbol Access Point applet. A prompt displays confirming the logout before the applet is closed.

4.2 Configuring Data Access

Use the AP-5131 **Access** screen to enable/disable data throughput to the AP-5131's LAN1, LAN2 and/or WAN interfaces and display screens for changing administrator passwords.

Use the AP-5131 Access screen checkboxes to enable or disable LAN1, LAN2 and/or WAN access using the protocols and ports listed. If access is disabled, this effectively locks out the administrator from configuring the AP-5131 using that interface. To avoid jeopardizing the network data managed by the AP-5131, Symbol recommends enabling only those interfaces used in the routine (daily) management of the network, and disabling all other interfaces until they are required.

To configure access for the AP-5131:

- Select **System Configuration** -> **AP-5131 Access** from the AP-5131 menu tree.

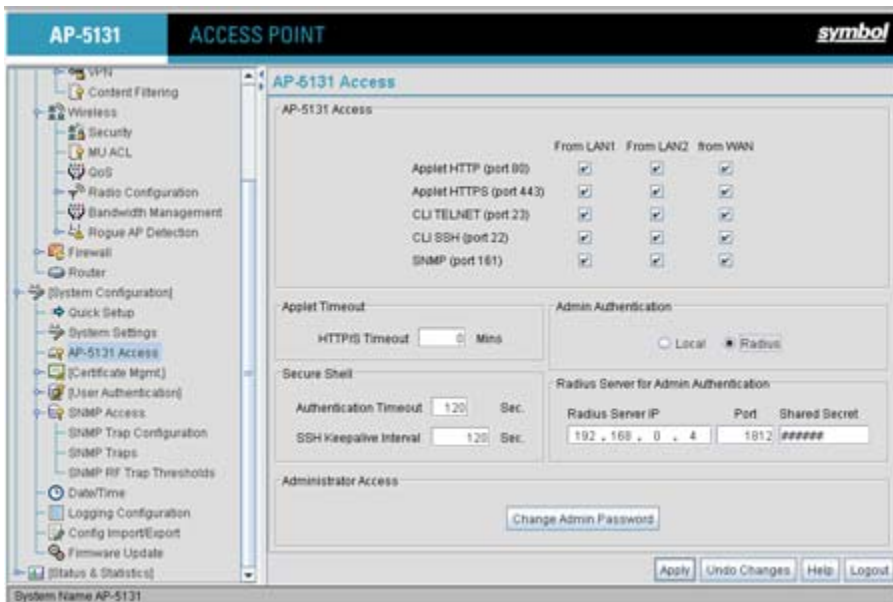

- Use the AP-5131 **Access** field checkboxes to enable/disable the following AP-5131 on the AP-5131's LAN1, LAN2 or WAN interfaces:

- Applet HTTP (port 80)* Select the LAN1, LAN2 and/or WAN checkboxes to enable access to the AP-5131 configuration applet using a Web browser.
- Applet HTTPS (port 443)* Select the LAN1, LAN2 and/or WAN checkboxes to enable access to the AP-5131 configuration applet using a *Secure Sockets Layer (SSL)* for encrypted HTTP sessions.
- CLI TELNET (port 23)* Select the LAN1, LAN2 and/or WAN checkboxes to enable access to the AP-5131 CLI via the TELNET terminal emulation TCP/IP protocol.
- CLI SSH (port 22)* Select the LAN1, LAN2 and/or WAN checkboxes to enable access to the AP-5131 CLI using the SSH (Secure Shell) protocol.
- SNMP (port 161)* Select the LAN1, LAN2 and/or WAN checkboxes to enable access to the AP-5131 configuration settings from an SNMP-capable client.
3. Refer to the **Applet Timeout** field to set an HTTPS timeout interval.
- HTTP/S Timeout* Disables access to the AP-5131 if no data activity is detected over Applet HTTPS (port 443) after the user defined interval. Default is 0 Mins.
4. Configure the **Secure Shell** field to set timeout values to reduce network inactivity.
- Authentication Timeout* Defines the maximum time (between 30 - 120 seconds) allowed for SSH authentication to occur before executing a timeout. The minimum permissible value is 30 seconds.
- SSH Keepalive Interval* The SSH Keepalive Interval defines a period (in seconds) after which if no data has been received from a client, SSH sends a message through the encrypted channel to request a response from the client. The default is 0, and no messages will be sent to the client until a non-zero value is set. Defining a Keepalive interval is important, otherwise programs running on a server may never notice if the other end of a connection is rebooted.
5. Use the **Admin Authentication** buttons to specify the authentication server connection method.
- Local* The AP-5131 verifies the authentication connection.

Radius Designates that a Radius server is used in the authentication credential verification. If using this option, the connected PC is required to have its Radius credentials verified with an external Radius server. Additionally, the Radius Server's Active Directory should have a valid user configured and have a PAP based Remote Access Policy configured for Radius Admin Authentication to work.

- Use the Radius Server if a Radius server has been selected as the authentication server, enter the required network address information.

Radius Server IP Specify the numerical (non DNS name) IP address of the *Remote Authentication Dial-In User Service* (Radius) server. Radius is a client/server protocol and software enabling remote-access servers to communicate with a server used to authenticate users and authorize access to the requested system or service.

Port Specify the port on which the server is listening. The Radius server typically listens on ports 1812 (default port).

Shared Secret Define a shared secret for authentication on the server. The shared secret is required to be the same as the shared secret defined on the Radius server. Use shared secrets to verify Radius messages (with the exception of the Access-Request message) sent by a Radius-enabled device configured with the same shared secret. Apply the qualifications of a well-chosen password to the generation of a shared secret. Generate a random, case-sensitive string using letters, numbers and symbols. The default is symbol.

- Update the **Administrator Access** field to change the administrative password used to access the AP-5131 configuration settings.

Change Admin Password Click the **Change Admin Password** button to display a screen for updating the AP administrator password. Enter and confirm a new administrator password as required.

- Click **Apply** to save any changes to the AP-5131 Access screen. Navigating away from the screen without clicking the Apply button results in all changes to the screen being lost.
- Click **Undo Changes** (if necessary) to undo any changes made. Undo Changes reverts the settings displayed on the AP-5131 Access screen to the last saved configuration.
- Click **Logout** to securely exit the AP-5131 Symbol Access Point applet. A prompt displays confirming the logout before the applet is closed.

4.3 Managing Certificate Authority (CA) Certificates

Certificate management includes the following sections:

- [Importing a CA Certificate](#)
- [Creating Self Certificates for Accessing the VPN](#)

4.3.1 Importing a CA Certificate

A *certificate authority (CA)* is a network authority that issues and manages security credentials and public keys for message encryption. The CA signs all digital certificates that it issues with its own private key. The corresponding public key is contained within the certificate and is called a CA certificate. A browser must contain this CA certificate in its *Trusted Root Library* so that it can trust certificates "signed" by the CA's private key.

Depending on the public key infrastructure, the digital certificate includes the owner's public key, the certificate expiration date, the owner's name and other public key owner information.

The AP-5131 can import and maintain a set of CA certificates to use as an authentication option for *Virtual Private Network (VPN)* access. To use the certificate for a VPN tunnel, define a tunnel and select the IKE settings to use either RSA or DES certificates. For additional information on configuring VPN tunnels, see [Configuring VPN Tunnels on page 6-34](#).



CAUTION Loaded and signed CA certificates will be lost when changing the AP-5131's firmware version using either the GUI or CLI. After a certificate has been successfully loaded, export it to a secure location to ensure its availability after a firmware update.

Refer to your AP-5131 network administrator to obtain a CA certificate to import into the AP-5131.



NOTE Verify the AP-5131 device time is synchronized with an NTP server before importing a certificate to avoid issues with conflicting date/time stamps. For more information, see [Configuring Network Time Protocol \(NTP\) on page 4-32](#).

To import a CA certificate:

1. Select **System Configuration** -> **Certificate Mgmt** -> **CA Certificates** from the AP-5131 menu tree.

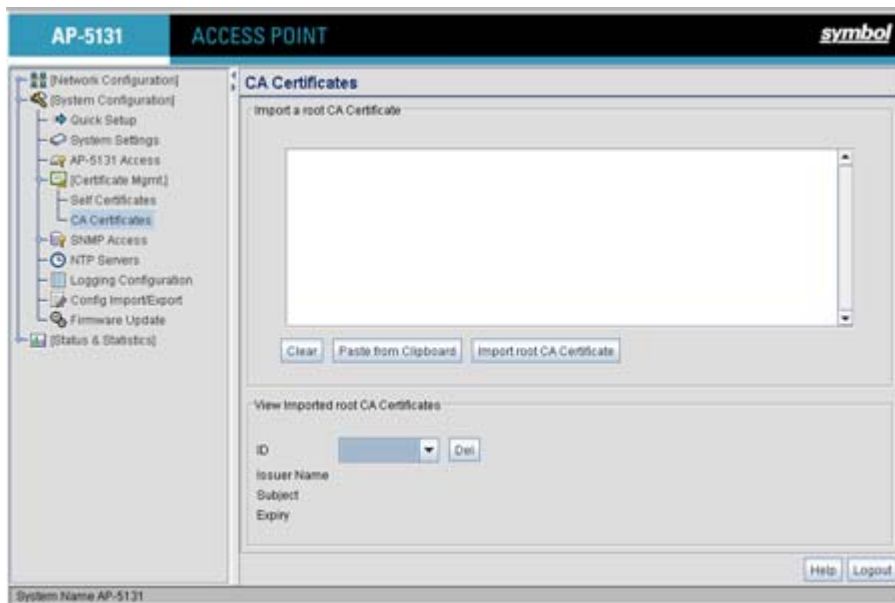

2. Copy the content of the CA Certificate message (using a text editor such as notepad) and then click on **Paste from Clipboard**.

The content of the certificate displays in the **Import a root CA Certificate** field.

3. Click the **Import root CA Certificate** button to import it into the CA Certificate list.
4. Once in the list, select the certificate ID within the **View Imported root CA Certificates** field to view the certificate issuer name, subject, and certificate expiration data.
5. To delete a certificate, select the Id from the drop-down menu and click the **Del** button.

4.3.2 Creating Self Certificates for Accessing the VPN

The AP-5131 requires two kinds of certificates for accessing the VPN, CA certificates and self certificates. Self certificates are certificate requests you create, send to a Certificate Authority (CA) to be signed, then import the signed certificate into the management system.



CAUTION Self certificates can only be generated using the AP-5131 GUI and CLI interfaces. No functionality exists for creating a self-certificate using the AP-5131's SNMP configuration option.

To create a self certificate:

1. Select **System Configuration** -> **Certificate Mgmt** -> **Self Certificates** from the AP-5131 menu tree.
2. Click on the **Add** button to create the certificate request.

Certificate Request

Certificate Request

Key ID (required)

Subject (required)

Department

Organization

City

State

Postal Code

Country Code

Email

Domain Name

IP Address

Signature Algorithm

Key Length

Java Applet Window

The **Certificate Request** screen displays.

3. Complete the request form with the pertinent information. Only 4 values are required, the others optional:

Key ID

Enter a logical name for the certificate to help distinguish between certificates. The name can be up to 7 characters in length.

- Subject** The required **Subject** value contains important information about the certificate. Contact the CA signing the certificate to determine the content of the Subject parameter.
- Signature Algorithm** Use the drop-down menu to select the signature algorithm used for the certificate. Options include:
- MD5-RSA - Message Digest 5 algorithm in combination with RSA encryption.
 - SHA1-RSA - Secure Hash Algorithm 1 in combination with RSA encryption.
- Key Length** Defines the length of the key. Possible values are 512, 1024, and 2048.

4. When the form is completed, click the **Generate** button.

The Certificate Request screen disappears and the ID of the generated certificate request displays in the drop-down list of certificates within the Self Certificates screen.

5. Click the **Generate Request** button.

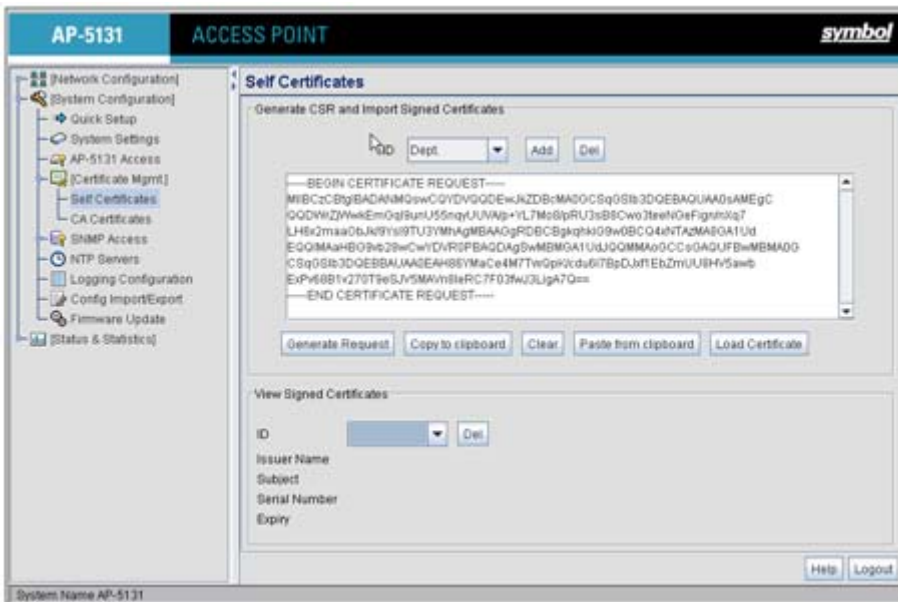

The generated certificate request displays in Self Certificates screen text box.

6. Click the **Copy to Clipboard** button.

The content of certificate request is copied to the clipboard.

Create an email to your CA, paste the content of the request into the body of the message and send it to the CA.

The CA signs the certificate and will send it back. Once received, copy the content from the email into the clipboard.

7. Click the **Paste from clipboard** button.

The content of the email displays in the window.

Click the **Load Certificate** button to import the certificate and make it available for use as a VPN authentication option. The certificate ID displays in the Signed list.



NOTE If the AP-5131 is restarted after a certificate request has been generated but before the signed certificate is imported, the import will not execute properly. Do not restart the AP-5131 during this process.

8. To use the certificate for a VPN tunnel, first define a tunnel and select the IKE settings to use either RSA or DES certificates. For additional information on configuring VPN tunnels, see [Configuring VPN Tunnels on page 6-34](#).

4.3.3 Creating a Certificate for Onboard Radius Authentication

The AP-5131 can use its on-board Radius Server to generate certificates to authenticate MUs for use with the AP-5131. In addition, a Windows 2000 or 2003 Server is used to sign the certificate before downloading it back to the AP-5131's on-board Radius server and loading the certificate for use with the AP-5131.

Both a CA and Self certificate are required for Onboard Radius Authentication. For information on CA Certificates, see [Importing a CA Certificate on page 4-9](#). Ensure the certificate is in a Base 64 Encoded format or risk loading an invalid certificate.



CAUTION Self certificates can only be generated using the AP-5131 GUI and CLI interfaces. No functionality exists for creating a self-certificate using the AP-5131's SNMP configuration option.

To create a self certificate for on-board Radius authentication:

1. Select **System Configuration -> Certificate Mgmt -> Self Certificates** from the AP-5131 menu tree.
2. Click on the **Add** button to create the certificate request.
The **Certificate Request** screen displays.
3. Complete the request form with the pertinent information.

<i>Key ID (required)</i>	Enter a logical name for the certificate to help distinguish between certificates. The name can be up to 7 characters in length.
<i>Subject (required)</i>	The required Subject value contains important information about the certificate. Contact the CA signing the certificate to determine the content of the Subject parameter.
<i>Department</i>	Optionally enter a value for your organizations's department name if needing to differentiate the certificate from similar certificates used in other departments within your organization.
<i>Organization</i>	Optionally enter the name of your organization for supporting information for the certificate request.
<i>City</i>	Optionally enter the name of the City where the AP-5131(using the certificate) resides.
<i>State</i>	Optionally enter the name of the State where the AP-5131(using the certificate) resides.
<i>Postal Code</i>	Optionally enter the name of the Postal (Zip) Code where the AP-5131(using the certificate) resides.
<i>Country Code</i>	Optionally enter the AP-5131's Country Code.
<i>Email</i>	Enter a organizational email address (avoid using a personal address if possible) to associate the request with the proper requesting organization.
<i>Domain Name</i>	Ensure the Domain name is the name of the CA Server. This value must be set correctly to ensure the certificate is properly generated.
<i>IP Address</i>	Enter the IP address of this AP-5131 (as you are using the AP-5131's onboard Radius server).

Signature Algorithm Use the drop-down menu to select the signature algorithm used for the certificate. Options include:

- MD5-RSA - Message Digest 5 algorithm in combination with RSA encryption.
- SHA1-RSA - Secure Hash Algorithm 1 in combination with RSA encryption.

Key Length Defines the length of the key. Possible values are 512, 1024, and 2048. Symbol recommends setting this value to 1024 to ensure optimum functionality.

4. Complete as many of the optional values within the **Certificate Request** screen as possible.
5. When the form is completed, click the **Generate** button from within the Certificate Request screen.

The Certificate Request screen disappears and the ID of the generated certificate request displays in the drop-down list of certificates within the Self Certificates screen.



NOTE A Warning screen may display at this phase stating key information could be lost if you proceed with the certificate request. Click the **OK** button to continue, as the certificate has not been signed yet.

6. Click the **Generate Request** button from within the Self Certificates screen. The certificate content displays within the Self Certificate screen.

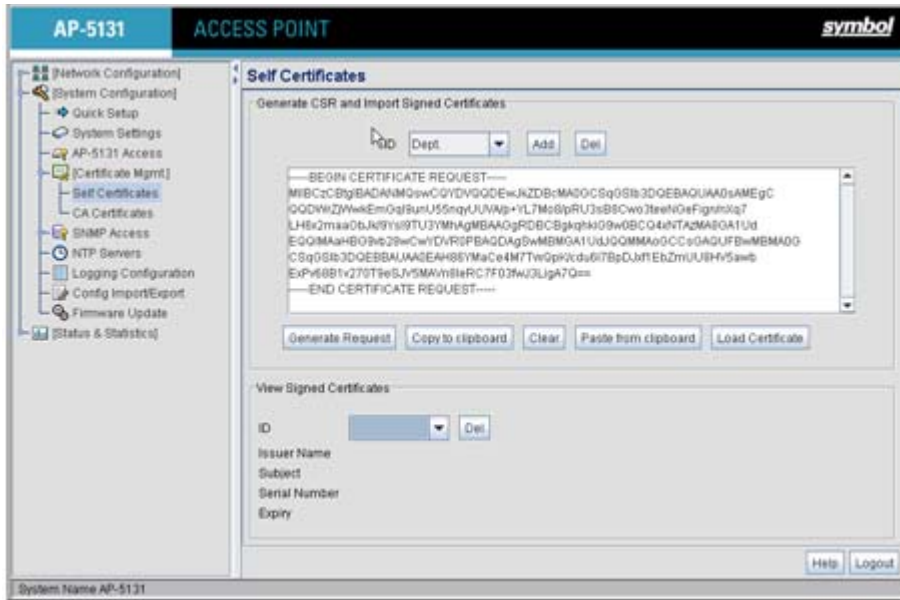

7. Click the **Copy to clipboard** button. Save the certificate content to a secure location.
8. Connect to the Windows 2000 or 2003 server used to sign the certificate.
9. Select the **Request a certificate** option. Click **Next** to continue.
10. Select the **Advanced request** checkbox from within the Choose Request Type screen and click Next to continue.
11. From within the Advanced Certificate Requests screen, select the **Submit a certificate request using a base 64 encoded PKCS #10 file or a renewal request using a base64 encoded PKCS file** option. Click Next to continue.
12. Paste the content of certificate in the **Saved Request** field (within the Submit a Saved Request screen).



NOTE An administrator must make sure the **Web Server** option is available as a selectable option for those without administrative privileges.

If you do not have administrative privileges, ensure the **Web Server** option has been selected from the Certificate Template drop-down menu. Click Submit.

13. Select the **Base 64 encoded** checkbox option from within the Certificate Issued screen and select the **Download CA Certificate** link.

A **File Download** screen displays prompting the user to select the download location for the certificate.

14. Click the **Save** button and save the certificate to a secure location.
15. Load the certificates on the AP-5131.



CAUTION Ensure the CA Certificate is loaded before the Self Certificate, or risk an invalid certificate load.

16. Open the certificate file and copy its contents into the CA Certificates screen by clicking the **Paste from Clipboard** button.

The certificate is now ready to be loaded into the AP-5131's flash memory.

17. Click the **Import root CA Certificate** button from within the CA Certificates screen.
18. Verify the contents of the certificate file display correctly within the CA Certificates screen.
19. Open the certificate file and copy its contents into the Self Certificates screen by clicking the **Paste from Clipboard** button.
20. Click the **Load Certificate** button.
21. Verify the contents of the certificate file display correctly within the Self Certificates screen.

The certificate for the onboard Radius authentication of MUs has now been generated and loaded into the AP-5131's flash memory.

4.4 Configuring SNMP Settings

Simple Network Management Protocol (SNMP) facilitates the exchange of management information between network devices. SNMP uses *Management Information Bases (MIBs)* to manage the device configuration and monitor Internet devices in potentially remote locations. MIB information accessed via SNMP is defined by a set of managed objects called *object identifiers (OIDs)*. An object identifier (OID) is used to uniquely identify each object variable of a MIB. The AP-5131 CDROM contains the following 2 MIB files:

- Symbol-CC-WS2000-MIB-2.0 (common Symbol MIB file)
- Symbol-AP-5131-MIB (AP-5131 specific MIB file)



NOTE The Symbol-AP-5131-MIB contains the majority of the information contained within the Symbol-CC-WS2000-MIB-2.0 file. This feature rich information has been validated with the Symbol WS2000 and proven reliable. The remaining portion of the Symbol-AP-5131-MIB contains supplemental information unique to the AP-5131 feature set.

If using the Symbol-CC-WS2000-MIB-2.0 and/or Symbol-AP-5131-MIB to configure the AP-5131, use the table below to locate the MIB where the feature can be configured.

Feature	MIB	Feature	MIB
<i>LAN Configuration</i>	Symbol-AP-5131-MIB	<i>Subnet Configuration</i>	Symbol-CC-WS2000-MIB-2.0
<i>VLAN Configuration</i>	Symbol-AP-5131-MIB	<i>DHCP Server Configuration</i>	Symbol-CC-WS2000-MIB-2.0
<i>802.1x Port Authentication</i>	Symbol-AP-5131-MIB	<i>Advanced DHCP Server configuration</i>	Symbol-CC-WS2000-MIB-2.0
<i>Ethernet Type Filter Configuration</i>	Symbol-AP-5131-MIB	<i>WAN IP Configuration</i>	Symbol-CC-WS2000-MIB-2.0
<i>Wireless Configuration</i>	Symbol-AP-5131-MIB	<i>PPP Over Ethernet</i>	Symbol-CC-WS2000-MIB-2.0
<i>Security Configuration</i>	Symbol-AP-5131-MIB	<i>NAT Address Mapping</i>	Symbol-CC-WS2000-MIB-2.0
<i>MU ACL Configuration</i>	Symbol-AP-5131-MIB	<i>VPN Tunnel Configuration</i>	Symbol-CC-WS2000-MIB-2.0
<i>QOS Configuration</i>	Symbol-AP-5131-MIB	<i>VPN Tunnel status</i>	Symbol-CC-WS2000-MIB-2.0
<i>Radio Configuration</i>	Symbol-AP-5131-MIB	<i>Content Filtering</i>	Symbol-CC-WS2000-MIB-2.0
<i>Bandwidth Management</i>	Symbol-AP-5131-MIB	<i>Rogue AP Detection</i>	Symbol-CC-WS2000-MIB-2.0
<i>SNMP Trap Selection</i>	Symbol-AP-5131-MIB	<i>Firewall Configuration</i>	Symbol-CC-WS2000-MIB-2.0
<i>SNMP RF Trap Thresholds</i>	Symbol-AP-5131-MIB	<i>LAN to WAN Access</i>	Symbol-CC-WS2000-MIB-2.0
<i>Config Import/Export</i>	Symbol-AP-5131-MIB	<i>Advanced LAN Access</i>	Symbol-CC-WS2000-MIB-2.0
<i>MU Authentication Stats</i>	Symbol-AP-5131-MIB	<i>Router Configuration</i>	Symbol-CC-WS2000-MIB-2.0

Feature	MIB	Feature	MIB
<i>WNMP Ping Configuration</i>	Symbol-AP-5131-MIB	<i>System Settings</i>	Symbol-CC-WS2000-MIB-2.0
<i>Known AP Stats</i>	Symbol-AP-5131-MIB	<i>AP 5131 Access</i>	Symbol-CC-WS2000-MIB-2.0
<i>Flash LEDs</i>	Symbol-AP-5131-MIB	<i>Certificate Mgt</i>	Symbol-CC-WS2000-MIB-2.0
<i>Automatic Update</i>	Symbol-AP-5131-MIB	<i>SNMP Access Configuration</i>	Symbol-CC-WS2000-MIB-2.0
		<i>SNMP Trap Configuration</i>	Symbol-CC-WS2000-MIB-2.0
		<i>NTP Server Configuration</i>	Symbol-CC-WS2000-MIB-2.0
		<i>Logging Configuration</i>	Symbol-CC-WS2000-MIB-2.0
		<i>Firmware Update</i>	Symbol-CC-WS2000-MIB-2.0
		<i>Wireless Stats</i>	Symbol-CC-WS2000-MIB-2.0
		<i>Radio Stats</i>	Symbol-CC-WS2000-MIB-2.0
		<i>MU Stats</i>	Symbol-CC-WS2000-MIB-2.0
		<i>Automatic Update</i>	Symbol-CC-WS2000-MIB-2.0

SNMP allows a network administrator to manage network performance, find and solve network problems, and plan for network growth. The AP-5131 supports SNMP management functions for gathering information from its network components, communicating that information to specified users and configuring the AP-5131. All the fields available within the AP-5131 are also configurable within the MIB.

The AP-5131 SNMP agent functions as a command responder and is a multilingual agent responding to SNMPv1, v2c and v3 managers (command generators). The factory default configuration maintains SNMPv1/2c support of the community names, hence providing backward compatibility.

SNMP v1/v2c community definitions and SNMP v3 user definitions work independently, and both use the *Access Control List (ACL)* of the **SNMP Access Control** sub-screen.

Use the **SNMP Access** screen to define SNMP v1/v2c community definitions and SNMP v3 user definitions. SNMP version 1 (v1) provides a strong network management system, but its security is relatively weak. The improvements in SNMP version 2c (v2c) do not include the attempted security enhancements of other version-2 protocols. Instead, SNMP v2c defaults to SNMP-standard

community strings for read-only and read/write access. SNMP version 3 (v3) further enhances protocol features, providing much improved security. SNMP v3 encrypts transmissions and provides authentication for users generating requests.

To configure SNMP v1/v2c community definitions and SNMP v3 user definitions for the AP-5131:

1. Select **System Configuration** -> **SNMP Access** from the AP-5131 menu tree.

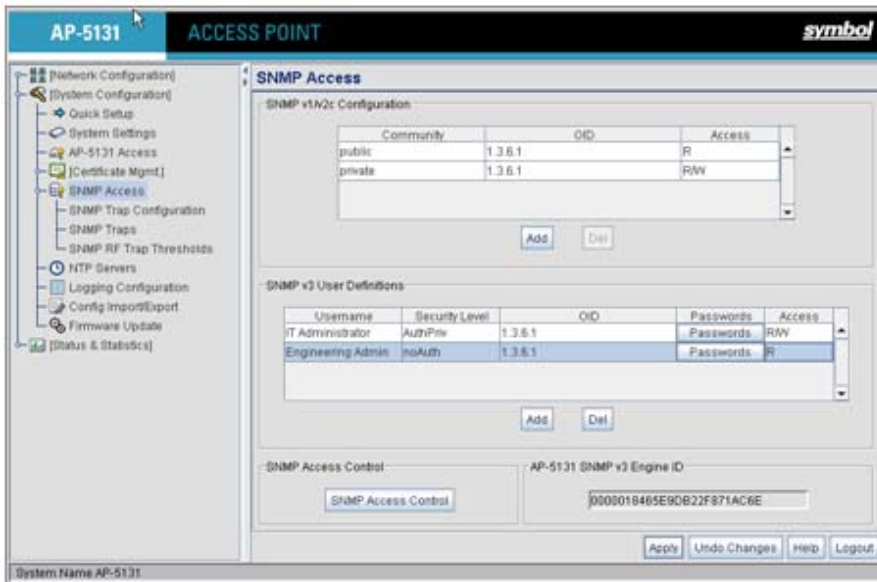

SNMP v1/v2c community definitions allow read-only or read/write access to AP-5131 management information. The SNMP community includes users whose IP addresses are specified on the **SNMP Access Control** screen.

A read-only community string allows a remote device to retrieve information, while a read/write community string allows a remote device to modify settings. Symbol recommends considering adding a community definition using a site-appropriate name and access level. Set up a read/write definition (at a minimum) to facilitate full access by the AP-5131 administrator.

2. Configure the **SNMP v1/v2 Configuration** field (if SNMP v1/v2 is used) to add or delete community definitions, name the community, specify the OID and define community access.

Add

Click **Add** to create a new SNMP v1/v2c community definition.

- | | |
|------------------|---|
| <i>Delete</i> | Select Delete to remove a SNMP v1/v2c community definition. |
| <i>Community</i> | Use the Community field to specify a site-appropriate name for the community. The name is required to match the name used within the remote network management software. |
| <i>OID</i> | Use the OID (Object Identifier) pull-down list to specify a setting of All or a enter a Custom OID. Select All to assign the user access to all OIDs in the MIB. The OID field uses numbers expressed in dot notation. |
| <i>Access</i> | Use the Access pull-down list to specify <i>read-only (R)</i> access or <i>read/write (RW)</i> access for the community. Read-only access allows a remote device to retrieve AP-5131 information, while read/write access allows a remote device to modify AP-5131 settings. |
3. Configure the **SNMP v3 User Definitions** field (if SNMP v3 is used) to add and configure SNMP v3 user definitions.
- SNMP v3 user definitions allow read-only or read/write access to management information as appropriate.
- | | |
|-----------------------|---|
| <i>Add</i> | Click Add to create a new entry for an SNMP v3 user. |
| <i>Delete</i> | Select Delete to remove an entry for an SNMP v3 user. |
| <i>Username</i> | Specify a username by typing an alphanumeric string of up to 31 characters. |
| <i>Security Level</i> | Use the Security Level area to specify a security level of <i>noAuth (no authorization)</i> , <i>AuthNoPriv (authorization without privacy)</i> , or <i>AuthPriv (authorization with privacy)</i> .
The NoAuth setting specifies no login authorization or encryption for the user.
The AuthNoPriv setting requires login authorization, but no encryption.
The AuthPriv setting requires login authorization and uses the <i>Data Encryption Standard (DES)</i> protocol. |
| <i>OID</i> | Use the OID (Object Identifier) area to specify a setting of All or enter a Custom OID. Select All to assign the user access to all OIDs in the MIB. The OID field uses numbers expressed in dot notation. |

Passwords Select **Passwords** to display the **Password Settings** screen for specifying authentication and password settings for an SNMP v3 user. The maximum password length is 11 characters. Use the **Authentication Algorithm** drop-down menu to specify **MD5** or **SHA1** as the authentication algorithm. Use the Privacy Algorithm drop-down menu to define an algorithm of **DES** or **AES-128bit**. When entering the same username on the **SNMP Traps** and **SNMP Access** screens, the password entered on the SNMP Traps page overwrites the password entered on the SNMP Access page. To avoid this problem, enter the same password on both pages.

Access Use the **Access** pull-down list to specify *read-only (R)* access or *read/write (RW)* access for a user. Read-only access permits a user to retrieve AP-5131 information, while read/write access allows a user to modify AP-5131 settings.

- Specify the users who can read and optionally modify the SNMP-capable client.

SNMP Access Control Click the **SNMP Access Control** button to display the **SNMP Access Control** screen for specifying which users can read SNMP-generated information and potentially modify related settings from an SNMP-capable client.

The SNMP Access Control screen's Access Control List (ACL) uses Internet Protocol (IP) addresses to restrict access to the AP's SNMP interface. The ACL applies to both SNMP v3 user definitions and SNMP v1/v2c community definitions.

For detailed instructions of configuring SNMP user access and modification privileges, see [Configuring SNMP Access Control on page 4-23](#).

- If configuring SNMP v3 user definitions, set the SNMP v3 engine ID.

AP-5131 SNMP v3 Engine ID The AP-5131 **SNMP v3 Engine ID** field lists the unique SNMP v3 Engine ID for the AP-5131. This ID is used in SNMP v3 as the source for a trap, response or report. It is also used as the destination ID when sending *get*, *getnext*, *getbulk*, *set* or *inform* commands.

- Click **Apply** to save any changes to the SNMP Access screen. Navigating away from the screen without clicking the Apply button results in all changes to the screen being lost.

7. Click **Undo Changes** (if necessary) to undo any changes made. Undo Changes reverts the settings displayed on the SNMP Access screen to the last saved configuration.
8. Click **Logout** to securely exit the AP-5131 Symbol Access Point applet. A prompt displays confirming the logout before the applet is closed.

For additional SNMP configuration information, see:

- [Configuring SNMP Access Control](#)
- [Enabling SNMP Traps](#)
- [Configuring Specific SNMP Traps](#)
- [Configuring SNMP RF Trap Thresholds](#)

4.4.1 Configuring SNMP Access Control

Use the **SNMP Access Control** screen (as launched from the SNMP Access screen) to specify which users can read SNMP generated information and, if capable, modify related settings from an SNMP-capable client.

Use the SNMP Access Control screen's *Access Control List (ACL)* to limit, by Internet Protocol (IP) address, who can access the AP-5131 SNMP interface.



NOTE The ACL applies to both SNMP v3 user definitions and SNMP v1/v2c community definitions on the AP-5131 SNMP Access screen.

To configure SNMP user access control for the AP-5131:

1. Select **System Configuration** -> **SNMP Access** from the AP-5131 menu tree. Click on the **SNMP Access Control** button from within the SNMP Access screen.



2. Configure the SNMP Access Control screen to add the IP addresses of those users receiving SNMP access.

Access Control List

Enter Start IP and End IP addresses (numerical addresses only, no DNS names supported) to specify a range of user that can access the AP-5131 SNMP interface. An SNMP-capable client can be set up whereby only the administrator (for example) can use a read/write community definition.

Use just the Starting IP Address column to specify a single SNMP user. Use both the Starting IP Address and Ending IP Address columns to specify a range of addresses for SNMP users.

To add a single IP address to the ACL, enter the same IP address in the Start IP and End IP fields.

Leave the ACL blank to allow access to the SNMP interface from the IP addresses of all authorized users.

Add

Click **Add** to create a new ACL entry.

Edit

Click **Edit** to revise an existing ACL entry.

Delete

Click **Delete** to remove a selected ACL entry for one or more SNMP users.

<i>OK</i>	Click Ok to return to the SNMP Access screen. Click Apply within the SNMP Access screen to save any changes made on the SNMP Access Control screen.
<i>Cancel</i>	Click Cancel to undo any changes made on the SNMP Access Control screen. This reverts all settings for this screen to the last saved configuration.

4.4.2 Enabling SNMP Traps

SNMP provides the ability to send traps to notify the administrator that trap conditions are met. Traps are network packets containing data relating to network devices, or SNMP agents, that send the traps. SNMP management applications can receive and interpret these packets, and optionally can perform responsive actions. SNMP trap generation is programmable on a trap-by-trap basis.

Use the **SNMP Traps Configuration** screen to enable traps and to configure appropriate settings for reporting this information. Trap configuration depends on the network machine that receives the generated traps. SNMP v1/v2c and v3 trap configurations function independently. In a mixed SNMP environment, generated traps can be sent using configurations for both SNMP v1/v2c and v3.

To configure SNMP traps on the AP-5131:

1. Select **System Configuration** -> **SNMP Access** -> **SNMP Trap Configuration** from the AP-5131 menu tree.

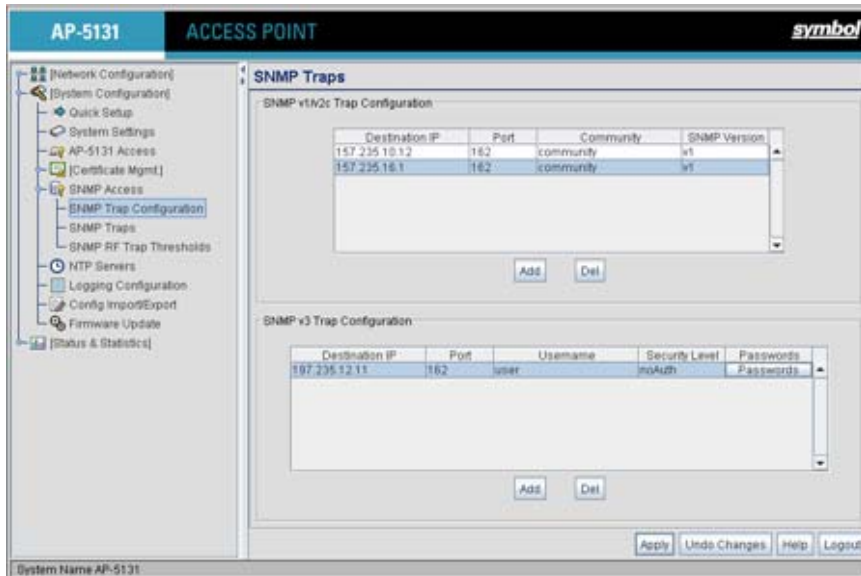

- Configure the **SNMP v1/v2c Trap Configuration** field (if SNMP v1/v2c Traps are used) to modify the following:

Add Click **Add** to create a new SNMP v1/v2c Trap Configuration entry.

Delete Click **Delete** to remove a selected SNMP v1/v2c Trap Configuration entry.

Destination IP Specify a numerical (non DNS name) destination IP address for receiving the traps sent by the AP-5131 SNMP agent.

Port Specify a destination *User Datagram Protocol (UDP)* port for receiving traps. The default is 162.

Community Enter a community name specific to the SNMP-capable client that receives the traps.

SNMP Version Use the SNMP Version drop-down menu to specify v1 or v2. Some SNMP clients support only SNMP v1 traps, while others support SNMP v2 traps and possibly both, verify the correct traps are in use with clients that support them.

- Configure the **SNMP v3 Trap Configuration** field (if SNMP v3 Traps are used) to modify the following:

<i>Add</i>	Click Add to create a new SNMP v3 Trap Configuration entry.
<i>Delete</i>	Select Delete to remove an entry for an SNMP v3 user.
<i>Destination IP</i>	Specify a numerical (non DNS name) destination IP address for receiving the traps sent by the AP-5131 SNMP agent.
<i>Port</i>	Specify a destination <i>User Datagram Protocol (UDP)</i> port for receiving traps.
<i>Username</i>	Enter a username specific to the SNMP-capable client receiving the traps.
<i>Security Level</i>	Use the Security Level drop-down menu to specify a security level of <i>noAuth</i> (no authorization), <i>AuthNoPriv</i> (authorization without privacy), or <i>AuthPriv</i> (authorization with privacy). The “NoAuth” setting specifies no login authorization or encryption for the user. The “AuthNoPriv” setting requires login authorization, but no encryption. The “AuthPriv” setting requires login authorization and uses the <i>Data Encryption Standard (DES)</i> .
<i>Passwords</i>	Select Passwords to display the Password Settings screen for specifying authentication and password settings for an SNMP v3 user. The maximum password length is 11 characters. Use the Authentication Algorithm drop-down menu to specify MD5 or SHA1 as the authentication algorithm. Use the Privacy Algorithm drop-down menu to define an algorithm of DES or AES-128bit . If entering the same username on the SNMP Traps and SNMP Access screens, the password entered on the SNMP Traps page overwrites the password entered on the SNMP Access page. To avoid this problem, enter the same password on both pages.

4. Click **Apply** to save any changes to the SNMP Trap Configuration screen. Navigating away from the screen without clicking the Apply button results in all changes to the screen being lost.
5. Click **Undo Changes** (if necessary) to undo any changes made. Undo Changes reverts the settings displayed on SNMP Trap Configuration screen to the last saved configuration.
6. Click **Logout** to securely exit the AP-5131 Symbol Access Point applet. A prompt displays confirming the logout before the applet is closed.

4.4.3 Configuring Specific SNMP Traps

Use the **SNMP Traps** screen to enable specific traps on the AP-5131. Symbol recommends defining traps to capture unauthorized devices operating within the AP-5131 coverage area. Trap configuration depends on the network machine that receives the generated traps. SNMP v1/v2c and v3 trap configurations function independently. In a mixed SNMP environment, traps can be sent using configurations for both SNMP v1/v2c and v3.

To configure specific SNMP traps on the AP-5131:

1. Select **System Configuration** -> **SNMP Access** -> **SNMP Traps** from the AP-5131 menu tree.

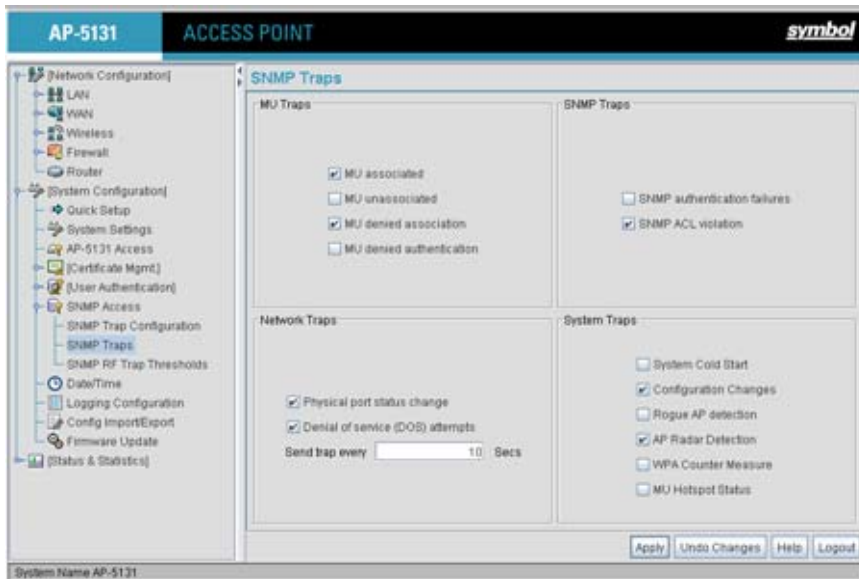

2. Configure the **MU Traps** field to generate traps for MU associations, MU association denials and MU authentication denials. When a trap is enabled, a trap is sent every 10 seconds until the condition no longer exists.

MU associated Generates a trap when an MU becomes associated with one of the AP-5131's WLANs.

MU unassociated Generates a trap when an MU becomes unassociated with (or gets dropped from) one of the AP-5131's WLANs.

- | | |
|---------------------------------|--|
| <i>MU denied association</i> | Generates a trap when an MU is denied association to a AP-5131 WLAN. Can be caused when the maximum number of MUs for a WLAN is exceeded or when an MU violates the AP-5131's <i>Access Control List (ACL)</i> . |
| <i>MU denied authentication</i> | Generates a trap when an MU is denied authentication on one of the AP's WLANs. Can be caused by the MU being set for the wrong authentication type for the WLAN or by an incorrect key or password. |
3. Configure the **SNMP Traps** field to generate traps when SNMP capable MUs are denied authentication privileges or are subject of an ACL violation. When a trap is enabled, a trap is sent every 5 seconds until the condition no longer exists.
- | | |
|-------------------------------------|---|
| <i>SNMP authentication failures</i> | Generates a trap when an SNMP-capable client is denied access to the AP-5131's SNMP management functions or data. This can result from an incorrect login, or missing/incorrect user credentials. |
| <i>SNMP ACL violation</i> | Generates a trap when an SNMP client cannot access SNMP management functions or data due to an Access Control List (ACL) violation. This can result from a missing/incorrect IP address entered within the SNMP Access Control screen. |
4. Configure the **Network Traps** field to generate traps when the AP-5131's link status changes or when the AP's firewall detects a DOS attack.
- | | |
|---|---|
| <i>Physical port status change</i> | Generates a trap whenever the status changes on the AP-5131. The physical port status changes when a link is lost between the AP-5131 and a connected device. |
| <i>Denial of service (DOS) attempts</i> | Generates a trap whenever a <i>Denial of Service (DOS)</i> attack is detected by the AP-5131 firewall. A new trap is sent at the specified interval until the attack has stopped. |
| <i>Send trap every</i> | Defines the interval in seconds the AP-5131 uses to generate a trap until the Denial of Service attack is stopped. Default is 10 seconds. |
5. Configure the **System Traps** field to generate traps when the AP-5131 re-initializes during transmission, saves its configuration file. When a trap is enabled, a trap is sent every 5 seconds until the condition no longer exists.

<i>System Cold Start</i>	Generates a trap when the AP-5131 re-initializes while transmitting, possibly altering the SNMP agent's configuration or protocol entity implementation.
<i>Configuration Changes</i>	Generates a trap whenever changes to the AP-5131's configuration file are saved.
<i>Rogue AP detection</i>	Generates a trap if a Rogue AP is detected by the AP-5131.
<i>AP Radar detection</i>	Generates a trap if an AP is detected using a form of radar detection.
<i>WPA Counter Measure</i>	Generates a trap if an attack is detected against the WPA Key Exchange Mechanism.
<i>MU Hotspot Status</i>	Generates a trap when a change to the status of MU hotspot member is detected.

6. Click **Apply** to save any changes to the SNMP Traps screen. Navigating away from the screen without clicking the Apply button results in all changes to the screen being lost.
7. Click **Undo Changes** (if necessary) to undo any changes made. Undo Changes reverts the settings displayed on SNMP Traps screen to the last saved configuration.
8. Click **Logout** to securely exit the AP-5131 Symbol Access Point applet. A prompt displays confirming the logout before the applet is closed.

4.4.4 Configuring SNMP RF Trap Thresholds

Use the **SNMP RF Trap Threshold** screen as a means to track RF activity and the AP-5131's radio and associated MU performance. SNMP RF Traps are sent when RF traffic exceeds defined limits set in the **RF Trap Thresholds** field of the SNMP RF Traps screen. Thresholds are displayed for the AP-5131, WLAN, selected radio and the associated MU.

To configure specific SNMP RF Traps on the AP-5131:

1. Select **System Configuration** -> **SNMP Access** -> **SNMP RF Trap Thresholds** from the AP-5131 menu tree.

AP-5131 ACCESS POINT **symbol**

SNMP RF Trap Thresholds

		Access Point	WLAN	802.11b/g	802.11a	MU	
Pkts/s	greater than	<input type="text"/>	<input type="text"/>	<input type="text"/>	<input type="text"/>	<input type="text"/>	Pps
Throughput	greater than	<input type="text"/>	<input type="text"/>	<input type="text"/>	<input type="text"/>	<input type="text"/>	Mbps
Average Bit Speed	less than	<input type="text"/>	<input type="text"/>	<input type="text"/>	<input type="text"/>	<input type="text"/>	Mbps
Average Signal	less than	<input type="text"/>	<input type="text"/>	<input type="text"/>	<input type="text"/>	<input type="text"/>	dBm
Average Retries	greater than	<input type="text"/>	<input type="text"/>	<input type="text"/>	<input type="text"/>	<input type="text"/>	Retries
% Dropped	greater than	<input type="text"/>	<input type="text"/>	<input type="text"/>	<input type="text"/>	<input type="text"/>	%
% Undecryptable	greater than	<input type="text"/>	<input type="text"/>	<input type="text"/>	<input type="text"/>	<input type="text"/>	%
Associated MUs	greater than	<input type="text"/>	<input type="text"/>	<input type="text"/>	<input type="text"/>	<input type="text"/>	

Minimum Packets

Minimum number of packets required for a trap to fire:

Apply Undo Changes Help Logout

System Name AP-5131

- Configure the **RF Trap Thresholds** field to define device threshold values for SNMP traps.



NOTE Average Bit Speed, % of Non-Unicast, Average Signal, Average Retries, % Dropped and % Undecryptable are not AP-5131 statistics.

<i>Pkts/s</i>	Enter a maximum threshold for the total throughput in Pps (Packets per second).
<i>Throughput</i>	Set a maximum threshold for the total throughput in Mbps (Megabits per second).
<i>Average Bit Speed</i>	Enter a minimum threshold for the average bit speed in Mbps (Megabits per second).
<i>Average Signal</i>	Enter a minimum threshold for the average signal strength in dBm for each device.
<i>Average Retries</i>	Set a maximum threshold for the average number of retries for each device.

<i>% Dropped</i>	Enter a maximum threshold for the total percentage of packets dropped for each device. Dropped packets can be caused by poor RF signal or interference on the channel.
<i>% Undecryptable</i>	Define a maximum threshold for the total percentage of packets undecryptable for each device. Undecryptable packets can be the result of corrupt packets, bad CRC checks or incomplete packets.
<i>Associated MUs</i>	Set a maximum threshold for the total number of MUs associated with each device.

3. Configure the **Minimum Packets** field to define a minimum packet throughput value for trap generation.

<i>Minimum number of packets required for a trap to fire</i>	Enter the minimum number of packets that must pass through the device before an SNMP rate trap is sent. Symbol recommends using the default setting of 1000 as a minimum setting for the field.
--	---

4. Click **Apply** to save any changes to the SNMP RF Traps screen. Navigating away from the screen without clicking the Apply button results in all changes to the screen being lost.
5. Click **Undo Changes** (if necessary) to undo any changes made. Undo Changes reverts the settings displayed on SNMP RF Traps screen to the last saved configuration.
6. Click **Logout** to securely exit the AP-5131 Symbol Access Point applet. A prompt displays confirming the logout before the applet is closed.

4.5 Configuring Network Time Protocol (NTP)

Network Time Protocol (NTP) manages time and/or network clock synchronization in the AP-5131-managed network environment. NTP is a client/server implementation. The AP-5131 (an NTP client) periodically synchronizes its clock with a master clock (an NTP server). For example, the AP-5131 resets its clock to 07:04:59 upon reading a time of 07:04:59 from its designated NTP server.

Time synchronization is recommended for the AP-5131's network operations. For sites using Kerberos authentication, time synchronization is required.

Use the **Date and Time Settings** screen to enable NTP and specify the IP addresses and ports of available NTP servers.



NOTE The current time is not set accurately when initially connecting to the AP-5131. Until a server is defined to provide the AP-5131 the correct time, or the correct time is manually set, the AP-5131 displays 1970-01-01 00:00:00 as the default time.

To manage clock synchronization on the AP-5131:

1. Select **System Configuration** -> **Date/Time** from the AP-5131 menu tree.

2. From within the **Current Time** field, click the **Refresh** button to update the time since the screen was displayed by the user.

The Current Time field displays the current time based on the AP-5131 system clock. If NTP is disabled or if there are no servers available, the system time displays the AP-5131 uptime starting at 1970-01-01 00:00:00, with the time and date advancing.

3. Select the **Set Date/Time** button to display the **Manual Date/Time Setting** screen. This screen enables the user to manually enter the AP-5131's system time using a Year-Month-Day HH:MM:SS format.

This option is disabled when the Enable NTP on AP-5131 checkbox has been selected, and therefore should be viewed as a second means to define the AP-5131 system time.

4. If using the Manual Date/Time Setting screen to define the AP-5131's system time, refer to the **Time Zone** field to select the time used to use as complimentary information to the information entered within the Manual Date/Time Setting screen.
5. If using an NTP server to supply system time to the AP-5131, configure the **NTP Server Configuration** field to define the server network address information required to acquire the AP-5131 network time.

Enable NTP on AP-5131

Select the **Enable NTP on AP-5131** checkbox to allow a connection between the AP-5131 and one or more specified NTP servers. A preferred, first alternate and second alternate NTP server cannot be defined unless this checkbox is selected.

Disable this option (uncheck the checkbox) if Kerberos is not in use and time synchronization is not necessary.

Preferred Time Server

Specify the numerical (non DNS name) IP address and port of the primary NTP server. The default port is 123.

First Alternate Time Server

Optionally, specify the numerical (non DNS name) IP address and port of an alternative NTP server to use for time synchronization if the primary NTP server goes down.

Second Alternate Time Server

Optionally, specify the numerical (non DNS name) and port of yet another NTP server for the greatest assurance of uninterrupted time synchronization.

Synchronization Interval

Define an interval in minutes the AP-5131 uses to synchronize its system time with the NTP server. A synchronization interval value from 15 minutes to 65535 minutes can be specified. For implementations using Kerberos, a synchronization interval of 15 minutes (default interval) or sooner is recommended.

6. Click **Apply** to save any changes to the Date and time Settings screen. Navigating away from the screen without clicking the Apply button results in all changes to the screen being lost.
7. Click **Undo Changes** (if necessary) to undo any changes made. Undo Changes reverts the settings displayed on Date and Time Settings screen to the last saved configuration.
8. Click **Logout** to securely exit the AP-5131 Symbol Access Point applet. A prompt displays confirming the logout before the applet is closed.

4.6 Logging Configuration

The AP-5131 provides the capability for periodically logging system events that prove useful in assessing the throughput and performance of the AP-5131 or troubleshooting problems on the AP-5131 managed *Local Area Network (LAN)*. Use the **Logging Configuration** screen to set the desired logging level (standard syslog levels) and view or save the current AP-5131 system log.

To configure event logging for the AP-5131:

1. Select **System Configuration** - > **Logging Configuration** from the AP-5131 menu tree.

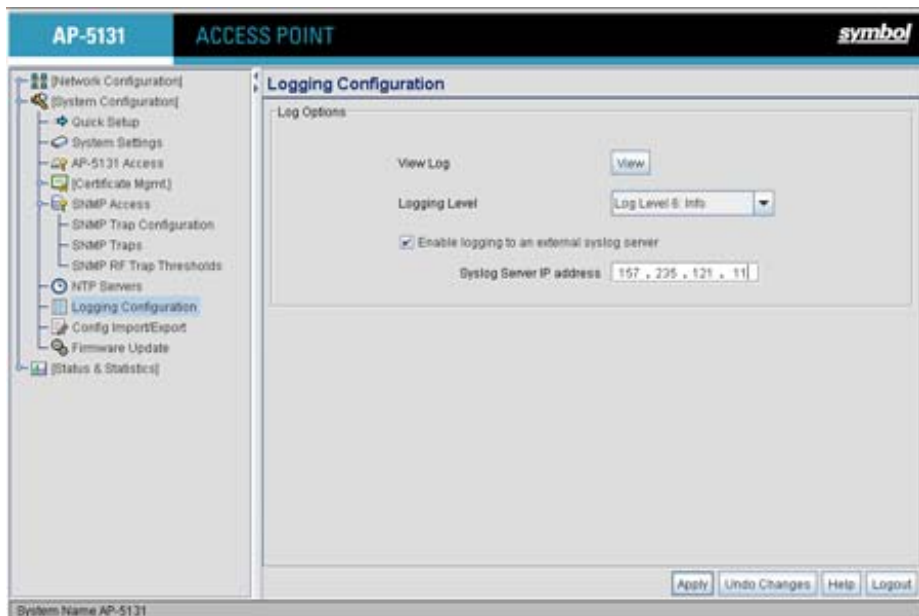

2. Configure the **Log Options** field to save event logs, set the log level and optionally port the AP-5131's log to an external server.

View Log

Click **View** to save a log of events retained on the AP-5131. The system displays a prompt requesting the administrator password before saving the log. After the password has been entered, click **Get File** to display a dialogue with buttons to **Open** or **Save** the log.txt file. Click Save and specify a location to save the log file. Use the WordPad application to view the saved log.txt file on a Microsoft Windows based computer. Do not view the log file using Notepad, as the Notepad application does not properly display the formatting of the AP-5131 log file. Log entries are not saved in the AP-5131. While the AP is in operation, log data temporarily resides in memory. AP memory is completely cleared each time the AP reboots.

Logging Level

Use the **Logging Level** drop-down menu to select the desired log level for tracking system events. Eight logging levels, (0 to 7) are available. **Log Level 6: Info** is the AP-5131 default log level. These are the standard UNIX/LINUX syslog levels. The levels are as follows:

- 0 - Emergency
- 1 - Alert
- 2 - Critical
- 3 - Errors
- 4 - Warning
- 5 - Notice
- 6 - Info
- 7 - Debug

Enable logging to an external syslog server

The AP-5131 can log events to an external syslog (system log) server. Select the **Enable logging to an external syslog server** checkbox to enable the server to listen for incoming syslog messages and decode the messages into a log for viewing.

Syslog server IP address

If the **Enable logging to an external syslog server** checkbox is selected, the numerical (non DNS name) IP address of an external syslog server is required in order to route the syslog events to that destination.

3. Click **Apply** to save any changes to the Logging Configuration screen. Navigating away from the screen without clicking the Apply button results in all changes to the screen being lost.

4. Click **Undo Changes** (if necessary) to undo any changes made. Undo Changes reverts the settings displayed on the Logging Configuration screen to the last saved configuration.
5. Click **Logout** to securely exit the AP-5131 Symbol Access Point applet. A prompt displays confirming the logout before the applet is closed.

4.7 Importing/Exporting Configurations

All of the configuration settings for an AP-5131 can be obtained from another AP-5131 in the form of a text file. Additionally, all of the AP-5131's settings can be downloaded to another AP-5131. Use the file-based configuration feature to speed up the setup process significantly at sites using multiple AP-5131s.

Another benefit is the opportunity to save the current AP configuration before making significant changes or restoring the default configuration. All options on the AP-5131 are deleted and updated by the imported file. Therefore, the imported configuration is not a merge with the configuration of the target AP-5131. The exported file can be edited with any document editor if necessary.

The export function will always export the encrypted Admin User password. The import function will import the Admin Password only if the AP-5131 is set to factory default. If the AP-5131 is not configured to factory default settings, the Admin User password WILL NOT get imported.



CAUTION A single-radio model AP-5131 cannot import/export its configuration to a dual-radio model AP-5131. In turn, a dual-radio model AP-5131 cannot import/export its configuration to a single-radio AP-5131.

Use the **Config Import/Export** screen to configure an import or export operation for AP-5131 configuration settings.



NOTE Use the **System Settings** screen as necessary to restore an AP-5131 default configuration. For more information on restoring configurations, see [Configuring System Settings on page 4-2](#).



CAUTION Symbol discourages importing a 1.0 baseline configuration file to a 1.1 version AP-5131. Similarly, a 1.1 baseline configuration file should not be imported to a 1.0 version AP-5131. Importing configuration files between different version AP-5131's results in broken configurations, since new features added to the 1.1 version AP-5131 cannot be supported in a 1.0 version AP-5131.

To create an importable/exportable AP-5131 configuration file:

1. Select **System Configuration** - > **Config Import/Export** from the AP-5131 menu tree.

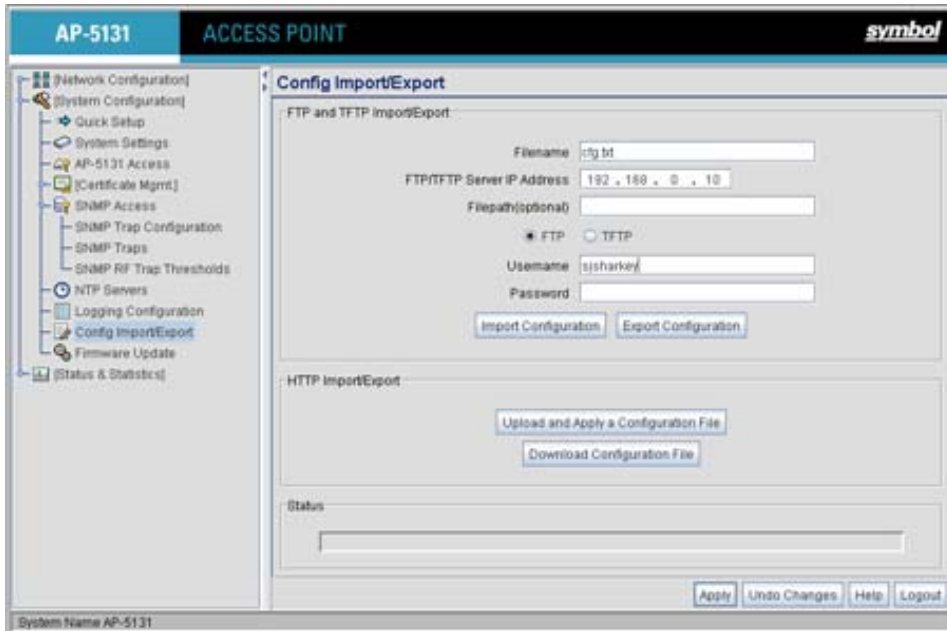

2. Configure the **FTP and TFTP Import/Export** field to import/export configuration settings.

Filename Specify the name of the configuration file to be written to the FTP or TFTP server.

Server IP Enter the numerical (non DNS name) IP address of the destination FTP or TFTP server where the configuration file is imported or exported.

Filepath (optional) Defines the optional path name used to import/export the target configuration file.

FTP Select the FTP radio button if using an FTP server to import or export the configuration.

TFTP Select the TFTP radio button if using an FTP server to import or export the configuration.

<i>Username</i>	Specify a username to be used when logging in to the FTP server. A username is not required for TFTP server logins.
<i>Password</i>	Define a password allowing access to the FTP server for the import or export operation.
<i>Import Configuration</i>	Click the Import Configuration button to import the configuration file from the server with the assigned filename and login information. The system displays a confirmation window indicating the administrator must log out of the AP-5131 after the operation completes for the changes to take effect. Click Yes to continue the operation. Click No to cancel the configuration file import.
<i>Export Configuration</i>	Click the Export Configuration button to export the configuration file from the server with the assigned filename and login information. If the IP mode is set to DHCP Client, IP address information is not exported (true for both LAN1, LAN2 and the WAN port). For LAN1 and LAN2, IP address information is only exported when the IP mode is set to either static or DHCP Server. For the WAN port, IP address information is only exported when the This interface is a DHCP Client checkbox is not selected. For more information on these settings, see Configuring the LAN Interface on page 5-1 and Configuring WAN Settings on page 5-14 . The system displays a confirmation window prompting the administrator to log out of the AP-5131 after the operation completes for the changes to take effect. Click Yes to continue the operation. Click No to cancel the configuration file export.

3. Configure the **HTTP Import/Export** field to import/export AP-5131 configuration settings using HTTP.



CAUTION For HTTP downloads (exports) to be successful, pop-up messages must be disabled.

<i>Upload and Apply A Configuration File</i>	Click the Upload and Apply A Configuration File button to upload a configuration file to this AP-5131 using HTTP.
<i>Download Configuration File</i>	Click the Download Configuration File button to download this AP-5131's configuration file using HTTP.

4. Refer to the **Status** field to assess the completion of the import/export operation.

Status After executing an operation (by clicking any of the buttons in the window), check the Status field for a progress indicator and messages about the success or errors in executing the Import/Export operation. Possible status messages include:

ambiguous input before marker: line <number>
 unknown input before marker: line <number>
 ignored input after marker: line <number>
 additional input required after marker: line <number>
 invalid input length: line <number>
 error reading input: line <number>
 import file from incompatible hardware type: line <number>
 [0] Import operation done
 [1] Export operation done
 [2] Import operation failed
 [3] Export operation failed
 [4] File transfer in progress
 [5] File transfer failed
 [6] File transfer done
 Auto cfg update: Error in applying config
 Auto cfg update: Error in getting config file
 Auto cfg update: Aborting due to fw update failure

The <number> value appearing at the end of some messages relates to the line of the configuration file where an error or ambiguous input was detected.



CAUTION If errors occur when importing the configuration file, a parsing message displays defining the line number where the error occurred. The configuration is still imported, except for the error. Consequently, it is possible to import an invalid configuration. The user is required to fix the problem and repeat the import operation until an error-free import takes place.



NOTE Symbol recommends importing configuration files using the CLI. If errors occur using the CLI, they display all at once and are easier to troubleshoot. The AP-5131 GUI displays errors one at a time, and troubleshooting can be a more time-consuming process.

5. Click **Apply** to save the filename and Server IP information. The Apply button does not execute the import or export operation, only saves the settings entered.
6. Click **Undo Changes** (if necessary) to undo any changes made. Undo Changes reverts the settings displayed on Config Import/Export screen to the last saved configuration.
7. Click **Logout** to securely exit the AP-5131 Symbol Access Point applet. A prompt displays confirming the logout before the applet is closed.



NOTE For a discussion on the implications of replacing an existing Symbol AP-4131 deployment with an AP-5131, see [Replacing an AP-4131 with an AP-5131 on page B-19](#).

4.8 Updating Device Firmware

Symbol periodically releases updated versions of the AP-5131 device firmware to the Symbol Web site. If the AP-5131 firmware version displayed on the **System Settings** page (see [Configuring System Settings on page 4-2](#)) is older than the version on the Web site, Symbol recommends updating the AP-5131 to the latest firmware version for full feature functionality.

The AP-5131's update feature updates the AP-5131's firmware and configuration file automatically when the AP-5131 is reset or when the AP-5131 initiates a DHCP discovery.

The AP-5131 firmware is automatically updated each time firmware versions are found to be different between the AP-5131 and the firmware file located on the DHCP/BootP server. If the configuration file is selected for automatic update, the configuration is automatically updated since the AP-5131 is unable to compare the differences between configuration files.



CAUTION If downgrading firmware from a 1.1 to a 1.0 version, the AP-5131 automatically reverts to 1.0 default settings, regardless of whether you are downloading the firmware manually or using the automatic download feature. The automatic feature allows the user to download the configuration file at the same time, but since the firmware reverts to 1.0 default settings, the configuration file is ignored.

For detailed update scenarios involving both a Windows DHCP and a Linux BootP server configuration, see [Configuring Automatic Updates using a DHCP or Linux BootP Server Configuration on page B-1](#).



CAUTION Loaded and signed CA certificates will be lost when changing the AP-5131's firmware version using either the GUI or CLI. After a certificate has been successfully loaded, export it to a secure location to ensure its availability after a firmware update.

If a firmware update is required, use the **Firmware Update** screen to specify a filename and define a file location for updating the firmware.



NOTE The firmware file must be available from an FTP or TFTP site to perform the update.



CAUTION Make sure a copy of the AP-5131's configuration is exported before updating the firmware.

To conduct a firmware update on the AP-5131:

1. Export the AP-5131 current configuration settings before updating the firmware to have the most recent settings available after the firmware is updated.

Refer to [Importing/Exporting Configurations on page 4-37](#) for instructions on exporting the AP-5131's current configuration to have it available after the firmware is updated.

2. Select **System Configuration** - > **Firmware Update** from the AP-5131 menu tree.

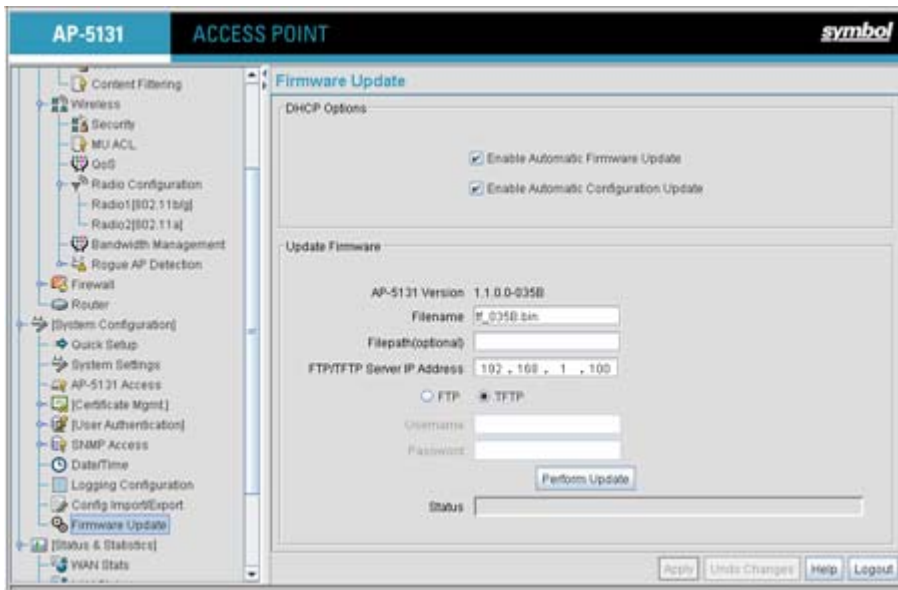

3. Configure the **DHCP Options** field to enable automatic firmware and/or configuration file updates.

DHCP options are used for out-of-the-box rapid deployment for Symbol wireless products. The following are the two DHCP options available on the AP-5131:

- Enable Automatic Firmware Update
- Enable Automatic Configuration Update

These options can be used to update newer firmware and configuration files on the AP-5131. The AP-5131 uses DHCP Vendor Specific Option 43 with the following options embedded within it:

	Option Code	Data Type
AP-5131 TFTP Server Name	181	IP address
AP-5131 Firmware File Name	187	String
AP-5131 Configuration File Name	188	String

The Vendor Class Identifier used is **SymbolAP.5131-V1-0**

The DHCP Server needs to be configured with the above mentioned vendor specific options and vendor class identifier. The update is conducted over the LAN or WAN port depending on which is the active port at the time the firmware update request is made.

Enable Automatic Firmware Update Select this checkbox to allow an automatic firmware update each time firmware versions are found to be different between the AP-5131 and the LAN or WAN interface. This option is used in conjunction with other DHCP options configured on a DHCP server. Symbol recommends selecting the **Enable Automatic Configuration Update** checkbox if auto-updating AP-5131 firmware, as backing up the AP-5131 configuration is always recommended before updating device firmware. If this function is disabled, the firmware update is required to be done manually. If this option is enabled, the AP-5131 initiates an update any time the AP-5131 reboots. If the files located on the DHCP server are different from the existing files on the AP-5131, the files are updated. The default setting is enabled on the AP-5131 WAN port.

Enable Automatic Configuration Update Select this checkbox to allow an automatic configuration file update each time the configuration file versions are found to be different between the AP-5131 and the LAN or WAN interface. If this function is disabled, the configuration file update is required to be done manually. If this function is disabled, the firmware update is required to be done manually. If this option is enabled, the AP-5131 initiates an update any time the AP-5131 reboots. If the files located on the DHCP server are different from the existing files on the AP-5131, the files are updated. The default setting is enabled on the AP-5131 WAN port.

Configure the **Update Firmware** field as required to set a filename and target firmware file upload location for manual firmware updates.

4. Specify the name of the target firmware file within the **Filename** field.
5. If the target firmware file resides within a directory, specify a complete path for the file within the **Filepath(optional)** field.
6. Enter an IP address for the FTP or TFTP server used for the update. Only numerical IP address names are supported, no DNS can be used.
7. Select either the **FTP** or **TFTP** button to define whether the firmware file resides on a FTP or TFTP server.
8. Set the following FTP or TFTP parameters:

- **Username** - Specify a username for the FTP server login.
- **Password** - Specify a password for FTP server login. Default is symbol.



NOTE Click **Apply** to save the settings before performing the firmware update. The user is not able to navigate the AP-5131 user interface while the firmware update is in process.

9. Click the **Perform Update** button to initiate the update. Upon confirming the firmware update, the AP reboots and completes the update.



NOTE The AP-5131 must complete the reboot process to successfully update the device firmware, regardless of whether the reboot is conducted using the GUI or CLI interfaces.

10. After the AP reboots, return to the Firmware Update screen. Check the **Status** field to verify whether the firmware update was successful. If an error occurs, one of the following error messages will display:

FAIL: auto fw update check

FAIL: network activity time out

FAIL: firmware check

FAIL: exceed memory limit

FAIL: authentication

FAIL: connection time out

FAIL: control channel error

FAIL: data channel error

FAIL: channel closed unexpected

FAIL: establish data channel

FAIL: accept data channel

FAIL: user interrupted

FAIL: no valid interface found

FAIL: conflict ip address

FAIL: command exchange time out

FAIL: invalid subnet number

11. Confirm the AP-5131 configuration is the same as it was before the firmware update. If they are not, restore the settings. Refer to [Importing/Exporting Configurations on page 4-37](#) for instructions on exporting the configuration back to the AP-5131.
12. Click **Apply** to save the filename and filepath information entered into the Firmware Update screen. The Apply button does not execute the firmware, only saves the update settings entered.
13. Click **Undo Changes** (if necessary) to undo any changes made. Undo Changes reverts the settings displayed on Firmware Update screen to the last saved configuration.
14. Click **Logout** to securely exit the AP-5131 Symbol Access Point applet. A prompt displays confirming the logout before the applet is closed.

4.8.1 Upgrade/Downgrade Considerations

When upgrading or downgrading AP-5131 configurations between the 1.0.0.0-XX (or 1.0.1.0-XX) and 1.1.0.0-XX baselines, the following should be taken into consideration as certain functionalities may not be available to the user after an upgrade/downgrade:



CAUTION Prior to upgrading/downgrading the AP-5131's configuration, ensure the AP-5131's current configuration has been exported to a secure location. Having the configuration available is recommended in case errors occur in the upgrade/downgrade process.

- When downgrading from 1.1 to 1.0, the AP-5131 is configured to default values.
- After a downgrade from 1.1.0.0-XX to 1.0.0.0-XX, WLANs mapped to LAN2 would still be usable, but now only available on LAN1. Once upgraded back to 1.1.0.0-XX, those WLANs previously available on LAN2 would still be mapped to LAN2.
- If downgraded to the 1.0.0.0-XX baseline, and a restore factory defaults function is performed, only 1.0.0.0-XX default values are restored to their factory default values. The feature set unique to 1.1.0.0-XX can only be restored to factory default when the AP-5131 is running 1.1.0.0-XX firmware.
- Export either a CA or Self Certificate to a safe and secure location before upgrading or downgrading your AP-5131 firmware. If the certificate is not saved, it will be discarded and not available to the user after the upgrade or downgrade. If discarded, a new certificate request would be required.



NOTE For a discussion on the implications of replacing an existing Symbol AP-4131 deployment with an AP-5131, see [Replacing an AP-4131 with an AP-5131 on page B-19](#).

5

Network Management

Configuring network management includes configuring network aspects in numerous areas. See the following sections for more information on AP-5131 network management:

- [*Configuring the LAN Interface*](#)
- [*Configuring WAN Settings*](#)
- [*Enabling Wireless LANs \(WLANs\)*](#)
- [*Configuring Router Settings*](#)

5.1 Configuring the LAN Interface

The AP-5131 has one physical LAN port supporting two unique LAN interfaces. The AP-5131 LAN port has its own MAC address. The LAN port MAC address is always the value of the AP-5131 WAN port MAC address plus 1. The LAN and WAN port MAC addresses can be located within the LAN and WAN Stats screens.

For information on locating the AP-5131 MAC addresses, see [*Viewing WAN Statistics on page 7-2*](#) and [*Viewing LAN Statistics on page 7-6*](#).

Use the **LAN Configuration** screen to enable one (or both) of an AP-5131's LAN interfaces, assign them names, define which LAN is currently active on the AP-5131 Ethernet port and assign a timeout value to disable the LAN connection if no data traffic is detected within a defined interval.

To configure the AP-5131 LAN interface:

1. Select **Network Configuration** -> **LAN** from the AP-5131 menu tree.

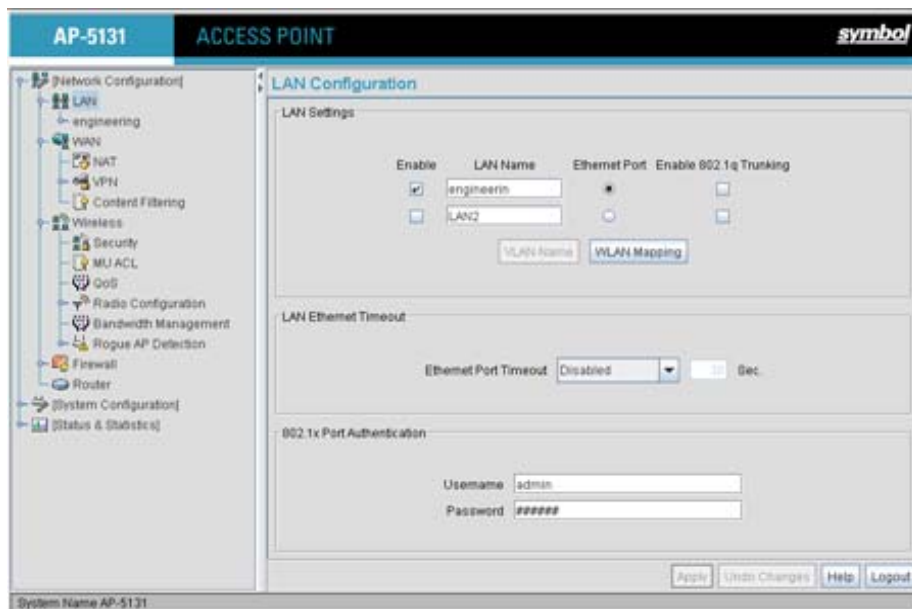

2. Configure the **LAN Settings** field to enable the AP-5131 LAN1 and/or LAN2 interface, assign a timeout value, enable 802.1q trunking, configure WLAN mapping and enable 802.1x port authentication.

Enable Select the LAN1 and/or LAN2 checkbox to allow the forwarding of data traffic over the specified LAN connection. The LAN1 connection is enabled by default, but both LAN interfaces can be enabled simultaneously.

LAN Name Use the **LAN Name** field to modify the existing name of LAN1 and LAN2. LAN1 and LAN2 are the default names assigned to the LANs until modified by the user.

<i>Ethernet Port</i>	The Ethernet Port radio buttons allow you to select one of the two available LANs as the LAN actively transmitting over the AP-5131's LAN port. Both LANs can be active at any given time, but only one can transmit over the AP-5131 physical LAN connection, thus the selected LAN has priority.
<i>Enable 802.1q Trunking</i>	Select the Enable 802.1q Trunking checkbox to enable the LAN to conduct VLAN tagging. If selected, click the WLAN Mapping button to configure mappings between individual WLANs and LANs. If enabled, the AP-5131 is required to be connected to a trunked port.
<i>VLAN Name</i>	Click the VLAN Name button to launch the VLAN Name screen to create VLANs and assign them VLAN IDs. For more information, see Configuring VLAN Support on page 5-4 .
<i>WLAN Mapping</i>	Click the WLAN Mapping button to launch the VLAN Configuration screen to map existing WLANs to one of the two AP-5131's LANs and define the WLAN's VLAN membership (up to 16 mappings are possible per AP-5131). For more information, see Configuring VLAN Support on page 5-4 .
<i>Ethernet Port Timeout</i>	Use the Ethernet Port Timeout drop-down menu to define how the AP-5131 interprets inactivity for the LAN assigned to the Ethernet port. When Enabled is selected, the AP-5131 uses the value defined in the Sec. box (default is 30 seconds). Selecting Disabled allows the LAN selected to use the Ethernet port for an indefinite timeout period.
<i>802.1x Port Authentication</i>	The AP-5131 only supports 802.1x authentication over its LAN port. The AP-5131 behaves as an 802.1x supplicant to authenticate to a server on the network. If using 802.1x authentication, enter the authentication server user name and password. The default password is "symbol." For information on enabling and configuring authentication schemes on the AP-5131, see Enabling Authentication and Encryption Schemes on page 6-5 .

3. Click **Apply** to save any changes to the LAN Configuration screen. Navigating away from the screen without clicking the Apply button results in all changes to the screen being lost if the prompts are ignored.
4. Click **Undo Changes** (if necessary) to undo any changes made. Undo Changes reverts the settings displayed on the LAN configuration screen to the last saved configuration.

5. Click **Logout** to securely exit the AP-5131 Symbol Access Point applet. A prompt displays confirming the logout before the applet is closed.

5.1.1 Configuring VLAN Support

A *Virtual Local Area Network (VLAN)* is a means to electronically separate data on the same AP-5131 from a single broadcast domain into separate broadcast domains. The AP-5131 can group devices on one or more WLANs so that they can communicate as if they were attached to the same wire, when in fact they are located on a different LAN segment. Because VLANs are based on logical instead of physical connections, they are extremely flexible. By using a VLAN, you can group by logical function instead of physical location. A maximum of 16 VLANs can be supported on the AP-5131 (regardless of the AP-5131 being single or dual-radio model). An administrator can map 16 WLANs to 16 VLANs and enable or disable dynamic VLAN assignment.

VLANs enable organizations to share network resources in various network segments within large areas (airports, shopping malls, etc.). A VLAN is a group of clients with a common set of requirements independent of their physical location. VLANs have the same attributes as physical LANs, but they enable system administrators to group MUs even when they are not members of the same network segment.



NOTE A WLAN supporting a mesh network does not need to be assigned to a particular VLAN, as all the traffic proliferating the mesh network is already trunked. However, if MUs are to be connected to the Mesh WLAN, the WLAN will need to be tied to a VLAN.

The AP-5131 assignment of VLANs can be implemented using Static or Dynamic assignments (often referred to as memberships) for individual WLANs. Both methods have their advantages and disadvantages. Static VLAN membership is perhaps the most widely used method because of the relatively small administration overhead and security it provides. With Static VLANs, you manually assign individual WLANs to individual VLANs.

Although static VLANs are the most common form of VLAN assignments, dynamic VLAN assignment is possible per WLAN. Configuring dynamic VLANs entail the AP-5131 sending a DHCP request for device information (such as an IP address). Additional information (such as device MAC address information) is sent to the AP-5131. The AP-5131 sends this MAC address to a host housing a copy of the Dynamic VLAN database. This database houses the records of MAC addresses and VLAN assignments. The VLAN database looks up the MAC to determine what VLAN is assigned to it. If it is not in the database, it simply uses a default VLAN assignment. The VLAN assignment is sent to the

AP-5131. The AP-5131 then maps the target WLAN for the assigned VLAN and traffic passes normally, allowing for the completion of the DHCP request and further traffic.

To create new VLANs or edit the properties of an existing VLAN:

1. Select **Network Configuration** -> **LAN** from the AP-5131 menu tree.
2. Ensure the **Enable 802.1q Trunking** button is selected from within the LAN Setting field.
Trunk links are required to pass VLAN information between destinations. A trunk port is by default a member of all the VLANs existing on the AP-5131 and carry traffic for all those VLANs. Trunking is a function that must be enabled on both sides of a link.
3. Select the **VLAN Name** button.



The VLAN name screen displays. The first time the screen is launched a default VLAN name of 1 and a default VLAN ID of 1 display. The VLAN name is auto-generated once the user assigns a VLAN ID. However, the user has the option of re-assigning a name to the VLAN using **New VLAN** and **Edit VLAN** screens.

To create a new VLAN, click the **Create** button, to edit the properties of an existing VLAN, click the **Edit** button.

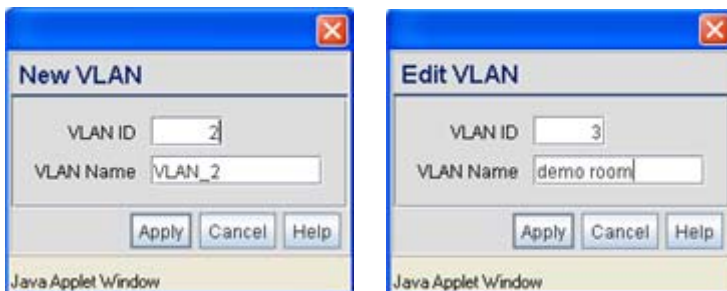

4. Assign a unique **VLAN ID** (from 1 to 4095) to each VLAN added or modified.

The VLAN ID associates a frame with a specific VLAN and provides the information the AP-5131 needs to process the frame across the network. Therefore, it may be practical to assign a name to a VLAN representative of the area or type of network traffic it represents.

A business may have offices in different locations and want to extend an internal LAN between the locations. An AP-5131 managed infrastructure could provide this connectivity, but it requires VLAN numbering be managed carefully to avoid conflicts between two VLANs with the same ID.

5. Define a 32 ASCII character maximum **VLAN Name**.

Enter a unique name that identifies members of the VLAN. Symbol recommends selecting the name carefully, as the VLAN name should signify a group of clients with a common set of requirements independent of their physical location.

6. Click **Apply** to save the changes to the new or modified VLAN.
7. From the LAN Configuration screen, click the **WLAN Mapping** button. The **Mapping Configuration** screen displays.

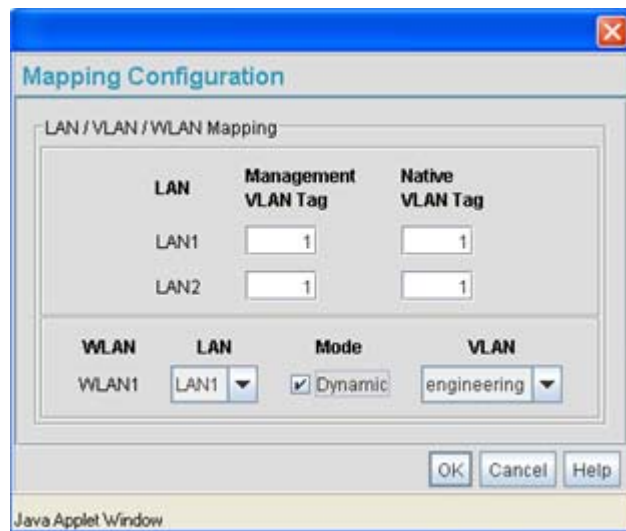

8. Enter a **Management VLAN Tag** for LAN1 and LAN2.

The Management VLAN uses a default tag value of 1. The Management VLAN is used to distinguish VLAN traffic flows for the LAN. The trunk port marks the frames with special tags as they pass between the AP-5131 and its destination, these tags help distinguish data traffic.

Authentication servers (such as Radius and Kerberos) must be on the same Management VLAN. Additionally, DHCP and BOOTP servers must be on the same Management VLAN as well.

9. Define a **Native VLAN Tag** for LAN1 and LAN2.

A trunk port configured with 802.1Q tagging can receive both tagged and untagged traffic. By default, the AP-5131 forwards untagged traffic with the native VLAN configured for the port. The Native VLAN is VLAN 1 by default. Symbol suggests leaving the Native VLAN set to 1 as other layer 2 devices also have their Native VLAN set to 1.

10. Use the **LAN** drop-down menu to map one of the two AP-5131s LANs to the WLAN listed to the left. With this assignment, the WLAN uses this assigned LAN interface.
11. Select the **Dynamic** checkboxes (under the **Mode** column) to configure the VLAN mapping as a dynamic VLAN.

Using Dynamic VLAN assignments, a *VMPS (VLAN Management Policy Server)* dynamically assigns VLAN ports. The AP-5131 uses a separate server as a VMPS server. When a frame

arrives on the AP-5131, it queries the VMPS for the VLAN assignment based on the source MAC address of the arriving frame.

If statically mapping VLANs, leave the **Dynamic** checkbox specific to the target WLAN and its intended VLAN unselected. The administrator is then required to configure VLAN memberships manually.

The Dynamic checkbox is enabled only when a WLAN is having EAP security configured. Otherwise, the checkbox is disabled.

12. Use the **VLAN** drop-down menu to select the name of the target VLAN to map to the WLAN listed on the left-hand side of the screen.

Symbol recommends mapping VLANs strategically in order to keep VLANs tied to the discipline they most closely match. For example, If WLAN1 is comprised of MUs supporting the sales area, then WLAN1 should be mapped to sales if a sales VLAN has been already been created.

13. Click **Apply** to return to the **VLAN Name** screen. Click **OK** to return to the LAN screen. Once at the LAN screen, click **Apply** to re-apply your changes.

5.1.2 Configuring LAN1 and LAN2 Settings

Both LAN1 and LAN2 have separate sub-screens to configure the DHCP settings used by the LAN1 and LAN2 interfaces. Within each LAN screen is a button to access a sub-screen to configure advanced DHCP settings for that LAN. For more information, see [Configuring Advanced DHCP Server Settings on page 5-11](#). Additionally, LAN1 and LAN2 each have separate **Type Filter** submenu items used to prevent specific (an potentially unnecessary) frames from being processed, for more information, see [Setting the Type Filter Configuration on page 5-13](#).

To configure unique settings for either LAN1 or LAN2:

1. Select **Network Configuration** -> **LAN** -> **LAN1 (or LAN2)** from the AP-5131 menu tree.

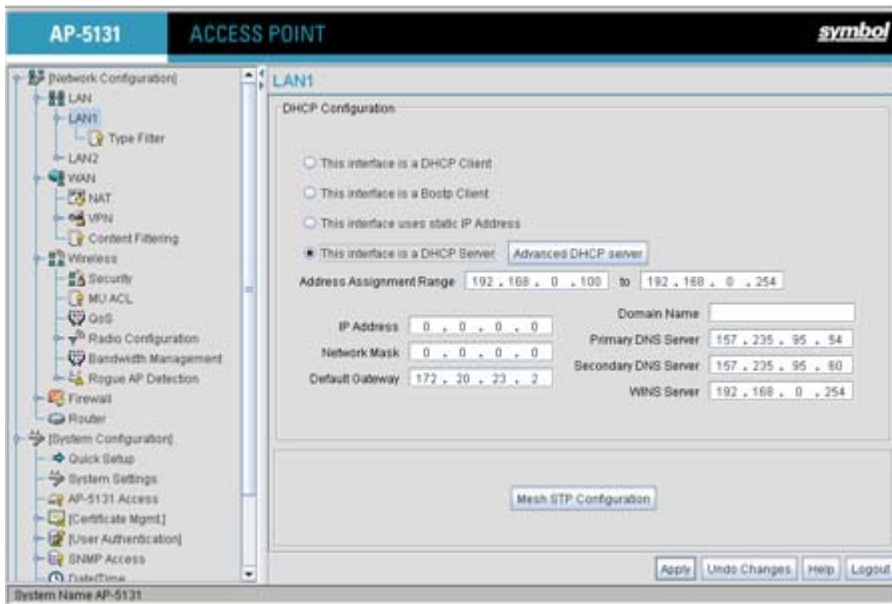

2. Configure the **DHCP Configuration** field to define the DHCP settings used for the LAN.



NOTE Symbol recommends the WAN and LAN ports should not both be configured as DHCP clients.

This interface is a DHCP Client

Select this button to enable DHCP to set AP-5131 network address information via this LAN1 or LAN2 connection. This is recommended if the AP-5131 resides within a large corporate network or the *Internet Service Provider (ISP)* uses DHCP.

DHCP is a protocol that includes mechanisms for IP address allocation and delivery of host-specific configuration parameters from a DHCP server to a host. If DHCP Client is selected, the first DHCP or BOOTP server to respond sets the IP address and network address values since DHCP and BOOTP are interoperable.

<i>This interface is a BOOTP Client</i>	Select this button to enable BOOTP to set AP-5131 network address information via this LAN1 or LAN2 connection. When selected, only BOOTP responses are accepted by the AP-5131. If both DHCP and BOOTP services are required, do not select BOOTP Client.
<i>This interface uses static IP Address</i>	Select the This interface uses static IP Address button, and manually enter static network address information in the areas provided.
<i>This interface is a DHCP Server</i>	The AP-5131 can be configured to function as a DHCP server over the LAN1 or LAN2 connection. Select the This interface is a DHCP Server button and manually enter static network address information in the areas provided.
<i>Address Assignment Range</i>	Use the address assignment parameter to specify a range of numerical (non DNS name) IP addresses reserved for mapping client MAC addresses to IP addresses. If a manually (static) mapped IP address is within the IP address range specified, that IP address could still be assigned to another client. To avoid this, ensure all statically mapped IP addresses are outside of the IP address range assigned to the DHCP server.
<i>Advanced DHCP Server</i>	Click the Advanced DHCP Server button to display a screen used for generating a list of static MAC to IP address mappings for reserved clients. A separate screen exists for each of the AP-5131 LANs. For more information, see Configuring Advanced DHCP Server Settings on page 5-11 .
<i>IP Address</i>	The network-assigned numerical (non DNS name) IP address of the AP-5131.
<i>Network Mask</i>	The first two sets of numbers specify the network domain, the next set specifies the subset of hosts within a larger network. These values help divide a network into subnetworks and simplify routing and data transmission. The subnet mask defines the size of the subnet.
<i>Default Gateway</i>	The Default Gateway parameter defines the numerical (non DNS name) IP address of a router the AP-5131 uses on the Ethernet as its default gateway.
<i>Domain Name</i>	Enter the name assigned to the primary DNS server.
<i>Primary DNS Server</i>	Enter the Primary DNS numerical (non DNS name) IP address.

<i>Secondary DNS Server</i>	Symbol recommends entering the numerical IP address of an additional DNS server (if available), used if the primary DNS server goes down. A maximum of two DNS servers can be used.
<i>WINS Server</i>	Enter the numerical (non DNS name) IP address of the WINS server. WINS is a Microsoft NetBIOS name server. Using a WINS server eliminates the broadcasts needed to resolve computer names to IP addresses by providing a cache or database of translations.
<i>Mesh STP Configuration</i>	<p>Click the Mesh STP Configuration button to define bridge settings for this specific LAN. Each of the AP-5131's two LANs can have a separate mesh configuration. As the <i>Spanning Tree Protocol</i> (STP) mentions, each mesh network maintains hello, forward delay and max age timers. These settings can be used as is using the current default settings, or be modified. However, if these settings are modified, they need to be configured for the LAN connecting to the mesh network WLAN.</p> <p>For information on the AP-5131's new mesh networking capabilities, see Configuring Mesh Networking Support on page 9-5. If new to mesh networking and in need of an overview, see Mesh Networking Overview on page 9-1.</p>

3. Click **Apply** to save any changes to the LAN1 or LAN2 screen. Navigating away from the screen without clicking the Apply button results in all changes to the screen being lost if the prompts are ignored.
4. Click **Undo Changes** (if necessary) to undo any changes made. Undo Changes reverts the settings displayed on the LAN1 or LAN2 screen to the last saved configuration.
5. Click **Logout** to securely exit the AP-5131 Symbol Access Point applet. A prompt displays confirming the logout before the applet is closed.

5.1.2.1 Configuring Advanced DHCP Server Settings

Use the **Advanced DHCP Server** screen to specify (reserve) static (or fixed) IP addresses for specific devices. Every wireless, 802.11x-standard device has a unique *Media Access Control (MAC)* address. This address is the device's hard-coded hardware number (shown on the bottom or back). An example of a MAC address is 00:A0:F8:45:9B:07.

The DHCP server can grant an IP address for as long as it remains in active use. The lease time is the number of seconds that an IP address is reserved for re-connection after its last use. Using very short leases, DHCP can dynamically reconfigure networks in which there are more computers than

available IP addresses. This is useful, for example, in education and customer environments where MU users change frequently. Use longer leases if there are fewer users.

To generate a list of client MAC address to IP address mappings for the AP-5131:

1. Select **Network Configuration** -> **LAN** -> **LAN1 (or LAN2)** from the AP-5131 menu tree.
2. Click the **Advanced DHCP Server** button from within the **LAN1** or **LAN2** screen.

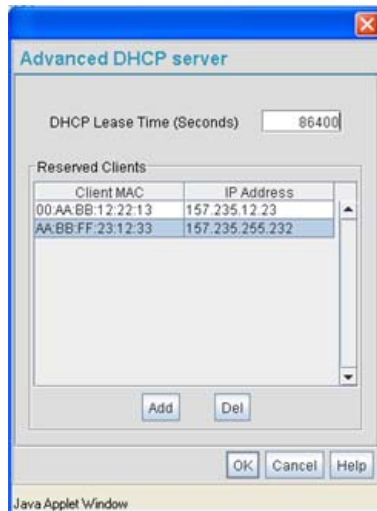

3. Specify a lease period in seconds for available IP addresses using the **DHCP Lease Time (Seconds)** parameter. An IP address is reserved for re-connection for the length of time you specify. The default interval is 86400 seconds.
4. Click the **Add** button to create a new table entry within the **Reserved Clients** field.
If a statically mapped IP address is within the IP address range in use by the DHCP server, that IP address may still be assigned to another client. To avoid this, ensure all statically mapped IP addresses are outside of the IP address range assigned to the DHCP server.
If multiple entries exist within the Reserved Clients field, use the scroll bar to the right of the window to navigate.
5. Click the **Del** (delete) button to remove a selected table entry.
6. Click **OK** to return to the LAN1 or LAN2 page, where the updated settings within the **Advanced DHCP Server** screen can be saved by clicking the **Apply** button.

- Click **Cancel** to undo any changes made. Undo Changes reverts the settings displayed to the last saved configuration.

5.1.2.2 Setting the Type Filter Configuration

Each AP-5131 LAN (either LAN1 or LAN2) can keep a list of frame types that it forwards or discards. The Type Filtering feature prevents specific (a potentially unnecessary) frames from being processed by the AP-5131 in order to improve throughput. These include certain broadcast frames from devices that consume bandwidth, but are unnecessary to AP-5131 operations.

Use the **Ethernet Type Filter Configuration** screen to build a list of filter types and configure them as either allowed or denied for use with the this particular LAN.

To configure type filtering on the AP-5131:

- Select **Network Configuration**-> **LAN** -> **LAN1 (or LAN2)**-> **Type Filter** from the AP-5131 menu tree.

The **Ethernet Type Filter Configuration** screen displays for the LAN. No Ethernet types are displayed (by default) when the screen is first launched.

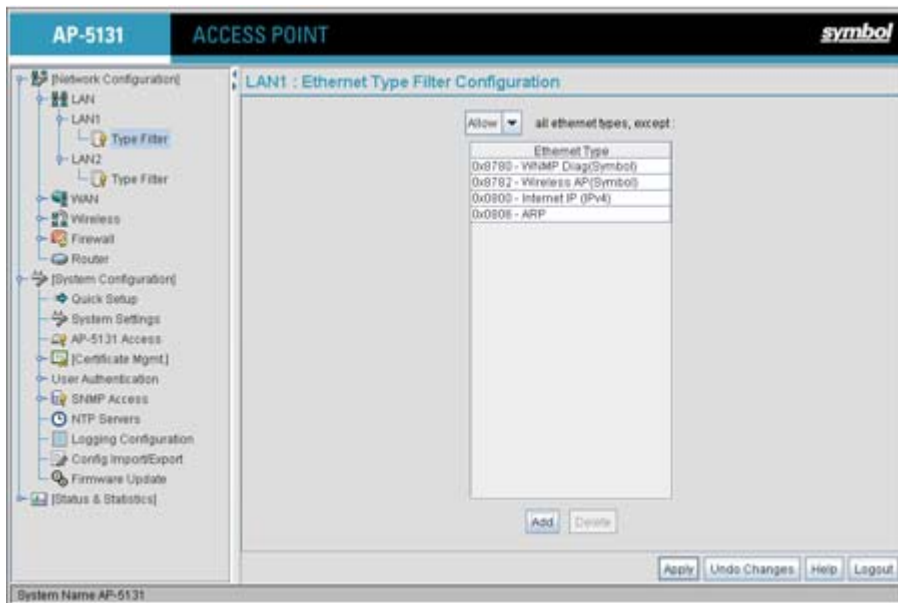

- Use the **all ethernet types, except** drop-down menu to designate whether the Ethernet Types defined for the LAN are allowed or denied for use by the AP-5131.

- To add an Ethernet type, click the **Add** button.

The **Add Ethernet Type** screen displays. Use this screen to add one type filter option at a time, for a list of up to 16 entries.

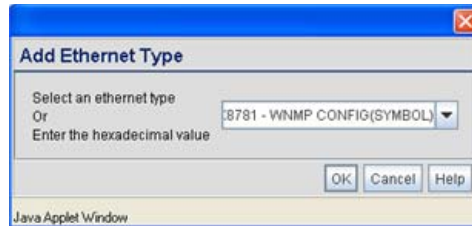

Packet types supported for the type filtering function include 16-bit DIX Ethernet types as well as Symbol proprietary types. Select an Ethernet type from the drop down menu, or enter the Ethernet type's hexadecimal value. Consult with your System Administrator if unsure of the implication of adding or omitting a type from the list for either LAN1 or LAN2.

- To optionally delete a type filtering selection from the list, highlight the packet type and click the **Delete** button.
- Click **Apply** to save any changes to the LAN1 or LAN2 Ethernet Type Filter Configuration screen. Navigating away from the screen without clicking Apply results in all changes to the screens being lost.
- Click **Cancel** to securely exit the LAN1 or LAN2 Ethernet Type Filter Configuration screen without saving your changes.
- Click **Logout** to securely exit the AP-5131 Symbol Access Point applet. A prompt displays confirming the logout before the applet is closed.

5.2 Configuring WAN Settings

A *Wide Area Network (WAN)* is a widely dispersed telecommunications network. The AP-5131 includes one WAN port. The AP-5131 WAN port has its own MAC address. In a corporate environment, the WAN port might connect to a larger corporate network. For a small business, the WAN port might connect to a DSL or cable modem to access the Internet.

Use the **WAN** screen to set the WAN IP configuration and *Point-to-Point Protocol over Ethernet (PPPoE)* parameters.

To configure WAN settings for the AP-5131:

1. Select **Network Configuration** -> **WAN** from the AP-5131 menu tree.

2. Refer to the **WAN IP Configuration** field to enable the WAN interface, and set network address information for the WAN connection.



NOTE Symbol recommends that the WAN and LAN ports should not both be configured as DHCP clients.

Enable WAN Interface Select the **Enable WAN Interface** checkbox to enable a connection between the AP-5131 and a larger network or outside world through the WAN port.

Disable this option to effectively isolate the AP-5131's WAN. No connections to a larger network or the Internet are possible. MUs cannot communicate beyond the LAN.

<i>This interface is a DHCP Client</i>	<p>This checkbox enables DHCP for the AP-5131 WAN connection. This is useful, if the larger corporate network or <i>Internet Service Provider (ISP)</i> uses DHCP.</p> <p>DHCP is a protocol that includes mechanisms for IP address allocation and delivery of host-specific configuration parameters from a DHCP server to a host. Some of these parameters are IP address, network mask, and gateway.</p> <p>If DHCP client mode is enabled, the other WAN IP configuration parameters are grayed out.</p>
<i>IP Address</i>	<p>Specify a numerical (non DNS name) IP address for the AP-5131's WAN connection. This address defines the AP's presence on a larger network or on the Internet.</p> <p>Obtain a static (dedicated) IP address from the ISP or network administrator. An IP address uses a series of four numbers expressed in dot notation, for example, 190.188.12.1.</p>
<i>Subnet Mask</i>	<p>Specify a subnet mask for the AP-5131's WAN connection. This number is available from the ISP for a DSL or cable-modem connection, or from an administrator if the AP-5131 connects to a larger network.</p> <p>A subnet mask uses a series of four numbers expressed in dot notation (similar to an IP address). For example, 255.255.255.0 is a valid subnet mask.</p>
<i>Default Gateway</i>	<p>Specify the gateway address for the AP-5131's WAN connection. The ISP or a network administrator provides this address.</p>
<i>Primary DNS Server</i>	<p>Specify the address of a primary <i>Domain Name System (DNS)</i> server. The ISP or a network administrator provides this address.</p> <p>A DNS server translates a domain name (for example, www.symboltech.com) into an IP address that networks can use.</p>
<i>Secondary DNS Server</i>	<p>Specify the address of a secondary DNS server if one is used. A secondary address is recommended if the primary DNS server goes down.</p>

More IP Addresses Click the **More IP Addresses** button to specify additional static IP addresses for the AP-5131. Additional IP addresses are required when users within the WAN need dedicated IP addresses, or when servers need to be accessed (addressed) by the outside world. The More IP Addresses screen allows the administrator to enter up to seven additional WAN IP addresses for the AP-5131 WAN. Only numeric, non-DNS names can be used.

If PPP over Ethernet is enabled from within the WAN screen, the **VPN WAN IP Configuration** portion of the More IP Addresses screen is enabled. Enter the IP address and subnet mask used to provide the PPPoE connection over the AP-5131's WAN port. Ensure the IP address is a numerical (non DNS) name.

Refresh Click the **Refresh** button to update the network address information displayed within the WAN IP Configuration field.

3. Configure the **PPP over Ethernet** field to enable high speed dial-up connections to the AP-5131 WAN port.

Enable Use the checkbox to enable *Point-to-Point over Ethernet (PPPoE)* for a high-speed connection that supports this protocol. Most DSL providers are currently using or deploying this protocol. PPPoE is a data-link protocol for dialup connections. PPPoE allows a host PC to use a broadband modem (DSL) for access to high-speed data networks.

Username Specify a username entered when connecting to the ISP. When the Internet session begins, the ISP authenticates the username.

Password Specify a password entered when connecting to the ISP. When the Internet session starts, the ISP authenticates the password.

PPPoE State Displays the current connection state of the PPPoE client. When a PPPoE connection is established, the status displays **Connected**. When no PPPoE connection is active, the status displays **Disconnected**.

Keep-Alive Select the **Keep-Alive** checkbox to maintain the AP-5131 WAN connection indefinitely (no timeout interval). Some ISPs terminate inactive connections. Enabling Keep-Alive keeps the AP-5131 WAN connection active, even when there is no traffic. If the ISP drops the connection after an idle period, the AP-5131 automatically re-establishes the connection to the ISP. Enabling Keep-Alive mode disables (grays out) the **Idle Time** field.

Idle Time (seconds) Specify an idle time in seconds to limit how long the AP-5131's WAN connection remains active after outbound and inbound traffic is not detected. The Idle Time field is grayed out if **Keep-Alive** is enabled.

Authentication Type Use the **Authentication Type** menu to specify the authentication protocol(s) for the WAN connection. Choices include *None*, *PAP* or *CHAP*, *PAP*, or *CHAP*.

Password Authentication Protocol (PAP) and Challenge Handshake Authentication Protocol (CHAP) are competing identify-verification methods.

PAP sends a username and password over a network to a server that compares the username and password to a table of authorized users. If the username and password are matched in the table, server access is authorized. WatchGuard products do not support the PAP protocol because the username and password are sent as clear text that a hacker can read.

CHAP uses secret information and mathematical algorithms to send a derived numeric value for login. The login server knows the secret information and performs the same mathematical operations to derive a numeric value. If the results match, server access is authorized. After login, one of the numbers in the mathematical operation is changed to secure the connection. This prevents any intruder from trying to copy a valid authentication session and replaying it later to log in.

4. Click **Apply** to save any changes to the WAN screen. Navigating away from the screen without clicking the Apply button results in all changes to the screen being lost.
5. Click **Undo Changes** (if necessary) to undo any changes made. Undo Changes reverts the settings displayed on the WAN screen to the last saved configuration.
6. Click **Logout** to securely exit the AP-5131 Symbol Access Point applet. A prompt displays confirming the logout before the applet is closed.

5.2.1 Configuring Network Address Translation (NAT) Settings

Network Address Translation (NAT) converts an IP address in one network to a different IP address or set of IP addresses in another network. The AP-5131 router maps its local (inside) network addresses to WAN (outside) IP addresses, and translates the WAN IP addresses on incoming packets to local IP addresses. NAT is useful because it allows the authentication of incoming and outgoing requests, and minimizes the number of WAN IP addresses needed when a range of local IP addresses is mapped to each WAN IP address. NAT can be applied in one of two ways:

- One-to-one mapping with a private side IP address
The private side IP address can belong to any of the private side subnets.
- One-to-many mapping with a configurable range of private side IP addresses
Ranges can be specified from each of the private side subnets.

Use the **NAT** screen to configure IP address mappings. To configure IP address mappings for the AP-5131:

1. Select **Network Configuration** -> **WAN** -> **NAT** from the AP-5131 menu tree.

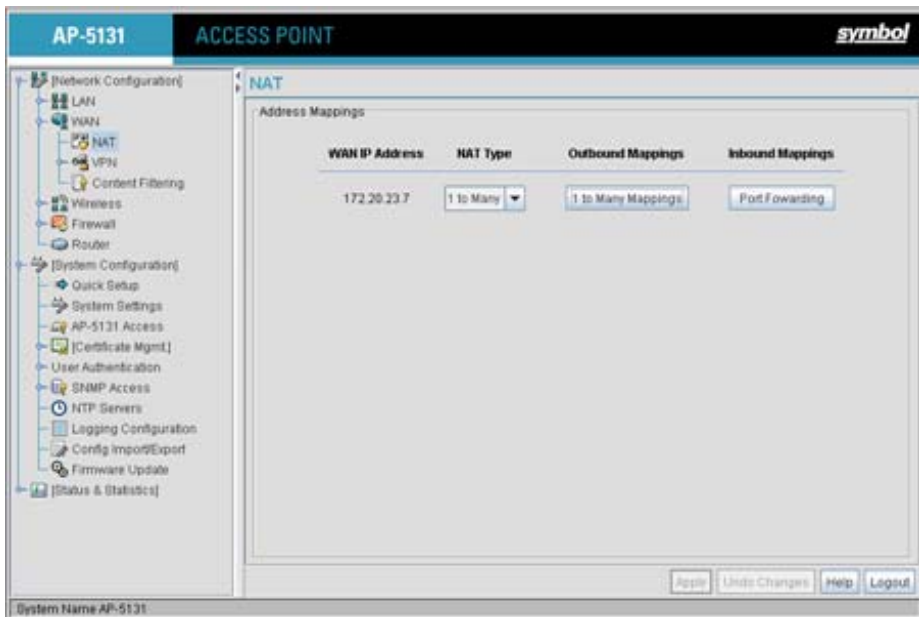

2. Configure the **Address Mappings** field to generate a WAN IP address, define the NAT type and set outbound/inbound NAT mappings.

<i>WAN IP Address</i>	The WAN IP addresses on the NAT screen are dynamically generated from address settings applied on the WAN screen.
<i>NAT Type</i>	<p>Specify the NAT Type as 1 to 1 to map a WAN IP address to a single host (local) IP address. 1 to 1 mapping is useful when users need dedicated addresses, and for public-facing servers connected to the AP-5131.</p> <p>Set the NAT Type as 1 to Many to map a WAN IP address to multiple local IP addresses. This displays the 1 to Many Mappings button in the adjacent Outbound Mappings field. This button displays a screen for mapping the LAN IP addresses that are associated with each subnet.</p> <p>Define the NAT Type as none when routable IP addresses are used on the internal network.</p>
<i>Outbound Mappings</i>	<p>When 1 to 1 NAT is selected, a single IP address can be entered in the Outbound Mappings area. This address provides a 1 to 1 mapping of the WAN IP address to the specified IP address.</p> <p>When 1 to Many is selected as the NAT Type, the Outbound Mappings area displays a 1 to Many Mappings button. Click the button to select the LAN1 or LAN2 IP address used to set the outbound IP address or select none to exclude the IP address.</p> <p>If none is selected as the NAT Type, The Outbound Mappings area is blank.</p>
<i>Inbound Mappings</i>	When 1 to 1 or 1 to Many is selected, the Inbound Mappings option displays a Port Forwarding button.
<i>Port Forwarding</i>	Click the Port Forwarding button to display a screen of port forwarding parameters for inbound traffic from the associated WAN IP address. for information on configuring port forwarding, see Configuring Port Forwarding on page 5-21 .

3. Click **Apply** to save any changes to the NAT screen. Navigating away from the screen without clicking the Apply button results in all changes to the screens being lost.
4. Click **Undo Changes** (if necessary) to undo any changes made. Undo Changes reverts the settings displayed on the NAT screen to the last saved configuration.

- Click **Logout** to securely exit the AP-5131 Symbol Access Point applet. A prompt displays confirming the logout before the applet is closed.

5.2.1.1 Configuring Port Forwarding

Use the **Port Forwarding** screen to configure port forwarding parameters for inbound traffic from the associated WAN IP address.

To configure port forwarding for the AP-5131:

- Select **Network Configuration -> WAN -> NAT** from the AP-5131 menu tree.
- Select **1 to 1** or **1 to Many** from the NAT Type drop-down menu.
- Click on the **Port Forwarding** button within the **Inbound Mappings** area.

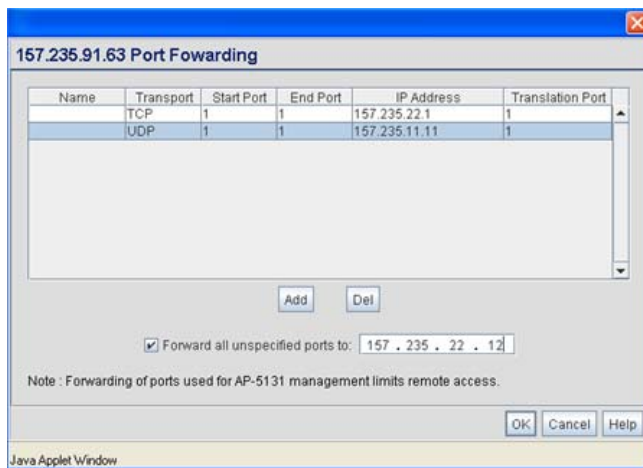

- Configure the **Port Forwarding** screen to modify the following:

- Add* Click **Add** to create a local map that includes the name, transport protocol, start port, end port, IP address and Translation Port for incoming packets.
- Delete* Click **Delete** to remove a selected local map entry.
- Name* Enter a name for the service being forwarded. The name can be any alphanumeric string and is used for identification of the service.

<i>Transport</i>	Use the Transport pull-down menu to specify the transport protocol used in this service. The choices are <i>ALL</i> , <i>TCP</i> , <i>UDP</i> , <i>ICMP</i> , <i>AH</i> , <i>ESP</i> , and <i>GRE</i> .
<i>Start Port and End Port</i>	Enter the port or ports used by the port forwarding service. To specify a single port, enter the port number in the Start Port area. To specify a range of ports, use both the Start Port and End Port options to enter the port numbers. For example, enter 110 in the Start Port field and 115 in the End Port field.
<i>IP Address</i>	Enter the numerical (non DNS name) IP address to which the specified service is forwarded. This address must be within the specified NAT range for the associated WAN IP address.
<i>Translation Port</i>	Specify the port number used to translate data for the service being forwarded.
<i>Forward all unspecified ports to</i>	Use the Forward all unspecified ports to checkbox to enable port forwarding for incoming packets with unspecified ports. In the adjacent area, enter a target forwarding IP address for incoming packets. This number must be within the specified NAT range for the associated WAN IP address.

- Click **Ok** to return to the NAT screen. Within the NAT screen, click **Apply** to save any changes made on the Port Forwarding screen.
- Click **Cancel** to undo any changes made on Port Forwarding screen. This reverts all settings for the Port Forwarding screen to the last saved configuration.

5.3 Enabling Wireless LANs (WLANs)

A *Wireless Local Area Network (WLAN)* is a data-communications system that flexibly extends the functionalities of a wired LAN. A WLAN does not require lining up devices for line-of-sight transmission, and are thus, desirable. Within the WLAN, roaming users can be handed off from one AP-5131 to another like a cellular phone system. WLANs can therefore be configured around the needs of specific groups of users, even when they are not in physical proximity.

Use the AP-5131's **Wireless Configuration** screen to create new WLANs, edit the properties of existing WLANs or delete a WLAN to create space for a new WLAN. Sixteen WLANs are available on the AP-5131 (regardless of single or dual-radio model).

To configure WLANs on the AP-5131:

1. Select **Network Configuration** -> **Wireless** from the AP-5131 menu tree.

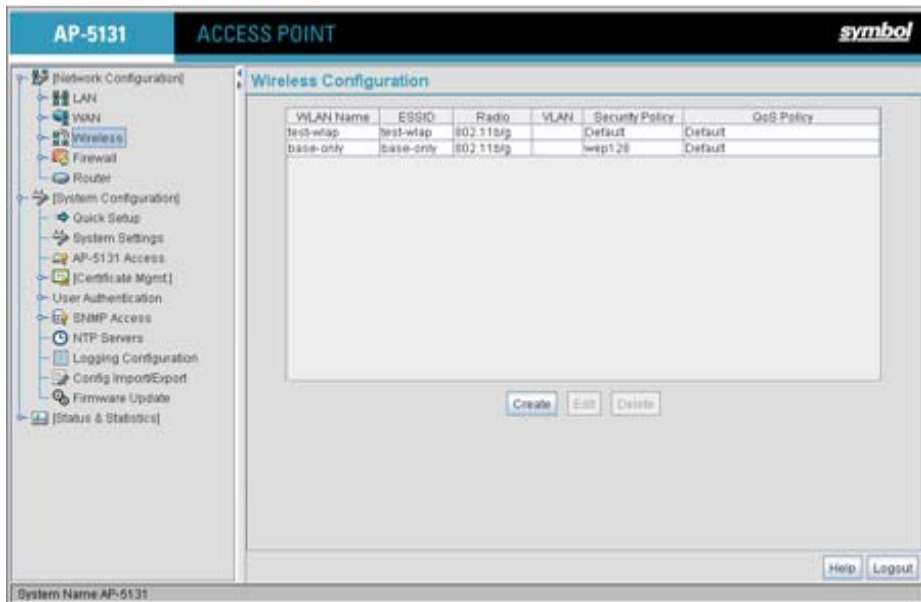

If a WLAN is defined, that WLAN displays within the Wireless Configuration screen. When the AP-5131 is first booted, WLAN1 exists as a default WLAN available immediately for connection.

2. Refer to the information within the Wireless Configuration screen to view the name, ESSID, AP-5131 radio designation, VLAN ID and security policy of existing WLANs.

WLAN Name The **Name** field displays the name of each WLAN that has been defined. The WLAN names can be modified within individual WLAN configuration screens. See [Creating/Editing Individual WLANs on page 5-24](#) to change the name of a WLAN.

ESSID Displays the *Extended Services Set Identification (ESSID)* associated with each WLAN. The ESSID can be modified within individual WLAN configuration screens. See [Creating/Editing Individual WLANs on page 5-24](#) to change the ESSID of a specific WLAN.

- | | |
|------------------------|--|
| <i>Radio</i> | The Radio field displays the name of the AP-5131 radio the WLAN is mapped to (either the 802.11a radio or the 802.11b/g radio). To change the radio designation for a specific WLAN, see Creating/Editing Individual WLANs on page 5-24 . |
| <i>VLAN</i> | The VLAN field displays the specific VLAN the target WLAN is mapped to. For information on VLAN configuration for the WLAN, see Configuring VLAN Support on page 5-4 . |
| <i>Security Policy</i> | The Security Policy field displays the security profile configured for the target WLAN. For information on configuring security for a WLAN, see Enabling Authentication and Encryption Schemes on page 6-5 . |
| <i>QoS Policy</i> | The QoS Policy field displays the quality of service currently defined for the WLAN. This policy outlines which data types receive priority for the user base comprising the WLAN. For information on QoS configuration for the WLAN, see Setting the WLAN Quality of Service (QoS) Policy on page 5-34 . |
3. Click the **Create** button (if necessary) to launch the **New WLAN** screen. Use the New WLAN screen to define the properties of a new WLAN that would display and be selectable within the **Wireless Configuration** screen. For additional information, see [Creating/Editing Individual WLANs on page 5-24](#).
 4. Click the **Edit** button (if necessary) to launch the **Edit WLAN** screen. Use the Edit WLAN screen to revise the properties of an existing WLAN that would continue display and be selectable within the **Wireless Configuration** screen. For additional information, see [Creating/Editing Individual WLANs on page 5-24](#).
 5. Consider using the **Delete** button to remove an existing WLAN if it has become outdated and is no longer required or if you are coming close the maximum 16 WLANs available per AP-5131.
 6. Click **Logout** to securely exit the AP-5131 Symbol Access Point applet. A prompt displays confirming the logout before the applet is closed.

5.3.1 Creating/Editing Individual WLANs

If the WLANs displayed within the **Wireless Configuration** screen do not satisfy your network requirements, you can either create a new WLAN or edit the properties of an existing WLAN.



NOTE Before editing the properties of an existing WLAN, ensure it is not being used by an AP-5131 radio, or is a WLAN that is needed in its current configuration. Once updated, the previous configuration is not available unless saved.

Use the New WLAN and Edit WLAN screens as required to create/modify a WLAN. To create a new WLAN or edit the properties of an existing WLAN:

1. Select **Network Configuration** -> **Wireless** from the AP-5131 menu tree.
The Wireless Configuration screen displays.
2. Click the **Create** button to configure a new WLAN, or highlight a WLAN and click the **Edit** button to modify an existing WLAN. Either the **New WLAN** or **Edit WLAN** screen displays.

New WLAN

Configuration

ESSID: 102

Name: five hole

Available On: 802.11a Radio
 802.11b/g Radio

Maximum MUs: 50

Enable Client Bridge Backhaul

Enable Hotspot [Configure Hotspot](#)

Security

Security Policy: Default [Create](#)

MU Access Control: Default [Create](#)

Kerberos User Name: 102

Kerberos Password:

Advanced

Disallow MU To MU Communication

Use Secure Beacon

Accept Broadcast ESSID

Quality Of Service Policy: Default [Create](#)

[Apply](#) [Cancel](#) [Help](#)

Java Applet Window

Edit WLAN

Configuration

ESSID: 103

Name: cross check

Available On: 802.11a Radio
 802.11b/g Radio

Maximum MUs: 40

Enable Client Bridge Backhaul

Enable Hotspot [Configure Hotspot](#)

Security

Security Policy: Default [Create](#)

MU Access Control: Default [Create](#)

Kerberos User Name: 103

Kerberos Password:

Advanced

Disallow MU To MU Communication

Use Secure Beacon

Accept Broadcast ESSID

Quality Of Service Policy: Default [Create](#)

[Apply](#) [Cancel](#) [Help](#)

Java Applet Window

- Set the parameters in the **Configuration** field as required for the WLAN.

ESSID

Enter the *Extended Services Set Identification (ESSID)* associated with the WLAN. The WLAN name is auto-generated using the ESSID until changed by the user. The maximum number of characters that can be used for the ESSID is 32.

<i>Name</i>	Define or revise the name for the WLAN. The name should be logical representation of WLAN coverage area (engineering, marketing etc.). The maximum number of characters that can be used for the name is 31.
<i>Available On</i>	Use the Available On checkboxes to define whether the WLAN you are creating or editing is available to clients on either the 802.11a or 802.11b/g radio (or both radios). The Available On checkbox should only be selected for a mesh WLAN if this target AP-5131 is to be configured as a base bridge or repeater (base and client bridge) on the radio. If the radio for the WLAN is to be defined as a client bridge only, the Available On checkbox should not be selected. For more information on defining a WLAN for mesh support, see Configuring a WLAN for Mesh Networking Support on page 9-7 .
<i>Max MUs</i>	Use the Max MUs field to define the number of MUs permitted to interoperate within the new or revised WLAN. The maximum (and default) is 127. However, each AP-5131 can only support a maximum 127 MUs spanned across its 16 available WLANs. If you intend to define numerous WLANs, ensure each is using a portion of the 127 available MUs and the sum of the supported MUs across all WLANs does not exceed 127.
<i>Enable Client Bridge Backhaul</i>	Select the Enable Client Bridge Backhaul checkbox to make the WLAN available in the WLAN drop-down menu within the Radio Configuration screen. This checkbox can be ignored for WLANs not supporting mesh networking, to purposely exclude them from the list of WLANs available in the Radio Configuration page selected specifically for mesh networking support. Only WLANs defined for mesh networking support should have this checkbox selected.
<i>Enable Hotspot</i>	Select the Enable Hotspot checkbox to allow this WLAN (whether it be a new or existing WLAN) to be configured for hotspot support. Clicking the Configure Hotspot button launches a screen wherein the parameters of the hotspot can be defined. For information on configuring a target WLAN for hotspot support, see Configuring WLAN Hotspot Support on page 5-40 . For an overview of what a hotspot is and what it can provide your wireless network, see Hotspot Support on page 1-4 .



CAUTION A WLAN cannot be enabled for both mesh and hotspot support at the same time. Only one of these two options can be enabled at one time, as the AP-5131 GUI and CLI will prevent both from being enabled.



NOTE If 802.11a is selected as the radio used for the WLAN, the WLAN cannot use a Kerberos supported security policy.

4. Configure the **Security** field as required to set the data protection requirements for the WLAN.



NOTE A WLAN configured to support Mesh should not have a Kerberos or 802.1x EAP security policy defined for it, as these two authentication schemes are not supported within an AP-5131 Mesh network.

Security Policy Use the scroll down **Security Policies** menu to select the security scheme best suited for the new or revised WLAN. Click the **Create** button to jump to the New Security Policy screen where a new policy can be created to suit the needs of the WLAN. For more information, see [Configuring WLAN Security Policies on page 5-29](#).

MU Access Control Select an ACL policy suiting the WLAN's MU interoperability requirements from the drop-down menu. If the existing ACL policies do not satisfy the requirements of the WLAN, a new ACL policy can be created by pressing the **Create** button. For more information, see [Configuring a WLAN Access Control List \(ACL\) on page 5-31](#).

Kerberos User Name Displays the read-only Kerberos User Name used to associate the wireless client. This value is the ESSID of the AP-5131.

Kerberos Password Enter a Kerberos password if **Kerberos** has been selected as the security scheme from within the **Security Policies** field. The field is grayed out if Kerberos has not been selected for the WLAN. For information on configuring Kerberos, see [Configuring Kerberos Authentication on page 6-9](#).

5. Configure the **Advanced** field as required to set MU interoperability permissions, secure beacon transmissions, broadcast ESSID acceptance and *Quality of Service (QoS)* policies.

<i>Disallow MU to MU Communication</i>	The AP-5131's MU-MU Disallow feature prohibits MUs from communicating with each other even if they are on different WLANs, assuming one of the WLAN's is configured to disallow MU-MU communication. Therefore, if an MU's WLAN is configured for MU-MU disallow, it will not be able to communicate with any other MUs connected to this AP-5131.
<i>Use Secure Beacon</i>	Select the Use Secure Beacon checkbox to not transmit the AP-5131's ESSID. If a hacker tries to find an ESSID via an MU, the AP-5131's ESSID does not display since the ESSID is not in the beacon. Symbol recommends keeping the option enabled to reduce the likelihood of hacking into the WLAN.
<i>Accept Broadcast ESSID</i>	Select the Accept Broadcast ESSID checkbox to associate an MU that has a blank ESSID (regardless of which ESSID the AP-5131 is currently using). Sites with heightened security requirements may want to leave the checkbox unselected and configure each MU with an ESSID. The default is unselected, thus not allowing the acceptance of broadcast ESSIDs.
<i>Quality of Service Policy</i>	If QoS policies are undefined (none), select the Create button to launch the New QoS Policy screen. Use this screen to create a QoS policy, wherein data traffic for the new or revised WLAN can be prioritized to best suit the MU transmissions within that WLAN. For more information, see Setting the WLAN Quality of Service (QoS) Policy on page 5-34 .



CAUTION When using the AP-5131's hotspot functionality, ensure MUs are re-authenticated when changes are made to the characteristics of a hotspot enabled WLAN, as MUs within the WLAN will be dropped from AP-5131 device association.

- Click **Apply** to save any changes to the WLAN screen. Navigating away from the screen without clicking Apply results in all changes to the screens being lost.
- Click **Cancel** to securely exit the New WLAN or Edit WLAN screen and return to the Wireless Configuration screen.

5.3.1.1 Configuring WLAN Security Policies

As WLANs are being defined for an AP-5131, a security policy can be created or an existing policy edited (using the **Create** or **Edit** buttons within the **Security Configuration** screen) to best serve the

security requirements of the WLAN. Once new policies are defined, they are available within the **New WLAN** or **Edit WLAN** screens and can be mapped to any WLAN. A single security policy can be used by more than one WLAN if its logical to do so. For example, there may be two or more WLANs within close proximity of each other requiring the same data protection scheme.

To create a new security policy or modify an existing policy:

1. Select **Network Configuration** -> **Wireless** -> **Security** from the AP-5131 menu tree.

The **Security Configuration** screen appears with existing policies and their attributes displayed.



NOTE When the AP-5131 is first launched, a single security policy (default) is available and mapped to WLAN 1. It is anticipated numerous additional security policies will be created as the list of WLANs grows.

Configuring a WLAN security scheme with a discussion of all the authentication and encryption options available is beyond the scope of this chapter. See [Chapter 6, Configuring Access Point Security on page 6-1](#) for more details on configuring AP-5131 security.

For detailed information on the authentication and encryption options available to the AP-5131 and how to configure them, see to [Configuring Security Options on page 6-2](#) and locate the section that describes your intended security scheme.

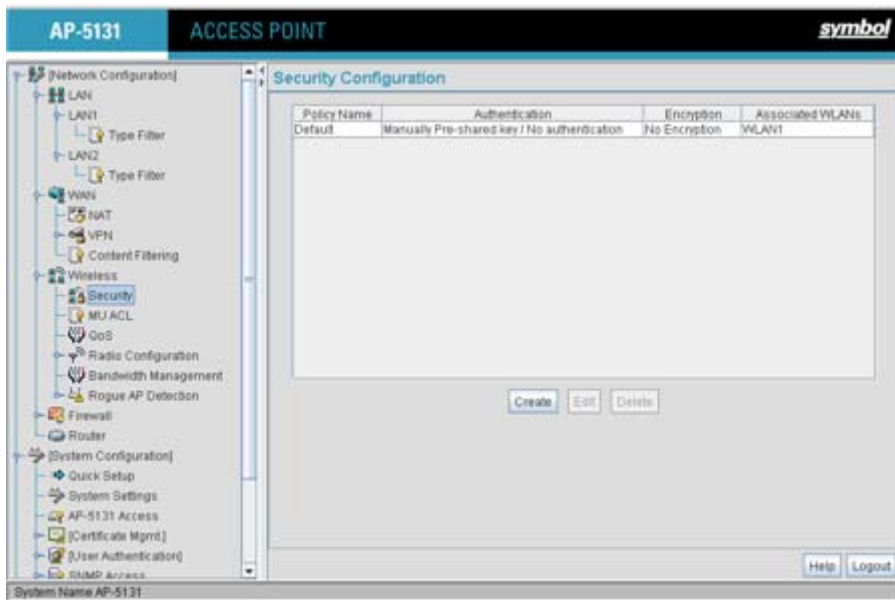

2. Click **Logout** to exit the Security Configuration screen.

5.3.1.2 Configuring a WLAN Access Control List (ACL)

An *Access Control Lists (ACL)* affords a system administrator the ability to grant or restrict MU access by specifying a MU MAC address or range of MAC addresses to either include or exclude from AP-5131 connectivity. Use the **Mobile Unit Access Control List Configuration** screen to create new ACL policies (using the **New MU ACL Policy** sub-screen) or edit existing policies (using the **Edit MU ACL Policy** sub-screen). Once new policies are defined, they are available for use within the **New WLAN** or **Edit WLAN** screens to assign to specific WLANs based on MU interoperability requirements.

Symbol recommends using the New MU ACL Policy or Edit MU ACL Policy screens strategically to name and configure ACL policies meeting the requirements of the particular WLANs they may map to. However, be careful not to name policies after specific WLANs, as individual ACL policies can be used by more than one WLAN. For detailed information on assigning ACL policies to specific WLANs, see [Creating/Editing Individual WLANs on page 5-24](#).

To create or edit ACL policies for WLANs:

1. Select **Network Configuration** -> **Wireless** -> **MU ACL** from the AP-5131 menu tree.

The **Mobile Unit Access Control List Configuration** screen displays with existing ACL policies and their current WLAN (if mapped to a WLAN).



NOTE When the AP-5131 is first launched, a single ACL policy (default) is available and mapped to WLAN 1. It is anticipated numerous additional ACL policies will be created as the list of WLANs grows.

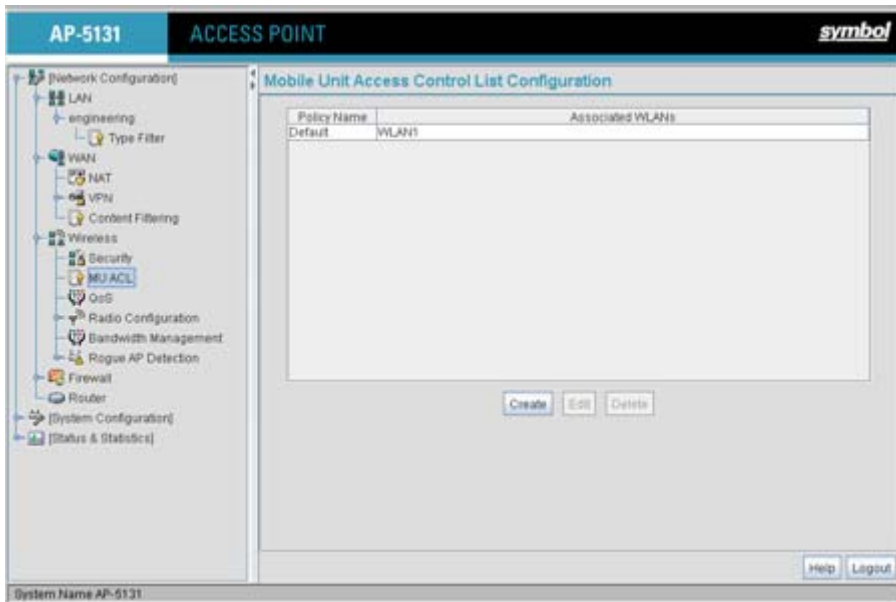

- Click the **Create** button to configure a new ACL policy, or select a policy and click the **Edit** button to modify an existing ACL policy. The AP-5131 supports a maximum of 16 MU ACL policies.

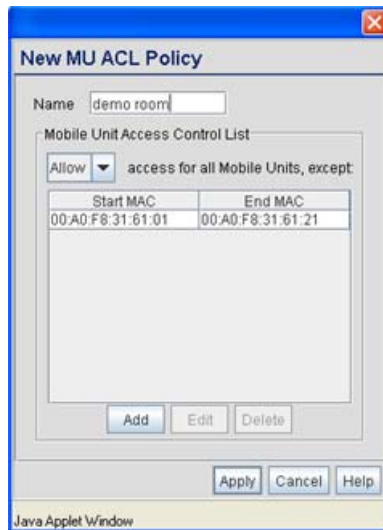

Either the **New MU ACL Policy** or **Edit MU ACL Policy** screens display.

3. Assign a name to the new or edited ACL policy that represents an inclusion or exclusion policy specific to a particular type of MU traffic you may want to use with a single or group of WLANs. More than one WLAN can use the same ACL policy.
4. Configure the parameters within the **Mobile Unit Access Control List** field to allow or deny MU access to the AP-5131.

The MU adoption list identifies MUs by their MAC address. The MAC address is the MU's unique *Media Access Control* number printed on the device (for example, 00:09:5B:45:9B:07) by the manufacturer. A maximum of 200 MU MAC addresses can be added to the New/Edit MU ACL Policy screen.

Access for the listed Mobile Units Use the drop-down list to select **Allow** or **Deny**. This rule applies to the MUs listed in the table. For example, if the adoption rule is to Allow, access is granted for all MUs except those listed in the table.

Add Click the **Add** button to create a new entry using only the **Start MAC** column to specify a MAC address, or uses both the **Start MAC** and **End MAC** columns to specify a range of MAC addresses.

Delete Click the **Delete** button to remove a selected list entry.

5. Click **Apply** to save any changes to the New MU ACL Policy or Edit MU ACL Policy screen and return to the Mobile Unit Access Control List Configuration screen. Navigating away from the screen without clicking Apply results in all changes to the screens being lost.
6. Click **Cancel** to securely exit the New MU ACL Policy or Edit MU ACL Policy screen and return to the Mobile Unit Access Control List Configuration screen.
7. Click **Logout** within the Mobile Unit Access Control List Configuration screen to securely exit the AP-5131 Symbol Access Point applet. A prompt displays confirming the logout before the applet is closed.

5.3.1.3 Setting the WLAN Quality of Service (QoS) Policy

The AP-5131 can keep a list of QoS policies that can be used from the **New WLAN** or **Edit WLAN** screens to map to individual WLANs. Use the **Quality of Service Configuration** screen to configure WMM policies that can improve the user experience for audio, video and voice applications by shortening the time between packet transmissions for higher priority (multimedia) traffic.

Use the **Quality of Service Configuration** screen to define the QoS policies for advanced network traffic management and multimedia applications support. If the existing QoS policies are insufficient, a new policy can be created or an existing policy can be modified using the **New QoS Policy** or **Edit QoS Policy** screens. Once new policies are defined, they are available for use within the **New WLAN** or **Edit WLAN** screens to assign to specific WLANs based on MU interoperability requirements.

Symbol recommends using the New QoS Policy and Edit QoS Policy screens strategically to name and configure QoS policies meeting the requirements of the particular WLANs they may map to. However, be careful not to name policies after specific WLANs, as individual QoS policies can be used by more than one WLAN. For detailed information on assigning QoS policies to specific WLANs, see [Creating/Editing Individual WLANs on page 5-24](#).

To configure QoS policies:

1. Select **Network Configuration** -> **Wireless** -> **QoS** from the AP-5131 menu tree.

The **Quality of Service Configuration** screen displays with existing QoS policies and their current WLAN (if mapped to a WLAN).



NOTE When the AP-5131 is first launched, a single QoS policy (default) is available and mapped to WLAN 1. It is anticipated additional QoS policies will be created as the list of WLANs grows.

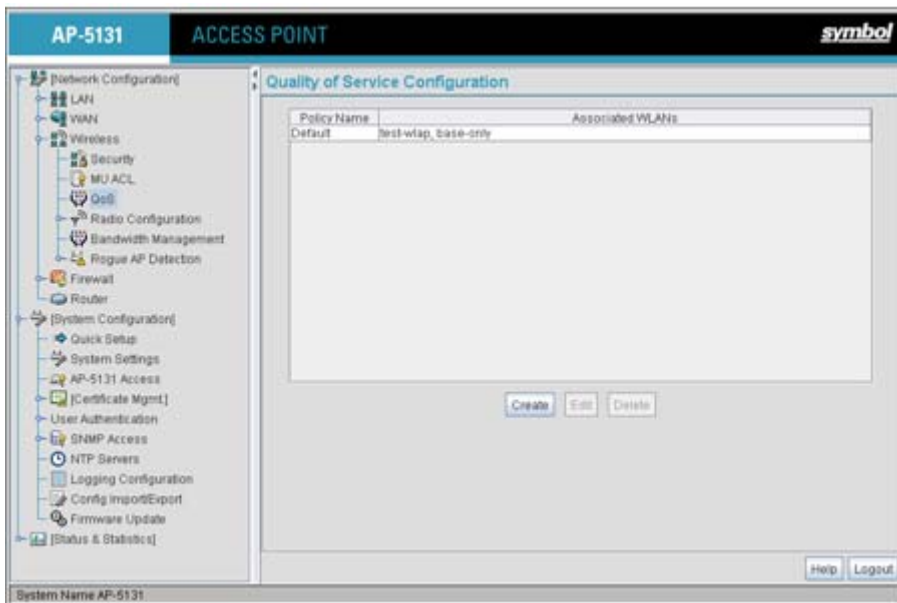

2. Click the **Create** button to configure a new QoS policy, or select a policy and click the **Edit** button to modify an existing QoS policy. The AP-5131 supports a maximum of 16 QoS policies.

New QoS Policy

Policy Name: demo room

Support Voice prioritization.

Multicast (Mask)Address1: : : : :
 Multicast (Mask)Address2: : : : :
 Enable Wi-Fi Multimedia (WMM) QoS Extensions 11ag-default

Access Category	CW Minimum	CW Maximum	AIFSN	TXOPs Time 32usec	TXOPs Time ms
Background	15	1023	7	0	0.0
Best Effort	15	255	3	20	0.64
Video	7	15	2	94	3.008
Voice	3	7	2	47	1.504

Apply Cancel Help

Java Applet Window

3. Assign a name to the new or edited QoS policy that makes sense to the AP-5131 traffic receiving priority. More than one WLAN can use the same QoS policy.
4. Select the **Support Voice prioritization** checkbox to allow legacy voice prioritization. Certain products may not receive priority over other voice or data traffic. Consequently, ensure the **Support Voice Prioritization** checkbox is selected if using products that do not support Wi-Fi Multimedia (WMM) to provide preferred queuing for these VOIP products. If the **Support Voice Prioritization** checkbox is selected, the AP-5131 will detect non-WMM capable (legacy) phones that connect to the AP-5131 and provide priority queuing for their traffic over normal data.



NOTE Wi-fi functionality requires that both the AP-5131 and its associated clients are WMM-capable and have WMM enabled. WMM enabled devices can take advantage of their QoS functionality only if using applications that support WMM, and can assign an appropriate priority level to the traffic streams they generate.

5. Use the two **Multicast Address** fields to specify one or two MAC addresses to be used for multicast applications. Some VoIP devices make use of multicast addresses. Using this mechanism ensures that the multicast packets for these devices are not delayed by the packet queue.
6. Use the drop-down menu to select the radio traffic best representing the network requirements of this WLAN. Options include:

<i>manual</i>	Select the manual option if intending to manually set the Access Categories for the radio traffic within this WLAN. Only advanced users should manually configure the Access Categories, as setting them inappropriately could negatively impact the AP-5131's performance.
<i>11ag - wifi</i>	Use this setting for high-end multimedia devices that using the AP-5131's high rate 802.11a or 802.11g radio.
<i>11b - wifi</i>	Use this setting for high-end devices multimedia devices that use the AP-5131's 802.11b radio.
<i>11ag - default</i>	Use this setting for typical "data-centric" MU traffic over the AP-5131's high rate 802.11a or 802.11g radio.
<i>11b - default</i>	Use this setting for typical "data-centric" MU traffic over the AP-5131's 802.11b radio.
<i>11ag voice</i>	Use this setting for "Voice-Over-IP" traffic over the AP-5131's high rate 802.11a or 802.11g radio.
<i>11b voice</i>	Use this setting for "Voice-Over-IP" traffic over the AP-5131's 802.11b radio.



CAUTION Symbol recommends using the drop-down menu to define the intended radio traffic within the WLAN. Once an option is selected, you do not need to adjust the values for the Access Categories. Unless qualified to do so, changing the Access Category default values could negatively impact the performance of the AP-5131.

7. Select the **Enable Wi-Fi Multimedia (WMM) QoS Extensions** checkbox to configure the AP-5131's QoS Access Categories. The Access Categories are not configurable unless the checkbox is selected. Access Categories include:

<i>Background</i>	Backgrounds traffic is typically of a low priority (file transfers, print jobs ect.). Background traffic typically does not have strict latency (arrival) and throughput requirements.
<i>Best Effort</i>	Best Effort traffic includes traffic from legacy devices or applications lacking QoS capabilities. Best Effort traffic is negatively impacted by data transfers with long delays as well as multimedia traffic.
<i>Video</i>	Video traffic includes music streaming and application traffic requiring priority over all other types of network traffic.
<i>Voice</i>	Voice traffic includes VoIP traffic and typically receives priority over Background and Best Effort traffic.

8. Configure the **CW min** and **CW max** (contention windows), **AIFSN** (*Arbitrary Inter-Frame Space Number*) and **TXOPs Time** (opportunity to transmit) for each Access Category. Their values are explained as follows.

<i>CW Min</i>	The contention window minimum value is the least amount of time the MU waits before transmitting when there is no other data traffic on the network. The longer the interval, the lesser likelihood of collision. This value should be set to a smaller increment for higher priority traffic. Reduce the value when traffic on the WLAN is anticipated as being smaller.
<i>CW Max</i>	The contention window maximum value is the maximum amount of time the MU waits before transmitting when there is no other data traffic on the network. The longer the interval, the lesser likelihood of collision, but the greater propensity for longer transmit periods.
<i>AIFSN</i>	The AIFSN is the minimum interframe space between data packets transmitted for the selected Access Category. This value should be set to a smaller increment for higher priority traffic to reduce packet delay time.
<i>TXOPs Time 32usec</i>	The TXOPs Time is the interval the transmitting MU is assigned for transmitting. The default for Background traffic is 0. The same TXOPs values should be used for either the AP-5131's 802.11a or 802.11b/g radio, there is no difference.

TXOPs Time ms TXOP times range from 0.2 ms (background priority) to 3 ms (video priority) in a 802.11a network, and from 1.2 ms to 6 ms in an 802.11b/g network. The TXOP bursting capability greatly enhances the efficiency for high data rate traffic such as streaming video

9. Click **Apply** to save any changes to the New QoS Policy or Edit QoS Policy screen to return to the Quality of Service Configuration screen. Navigating away from the screen without clicking Apply results in all changes to the screens being lost.
10. Click **Cancel** to securely exit the New QoS Policy or Edit QoS Policy screen to return to the Quality of Service Configuration screen.
11. Click **Logout** within the Quality of Service Configuration screen to securely exit the AP-5131 Symbol Access Point applet. A prompt displays confirming the logout before the applet is closed.

U-APSD (WMM Power Save) Support

With this latest release, the AP-5131 now supports *Unscheduled Automatic Power Save Delivery* (U-APSD), often referred to as WMM Power Save. U-APSD provides a periodic frame exchange between a voice capable MU and the AP-5131 during a VoIP call, while legacy power management is still utilized for typical data frame exchanges. The AP-5131 and its associated MU activate the new U-APSD power save approach when a VoIP traffic stream is detected. The MU then buffers frames from the voice traffic stream and sends a VoIP frame with an implicit "poll" request to its associated AP-5131. The AP-5131 responds to the poll request with buffered VoIP stream frame(s). When a voice-enabled MU wakes up at a designated VoIP frame interval, it sends a VoIP frame with an implicit "poll" request to its associated AP-5131. The AP -5131 responds to the poll request with buffered VoIP stream frame(s).



NOTE The AP-5131 ships with the U-APSD feature disabled by default. It is automatically enabled when WMM is enabled for a WLAN. Thus, U-APSD is only functional when WMM is enabled. If WMM is disabled, then U-APSD is disabled as well.

5.3.1.4 Configuring WLAN Hotspot Support

The AP-5131 enables hotspot operators to provide user authentication and accounting without a special client application. The AP-5131 uses a traditional Internet browser as a secure authentication device. Rather than rely on built-in 802.11 security features to control AP-5131 association privileges, configure a WLAN with no WEP (an open network). The AP-5131 issues an IP address to the user using a DHCP server, authenticates the user and grants the user to access the Internet.

When a user visits a public hotspot and wants to browse to a Web page, they boot up their laptop and associate with the local Wi-Fi network by entering the correct SSID. They then start a browser. The hotspot access controller forces this un-authenticated user to a Welcome page from the hotspot Operator that allows the user to login with a username and password.

The AP-5131 hotspot functionality requires the following:

- HTTP Redirection - Redirects unauthenticated users to a specific page specified by the Hotspot provider.
- User authentication - Authenticates users using a Radius server.
- Walled garden support - Enables a list of IP address (not domain names) to be accessed without authentication.
- Billing system integration - Sends accounting records to a Radius accounting server.



CAUTION When using the AP-5131's hotspot functionality, ensure MUs are re-authenticated when changes are made to the characteristics of a hotspot enabled WLAN, as MUs within the WLAN will be dropped from AP-5131 device association.

To configure hotspot functionality for an AP-5131 WLAN:

1. Ensure the **Enable Hotspot** checkbox is selected from within the target WLAN screen, and ensure the WLAN is properly configured.

Any of the sixteen WLANs on the AP-5131 can be configured as a hotspot. For hotspot enabled WLANs, DHCP, DNS, HTTP and HTTP-S traffic is allowed (before you login to the hotspot), while TCP/IP packets are redirected to the port on the subnet to which the WLAN is mapped. For WLANs that are not hotspot-enabled, all packets are allowed.

2. Click the **Configure Hotspot** button within the WLAN screen to display the **Hotspot Configuration** screen for that target WLAN.

3. Refer to the **HTTP Redirection** field to specify how the Login, Welcome, and Fail pages are maintained for this specific WLAN. The pages can be hosted locally or remotely.

Use Default Files Select the **Use Default Files** checkbox if the login, welcome and fail pages reside on the AP-5131.

Use External URL Select the **Use External URL** checkbox to define a set of external URLs for hotspot users to access the login, welcome and fail pages. To create a redirected page, you need to have a TCP termination locally. On receiving the user credentials from the login page, the AP-5131 connects to a radius server, determines the identity of the connected wireless user and allows the user to access the Internet based on successful authentication.

4. Use the **External URL** field to specify the location of the login page, welcome page and fail page used for hotspot access. Defining these settings is required when the **Use External URL** checkbox has been selected within the HTTP Redirection field.

Login Page URL Define the complete URL for the location of the Login page. The Login screen will prompt the hotspot user for a username and password to access the Welcome page.

Welcome Page URL Define the complete URL for the location of the Welcome page. The Welcome page asserts the hotspot user has logged in successfully and can access the Internet.

Fail Page URL Define the complete URL for the location of the Fail page. The Fail screen asserts the hotspot authentication attempt failed, you are not allowed to access the Internet and you need to provide correct login information to access the Internet.

5. Click the **White List Entries** button (within the **WhiteList Configuration** field) to create a set of allowed destination IP addresses. These allowed destination IP addresses are called a White List. Ten configurable IP addresses are allowed for each WLAN. For more information, see [Defining the Hotspot White List on page 5-43](#).
6. Refer to the **Radius Accounting** field to enable Radius accounting and specify the a timeout and retry value for the Radius server.

Enable Accounting Select the **Enable Accounting** checkbox to enable a Radius Accounting Server used for Radius authentication for a target hotspot user.

Server Address Specify an IP address for the external Radius Accounting server used to provide Radius accounting for the hotspot. If using this option, an internal Radius server cannot be used. The IP address of the internal Radius server is fixed at 127.0.0.1 and cannot be used for the external Radius server.

Radius Port Specify the port on which the Radius accounting server is listening.

Shared Secret Specify a shared secret for accounting authentication for the hotspot. The shared secret is required to match the shared secret on the external Radius accounting server.

Timeout Set the timeout value in seconds (1-255) used to timeout users accessing the Radius Accounting server if they have not successfully accessed the Accounting Server.

Retries Define the number of retries (1-10) the user is allowed to access the Radius Accounting Server if the first attempt fails. The default is 1.

7. Refer to the **Radius Configuration** field to define a primary and secondary Radius server port and shared secret password.

- | | |
|----------------------|--|
| <i>Select mode</i> | Use the Select mode drop-down menu to define whether an Internal or External server is to be used for the primary server. |
| <i>Pri Server IP</i> | Define the IP address of the primary Radius server. This is the address of your first choice for Radius server. |
| <i>Pri Port</i> | Enter the TCP/IP port number for the server acting as the primary Radius server. The default port is 1812. |
| <i>Pri Secret</i> | Enter the shared secret password used with the primary Radius Server. |
| <i>Sec Server IP</i> | Define the IP address of the secondary Radius server. This is the address of your second choice for Radius server. |
| <i>Sec Port</i> | Enter the TCP/IP port number for the server acting as the secondary Radius server. The default port is 1812. |
| <i>Sec Secret</i> | Enter the shared secret password used with the secondary Radius Server. |
8. Click **OK** to save any changes to the Hotspot Configuration screen. Navigating away from the screen without clicking Apply results in all changes to the screens being lost.
 9. Click **Cancel** (if necessary) to undo any changes made. Cancel reverts the settings displayed on the Hotspot Configuration screen to the last saved configuration.

Defining the Hotspot White List

To host a Login, Welcome or Fail page on the external Web server, the IP address of that Web server should be in AP-5131's White List.

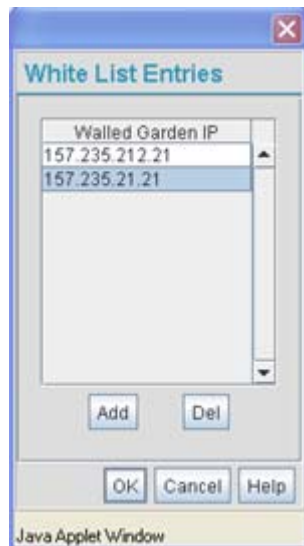

When a client requests a URL from a Web server, the login handler returns an HTTP redirection status code (for example, 301 Moved Permanently), which indicates to the browser it should look for the page at another URL. This other URL can be a local or remote login page (based on the hotspot configuration). The login page URL is specified in the location's HTTP header.

To host a Login page on the external Web server, the IP address of the Web server should be in the White list (list of IP addresses allowed to access the server) configuration. Ensure the Login page is designed so the submit action always posts the login data on the AP-5131.

To define the White List for a target WLAN:

1. Click the **White List Entries** button from within the WLAN's Hotspot Config screen.
2. Click the **Add** button to define an IP address for an allowed destination IP address.
3. Select a White List entry and click the **Del** button to remove the address from the White List.
4. Click **OK** to return to the Hotspot Config screen where the configuration can be saved by clicking the Apply button.

Now user enters his/her credentials on Login page and submits the page to AP5131. Login Handler will execute a CGI script, which will use this data as input.

5. Click **Cancel** to return to the Hotspot Config screen without saving any of the White List entries defined within the White List Entries screen.

5.3.2 Setting the WLAN's Radio Configuration

Each AP-5131 WLAN can have a separate 802.11a or 802.11b/g radio configured and mapped to that WLAN. The first step is to enable the radio.

One of two possible radio configuration pages are available on the AP-5131 depending on which model SKU is purchased. If the AP-5131 is a single-radio model, the **Radio Configuration** screen enables you to configure the single radio for either 802.11a or 802.11b/g use. The Radio Configuration screen contains two radio buttons whose selection is mutually exclusive.

If the AP-5131 is a dual-radio model, the **Radio Configuration** screen enables you to configure one radio for 802.11a use and the other for 802.11b/g (no other alternatives exist for the dual-radio model). Using a dual-radio AP-5131, individual 802.11a and 802.11b/g radios can be enabled or disabled using the Radio Configuration screen checkboxes.



NOTE This section describes mesh networking (setting the radio's base and client bridge configuration) at a high level. For a detailed overview on the theory of mesh networking, see [Mesh Networking Overview on page 9-1](#). For detailed information on the implications of setting the mesh network configuration, see [Configuring Mesh Networking Support on page 9-5](#). To review a use case on mesh networking, see [Usage Scenario - Trion Enterprises on page 9-15](#).

The Radio Configuration screen displays with two tabs. One tab each for the AP-5131's radios. Verify both tabs are selected and configured separately to enable the radio(s), and set their mesh networking definitions.

To set the AP-5131 radio configuration (this example is for a dual-radio AP-5131):

1. Select **Network Configuration** -> **Wireless** -> **Radio Configuration** from the AP-5131 menu tree.

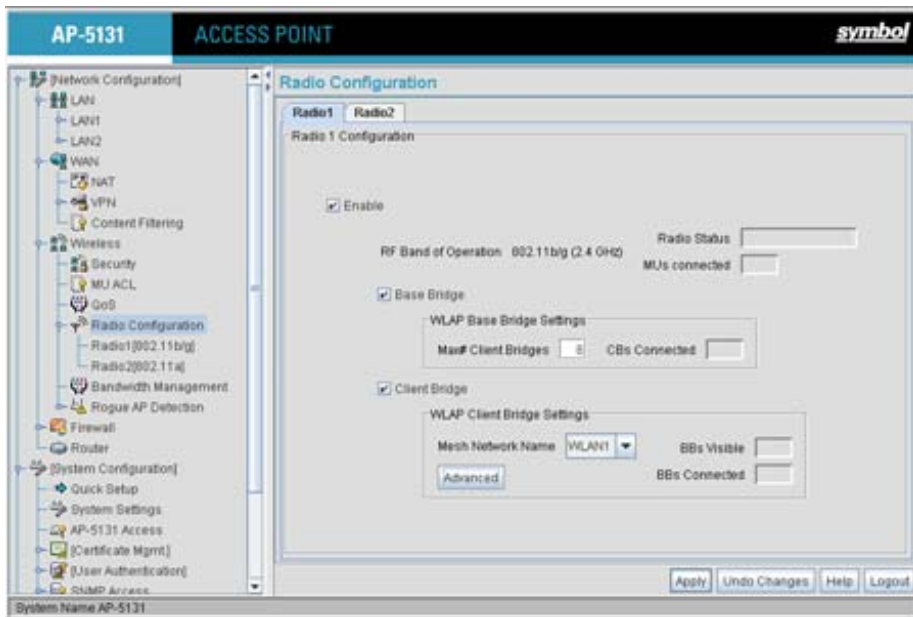

2. Enable the radio(s) using the **Enable** checkbox(es).

Refer to **RF Band of Operation** parameter to ensure you are enabling the correct 802.11a or 802.11b/g radio. After the settings are applied within this Radio Configuration screen, the **Radio Status** and **MUs connected** values update. If this is an existing radio within a mesh network, these values update in real-time.



CAUTION If a radio is disabled, be careful not to accidentally configure a new WLAN, expecting the radio to be operating when you have forgotten it was disabled.

3. Select the **Base Bridge** checkbox to allow the AP-5131 radio to accept client bridge connections from other AP-5131s in client bridge mode. The base bridge is the acceptor of mesh network data from those client bridges within the mesh network and never the initiator.
4. If the Base Bridge checkbox has been selected, use the **Max# Client Bridges** parameter to define the client bridge load on a particular base bridge.

The maximum number of client bridge connections per AP-5131 radio is 12, with 24 representing the maximum for dual-radio models.



CAUTION An AP-5131 in Base Bridge mode logs out whenever a Client Bridge associates to the Base Bridge over the LAN connection. This problem is not experienced over the AP-5131's WAN connection. If this situation is experienced, log-in to the AP-5131 again.

Once the settings within the Radio Configuration screen are applied (for an initial deployment), the current number of client bridge connections for this specific radio displays within the **CBs Connected** field. If this is an existing radio within a mesh network, this value updates in real-time.



CAUTION A problem could arise if a Base Bridge's Indoor channel is not available on an Outdoor Client Bridge's list of available channels. As long as an Outdoor Client Bridge has the Indoor Base Bridge channel in its available list of channels, it can associate to the Base Bridge.

5. Select the **Client Bridge** checkbox to enable the AP-5131 radio to initiate client bridge connections with other mesh network supported AP-5131s using the same WLAN.

If the Client Bridge checkbox has been selected, use the **Mesh Network Name** drop-down menu to select the WLAN (ESS) the client bridge uses to establish a wireless link. The default setting, is (WLAN1). Symbol recommends creating (and naming) a WLAN specifically for mesh networking support to differentiate the Mesh supported WLAN from non-Mesh supported WLANs.



CAUTION An AP-5131 in client bridge mode cannot use a WLAN configured with a Kerberos or EAP 802.1x based security scheme, as these authentication types secure user credentials not the mesh network itself.



NOTE Ensure you have verified the radio configuration for both Radio 1 and Radio 2 before saving the existing settings and exiting the Radio Configuration screen.

Once the settings within the Radio Configuration screen are applied (for an initial deployment), the current number of base bridges visible to the radio displays within the **BBs Visible** field, and the number of base bridges currently connected to the radio displays

within the **BBs Connected** field. If this is an existing radio within a mesh network, these values update in real-time.

6. Click the **Advanced** button to define a prioritized list of access points to define Mesh Connection links. For a detailed overview on mesh networking and how to configure the AP-5131 radio for mesh networking support, see [Configuring Mesh Networking on page 9-1](#).
7. Click **Apply** to save any changes to the Radio Configuration screen. Navigating away from the screen without clicking Apply results in all changes to the screens being lost.



CAUTION When defining a Mesh configuration and changes are saved, the mesh network temporarily goes down. The Mesh network is unavailable because the AP-5131 radio is reconfigured when applying changes. This can be problematic for users making changes within a deployed mesh network. If updating the mesh network using a LAN connection, the AP-5131 applet loses connection and the connection must be re-instated. If updating the mesh network using a WAN connection, the AP-5131 applet does not lose connection, but the mesh network is unavailable until the changes have been applied.

8. Click **Undo Changes** (if necessary) to undo any changes made. Undo Changes reverts the settings displayed on the Radio Configuration screen to the last saved configuration.
9. Click **Logout** to securely exit the AP-5131 Symbol Access Point applet. A prompt displays confirming the logout before the applet is closed.

Once the target radio has been enabled from the **Radio Configuration** screen, configure the radio's properties by selecting it from the AP-5131 menu tree.

For more information, see [Configuring the 802.11a or 802.11b/g Radio on page 5-48](#).

5.3.2.1 Configuring the 802.11a or 802.11b/g Radio

Configure an 802.11a or 802.11b/g radio by selecting the radio's name (as defined using the 802.11a or 802.11b/g radio configuration screen described below) as a sub-menu item under the Radio Configuration menu item. Use the radio configuration screen to set the radio's placement properties, define the radio's threshold and QoS settings, set the radio's channel and antenna settings and define beacon and DTIM intervals.

To configure the AP-5131's 802.11a or 802.11b/g radio:

1. Select **Network Configuration** -> **Wireless** -> **Radio Configuration** -> **Radio1** (default name) from the AP-5131 menu tree.

On a single-radio AP-5131, Radio1 could either be an 802.11a or 802.11b/g radio depending on which radio has been enabled.

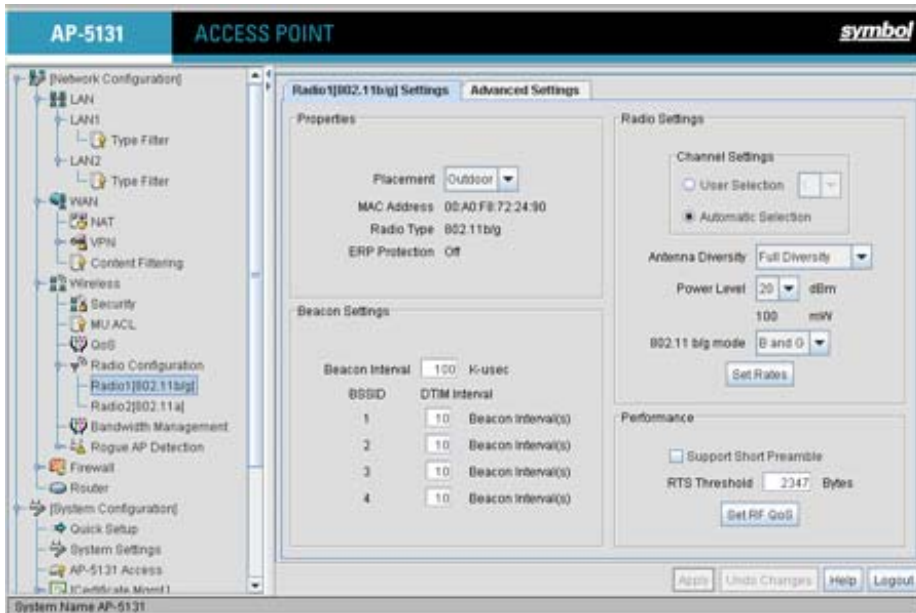

2. Configure the **Properties** field to assign a name and placement designation for the radio.

Placement

Use the **Placement** drop-down menu to specify whether the radio is located outdoors or indoors. Default placement depends on the country of operation selected for the AP-5131.

MAC Address

The AP-5131, like other Ethernet devices, has a unique, hardware encoded *Media Access Control (MAC)* or IEEE address. MAC addresses determine the device sending or receiving data. A MAC address is a 48-bit number written as six hexadecimal bytes separated by colons. For example: *00:A0:F8:24:9A:C8*

Radio Type

The **Radio Type** parameter simply displays the radio type as 802.11a or 802.11b/g. This field is read only and always displays the radio type selected from the AP-5131 menu tree under the Radio Configuration item.

ERP Protection *Extended Rate PHY (ERP)* allows 802.11g MUs to interoperate with 802.11b only MUs. ERP Protection is managed automatically by the AP-5131 and informs users when 802.11b MUs are present within the AP-5131's coverage area. The presence of 802.11b MUs within the 802.11g coverage area negatively impacts network performance, so this feature should be looked to as an indicator of why network performance has been degraded.

3. Configure the **Radio Settings** field to assign a channel, antenna diversity setting, radio transmit power level and data rate.

Channel Setting The following channel setting options exist:
User Selection - If selected, use the drop-down menu to specify the legal channel for the intended country of operation. The drop-down menu is not available if this option is not selected.
Automatic Selection - Enables the AP-5131 to auto-select the channel of operation. For example, if three AP-5131's are operating on 802.11b/g, each AP-5131 would be set to a non-overlapping channel (1, 6 and 11). If using the AP-5131's 802.11a radio, a **Uniform Spreading** option is available (and is the default setting for the 802.11a radio). To comply with *Dynamic Frequency Selection (DFS)* requirements in the European Union, the 802.11a radio uses a randomly selected channel each time the AP-5131 is powered on.

Antenna Diversity Specifies the antenna selection for the 802.11a radio. Options include *Primary Only*, *Secondary Only* and *Full Diversity*. The default setting is *Primary*. However, Diversity can improve performance and signal reception in areas where interference is significant and is recommended when two antennas are supported.

Power Level The **Power Level** parameter defines the transmit power of the 802.11a or 802.11b/g antenna(s). The values are expressed in dBm and mW.

802.11 b/g mode Specify **b only**, **g only** or **b and g** to define whether the 802.11b/g radio transmits in the 2.4 Ghz band exclusively for 802.11b (legacy) clients or transmits in the 2.4 Ghz band for 802.11g clients. Selecting b and g enables the AP-5131 to transmit to both b and g clients if legacy clients (802.11b) partially comprise the network. Select accordingly based on the MU requirements of the network. This parameter does not apply to AP-5131 802.11a radios.

Set Rates

Click the **Set Rates** button to display a window for selecting minimum and maximum data transmit rates for the radio. At least one **Basic Rate** must be selected as a minimum transmit rate value. **Supported Rates** define the data rate the radio defaults to if a higher selected data rate cannot be maintained. Click **OK** to implement the selected rates and return to the 802.11a or 802.11b/g radio configuration screen. Clicking **Cancel** reverts the Set Rates screen to the last saved configuration. Symbol recommends using the default rates unless qualified to understand the performance risks of changing them. The appearance of the Set Rates screen varies depending on the 802.11a or 802.11b/g used, as the data rates available to the two radios are different.

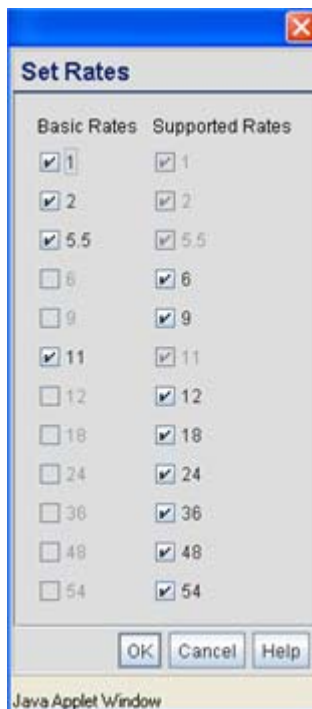

4. Refer to the **Beacon Settings** field to set the radio beacon and DTIM intervals.

Beacon Interval The beacon interval controls the performance of power save stations. A small interval may make power save stations more responsive, but it will also cause them to consume more battery power. A large interval makes power save stations less responsive, but could increase power savings. The default is 100. Avoid changing this parameter as it can adversely affect performance.

DTIM Interval The DTIM interval defines how often broadcast frames are delivered for each of the four AP-5131 BSSIDs. If a system has an abundance of broadcast traffic and it needs to be delivered quickly, Symbol recommends decreasing the DTIM interval for that specific BSSID. However, decreasing the DTIM interval decreases the battery life on power save stations. The default is 10 for each BSSID. Symbol recommends using the default value unless qualified to understand the performance risks of changing it.

5. Configure the **Performance** field to set the preamble, thresholds values, data rates and QoS values for the radio.

Support Short Preamble The preamble is approximately 8 bytes of packet header generated by the AP-5131 and attached to the packet prior to transmission from the 802.11b radio. The preamble length for 802.11b transmissions is data rate dependant. The short preamble is 50% shorter than the long preamble. Leave the checkbox unselected if in a mixed MU/AP environment, as MUs and the AP-5131 are required to have the same RF Preamble settings for interoperability. The default is Disabled. The preamble length for 802.11a and 802.11g transmissions is the same, with no long or short preamble lengths.

RTS Threshold RTS allows the AP-5131 to use RTS (Request To Send) on frames longer than the specified length. The default is 2341bytes.

Set RF QoS

Click the **Set RF QoS** button to display the **Set RF QoS** screen to set QoS parameters for the AP-5131 radio. Do not confuse with the QoS configuration screen used for a WLAN. The Set RF QoS screen initially appears with default values displayed.

Select **manual** from the **Select Parameter set** drop-down menu to edit the **CW min** and **CW max** (contention window), **AIFSN** (*Arbitrary Inter-Frame Space Number*) and **TXOPs Time** for each Access Category. These are the QoS policies for the 802.11a or 802.11b/g radio, not the QoS policies configured for the WLAN (as created or edited from the **Quality of Service Configuration** screen).

Symbol recommends only advanced users manually set these values. If the type of data-traffic is known, use the drop-down menu to select a **11g-wifi**, **11b-wifi**, **11g-default**, **11b-default**, **11g-voice** or **11b-voice** option. Wifi represents multimedia traffic, default is typical data traffic and voice is for "Voice-Over-IP" supported wireless devices.

Click **OK** to implement the selected QoS values and return to the 802.11a or 802.11b/g radio configuration screen. Clicking **Cancel** reverts the screen to the last saved configuration.

Access Category	CW Minimum	CW Maximum	AIFSN	TXOPs Time 32usec	TXOPs Time ms
Background	15	255	7	0	0.0
Best Effort	15	63	3	31	0.992
Video	7	15	1	94	3.008
Voice	3	7	1	47	1.504

6. Select the **Advanced Settings** tab to strategically map BSSIDs to WLANs in order to define them as primary WLANs.

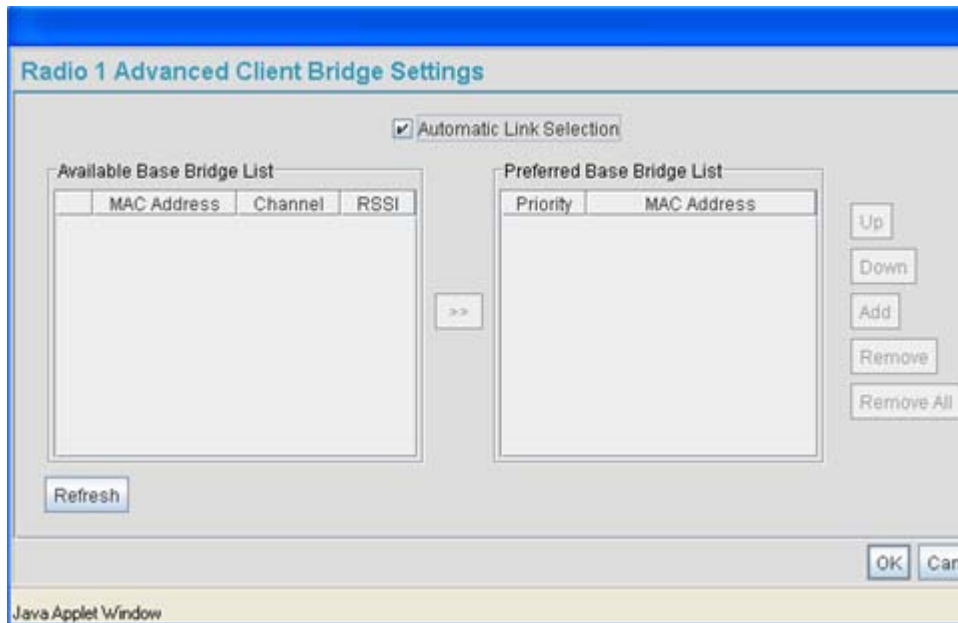

Defining Primary WLANs allows an administrator to dedicate BSSIDs (4 BSSIDs are available for mapping) to WLANs. From that initial BSSID assignment, Primary WLANs can be defined from within the WLANs assigned to BSSID groups 1 through 4. Each BSSID beacons only on the primary WLAN.

The user should assign each WLAN to its own BSSID. In cases where more than four WLANs are required, WLANs should be grouped according to their security policies so all of the WLANs on a BSSID have the same security policy. It is generally a bad idea to have WLANs with different security policies on the same BSSID, as this will result in warning or error messages.



NOTE If using a single-radio AP-5131, there are 4 BSSIDs available. If using a dual-radio AP-5131, 4 BSSIDs for the 802.11b/g radio and 4 BSSIDs for the 802.11a radio are available.

WLAN Lists the WLAN names available to the 802.11a or 802.11b/g radio that can be assigned to a BSSID.

<i>BSSID</i>	Assign a BSSID value of 1 through 4 to a WLAN in order to map the WLAN to a specific BSSID.
<i>BC/MC Cipher</i>	A read only field displaying the downgraded BC/MC (Broadcast/Multicast) cipher for a WLAN based on the BSSID and VLAN ID to which it has been mapped.
<i>Status</i>	Displays the following color coded status: Red - Error (Invalid Configuration) Yellow - Warning (Broadcast Downgrade) Green - Good (Configuration is OK)
<i>Message</i>	Displays the verbal status of the WLAN and BSSID assignments. If the Status column displays green, the Message will typically be Configuration is OK . If yellow, a description of invalid configuration displays.

7. Use the **Primary WLAN** drop-down menu to select a WLAN from those WLANs sharing the same BSSID. The selected WLAN is the primary WLAN for the specified BSSID.
8. Click **Apply** to save any changes to the Radio Settings and Advanced Settings screens. Navigating away from the screen without clicking Apply results in changes to the screens being lost.
9. Click **Undo Changes** (if necessary) to undo any changes made to the screen and its sub-screens. Undo Changes reverts the settings to the last saved configuration.
10. Click **Logout** to securely exit the AP-5131 Symbol Access Point applet. A prompt displays confirming the logout before the applet is closed.

5.3.3 Configuring Bandwidth Management Settings

The AP-5131 can be configured to grant individual WLAN's network bandwidth priority levels. Use the **Bandwidth Management** screen to control the network bandwidth allotted to WLANs. Symbol recommends defining a weighed scheme as needed when WLAN traffic supporting a specific network segment becomes critical.

1. Select **Network Configuration -> Wireless -> Bandwidth Management** from the AP-5131 menu tree.

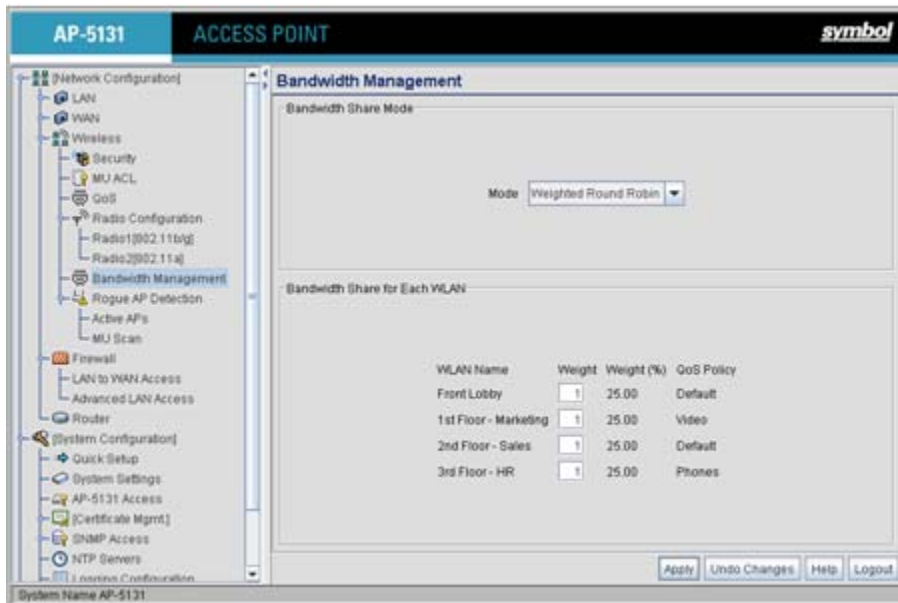

- Use the **Bandwidth Share Mode** drop-down menu to define the order enabled WLANs receive AP-5131 services. Select one of the following three options:

First In First Out WLANs receive services from the AP-5131 on a first-come, first-served basis. This is the default setting.

Round-Robin Each WLAN receives AP-5131 services in turn as long the AP-5131 has data traffic to forward.

Weighted Round-Robin If selected, a weighting (prioritization) scheme (configured within the QoS Configuration screen) is used to define which WLANs receive AP-5131 resources first.

- Configure the **Bandwidth Share for Each WLAN** field to set a raw weight (for WLANs using the Weighted Round-Robin option) for each WLAN. The weight% changes as the weight is entered.

If a WLAN has not been enabled from the **Wireless** screen, it is not configurable using the **Bandwidth Management** screen. To enable a specific WLAN, see [Enabling Wireless LANs \(WLANs\) on page 5-22](#).

<i>WLAN Name</i>	Displays the name of the WLAN. This field is read-only. To change the name of the WLAN, see Creating/Editing Individual WLANs on page 5-24 .
<i>Weight</i>	This column is not available unless Weighted Round-Robin is selected. Assign a weight to each WLAN. This percentage equals the AP-5131 bandwidth share for that WLAN when network traffic is detected.
<i>Weight (%)</i>	This column is automatically updated with the appropriate WLAN bandwidth share when the Weight is modified.
<i>QoS Policy</i>	Displays the name of the QoS policy defined for each WLAN within the Quality of Service for WLAN screen. If no policy has been set, the WLAN uses the default policy. For information on assigning QoS policies for specific WLANs, see Setting the WLAN Quality of Service (QoS) Policy on page 5-34 .

4. Click **Apply** to save any changes to the Bandwidth Management screen. Navigating away from the screen without clicking Apply results in all changes to the screens being lost.
5. Click **Undo Changes** (if necessary) to undo any changes made. Undo Changes reverts the settings displayed on the Bandwidth Management screen to the last saved configuration.
6. Click **Logout** to securely exit the AP-5131 Symbol Access Point applet. A prompt displays confirming the logout before the applet is closed.



NOTE Though the Rogue AP and Firewall features appear after the Bandwidth Management features within the AP-5131 menu tree, they are described in [Chapter 6, Configuring Access Point Security on page 6-1](#), as both items are data protection functions. More specifically, see, [Configuring Firewall Settings on page 6-25](#) and [Configuring Rogue AP Detection on page 6-53](#).

5.4 Configuring Router Settings

The AP-5131 router uses routing tables and protocols to forward data packets from one network to another. The AP-5131 router manages traffic within the network, and directs traffic from the WAN to destinations on the AP-5131 managed LAN. Use the AP-5131 **Router** screen to view the router's connected routes. To access the Router screen.

1. Select **Network Configuration** -> **Router** from the AP-5131 menu tree.

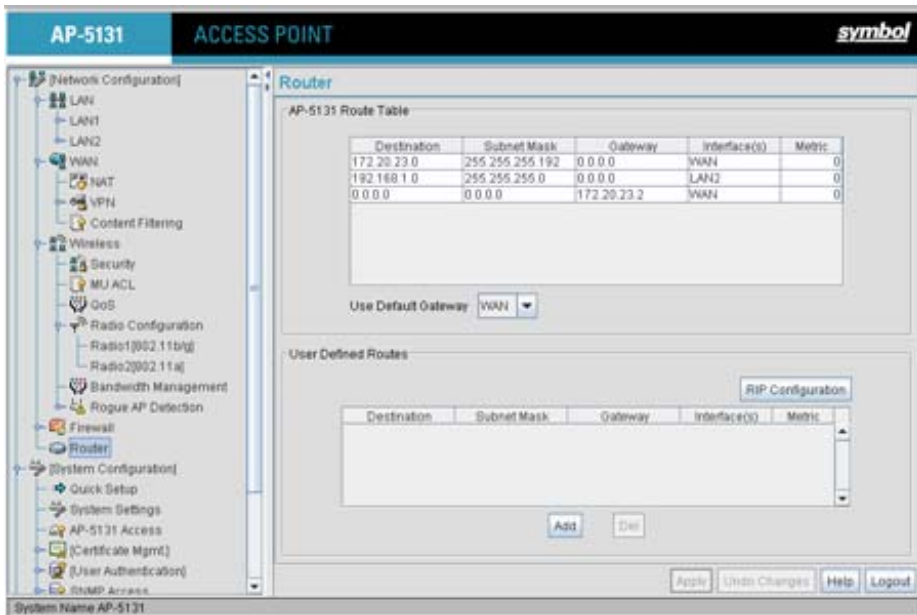

2. Refer to the AP-5131 **Router Table** field to view existing routes.

The AP-5131 Router Table field displays a list of connected routes between an enabled subnet and the router. These routes can be changed by modifying the IP address and subnet masks of the enabled subnets.

The information in the AP-5131 Router Table is dynamically generated from settings applied on the **WAN** screen. The destination for each subnet is its IP address. The subnet mask (or network mask) and gateway settings are those belonging to each subnet. Displayed interfaces are those associated with destination IP addresses. To change any of the network address information within the WAN screen, see [Configuring WAN Settings on page 5-14](#).

3. From the **Use Default Gateway** drop-down menu, select the WAN or either of the two LANs (if enabled) to serve as the default gateway to forward data packets from one network to another.
4. To set or view the RIP configuration, click the **RIP Configuration** button.

Routing Information Protocol (RIP) is an interior gateway protocol that specifies how routers exchange routing-table information. The Router screen also allows the administrator to select the type of RIP and the type of RIP authentication used by the switch. For more information on configuring RIP, see [Setting the RIP Configuration on page 5-59](#).

5. Use the **User Defined Routes** field to add or delete static routes.
The User Defined Routes field allows the administrator to view, add or delete internal static (dedicated) routes.
 - a. Click the **Add** button to create a new table entry.
 - b. Highlight an entry and click the **Del** (delete) button to remove an entry.
 - c. Specify the destination IP address, subnet mask, and gateway information for the internal static route.
 - d. Select an enabled subnet from the **Interface(s)** column's drop-down menu to complete the table entry. Information in the **Metric** column is a user-defined value (from 1 to 65535) used by router protocols to determine the best hop routes.
6. Click the **Apply** button to save the changes.
7. Click **Logout** to securely exit the AP-5131 Symbol Access Point applet. A prompt displays confirming the logout before the applet is closed.

5.4.1 Setting the RIP Configuration

To set the RIP configuration:

1. From within the RIP Configuration field, select the RIP Type from the drop-down menu. The following options are available:

<i>No RIP</i>	The No RIP option disallows the AP-5131's router from exchanging routing information with other routers. Routing information may not be appropriate to share, for example, if the AP-5131 manages a private LAN.
<i>RIP v1</i>	RIP version 1 is a mature, stable, and widely supported protocol. It is well suited for use in stub networks and in small autonomous systems that do not have enough redundant paths to warrant the overhead of a more sophisticated protocol.
<i>RIP v2 (v1 compat)</i>	RIP version 2 (compatible with version 1) is an extension of RIP v1's capabilities, but it is still compatible with RIP version 1. RIP version 2 increases the amount of packet information to provide the a simple authentication mechanism to secure table updates.

RIP v2

RIP version 2 enables the use of a simple authentication mechanism to secure table updates. More importantly, RIP version 2 supports subnet masks, a critical feature not available in RIP version 1. This selection is not compatible with RIP version 1 support.

2. Select a routing direction from the **RIP Direction** drop-down menu. **Both** (for both directions), **Rx only** (receive only), and **TX only** (transmit only) are available options.

The screenshot shows the 'RIP Configuration' dialog box. The 'RIP Configuration' section has 'RIP Type' set to 'RIP v2 (v1 compat)' and 'RIP Direction' set to 'Both'. The 'RIP v2 Authentication' section has 'Authentication Type' set to 'MD5'. Below this, there are two key configurations: 'Key #1' and 'Key #2'. Each key configuration includes an 'MD5 ID (1-256)' field set to '1' and an 'MD5 Auth Key (16 Characters)' field filled with asterisks. At the bottom right, there are 'OK', 'Cancel', and 'Help' buttons. The dialog is running in a 'Java Applet Window'.

3. If RIP v2 or RIP v2 (v1 compat) is the selected RIP type, the **RIP v2 Authentication** field becomes active. Select the type of authentication to use from the **Authentication Type** drop-down menu. Available options include:

<i>None</i>	This option disables the RIP authentication.
<i>Simple</i>	This option enable RIP version 2's simple authentication mechanism. This setting activates the Password (Simple Authentication) field.
<i>MD5</i>	This option enables the MD5 algorithm for data verification. MD5 takes as input a message of arbitrary length and produces a 128-bit fingerprint. The MD5 setting activates the RIP v2 Authentication settings for keys (below).

4. If the Simple authentication method is selected, specify a password of up to 15 alphanumeric characters in the **Password (Simple Authentication)** area.
5. If the MD5 authentication method is selected, fill in the **Key #1** field (Key #2 is optional). Enter any numeric value between 0 and 256 into the **MD5 ID** area. Enter a string consisting of up to 16 alphanumeric characters in the **MD5 Auth Key** area.
6. Click the **OK** button to return to the Router screen. From there, click **Apply** to save the changes.

6

Configuring Access Point Security

Security measures for the AP-5131 and its WLANs are critical. Use the available AP-5131 security options to protect the AP-5131 LAN from wireless vulnerabilities, and safeguard the transmission of RF packets between the AP-5131 and its associated MUs.

WLAN security can be configured on an ESS by ESS basis on the AP-5131. Sixteen separate ESSIDs (WLANs) can be supported on an AP-5131, and must be managed (if necessary) between the 802.11a and 802.11b/g radio. The user has the capability of configuring separate security policies for each WLAN. Each security policy can be configured based on the authentication (Kerberos, 802.1x EAP) or encryption (WEP, KeyGuard, WPA/TKIP or WPA2/CCMP) scheme best suited to the coverage area that security policy supports.

The AP-5131 can also create VPN tunnels to securely route traffic through a IPSEC tunnel and block transmissions with devices interpreted as Rogue APs.



NOTE Security for the AP-5131 can be configured in various locations throughout the AP-5131 menu structure. This chapter outlines the security options available to the AP-5131, and the menu locations and steps required to configure specific security measures.

6.1 Configuring Security Options

To configure the data protection options available on the AP-5131, refer to the following:

- To set an administrative password for secure AP-5131 logins, see [Setting Passwords on page 6-3](#).
- Refer to [Enabling Authentication and Encryption Schemes on page 6-5](#) to display security policy screens used to configure the authentication and encryption schemes available to the AP-5131. These security policies can be used on more than one WLAN.
- To create a security policy supporting 802.1x EAP, see [Configuring 802.1x EAP Authentication on page 6-11](#).
- To define a security policy supporting Kerberos, see, [Configuring Kerberos Authentication on page 6-9](#).
- To create a security policy supporting WEP, see [Configuring WEP Encryption on page 6-16](#).
- To configure a security policy supporting KeyGuard, see, [Configuring KeyGuard Encryption on page 6-18](#).
- To define a security policy supporting WPA-TKIP, see [Configuring WPA Using TKIP on page 6-20](#).
- To create a security policy supporting WPA2-CCMP, see [Configuring WPA2-CCMP \(802.11i\) on page 6-22](#).
- To configure the AP-5131 to block specific kinds of HTTP, SMTP and FTP data traffic, see [Configuring Firewall Settings on page 6-25](#).
- To create VPN tunnels allowing traffic to route securely through a IPSEC tunnel to a private network, see [Configuring VPN Tunnels on page 6-34](#).
- To configure the AP-5131 to block transmissions with devices detected as Rogue AP's (hostile devices), see [Configuring Rogue AP Detection on page 6-53](#).

6.2 Setting Passwords

Before setting the AP-5131 security parameters, verify an administrative password for the AP-5131 has been created to restrict access to the device before advanced device security is configured.

To password protect and restrict AP-5131 device access:

1. Connect a wired computer to the AP-5131 LAN port using a standard CAT-5 cable.
2. Set up the computer for TCP/IP DHCP network addressing and make sure the DNS settings are not hardcoded.
3. Start up Internet Explorer (with Sun Micro Systems' Java Runtime Environment (JRE) 1.5 or higher installed) and type in the default IP address in the address field.

To connect to the AP, the AP-5131 IP is required. If connected to the AP-5131 using the WAN port, the default static IP address is 10.1.1.1. The default password is "symbol." If connected to the AP-5131 using the LAN port, the default setting is DHCP client. The user must know the IP address in order to access the AP-5131 using a Web browser.

The AP-5131 Login screen displays.



NOTE For optimum compatibility use Sun Microsystems' JRE 1.5 or higher (available from Sun's Web site), and be sure to disable Microsoft's Java Virtual Machine if it is installed.

AP-5131
ACCESS POINT

Username
admin

Password

Login

symbol

- Log in using the “**admin**” as the default User ID and “**symbol**” as the default Password. If the default login is successful, the **Change Admin Password** window displays. Change the default login and password to significantly decrease the likelihood of hacking.



CAUTION Restoring the AP-5131’s configuration back to default settings changes the administrative password back to “symbol.” If restoring the configuration back to default settings, be sure you change the administrative password accordingly.

- Enter the previous password and the new admin password in the two fields provided. Click the **Apply** button.

Once the admin password has been created/updated, the **System Settings** screen displays. If the AP-5131 has not had its System Settings (device name, location etc.) configured, see [Configuring System Settings on page 4-2](#).

Once the password has been set, refer back to [Configuring Security Options on page 6-2](#) to determine which AP-5131 security feature to configure next.

6.2.1 Resetting the AP-5131 Password

The AP-5131 *Command Line Interface* (CLI) enables users who forget their password to reset it to the factory default (symbol). From there, a new password can be defined.

To reset the AP-5131 password back to its default setting:

- Connect one end of a null modem serial cable to the AP-5131’s serial connector.
- Attach the other end of the null modem serial cable to the serial port of a PC running HyperTerminal or a similar emulation program.
- Set the HyperTerminal program to use 19200 baud, 8 data bits, 1 stop bit, no parity, no flow control and auto-detect for terminal emulation.

4. Press <ESC> or <Enter> to access the AP-5131 CLI.
A serial connection has now been established and the user should be able to view the serial connection window.
5. Reset the AP-5131.
An AP-5131 can be reset by removing and re-inserting the LAN cable or removing and re-inserting the power cable.
As the AP-5131 is re-booting, a "Press esc key to run boot firmware" message displays.
6. Quickly press <ESC>.



CAUTION If the <ESC> key is not pressed within three seconds after the "Press esc key to run boot firmware" message displays, the AP-5131 will continue to boot.

If the <ESC> key is pressed within three seconds a boot> prompt displays.

7. Type the following at the boot prompt:
passwd default
8. Reset the AP-5131 by typing the following at the boot prompt:
reset system

When the AP-5131 re-boots again, the password will return to its default value of "symbol."
You can now access the AP-5131.

6.3 Enabling Authentication and Encryption Schemes

To complement the built-in firewall filters on the WAN side of the AP-5131, the WLAN side of the AP-5131 supports authentication and encryption schemes. Authentication is a challenge-response procedure for validating user credentials such as username, password, and sometimes secret-key information. The AP-5131 provides two schemes for authenticating users: *802.1x EAP* and *Kerberos*.

Encryption applies a specific algorithm to alter its appearance and prevent unauthorized reading. Decryption applies the algorithm in reverse to restore the data to its original form. Sender and receiver must employ the same encryption/decryption method to interoperate.

Wired Equivalent Privacy (WEP) is available in two encryption modes: 40 bit (also called WEP 64) and 104 bit (also called WEP 128). The 104-bit encryption mode provides a longer algorithm (better security) that takes longer to decode (hack) than the 40-bit encryption mode.

Each WLAN (16 WLANs available in total to an AP-5131 regardless of the model) can have a separate security policy. However, more than one WLAN can use the same security policy. Therefore, to avoid confusion, do not name security policies the same name as WLANs. Once security policies have been created, they are selectable within the **Security** field of each **WLAN** screen. If the existing default security policy does not satisfy the data protection requirements of a specific WLAN, a new security policy (using the authentication and encryption schemes discussed above) can be created.

To enable an existing WLAN security policy or create a new policy:

1. Select **Network Configuration** -> **Wireless** -> **Security** from the AP-5131 menu tree. The **Security Configuration** screen displays.
2. If a new security policy is required, click the **Create** button.

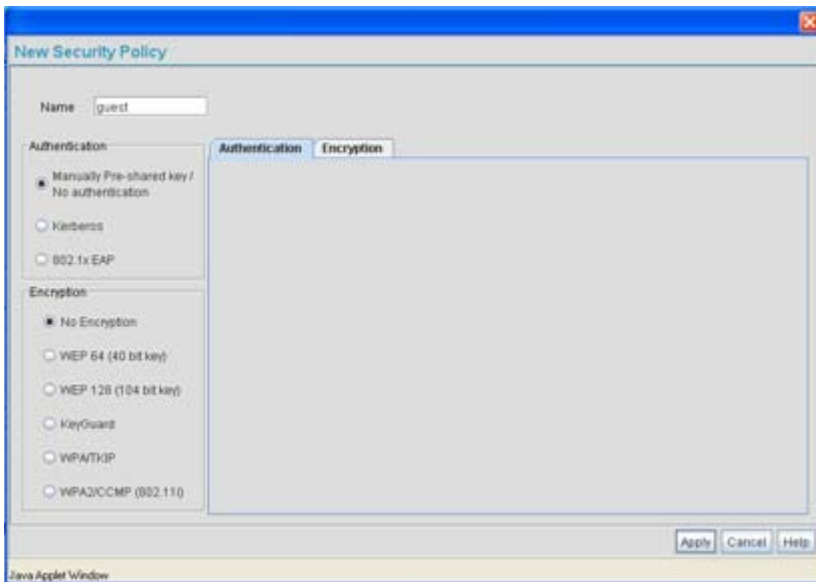

The **New Security Policy** screen displays with the **Manually Pre-shared key/No authentication** and **No Encryption** options selected. Naming and saving such a policy (as is) would provide no security and might only make sense in a guest network wherein no sensitive data is either transmitted or received.

However, selecting any other authentication or encryption checkbox displays a configuration field for the selected security scheme within the **New Security Policy** screen.



NOTE An existing security policy can be edited from the Security Configuration screen by selecting an existing policy and clicking the **Edit** button. Use the **Edit Security Policy** screen to edit the policy. For more information on editing an existing security policy, refer to security configuration sections described in steps 4 and 5.

- Use the **Name** field to define a logical security policy name.
Remember, multiple WLANs can share the same security policy, so be careful not to name security policies after specific WLANs or risk defining a WLAN to single policy. Symbol recommends naming the policy after the attributes of the authentication or encryption type selected (for example, *WPA2 Allow TKIP*).
- Enable and configure an **Authentication** option if necessary for the target security policy.

Manually Pre-Shared Key / No Authentication Select this button to disable authentication. This is the default value for the **Authentication** field.

Kerberos Select the **Kerberos** button to display the **Kerberos Configuration** field within the New Security Policy screen. For specific information on configuring Kerberos, see [Configuring Kerberos Authentication on page 6-9](#).

802.1x EAP Select the **802.1x EAP** button to display the **802.1x EAP Settings** field within the New Security Policy screen. For specific information on configuring EAP, see [Configuring 802.1x EAP Authentication on page 6-11](#).

- Enable and configure an **Encryption** option if necessary for the target security policy.

No Encryption If **No Encryption** is selected, encryption is disabled for the security policy. If security is not an issue, this setting avoids the overhead an encryption protocol causes on the AP-5131. No Encryption is the default value for the Encryption field.

WEP 64 (40-bit key) Select the **WEP 64 (40 bit key)** button to display the **WEP 64 Settings** field within the New Security Policy screen. For specific information on configuring WEP 64, see [Configuring WEP Encryption on page 6-16](#).

- WEP 128 (104-bit key)* Select the **WEP 128 (104 bit key)** button to display the **WEP 128 Settings** field within the New Security Policy screen. For specific information on configuring WEP 128, see [Configuring WEP Encryption on page 6-16](#).
- KeyGuard* Select the **KeyGuard** button to display the **KeyGuard Settings** field within the New Security Policy screen. For specific information on configuring KeyGuard, see [Configuring KeyGuard Encryption on page 6-18](#).
- WPA/TKIP* Select the **WPA/TKIP** button to display the **WPA/TKIP Settings** field within the New Security Policy screen. For specific information on configuring WPA-TKIP, see [Configuring WPA Using TKIP on page 6-20](#).
- WPA2/CCMP (802.11i)* Select the **WPA2/CCMP (802.11)** button to display the **WPA2/CCMP Settings** field within the New Security Policy screen. For detailed information on configuring WPA2/CCMP, see [Configuring WPA2-CCMP \(802.11i\) on page 6-22](#).

6. Click **Apply** to keep changes made within the New Security Policy screen (if any).

Configure encryption or authentication supported security policies by referring to the following:

AP-5131 authentication:

- To create a security policy supporting Kerberos, see, [Configuring Kerberos Authentication on page 6-9](#).
- To define a security policy supporting 802.1x EAP, see [Configuring 802.1x EAP Authentication on page 6-11](#).

AP-5131 encryption:

- To create a security policy supporting WEP, see [Configuring WEP Encryption on page 6-16](#).
- To define a security policy supporting KeyGuard, see, [Configuring KeyGuard Encryption on page 6-18](#).
- To configure a security policy supporting WPA/TKIP, see [Configuring WPA Using TKIP on page 6-20](#).
- To create a security policy supporting WPA2/CCMP, see [Configuring WPA2-CCMP \(802.11i\) on page 6-22](#).

7. Click **Cancel** to return to the target WLAN screen without keeping any of the changes made within the New Security Policy screen.

6.4 Configuring Kerberos Authentication

Kerberos (designed and developed by MIT) provides strong authentication for client/server applications using secret-key cryptography. Using Kerberos, a client must prove its identity to a server (and vice versa) across an insecure network connection.

Once a client and server use Kerberos to prove their identity, they can encrypt all communications to assure privacy and data integrity. Kerberos can only be used on the AP-5131 with Symbol clients.



CAUTION Kerberos makes no provisions for host security. Kerberos assumes that it is running on a trusted host with an untrusted network. If host security is compromised, Kerberos is compromised as well

Kerberos uses the *Network Time Protocol (NTP)* for synchronizing the clocks of its *Key Distribution Center (KDC) server(s)*. Use the **NTP Servers** screen to specify the IP addresses and ports of available NTP servers. Kerberos requires the **Enable NTP on AP-5131** checkbox be selected for authentication to function properly. See [Configuring Network Time Protocol \(NTP\) on page 4-32](#) to configure the NTP server.



NOTE If 802.11a is selected as the radio used for a specific WLAN, the WLAN cannot use a Kerberos supported security policy, as no 802.11a clients can support Kerberos on the AP-5131.

To configure Kerberos on the AP-5131:

1. Select **Network Configuration** -> **Wireless** -> **Security** from the AP-5131 menu tree. If security policies supporting Kerberos exist, they appear within the **Security Configuration** screen. These existing policies can be used as is, or their properties edited by clicking the **Edit** button. To configure a new security policy supporting Kerberos, continue to step 2.
2. Click the **Create** button to configure a new policy supporting Kerberos. The **New Security Policy** screen displays with no authentication or encryption options selected.

3. Select the **Kerberos** radio button.

The **Kerberos Configuration** field displays within the New Security Policy screen.

4. Ensure the **Name** of the security policy entered suits the intended configuration or function of the policy.

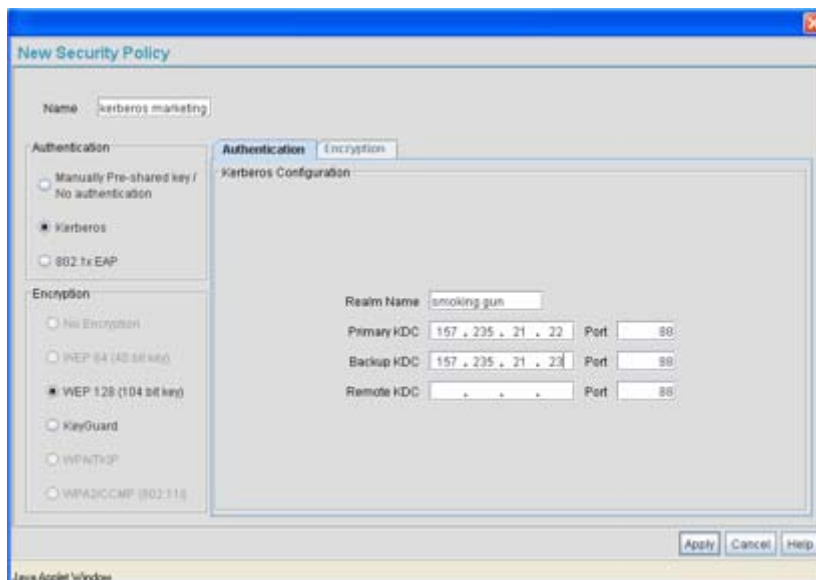

5. Set the **Kerberos Configuration** field as required to define the parameters of the Kerberos authentication server and AP-5131.

Realm Name

Specify a realm name that is case-sensitive, for example, SYMBOL.COM. The realm name is the name domain/real name of the KDC Server. A realm name functions similarly to a DNS domain name. In theory, the realm name is arbitrary. However, in practice a Kerberos realm is named by uppercasing the DNS domain name that is associated with hosts in the realm.

Primary KDC

Specify a numerical (non-DNS) IP address and port for the primary *Key Distribution Center (KDC)*. The KDC implements an Authentication Service and a Ticket Granting Service, whereby an authorized user is granted a ticket encrypted with the user's password. The KDC has a copy of every user password.

<i>Backup KDC</i>	Optionally, specify a numerical (non-DNS) IP address and port for a backup KDC. Backup KDCs are referred to as slave servers. The slave server periodically synchronizes its database with the primary (or master) KDC.
<i>Remote KDC</i>	Optionally, specify a numerical (non-DNS) IP address and port for a remote KDC. Kerberos implementations can use an administration server allowing remote manipulation of the Kerberos database. This administration server usually runs on the KDC.
<i>Port</i>	Specify the ports on which the Primary, Backup and Remote KDCs reside. The default port number for Kerberos Key Distribution Centers is Port 88.

6. Click the **Apply** button to return to the **WLAN** screen to save any changes made within the Kerberos Configuration field of the New Security Policy screen.
7. Click the **Cancel** button to undo any changes made within the Kerberos Configuration field and return to the **WLAN** screen. This reverts all settings for the Kerberos Configuration field to the last saved configuration.

6.5 Configuring 802.1x EAP Authentication

The IEEE 802.1x standard ties the 802.1x EAP authentication protocol to both wired and wireless LAN applications.

The EAP process begins when an unauthenticated supplicant (client device) tries to connect with an authenticator (in this case, the authentication server). The AP-5131 passes EAP packets from the client to an authentication server on the wired side of the AP-5131. All other packet types are blocked until the authentication server (typically, a RADIUS server) verifies the MU's identity.

To configure 802.1x EAP authentication on the AP-5131:

1. Select **Network Configuration** -> **Wireless** -> **Security** from the AP-5131 menu tree. If security policies supporting 802.1x EAP exist, they appear within the **Security Configuration** screen. These existing policies can be used as is, or their properties edited by clicking the **Edit** button. To configure a new security policy supporting 802.1x EAP, continue to step 2.
2. Click the **Create** button to configure a new policy supporting 802.1x EAP. The **New Security Policy** screen displays with no authentication or encryption options selected.

3. Select the **802.1x EAP** radio button.

The **802.1x EAP Settings** field displays within the New Security Policy screen.

4. Ensure the **Name** of the security policy entered suits the intended configuration or function of the policy.
5. If using the AP-5131's Internal Radius server, leave the **Radius Server** drop-down menu in the default setting of **Internal**. If an external Radius server is used, select **External** from the drop-down menu.

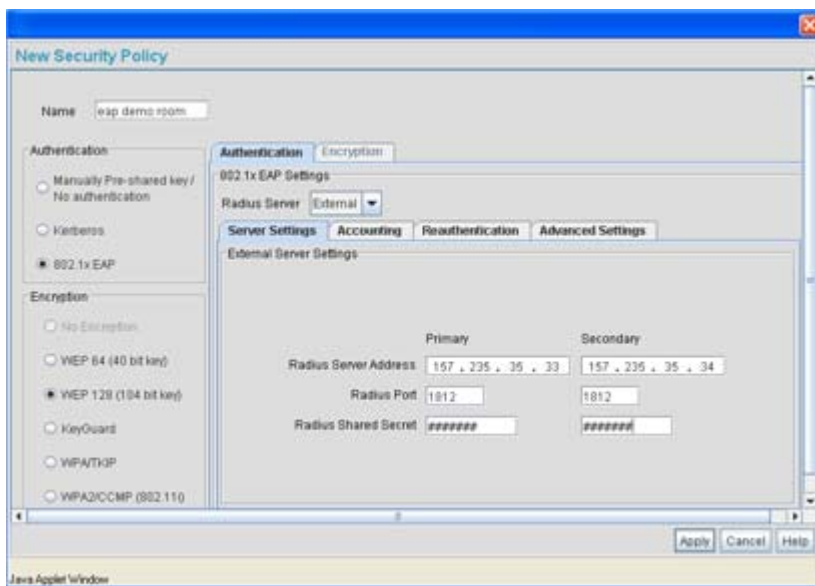

6. Configure the **Server Settings** field as required to define address information for the authentication server. The appearance of the Server Settings field varies depending on whether Internal or External has been selected from the Radius Server drop-down menu.

*Radius Server
Address*

If using an External Radius Server, specify the numerical (non-DNS) IP address of a primary *Remote Dial-In User Service* (Radius) server. Optionally, specify the IP address of a secondary server. The secondary server acts as a failover server if the primary server cannot be contacted. An ISP or a network administrator provides these addresses.

Radius is a client/server protocol and software enabling remote-access clients to communicate with a server used to authenticate users and authorize access to the requested system or service. This setting is not available if Internal has been selected from the Radius Server drop-down menu.

RADIUS Port

If using an External Radius Server, specify the port on which the primary Radius server is listening. Optionally, specify the port of a secondary (failover) server. Older Radius servers listen on ports 1645 and 1646. Newer servers listen on ports 1812 and 1813. Port 1645 or 1812 is used for authentication. Port 1646 or 1813 is used for accounting. The ISP or a network administrator needs to confirm the appropriate primary and secondary port numbers for authentication. This setting is not available if Internal has been selected from the Radius Server drop-down menu.

*RADIUS Shared
Secret*

Specify a shared secret for authentication on the Internal or Primary Radius server (External Radius Server only). The shared secret is required to match the shared secret on the Radius server. Optionally, specify a shared secret for a secondary (failover) server. Use shared secrets to verify Radius messages (with the exception of the Access-Request message) sent by a Radius enabled device configured with the same shared secret.

Apply the qualifications of a well-chosen password to the generation of a shared secret. Generate a random, case-sensitive string using letters, numbers and symbols. Verify the shared secret is at least 22 characters to protect the Radius server from brute-force attacks. An example of a strong and secure shared secret is: 8d#>9fq4bV)H7%a3-zE13sW.

7. Select the **Accounting** tab as required to define a timeout period and retry interval Syslog for MUs interoperating with the AP-5131 and EAP authentication server. The items within this tab could be enabled or disabled depending on whether internal or External has been selected from the Radius Server drop-down menu.

<i>Internal/External Accounting</i>	If using an Internal Radius server, select Disabled (no Internal Accounting), Internal Only or Both Internal and External . Selecting Both Internal and External displays additional parameters for configuring the External Radius Server.
	If using an External Radius server, simply select Enable or Disable to allow or deny external accounting with the external Radius server.
<i>External Radius Server Address</i>	Specify the IP address of the external Radius server used to provide Radius accounting.
<i>External Radius Port</i>	Specify the port on which the Radius server is listening.
<i>External Radius Shared Secret</i>	Specify a shared secret for authentication. The shared secret is required to match the shared secret on the Radius server.
<i>MU Timeout</i>	Specify the time (in seconds) for the AP-5131's retransmission of EAP-Request packets. The default is 10 seconds. If this time is exceeded, the authentication session is terminated.
<i>Retries</i>	Specify the number of retries for the MU to retransmit a missed frame to the Radius server before it times out of the authentication session. The default is 2 retries.
<i>Enable Syslog</i>	Select the Enable Syslog checkbox to enable syslog messages relating to EAP events to be written to the specified syslog server.
<i>Syslog Server IP Address</i>	Enter the IP address of the destination syslog server to be used to log EAP events.

8. Select the **Reauthentication** tab as required to define authentication connection policies, intervals and maximum retries. The items within this tab are identical regardless of whether Internal or External is selected from the Radius Server drop-down menu.

<i>Enable Reauthentication</i>	Select the Enable Reauthentication checkbox to configure a wireless connection policy so MUs are forced to reauthenticate periodically. Periodic repetition of the EAP process provides ongoing security for current authorized connections.
--------------------------------	---

Period (30-9999) secs Set the EAP reauthentication period to a shorter time interval (at least 30 seconds) for tighter security on the WLAN's connections. Set the EAP reauthentication period to a longer time interval (at most, 9999 seconds) to relax security on wireless connections. The reauthentication period setting does not affect wireless connection throughput. The default is 3600 seconds.

Max. Retries (1-99) retries Define the maximum number of MU retries to reauthenticate after failing to complete the EAP process. Failure to reauthenticate in the specified number of retries results in a terminated connection. The default is 2 retries.

9. Select the **Advanced Settings** tab as required to specify a MU quiet period, timeout interval, transmit period, and retry period for MUs and the authentication server. The items within this tab are identical regardless of whether Internal or External is selected from the Radius Server drop-down menu.

MU Quiet Period (1-65535) secs Specify an idle time (in seconds) between MU authentication attempts, as required by the authentication server. The default is 10 seconds.

MU Timeout (1-255) secs Define the time (in seconds) for the AP-5131's retransmission of EAP-Request packets. The default is 10 seconds.

MU Tx Period (1-65535) secs Specify the time period (in seconds) for the AP-5131's retransmission of the EAP Identity Request frame. The default is 5 seconds.

MU Max Retries (1-10) retries Specify the maximum number of times the AP-5131 retransmits an EAP-Request frame to the client before it times out the authentication session. The default is 2 retries.

Server Timeout (1-255) secs Specify the time (in seconds) for the AP-5131's retransmission of EAP-Request packets to the server. The default is 5 seconds. If this time is exceeded, the authentication session is terminated.

Server Max Retries (1-255) retries Specify the maximum number of times for the AP-5131 to retransmit an EAP-Request frame to the server before it times out the authentication session. The default is 2 retries.

10. Click the **Apply** button to save any changes made within the 802.1x EAP Settings field (including all 5 selectable tabs) of the New Security Policy screen.

11. Click the **Cancel** button to undo any changes made within the 802.1x EAP Settings field and return to the **WLAN** screen. This reverts all settings for the 802.1x EAP Settings field to the last saved configuration.

6.6 Configuring WEP Encryption

Wired Equivalent Privacy (WEP) is a security protocol specified in the *IEEE Wireless Fidelity (Wi-Fi)* standard. WEP is designed to provide a WLAN with a level of security and privacy comparable to that of a wired LAN.

WEP may be all that a small-business user needs for the simple encryption of wireless data. However, networks that require more security are at risk from a WEP flaw. The existing 802.11 standard alone offers administrators no effective method to update keys.

To configure WEP on the AP-5131:

1. Select **Network Configuration** -> **Wireless** -> **Security** from the AP-5131 menu tree.
If security policies supporting WEP exist, they appear within the **Security Configuration** screen. These existing policies can be used as is, or their properties edited by clicking the **Edit** button. To configure a new security policy supporting WEP, continue to step 2.
2. Click the **Create** button to configure a new policy supporting WEP.
The **New Security Policy** screen displays with no authentication or encryption options selected.
3. Select either the **WEP 64 (40 bit key)** or **WEP 128 (104 bit key)** radio button.
The **WEP 64 Settings** or **WEP 128 Settings** field displays within the New Security Policy screen.
4. Ensure the **Name** of the security policy entered suits the intended configuration or function of the policy.

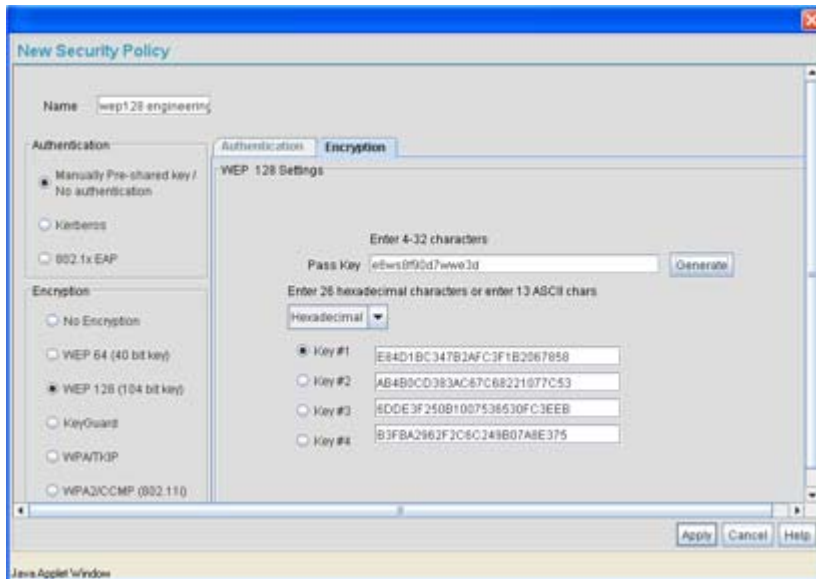

- Configure the **WEP 64 Settings** or **WEP 128 Settings** field as required to define the Pass Key used to generate the WEP keys. These keys must be the same between the AP-5131 and its MU to encrypt packets between the two devices.

Pass Key

Specify a 4 to 32 character pass key and click the **Generate** button. The pass key can be any alphanumeric string. The AP-5131, other proprietary routers and Symbol MUs use the algorithm to convert an ASCII string to the same hexadecimal number. MUs without Symbol adapters need to use WEP keys manually configured as hexadecimal numbers.

Keys #1-4

Use the **Key #1-4** areas to specify key numbers. The key can be either a hexadecimal or ASCII depending on which option is selected from the drop-down menu. For WEP 64 (40-bit key), the keys are 10 hexadecimal characters in length or 5 ASCII characters. For WEP 128 (104-bit key), the keys are 26 hexadecimal characters in length or 13 ASCII characters. Select one of these keys for activation by clicking its radio button.

Default (hexadecimal) keys for WEP 64 include:

Key 1	1011121314
Key 2	2021222324
Key 3	3031323334
Key 4	4041424344

Default (hexadecimal) keys for WEP 128 include:

Key 1	101112131415161718191A1B1C
Key 2	202122232425262728292A2B2C
Key 3	303132333435363738393A3B3C
Key 4	404142434445464748494A4B4C

- Click the **Apply** button to save any changes made within the WEP 64 Setting or WEP 128 Setting field of the New Security Policy screen.
- Click the **Cancel** button to undo any changes made within the WEP 64 Setting or WEP 128 Setting field and return to the **WLAN** screen. This reverts all settings to the last saved configuration.

6.7 Configuring KeyGuard Encryption

KeyGuard is a proprietary encryption method developed by Symbol Technologies. KeyGuard is Symbol's enhancement to WEP encryption, and was developed before the finalization of WPA-TKIP. This encryption implementation is based on the IEEE Wireless Fidelity (Wi-Fi) standard, 802.11i.

WPA2-CCMP (not KeyGuard) offers the highest level of security among the encryption methods available with the AP-5131.

- Select **Network Configuration** -> **Wireless** -> **Security** from the AP-5131 menu tree. If security policies supporting KeyGuard exist, they appear within the **Security Configuration** screen. These existing policies can be used as is, or their properties edited by clicking the **Edit** button. To configure a new security policy supporting KeyGuard, continue to step 2.
- Click the **Create** button to configure a new policy supporting KeyGuard. The **New Security Policy** screen displays with no authentication or encryption options selected.

- Select the **KeyGuard** radio button.
The **KeyGuard Settings** field displays within the New Security Policy screen.
- Ensure the **Name** of the security policy entered suits the intended configuration or function of the policy.

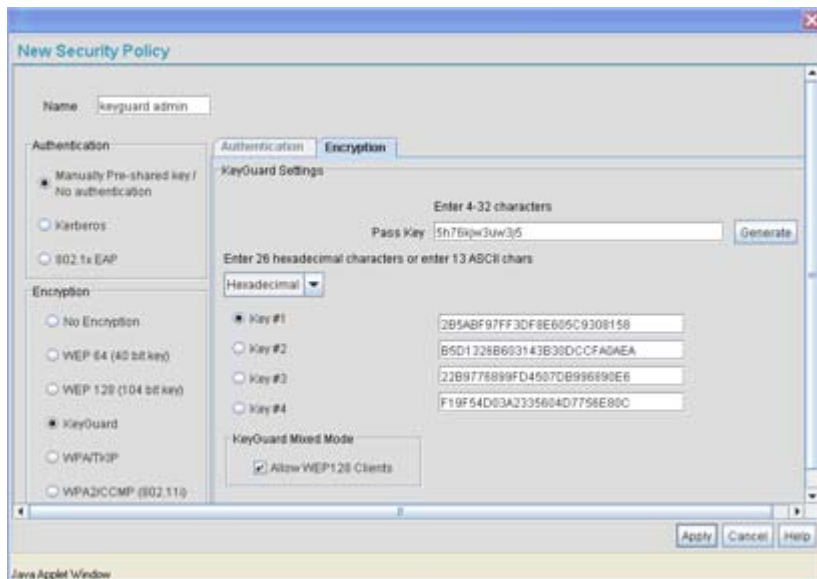

- Configure the **KeyGuard Settings** field as required to define the Pass Key used to generate the WEP keys used with the KeyGuard algorithm. These keys must be the same between the AP-5131 and its MU to encrypt packets between the two devices

Pass Key

Specify a 4 to 32 character pass key and click the **Generate** button. The pass key can be any alphanumeric string. The AP-5131, other proprietary routers, and Symbol MUs use the algorithm to convert an ASCII string to the same hexadecimal number. MUs without Symbol adapters need to use WEP keys manually configured as hexadecimal numbers.

Keys #1-4

Use the **Key #1-4** areas to specify key numbers. The key can be either a hexadecimal or ASCII depending on which option is selected from the drop-down menu. The keys are 26 hexadecimal characters in length or 13 ASCII characters. Select one of these keys for activation by clicking its radio button.

Default (hexadecimal) keys for KeyGuard include:

Key 1	101112131415161718191A1B1C
Key 2	202122232425262728292A2B2C
Key 3	303132333435363738393A3B3C
Key 4	404142434445464748494A4B4C

6. Select the **Allow WEP128 Clients** checkbox (from within the **KeyGuard Mixed Mode** field) to enable WEP128 clients to associate with an AP-5131's KeyGuard supported WLAN. The WEP128 clients must use the same keys as the KeyGuard clients to interoperate within the AP-5131's KeyGuard supported WLAN.
7. Click the **Apply** button to save any changes made within the KeyGuard Setting field of the New Security Policy screen.
8. Click the **Cancel** button to undo any changes made within the KeyGuard Setting field and return to the **WLAN** screen. This reverts all settings to the last saved configuration.

6.8 Configuring WPA Using TKIP

Wi-Fi Protected Access (WPA) is a robust encryption scheme specified in the IEEE Wireless Fidelity (Wi-Fi) standard, 802.11i. WPA provides more sophisticated data encryption than WEP. WPA is designed for corporate networks and small-business environments where more wireless traffic allows quicker discovery of encryption keys by an unauthorized person.

WPA's encryption method is *Temporal Key Integrity Protocol (TKIP)*. TKIP addresses WEP's weaknesses with a re-keying mechanism, a per-packet mixing function, a message integrity check, and an extended initialization vector. WPA also provides strong user authentication based on 802.1x EAP. To configure WPA-TKIP encryption on the AP-5131:

1. Select **Network Configuration** -> **Wireless** -> **Security** from the AP-5131 menu tree. If security policies supporting WPA-TKIP exist, they appear within the **Security Configuration** screen. These existing policies can be used as is, or their properties edited by clicking the **Edit** button. To configure a new security policy supporting WPA-TKIP, continue to step 2.
2. Click the **Create** button to configure a new policy supporting WPA-TKIP. The **New Security Policy** screen displays with no authentication or encryption options selected.

3. Select the **WPA/TKIP** radio button.
The **WPA/TKIP Settings** field displays within the New Security Policy screen.
4. Ensure the **Name** of the security policy entered suits the intended configuration or function of the policy.

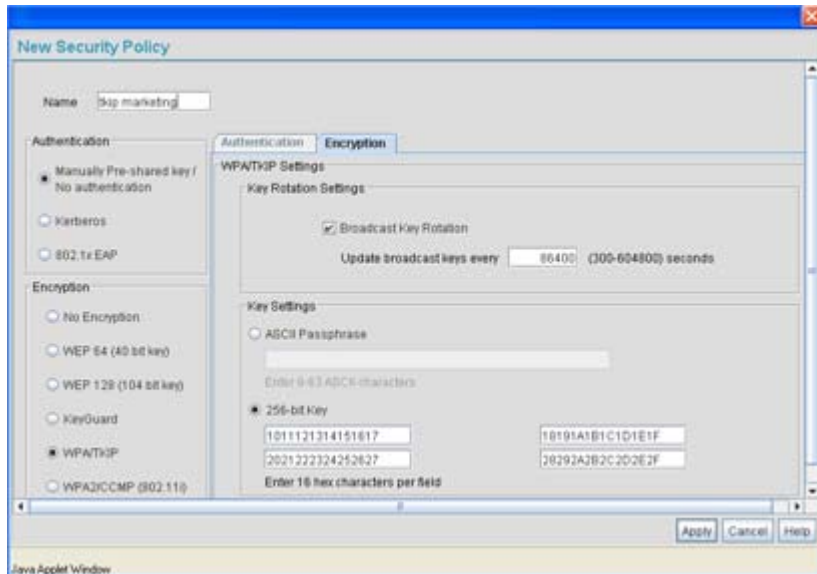

5. Configure the **Key Rotation Settings** area as needed to broadcast encryption key changes to MUs and define the broadcast interval.

Broadcast Key Rotation

Select the **Broadcast Key Rotation** checkbox to enable or disable the broadcasting of encryption-key changes to MUs. Only broadcast key changes when required by associated MUs to reduce the transmissions of sensitive key information. This value is disabled by default.

Update broadcast keys every (300-604800 seconds)

Specify a time period in seconds for broadcasting encryption-key changes to MUs. Set key broadcasts to a shorter time interval (at least 30 seconds) for tighter security on the WLAN's wireless connections. Set key broadcasts to a longer time interval (at most, 80000 seconds) to extend the key times for wireless connections. Default is 86,400 seconds.

6. Configure the **Key Settings** area as needed to set an ASCII Passphrase and key values.

ASCII Passphrase To use an ASCII passphrase (and not a hexadecimal value), select the checkbox and enter an alphanumeric string of 8 to 63 characters. The alphanumeric string allows character spaces. The AP-5131 converts the string to a numeric value. This passphrase saves the administrator from entering the 256-bit key each time keys are generated.

256-bit Key To use a hexadecimal value (and not an ASCII passphrase), select the checkbox and enter 16 hexadecimal characters into each of the four fields displayed.

Default (hexadecimal) 256-bit keys for WPA/TKIP include:

1011121314151617

18191A1B1C1D1E1F

2021222324252627

28292A2B2C2D2E2F

7. Click the **Apply** button to save any changes made within the WPA/TKIP Settings field of the New Security Policy screen.
8. Click the **Cancel** button to undo any changes made within the WPA/TKIP Settings field and return to the **WLAN** screen. This reverts all settings to the last saved configuration.

6.9 Configuring WPA2-CCMP (802.11i)

WPA2 is a newer 802.11i standard that provides even stronger wireless security than Wi-Fi Protected Access (WPA) and WEP. CCMP is the security standard used by the *Advanced Encryption Standard (AES)*. AES serves the same function TKIP does for WPA-TKIP. CCMP computes a *Message Integrity Check (MIC)* using the proven *Cipher Block Chaining (CBC)* technique. Changing just one bit in a message produces a totally different result.

WPA2/CCMP is based on the concept of a *Robust Security Network (RSN)*, which defines a hierarchy of keys with a limited lifetime (similar to TKIP). Like TKIP, the keys the administrator provides are used to derive other keys. Messages are encrypted using a 128-bit secret key and a 128-bit block of data. The end result is an encryption scheme as secure as any the AP-5131 provides.

To configure WPA2-CCMP on the AP-5131:

1. Select **Network Configuration** -> **Wireless** -> **Security** from the AP-5131 menu tree.

If security policies supporting WPA2-CCMP exist, they appear within the **Security Configuration** screen. These existing policies can be used as is, or their properties edited by clicking the **Edit** button. To configure a new security policy supporting WPA2-CCMP, continue to step 2.

2. Click the **Create** button to configure a new policy supporting WPA2-CCMP. The **New Security Policy** screen displays with no authentication or encryption options selected.
3. Select the **WPA2/CCMP (802.11i)** checkbox. The **WPA2/CCMP Settings** field displays within the New Security Policy screen.
4. Ensure the **Name** of the security policy entered suits the intended configuration or function of the policy.

The screenshot shows the 'New Security Policy' configuration window. The 'Name' field is set to 'wpa2 comp'. Under the 'Authentication' section, 'Manually Pre-shared key / No authentication' is selected. Under the 'Encryption' section, 'WPA2/CCMP (802.11i)' is selected. The 'WPA2/CCMP Settings' section is expanded, showing 'Key Rotation Settings' with 'Broadcast Key Rotation' checked and 'Update broadcast keys every' set to '86400 (300-804800) seconds'. The 'Key Settings' section shows '256-bit Key' selected, with two hex input fields containing '1211121314151617' and '18191A1B1C1D1E1F', and another two hex input fields containing '2021222324252627' and '28292A2B2C2D2E2F'. The 'WPA2-CCMP Mixed Mode' section has 'Allow WPA-THP clients' checked. The 'Fast Roaming (802.1x only)' section has 'Pre-Authentication' unchecked. Buttons for 'Apply', 'Cancel', and 'Help' are at the bottom right.

5. Configure the **Key Rotation Settings** field as required to set Broadcast Key Rotation and the update interval.

Broadcast Key Rotation Select the **Broadcast Key Rotation** checkbox to enable or disable the broadcasting of encryption key changes to MUs. Only broadcast key changes when required by associated MUs to reduce the transmissions of sensitive key information. This option is disabled by default.

Update broadcast keys every (300-604800 seconds) Specify a time period in seconds for broadcasting encryption key changes to MUs. Set key broadcasts to a shorter interval (at least 30 seconds) for tighter security on the WLAN's wireless connections. Set key broadcasts to a longer interval to extend the key times for wireless connections. Default is 86,400 seconds.

6. Configure the **Key Settings** area as needed to set an ASCII Passphrase and 128-bit key.

ASCII Passphrase To use an ASCII passphrase (and not a hexadecimal value), select the checkbox enter an alphanumeric string of 8 to 63 characters. The string allows character spaces. The AP-5131 converts the string to a numeric value. This passphrase saves the administrator from entering the 256-bit key each time keys are generated.

256-bit Key To use a hexadecimal value (and not an ASCII passphrase), select the checkbox and enter 16 hexadecimal characters into each of the four fields displayed.

Default (hexadecimal) 256-bit keys for WP2A/CCMP include:

1011121314151617

18191A1B1C1D1E1F

2021222324252627

28292A2B2C2D2E2F

7. Configure the **WPA2-CCMP Mixed Mode** field as needed to allow TKIP and WPA2 client interoperation.

Allow WPA-TKIP clients WPA2-CCMP Mixed Mode enables WPA2-CCMP and WPA-TKIP clients to operate together on the network. Enabling this option allows backwards compatibility for clients that support WPA-TKIP but do not support WPA2-CCMP. Symbol recommends enabling this feature if WPA-TKIP supported MUs operate within a WLAN populated by WPA2-CCMP enabled clients.

8. Configure the **Fast Roaming (802.1x only)** field as required to enable additional AP-5131 roaming and key caching options. This feature is applicable only when using 802.1x EAP authentication with WPA2/CCMP.

Pre-Authentication Selecting this option enables an associated MU to carry out an 802.1x authentication with another AP-5131 before it roams to it. The AP-5131 caches the keying information of the client until it roams to the other AP-5131. This enables the roaming client to start sending and receiving data sooner by not having to do 802.1x authentication after it roams. This feature is only supported when 802.1x EAP authentication is enabled.

9. Click the **Apply** button to save any changes made within the WPA2/CCMP Settings field of the New Security Policy screen.
10. Click the **Cancel** button to undo any changes made within the WPA2/CCMP Settings field and return to the **WLAN** screen. This reverts all settings to the last saved configuration.

6.10 Configuring Firewall Settings

The AP-5131's firewall is a set of related programs located in the gateway on the WAN side of the AP-5131. The firewall uses a collection of filters to screen information packets for known types of system attacks. Some of the AP-5131's filters are continuously enabled, others are configurable.

Use the AP-5131's **Firewall** screen to enable or disable the configurable firewall filters. Enable each filter for maximum security. Disable a filter if the corresponding attack does not seem a threat in order to reduce processor overhead. Use the WLAN Security screens (WEP, Kerberos etc.) as required for setting user authentication and data encryption parameters.

To configure the AP-5131 firewall settings:

1. Select **Network Configuration** -> **Firewall** from the AP-5131 menu tree.

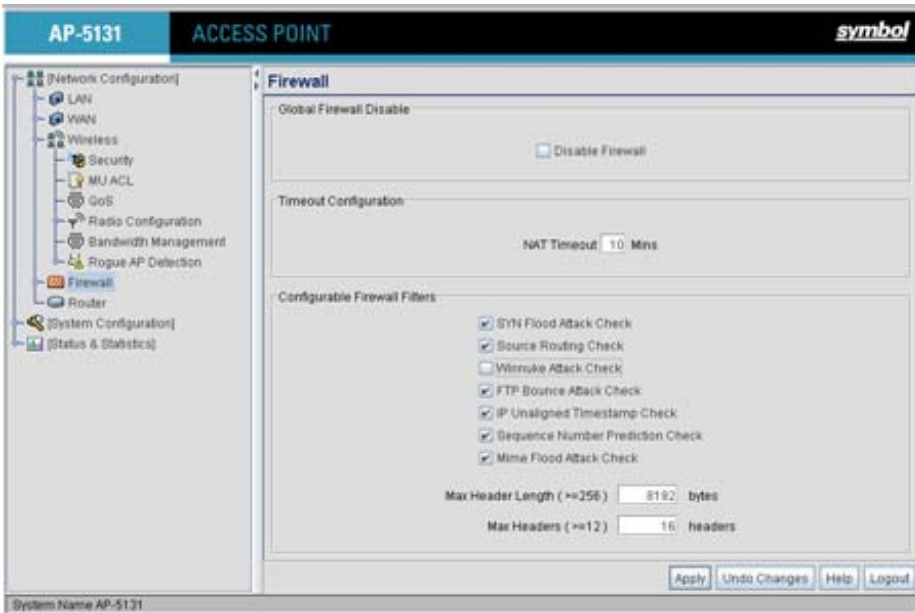

2. Refer to the **Global Firewall Disable** field to enable or disable the AP-5131 firewall.

Disable Firewall

Select the **Disable Firewall** checkbox to disable all firewall functions on the AP-5131. This includes firewall filters, NAT, VPN, content filtering, and subnet access. Disabling the AP-5131 firewall makes the AP-5131 vulnerable to data attacks and is not recommended during normal operation if using the WAN port.

3. Refer to the **Timeout Configuration** field to define a timeout interval to terminate IP address translations.

NAT Timeout

Network Address Translation (NAT) converts an IP address in one network to a different IP address or set of IP addresses in a different network. Set a **NAT Timeout** interval (in minutes) the AP-5131 uses to terminate the IP address translation process if no translation activity is detected after the specified interval.

4. Refer to the **Configurable Firewall Filters** field to set the following firewall filters:

<i>SYN Flood Attack Check</i>	A SYN flood attack requests a connection and then fails to promptly acknowledge a destination host's response, leaving the destination host vulnerable to a flood of connection requests.
<i>Source Routing Check</i>	A source routing attack specifies an exact route for a packet's travel through a network, while exploiting the use of an intermediate host to gain access to a private host.
<i>Winnuke Attack Check</i>	A "Win-nuking" attack uses the IP address of a destination host to send junk packets to its receiving port.
<i>FTP Bounce Attack Check</i>	An FTP bounce attack uses the PORT command in FTP mode to gain access to arbitrary ports on machines other than the originating client.
<i>IP Unaligned Timestamp Check</i>	An IP unaligned timestamp attack uses a frame with the IP timestamp option, where the timestamp is not aligned on a 32-bit boundary.
<i>Sequence Number Prediction Check</i>	A sequence number prediction attack establishes a three-way TCP connection with a forged source address. The attacker guesses the sequence number of the destination host response.
<i>Mime Flood Attack Check</i>	A MIME flood attack uses an improperly formatted MIME header in "sendmail" to cause a buffer overflow on the destination host.
<i>Max Header Length</i>	Use the Max Header Length field to set the maximum allowable header length (at least 256 bytes).
<i>Max Headers</i>	Use the Max Headers field to set the maximum number of headers allowed (at least 12 headers).

5. Click **Apply** to save any changes to the Firewall screen. Navigating away from the screen without clicking the Apply button results in all changes to the screens being lost.
6. Click **Undo Changes** (if necessary) to undo any changes made. Undo Changes reverts the settings displayed on the Firewall screen to the last saved configuration.
7. Click **Logout** to securely exit the AP-5131 Symbol Access Point applet. A prompt displays confirming the logout before the applet is closed.

6.10.1 Configuring LAN to WAN Access

The AP-5131 LAN can be configured to communicate with the WAN side of the AP-5131. Use the **Subnet Access** screen to allow/deny access to the AP-5131 WAN protocols, specify names and properties for existing protocols and enable pre-configured protocols (FTP, TFTP, Telnet ect.).

To configure AP-5131 subnet access:

1. Select **Network Configuration** -> **Firewall** -> **Subnet Access** from the AP-5131 menu tree.
2. Refer to the Overview table to view rectangles representing subnet associations. The three possible colors indicate the current access level, as defined, for each subnet association.

Color	Access Type	Description
Green	Full Access	No protocol exceptions (rules) are specified. All traffic may pass between these two areas.
Yellow	Limited Access	One or more protocol rules are specified. Specific protocols are either enabled or disabled between these two areas. Click the table cell of interest and look at the exceptions area in the lower half of the screen to determine the protocols that are either allowed or denied.
Red	No Access	All protocols are denied, without exception. No traffic will pass between these two areas.

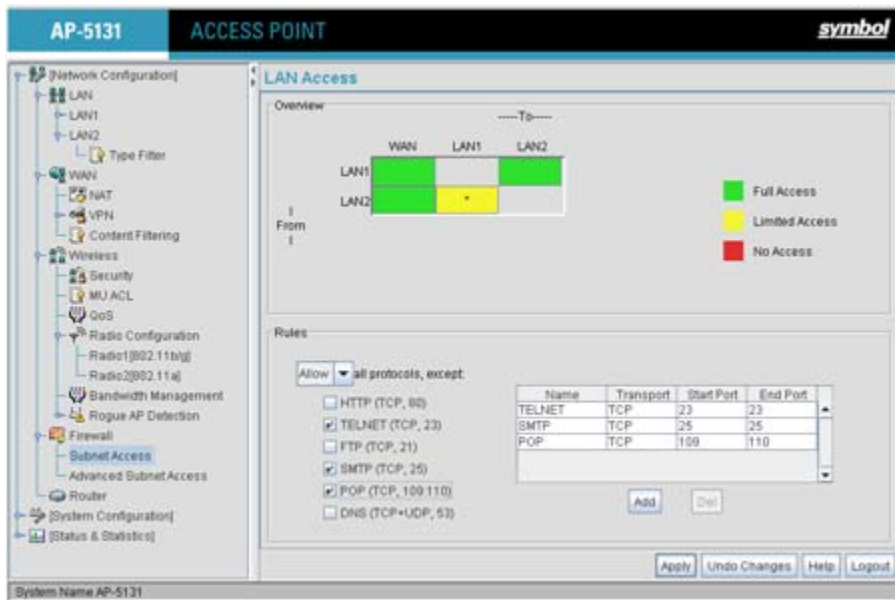

3. Configure the **Rules** field as required to allow or deny access to selected (enabled) protocols.

Allow or Deny all protocols, except

Use the drop-down menu to select either **Allow** or **Deny**. The selected setting applies to all protocols except those with enabled checkboxes and any traffic that is added to the table. For example, if the adoption rule is to Deny access to all protocols except those listed, access is allowed only to those selected protocols.

<i>Pre configured Rules</i>	<p>The following protocols are preconfigured with the AP-5131. To enable a protocol, check the box next to the protocol name.</p> <ul style="list-style-type: none"> • HTTP - <i>Hypertext Transfer Protocol</i> is the protocol for transferring files on the Web. HTTP is an application protocol running on top of the TCP/IP suite of protocols, the foundation protocols for the Internet. The HTTP protocol uses TCP port 80. • TELNET - TELNET is the terminal emulation protocol of TCP/IP. TELNET uses TCP to achieve a virtual connection between server and client, then negotiates options on both sides of the connection. TELNET uses TCP port 23. • FTP - <i>File Transfer Protocol (FTP)</i> is an application protocol using the Internet's TCP/IP protocols. FTP provides an efficient way to exchange files between computers on the Internet. FTP uses TCP port 21. • SMTP - <i>Simple Mail Transfer Protocol</i> is a TCP/IP protocol for sending and receiving email. Due to its limited ability to queue messages at the receiving end, SMTP is often used with POP3 or IMAP. SMTP sends the email, and POP3 or IMAP receives the email. SMTP uses TCP port 25. • POP - <i>Post Office Protocol</i> is a TCP/IP protocol intended to permit a workstation to dynamically access a maildrop on a server host. A workstation uses POP3 to retrieve email that the server is holding for it. • DNS - <i>Domain Name Service</i> protocol searches for resources using a database distributed among different name servers.
<i>Add</i>	Click Add to create a new table entry.
<i>Del (Delete)</i>	Click Del (Delete) to remove a selected list entry.
<i>Name</i>	Specify a name for a newly configured protocol.
<i>Transport</i>	Select a protocol from the drop-down menu. For a detailed description of the protocols available, see Available Protocols on page 6-31 .
<i>Start Port</i>	Enter the starting port number for a range of ports. If the protocol uses a single port, enter that port in this field.

End Port Enter the ending port number for a port range. If the protocol uses a single port, leave the field blank. A new entry might use *Web Traffic* for its name, *TCP* for its protocol, and *80* for its port number.

4. Click **Apply** to save any changes to the Subnet Access screen. Navigating away from the screen without clicking the Apply button results in all changes to the screens being lost.
5. Click **Undo Changes** (if necessary) to undo any changes made. Undo Changes reverts the settings displayed on the Subnet Access screen to the last saved configuration.
6. Click **Logout** to securely exit the AP-5131 Symbol Access Point applet. A prompt displays confirming the logout before the applet is closed.

6.10.1.1 Available Protocols

Protocols that are not pre-configured can be specified using the drop down list within the **Transport** column within the Subnet Access and Advanced Subnet Access screens. They include:

- **ALL** - Enables all of the protocol options displayed in the drop-down menu (as described below).
- **TCP** - *Transmission Control Protocol* is a set of rules for sending data as message units over the Internet. TCP manages individual data packets. Messages are divided into packets for efficient routing through the Internet.
- **UDP** - *User Datagram Protocol* is used for broadcasting data over the Internet. Like TCP, UDP runs on top of Internet Protocol (IP) networks. Unlike TCP/IP, UDP/IP provides few error recovery services. UDP offers a way to directly connect, and then send and receive datagrams over an IP network.
- **ICMP** - *Internet Control Message Protocol* is tightly integrated with IP. ICMP messages are used for out-of-band messages related to network operation. ICMP packet delivery is unreliable. Hosts cannot count on receiving ICMP packets for a network problem.
- **AH** - Authentication Header is one of the two key components of IP Security Protocol (IPsec). The other key component is *Encapsulating Security Protocol (ESP)*.

AH provides authentication, proving the packet sender really is the sender, and the data really is the data sent. AH can be used in transport mode, providing security between two end points. Also, AH can be used in tunnel mode, providing security like that of a Virtual Private Network (VPN).

- **ESP** - *Encapsulating Security Protocol* is one of two key components of IP Security Protocol (IPsec). The other key component is Authentication Header (AH). ESP encrypts the packets and provides authentication services. ESP can be used in transport mode, providing security

between two end points. ESP can also be used in tunnel mode, providing security like that of a *Virtual Private Network (VPN)*.

- **GRE - General Routing Encapsulation** supports VPNs across the Internet. GRE is a mechanism for encapsulating network layer protocols over any other network layer protocol. Such encapsulation allows routing of IP packets between private IP networks across an Internet using globally assigned IP addresses.

6.10.2 Configuring Advanced Subnet Access

Use the **Advanced Subnet Access** screen to configure complex access rules and filtering based on source port, destination port, and transport protocol. To enable advanced subnet access, the subnet access rules must be overridden. However, the Advanced Subnet Access screen allows you to import existing subnet access rules into the advanced subnet access rules.

To configure AP-5131 Advanced Subnet Access:

1. Select **Network Configuration -> Firewall -> Advanced Subnet Access** from the AP-5131 menu tree.

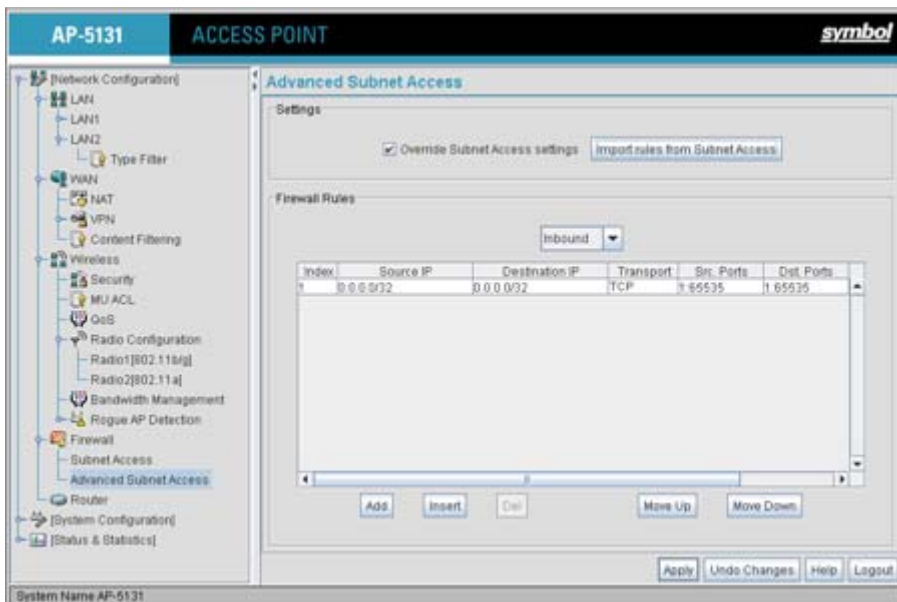

2. Configure the **Settings** field as needed to override the settings in the Subnet Access screen and import firewall rules into the Advanced Subnet Access screen.

Override Subnet Access settings Select this checkbox to enable advanced subnet access rules and disable existing subnet access rules, port forwarding, and 1 to many mappings from the system. Only enable advanced subnet access rules if your configuration requires rules that cannot be configured within the **Subnet Access** screen.

Import rules from Subnet Access Select this checkbox to import existing access rules (NAT, packet forwarding, VPN rules etc.) into the **Firewall Rules** field. This rule import overrides any existing rules configured in the Advanced Subnet Access screen. A warning box displays stating the operation cannot be undone.

3. Configure the **Firewall Rules** field as required add, insert or delete firewall rules into the list of advanced rules.

Inbound or Outbound Select **Inbound** or **Outbound** from the drop-down menu to specify if a firewall rule is intended for inbound traffic to an interface or outbound traffic from that interface.

Add Click the **Add** button to insert a new rule at the bottom of the table. Click on a row to display a new window with configuration options for that field.

Insert Click the **Insert** button to insert a new rule directly above a selected rule in the table. Clicking on a field in the row displays a new window with configuration options.

Del (Delete) Click **Del** to remove the selected rule from the table. The index numbers for all the rows below the deleted row decrease by 1.

Move Up Clicking the **Move Up** button moves the selected rule up by one row in the table. The index numbers for the affected rows adjust to reflect the new order.

Move Down Clicking the **Move Down** button moves the selected rule down by one row in the table. The index numbers for the affected rows adjust to reflect the new order.

Index The index number determines the order firewall rules are executed. Rules are executed from the lowest number to the highest number.

<i>Source IP</i>	The Source IP range defines the origin address or address range for the firewall rule. To configure the Source IP range, click on the field. A new window displays for entering the IP address and range.
<i>Destination IP</i>	The Destination IP range determines the target address or address range for the firewall rule. To configure the Destination IP range, click on the field. A new window displays for entering the IP address and range.
<i>Transport</i>	Select a protocol from the drop-down list. For a detailed description of the protocols available, see Available Protocols on page 6-31 .
<i>Src. Ports (Source Ports)</i>	The source port range determines which ports the firewall rule applies to on the source IP address. Click on the field to configure the source port range. A new window displays to enter the starting and ending port ranges. For rules where only a single port is necessary, enter the same port in the start and end port fields.
<i>Dst. Ports (Destination Ports)</i>	The destination port range determines which ports the firewall rule applies to on the destination IP address. Click on the field to configure the destination port range. A new window displays to enter the starting and ending ports in the range. For rules where only a single port is necessary, enter the same port in the start and end port fields.

4. Click **Apply** to save any changes to the Advanced Subnet Access screen. Navigating away from the screen without clicking Apply results in all changes to the screens being lost.
5. Click **Undo Changes** (if necessary) to undo any changes made. Undo Changes reverts the settings displayed on the Advanced Subnet Access screen to the last saved configuration.
6. Click **Logout** to securely exit the AP-5131 Symbol Access Point applet. A prompt displays confirming the logout before the applet is closed.

6.11 Configuring VPN Tunnels

The AP-5131 allows up to 25 VPN tunnels to either a VPN endpoint or to another AP-5131. VPN tunnels allow all traffic on a local subnet to route securely through a IPSEC tunnel to a private network. A VPN port is a virtual port which handles tunneled traffic.

When connecting to another site using a VPN, the traffic is encrypted so if anyone intercepts the traffic, they cannot see what it is unless they can break the encryption. The traffic is encrypted from your computer through the network to the VPN. At that point the traffic is decrypted.

Use the **VPN** screen to add and remove VPN tunnels. To configure an existing VPN tunnel, select it from the list in the **VPN Tunnels** field. The selected tunnel's configuration displays in a **VPN Tunnel Config** field.

To configure a VPN tunnel on the AP-5131:

1. Select **Network Configuration** -> **WAN** -> **VPN** from the AP-5131 menu tree.

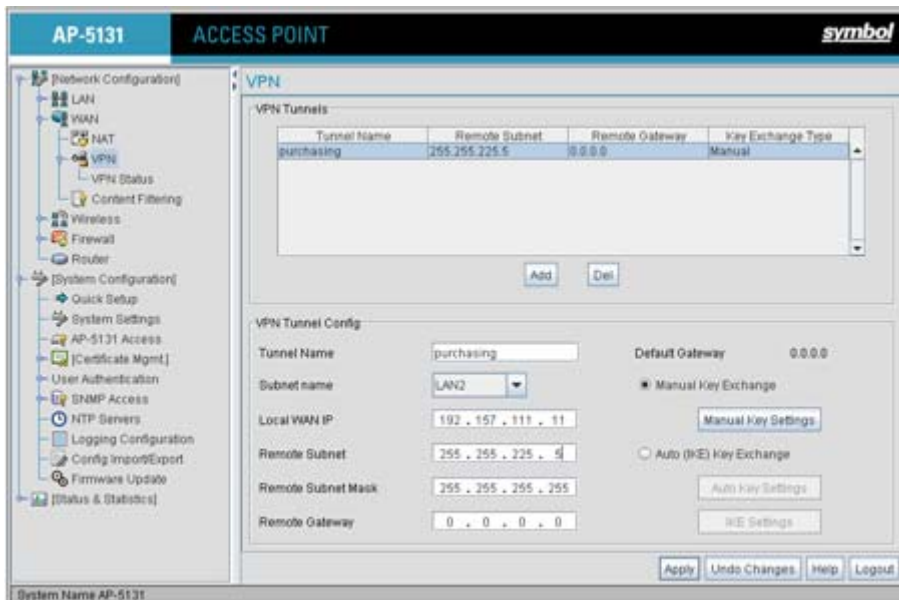

2. Use the **VPN Tunnels** field to add or delete a tunnel to the list of available tunnels, list tunnel network address information and display key exchange information for each tunnel.

Add

Click **Add** to add a VPN tunnel to the list. To configure a specific tunnel, select it from the list and use the parameters within the **VPN Tunnel Config** field to set its properties.

Del

Click **Del** to delete a highlighted VPN tunnel. There is no confirmation before deleting the tunnel.

Tunnel Name

The **Tunnel Name** column lists the name of each VPN tunnel on the AP-5131.

<i>Remote Subnet</i>	The Remote Subnet column lists the remote subnet for each tunnel. The remote subnet is the subnet the remote network uses for connection.
<i>Remote Gateway</i>	The Remote Gateway column lists a remote gateway IP address for each tunnel. The numeric remote gateway is the gateway IP address on the remote network the VPN tunnel connects to. Ensure the address is the same as the WAN port address of the target gateway AP or switch.
<i>Key Exchange Type</i>	The Key Exchange Type column lists the key exchange type for passing keys between both ends of a VPN tunnel. If <i>Manual Key Exchange</i> is selected, this column displays Manual. If <i>Auto (IKE) Key Exchange</i> is selected, the field displays Automatic .



NOTE When creating a tunnel, the remote subnet and remote subnet mask must be that of the target device's LAN settings. The remote gateway must be that of the target device's WAN IP address.

If AP-5131 #1 has the following values:

- WAN IP address: 20.1.1.2
- LAN IP address: 10.1.1.1
- Subnet Mask: 255.0.0.0

Then, the VPN values for AP-5131 #2 should be:

- Remote subnet: 10.1.1.0 or 10.0.0.0
 - Remote subnet mask: 255.0.0.0
 - Remote gateway: 20.1.1.2
3. If a VPN tunnel has been added to the list of available AP-5131 tunnels, use the **VPN Tunnel Config** field to optionally modify the tunnel's properties.

Tunnel Name Enter a name to define the VPN tunnel. The tunnel name is used to uniquely identify each tunnel. Select a name best suited to that tunnel's function so it can be selected again in the future if required in a similar application.

<i>Subnet name</i>	Use the drop-down menu to specify the LAN1 or LAN2 connection used for routing VPN traffic. Remember, only one LAN connection can be active on the AP-5131 Ethernet port at a time. The LAN connection specified from the LAN screen to receive priority for Ethernet port connectivity may be the better subnet to select for VPN traffic.
<i>Local WAN IP</i>	Enter the WAN's numerical (non-DNS) IP address in order for the tunnel to pass traffic to a remote network.
<i>Remote Subnet</i>	Specify the numerical (non-DNS) IP address for the Remote Subnet.
<i>Remote Subnet Mask</i>	Enter the subnet mask for the tunnel's remote network for the tunnel. The remote subnet mask is the subnet setting for the remote network the tunnel connects to.
<i>Remote Gateway</i>	Enter a numerical (non-DNS) remote gateway IP address for the tunnel. The remote gateway IP address is the gateway address on the remote network the VPN tunnel connects to.
<i>Default Gateway</i>	Displays the WAN interface's default gateway IP address.
<i>Manual Key Exchange</i>	Selecting Manual Key Exchange requires you to manually enter keys for AH and/or ESP encryption and authentication. Click the Manual Key Settings button to configure the settings.
<i>Manual Key Settings</i>	Select Manual Key Exchange and click the Manual Key Settings button to open a screen where AH authentication and ESP encryption/authentication can be configured and keys entered. For more information, see Configuring Manual Key Settings on page 6-38 .
<i>Auto (IKE) Key Exchange</i>	Select the Auto (IKE) Key Exchange checkbox to configure AH and/or ESP without having to manually enter keys. The keys automatically generate and rotate for the authentication and encryption type selected.
<i>Auto Key Settings</i>	Select the Auto (IKE) Key Exchange checkbox, and click the Auto Key Settings button to open a screen where AH authentication and ESP encryption/authentication can be configured. For more information, see Configuring Auto Key Settings on page 6-42 .

IKE Settings

After selecting Auto (IKE) Key Exchange, click the **IKE Settings** button to open a screen where IKE specific settings can be configured. For more information, see [Configuring IKE Key Settings on page 6-44](#).

4. Click **Apply** to save any changes to the **VPN** screen as well as changes made to the Auto Key Settings, IKE Settings and Manual Key Settings screens. Navigating away from the screen without clicking the Apply button results in all changes to the screens being lost.
5. Click **Undo Changes** (if necessary) to undo any changes made. Undo Changes reverts the settings displayed on the VPN, Auto Key Settings, IKE Settings and Manual Key Settings screens to the last saved configuration.
6. Click **Logout** to securely exit the AP-5131 Symbol Access Point applet. A prompt displays confirming the logout before the applet is closed.

6.11.1 Configuring Manual Key Settings

A transform set is a combination of security protocols and algorithms applied to IPSec protected traffic. During *security association (SA)* negotiation, both gateways agree to use a particular transform set to protect data flow.

A transform set specifies one or two IPSec security protocols (either AH, ESP, or both) and specifies the algorithms to use for the selected security protocol. If you specify an ESP protocol in a transform set, specify just an ESP encryption transform or both an ESP encryption transform and an ESP authentication transform.

When the particular transform set is used during negotiations for IPSec SAs, the entire transform set (the combination of protocols, algorithms, and other settings) must match a transform set at the remote end of the gateway.

Use the **Manual Key Settings** screen to specify the transform sets used for VPN access.

To configure manual key settings for the AP-5131:

1. Select **Network Configuration** -> **WAN** -> **VPN** from the AP-5131 menu tree.
2. Refer to the **VPN Tunnel Config** field, select the **Manual Key Exchange** radio button and click the **Manual Key Settings** button.

3. Configure the **Manual Key Settings** screen to modify the following:



NOTE When entering Inbound or Outbound encryption or authentication keys, an error message could display stating the keys provided are “weak”. Some WEP attack tools invoke a dictionary to hack WEP keys based on commonly used words. To avoid entering a weak key, try to not to produce a WEP key using commonly used terms and attempt to mix alphabetic and numerical key attributes when possible.

AH Authentication

AH provides data authentication and anti-replay services for the VPN tunnel. Select the required authentication method from the drop-down menu:

- None - Disables AH authentication. The rest of the fields are not active.
- MD5 - Enables the Message Digest 5 algorithm requiring 128-bit (32-character hexadecimal) keys.
- SHA1 - Enables Secure Hash Algorithm 1, requiring 160-bit (40-character hexadecimal) keys.

<i>Inbound AH Authentication Key</i>	Configure a key for computing the integrity check on inbound traffic with the selected authentication algorithm. The key must be 32/40 (for MD5/SHA1) hexadecimal (0-9, A-F) characters in length. The key value must match the corresponding outbound key on the remote security gateway.
<i>Outbound AH Authentication Key</i>	Configure a key for computing the integrity check on outbound traffic with the selected authentication algorithm. The key must be 32/40 (for MD5/SHA1) hexadecimal (0-9, A-F) characters in length. The key value must match the corresponding inbound key on the remote security gateway.
<i>Inbound SPI (Hex)</i>	Enter an up to six-character hexadecimal value to identify the inbound security association created by the AH algorithm. The value must match the corresponding outbound SPI value configured on the remote security gateway.
<i>Outbound SPI (Hex)</i>	Provide an up to six-character hexadecimal value to identify the outbound security association created by the AH algorithm. The value must match the corresponding inbound SPI value configured on the remote security gateway.
<i>ESP Type</i>	ESP provides packet encryption, optional data authentication and anti-replay services for the VPN tunnel. Use the drop-down menu to select the ESP type. Options include: <ul style="list-style-type: none">• None - Disables ESP. The rest of the fields are not be active.• ESP - Enables ESP for the tunnel.• ESP with Authentication - Enables ESP with authentication.
<i>ESP Encryption Algorithm</i>	Select the encryption and authentication algorithms for the VPN tunnel using the drop-down menu. <ul style="list-style-type: none">• DES - Uses the DES encryption algorithm requiring 64-bit (16-character hexadecimal) keys.• 3DES - Uses the 3DES encryption algorithm requiring 192-bit (48-character hexadecimal) keys.• AES 128-bit: - Uses the Advanced Encryption Standard algorithm with 128-bit (32-character hexadecimal) keys.• AES 192-bit: - Uses the Advanced Encryption Standard algorithm with 192-bit (48-character hexadecimal) keys.• AES 256-bit: - Uses the Advanced Encryption Standard algorithm with 256-bit (64-character hexadecimal) keys.

<i>Inbound ESP Encryption Key</i>	Enter a key for inbound traffic. The length of the key is determined by the selected encryption algorithm. The key must match the outbound key at the remote gateway.
<i>Outbound ESP Encryption Key</i>	Define a key for outbound traffic. The length of the key is determined by the selected encryption algorithm. The key must match the inbound key at the remote gateway.
<i>ESP Authentication Algorithm</i>	Select the authentication algorithm to use with ESP. This option is available only when ESP with Authentication was selected for the ESP type. Options include: <ul style="list-style-type: none"> • MD5 - Enables the Message Digest 5 algorithm, which requires 128-bit (32-character hexadecimal) keys. • SHA1 - Enables Secure Hash Algorithm 1, which requires 160-bit (40-character hexadecimal) keys.
<i>Inbound ESP Authentication Key</i>	Define a key for computing the integrity check on the inbound traffic with the selected authentication algorithm. The key must be 32/40 (for MD5/SHA1) hexadecimal (0-9, A-F) characters in length. The key must match the corresponding outbound key on the remote security gateway.
<i>Outbound ESP Authentication Key</i>	Enter a key for computing the integrity check on outbound traffic with the selected authentication algorithm. The key must be 32/40 (for MD5/SHA1) hexadecimal (0-9, A-F) characters in length. The key must match the corresponding inbound key on the remote security gateway.
<i>Inbound SPI (Hex)</i>	Define an up to six-character (maximum) hexadecimal value to identify the inbound security association created by the encryption algorithm. The value must match the corresponding outbound SPI value configured on the remote security gateway.
<i>Outbound SPI (Hex)</i>	Enter an up to six (maximum) hexadecimal value to identify the outbound security association created by the encryption algorithm. The value must match the corresponding inbound SPI value configured on the remote security gateway.

The Inbound and Outbound SPI settings are required to be interpolated to function correctly. For example:

AP1 Inbound SPI = 800

AP1 Outbound SPI = 801

AP2 Inbound SPI = 801

AP2 Outbound SPI = 800

4. Click **Ok** to return to the VPN screen. Click Apply to retain the settings made on the **Manual Key Settings** screen.
5. Click **Cancel** to return to the VPN screen without retaining the changes made to the **Manual Key Settings** screen.

6.11.2 Configuring Auto Key Settings

The AP-5131's Network Management System can automatically set encryption and authentication keys for VPN access. Use the **Auto Key Settings** screen to specify the type of encryption and authentication, without specifying the keys. To manually specify keys, cancel out of the **Auto Key Settings** screen, select the **Manual Key Exchange** radio button, and set the keys within the **Manual Key Setting** screen.

To configure auto key settings for the AP-5131:

1. Select **Network Configuration** -> **WAN** -> **VPN** from the AP-5131 menu tree.
2. Refer to the **VPN Tunnel Config** field, select the **Auto (IKE) Key Exchange** radio button and click the **Auto Key Settings** button.



3. Configure the **Auto Key Settings** screen to modify the following:

- | | |
|---------------------------------------|---|
| <i>Use Perfect Forward Secrecy</i> | Forward secrecy is a key-establishment protocol guaranteeing the discovery of a session key or long-term private key does not compromise the keys of other sessions. Select Yes to enable Perfect Forward Secrecy. Select No to disable Perfect Forward Secrecy. |
| <i>Security Association Life Time</i> | The Security Association Life Time is the configurable interval used to timeout association requests that exceed the defined interval. The available range is from 300 to 65535 seconds. The default is 300 seconds. |
| <i>AH Authentication</i> | AH provides data authentication and anti-replay services for the VPN tunnel. Select the desired authentication method from the drop-down menu. <ul style="list-style-type: none"> • None - Disables AH authentication. No keys are required to be manually provided. • MD5 - Enables the Message Digest 5 algorithm. No keys are required to be manually provided. • SHA1 - Enables Secure Hash Algorithm 1. No keys are required to be manually provided. |
| <i>ESP Type</i> | ESP provides packet encryption, optional data authentication and anti-replay services for the VPN tunnel. Use the drop-down menu to select the ESP type. <ul style="list-style-type: none"> • None - Disables ESP. The rest of the fields are not active. • ESP - Enables ESP for this tunnel. • ESP with Authentication - Enables ESP with authentication. |

ESP Encryption Algorithm

Use this menu to select the encryption and authentication algorithms for this VPN tunnel.

- DES - Selects the DES algorithm. No keys are required to be manually provided.
- 3DES - Selects the 3DES algorithm. No keys are required to be manually provided.
- AES 128-bit: - Selects the Advanced Encryption Standard algorithm with 128-bit. No keys are required to be manually provided.
- AES 192-bit: - Selects the Advanced Encryption Standard algorithm with 192-bit. No keys are required to be manually provided.
- AES 256-bit: - Selects the Advanced Encryption Standard algorithm with 256-bit. No keys are required to be manually provided.

ESP Authentication Algorithm

Use this menu to select the authentication algorithm to be used with ESP. This menu is only active when ESP with Authentication was selected for the ESP type.

- MD5 - Enables the Message Digest 5 algorithm requiring 128-bit. No keys are required to be manually provided.
- SHA1 - Enables Secure Hash Algorithm. No keys are required to be manually provided.

4. Click **Ok** to return to the VPN screen. Click Apply to retain the settings made on the **Auto Key Settings** screen.
5. Click **Cancel** to return to the VPN screen without retaining the changes made to this screen.

6.11.3 Configuring IKE Key Settings

The *Internet Key Exchange (IKE)* is an IPsec standard protocol used to ensure security for VPN negotiation and remote host or network access. IKE provides an automatic means of negotiation and authentication for communication between two or more parties. In essence, IKE manages IPSec keys automatically for the parties.

To configure IKE key settings for the AP-5131:

1. Select **Network Configuration** -> **WAN** -> **VPN** from the AP-5131 menu tree.
2. Refer to the **VPN Tunnel Config** field, select the **Auto (IKE) Key Exchange** radio button and click the **IKE Settings** button.

IKE Settings

Operation Mode: Main Mode

Local ID Type: FQDN
Local ID Data: tunnel1

Remote ID Type: FQDN
Remote ID Data: tunnel1

IKE Authentication Mode: Pre Shared Key (PSK)
IKE Authentication Algorithm: SHA1
IKE Authentication Passphrase: #####

IKE Encryption Algorithm: 3DES

Key Lifetime: 3600 sec

Diffie-Hellman Group: Group 1 - 768 bit

OK Cancel Help

Java Applet Window

3. Configure the **IKE Key Settings** screen to modify the following:

Operation Mode

The Phase I protocols of IKE are based on the ISAKMP identity-protection and aggressive exchanges. IKE main mode refers to the identity-protection exchange, and IKE aggressive mode refers to the aggressive exchange.

- Main - Standard IKE mode for communication and key exchange.
- Aggressive - Aggressive mode is faster, but less secure than Main mode. Identities are not encrypted unless public key encryption is used. The authentication method cannot be negotiated if the initiator chooses public key encryption

- Local ID Type* Select the type of ID to be used for the AP-5131 end of the SA.
- IP - Select IP if the local ID type is the IP address specified as part of the tunnel.
 - FQDN - Use FQDN if the local ID is a fully qualified domain name (such as sj.symbol.com).
 - UFQDN - Select UFQDN if the local ID is a user fully-qualified email (such as johndoe@symbol.com).
- Local ID Data* Specify the FQDN or UFQDN based on the Local ID type assigned.
- Remote ID Type* Select the type of ID to be used for the AP-5131 end of the tunnel from the **Remote ID Type** drop-down menu.
- IP - Select the IP option if the remote ID type is the IP address specified as part of the tunnel.
 - FQDN - Select FQDN if the remote ID type is a fully qualified domain name (such as sj.symbol.com). The setting for this field does not have to be fully qualified, however it must match the setting for the Certificate Authority.
 - UFQDN - Select this item if the remote ID type is a user unqualified email address (such as johndoe@symbol.com). The setting for this field does not have to be unqualified, it just must match the setting of the field of the Certificate Authority.
- Remote ID Data* If FQDN or UFQDN is selected, specify the data (either the qualified domain name or the user name) in the **Remote ID Data** field.
- IKE Authentication Mode* Select the appropriate IKE authentication mode:
- Pre-Shared Key (PSK) - Specify an authenticating algorithm and passcode used during authentication.
 - RSA Certificates - Select this option to use RSA certificates for authentication purposes. See the CA Certificates and Self certificates screens to create and import certificates into the system.

<i>IKE Authentication Algorithm</i>	<p>IKE provides data authentication and anti-replay services for the VPN tunnel. Select an authentication methods from the drop-down menu.</p> <ul style="list-style-type: none">• MD5 - Enables the Message Digest 5 algorithm. No keys are required to be manually provided.• SHA1 - Enables Secure Hash Algorithm. No keys are required to be manually provided.
<i>IKE Authentication Passphrase</i>	<p>If you selected Pre-Shared Key as the authentication mode, you must provide a passphrase.</p>
<i>IKE Encryption Algorithm</i>	<p>Select the encryption and authentication algorithms for the VPN tunnel from the drop-down menu.</p> <ul style="list-style-type: none">• DES - Uses the DES encryption algorithm. No keys are required to be manually provided.• 3DES - Enables the 3DES encryption algorithm. No keys are required to be manually provided.• AES 128-bit - Uses the Advanced Encryption Standard algorithm with 128-bit. No keys are required to be manually provided.• AES 192-bit - Enables the Advanced Encryption Standard algorithm with 192-bit. No keys are required to be manually provided.• AES 256-bit - Uses the Advanced Encryption Standard algorithm with 256-bit. No keys are required to be manually provided.
<i>Key Lifetime</i>	<p>The number of seconds the key is valid. At the end of the lifetime, the key is renegotiated.</p> <p>The AP-5131 forces renegotiation every 3600 seconds. There is no way to change the renegotiation value. If the IKE Lifetime is greater than 3600, the keys still get renegotiated every 3600 seconds.</p>

Diffie Hellman Group Select a **Diffie-Hellman Group** to use. The Diffie-Hellman key agreement protocol allows two users to exchange a secret key over an insecure medium without any prior secrets. Two algorithms exist, 768-bit and 1024-bit. Select one of the following options:

- Group 1 - 768 bit - Somewhat faster than the 1024-bit algorithm, but secure enough in most situations.
 - Group 2 - 1024 bit - Somewhat slower than the 768-bit algorithm, but much more secure and a better choice for extremely sensitive situations.
4. Click **Ok** to return to the VPN screen. Click Apply to retain the settings made on the **IKE Settings** screen.
 5. Click **Cancel** to return to the VPN screen without retaining the changes made to the **IKE Settings** screen.

6.11.4 Viewing VPN Status

Use the **VPN Status** screen to display the status of the tunnels configured on the AP-5131 as well as their lifetime, transmit and receive statistics. The VPN Status screen is read-only with no configurable parameters. To configure a VPN tunnel, use the *VPN* configuration screen in the WAN section of the AP-5131 menu tree.

To view VPN status on the AP-5131:

1. Select **Network Configuration** -> **WAN** -> **VPN** -> **VPN Status** from the AP-5131 menu tree.

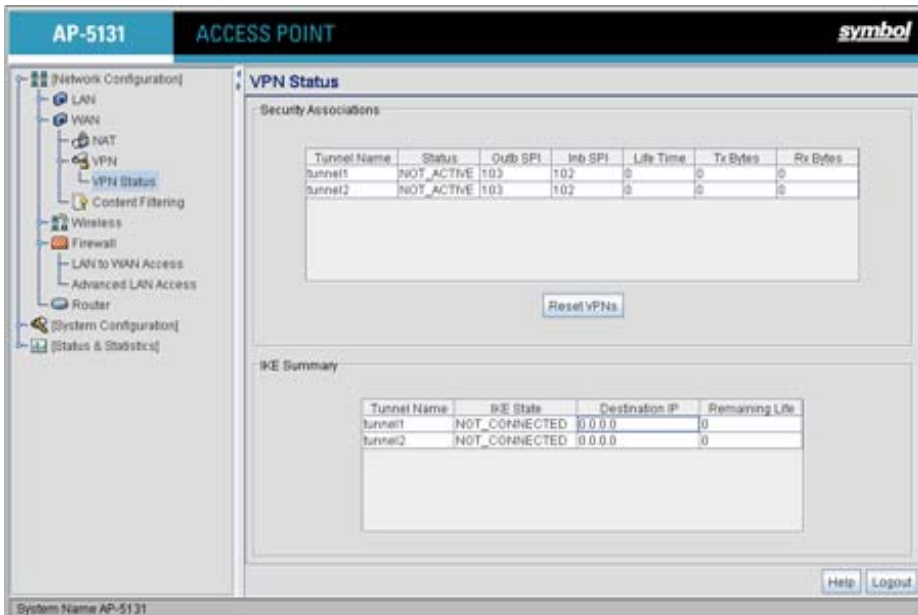

2. Reference the **Security Associations** field to view the following:

- Tunnel Name* The **Tunnel Name** column lists the names of all the tunnels configured on the AP-5131. For information on configuring a tunnel, see [Configuring VPN Tunnels on page 6-34](#).
- Status* The **Status** column lists the status of each configured tunnel. When the tunnel is not in use, the status reads **NOT_ACTIVE**. When the tunnel is connected, the status reads **ACTIVE**.
- Outb SPI* The **Outb SPI** column displays the outbound Security Parameter Index (SPI) for each tunnel. The SPI is used locally by the AP-5131 to identify a security association. There are unique outbound and inbound SPIs.
- Inb SPI* The **Inb SPI** column displays the inbound SPI Security Parameter Index (SPI) for each of the tunnels. The SPI is used locally by the AP-5131 to identify a security association. There are unique outbound and inbound SPIs.

<i>Life Time</i>	Use the Life Time column to view the lifetime associated with a particular Security Association (SA). Each SA has a finite lifetime defined. When the lifetime expires, the SA can no longer be used to protect data traffic. The maximum SA lifetime is 65535 seconds.
<i>Tx Bytes</i>	The Tx Bytes column lists the amount of data (in bytes) transmitted through each configured tunnel.
<i>Rx Bytes</i>	The Rx Bytes column lists the amount of data (in bytes) received through each configured tunnel.

- Click the **Reset VPNs** button to reset active VPNs. Selecting **Reset VPNs** forces renegotiation of all the Security Associations and keys. Users could notice a slight pause in network performance.
- Reference the **IKE Summary** field to view the following:

<i>Tunnel Name</i>	Displays the name of each of the tunnels configured to use IKE for automatic key exchange.
<i>IKE State</i>	Lists the state for each of the tunnels configured to use IKE for automatic key exchange. When the tunnel is not active, the IKE State field displays NOT_CONNECTED . When the tunnel is active, the IKE State field displays CONNECTED .
<i>Destination IP</i>	Displays the destination IP address for each tunnel configured to use IKE for automatic key exchange.
<i>Remaining Life</i>	Lists the remaining life of the current IKE key for each tunnel. When the remaining life on the IKE key reaches 0, IKE initiates a negotiation for a new key. IKE keys associated with a renegotiated tunnel.

- Click **Logout** to securely exit the AP-5131 Symbol Access Point applet. A prompt displays confirming the logout before the applet is closed.

6.12 Configuring Content Filtering Settings

Content filtering allows system administrators to block specific commands and URL extensions from going out through the AP-5131 WAN port. Therefore, content filtering affords system administrators selective control on the content proliferating the network and is a powerful data and network screening tool. Content filtering allows the blocking of up to 10 files or URL extensions and allows blocking of specific outbound HTTP, SMTP, and FTP requests.

To configure content filtering for the AP-5131:

1. Select **Network Configuration** -> **WAN** -> **Content Filtering** from the AP-5131 menu tree.

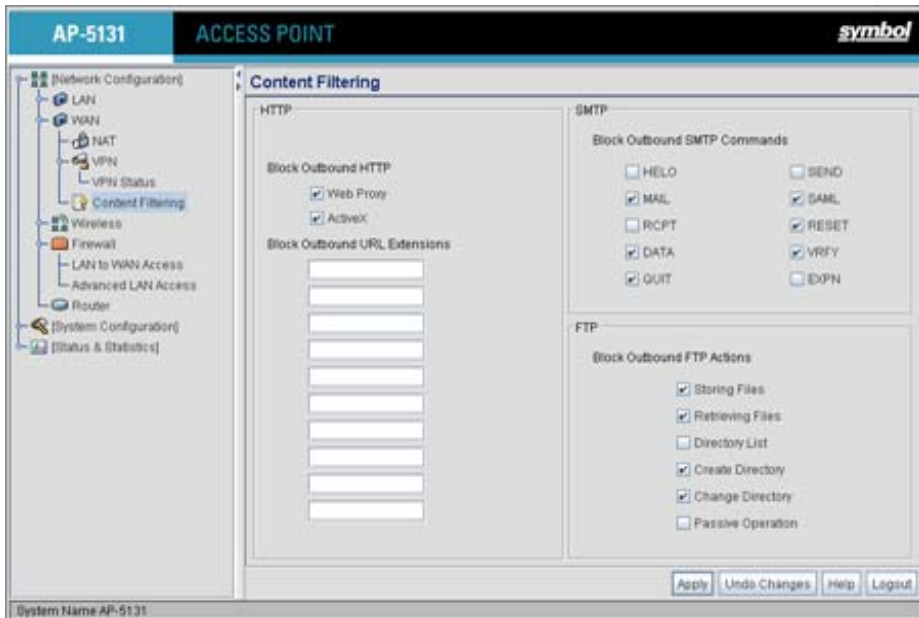

2. Configure the **HTTP** field to configure block Web proxies and URL extensions.

Block Outbound HTTP *HyperText Transport Protocol (HTTP)* is the protocol used to transfer information to and from Web sites. HTTP Blocking allows for blocking of specific HTTP commands going outbound on the AP-5131 WAN port. HTTP blocks commands on port 80 only. The Block Outbound HTTP option allows blocking of the following (user selectable) outgoing HTTP requests:

- Web Proxy: Blocks the use of Web proxies by clients
- ActiveX: Blocks all outgoing ActiveX requests by clients. Selecting ActiveX only blocks traffic (scripting language) with an .ocx extension.

Block Outbound URL Extensions Enter a URL extension or file name per line in the format of *filename.ext*. An asterisk (*) can be used as a wildcard in place of the filename to block all files with a specific extension.

3. Configure the **SMTP** field to disable or restrict specific kinds of network mail traffic.

Block Outbound SMTP Commands Simple Mail Transport Protocol (SMTP) is the Internet standard for host-to-host mail transport. SMTP generally operates over TCP on port 25. SMTP filtering allows the blocking of any or all outgoing SMTP commands. Check the box next to the command to disable that command when using SMTP across the AP-5131's WAN port.

- HELO - (Hello) Identifies the SMTP sender to the SMTP receiver.
- MAIL - Initiates a mail transaction where data is delivered to one or more mailboxes on the local server.
- RCPT: (Recipient) Identifies a recipient of mail data.
- DATA - Tells the SMTP receiver to treat the following information as mail data from the sender.
- QUIT - Tells the receiver to respond with an **OK** reply and terminate communication with the sender.
- SEND - Initiates a mail transaction where mail is sent to one or more remote terminals.
- SAML - (Send and Mail) Initiates a transaction where mail data is sent to one or more local mailboxes and remote terminals.
- RESET - Cancels mail transaction and informs the recipient to discard data sent during transaction.
- VRFY - Asks receiver to confirm the specified argument identifies a user. If argument does identify a user, the full name and qualified mailbox is returned.
- EXPN - (Expand) Asks receiver to confirm a specified argument identifies a mailing list. If the argument identifies a list, the membership list of the mailing list is returned.

4. Configure the **FTP** field to block or restrict various FTP traffic on the network.

Block Outbound FTP Actions

File Transfer Protocol (FTP) is the Internet standard for host-to-host mail transport. FTP generally operates over TCP port 20 and 21. FTP filtering allows the blocking of any or all outgoing FTP functions. Check the box next to the command to disable the command when using FTP across the AP-5131's WAN port.

- Storing Files - Blocks the request to transfer files sent from the client across the AP's WAN port to the FTP server.
 - Retrieving Files: Blocks the request to retrieve files sent from the FTP server across the AP's WAN port to the client.
 - Directory List: Blocks requests to retrieve a directory listing sent from the client across the AP's WAN port to the FTP server.
 - Create Directory: Blocks requests to create directories sent from the client across the AP's WAN port to the FTP server.
 - Change Directory: Blocks requests to change directories sent from the client across the AP's WAN port to the FTP server.
 - Passive Operation: Blocks passive mode FTP requests sent from the client across the AP's WAN port to the FTP server.
5. Click **Apply** to save any changes to the Content Filtering screen. Navigating away from the screen without clicking the Apply button results in all changes to the screens being lost.
 6. Click **Undo Changes** (if necessary) to undo any changes made. Undo Changes reverts the settings displayed on the Content Filtering screen to the last saved configuration.
 7. Click **Logout** to securely exit the AP-5131 Symbol Access Point applet. A prompt displays confirming the logout before the applet is closed.

6.13 Configuring Rogue AP Detection

It is possible that not all of the devices identified by the AP-5131 are operating legitimately within the AP-5131's radio coverage area. A rogue AP is a device located nearby an authorized Symbol AP-5131 but recognized as having properties rendering its operation illegal and threatening to the AP-5131 and the LAN. Rogue AP detection can be configured independently for both AP-5131 802.11a and 802.11b/g radios (if using a dual radio sku AP-5131). A rogue detection interval is the user-defined interval the AP-5131 waits to search for rogue APs. Additionally, the AP-5131 does not detect rogue APs on illegal channels (channels not allowed by the regulatory requirements of the country the AP-5131 is operating in).

The rogue detection interval is used in conjunction with Symbol MUs that identify themselves as rogue detection capable to the AP-5131. The detection interval defines how often the AP-5131 requests these MUs to scan for a rogue AP. A shorter interval can effect the performance of the MU, but it will also decrease the time it takes for the AP-5131 to scan for a rogue AP. A longer interval will have less of an impact to the MU's, but it will increase the amount of time used to detect rogue APs. Therefore, the interval should be set according to the perceived risk of rogue devices and the criticality of MU performance.



CAUTION Using an antenna other than the Dual-Band Antenna (Part No. ML-2452-APA2-01) could render the AP-5131's Rogue AP Detector Mode feature inoperable. Contact your Symbol sales associate for specific information.

To configure Rogue AP detection for the AP-5131:

1. Select **Network Configuration** -> **Wireless** -> **Rogue AP Detection** from the AP-5131 menu tree.

The screenshot shows the 'Rogue AP Detection' configuration page. The 'Detection Method' section has the following settings:

- RF Scan by MU (Scan Interval: 15 Min)
- RF On-Channel detection
- RF Scan by Detector Radio (Radio: 11bg)

The 'Allowed AP list' section has the checkbox 'Authorize Any AP Having Symbol Defined MAC Address' checked. Below it is a table with columns for 'Any MAC', 'MAC', 'Any ESSID', and 'ESSID'.

MAC Information		ESSID Information	
Any MAC	MAC	Any ESSID	ESSID
<input type="checkbox"/>	00 AC F0 43 AA BB	<input checked="" type="checkbox"/>	
<input type="checkbox"/>	00 AC F0 AC 01 D0	<input checked="" type="checkbox"/>	

Buttons at the bottom include 'Add', 'Del', 'Delete All', 'Apply', 'Undo Changes', 'Help', and 'Logout'. The system name 'AP-5131' is visible at the bottom left.

2. Configure the **Detection Method** field to set the detection method (MU or AP-5131) and define the 802.11a or 802.11b/g radio to conduct the rogue AP search.

- RF Scan by MU* Select the **RF Scan by MU** checkbox to enable MUs to scan for potential rogue APs within the network. Define an interval in the **Scan Interval** field for associated MUs to beacon in an attempt to locate a rogue AP. Set the interval to a value sooner than the default if a large volume of device network traffic is anticipated within the coverage area of the target AP-5131 access point. The **Scan Interval** field is not available unless the RF Scan by MU checkbox is selected. Symbol clients must be associated and have rogue AP detection enabled.
- RF On-Channel Detection* Select the **RF On-Channel Detection** checkbox to enable the AP-5131 to detect rogue APs on its current (legal) channel setting.
- RF Scan by Detector Radio* If the AP-5131 supports a dual-radio SKU, select the **RF Scan by Detector Radio** checkbox to enable the selected **11a** or **11b/g** radio to scan for rogue APs.
3. Use the **Allowed AP List** field to restrict Symbol AP's from Rogue AP detection and create a list of device MAC addresses and ESSID's approved for interoperability with the AP-5131.
- Authorize Any AP Having Symbol Defined MAC Address* Select this checkbox to enable all access points with a Symbol MAC address to interoperate with the AP-5131 conducting a scan for rogue devices.
- Add* Click **Add** to display a single set of editable MAC address and ESS address values.
- Del (Delete)* Click the **Delete** button to remove the highlighted line from the Rule Management field. The MAC and ESS address information previously defined is no longer applicable unless the previous configuration is restored.
- Delete All* Click the **Delete All** button to remove all entries from the Rule Management field. All MAC and ESS address information previously defined is no longer applicable unless the previous configuration is restored.
- Any MAC* Select the **Any MAC** checkbox to prevent a device's MAC address (whether it is a known device MAC address or not) from being considered a rogue device.
- MAC Address* Click **Add**, and enter the device MAC address to be excluded from classification as a rogue device.

<i>Any ESSID</i>	Select the Any ESSid checkbox to prevent a device's ESSID (whether it is a known device ESSID or not) from being considered a rogue device
<i>ESSID</i>	Click Add , and enter the name of a device ESSid to be excluded from classification as a rogue device.

4. Click **Apply** to save any changes to the Rogue AP Detection screen. Navigating away from the screen without clicking Apply results in all changes to the screens being lost.
5. Click **Undo Changes** (if necessary) to undo any changes made. Undo Changes reverts the settings displayed on the Rogue AP Detection screen to the last saved configuration.
6. Click **Logout** to securely exit the AP-5131 Symbol Access Point applet. A prompt displays confirming the logout before the applet is closed.

6.13.1 Moving Rogue APs to the Allowed AP List

The AP-5131 **Active APs** screen enables the user to view the list of detected rogue APs and, if necessary, select and move an AP into a list of allowed devices. This is helpful when the settings defined within the **Rogue AP Detection** screen inadvertently detect and define a device as a rogue AP.

To move detected rogue APs into a list of allowed APs:

1. Select **Network Configuration** -> **Wireless** -> **Rogue AP Detection** -> **Active APs** from the AP-5131 menu tree.

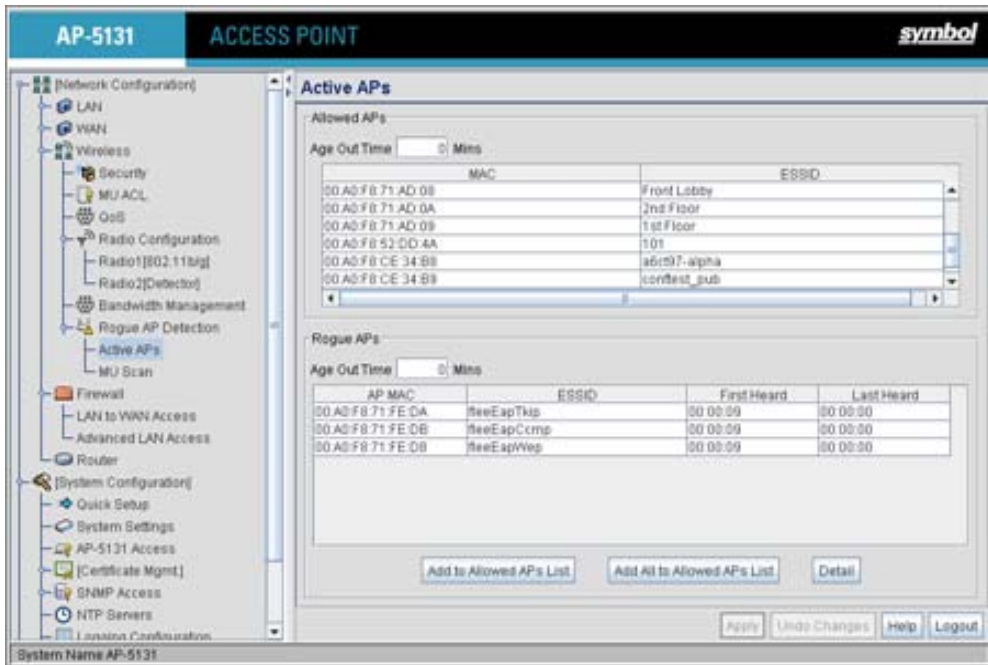

The Active APs screen displays with detected rogue devices displayed within the **Rogue APs** table.

2. Enter a value (in minutes) in the Allowed APs **Age Out Time** field to indicate the number of elapsed minutes before an AP will be removed from the approved list and reevaluated. A zero (0) for this value (default value) indicates an AP can remain on the approved AP list permanently.
3. Enter a value (in minutes) in the Rogue APs **Age Out Time** field to indicate the number of elapsed minutes before an AP will be removed from the rogue AP list and reevaluated. A zero (0) for this value (default value) indicates an AP can remain on the rogue AP list permanently.
4. Highlight an AP from within the Rogue APs table and click the **Add to Allowed APs List** button to move the device into the list of Allowed APs.
5. Click the **Add All to Allowed APs List** button to move each of the APs displayed within the Rogue APs table to the list of allowed APs.

6. Highlight a rogue AP and click the **Details** button to display a screen with device and detection information specific to that rogue device. This information is helpful in determining if a rogue AP should be moved to the Allowed APs table.

For more information on the displaying information on detected rogue APs, see [Displaying Rogue AP Details on page 6-58](#).

7. To remove the Rogue AP entries displayed within the e Rogue APs field, click the **Clear Rogue AP List** button.

Symbol only recommends clearing the list of Rogue APs when the devices displaying within the list do not represent a threat to the AP-5131 managed network.

8. Click **Apply** to save any changes to the Active APs screen. Navigating away from the screen without clicking Apply results in all changes to the screen being lost.
9. Click **Undo Changes** (if necessary) to undo any changes made. Undo Changes reverts the settings displayed on the Active APs screen to the last saved configuration.
10. Click **Logout** to securely exit the AP-5131 Symbol Access Point applet. A prompt displays confirming the logout before the applet is closed.

6.13.1.1 Displaying Rogue AP Details

Before moving a rogue AP into the list of allowed APs within the Active APs screen, the device address and rogue detection information for that AP should be evaluated.

To evaluate the properties of a rogue AP:

1. Select **Network Configuration** -> **Wireless** -> **Rogue AP Detection** -> **Active APs** from the AP-5131 menu tree.
2. Highlight a target rogue AP from within Rogue APs table and click the **Details** button.

The **Detail** screen displays for the rogue AP.



3. Refer to the **Rogue AP Detail** field for the following information:

<i>BSSID/MAC</i>	Displays the MAC address of the rogue AP. This information could be useful if the MAC address is determined to be a Symbol MAC address and the device is interpreted as non-hostile and the device should be defined as an allowed AP.
<i>ESSID</i>	Displays the ESSID of the rogue AP. This information could be useful if the ESSID is determined to be non-hostile and the device should be defined as an allowed AP.
<i>RSSI</i>	Shows the <i>Relative Signal Strength</i> (RSSI) of the rogue AP. Use this information to assess how close the rogue AP is. The higher the RSSI, the closer the rogue AP. If multiple AP-5131's have detected the same rogue AP, RSSI can be useful in triangulating the location of the rogue AP.

4. Refer to the **Rogue Detector Detail** field for the following information:

<i>Finder's MAC</i>	The MAC address of the AP-5131 detecting the rogue AP.
---------------------	--

<i>Detection Method</i>	Displays the RF Scan by MU , RF On-Channel Detection or RF Scan by Detector Radio method selected from the Rogue AP screen to detect rogue devices. For information on detection methods, see Configuring Rogue AP Detection on page 6-53 .
<i>First Heard (days:hrs:min)</i>	Defines the time in (days:hrs:min) that the rogue AP was initially heard by the detecting AP.
<i>Last Heard (days:hrs:min)</i>	Defines the time in (days:hrs:min) that the rogue AP was last heard by the detecting AP.
<i>Channel</i>	Displays the channel the rogue AP is using.

5. Click **OK** to securely exit the Detail screen and return to the Active APs screen.
6. Click **Cancel** (if necessary) to undo any changes made and return to the Active APs screen.

6.13.2 Using MUs to Detect Rogue Devices

The AP-5131 can use an associated MU that has its rogue AP detection feature enabled to scan for rogue APs. Once detected, the rogue AP(s) can be moved to the list of allowed devices (if appropriate) within the Active APs screen. When adding an MU's detection capabilities with the AP-5131's own rogue AP detection functionality, the rogue detection area can be significantly extended.

To use associated rogue AP enabled MUs to scan for rogue APs:

1. Select **Network Configuration** -> **Wireless** -> **Rogue AP Detection** -> **MU Scan** from the AP-5131 menu tree.

The **On Demand MU Scan** screen displays with associated MUs with rogue AP detection enabled

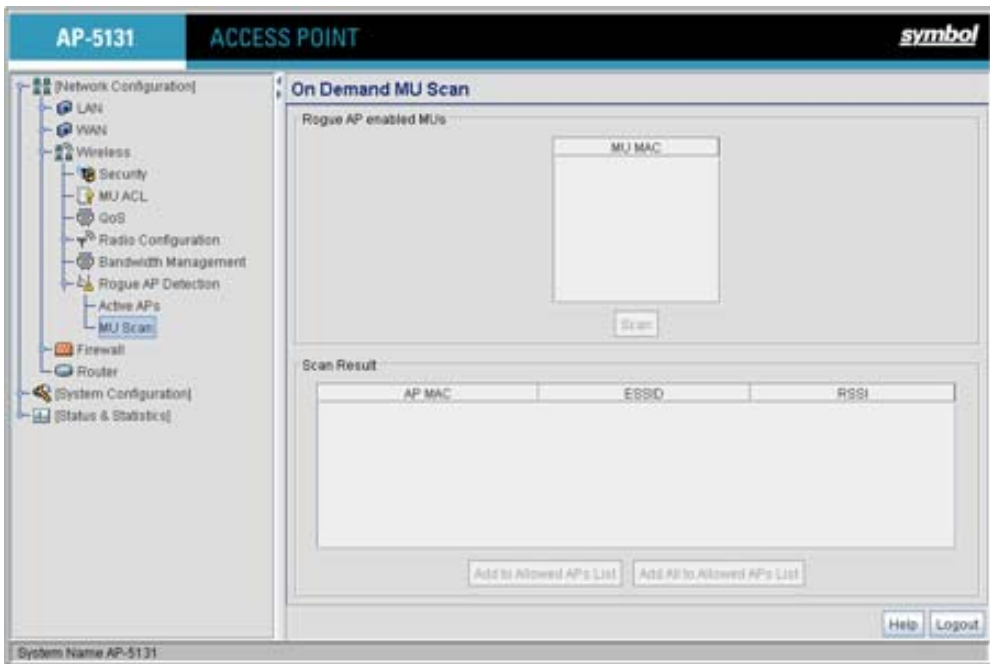

2. Highlight an MU from within the **Rogue AP enabled MUs** field and click the scan button. The target MU begins scanning for rogue devices using the detection parameters defined within the Rogue AP Detection screen. To modify the detection parameters, see [Configuring Rogue AP Detection on page 6-53](#). Those devices detected as rogue APs display within the **Scan Result** table. Use the displayed AP MAC, ESSID and RSSI values to determine the device listed in the table is truly a rogue device or one inadvertently detected as a rogue AP.
3. If necessary, highlight an individual MU from within the Scan Result field and click the **Add to Allowed AP List** button to move the AP into the Allowed APs table within the **Active APs** screen.
4. Additionally, if necessary, click the **Add All to Allowed APs List** button to move every device within the Scan Result table into the Allowed APs table within the **Active APs** screen. Only use this option if you are sure all of the devices detected and displayed within the Scan Results table are non-hostile APs.
5. Highlight a different MU from the Rogue AP enabled MUs field as needed to scan for additional rogue APs.

- Click **Logout** to return to the Rogue AP Detection screen.

6.14 Configuring User Authentication

The AP-5131 can work with external RADIUS and LDAP Servers (AAA Servers) to provide user database information and user authentication.

6.14.1 Configuring the Radius Server

The **Radius Server** screen enables an administrator to define data sources and specify authentication information for the RADIUS Server.

To configure the Radius Server:

- Select **System Configuration** -> **User Authentication** -> **RADIUS Server** from the AP-5131 menu tree.

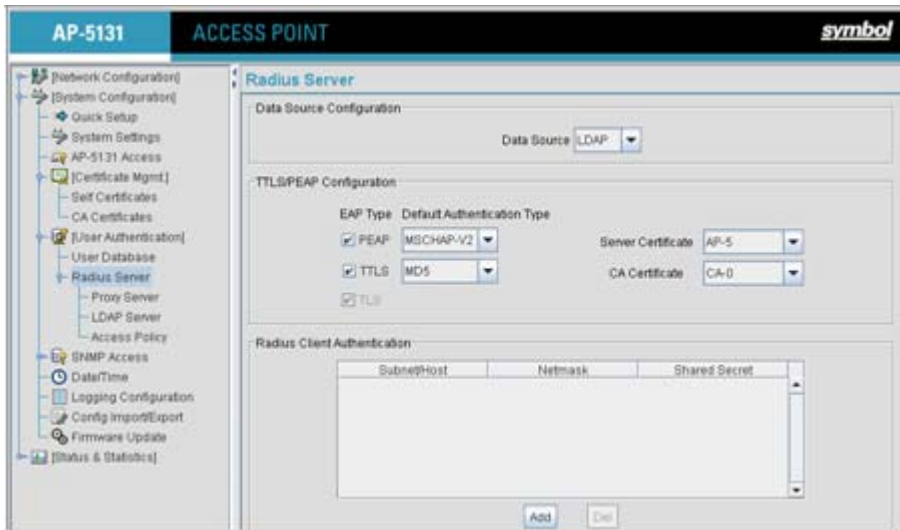

- From within the **Data Source Configuration** field, use the **Data Source** drop-down menu to select the data source for the Radius server.

Local

An internal user database serves as the data source. Use the **User Database** screen to enter the user data. For more information, see [Managing the Local User Database on page 6-69](#).

LDAP

If LDAP is selected, the switch will use the data in an LDAP server. Configure the LDAP server settings on the LDAP screen under RADIUS Server on the menu tree. For more information, see [Configuring LDAP Authentication on page 6-65](#).

3. Use the **TTLS/PEAP Configuration** field to specify the Radius Server default EAP type, EAP authentication type and a Server or CA certificate (if used).

EAP Type

Use the **EAP Type** checkboxes to enable the default EAP type(s) for the RADIUS server. Options include:

- PEAP - Select the PEAP checkbox to enable both PEAP types (GTC and MSCHAP-V2) available to the AP-5131. PEAP uses a TLS layer on top of EAP as a carrier for other EAP modules. PEAP is an ideal choice for networks using legacy EAP authentication methods.
- TTLS - Select the TTLS checkbox to enable all three TTLS types (MD5, PAP and MSCHAP-V2) available to the AP-5131. TTLS is similar to EAP-TLS, but the client authentication portion of the protocol is not performed until after a secure transport tunnel is established. This allows EAP-TTLS to protect legacy authentication methods used by some RADIUS servers.
- TLS - The TLS checkbox is selected but disabled by default and resides in the background as it does not contain user configurable parameters.

Default Authentication Type

Specify a PEAP and/or TTLS Authentication Type for EAP to use from the drop-down menu to the right of each checkbox item.

PEAP options include:

- GTC - *EAP Generic Token Card* (GTC) is a challenge handshake authentication protocol using a hardware token card to provide the response string.
- MSCHAP-V2 - *Microsoft CHAP* (MSCHAP-V2) is an encrypted authentication method based on Microsoft's challenge/response authentication protocol.

TTLS options include:

- PAP - *Password Authentication Protocol* sends a username and password over a network to a server that compares the username and password to a table of authorized users. If the username and password are matched in the table, server access is authorized. WatchGuard products do not support the PAP protocol because the username and password are sent as clear text that a hacker can read.
- MD5 - This option enables the MD5 algorithm for data verification. MD5 takes as input a message of arbitrary length and produces a 128-bit fingerprint. The MD5 algorithm is intended for digital signature applications, in which a large file must be compressed in a secure manner before being encrypted with a private (secret) key under a public-key cryptographic system.
- MSCHAP-V2 - *Microsoft CHAP* (MSCHAP-V2) is an encrypted authentication method based on Microsoft's challenge/response authentication protocol.

Server Certificate

If you have a server certificate from a CA and wish to use it on the Radius server, select it from the drop-down menu. Only certificates imported to the AP-5131 are available in the menu. For information on creating a certificate, see [Creating Self Certificates for Accessing the VPN on page 4-10](#).

CA Certificate

You can also choose an imported CA Certificate to use on the Radius server. If using a server certificate signed by a CA, import that CA's root certificate using the CA certificates screen (for information, see [Importing a CA Certificate on page 4-9](#)). After a valid CA certificate has been imported, it is available from the CA Certificate drop-down menu.

- Use the **Radius Client Authentication** table to configure multiple shared secrets based on the subnet or host attempting to authenticate with the Radius server. Use the **Add** button to add entries to the list. Modify the following information as needed within the table.

<i>Subnet/Host</i>	Defines the IP address of the subnet or host that will be authenticating with the Radius server. If a WLAN has been created to support mesh networking, then enter the IP address of mesh client bridge in order for the MU to authenticate with a base bridge.
<i>Netmask</i>	Defines the netmask (subnet mask) of the subnet or host authenticating with the Radius server.
<i>Shared Secret</i>	Click the Passwords button and set a shared secret used for each host or subnet authenticating against the RADIUS server. The shared secret can be up to 7 characters in length.

- Click **Apply** to save any changes to the Radius Server screen. Navigating away from the screen without clicking Apply results in all changes to the screen being lost.
- Click **Undo Changes** (if necessary) to undo any changes made. Undo Changes reverts the settings displayed on the Radius Server screen to the last saved configuration.
- Click **Logout** to securely exit the AP-5131 Symbol Access Point applet. A prompt displays confirming the logout before the applet is closed.

6.14.2 Configuring LDAP Authentication

When the Radius Data Source is set to use an external LDAP server (see [Configuring the Radius Server on page 6-62](#)), the **LDAP** screen is used to configure the properties of the external LDAP server.

To configure the LDAP server:

- Select **System Configuration** -> **User Authentication** -> **RADIUS Server** -> **LDAP** from the AP-5131 menu tree.



NOTE The LDAP screen displays with unfamiliar alphanumeric characters (if new to LDAP configuration). Symbol recommends only qualified administrators change the default values displayed within the LDAP screen.

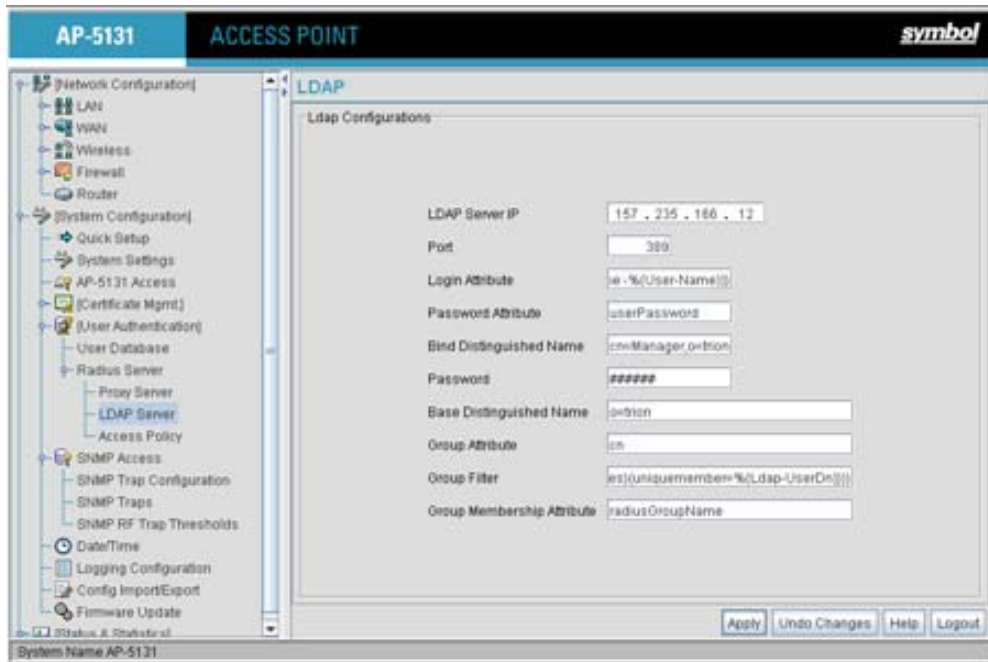

2. Enter the appropriate information within the LDAP Configuration field to allow the AP-5131 to interoperate with the LDAP server. Consult with your LDAP server administrator for details on how to define the values in this screen.

LDAP Server IP Enter the IP address of the external LDAP server acting as the data source for the Radius server. The LDAP server must be accessible from the WAN port or from the AP-5131's active subnet.

Port Enter the TCP/IP port number for the LDAP server acting as a data source for the Radius. The default port is 389.

Login Attribute Specify the login attribute used by the LDAP server for authentication. In most cases, the default value should work. Windows Active Directory users must use "sAMAccountName" as their login attribute to successfully login to the LDAP server.

Password Attribute Enter the password used by the LDAP server for authentication.

Bind Distinguished Name Specify the distinguished name used to bind with the LDAP server.

<i>Password</i>	Enter a valid password for the LDAP server.
<i>Base Distinguished Name</i>	Enter a name that establishes the base object for the search. The base object is the point in the LDAP tree at which to start searching.
<i>Group Attribute</i>	Define the group attribute used by the LDAP server.
<i>Group Filter</i>	Specify the group filters used by the LDAP server.
<i>Group Member Attribute</i>	Enter the Group Member Attribute sent to the LDAP server when authenticating users.



CAUTION Windows Active Directory users must set their Login Attribute to "sAMAccountName" in order to successfully login to the LDAP server.

3. Click **Apply** to save any changes to the LDAP screen. Navigating away from the screen without clicking Apply results in all changes to the screen being lost.
4. Click **Undo Changes** (if necessary) to undo any changes made. Undo Changes reverts the settings displayed on the LDAP screen to the last saved configuration.
5. Click **Logout** to securely exit the AP-5131 Symbol Access Point applet. A prompt displays confirming the logout before the applet is closed.

6.14.3 Configuring a Proxy Radius Server

The AP-5131 has the capability to proxy authentication requests to a remote Radius server based on the suffix of the user ID (such as myisp.com or company.com). The AP-5131 support up to 10 proxy servers.



CAUTION If using a proxy server for Radius authentication, the **Data Source** field within the Radius server screen must be set to **Local**. If set to LDAP, the proxy server will not be successful when performing the authentication. To verify the existing settings, see [Configuring the Radius Server on page 6-62](#).

To configure the proxy Radius server for the AP-5131:

1. Select **System Configuration** -> **User Authentication** -> **RADIUS Server** -> **Proxy** from the AP-5131 menu tree.

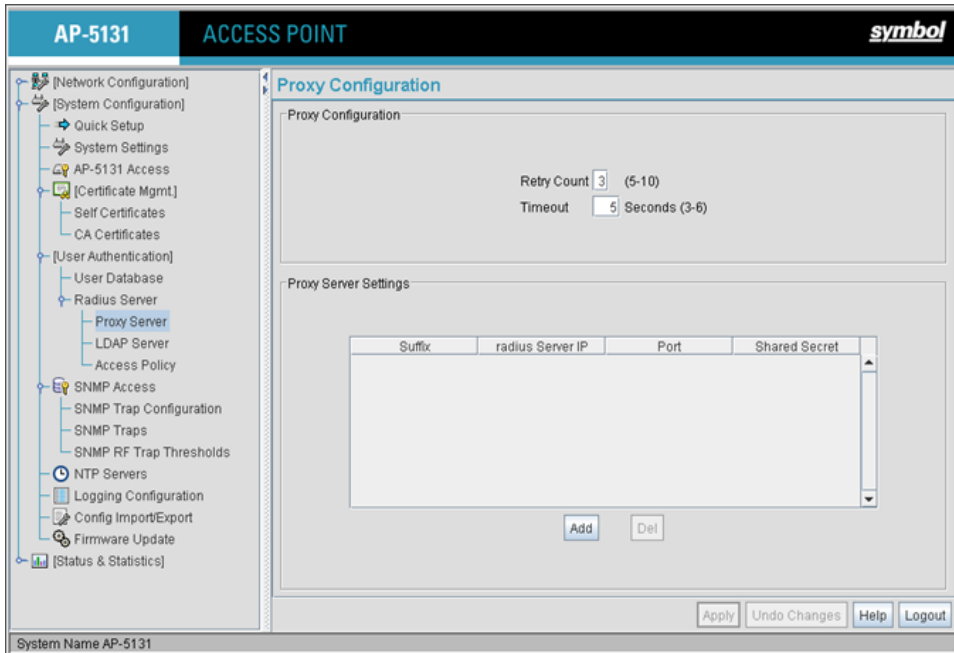

2. Refer to the **Proxy Configuration** field to define the proxy server's retry count and timeout values.

Retry Count Enter a value between 3 and 6 to indicate the number of times the AP-5131 attempts to reach a proxy server before giving up.

Timeout Enter a value between 5 and 10 to indicate the number of elapsed seconds causing the AP-5131 to time out on a request to a proxy server.

3. Use the **Add** button to add a new proxy server. Define the following information for each entry:

Suffix Enter the domain suffix (such as myisp.com or mycompany.com) of the users sent to the specified proxy server.

RADIUS Server IP Specify the IP address of the Radius server acting as a proxy server.

Port Enter the TCP/IP port number for the Radius server acting as a proxy server. The default port is 1812.

Shared Secret Set a shared secret used for each suffix used for authentication with the RADIUS proxy server.

4. To remove a row, select the row and click the **Del** (Delete) button.
5. Click **Apply** to save any changes to the Proxy screen. Navigating away from the screen without clicking Apply results in all changes to the screen being lost.
6. Click **Undo Changes** (if necessary) to undo any changes made. Undo Changes reverts the settings displayed on the Proxy screen to the last saved configuration.
7. Click **Logout** to securely exit the AP-5131 Symbol Access Point applet. A prompt displays confirming the logout before the applet is closed.

6.14.4 Managing the Local User Database

Use the **User Database** screen to create groups for use with the Radius server. The database of groups is employed if **Local** is selected as the Data Source from the Radius Server screen. For information on selecting Local as the Data Source, see [Configuring the Radius Server on page 6-62](#).

To add groups to the User database:



NOTE Each group can be configured to have its own access policy using the Access Policy screen. For more information, see [Defining the User Access Policy on page 6-72](#).

1. Select **System Configuration** -> **User Authentication** -> **User Database** from the AP-5131 menu tree.

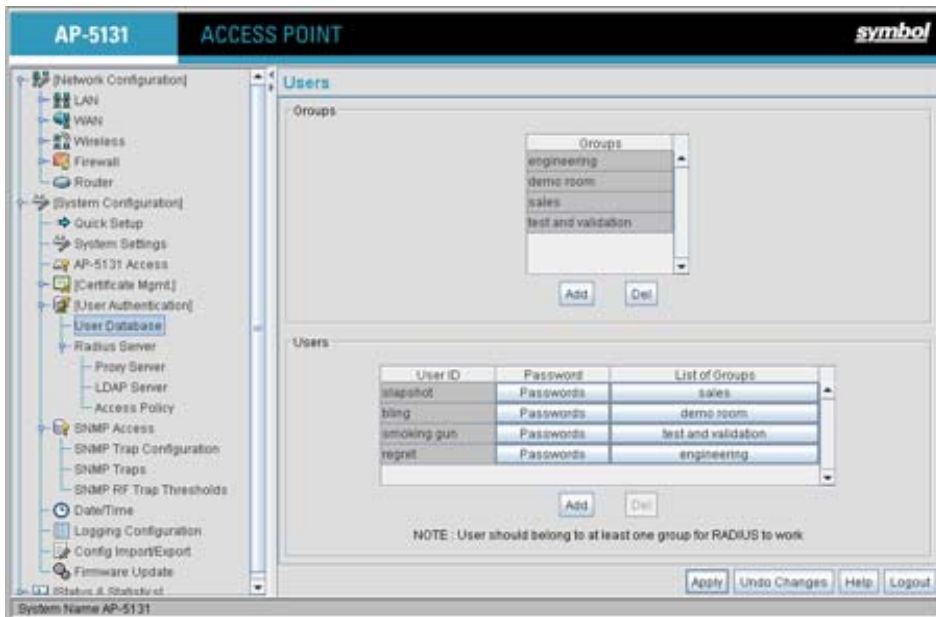

Refer to the **Groups** field for a list of all groups in the local Radius database. The groups are listed in the order added. Although groups can be added and deleted, there is no capability to edit a group name.

2. Click the **Add** button and enter the name of the group in the new blank field in the Groups table.
3. To remove a group, select the group from the table and click the **Del** (Delete) key.

The **Users** table displays the entire list of users. Up to 100 users can be entered here. The users are listed in the order added. Users can be added and deleted, but there is no capability to edit the name of a group.

4. To add a new user, click the **Add** button at the bottom of the Users area.
5. In the new line, type a **User ID** (username).
6. Click the **Password** cell. A small window displays. Enter a password for the user and click **OK** to return to the Users screen.

7. Click the **List of Groups** cell. A new screen displays enabling you to associate groups with the user. For more information on mapping groups with a user, see [Mapping Users to Groups on page 6-71](#).
8. Click **Apply** to save any changes to the Users screen. Navigating away from the screen without clicking Apply results in all changes to the screen being lost.
9. Click **Undo Changes** (if necessary) to undo any changes made. Undo Changes reverts the settings displayed on the Users screen to the last saved configuration.
10. Click **Logout** to securely exit the AP-5131 Symbol Access Point applet. A prompt displays confirming the logout before the applet is closed.

6.14.4.1 Mapping Users to Groups

Once users have been created within the **Users** screen, their access privileges need to be configured for inclusion to one, some or all of the groups also created within the Users screen.

To map users to groups for group authentication privileges:

1. If you are not already in the Users screen, select **System Configuration** -> **User Authentication** -> **User Database** from the AP-5131 menu tree.
Existing users and groups display within their respective fields. If user or group requires creation or modification, make your changes before you begin to map them.
2. Refer to the Users field and select the **List of Groups** column for the particular user you wish to map to one or more groups.
The **Users Group Setting** screen displays with the groups available for user inclusion displayed within the **Available** column.

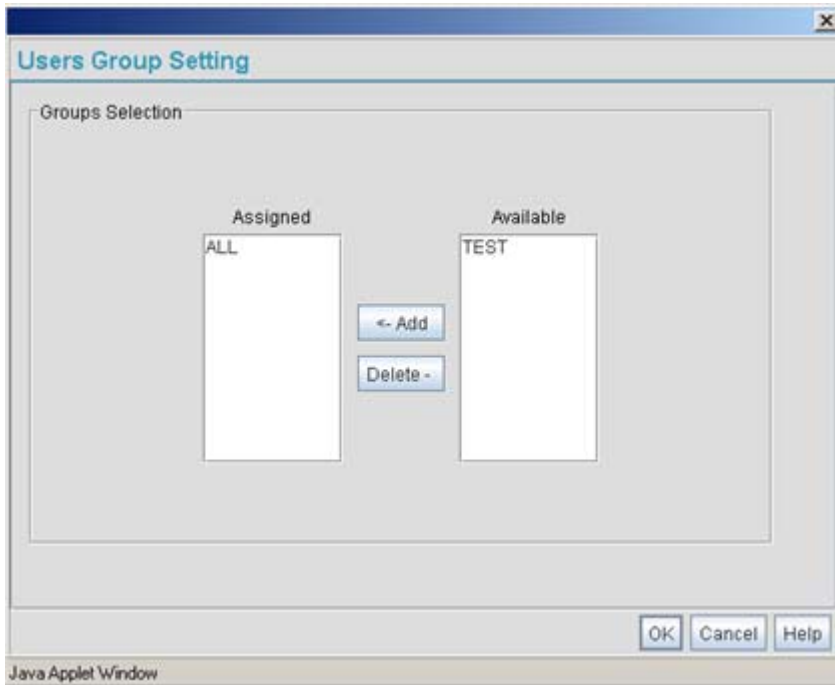

3. To add the user to a group, select the group in the **Available** list (on the right) and click the **<-Add** button.

Assigned users will display within the **Assigned** table. Map one or more groups as needed for group authentication access for this particular user.

4. To remove the user from a group, select the group in the Assigned list (on the left) and click the **Delete->** button.
5. Click the **OK** button to save your user and group mapping assignments and return to the Users screen.

6.14.5 Defining the User Access Policy

Refer to the **Access Policy** screen to define WLAN access for the user group(s) defined within the Users screen. Each group created within the Users screen displays within the Access Policy screen under the group column. Similarly, existing WLANs can be individually mapped to user groups by clicking the WLANs button to the right of each group name. For more information on creating groups and users, see [Managing the Local User Database on page 6-69](#). For information on creating a new

WLAN or editing the properties of an existing WLAN, see [Creating/Editing Individual WLANs on page 5-24](#)

1. Select **User Authentication** -> **Radius Server** -> **Access Policy** from the AP-5131 menu tree.

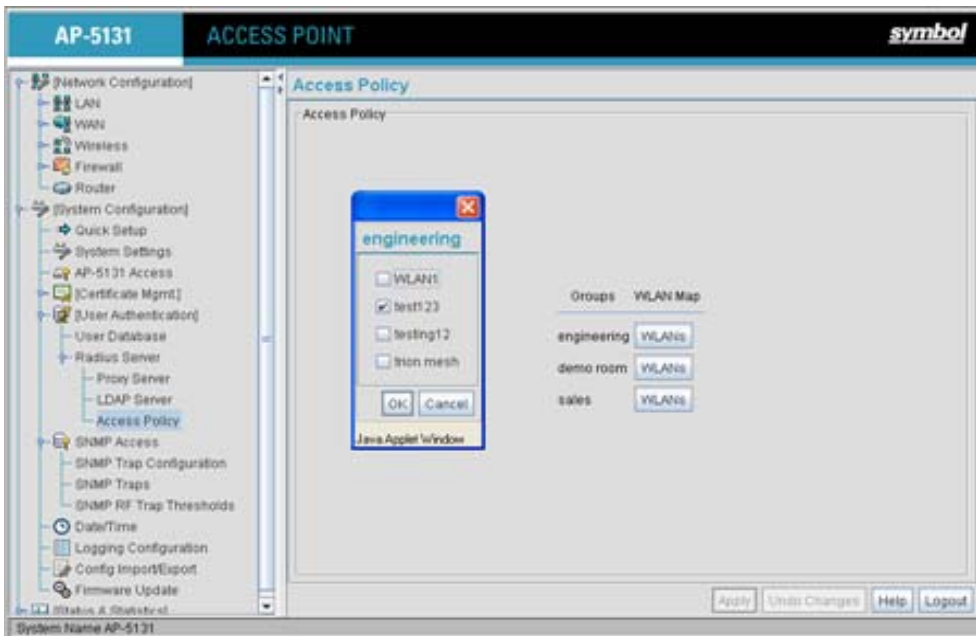

2. Click the **WLANs** button to the right of a specific group name.
A pop-up window displays with the name of the user group appearing on the top of the screen and the names of existing WLANs displaying within the screen. Each WLAN has a checkbox to the left of it for mapping the WLAN to this group.
3. Select the WLAN checkboxes for those specific WLANs you would like to assign access for this particular user group.
4. Click **OK** within the pop-up group screen to save the WLAN mapping configuration for that specific group.
5. Click **Apply** to save any changes to the Access Policy screen. Navigating away from the screen without clicking Apply results in all changes to the screen being lost.
6. Click **Undo Changes** (if necessary) to undo any changes made. Undo Changes reverts the settings displayed on the Access Policy screen to the last saved configuration.

7. Click **Logout** to securely exit the AP-5131 Symbol Access Point applet. A prompt displays confirming the logout before the applet is closed.

Monitoring Statistics

The AP-5131 has functionality to display robust transmit and receive statistics for its WAN and LAN port. *Wireless Local Area Network (WLAN)* stats can also be displayed collectively for each enabled WLAN as well as individually for up to 16 specific WLANs.

Transmit and receive statistics can also be displayed for the AP-5131's 802.11a and 802.11b/g radios. An advanced radio statistics page is also available to display retry histograms for specific data packet retry information.

Associated MU stats can be displayed collectively for associated MUs and individually for specific MUs. An echo (ping) test is also available to ping specific MUs to assess the strength of the AP association.

Finally, the AP-5131 can detect and display the properties of other APs detected within the AP-5131 radio coverage area. The type of AP detected can be displayed as well as the properties of individual APs.

See the following sections for more details on viewing statistics for the AP-5131:

- [Viewing WAN Statistics](#)
- [Viewing LAN Statistics](#)
- [Viewing Wireless Statistics](#)
- [Viewing Radio Statistics Summary](#)
- [Viewing MU Statistics Summary](#)
- [Viewing the Mesh Statistics Summary](#)
- [Viewing Known Access Point Statistics](#)

7.1 Viewing WAN Statistics

Use the AP-5131 **WAN Stats** screen to view real-time statistics for monitoring the AP-5131 activity through its *Wide Area Network (WAN)* port.

The **Information** field of the WAN Stats screen displays basic WAN information, generated from settings on the WAN screen. The **Received** and **Transmitted** fields display statistics for the cumulative packets, bytes, and errors received and transmitted through the WAN interface since it was last enabled or the AP was last rebooted. The AP-5131 **WAN Stats** screen is view-only with no configurable data fields.

To view AP-5131 WAN Statistics:

1. Select **Status and Statistics** -> **WAN Stats** from the AP-5131 menu tree.

The screenshot shows the configuration interface for an AP-5131 Access Point. The left sidebar contains a navigation tree with categories like [Network Configuration], [System Configuration], [Status & Statistics], and [WAN Stats]. The main content area is titled 'WAN Statistics' and includes an 'Information' section with the following data:

Status	Enabled
HW Address	00A0F8725792
IP Address	172.20.23.5
Mask	255.255.255.192
Link	Up
Speed	150 Mbps

Below the information section are two tables for network statistics:

Received		Transmitted	
RX Packets	842561	TX Packets	134471
RX Bytes	107616205	TX Bytes	82638017
RX Errors	1	TX Errors	0
RX Dropped	0	TX Dropped	0
RX Overruns	0	TX Overruns	0
RX Frame	1	TX Carrier	0

At the bottom of the main content area, there is a 'Clear WAN Stats' button and 'Help' and 'Logout' buttons. The system name 'AP-5131' is displayed at the bottom left.

2. Refer to the **Information** field to reference the following AP-5131 WAN data:

<i>Status</i>	The Status field displays Enabled if the WAN interface is enabled on the WAN screen. If the WAN interface is disabled on the WAN screen, the WAN Stats screen displays no connection information and statistics. To enable the WAN connection, see Configuring WAN Settings on page 5-14
<i>HW Address</i>	The <i>Media Access Control (MAC)</i> address of the AP-5131 WAN port. The WAN port MAC address is hard coded at the factory and cannot be changed.
<i>IP Addresses</i>	The displayed <i>Internet Protocol (IP)</i> addresses for the AP-5131 WAN port.
<i>Mask</i>	The Mask field displays the subnet mask number for the AP-5131's WAN connection. This value is set on the WAN screen. Refer to Configuring WAN Settings on page 5-14 to change the subnet mask.

Link The **Link** field displays **Up** if the WAN connection is active between the AP-5131 and network, and **Down** if the WAN connection is interrupted or lost. Use this information to assess the current connection status of the WAN port.

Speed The WAN connection speed is displayed in Megabits per second (Mbps), for example, 54Mbps. If the throughput speed is not achieved, examine the number of transmit and receive errors, or consider increasing the supported data rate. To change the data rate of the 802.11a or 802.11b/g radio, see [Configuring the 802.11a or 802.11b/g Radio on page 5-48](#).

3. Refer to the **Received** field to reference data received over the AP-5131 WAN port.

RX Packets RX packets are data packets received over the WAN port. The displayed number is a cumulative total since the WAN interface was last enabled or the AP-5131 was last restarted.

RX Bytes RX bytes are bytes of information received over the WAN port. The displayed number is a cumulative total since the WAN interface was last enabled or the AP-5131 was last restarted. To restart the AP-5131 to begin a new data collection, see [Configuring System Settings on page 4-2](#).

RX Errors RX errors include dropped data packets, buffer overruns, and frame errors on inbound traffic. The number of RX errors is a total of *RX Dropped*, *RX Overruns* and *RX Carrier* errors. Use this information to determine performance quality of the current WAN connection.

RX Dropped The **RX Dropped** field displays the number of data packets that fail to reach the WAN interface. If this number appears excessive, consider a new connection to the device.

RX Overruns RX overruns are buffer overruns on the WAN connection. RX overruns occur when packets are received faster than the WAN port can handle them. If RX overruns are excessive, consider reducing the data rate, for more information, see [Configuring the 802.11a or 802.11b/g Radio on page 5-48](#).

RX Frame The **RX Frame** field displays the number of TCP/IP data frame errors received.

4. Refer to the **Transmitted** field to reference data received over the AP-5131 WAN port.

<i>TX Packets</i>	TX packets are data packets sent over the WAN connection. The displayed number is a cumulative total since the WAN interface was last enabled or the AP-5131 was last restarted. To begin a new data collection, see Configuring System Settings on page 4-2 .
<i>TX Bytes</i>	TX bytes are bytes of information sent over the WAN connection. The displayed number is a cumulative total since the WAN interface was last enabled or the AP-5131 was last restarted. To begin a new data collection, see Configuring System Settings on page 4-2 .
<i>TX Errors</i>	TX errors include dropped data packets, buffer overruns, and carrier errors on outbound traffic. The displayed number of TX errors is the total of <i>TX Dropped</i> , <i>TX Overruns</i> and <i>TX Carrier</i> errors. Use this information to re-assess AP-5131 location and transmit speed.
<i>TX Dropped</i>	The TX Dropped field displays the number of data packets that fail to get sent from the WAN interface.
<i>TX Overruns</i>	TX overruns are buffer overruns on the WAN connection. TX overruns occur when packets are sent faster than the WAN interface can handle. If TX overruns are excessive, consider reducing the data rate, for more information, see Configuring the 802.11a or 802.11b/g Radio on page 5-48 .
<i>TX Carrier</i>	The TX Carrier field displays the number of TCP/IP data carrier errors.

5. Click the **Clear WAN Stats** button to reset each of the data collection counters to zero in order to begin new data collections. The RX/TX Packets and RX/TX Bytes totals remain at their present values and are not cleared.

Do not clear the WAN stats if currently in an important data gathering activity or risk losing all data calculations to that point.

6. Click **Logout** to securely exit the AP-5131 Symbol Access Point applet. A prompt displays confirming the logout before the applet is closed.

7.2 Viewing LAN Statistics

Use the **LAN Stats** screen to monitor the activity of the AP-5131 LAN1 or LAN2 connection. The **Information** field of the LAN Stats screen displays network traffic information as monitored over the AP-5131 LAN1 or LAN2 port. The **Received** and **Transmitted** fields of the screen display statistics for the cumulative packets, bytes, and errors received and transmitted over the LAN1 or LAN2 port since it was last enabled or the AP-5131 was last restarted. The **LAN Stats** screen is view-only with no user configurable data fields.

To view AP-5131 LAN connection stats:

1. Select **Status and Statistics** -> **LAN Stats** -> **LAN1 Stats** (or LAN2 Stats) from the AP-5131 menu tree.

The screenshot shows the AP-5131 web interface. The left navigation tree is expanded to 'LAN1 Stats'. The main content area displays the following information:

Information

Status: Enabled
 IP Address: 192.168.10.123
 Network Mask: 196.129.12.132
 Ethernet Address: 08:A0:F8:72:57:83

WLANs Mapped

WLANs
WLAN1
test123
testng12
tion mesh

Received

RX Packets: 603	RX Errors: 0
RX Bytes: 110612	RX Dropped: 0
RX Overruns: 0	RX Frame: 0

Transmitted

TX Packets: 103112	TX Errors: 0
TX Bytes: 27837094	TX Dropped: 0
TX Overruns: 0	TX Carrier: 0

Buttons: Clear LAN Stats, Help, Logout

System Name: AP-5131

2. Refer to the **Information** field to view the following AP-5131 device address information:

LAN Interface Displays whether this particular LAN has been enabled as viable AP-5131 subnet from within the LAN Configuration screen.

IP Address The *Internet Protocol (IP)* addresses for the AP-5131 LAN port.

<i>Network Mask</i>	The first two sets of numbers specify the network domain, the next set specifies the subset of hosts within a larger network. These values help divide a network into subnetworks and simplify routing and data transmission.
<i>Ethernet Address</i>	The <i>Media Access Control (MAC)</i> address of the AP-5131. The MAC address is hard coded at the factory and cannot be changed.
<i>WLANs Connected</i>	The WLANs Connected table lists the WLANs using this LAN (Either LAN1 or LAN2) as their LAN interface.

3. Refer to the **Received** field to view data received over the AP-5131 LAN port.

<i>RX Packets</i>	RX packets are data packets received over the AP-5131 LAN port. The number is a cumulative total since the LAN connection was last enabled or the AP-5131 was last restarted. To begin a new data collection, see Configuring System Settings on page 4-2 .
<i>RX Bytes</i>	RX bytes are bytes of information received over the LAN port. The value is a cumulative total since the LAN connection was last enabled or the AP-5131 was last restarted. To begin a new data collection, see Configuring System Settings on page 4-2 .
<i>RX Errors</i>	RX errors include dropped data packets, buffer overruns, and frame errors on inbound traffic. The number of RX errors is a total of <i>RX Dropped</i> , <i>RX Overruns</i> and <i>RX Carrier</i> errors. Use this information to determine performance quality of the current LAN connection.
<i>RX Dropped</i>	The RX Dropped field displays the number of data packets failing to reach the LAN port. If this number appears excessive, consider a new connection to the device.
<i>RX Overruns</i>	RX overruns are buffer overruns on the AP-5131 LAN port. RX overruns occur when packets are received faster than the LAN connection can handle them. If RX overruns are excessive, consider reducing the data rate, for more information, see Configuring the 802.11a or 802.11b/g Radio on page 5-48 .
<i>RX Frame</i>	The RX Frame field displays the number of TCP/IP data frame errors received.

4. Refer to the **Transmitted** field to view statistics transmitted over the AP-5131 LAN port.

<i>TX Packets</i>	TX packets are data packets sent over the AP-5131 LAN port. The displayed number is a cumulative total since the LAN connection was last enabled or the AP-5131 was last restarted. To begin a new data collection, see Configuring System Settings on page 4-2 .
<i>TX Bytes</i>	TX bytes are bytes of information sent over the LAN port. The displayed number is a cumulative total since the LAN Connection was last enabled or the AP-5131 was last restarted. To begin a new data collection, see Configuring System Settings on page 4-2 .
<i>TX Errors</i>	TX errors include dropped data packets, buffer overruns, and carrier errors on outbound traffic. The displayed number of TX errors is a total of <i>TX Dropped</i> , <i>TX Overruns</i> and <i>TX Carrier</i> errors. Use this information to re-assess AP location and transmit speed.
<i>TX Dropped</i>	The TX Dropped field displays the number of data packets that fail to get sent from the AP-5131 LAN port.
<i>TX Overruns</i>	TX overruns are buffer overruns on the LAN port. TX overruns occur when packets are sent faster than the LAN connection can handle. If TX overruns are excessive, consider reducing the data rate, for more information, see Configuring the 802.11a or 802.11b/g Radio on page 5-48 .
<i>TX Carrier</i>	The TX Carrier field displays the number of TCP/IP data carrier errors.

5. Click the **Clear LAN Stats** button to reset each of the data collection counters to zero in order to begin new data collections. The RX/TX Packets and RX/TX Bytes totals remain at their present values and are not cleared.
6. Click the **Logout** button to securely exit the AP-5131 Symbol Access Point applet. There will be a prompt confirming logout before the applet is closed.

7.2.1 Viewing a LAN's STP Statistics

Each AP-5131 LAN has the ability to track its own unique STP statistics. Refer to the LAN STP Stats page when assessing mesh networking functionality for each of the two AP-5131 LANs. AP-5131s in bridge mode exchange configuration messages at regular intervals (typically 1 to 4 seconds). If a bridge fails, neighboring bridges detect a lack of configuration messaging and initiate a spanning-tree recalculation (when spanning tree is enabled).

To view AP-5131 LAN's STP statistics:

1. Select **Status and Statistics** -> **LAN Stats** -> **LAN1 Stats** (or LAN2 Stats) > **STP Stats** from the AP-5131 menu tree.

The screenshot shows the web interface for an AP-5131 Access Point. The navigation tree on the left is expanded to show 'Status & Statistics' > 'LAN Stats' > 'LAN1 Stats' > 'STP Stats'. The main content area displays the following information:

Spanning Tree Info

Spanning Tree State	Disabled
Designated Root	8000.00A0F8725783
Bridge ID	8000.00A0F8725783
Root Port Number	0
Root Path Cost	0
Bridge Max Msg. Age	20 sec
Bridge Hello Time	2 sec
Bridge Forward Delay	15 sec

Port Interface Table

Port ID	State	Path Cost	Designated root	Designated Bridge	Designated Port	Designated Cost
Radio1	Forwarding	100	8000.00A0F8725783	8000.00A0F8725783	8001	0
Radio2	Forwarding	100	8000.00A0F8725783	8000.00A0F8725783	8002	0
Ethernet	Forwarding	100	8000.00A0F8725783	8000.00A0F8725783	8003	0

System Name AP-5131

2. Refer to the **Spanning Tree Info** field to for details on spanning tree state, and root AP-5131 designation.

Spanning Tree State Displays whether the spanning tree state is currently enabled or disabled. The spanning tree state must be enabled for a unique spanning-tree calculation to occur when the bridge is powered up or when a topology change is detected.

<i>Designated Root</i>	Displays the AP-5131 MAC address of the bridge defined as the root bridge in the Bridge STP Configuration screen. For information on defining an AP-5131 as a root bridge, see Setting the LAN Configuration for Mesh Networking Support on page 9-5 .
<i>Bridge ID</i>	The Bridge ID identifies the priority and ID of the bridge sending the message
<i>Root Port Number</i>	Identifies the root bridge by listing its 2-byte priority followed by its 6-byte ID.
<i>Root Path Cost</i>	Bridge message traffic contains information identifying the root bridge and the sending bridge. The root path cost represents the distance (cost) from the sending bridge to the root bridge.
<i>Bridge Max Msg. Age</i>	The Max Msg Age measures the age of received protocol information recorded for a port, and to ensure the information is discarded when it exceeds the value set for the Maximum Message age timer. For information on setting the Maximum Message Age. For information on setting the Bridge Max Msg. Age, see Setting the LAN Configuration for Mesh Networking Support on page 9-5 .
<i>Bridge Hello Time</i>	The Bridge Hello Time is the time between each bridge protocol data unit sent. This time is equal to 2 seconds (sec) by default, but can be tuned between 1 and 10 sec. For information on setting the Bridge Hello Time, see Setting the LAN Configuration for Mesh Networking Support on page 9-5 . The 802.1d specification recommends the Hello Time be set to a value less than half of the Max Message age value.
<i>Bridge Forward Delay</i>	The Bridge Forward Delay value is the time spent in a listening and learning state. This time is equal to 15 sec by default, but you can tune the time to be between 4 and 30 sec. For information on setting the Bridge Forward Delay, see Setting the LAN Configuration for Mesh Networking Support on page 9-5 .

3. Refer to the **Port Interface Table** to assess the state of the traffic over the ports listed within the table for the root and bridge and designated bridges.

<i>Port ID</i>	Identifies the port from which the configuration message was sent.
----------------	--

<i>State</i>	Displays whether a bridge is forwarding traffic to other members of the mesh network (over this port) or blocking traffic. Each viable member of the mesh network must forward traffic to extend the coverage area of the mesh network.
<i>Path Cost</i>	The root path cost is the distance (cost) from the sending bridge to the root bridge.
<i>Designated Root</i>	Displays the MAC address of the AP-5131 defined with the lowest priority within the Mesh STP Configuration screen.
<i>Designated Bridge</i>	There is only one root bridge within each mesh network. All other bridges are designated bridges that look to the root bridge for several mesh network timeout values. For information on root and bridge designations, see Setting the LAN Configuration for Mesh Networking Support on page 9-5 .
<i>Designated Port</i>	Each designated bridge must use a unique port. The value listed represents the port used by each bridge listed within the table to route traffic to other members of the mesh network.
<i>Designated Cost</i>	Displays the unique distance between each AP-5131 MAC address listed in the Designated Bridge column and the AP-5131 MAC address listed in the Designated Root column.

4. Click the **Logout** button to securely exit the AP-5131 Symbol Access Point applet. There will be a prompt confirming logout before the applet is closed.

7.3 Viewing Wireless Statistics

Use the **WLAN Statistics Summary** screen to view overview statistics for active (enabled) WLANs on the AP-5131. The **WLAN Summary** field displays basic information such as number of Mobile Units (MUs) and total throughput for each of the active WLANs. The **Total RF Traffic** section displays basic throughput information for all RF activity on the AP-5131. The WLAN Statistics Summary screen is view-only with no user configurable data fields.

If a WLAN is not displayed within the **Wireless Statistics Summary** screen, see [Enabling Wireless LANs \(WLANs\) on page 5-22](#) to enable the WLAN. For information on configuring the properties of individual WLANs, see [Creating/Editing Individual WLANs on page 5-24](#).

To view AP-5131 WLAN Statistics:

1. Select **Status and Statistics** -> **Wireless Stats** from the AP-5131 menu tree.

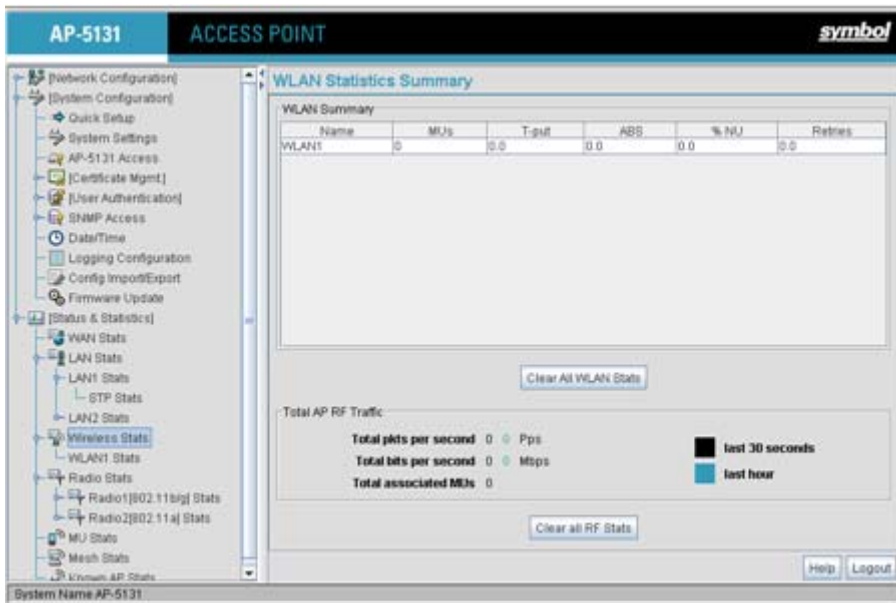

2. Refer to the **WLAN Summary** field to reference high-level data for each enabled WLAN.

<i>Name</i>	Displays the names of all the enabled WLANs on the AP-5131. For information on enabling a WLAN, see Enabling Wireless LANs (WLANs) on page 5-22 .
<i>MUs</i>	Displays the total number of MUs currently associated with each enabled WLAN. Use this information to assess if the MUs are properly grouped by function within each enabled WLAN. To adjust the maximum number of MUs permissible per WLAN, see Creating/Editing Individual WLANs on page 5-24 .
<i>T-put</i>	Displays the total throughput in Megabits per second (Mbps) for each active WLAN.
<i>ABS</i>	Displays the <i>Average Bit Speed (ABS)</i> in Megabits per second (Mbps) for each active WLAN displayed.
<i>% NU</i>	Displays a percentage of the total packets for each active WLAN that are non-unicast. Non-unicast packets include broadcast and multicast packets.

- Retries* Displays the average number of retries per packet. An excessive number could indicate possible network or hardware problems.
- Clear All WLAN Stats* Click this button to reset each of the data collection counters to zero in order to begin new data collections.
Do not clear the WLAN stats if currently in an important data gathering activity or risk losing all data calculations to that point.
3. Refer to the **Total AP RF Traffic** field to view throughput information for the AP-5131 and WLAN.

Total pkts per second Displays the average number of RF packets sent per second across all active WLANs on the AP-5131. The number in black represents packets for the last 30 seconds and the number in blue represents total pkts per second for the last hour.

Total bits per second Displays the average bits sent per second across all active WLANs on the AP-5131. The number in black displays this statistic for the last 30 seconds and the number in blue displays this statistic for the last hour.

Total associated MUs Displays the current number of MUs associated with the active WLANs on the AP-5131. If the number is excessive, reduce the maximum number of MUs that can associate with the AP-5131, for more information, see [Creating/Editing Individual WLANs on page 5-24](#).

Clear all RF Stats Click the **Clear all RF Stats** button to reset statistic counters for each WLAN, and the Total AP RF totals to 0. Do not clear RF stats if currently in an important data gathering activity or risk losing all data calculations to that point.
 4. Click the **Clear RF Stats** button to reset each of the data collection counters to zero in order to begin new data collections.
 5. Click the **Logout** button to securely exit the AP-5131 Symbol Access Point applet. A prompt displays confirming the logout before the applet is closed.

7.3.1 Viewing WLAN Statistics

Use the **WLAN Stats** screen to view detailed statistics for individual WLANs. The WLAN Stats screen is separated into four fields; *Information*, *Traffic*, *RF Status*, and *Errors*. The **Information** field displays basic information such as number of associated Mobile Units, ESSID and security

information. The **Traffic** field displays statistics on RF traffic and throughput. The **RF Status** field displays information on RF signal averages from the associated MUs. The **Error** field displays RF traffic errors based on retries, dropped packets, and undecryptable packets. The **WLAN Stats** screen is view-only with no user configurable data fields.

To view statistics for an individual WLAN:

1. Select **Status and Statistics** -> **Wireless Stats** -> **WLANx Stats** (x = target WLAN) from the AP-5131 menu tree.

The screenshot shows the 'WLAN1 Statistics' page in the AP-5131 web interface. The left sidebar contains a navigation tree with 'WLAN Stats' selected. The main content area is titled 'WLAN1 Statistics' and includes the following data:

- Information:** ESSID: 101, Radio/s: 802.11a, 802.11b/g, Authentication Type: No Authentication, Encryption Type: No Encryption, Num. Associated MUs: 0.
- Traffic:**

	Total	Rx	Tx
Packets per second	0.0 Pps	0.0 Pps	0.0 Pps
Throughput	0.00 Mbps	0.00 Mbps	0.00 Mbps
Avg. Bit Speed	0.00 Mbps		
Non-unicast pkts	0.0%	0.0%	
- RF Status:** Avg MU Signal: 0.0 dBm, Avg MU Noise: 0.0 dBm, Avg MU SNR: 0.0 dB.
- Errors:** Avg Num of Retries: 0.0, Dropped Packets: 0.0%, %Undecryptable Pkts: 0.0%.

At the bottom, there are radio buttons for 'last 30 seconds' (selected) and 'last hour', and a 'Clear WLAN Stats' button.

2. Refer to the **Information** field to view specific WLAN address, MU and security scheme information for the WLAN selected from the AP-5131 menu tree.

ESSID Displays the *Extended Service Set ID (ESSID)* for the target WLAN.

Radio/s Displays the name of the 802.11a or 802.11b/g radio the target WLAN is using for AP-5131 transmissions.

Authentication Type Displays the authentication type (802.1x EAP or Kerberos) defined for the WLAN. If the authentication type does not match the desired scheme for the WLAN or needs to be enabled, see [Enabling Authentication and Encryption Schemes on page 6-5](#).

- Encryption Type* Displays the encryption method defined for the WLAN. If the encryption type does not match the desired scheme for the WLAN or needs to be enabled, see [Enabling Authentication and Encryption Schemes on page 6-5](#).
- Num. Associated MUs* Displays the total number of MUs currently associated with the WLAN. If this number seems excessive, consider segregating MU's to other WLANs if appropriate.
3. Refer to the **Traffic** field to view performance and throughput information for the WLAN selected from the AP-5131 menu tree.
- Pkts per second* The **Total** column displays the average total packets per second crossing the selected WLAN. The **Rx** column displays the average total packets per second received on the selected WLAN. The **Tx** column displays the average total packets per second sent on the selected WLAN. The number in black represents this statistic for the last 30 seconds and the number in blue represents this statistic for the last hour.
- Throughput* The **Total** column displays average throughput in Mbps for a given time period on the selected WLAN. The **Rx** column displays average throughput in Mbps for packets received on the selected WLAN. The **Tx** column displays average throughput for packets sent on the selected WLAN. The number in black represents statistics for the last 30 seconds and the number in blue represents statistics for the last hour. Use this information to assess whether the current AP-5131 data rate is sufficient to support required network traffic.
- Avg. Bit Speed* The **Total** column displays the average bit speed in Mbps for a given time period on the selected WLAN. This includes all packets that are sent and received. The number in black represents statistics for the last 30 seconds and the number in blue represents statistics for the last hour. If the bit speed is significantly slower than the selected data rate, refer to the **RF Statistics** and **Errors** fields to troubleshoot.
- % Non-unicast pkts* Displays the percentage of the total packets that are non-unicast. Non-unicast packets include broadcast and multicast packets. The number in black represents packets for the last 30 seconds and the number in blue represents packets for the last hour.

4. Refer to the **RF Status** field to view the following MU signal, noise and performance information for the WLAN selected from the AP-5131 menu tree.

Avg MU Signal Displays the average RF signal strength in dBm for all MUs associated with the selected WLAN. The number in black represents this statistic for the last 30 seconds and the number in blue represents this statistic for the last hour. If the signal is low, consider mapping the MU to a different WLAN if a better functional grouping of MUs can be determined.

Avg MU Noise Displays the average RF noise for all MUs associated with the selected WLAN. The number in black represents MU noise for the last 30 seconds and the number in blue represents MU noise for the last hour. If MU noise is excessive, consider moving the MU closer to the AP-5131, or in area with less conflicting network traffic.

Avg MU SNR Displays the average *Signal to Noise Ratio (SNR)* for all MUs associated with the selected WLAN. The Signal to Noise Ratio is an indication of overall RF performance on your wireless networks.

5. Refer to the **Errors** field to view MU association error statistics for the WLAN selected from the AP-5131 menu tree.

Avg Num of Retries Displays the average number of retries for all MUs associated with the selected WLAN. The number in black represents average retries for the last 30 seconds and the number in blue represents average retries for the last hour.

Dropped Packets Displays the percentage of packets which the AP gave up on for all MUs associated with the selected WLAN. The number in black represents this statistic for the last 30 seconds and the number in blue represents this statistic for the last hour.

% of Undecryptable Pkts Displays the percentage of undecryptable packets for all MUs associated with the selected WLAN. The number in black represents undecryptable pkts for the last 30 seconds and the number in blue represents undecryptable pkts for the last hour.



NOTE The **Apply** and **Undo Changes** buttons are not available on the **WLAN Statistics** screen as this screen is view only with no configurable data fields.

- Click the **Clear WLAN Stats** button to reset each of the data collection counters to zero in order to begin new data collections.

Do not clear the WLAN stats if currently in an important data gathering activity or risk losing all data calculations to that point.

- Click the **Logout** button to securely exit the AP-5131 Symbol Access Point applet. A prompt displays confirming the logout before the applet is closed.

7.4 Viewing Radio Statistics Summary

Select the **Radio Stats Summary** screen to view high-level information (radio name, type, number of associated MUs, etc.) for the radio(s) enabled on an AP-5131. Individual radio statistics can be displayed as well by selecting a specific radio from within the AP-5131 menu tree.

To view high-level AP-5131 radio statistics:

- Select **Status and Statistics** -> **Radio Stats** from the AP-5131 menu tree.

The screenshot shows the AP-5131 web interface. The navigation tree on the left includes 'Status & Statistics' > 'Radio Stats'. The main content area displays the 'Radio Statistics Summary' screen with a table of radio statistics.

Type	MUs	T-pkt	ABS	RF Use	% NU	Retries
802.11b/g	0	0.0	0.0	0.0	0.0	0.0
802.11a	0	0.0	0.0	0.0	0.0	0.0

Below the table is a button labeled 'Clear All Radio Stats'. At the bottom right of the interface are 'Help' and 'Logout' buttons. The system name 'AP-5131' is visible at the top left and bottom left of the interface.

- Refer to the **Radio Summary** field to reference AP-5131 radio information.

<i>Type</i>	Displays the type of radio (either 802.11a or 802.11b/g) currently deployed by the AP-5131. To configure the radio type, see Setting the WLAN's Radio Configuration on page 5-45 .
<i>MUs</i>	Displays the total number of MUs currently associated with each AP-5131 radio.
<i>T-put</i>	Displays the total throughput in Megabits per second (Mbps) for each AP-5131 radio listed. To adjust the data rate for a specific radio, see Configuring the 802.11a or 802.11b/g Radio on page 5-48 .
<i>ABS</i>	Displays the <i>Average Bit Speed (ABS)</i> in Megabits per second (Mbps) for each AP-5131 radio.
<i>RF Util</i>	Displays the approximate RF Utilization for each AP-5131 radio
<i>% NU</i>	Displays the percentage of the total packets that are non-unicast. Non-unicast packets include broadcast and multicast packets.
<i>Retries</i>	Displays the average number of retries per packet on each radio. A high number could indicate network or hardware problems.

3. Click the **Clear All Radio Stats** button to reset each of the data collection counters to zero in order to begin new data collections.

Do not clear the radio stats if currently in an important data gathering activity or risk losing all data calculations to that point.

For information on viewing radio statistics particular to the AP-5131 radio type displayed within the AP Stats Summary screen, see [Viewing Radio Statistics on page 7-18](#).

4. Click the **Logout** button to securely exit the AP-5131 Symbol Access Point applet.

7.4.1 Viewing Radio Statistics

Refer to the **Radio Stats** screen to view detailed information for the AP-5131 radio (either 802.11a or 802.11b/g) displayed within the Radio Summary screen. There are four fields within the screen. The **Information** field displays device address and location information, as well as channel and power information. The **Traffic** field displays statistics for cumulative packets, bytes, and errors received and transmitted. The Traffic field does not add retry information to the stats displayed. Refer to the **RF Status** field for an average MU signal, noise and signal to noise ratio information. Finally, the **Errors** field displays retry information as well as data transmissions the AP-5131 radio either

dropped or could not decrypt. The information within the 802.11a Radio Statistics screen is view-only with no configurable data fields.

To view detailed radio statistics:

1. Select **Status and Statistics** -> **Radio Stats** -> **Radio1(802.11b/g) Stats** from the AP-5131 menu tree.

The screenshot shows the 'Radio2(802.11a) Statistics' page for AP-5131. The left navigation pane is expanded to 'Radio2(802.11a) Stats'. The main content area is divided into several sections:

- Information:**
 - HW Address: 00:A0:F8:72:22:00
 - Radio Type: 802.11a
 - Power: 20 dBm
 - Active WLANs: WLAN1
 - Placement: Outdoor
 - Current Channel: 161 (52)
 - Num. Associated MUs: 0
- Traffic:**

	Total	Rx	Tx
Packets per second	0 0 Pps	0 0 Pps	0 0 Pps
Throughput	0.00 0.00 Mbps	0.00 0.00 Mbps	0.00 0.00 Mbps
Avg. Bit Speed	0.00 0.00 Mbps		
Approximate RF Utilization	0.00% 0.00%		
Non-unicast pkts	0.00% 0.00%		
- RF Status:**
 - Avg MU Signal: 0.0 0.0 dBm
 - Avg MU Noise: 0.0 0.0 dBm
 - Avg MU SNR: 0.0 0.0 dB
- Errors:**
 - Avg Num of Retries: 0.00 0.00
 - Dropped Packets: 0.00% 0.00%
 - %Undecryptable Pkts: 0.00% 0.00%

At the bottom, there are radio buttons for 'last 30 seconds' (selected) and 'last hour', and a 'Clear Radio Stats' button.

2. Refer to the **Information** field to view the AP-5131 802.11a or 802.11b/g radio's MAC address, placement and transmission information.

HW Address The *Media Access Control (MAC)* address of the AP-5131 housing the 802.11a radio. The MAC address is set at the factory and can be found on the bottom of the AP.

Radio Type Displays the radio type (either 802.11a or 802.11b/g).

Power The power level in milliwatts (mW) for RF signal strength. To change the power setting for the radio, see [Configuring the 802.11a or 802.11b/g Radio on page 5-48](#).

Active WLANs Lists the AP-5131 WLANs adopted by the 802.11a or 802.11b/g radio.

- Placement* Lists whether the AP-5131 radio is indoors or outdoors. To change the placement setting, see [Configuring the 802.11a or 802.11b/g Radio on page 5-48](#).
- Current Channel* Indicates the channel for communications between the AP-5131 radio and its associated MUs. To change the channel setting, see [Configuring the 802.11a or 802.11b/g Radio on page 5-48](#).
- Num Associated MUs* Lists the number of mobile units (MUs) currently associated with the AP-5131 802.11a or 802.11b/g radio.
3. Refer to the **Traffic** field to view performance and throughput information for the target AP-5131 802.11a or 802.11b/g radio.

Pkts per second The **Total** column displays the average total packets per second crossing the radio. The **Rx** column displays the average total packets per second received. The **Tx** column displays the average total packets per second transmitted. The number in black represents this statistic for the last 30 seconds and the number in blue represents this statistic for the last hour.

Throughput The **Total** column displays average throughput on the radio. The **Rx** column displays average throughput in Mbps for packets received. The **Tx** column displays average throughput for packets transmitted. The number in black represents statistics for the last 30 seconds and the number in blue represents statistics for the last hour. Use this information to assess whether the current throughput is sufficient to support required network traffic.

Avg. Bit Speed The **Total** column displays the average bit speed in Mbps for the radio. This includes all packets transmitted and received. The number in black represents statistics for the last 30 seconds and the number in blue represents statistics for the last hour.

Approximate RF Utilization The approximate RF utilization of the AP-5131 radio. This value is calculated as throughput divided by average bit speed. The number in black represents this statistic for the last 30 seconds and the number in blue represents this statistic for the last hour.

% Non-unicast pkts Displays the percentage of total radio packets that are non-unicast. Non-unicast packets include broadcast and multicast packets. The number in black represents packets for the last 30 seconds and the number in blue represents packets for the last hour.

4. Refer to the **RF Status** field to view the following MU signal, noise and performance information for the target AP-5131 802.11a or 802.11b/g radio.

Avg MU Signal Displays the average RF signal strength in dBm for all MUs associated with the radio. The number in black represents the average signal for the last 30 seconds and the number in blue represents the average signal for the last hour. If the signal is low, consider mapping the MU to a different WLAN, if a better functional grouping of MUs can be determined.

Avg MU Noise Displays the average RF noise for all MUs associated with the AP-5131 radio. The number in black represents MU noise for the last 30 seconds and the number in blue represents MU noise for the last hour. If MU noise is excessive, consider moving the MU closer to the AP-5131, or in area with less conflicting network traffic.

Avg MU SNR Displays the average *Signal to Noise Ratio (SNR)* for all MUs associated with the AP-5131 radio. The Signal to Noise Ratio is an indication of overall RF performance on your wireless network.

5. Refer to the **Errors** field to reference retry information as well as data transmissions the target AP-5131 802.11a or 802.11 b/g radio either gave up on could not decrypt.

Avg Num. of Retries Displays the average number of retries for all MUs associated with the AP-5131 802.11a or 802.11b/g radio. The number in black represents retries for the last 30 seconds and the number in blue represents retries for the last hour.

Dropped Packets Displays the percentage of packets the AP gave up on for all MUs associated with the AP-5131 802.11a or 802.11b/g radio. The number in black represents this statistic for the last 30 seconds and the number in blue represents this statistic for the last hour.

% of Undecryptable Pkts Displays the percentage of undecryptable packets for all MUs associated with the 802.11a or 802.11b/g radio. The number in black represents packets for the last 30 seconds and the number in blue represents packets for the last hour.

6. Click the **Clear Radio Stats** button to reset each of the data collection counters to zero in order to begin new data collections.
7. Click the **Logout** button to securely exit the AP-5131 Symbol Access Point applet.

7.4.1.1 Retry Histogram

Refer to the **Retry Histogram** screen for an overview of the retries transmitted by an AP-5131 radio and whether those retries contained any data packets. Use this information in combination with the error fields within a Radio Stats screen to assess overall radio performance.

To display a Retry Histogram screen for an AP-5131 radio:

1. Select **Status and Statistics** -> **Radio Stats** -> **Radio1(802.11b/g) Stats** -> **Retry Histogram** from the AP-5131 menu tree.

A Radio Histogram screen is available for each AP-5131 radio (regardless of single or dual-radio model).

The screenshot shows the web interface for an AP-5131. The navigation tree on the left is expanded to show the path: Status & Statistics > Radio Stats > Radio1(802.11b/g) Stats > Retry Histogram. The main content area displays a table with two columns: Retries and Packets. The table contains 17 rows, numbered 0 to 16, representing the number of retries. The 'Retries' column shows the number of retries, and the 'Packets' column shows the number of packets transmitted for each retry count. The table is currently empty, with all values set to 0.

Retries	Packets
0	0
1	0
2	0
3	0
4	0
5	0
6	0
7	0
8	0
9	0
10	0
11	0
12	0
13	0
14	0
15	0
16	0

The table's first column shows 0 under **Retries**. The value under the **Packets** column directly to the right shows the number of packets transmitted by this AP-5131 radio that required 0 retries (delivered on the first attempt). As you go down the table you can see the number of packets requiring 1 retry, 2 retries etc. Use this information to assess whether an abundance of retries warrants reconfiguring the AP-5131 radio to achieve better performance.

2. Click **Apply** to save any changes to the Radio Histogram screen. Navigating away from the screen without clicking Apply results in changes to the screens being lost.
3. Click **Undo Changes** (if necessary) to undo any changes made to the screen. Undo Changes reverts the settings to the last saved configuration.
4. Click **Logout** to securely exit the AP-5131 Symbol Access Point applet. A prompt displays confirming the logout before the applet is closed.

7.5 Viewing MU Statistics Summary

Use the **MU Stats Summary** screen to display overview statistics for mobile units (MUs) associated with the AP-5131. The **MU List** field displays basic information such as IP Address and total throughput for each associated MU. The MU Stats screen is view-only with no user configurable data fields. However, individual MUs can be selected from within the MU Stats Summary screen to either ping to assess interoperability or display authentication statistics.

To view AP-5131 overview statistics for all of the MUs associated to the AP-5131:

1. Select **Status and Statistics** - > **MU Stats** from the AP-5131 menu tree.

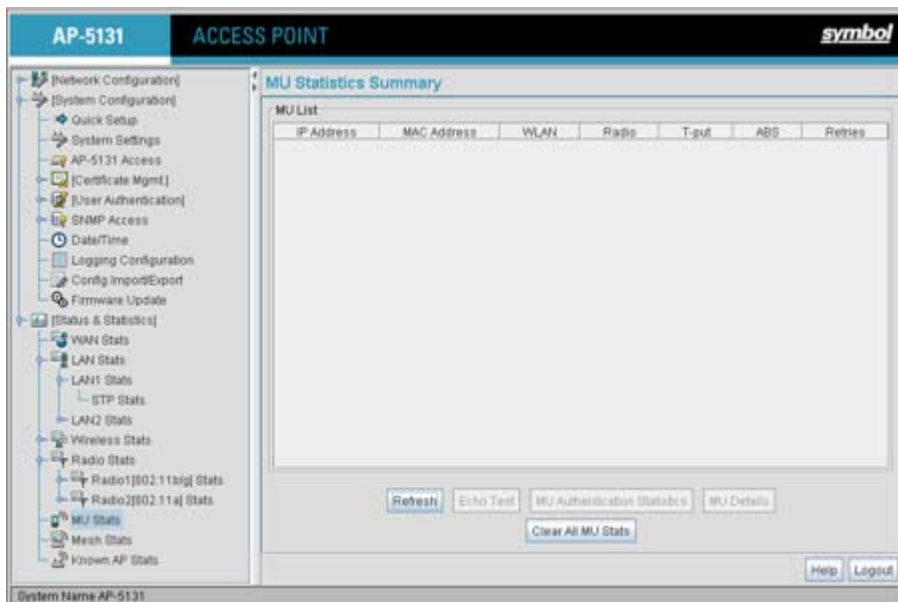

2. Refer to the **MU List** field to reference associated MU address, throughput and retry information.

<i>IP Address</i>	Displays the IP address of each of the associated MU.
<i>MAC Address</i>	Displays the MAC address of each of the associated MU.
<i>WLAN</i>	Displays the WLAN name each MU is interoperating with.
<i>Radio</i>	Displays the name of the 802.11a or 802.11b/g radio each MU is associated with.
<i>T-put</i>	Displays the total throughput in Megabits per second (Mbps) for each associated MU.
<i>ABS</i>	Displays the <i>Average Bit Speed (ABS)</i> in Megabits per second (Mbps) for each associated MU.
<i>Retries</i>	Displays the average number of retries per packet. A high number retries could indicate possible network or hardware problems.

3. Click the **Refresh** button to update the data collections displayed without resetting the data collections to zero.
4. Click the **Echo Test** button to display a screen for verifying the link with an associated MU. For detailed information on conducting a ping test for an MUs, see [Pinging Individual MUs on page 7-27](#).



NOTE An echo test initiated from the AP-5131 **MU Stats Summary** screen uses WNMP pings. Therefore, target clients that are not Symbol MUs are unable to respond to the echo test.

5. Click the **MU Authentication Statistics** button to display a screen with detailed authentication statistics for the an MU. For information on individual MU authentication statistics, see [MU Authentication Statistics on page 7-28](#).
6. Click the **MU Details** button to display a screen with detailed statistics for a selected MU. For detailed information on individual MU authentication statistics, see [Viewing MU Details on page 7-25](#).
7. Click the **Clear All MU Stats** button to reset each of the data collection counters to zero in order to begin new data collections.

- Click the **Logout** button to securely exit the AP-5131 Symbol Access Point applet. A prompt displays confirming the logout before the applet is closed.

7.5.1 Viewing MU Details

Use the **MU Details** screen to display throughput, signal strength and transmit error information for a specific MU associated with the AP-5131.

The MU Details screen is separated into four fields; *MU Properties*, *MU Traffic*, *MU Signal*, and *MU Errors*. The **MU Properties** field displays basic information such as hardware address, IP address, and associated WLAN and AP. Reference the **MU Traffic** field for MU RF traffic and throughput data. Use the **RF Status** field to reference information on RF signal averages from the target MU. The **Error** field displays RF traffic errors based on retries, dropped packets and undecryptable packets. The MU Details screen is view-only with no user configurable data fields.

To view details specific to an individual MU:

- Select **Status and Statistics** -> **MU Stats** from the AP-5131 menu tree.
- Highlight a specific MU.
- Select the **MU Details** button.
- Refer to the **MU Properties** field to view MU address information.

<i>IP Address</i>	Displays the IP address of the MU.
<i>WLAN Association</i>	Displays the name of the WLAN the MU is associated with. Use this information to assess whether the MU is properly grouped within that specific WLAN.
<i>PSP State</i>	Displays the current PSP state of the MU. The PSP Mode field has two potential settings. PSP indicates the MU is operating in Power Save Protocol mode. In PSP, the MU runs enough power to check for beacons and is otherwise inactive. CAM indicates the MU is continuously aware of all radio traffic. Symbol recommends CAM for those MUs transmitting with the AP frequently and for periods of time of two hours.
<i>HW Address</i>	Displays the <i>Media Access Control (MAC)</i> address for the MU.
<i>Radio Association</i>	Displays the name of the AP MU is currently associated with. If the name of the AP-5131 requires modification, see Configuring System Settings on page 4-2 .

QoS Client Type Displays the data type transmitted by the mobile unit. Possible types include **Legacy**, **Voice**, **WMM Baseline** and **Power Save**. For more information, see [Setting the WLAN Quality of Service \(QoS\) Policy on page 5-34](#).

Encryption Displays the encryption scheme deployed by the associated MU.

5. Refer to the **Traffic** field to view individual MU RF throughput information.

Packets per second The **Total** column displays average total packets per second crossing the MU. The **Rx** column displays the average total packets per second received on the MU. The **Tx** column displays the average total packets per second sent on the MU. The number in black represents Pkts per second for the last 30 seconds and the number in blue represents Pkts per second for the last hour.

Throughput The **Total** column displays the average total packets per second crossing the selected MU. The **Rx** column displays the average total packets per second received on the MU. The **Tx** column displays the average total packets per second sent on the MU. The number in black represents throughput for the last 30 seconds, the number in blue represents throughput for the last hour.

Avg. Bit Speed The **Total** column displays the average bit speed in Mbps for a given time period on the MU. This includes all packets sent and received. The number in black represents average bit speed for the last 30 seconds and the number in blue represents average bit speed for the last hour. Consider increasing the data rate of the AP if the current bit speed does not meet network requirements. For more information, see [Configuring the 802.11a or 802.11b/g Radio on page 5-48](#). The associated MU must also be set to the higher rate to interoperate with the AP-5131 at that data rate.

% of Non-unicast pkts Displays the percentage of the total packets for the selected mobile unit that are non-unicast. Non-unicast packets include broadcast and multicast packets. The number in black represents packets for the last 30 seconds and the number in blue represents packets for the last hour.

6. Refer to the **RF Status** field to view MU signal and signal disturbance information.

Avg MU Signal Displays RF signal strength in dBm for the target MU. The number in black represents signal information for the last 30 seconds and the number in blue represents signal information for the last hour.

Avg MU Noise Displays RF noise for the target MU. The number in black represents noise for the last 30 seconds, the number in blue represents noise for the last hour.

Avg MU SNR Displays the *Signal to Noise Ratio (SNR)* for the target MU. The Signal to Noise Ratio is an indication of overall RF performance on your wireless network.

7. Refer to the **Errors** field to view MU retry information and statistics on packets not transmitted.

Avg Num of Retries Displays the average number of retries for the MU. The number in black represents average retries for the last 30 seconds and the number in blue represents average retries for the last hour.

Dropped Packets Displays the percentage of packets the AP gave up as not received on for the selected MU. The number in black represents the percentage of packets for the last 30 seconds and the number in blue represents the percentage of packets for the last hour.

% of Undecryptable Pkts Displays the percentage of undecryptable packets for the MU. The number in black represents the percentage of undecryptable packets for the last 30 seconds and the number in blue represents the percentage of undecryptable packets for the last hour.

8. Click **OK** to exit the screen.

7.5.2 Pinging Individual MUs

The AP-5131 can verify its link with an MU by sending WNMP ping packets to the associated MU. Use the **Echo Test** screen to specify a target MU and configure the parameters of the ping test.



NOTE An echo test initiated from the AP-5131 **MU Stats Summary** screen uses WNMP pings. Therefore, target clients that are not Symbol MUs are unable to respond to the echo test.

To ping a specific MU to assess its connection with an AP-5131:

1. Select **Status and Statistics** - > **MU Stats** from the AP-5131 menu tree.
2. Select the **Echo Test** button from within the **MU Stats Summary** screen
3. Specify the following ping test parameters.

Station Address The IP address of the target MU. Refer to the **MU Stats Summary** screen for associated MU IP address information.

Number of ping Specify the number of ping packets to transmit to the target MU. The default is 100.

Packet Length Specify the length of each data packet transmitted to the target MU during the ping test. The default is 100 bytes.

Packet Data Defines the data to be transmitted as part of the test.

4. Click the **Ping** button to begin transmitting ping packets to the station address specified. Refer to the **Number of Responses** parameter to assess the number of responses from the target MU versus the number of pings transmitted by the AP-5131. Use the ratio of packets sent versus packets received to assess the link quality between MU and the AP-5131
Click the **Ok** button to exit the Echo Test screen and return to the MU Stats Summary screen.

7.5.3 MU Authentication Statistics

The AP-5131 can access and display authentication statistics for individual MUs.

To view AP-5131 authentication statistics for a specific MU:

1. Select **Status and Statistics** - > **MU Stats** from the AP-5131 menu tree.
2. Highlight a target MU from within the **MU List** field.
3. Click the **MU Authentication Statistics** button
Use the displayed statistics to determine if the target MU would be better served with a different AP-5131 WLAN or AP-5131 radio.
4. Click **Ok** to return to the MU Stats Summary screen.

7.6 Viewing the Mesh Statistics Summary

The AP-5131 has the capability of detecting and displaying the properties of other access points in mesh network (either base bridges or client bridges) mode. This information is used to create a list of known wireless bridges.

To view detected mesh network statistics:

1. Select **Status and Statistics** -> **Mesh Stats** from the AP-5131 menu tree.

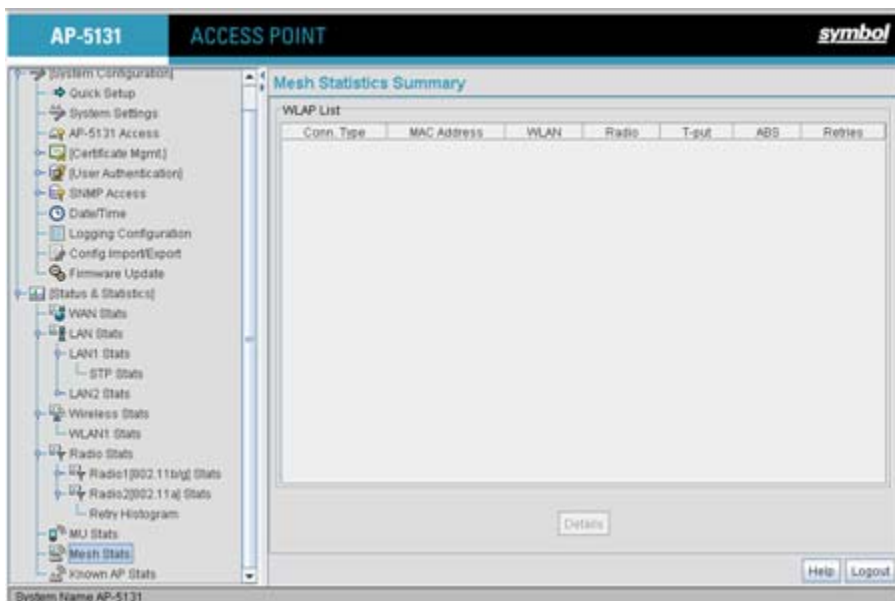

The **Mesh Statistics Summary** screen displays the following information:

Conn Type

Displays whether the bridge has been defined as a base bridge or a client bridge. For information on defining configuring the AP-5131 as either a base or client bridge, see [Configuring the AP-5131 Radio for Mesh Networking Support on page 9-10](#).

MAC Address

The unique 48-bit, hard-coded Media Access Control address, known as the devices station identifier. This value is hard coded at the factory by the manufacturer and cannot be changed.

<i>WLAN</i>	Displays the WLAN name each wireless bridge is interoperating with.
<i>Radio</i>	Displays the name of the 802.11a or 802.11b/g radio each bridge is associated with.
<i>T-put</i>	Displays the total throughput in Megabits per second (Mbps) for each associated bridge.
<i>ABS</i>	Displays the <i>Average Bit Speed (ABS)</i> in Megabits per second (Mbps) for each associated bridge.
<i>Retries</i>	Displays the average number of retries per packet. A high number of retries could indicate possible network or hardware problems.

2. Click the **Refresh** button to update the display of the Mesh Statistics Summary screen to the latest values.
3. Click the **Details** button to display address and radio information for those AP-5131s in a client bridge configuration with this detecting AP-5131.
4. Click the **Logout** button to securely exit the AP-5131 Symbol Access Point applet. A prompt displays confirming the logout before the applet is closed.

7.7 Viewing Known Access Point Statistics

The AP-5131 has the capability of detecting and displaying the properties of other Symbol access points located within its coverage area. Detected AP-5131's transmit a WNMP message indicating their channel, IP address, firmware version, etc. This information is used to create a known AP list. The list has fields indicating the properties of the access point discovered.

To view detected access point statistics:

1. Select **Status and Statistics** -> **Known AP Stats** from the AP-5131 menu tree.

The screenshot shows the 'Known AP Statistics' screen for a Symbol AP-5131. The left navigation pane is expanded to 'Known AP Stats'. The main content area displays a 'Known AP Summary' table with the following data:

IP Address	MAC Address	MUs	Unit Name
192.168.10.123	00 AD FB 72 57 83	0	AP-5131

Below the table are buttons for 'Clear Known AP Stats', 'Details', 'Ping', and 'Send Cfg to APs'. There is also a 'Flash All LEDs' section with 'Start Flash' and 'Stop Flash' buttons. At the bottom right are 'Help' and 'Logout' buttons. The system name 'AP-5131' is displayed at the bottom left of the interface.

The **Known AP Statistics** screen displays the following information:

<i>IP Address</i>	The network-assigned Internet Protocol address of the located AP.
<i>MAC Address</i>	The unique 48-bit, hard-coded Media Access Control address, known as the devices station identifier. This value is hard coded at the factory by the manufacturer and cannot be changed.
<i>MUs</i>	The number MUs associated with the located AP-5131.
<i>Unit Name</i>	Displays the name assigned to the AP-5131 using the System Settings screen. For information on changing the unit name, see Configuring System Settings on page 4-2 .

2. Click the **Clear Known AP Stats** button to reset each of the data collection counters to zero in order to begin new data collections.
3. Click the **Details** button to display AP-5131 address and radio information.

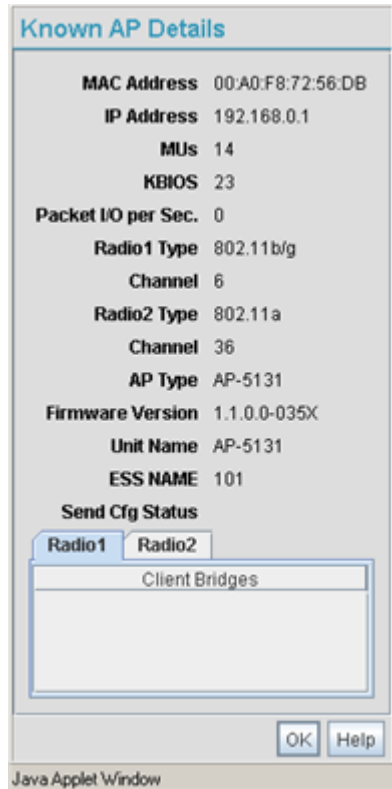

The Known AP Details screen displays the target AP's MAC address, IP address, radio channel, number of associated MUs, packet throughput per second, radio type(s), model, firmware version, ESS and client bridges currently connected to the AP radio. Use this information to determine whether this AP provides better MU association support than the locating AP-5131 or warrants consideration as a member of a different mesh network.

4. Click the **Ping** button to display a screen for verifying the link with a highlighted Symbol access point.



NOTE A ping test initiated from the AP-5131 **Known AP Statistics** screen uses WNMP pings. Therefore, target devices that are not Symbol access points are unable to respond to the ping test.

5. Click the **Send Cfg to APs** button to send the your AP-5131's configuration to other AP-5131's. Recipient AP-5131 must be the same single or dual-radio model as the AP-5131 sending the configuration. The sending and recipient AP-5131's must also be running the same major firmware version (i.e., 1.1 to 1.1).



CAUTION When using the Send Cfg to APs function to migrate an AP-5131's configuration to other AP-5131s, it is important to keep in mind mesh network configuration parameters do not get completely sent to other AP-5131s. The Send Cfg to APs function will not send the "auto-select" and "preferred list" settings. Additionally, LAN1 and LAN2 IP mode settings will only be sent if the sender's AP mode is DHCP or BOOTP. The WAN's IP mode will only be sent if the sender's IP mode is DHCP.

6. Click the **Start Flash** button to flash the LEDs of other AP-5131s detected and displayed within the Known AP Statistics screen.

Use the **Start Flash** button to determine the location of the devices displayed within the Known AP Statistics screen. When an AP-5131 is highlighted and the Start Flash button is selected, the LEDs on the selected AP-5131 flash. When the **Stop Flash** button is selected, the LEDs on the selected AP-5131 go back to normal operation.

7. Click the **Logout** button to securely exit the AP-5131 Symbol Access Point applet. A prompt displays confirming the logout before the applet is closed.

Command Line Interface Reference

The AP-5131 *Command Line Interface (CLI)* is accessed through the serial port or a Telnet session. The AP-5131 CLI follows the same conventions as the Web-based user interface. The CLI does, however, provide an “escape sequence” to provide diagnostics for problem identification and resolution.

The AP-5131 CLI treats the following as invalid characters:

| " & , \ ' < >

In order to avoid problems when using the AP-5131 CLI, these characters should be avoided.

8.1 Connecting to the CLI

8.1.1 Accessing the CLI through the Serial Port

To connect to the AP-5131 CLI through the serial port:

1. Connect one end of a null modem serial cable to the AP-5131's serial connector.
2. Attach the other end of the null modem serial cable to the serial port of a PC running HyperTerminal or a similar emulation program.
3. Set the HyperTerminal program to use 19200 baud, 8 data bits, 1 stop bit, no parity, no flow control, and auto-detect for terminal emulation.
4. Press <ESC> or <Enter> to enter into the CLI.
5. Enter the default username of **admin** and the default password of **symbol**. If this is your first time logging into the AP-5131, you are unable to access any of the AP-5131's commands until the country code is set. A new password will also need to be created.

8.1.2 Accessing the CLI via Telnet

To connect to the AP-5131 CLI through a Telnet connection:

1. Telnet into the AP-5131 using an IP address of 192.168.0.1
2. Enter the default username of **admin** and the default password of **symbol**. If this is your first time logging into the AP-5131, you are unable to access any of the AP-5131's commands until the country code is set. A new password will also need to be created.

8.2 Admin and Common Commands

AP5131>admin>

Description:

Displays admin configuration options. The items available under this command are shown below.

Syntax:

help	Displays general user interface help.
passwd	Changes the admin password.
summary	Shows a system summary.
network	Goes to the network submenu.
system	Goes to the system submenu.
stats	Goes to the stats submenu.
..	Goes to the parent menu.
/	Goes to the root menu.
save	Saves the configuration to system flash.
quit	Quits the CLI.

AP5131>admin>help**Description:**

Displays general CLI user interface help.

Syntax:

help Displays command line help using combinations of function keys for navigation.

Example:

```
admin>help
```

```

?                : display command help - Eg. ?, show ?, s?
* Restriction of "?": : "?" after a function argument is treated
                    : as an argument
                    : Eg. admin<network.lan> set lan enable?
                    : (Here "?" is an invalid extra argument,
                    : because it is after the argument
                    : "enable")

<ctrl-q>        : go backwards in command history
<ctrl-p>        : go forwards in command history

* Note          : 1) commands can be incomplete
                : - Eg. sh = sho = show
                : 2) "//" introduces a comment and gets no
                : resposne from CLI.

admin>
```

AP5131>admin>passwd

Description:

Changes the password for the admin login.

Syntax:

passwd Changes the admin password for AP-5131 access. This requires typing the old admin password and entering a new password and confirming it. Passwords can be up to 11 characters. The AP-5131 CLI treats the following as invalid characters:

| " & , \ ' < >

In order to avoid problems when using the AP-5131 CLI, these characters should be avoided.

Example:

```
admin>passwd
```

```
Old Admin Password:*****
```

```
New Admin Password:*****
```

```
Verify Admin Password:*****
```

```
Password successfully updated
```

For information on configuring passwords using the applet (GUI), see [Setting Passwords on page 6-3](#).

AP5131>admin>summary

Description:

Displays the AP-5131's system summary.

Syntax:

summary Displays a summary of high-level characteristics and settings for the WAN, LAN and WLAN.

Example:

```
admin>summary
```

AP-5131 firmware version	1.1.0.0-xxx
country code	us
serial number	00A0F8716A74

WLAN 1:

WLAN Name	WLAN1
ESS ID	101
Radio	11a, 11b/g
VLAN	VLAN1
Security Policy	Default
QoS Policy	Default

LAN1 Name: LAN1

LAN1 Mode: enable

LAN1 IP: 0.0.0.0

LAN1 Mask: 0.0.0.0

LAN1 Mask: client

LAN2 Name: LAN2

LAN2 Mode: enable

LAN2 IP: 192.235.1.1

LAN2 Mask: 255.255.255.0

LAN2 Mask: client

```
-----
WAN Interface  IP Address      Network Mask    Default Gateway  DHCP Client
-----
enable         172.20.23.10   255.255.255.192 172.20.23.20    enable
```

For information on displaying a system summary using the applet (GUI), see [Basic Device Configuration on page 3-5](#).

AP5131>admin>..**Description:**

Displays the parent menu of the current menu.

This command appears in all of the submenus under admin. In each case, it has the same function, to move up one level in the directory structure.

Example:

```
admin(network.lan)>..  
admin(network)>
```

AP5131>admin> /

Description:

Displays the root menu, that is, the top-level CLI menu.

This command appears in all of the submenus under admin. In each case, it has the same function, to move up to the top level in the directory structure.

Example:

```
admin(network.lan)>/  
admin>
```

AP5131>admin>save**Description:**

Saves the configuration to system flash.

The save command appears in all of the submenus under admin. In each case, it has the same function, to save the current configuration.

Syntax:

save Saves configuration settings. The save command works at all levels of the CLI. The save command must be issued before leaving the CLI for updated settings to be retained.

Example:

```
admin>save
admin>
```

AP5131>admin>quit

Description:

Exits the command line interface session and terminates the session.

The quit command appears in all of the submenus under admin. In each case, it has the same function, to exit out of the CLI. Once the quit command is executed, the login prompt displays again.

Example:

```
admin>quit
```

8.3 Network Commands

AP5131>admin(network)>

Description:

Displays the network submenu. The items available under this command are shown below.

lan	Goes to the LAN submenu.
wan	Goes to the WAN submenu.
wireless	Goes to the Wireless Configuration submenu.
firewall	Goes to the firewall submenu.
router	Goes to the router submenu.
..	Goes to the parent menu.
/	Goes to the root menu.
save	Saves the current configuration to the system flash.
quit	Quits the CLI and exits the current session.

8.3.1 Network LAN Commands

AP5131>admin(network.lan)>

Description:

Displays the LAN submenu. The items available under this command are shown below.

show	Shows current AP-5131 LAN parameters.
set	Sets LAN parameters.
bridge	Goes to the mesh configuration submenu.
wlan-mapping	Goes to the WLAN/Lan/Vlan Mapping submenu.
dhcp	Goes to the LAN DHCP submenu.
type-filter	Goes to the Ethernet Type Filter submenu.
..	Goes to the parent menu.
/	Goes to the root menu.
save	Saves the configuration to system flash.
quit	Quits the CLI.

For an overview of the AP-5131's LAN configuration options using the applet (GUI), see [Configuring the LAN Interface on page 5-1](#).

AP5131>admin(network.lan)> show**Description:**

Displays the AP-5131 LAN settings.

Syntax:

show Shows the settings for the AP-5131 LAN1 and LAN2 interfaces.

Example:

```
admin(network.lan)>show
```

```

LAN On Ethernet Port           : LAN1
LAN Ethernet Timeout          : disable

802.1x Port Authentication:
  Username                     : admin
  Password                     : *****

** LAN1 Information **
LAN Name                       : LAN1
LAN Interface                  : enable
802.11q Trunking              : disable

LAN IP mode                   : DHCP client
IP Address                    : 192.168.0.1
Network Mask                  : 255.255.255.255
Default Gateway               : 192.168.0.1
Domain Name                   :
Primary DNS Server            : 192.168.0.1
Secondary DNS Server          : 192.168.0.2
WINS Server                   : 192.168.0.254

** LAN2 Information **
LAN Name                       : LAN2
LAN Interface                  : disable
802.11q Trunking              : disable

LAN IP mode                   : DHCP server
IP Address                    : 192.168.1.1
Network Mask                  : 255.255.255.255
Default Gateway               : 192.168.1.1
Domain Name                   :

```

```
Primary DNS Server      : 192.168.0.2
Secondary DNS Server    : 192.168.0.3
WINS Server             : 192.168.0.255
```

```
admin(network.lan)>
```

For information on displaying LAN information using the applet (GUI), see [Configuring the LAN Interface on page 5-1](#).

AP5131>admin(network.lan)> set**Description:**

Sets the LAN parameters for the LAN port.

Syntax:

set lan	<mode>	Enables or disables the AP-5131 LAN interface.
name	<idx-name >	Defines the LAN name by index.
ethernet-port-lan	<idx>	Defines which LAN (LAN 1 or LAN 2) is active on the AP-5131's Ethernet port.
timeout	<seconds>	Sets the interval (in seconds) the AP-5131 uses to terminate its LAN interface if no activity is detected for the specified interval.
trunking	<mode>	Enables or disables 802.11q Trunking over the AP-5131 LAN port.
username	<name>	Specifies the user name for 802.1x port authentication over the LAN interface.
passwd	<password>	The 0-32 character password for the username for the 802.1x port.
ip-mode	<ip>	Defines the AP-5131 LAN port IP mode.
ipadr	<ip>	Sets the IP address used by the LAN port.
mask	<ip>	Defines the IP address used for AP-5131 LAN port network mask.
dgw	<ip>	Sets the Gateway IP address used by the LAN port.
domain	<name>	Specifies the domain name used by the AP-5131 LAN port.
dns	<ip>	Defines the IP address of the primary and secondary DNS servers used by the LAN port.
wins	<ip>	Defines the IP address of the WINS server used by the LAN port.

Example:

```
admin(network.lan)>

admin(network.lan)>set lan 1 enable
admin(network.lan)>set name 1 engineering
admin(network.lan)>set ethernet-port-lan 1
admin(network.lan)>set timeout 45
admin(network.lan)>set trunking 1 disable
admin(network.lan)>set dns 1 192.168.0.1
admin(network.lan)>set dns 2 192.168.0.2
admin(network.lan)>set wins 1 192.168.0.254
admin(network.lan)>set trunking disable
admin(network.lan)>set username phil
admin(network.lan)>set passwd ea0258c1
```

Related Commands:

show Shows the current settings for the AP-5131 LAN port.

For information on configuring the AP-5131 LAN using the applet (GUI), see [Configuring the LAN Interface on page 5-1](#).

8.3.1.1 Network LAN, Bridge Commands

AP5131>admin(network.lan.bridge)>

Description:

Displays the AP-5131 Bridge submenu.

show	Displays the mesh configuration parameters for the AP-5131's LANs.
set	Sets the mesh configuration parameters for the AP-5131's LANs..
..	Moves to the parent menu.
/	Goes to the root menu.
save	Saves the configuration to system flash.
quit	Quits the CLI and exits the session.

For an overview of the AP-5131's mesh networking options using the applet (GUI), see [Configuring Mesh Networking on page 9-1](#).

AP5131>admin(network.lan.bridge)> show**Description:**

Displays the mesh bridge configuration parameters for the AP-5131's LANs.

Syntax:

show Displays the mesh bridge configuration parameters for the AP-5131's LANs.

Example:

```
admin(network.lan.bridge)>show

** LAN1 Bridge Configuration **
Bridge Priority           :32768
Hello Time (seconds)     :2
Message Age Time (seconds) :20
Forward Delay Time (seconds) :15

Entry Ageout Time (seconds) :300

** LAN2 Bridge Configuration **
Bridge Priority           :32768
Hello Time (seconds)     :2
Message Age Time (seconds) :20
Forward Delay Time (seconds) :15

Entry Ageout Time (seconds) :300
```

For an overview of the AP-5131's mesh networking options using the applet (GUI), see [Configuring Mesh Networking on page 9-1](#).

AP5131>admin(network.lan.bridge)> set**Description:**

Sets the mesh configuration parameters for the AP-5131's LANs.

Syntax:

set priority	<LAN-idx>	<seconds>	Sets bridge priority time in seconds (0-65535) for specified LAN.
hello	<LAN-idx>	<seconds>	Sets bridge hello time in seconds (0-10) for specified LAN.
msgage	<LAN-idx>	<seconds>	Sets bridge message age time in seconds (6-40) for specified LAN.
fwddelay	<LAN-idx>	<seconds>	Sets bridge forward delay time in seconds (4-30) for specified LAN.
ageout	<LAN-idx>	<seconds>	Sets bridge forward table entry time in seconds (4-3600) for specified LAN.

Example:

```
admin(network.lan.bridge)>set priority 2 32768
admin(network.lan.bridge)>set hello 2 2
admin(network.lan.bridge)>set msgage 2 20
admin(network.lan.bridge)>set fwddelay 2 15
admin(network.lan.bridge)>set ageout 2 300
```

```
admin(network.lan.bridge)>show
```

```
** LAN1 Mesh Configuration **
Bridge Priority           :32768
Hello Time (seconds)     :2
Message Age Time (seconds) :20
Forward Delay Time (seconds) :15

Entry Ageout Time (seconds) :300

** LAN2 Mesh Configuration **
Bridge Priority           :32768
Hello Time (seconds)     :2
Message Age Time (seconds) :20
Forward Delay Time (seconds) :15

Entry Ageout Time (seconds) :300
```

For an overview of the AP-5131's mesh networking options using the applet (GUI), see [Configuring Mesh Networking on page 9-1](#).

8.3.1.2 Network LAN, WLAN-Mapping Commands

AP5131>admin(network.lan.wlan-mapping)>

Description:

Displays the WLAN/Lan/Vlan Mapping submenu.

show	Displays the VLAN list currently defined for the AP-5131.
set	Sets the AP-5131 VLAN configuration.
create	Creates a new AP-5131 VLAN.
edit	Edits the properties of an existing AP-5131 VLAN.
delete	Deletes a VLAN.
lan-map	Maps AP-5131 existing WLANs to an enabled LAN.
vlan-map	Maps AP-5131 existing WLANs to VLANs.
..	Moves to the parent menu.
/	Goes to the root menu.
save	Saves the configuration to system flash.
quit	Quits the CLI and exits the session.

For an overview of the AP-5131's VLAN configuration options using the applet (GUI), see [Configuring VLAN Support on page 5-4](#).

AP5131>admin(network.lan.wlan-mapping)> show**Description:**

Displays the VLAN list currently defined for the AP-5131.. These parameters are defined with the set command.

Syntax:

show	name	Displays the existing list of AP-5131 VLAN names.
	vlan-cfg	Shows WLAN-VLAN mapping and VLAN configuration.
	lan-wlan	Displays a WLAN-LAN mapping summary.
	wlan	Displays the WLAN summary list.

Example:

```
admin(network.lan.wlan-mapping)>show name
```

```
-----
Index      VLAN ID   VLAN Name
-----
```

```
1          1         VLAN_1
2          2         VLAN_2
3          3         VLAN_3
4          4         VLAN_4
```

```
admin(network.lan.wlan-mapping)>show vlan-cfg
```

```
Management VLAN Tag      :1
Native VLAN Tag          :2
WLAN                      :WLAN1
mapped to VLAN           :VLAN 2
VLAN Mode                 :static
```

```
admin(network.lan.wlan-mapping)>show lan-wlan
```

```
WLANs on LAN1:
```

```
      :WLAN1
      :WLAN2
      :WLAN3
```

```
WLANs on LAN2:
```

```
admin(network.lan.wlan-mapping)>show wlan
```

```
WLAN1:  
WLAN Name           :WLAN1  
ESSID               :101  
Radio               :  
VLAN                :  
Security Policy     :Default  
QoS Policy          :Default
```

For information on displaying the AP-5131 VLAN screens using the applet (GUI), see [Configuring VLAN Support on page 5-4](#).

AP5131>admin(network.lan.wlan-mapping)> set**Description:**

Sets VLAN parameters for the AP-5131.

Syntax:

set	mgmt-tag	<id>	Defines the Management VLAN tag (1-4095).
	native-tag	<id>	Sets the Native VLAN tag (1-4095).
	mode	<wlan-idx>	Sets WLAN VLAN mode (WLAN 1-16) to either dynamic or static.

Example:

```
admin(network.lan.wlan-mapping)>set mgmt-tag 1
admin(network.lan.wlan-mapping)>set native-tag 2
admin(network.lan.wlan-mapping)>set mode 1 static
```

```
admin(network.lan.wlan-mapping)>show vlan-cfg
```

```
Management VLAN Tag      :1
Native VLAN Tag          :2
WLAN                      :WLAN1
mapped to VLAN           :VLAN 2
VLAN Mode                :static
```

For information on configuring VLANs using the applet (GUI), see [Configuring VLAN Support on page 5-4](#).

AP5131>admin(network.lan.wlan-mapping)> create**Description:**

Creates a VLAN for the AP-5131.

Syntax:

create	vlan-id	<id>	Defines the VLAN ID (1-4095).
	vlan-name	<name>	Specifies the name of the VLAN (1-31 characters in length).

Example:

```
admin(network.lan.wlan-mapping)>  
admin(network.lan.wlan-mapping)>create 5 vlan-5
```

For information on creating VLANs using the applet (GUI), see [Configuring VLAN Support on page 5-4](#).

AP5131>admin(network.lan.wlan-mapping)> edit

Description:

Modifies a VLAN's name and ID.

Syntax:

edit	name	<name>	Modifies an existing VLAN name (1-31 characters in length)
	id	<id>	Modifies an existing VLAN ID (1-4095) characters in length.

For information on editing VLANs using the applet (GUI), see [Configuring VLAN Support on page 5-4](#).

AP5131>admin(network.lan.wlan-mapping)> delete**Description:**

Deletes a specific VLAN or all VLANs.

Syntax:

delete <VLAN id> Deletes a specific VLAN ID (1-16).
all Deletes all defined VLANs.

For information on deleting VLANs using the applet (GUI), see [Configuring VLAN Support on page 5-4](#).

AP5131>admin(network.lan.wlan-mapping)> lan-map

Description:

Maps an AP-5131 VLAN to a WLAN.

Syntax: ..

lan-map <wlan name><lan name> Maps an existing WLAN to an enabled AP-5131 LAN. All names and IDs are case-sensitive.

```
admin(network.lan.wlan-mapping)>lan-map wlan1 lan1
```

For information on mapping VLANs using the applet (GUI), see [Configuring VLAN Support on page 5-4](#).

AP5131>admin(network.lan.wlan-mapping)> vlan-map**Description:**

Maps an AP-5131 VLAN to a WLAN.

Syntax:

vlan-map <wlan name> <vlan name> Maps an existing WLAN to an enabled AP-5131 LAN. All names and IDs are case-sensitive.

```
admin(network.lan.wlan-mapping)>vlan-map wlan1 vlan1
```

For information on mapping VLANs using the applet (GUI), see [Configuring VLAN Support on page 5-4](#).

8.3.1.3 Network LAN, DHCP Commands

AP5131>admin(network.lan.dhcp)>

Description:

Displays the AP-5131 DHCP submenu. The items available are displayed below.

show	Displays DHCP parameters.
set	Sets DHCP parameters.
add	Adds static DHCP address assignments.
delete	Deletes static DHCP address assignments.
list	Lists static DHCP address assignments.
..	Goes to the parent menu.
/	Goes to the root menu.
save	Saves the configuration to system flash.
quit	Quits the CLI and exits the session.

AP5131>admin(network.lan.dhcp)> show**Description:**

Shows DHCP parameter settings.

Syntax:

show Displays DHCP parameter settings for the AP-5131. These parameters are defined with the set command.

Example:

```
admin(network.lan.dhcp)>show
**LAN1 DHCP Information**
DHCP Address Assignment Range:
    Starting IP Address   : 192.168.0.100
    Ending IP Address     : 192.168.0.254

Lease Time               : 86400

**LAN2 DHCP Information**
DHCP Address Assignment Range:
    Starting IP Address   : 192.168.0.100
    Ending IP Address     : 192.168.0.254

Lease Time               : 86400
```

For information on configuring DHCP using the applet (GUI), see [Configuring the LAN Interface on page 5-1](#).

AP5131>admin(network.lan.dhcp)> set**Description:**

Sets DHCP parameters for the LAN port.

Syntax:

set range	<LAN-idx>	<ip1>	<ip2>	Sets the DHCP assignment range from IP address <ip1> to IP address <ip2> for the specified LAN.
lease	<LAN-idx>	<lease>		Sets the DHCP lease time <lease> in seconds (1-999999) for the specified LAN.

Example:

```
admin(network.lan.dhcp)>set range 1 192.168.0.100 192.168.0.254
admin(network.lan.dhcp)>set lease 1 86400
```

```
admin(network.lan.dhcp)>show
**LAN1 DHCP Information**
DHCP Address Assignment Range:
    Starting IP Address   : 192.168.0.100
    Ending IP Address     : 192.168.0.254

Lease Time               : 86400
```

For information on configuring DHCP using the applet (GUI), see [Configuring the LAN Interface on page 5-1](#).

AP5131>admin(network.lan.dhcp)> add**Description:**

Adds static DHCP address assignments.

Syntax:

add <LAN-idx> <mac> <ip> Adds a reserved static IP address to a MAC address for the specified LAN.

Example:

```
admin(network.lan.dhcp)>add 1 00A0F8112233 192.160.24.6
admin(network.lan.dhcp)>add 1 00A0F1112234 192.169.24.7
admin(network.lan.dhcp)>list 1
```

```
-----
Index   MAC Address      IP Address
-----
1       00A0F8112233    192.160.24.6
2       00A0F8112234    192.169.24.7
```

For information on adding client MAC and IP address information using the applet (GUI), see [Configuring Advanced DHCP Server Settings on page 5-11](#).

AP5131>admin(network.lan.dhcp)> delete**Description:**

Deletes static DHCP address assignments.

Syntax:

delete <LAN-idx> <entry> Deletes the static DHCP address entry for the specified LAN.
 <LAN-idx> **all** Deletes all static DHCP addresses.

Example:

```
admin(network.lan.dhcp)>list 1
```

```
-----
Index   MAC Address      IP Address
-----
1       00A0F8112233    10.1.2.4
2       00A0F8102030    10.10.1.2
3       00A0F8112234    10.1.2.3
4       00A0F8112235    192.160.24.6
5       00A0F8112236    192.169.24.7
```

```
admin(network.lan.dhcp)>delete 1
```

```
-----
index   mac address      ip address
-----
1       00A0F8102030    10.10.1.2
2       00A0F8112234    10.1.2.3
3       00A0F8112235    192.160.24.6
4       00A0F8112236    192.169.24.7
```

```
admin(network.lan.dhcp)>delete 1 all
```

```
-----
index   mac address      ip address
-----
```

For information on deleting client MAC and IP address information using the applet (GUI), see [Configuring Advanced DHCP Server Settings on page 5-11](#).

AP5131>admin(network.lan.dhcp)> list**Description:**

Lists static DHCP address assignments.

Syntax:

list <LAN-idx> Lists the static DHCP address assignments for the specified LAN.

Example:

```
admin(network.lan.dhcp)>list 1
```

```
-----  
Index    MAC Address      IP Address  
-----  
1        00A0F8112233    10.1.2.4  
2        00A0F8102030    10.10.1.2  
3        00A0F8112234    10.1.2.3  
4        00A0F8112235    192.160.24.6  
5        00A0F8112236    192.169.24.7
```

```
admin(network.lan.dhcp)>
```

For information on listing client MAC and IP address information using the applet (GUI), see [Configuring Advanced DHCP Server Settings on page 5-11](#).

8.3.1.4 Network Type Filter Commands

AP5131>admin(network.lan.type-filter)>

Description:

Displays the AP-5131 Type Filter submenu. The items available under this command include:

.	
show	Displays the current Ethernet Type exception list.
set	Defines Ethernet Type Filter parameters.
add	Adds an Ethernet Type Filter entry.
delete	Removes an Ethernet Type Filter entry.
..	Goes to the parent menu.
/	Goes to the root menu.
save	Saves the configuration to system flash.
quit	Quits the CLI.

AP5131>admin(network.lan.type-filter)> show**Description:**

Displays the AP-5131's current Ethernet Type Filter configuration.

Syntax:

show <LAN-idx> Displays the existing Type-Filter configuration for the specified LAN.

Example:

```
admin(network.lan.type-filter)>show 1
```

```
Ethernet Type Filter mode           : allow
```

```
-----  
index           ethernet type  
-----
```

```
1                8137
```

For information on displaying the AP-5131's type filter configuration using the applet (GUI), see [Setting the Type Filter Configuration on page 5-13](#).

AP5131>admin(network.lan.type-filter)> set

Description:

Defines the AP-5131 Ethernet Type Filter configuration.

Syntax:

set mode <LAN-idx> **allow** or **deny** Allows or denies the AP-5131 from processing a specified Ethernet data type for the specified LAN.

Example:

```
admin(network.lan.type-filter)>set mode 1 allow
```

For information on configuring the AP-5131's type filter settings using the applet (GUI), see [Setting the Type Filter Configuration on page 5-13](#).

AP5131>admin(network.lan.type-filter)> add**Description:**

Adds an Ethernet Type Filter entry.

Syntax:

add <LAN-idx> <type> Adds entered Ethernet Type to list of data types either allowed or denied AP-5131 processing permissions for the specified LAN.

Example:

```
admin(network.lan.type-filter)>
```

```
admin(network.wireless.type-filter)>add 1 8137
```

```
admin(network.wireless.type-filter)>add 2 0806
```

```
admin(network.wireless.type-filter)>show 1
```

```
Ethernet Type Filter mode           : allow
```

```
-----
```

index	ethernet type
1	8137
2	0806
3	0800
4	8782

```
-----
```

For information on configuring the AP-5131's type filter settings using the applet (GUI), see [Setting the Type Filter Configuration on page 5-13](#).

AP5131>admin(network.lan.type-filter)> delete**Description:**

Removes an Ethernet Type Filter entry individually or the entire Type Filter list.

Syntax:

delete	<LAN-idx>	<index>	Deletes the specified Ethernet Type index entry (1 through 16).
	<LAN-idx>	all	Deletes all Ethernet Type entries currently in list.

Example:

```
admin(network.lan.type-filter)>delete 1 1
admin(network.lan.type-filter)>show 1
```

```
Ethernet Type Filter mode           : allow
```

```
-----
index                               ethernet type
-----
```

```
1                                   0806
2                                   0800
3                                   8782
```

```
admin(network.lan.type-filter)>delete 2 all
admin(network.lan.type-filter)>show 2
```

```
Ethernet Type Filter mode           : allow
```

```
-----
index                               ethernet type
-----
```

For information on configuring the AP-5131's type filter settings using the applet (GUI), see [Setting the Type Filter Configuration on page 5-13](#).

8.3.2 Network WAN Commands

AP5131>admin(network.wan)>

Description:

Displays the WAN submenu. The items available under this command are shown below.

show	Displays the AP-5131 WAN configuration and the AP-5131's current PPPoE configuration.
set	Defines the AP-5131's WAN and PPPoE configuration.
nat	Displays the NAT submenu, wherein Network Address Translations (NAT) can be defined.
vpn	Goes to the VPN submenu, where the AP-5131 VPN tunnel configuration can be set.
content	Displays the Outbound Content Filtering submenu, where data types can be included/excluded from AP-5131 throughput.
..	Goes to the parent menu.
/	Goes to the root menu.
save	Saves the current configuration to the AP-5131 system flash.
quit	Quits the CLI and exits the current session.

For an overview of the AP-5131's WAN configuration options using the applet (GUI), see [Configuring WAN Settings on page 5-14](#).

AP5131>admin(network.wan)> show**Description:**

Displays the AP-5131 WAN port parameters.

Syntax:

show Shows the general IP parameters for the WAN port along with settings for the WAN interface..

Example:

```
admin(network.wan)>show

Status                               : enable
WAN DHCP Client Mode                 : disable
IP address                           : 0.0.0.0
Network Mask                         : 0.0.0.0
Default Gateway                      : 10.10.1.1
Primary DNS Server                   : 0.0.0.0
Secondary DNS Server                 : 0.0.0.0

WAN IP 2                             : disable
WAN IP 3                             : disable
WAN IP 4                             : disable
WAN IP 5                             : disable
WAN IP 6                             : disable
WAN IP 7                             : disable
WAN IP 8                             : disable

PPPoE Mode                          : enable
PPPoE User Name                     : JohnDoe
PPPoE Password                      : *****
PPPoE keepalive mode                : enable
PPPoE Idle Time                     : 600
PPPoE Authentication Type           : chap
PPPoE State

admin(network.wan)>
```

For an overview of the AP-5131 WAN configuration options available using the applet (GUI), see [Configuring WAN Settings on page 5-14](#).

AP5131>admin(network.wan)> set**Description:**

Defines the configuration of the AP-5131 WAN port.

Syntax:

set wan	enable/disable		Enables or disables the AP-5131 WAN port.
dhcp	enable/disable		Enables or disables WAN DHCP Client mode.
ipadr	<idx>	<a.b.c.d>	Sets up to 8 (using <idx> from 1 to 8) IP addresses <a.b.c.d> for the AP-5131 WAN interface.
mask	<a.b.c.d>		Sets the subnet mask for the AP-5131 WAN interface.
dgw	<a.b.c.d>		Sets the default gateway IP address to <a.b.c.d>.
dns	<idx>	<a.b.c.d>	Sets the IP address of one or two DNS servers, where <idx> indicates either the primary (1) or secondary (2) server, and <a.b.c.d> is the IP address of the server.
pppoe	mode	enable/disable	Enables or disables PPPoE.
	user	<name>	Sets PPPoE user name.
	passwd	<password>	Defines the PPPoE password.
	ka	enable/disable	Enables or disables PPPoE keepalive.
	idle	<time>	Sets PPPoE idle time.
	type	<auth-type>	Sets PPPoE authentication type.

Example:

```
admin(network.wan)>
admin(network.wan)>set dhcp disable
admin(network.wan)>set ipadr 157.169.22.5
admin(network.wan)>set dgw 157.169.22.1
admin(network.wan)>set dns 1 157.169.22.2
admin(network.wan)>set mask 255.255.255.000
admin(network.wan)>set pppoe mode enable
admin(network.wan)>set pppoe type chap
admin(network.wan)>set pppoe user jk
admin(network.wan)>set pppoe passwd @$goodpassword%$#
admin(network.wan)>set pppoe ka enable
admin(network.wan)>set pppoe idle 600
```

For an overview of the AP-5131 WAN configuration options available using the applet (GUI), see [Configuring WAN Settings on page 5-14](#).

8.3.2.1 Network WAN NAT Commands

AP5131>admin(network.wan.nat)>

Description:

Displays the NAT submenu. The items available under this command are shown below.

show	Displays the AP-5131's current NAT parameters for the specified index.
set	Defines the AP-5131 NAT settings.
add	Adds NAT entries.
delete	Deletes NAT entries.
list	Lists NAT entries.
..	Goes to the parent menu.
/	Goes to the root menu.
save	Saves the configuration to system flash.
quit	Quits the CLI.

For an overview of the AP-5131 NAT configuration options available using the applet (GUI), see [Configuring Network Address Translation \(NAT\) Settings on page 5-19](#).

AP5131>admin(network.wan.nat)> show**Description:**

Displays AP-5131 NAT parameters.

Syntax:

show <idx> Displays AP-5131 NAT parameters for the specified NAT index.

Example:

```
admin(network.wan.nat)>show 2

WAN IP Mode           : disable
WAN IP Address        : 157.235.91.2
NAT Type              : 1-to-many
One to many nat mapping : LAN1 LAN2
Inbound Mappings      : Port Forwarding

unspecified port forwarding mode : enable
unspecified port fwd. ip address : 111.223.222.1

admin(network.wan.nat)>
```

For an overview of the AP-5131 NAT options available using the applet (GUI), see [Configuring Network Address Translation \(NAT\) Settings on page 5-19](#).

AP5131>admin(network.wan.nat)> set**Description:**

Sets NAT inbound and outbound parameters.

Syntax:

set type	<index>	<type>	Sets the type of NAT translation for WAN address index <idx> (1-8) to <type> (none, 1-to-1, or 1-to-many).
ip	<index>	<ip>	Sets NAT IP mapping associated with WAN address <idx> to the specified IP address <ip>.
inb	enable/disable	<ip>	Sets inbound NAT parameters.
outb	<ip>	<map>	Sets outbound NAT parameters.
mode	<index>	enable/disable	Enable or disable the AP-5131's Unspecified Port Forwarding mode for the designated NAT index.
unspec-ip	<index>	<ip>	Forward unspecified ports for the defined NAT index to the defined IP address.

Example:

```
admin(network.wan.nat)>set type 1-to-many
admin(network.wan.nat)>set ip 157.235.91.2
admin(network.wan.nat)>set mode 2 disable
admin(network.wan.nat)>set unspec-ip 2 111.223.222.1
```

```
admin(network.wan.nat)>show 2
```

```
WAN IP Mode           : disable
WAN IP Address        : 157.235.91.2
NAT Type              : 1-to-many
One to many nat mapping : LAN1 LAN2
Inbound Mappings      : Port Forwarding

unspecified port forwarding mode : enable
unspecified port fwd. ip address : 111.223.222.1
```

For an overview of the AP-5131 NAT options available using the applet (GUI), see [Configuring Network Address Translation \(NAT\) Settings on page 5-19](#).

AP5131>admin(network.wan.nat)> add**Description:**

Adds NAT entries.

Syntax:

```
add <idx> <name> <tran> <port1> <port2> <ip> <dst_port>
```

Sets an inbound network address translation (NAT) for WAN address <idx>, where <name> is the name of the entry (1 to 7 characters), <tran> is the transport protocol (one of **tcp**, **udp**, **icmp**, **ah**, **esp**, **gre**, or **all**), <port1> is the starting port number in a port range, <port2> is the ending port number in a port range, <ip> is the internal IP address, and <dst_port> is the (optional) internal translation port.

Example:

```
admin(network.wan.nat)>add 1 indoors udp 20 29 10.10.2.2
```

```
admin(network.wan.nat)>list 1
```

```
-----
index   name    prot   start port   end port   internal ip   translation port
-----
1       indoor  udp    20           29        10.10.2.2    0
```

Related Commands:

delete Deletes one of the inbound NAT entries from the list.
list Displays the list of inbound NAT entries.

For an overview of the AP-5131 NAT options available using the applet (GUI), see [Configuring Network Address Translation \(NAT\) Settings on page 5-19](#).

AP5131>admin(network.wan.nat)> delete**Description:**

Deletes NAT entries.

Syntax:

delete <idx> <entry> Deletes a specified NAT index entry <entry> associated with the WAN.
 <idx> **all** Deletes all NAT entries associated with the WAN.

Example:

```
admin(network.wan.nat)>list 1
-----
index  name  prot  start port  end port  internal ip  translation port
-----
1      special tcp  20        21        192.168.42.16  21

admin(network.wan.nat)>delete 1 1
      ^
admin(network.wan.nat)>list 1
-----
index  name  prot  start port  end port  internal ip  translation port
-----
```

Related Commands:

add Adds entries to the list of inbound NAT entries.
list Displays the list of inbound NAT entries.

For an overview of the AP-5131 NAT options available using the applet (GUI), see [Configuring Network Address Translation \(NAT\) Settings on page 5-19](#).

AP5131>admin(network.wan.nat)> list**Description:**

Lists AP-5131 NAT entries for the specified index.

Syntax:

list <idx> Lists the inbound NAT entries associated with WAN port.

Example:

```
admin(network.wan.nat)>list 1
```

```
-----
index  name      Transport  start port  end port  internal ip  translation
port
-----
1      special tcp      20         21         192.168.42.16  21
-----
```

Related Commands:

delete Deletes inbound NAT entries from the list.
add Adds entries to the list of inbound NAT entries.

For an overview of the AP-5131 NAT options available using the applet (GUI), see [Configuring Network Address Translation \(NAT\) Settings on page 5-19](#).

8.3.2.2 Network WAN, VPN Commands

AP5131>admin(network.wan.vpn)>

Description:

Displays the VPN submenu. The items available under this command include:

add	Adds VPN tunnel entries.
set	Sets key exchange parameters.
delete	Deletes VPN tunnel entries.
list	Lists VPN tunnel entries
reset	Resets all VPN tunnels.
stats	Lists security association status for the VPN tunnels.
ikestate	Displays an Internet Key Exchange (IKE) summary.
..	Goes to the parent menu.
/	Goes to the root menu.
save	Saves the configuration to system flash.
quit	Quits the CLI.

For an overview of the AP-5131 VPN options available using the applet (GUI), see [Configuring VPN Tunnels on page 6-34](#).

AP5131>admin(network.wan.vpn)> add**Description:**

Adds a VPN tunnel entry.

Syntax:

```
add <name> <LAN idx> <LWanIP> <RSubnetIP> <RSubnetMask> <RGatewayIP>
```

Creates a tunnel <name>(1 to 13 characters) to gain access through local WAN IP <LWanIP> from the remote subnet with address <RSubnetIP> and subnet mask <RSubnetMask> using the remote gateway <RGatewayIP>.

Example:

```
admin(network.wan.vpn)>add 2 SJSarkey 209.235.44.31 206.107.22.46  
255.255.255.224 206.107.22.1
```

If tunnel type is Manual, proper SPI values and Keys must be configured after adding the tunnel

```
admin(network.wan.vpn)>
```

For information on configuring VPN using the applet (GUI), see [Configuring VPN Tunnels on page 6-34](#).

AP5131>admin(network.wan.vpn)> set**Description:**

Sets VPN entry parameters.

Syntax:

set type	<name>	<tunnel type>	Sets the tunnel type <name> to Auto or Manual for the specified tunnel name.	
authalgo	<name>	<authalgo>	Sets the authentication algorithm for <name> to (None , MD5 , or SHA1).	
authkey	<name>	<dir> <authkey>	Sets the AH authentication key (if type is Manual) for tunnel <name> with the direction set to IN or OUT , and the manual authentication key set to <authkey>. (The key size is 32 hex characters for MD5, and 40 hex characters for SHA1).	
esp-type	<name>	<esptype>	Sets the Encapsulating Security Payload (ESP) type. Options include None , ESP , or ESP-AUTH .	
esp-encalgo	<name>	<escalgo>	Sets the ESP encryption algorithm. Options include DES , 3DES , AES128 , AES192 , or AES256 .	
esp-enckey	<name>	<dir> <enckey>	Sets the Manual Encryption Key in ASCII for tunnel <name> and direction IN or OUT to the key <enckey>. The size of the key depends on the encryption algorithm. <ul style="list-style-type: none"> - 16 hex characters for DES - 48 hex characters for 3DES - 32 hex characters for AES128 - 48 hex characters for AES192 - 64 hex characters for AES256 	
esp-authalgo	<name>	<authalgo>	Sets the ESP authentication algorithm. Options include MD5 or SHA1 .	
esp-authkey	<name>	<dir> <authkey>	Sets ESP Authentication key <name> either for IN or OUT direction to <auth-key>, an ASCII string of hex characters. If authalgo is set to MD5 , then provide 32 hex characters. If authalgo is set to SHA1 , provide 40 hex characters.	
spi	<name>	<algo> <dir>	<value>	Sets 6 character IN (bound) or OUT (bound) for AUTH (Manual Authentication) or ESP for <name> to <spi> (a hex value more than 0xFF) <value>.
usepfs	<name>	<mode>	Enables or disables Perfect Forward Secrecy for <name>.	

salife	<name>	<lifetime>		Defines the name of the tunnel <name> the Security Association Life Time <300-65535> applies to in seconds.
ike	opmode	<name>	<opmode>	Sets the Operation Mode of IKE for <name> to Main or Aggr (essive).
	myidtype	<name>	<idtype>	Sets the Local ID type for IKE authentication for <name> (1 to 13 characters) to <idtype> (IP , FQDN , or UFQDN).
	remidtype	<name>	<idtype>	Sets the Remote ID type for IKE authentication for <name> (1 to 13 characters) to <idtype> (IP , FQDN , or UFQDN).
	myiddata	<name>	<idtype>	Sets the Local ID data for IKE authentication for <name> to <idtype>. This value is not required when the ID type is set to IP.
	remiddata	<name>	<idtype>	Sets the Local ID data for IKE authentication for <name> to <idtype>. This value is not required when the ID type is set to IP.
	authtype	<name>	<authtype>	Sets the IKE Authentication type for <name> to <authtype> (PSK or RSA).
	authalgo	<name>	<authalgo>	Sets the IKE Authentication Algorithm for <name> to MD5 or SHA1 .
	phrase	<name>	<phrase>	Sets the IKE Authentication passphrase for <name> to <phrase>.
	encalgo	<name>	<encalgo>	Sets the IKE Encryption Algorithm for <name> to <encalgo> (one of DES , 3DES , AES128 , AES192 , or AES256).
	lifetime	<name>	<lifetime>	Sets the IKE Key life time in seconds for <name> to <lifetime>.
	group	<name>	<group>	Sets the IKE Diffie-Hellman Group for <name> to either G768 or G1024 .

For information on configuring VPN using the applet (GUI), see [Configuring VPN Tunnels on page 6-34](#).

AP5131>admin(network.wan.vpn)> delete**Description:**

Deletes VPN tunnel entries.

Syntax:

delete **all** Deletes all VPN entries.
 <name> Deletes VPN entries <name>.

Example:

```
admin(network.wan.vpn)>list
```

```
-----
Tunnel Name   Type       Remote IP/Mask   Remote Gateway   Local WAN IP
-----
Eng2EngAnnex   Manual   192.168.32.2/24   192.168.33.1    192.168.24.198
SJSharkey      Manual   206.107.22.45/27 206.107.22.2    209.235.12.55
```

```
admin(network.wan.vpn)>delete Eng2EngAnnex
```

```
admin(network.wan.vpn)>list
```

```
-----
Tunnel Name   Type       Remote IP/Mask   Remote Gateway   Local WAN IP
-----
SJSharkey      Manual   206.107.22.45/27 206.107.22.2    209.235.12.55
```

```
admin(network.wan.vpn)>
```

For information on configuring VPN using the applet (GUI), see [Configuring VPN Tunnels on page 6-34](#).

AP5131>admin(network.wan.vpn)> list**Description:**

Lists VPN tunnel entries.

Syntax:

list <cr> Lists all tunnel entries.
 <name> Lists detailed information about tunnel named <name>. Note that the <name> must match case with the name of the VPN tunnel entry

Example:

```
admin(network.wan.vpn)>list
```

```
-----
Tunnel Name      Type      Remote IP/Mask      Remote Gateway      Local WAN IP
-----
Eng2EngAnnex    Manual    192.168.32.2/24     192.168.33.1       192.168.24.198
SJSharkey       Manual    206.107.22.45/27    206.107.22.2       209.235.12.55
```

```
admin(network.wan.vpn)>list SJSharkey
```

```
-----
Detail listing of VPN entry:
-----
```

```
Name                : SJSharkey
Local Subnet         : 1
Tunnel Type          : Manual
Remote IP            : 206.107.22.45
Remote IP Mask       : 255.255.255.224
Remote Security Gateway : 206.107.22.2
Local Security Gateway : 209.239.160.55
AH Algorithm         : None
Encryption Type      : ESP
Encryption Algorithm : DES
ESP Inbound SPI      : 0x00000100
ESP Outbound SPI     : 0x00000100
```

For information on displaying VPN information using the applet (GUI), see [Viewing VPN Status on page 6-48](#).

AP5131>admin(network.wan.vpn)> reset

Description:

Resets all of the AP-5131's VPN tunnels.

Syntax:

reset Resets all VPN tunnels.

Example:

```
admin(network.wan.vpn)>reset
```

```
VPN tunnels reset.
```

```
admin(network.wan.vpn)>
```

For information on configuring VPN using the applet (GUI), see [Configuring VPN Tunnels on page 6-34](#).

AP5131>admin(network.wan.vpn)> stats**Description:**

Lists statistics for all active tunnels.

Syntax:

stats Display statistics for all VPN tunnels.

Example:

```
admin(network.wan.vpn)>stats
```

```
-----  
Tunnel Name    Status        SPI(OUT/IN)        Life Time        Bytes(Tx/Rx)  
-----  
Eng2EngAnnex   Not Active  
SJSharkey       Not Active
```

For information on displaying VPN information using the applet (GUI), see [Viewing VPN Status on page 6-48](#).

AP5131>admin(network.wan.vpn)> ikestate**Description:**

Displays statistics for all active tunnels using Internet Key Exchange (IKE).

Syntax:

ikestate Displays status about Internet Key Exchange (IKE) for all tunnels. In particular, the table indicates whether IKE is connected for any of the tunnels, it provides the destination IP address, and the remaining lifetime of the IKE key.

Example:

```
admin(network.wan.vpn)>ikestate
```

```
-----
Tunnel Name    IKE State          Dest IP           Remaining Life
-----
Eng2EngAnnex   Not Connected     -----          ---
SJSharkey      Not Connected     -----          ---
```

```
admin(network.wan.vpn)>
```

For information on configuring IKE using the applet (GUI), see [Configuring IKE Key Settings on page 6-44](#).

8.3.3 Network Wireless Commands

AP5131>admin(network.wireless)

Description:

Displays the AP-5131 wireless submenu. The items available under this command include:

wlan	Displays the WLAN submenu used to create and configure up to 16 WLANs per AP-5131.
security	Displays the security submenu used to create encryption and authentication based security policies for use with AP-5131 WLANs.
acl	Displays to the <i>Access Control List</i> (ACL) submenu to restrict or allow MU access to AP-5131 WLANs.
radio	Displays the radio configuration submenu used to specify how the 802.11a or 802.11b/g radio is used with specific WLANs.
qos	Displays the <i>Quality of Service</i> (QoS) submenu to prioritize specific kinds of data traffic within a WLAN.
bandwidth	Displays the Bandwidth Management submenu used to configure the order data is processed by an AP-5131 radio.
rogue-ap	Displays the Rogue-AP submenu to configure devices located by the AP-5131 as friendly or threatening for interoperability.
..	Goes to the parent menu.
/	Goes to the root menu.
save	Saves the configuration to system flash.
quit	Quits the CLI.

8.3.3.1 Network WLAN Commands

AP5131>admin(network.wireless.wlan)>

Description:

Displays the AP-5131 wireless LAN (WLAN) submenu. The items available under this command include:

.	
show	Displays the AP-5131's current WLAN configuration.
create	Defines the parameters of a new WLAN.
edit	Modifies the properties of an existing WLAN.
delete	Deletes an existing WLAN.
hotspot	Displays the WLAN hotspot menu.
..	Goes to the parent menu.
/	Goes to the root menu.
save	Saves the configuration to system flash.
quit	Quits the CLI.

For an overview of the Wireless configuration options available to the AP-5131 using the applet (GUI), see [Enabling Wireless LANs \(WLANs\) on page 5-22](#).

AP5131>admin(network.wireless.wlan)> show**Description:**

Displays the AP-5131's current WLAN configuration.

Syntax:

show	summary	Displays the current configuration for existing WLANs.
	wlan <number>	Displays the configuration for the requested WLAN (WLAN 1 through 16).

Example:

```
admin(network.wireless.wlan)>show summary
```

```
WLAN1
WLAN Name           : Lobby
ESSID               : 101
Radio               : 11a, 11b/g
VLAN                :
Security Policy     : Default
QoS Policy          : Default
```

```
admin(network.wireless.wlan)>show wlan 1
```

```
ESS Identifier      : 101
WLAN Name           : Lobby
802.11a Radio       : available
802.11b/g Radio     : not available
Client Bridge Mesh Backhaul : available
Hotspot             : not available
Maximum MUs         : 127
Security Policy     : Default
MU Access Control   : Default
Kerberos User Name  : 101
Kerberos Password   : *****
Disallow MU to MU Communication : disable
Use Secure Beacon   : disable
Accept Broadcast ESSID : disable
QoS Policy          : Default
```

For information on displaying WLAN information using the applet (GUI), see [Enabling Wireless LANs \(WLANs\) on page 5-22](#).

AP5131>admin(network.wireless.wlan)> create**Description:**

Defines the parameters of a new AP-5131 WLAN.

Syntax:**create**

show	wlan	<number>	Displays newly created WLAN and policy number.
set	ess	<essid>	Defines the ESSID for a target WLAN.
	wlan-name	<name>	Determines the name of this particular WLAN (1-32).
	11a	<mode>	Enables or disables access to the AP-5131 802.11a radio.
	11bg	<mode>	Enables or disables access to the AP-5131 802.11b/g radio.
	mesh	<mode>	Enables or disables the Client Bridge Mesh Backhaul option.
	hotspot	<mode>	Enables or disables the Hotspot mode.
	max-mu	<number>	Defines the maximum number of MU able to operate within the WLAN (default = 127 MUs).
	security	<name>	Sets the security policy to the WLAN (1-32).
	acl	<name>	Sets the MU ACL policy to the WLAN (1-32).
	passwd	<ascii string>	Defines a Kerberos password used if the WLAN's security policy uses a Kerberos server-based authentication scheme.
	no-mu-mu	<mode>	Enables or disables MUs associated to the same WLAN to not communicate with each other.
	sbeacon	<mode>	Enables or disables the AP-5131 from transmitting the ESSID in the beacon.
	bcast	<mode>	Enables or disables the AP-5131 from accepting broadcast IDs from MUs. Broadcast IDs are transmitted without security.
	qos	<name>	Defines the index name representing the QoS policy used with this WLAN.
	add-wlan		Apply the changes to the modified WLAN and exit.
	..		Disregard the changes to the modified WLAN and exit.

Example:

```
admin(network.wireless.wlan.create)>show wlan
```

```
ESS Identifier           :
WLAN Name               :
802.11a Radio           : available
802.11b/g Radio         : not available
Client Bridge Mesh Backhaul : not available
Hotspot                 : not available
Maximum MUs             : 127
Security Policy         : Default
MU Access Control       :
Kerberos User Name     : Default
Kerberos Password      : *****
Disallow MU to MU Communication : disable
Use Secure Beacon      : disable
```

```
Accept Broadcast ESSID      : disable
QoS Policy                  : Default
```

```
admin(network.wireless.wlan.create)>show security
```

```
-----
Secu Policy Name      Authen      Encryption      Associated WLANs
-----
1 Default             Manual      no encrypt      Front Lobby
2 WEP Demo            Manual      WEP 64          2nd Floor
3 Open                Manual      no encrypt      1st Floor
```

```
admin(network.wireless.wlan.create)>show acl
```

```
-----
ACL Policy Name      Associated WLANs
-----
1 Default             Front Lobby
2 Admin               3rd Floor
3 Demo Room           5th Floor
```

```
admin(network.wireless.wlan.create)>show qos
```

```
-----
QOS Policy Name      Associated WLANs
-----
1 Default             Front Lobby
2 Voice               Audio Dept
3 Video               Video Dept
```

For information on creating a WLAN using the applet (GUI), see [Creating/Editing Individual WLANs on page 5-24](#).

AP5131>admin(network.wireless.wlan)> edit

Description:

Edits the properties of an existing WLAN policy.

Syntax:

edit	<index>	Edits the properties of an existing WLAN policy.
show		Displays the WLANs parameters and summary.
set		Edits the same WLAN parameters that can be modified using the create command.
change		Completes the WLAN edits and exits the CLI session.
	..	Cancel the WLAN edits and exit the CLI session.

For information on editing a WLAN using the applet (GUI), see [Creating/Editing Individual WLANs on page 5-24](#).

AP5131>admin(network.wireless.wlan)> delete**Description:**

Deletes an existing WLAN.

Syntax:

delete <wlan-name> Deletes a target WLAN by name supplied.
all Deletes all WLANs defined.

For information on deleting a WLAN using the applet (GUI), see [Creating/Editing Individual WLANs on page 5-24](#).

AP5131>admin(network.wireless.wlan.hotspot)>

Description:

Displays the Hotspot submenu. The items available under this command include:

.	Show hotspot parameters.
show	Show hotspot parameters.
redirection	Goes to the hotspot redirection menu.
radius	Goes to the hotspot Radius menu.
white-list	Goes to the hotspot white-list menu.
save	Saves the configuration to system flash.
quit	Quits the CLI.
..	Goes to the parent menu.
/	Goes to the root menu.

For information on configuring the Hotspot options available to the AP-5131 using the applet (GUI), see [Configuring WLAN Hotspot Support on page 5-40](#).

AP5131>admin(network.wireless.wlan.hotspot)> show**Description:**

Displays the current AP-5131 Rogue AP detection configuration.

Syntax:

show hotspot <idx> Shows hotspot parameters per wlan index (1-16).

Example:

```
admin(network.wireless.wlan.hotspot)>show hotspot 1
```

```
WLAN1
```

```
Hotspot Mode           : enable
Hotspot Page Location  : default
External Login URL     : www.sjsharkey.com
External Welcome URL   :
External Fail URL      :
```

```
Primary Server Ip adr  :157.235.21.21
Primary Server Port    :1812
Primary Server Secret  :*****
Secondary Server Ip adr :157.235.32.12
Secondary Server Port  :1812
Secondary Server Secret :*****
Accounting Mode        :disable
Accounting Server Ip adr :0.0.0.0
Accounting Server Port  :1813
Accounting Server Secret :*****
Accounting Timeout     :10
Accounting Retry-count :3
```

```
Whitelist Rules?
```

```
-----
      Idx          IP Address
-----
      1           157.235.121.12
```

For information on configuring the Hotspot options available to the AP-5131 using the applet (GUI), see [Configuring WLAN Hotspot Support on page 5-40](#).

AP5131>admin(network.wireless.wlan.hotspot)> redirection**Description:**

Goes to the hotspot redirection menu.

Syntax:

redirection set	<page-loc>	Sets the hotspot http-re-direction by index (1-16) for the specified URL.
	<exturl>	Shows hotspot http-redirection details for specified index (1-16) for specified page (login, welcome, fail) and target URL..
show		Shows hotspot http-redirection details.
save		Saves the updated hotspot configuration to flash memory.
quit		Quits the CLI session.
..		Goes to the parent menu.
/		Goes to the root menu.

Example:

```
admin(network.wireless.wlan.hotspot)>set page-loc 1 www.sjsharkey.com
admin(network.wireless.wlan.hotspot)>set exturl 1 fail www.sjsharkey.com
```

For information on configuring the Hotspot options available to the AP-5131 using the applet (GUI), see [Configuring WLAN Hotspot Support on page 5-40](#).

AP5131>admin(network.wireless.wlan.hotspot)> radius**Description:**

Goes to the hotspot Radius menu.

Syntax:

set	Sets the Radius hotspot configuration.
show	Shows Radius hotspot server details.
save	Saves the configuration to system flash.
quit	Quits the CLI.
..	Goes to the parent menu.
/	Goes to the root menu.

For information on configuring the Hotspot options available to the AP-5131 using the applet (GUI), see [Configuring WLAN Hotspot Support on page 5-40](#).

AP5131>admin(network.wireless.wlan.hotspot.radius)> set**Description:**

Sets the Radius hotspot configuration.

Syntax:

set	server	<idx>	<svr_type>	<ipadr>	Sets the Radius hotpost server IP address per wlan index (1-16)
	port	<idx>	<svr_type>	<port>	Sets the Radius hotpost server port per wlan index (1-16)
	secret	<idx>	<svr_type>	<secret>	Sets the Radius hotspot server shared secret password.
	acct-mode	<idx>	<mode>		Sets the Radius hotspot server accounting mode (enable/disable)
	acct-server	<idx>	<ipadr>		Sets the Radius hotspot accounting server IP address per wlan index (1-16).
	acct-port	<idx>	<port>		Sets the Radius hotspot accounting server port per wlan index (1-16).
	acct-secret	<idx>	<secret>		Sets the Radius hotspot server shared secret password per wlan index (1-16).
	acct-timeout	<idx>	<timeout>		Sets the Radius hotspot server accounting timeout period in seconds (1-25).
	acct-retry	<idx>	<retry_count>		Sets the Radius hotspot server accounting accounting retry interval (1-10).

Example:

```

admin(network.wireless.wlan.hotspot.radius)>set server 1 primary 157.235.121.1
admin(network.wireless.wlan.hotspot.radius)>set port 1 primary 1812
admin(network.wireless.wlan.hotspot.radius)>set secret 1 primary sjsharkey
admin(network.wireless.wlan.hotspot.radius)>set acct-mode 1 enable
admin(network.wireless.wlan.hotspot.radius)>set acct-server 1 157.235.14.14
admin(network.wireless.wlan.hotspot.radius)>set acct-port 1 1812
admin(network.wireless.wlan.hotspot.radius)>set acct-secret londonfog
admin(network.wireless.wlan.hotspot.radius)>set acct-timeout 1 25
admin(network.wireless.wlan.hotspot.radius)>set acct-retry 1 10

```

For information on configuring the Hotspot options available to the AP-5131 using the applet (GUI), see [Configuring WLAN Hotspot Support on page 5-40](#).

AP5131>admin(network.wireless.wlan.hotspot.radius)> show**Description:**

Shows Radius hotspot server details.

Syntax:

show radius <idx> Displays Radius hotspot server details per index (1-16)

Example:

```
admin(network.wireless.wlan.hotspot.radius)>show radius 1
```

```
Primary Server Ip adr      : 157.235.12.12
Primary Server Port       : 1812
Primary Server Secret     : *****
Secondary Server Ip adr   : 0.0.0.0
Secondary Server Port     : 1812
Primary Server Secret     : *****
Accounting Mode           : enable
Accounting Server Ip adr  : 157.235.15.16
Accounting Server Port    : 1812
Accounting Server Secret  : *****
Accounting Timeout       : 10
Accounting Retry-count    : 3
```

For information on configuring the Hotspot options available to the AP-5131 using the applet (GUI), see [Configuring WLAN Hotspot Support on page 5-40](#).

AP5131>admin(network.wireless.wlan.hotspot)> white-list**Description:**

Goes to the hotspot white-list menu.

Syntax:

white-list	add	<rule>	Adds hotspot whitelist rules by index (1-16) for specified IP address.
	clear		Clears hotspot whitelist rules for specified index (1-16).
	show		Shows hotspot whitelist rules for specified index (1-16).
	save		Saves the updated hotspot configuration to flash memory.
	quit		Quits the CLI session.
	..		Goes to the parent menu.
	/		Goes to the root menu.

Example:

```
admin(network.wireless.wlan.hotspot.whitelist)>add rule 1 157.235.21.21
admin(network.wireless.wlan.hotspot.whitelist)>show white-rule 1
```

```
-----
Idx                IP Address
-----
1                   157.235.21.21
```

For information on configuring the Hotspot options available to the AP-5131 using the applet (GUI), see [Configuring WLAN Hotspot Support on page 5-40](#).

8.3.3.2 Network Security Commands

AP5131>admin(network.wireless.security)>

Description:

Displays the AP-5131 wireless security submenu. The items available under this command include:

show	Displays the AP-5131's current security configuration.
create	Defines the parameters of a security policy.
edit	Edits the properties of an existing security policy.
delete	Removes a specific security policy.
..	Goes to the parent menu.
/	Goes to the root menu.
save	Saves the configuration to system flash.
quit	Quits the CLI.

For information the security configuration options available to the AP-5131 using the applet (GUI), see [Configuring Security Options on page 6-2](#).

AP5131>admin(network.wireless.security)> create

Description:

Defines the parameter of AP-5131 security policies.

Syntax:

create				Defines the parameters of a security policy.
show				Displays new or existing security policy parameters.
set	sec-name	<name>		Sets the name of the security policy.
	auth	<authtype>		Sets the authentication type for WLAN <idx> to <type> (none , eap , or kerberos).
				<i>Note: Kerberos parameters are only in affect if "kerberos" is specified for the authentication method (set auth <type>).</i>
	kerb	realm	<name>	Sets the Kerberos realm.
		server	<sidx> <ip>	Sets the Kerberos server <sidx> (1 -primary, 2 -backup, or 3 -remote) to KDC IP address.
		port	<sidx> <port>	Sets the Kerberos port to <port> (KDC port) for server <ksidx> (1 -primary, 2 -backup, or 3 -remote).
				<i>Note: EAP parameters are only in affect if "eap" is specified for the authentication method (set auth <type>).</i>
	eap	server	<sidx> <ip>	Sets the radius server (1 -primary or as 2 -secondary) IP address <ip>.
		port	<sidx> <port>	Sets the radius server <sidx> (1 -primary or 2 -secondary) <port> (1-65535).
		secret	<sidx> <secret>	Sets the EAP shared secret <secret> (1-63 characters) for server <sidx> (1 -primary or 2 -secondary).
	reauth	mode	<mode>	Enables or disables EAP reauthentication.
		period	<time>	Sets the reauthentication period <period> in seconds (30-9999).

	retry	<number>	Sets the maximum number of reauthentication retries <retry> (1-99) .
accounting	mode	<mode>	Enable or disable Radius accounting.
	server	<ip>	Set external Radius server IP address.
	port	<port>	Set external Radius server port number.
	secret	<secret>	Set external Radius server shared secret password.
	timeout	<period>	Defines MU timeout period in seconds (1-255).
	retry	<number>	Sets the maximum number of MU retries to <retry> (1-10) .
	syslog	<mode>	Enable or disable syslog messages.
	ip	<ip>	Defines syslog server IP address.
adv	mu-quiet	<time>	Set the EAP MU/supplicant quiet period to <time> seconds (1-65535) .
	mu-timeout	<timeout>	Sets the EAP MU/supplicant timeout in seconds (1-255) .
	mu-tx	<time>	Sets the EAP MU/supplicant TX period <time> in seconds (1-65535) .
	mu-retry	<count>	Sets the EAP maximum number of MU retries to <count> (1-10) .
	svr-timeout	<time>	Sets the server timeout <time> in seconds (1-255) .
	svr-retry	<count>	Sets the maximum number of server retries to <count> (1-255) .
 <i>Note: The WEP authentication mechanism saves up to four different keys (one for each WLAN). It is not requirement to set all keys, but you must associate a WLAN with the same keys.</i>			
enc	<idx>	<type>	Sets the encryption type to <type> (one of none , wep40 , wep104 , keyguard , tkip , or ccmp) for WLAN <idx>.

wep-keyguard	passkey	<passkey>		The passkey used as a text abbreviation for the entire key length (4-32).
	index	<key index>		Selects the WEP/KeyGuard key (from one of the four potential values of <key index> (1-4).
	hex-key	<kidx>	<key string>	Sets the WEP/KeyGuard key for key index <kidx> (1-4) for WLAN <kidx> to <key string>.
	ascii-key	<kidx>	<key string>	Sets the WEP/KeyGuard key for key index <kidx> (1-4) for WLAN <kidx> to <key string>.
<i>Note: TKIP parameters are only affected if "tkip" is selected as the encryption type.</i>				
tkip	rotate-mode	<mode>		Enables or disabled the broadcast key.
	interval	<time>		Sets the broadcast key rotation interval to <time> in seconds (300-604800).
	type	<key type>		Sets the TKIP key type.
	key	<256 bit key>		Sets the TKIP key to <256 bit key>.
	phrase	<ascii phrase>		Sets the TKIP ASCII pass phrase to <ascii phrase> (8-63 characters).
ccmp	rotate-mode	<mode>		Enables or disabled the broadcast key.
	interval	<time>		Sets the broadcast key rotation interval to <time> in seconds (300-604800).
	type	<key type>		Sets the CCMP key type.
	phrase	<ascii phrase>		Sets the CCMP ASCII pass phrase to <ascii phrase> (8-63 characters).
	key	<256 bit key>		Sets the CCMP key to <256 bit key>.
	mixed-mode	<mode>		Enables or disables mixed mode (allowing WPA-TKIP clients).

preauth	<mode>	Enables or disables preauthentication (fast roaming).
add-policy		Adds the policy and exits.
..		Disregards the policy creation and exits the CLI session.

For information on configuring the encryption and authentication options available to the AP-5131 using the applet (GUI), see [Configuring Security Options on page 6-2](#).

AP5131>admin(network.wireless.security.edit)>**Description:**

Edits the properties of a specific security policy.

Syntax:

show	Displays the new or modified security policy parameters.
set <index>	Edits security policy parameters.
change	Completes policy changes and exits the session.
..	Cancel the changes made and exits the session.

Example:

```
admin(network.wireless.security)>edit 1
admin(network.wireless.security.edit)>show
```

```
Policy Name           : Default
Authentication        : Manual Pre-shared key/No Authentication

Encryption type       : no encryption
```

For information on configuring the encryption and authentication options available to the AP-5131 using the applet (GUI), see [Configuring Security Options on page 6-2](#).

AP5131>admin(network.wireless.security)> delete**Description:**

Deletes a specific security policy.

Syntax:

delete	<sec-name>	Removes the specified security policy for the list supported.
	<all>	Removes all security policies except the default policy.

For information on configuring the encryption and authentication options available to the AP-5131 using the applet (GUI), see [Configuring Security Options on page 6-2](#).

8.3.3.3 Network ACL Commands

AP5131>admin(network.wireless.acl)>

Description:

Displays the AP-5131 Mobile Unit *Access Control List* (ACL) submenu. The items available under this command include:

show	Displays the AP-5131's current ACL configuration.
create	Creates an MU ACL policy.
edit	Edits the properties of an existing MU ACL policy.
delete	Removes an MU ACL policy.
..	Goes to the parent menu.
/	Goes to the root menu.
save	Saves the configuration to system flash.
quit	Quits the CLI.

AP5131>admin(network.wireless.acl)> show**Description:**

Displays the AP-5131's current ACL configuration.

Syntax:

show **summary** Displays the list of existing MU ACL policies.
 policy <index> Displays the requested MU ACL index policy.

Example:

```
admin(network.wireless.acl)>show summary
```

```
-----
ACL Policy Name                      Associated WLANs
-----
1 Default                              Front Lobby
2 Admin                                 Administration
3 Demo Room                            Customers
```

```
admin(network.wireless.acl)>show policy 1
```

```
Policy Name                            : Front Lobby
Policy Mode                            : allow
```

```
-----
index                                  start mac                              end mac
-----
1                                        00A0F8348787                          00A0F8348798
```

For information on configuring the ACL options available to the AP-5131 using the applet (GUI), see [Configuring a WLAN Access Control List \(ACL\) on page 5-31](#).

AP5131>admin(network.wireless.acl)> create**Description:**

Creates an MU ACL policy.

Syntax:

create	show		<acl-name>	Displays the parameters of a new ACL policy.
	set	acl-name	<index>	Sets the MU ACL policy name.
		mode	<acl-mode>	Sets the ACL mode for the defined index (1-16). Allowed MUs can access the AP-5131 managed LAN. Options are deny and allow .
	add-addr		<mac1> or <mac1> <mac2>	Adds specified MAC address to list of ACL MAC addresses.
	delete		<index>	Removes either a specified ACL index or all ACL entries.
	add-policy		<all>	Completes the policy creation and exits the CLI.
	..			Cancels the creation of the ACL and exits the CLI.

Example:

```
admin(network.wireless.acl.create)>show
```

```
Policy Name           : Front Lobby
Policy Mode           : allow
```

```
-----
index                start mac                end mac
-----
1                    00A0F8334455            00A0F8334455
2                    00A0F8400000            00A0F8402001
```

```
admin(network.wireless.acl.create)>set acl-name engineering
admin(network.wireless.acl.create)>set mode deny
admin(network.wireless.acl.create)>add-addr 00A0F843AABB
admin(network.wireless.acl.create)>add-policy
```

For information on configuring the ACL options available to the AP-5131 using the applet (GUI), see [Configuring a WLAN Access Control List \(ACL\) on page 5-31](#).

AP5131>admin(network.wireless.acl.edit)>**Description:**

Edits the properties of an existing MU ACL policy.

Syntax:

show	Displays MU ACL policy and its parameters.
set	Modifies the properties of an existing MU ACL policy.
add-addr	Adds an MU ACL table entry.
delete	Deletes an MU ACL table entry, including starting and ending MAC address ranges.
change	Completes the changes made and exits the session.
..	Cancels the changes made and exits the session.

For information on configuring the ACL options available to the AP-5131 using the applet (GUI), see [Configuring a WLAN Access Control List \(ACL\) on page 5-31](#).

AP5131>admin(network.wireless.acl)> delete

Description:

Removes an MU ACL policy.

Syntax:

delete	<acl name>	Deletes a particular MU ACL policy.
	all	Deletes all MU ACL policies.

For information on configuring the ACL options available to the AP-5131 using the applet (GUI), see [Configuring a WLAN Access Control List \(ACL\) on page 5-31](#).

8.3.3.4 Network Radio Configuration Commands

AP5131>admin(network.wireless.radio)>

Description:

Displays the AP-5131 Radio submenu. The items available under this command include:

.	Summarizes AP-5131 radio parameters at a high-level.
show	Summarizes AP-5131 radio parameters at a high-level.
set	Defines the AP-5131 radio configuration.
radio1	Displays the 802.11b/g radio submenu.
radio2	Displays the 802.11a radio submenu.
..	Goes to the parent menu.
/	Goes to the root menu.
save	Saves the configuration to system flash.
quit	Quits the CLI.

AP5131>admin(network.wireless.radio)> show**Description:**

Displays the AP-5131's current radio configuration.

Syntax:

show Displays the AP-5131's current radio configuration.

Example:

```
admin(network.wireless.radio)>show
```

Radio Configuration**Radio 1**

```
Name : Radio 1
Radio Mode : enable
RF Band of Operation : 802.11b/g (2.4 GHz)
```

Wireless AP Configuration:

```
Base Bridge Mode : enable
Max Wireless AP Clients : 6
Client Bridge Mode : disable
Clitn Bridge WLAN : WLAN1
```

Radio 2

```
Name : Radio 2
Radio Mode : enable
RF Band of Operation : 802.11a (5 GHz)
```

Wireless AP Configuration:

```
Base Bridge Mode : enable
Max Wireless AP Clients : 5
Client Bridge Mode : disable
Client Bridge WLAN : WLAN1
```

For information on configuring the Radio Configuration options available to the AP-5131 using the applet (GUI), see [Setting the WLAN's Radio Configuration on page 5-45](#).

AP5131>admin(network.wireless.radio)> set**Description:**

Enables an AP-5131 Radio and defines the RF band of operation.

Syntax:

set 11a	<mode>	Enables or disables the AP-5131's 802.11a radio.
11bg	<mode>	Enables or disables the AP-5131's 802.11b/g radio.
mesh-base	<mode>	Enables or disables base bridge mode.
mesh-max		Sets the maximum number of wireless bridge clients.
mesh-client	<mode>	Enables or Disables client bridge mode.
mesh-wlan	<name>	Defines the client bridge WLAN name.

Example:

```
admin(network.wireless.radio)>set 11a disable
admin(network.wireless.radio)>set 11bg enable
admin(network.wireless.radio)>set mesh-base enable
admin(network.wireless.radio)>set mesh-max 11
admin(network.wireless.radio)>set mesh-client disable
admin(network.wireless.radio)>set mesh-wlan wlan1
admin(network.wireless.radio)>show
```

Radio Configuration**Radio 1**

```
Name : Radio 1
Radio Mode : enable
RF Band of Operation : 802.11b/g (2.4 GHz)
```

Wireless AP Configuration:

```
Base Bridge Mode : enable
Max Wireless AP Clients : 11
Client Bridge Mode : disable
Clitn Bridge WLAN : WLAN1
```

For information on configuring the Radio Configuration options available to the AP-5131 using the applet (GUI), see [Setting the WLAN's Radio Configuration on page 5-45](#).

AP5131>admin(network.wireless.radio.radio1)>

Description:

Displays a specific 802.11b/g radio submenu. The items available under this command include:

Syntax:

show	Displays 802.11b/g radio settings.
set	Defines specific 802.11b/g radio parameters.
advanced	Displays the Advanced radio settings submenu.
mesh	Goes to the Wireless AP Connections submenu.
..	Goes to the parent menu.
/	Goes to the root menu.
save	Saves the configuration to system flash.
quit	Quits the CLI.

For information on configuring Radio 1 Configuration options available to the AP-5131 using the applet (GUI), see [Setting the WLAN's Radio Configuration on page 5-45](#).

AP5131>admin(network.wireless.radio.radio1)> show**Description:**

Displays specific 802.11b/g radio settings.

Syntax:

show	radio	Displays specific 802.11b/g radio settings.
	qos	Displays specific 802.11b/g radio WMM QoS settings.

Example:

```
admin(network.wireless.radio.radio1)>show radio
```

Radio Setting Information

```

Placement                : indoor
MAC Address               : 00A0F8715920
Radio Type                : 802.11b/g
ERP Protection            : Off

Channel Setting           : user selection
Antenna Diversity         : full
Power Level               : 5 dbm (4 mW)

802.11b/g mode           : B-Only
Basic Rates               : 1 2 5.5 11
Supported Rates           : 1 2 5.5 11

Beacon Interval           : 100 K-usec
DTIM Interval per BSSID
    1                     : 10 beacon intvls
    2                     : 10 beacon intvls
    3                     : 10 beacon intvls
    4                     : 10 beacon intvls

short preamble            : disable
RTS Threshold             : 2341 bytes

```

```
admin(network.wireless.radio.radiol1)>show qos
```

Radio QOS Parameter Set		11g-default			
Access Category	CWMin	CWMax	AIFSN	TXOPs (32 usec)	TXOPs ms
Background	15	1023	7	0	0.000
Best Effort	15	63	3	31	0.992
Video	7	15	1	94	3.008
Voice	3	7	1	47	1.504

For information on configuring the Radio 1 Configuration options available to the AP-5131 using the applet (GUI), see [Configuring the 802.11a or 802.11b/g Radio on page 5-48](#).

AP5131>admin(network.wireless.radio.802-11bg)> set**Description:**

Defines specific 802.11b/g radio parameters.

Syntax:

set	placement	Defines the AP-5131 radio placement as indoors or outdoors.
	ch-mode	Determines how the radio channel is selected.
	channel	Defines the actual channel used by the radio.
	antenna	Sets the radio antenna power
	power	Defines the radio antenna power transmit level.
	bg-mode	Enables or disables 802-11bg radio mode support.
	rates	Sets the supported radio transmit rates.
	beacon	Sets the beacon interval used by the radio.
	dtim	Defines the DTIM interval (by index) used by the radio.
	preamble	Enables or disables support for short preamble for the radio.
	rts	Defines the RTS Threshold value for the radio.
	qos	Defines the cwmin, cwmax, aifsn and txops levels for the QoS policy used for the radio.
	qos param-set	Defines the data type proliferating the mesh network. When set to a value other than manual, editing the access category values is not necessary. Options include; 11g-default, 11b-default, 11g-wifi, 11b-wifi, 11g-voice, 11b-voice or manual (for advanced users).

Example:

```
admin(network.wireless.radio.802-11bg)>set placement indoor
admin(network.wireless.radio.802-11bg)>set ch-mode user
admin(network.wireless.radio.802-11bg)>set channel 1
admin(network.wireless.radio.802-11bg)>set antenna full
admin(network.wireless.radio.802-11bg)>set power 4
admin(network.wireless.radio.802-11bg)>set bg-mode enable
admin(network.wireless.radio.802-11bg)>set rates
admin(network.wireless.radio.802-11bg)>set beacon 100
admin(network.wireless.radio.802-11bg)>set dtim 1 40
admin(network.wireless.radio.802-11bg)>set preamble disable
admin(network.wireless.radio.802-11bg)>set rts 2341
admin(network.wireless.radio.802-11bg)>set qos cwmin 125
admin(network.wireless.radio.802-11bg)>set qos cwmax 255
admin(network.wireless.radio.802-11bg)>set qos aifsn 7
admin(network.wireless.radio.802-11bg)>set qos txops 0
admin(network.wireless.radio.802-11bg)>set qos param-set 11g-default
```

For information on configuring the Radio 1 Configuration options available to the AP-5131 using the applet (GUI), see [Configuring the 802.11a or 802.11b/g Radio on page 5-48](#).

AP5131>admin(network.wireless.radio.802-11bg.advanced)>

Description:

Displays the advanced submenu for the 802.11b/g radio. The items available under this command include:

Syntax:

show	Displays advanced radio settings for the 802.11b/g radio.
set	Defines advanced parameters for the 802.11b/g radio.
..	Goes to the parent menu.
/	Goes to the root menu.
save	Saves the configuration to system flash.
quit	Quits the CLI.

AP5131>admin(network.wireless.radio.802-11bg.advanced)> show**Description:**

Displays the BSSID to WLAN mapping for the 802.11b/g radio.

Syntax:

show **advanced** Displays advanced settings for the 802.11b/g radio.
wlan Displays WLAN summary list for the 802.11b/g radio.

Example:

```
admin(network.wireless.radio.802-11bg.advanced)>show advanced
```

WLAN	BSS ID	BC/MC Cipher	Status	Message
Lobby	1	Open	good	configuration is ok
HR	2	Open	good	configuration is ok
Office	3	Open	good	configuration is ok

BSSID	Primary WLAN
1	Lobby
2	HR
3	Office

```
admin(network.wireless.radio.802-11bg.advanced)>show wlan
```

```
WLAN 1:
WLAN name           : WLAN1
ESS ID              : 101
Radio               : 11a,11b/g
VLAN                :
Security Policy     : Default
QoS Policy          : Default
```

For information on configuring Radio 1 Configuration options available to the AP-5131 using the applet (GUI), see [Configuring the 802.11a or 802.11b/g Radio on page 5-48](#).

AP5131>admin(network.wireless.radio.802-11bg.advanced)> set**Description:**

Defines advanced parameters for the target 802.11b/g radio.

Syntax:

set wlan	<wlan-name>	<bssid>	Defines advanced WLAN to BSSID mapping for the target radio.
bss	<bss-id>	<wlan name>	Sets the BSSID to primary WLAN definition.

Example:

```
admin(network.wireless.radio.802-11bg.advanced)>set wlan demoroom 1
admin(network.wireless.radio.802-11bg.advanced)>set bss 1 demoroom
```

For information on configuring Radio 1 Configuration options available to the AP-5131 using the applet (GUI), see [Configuring the 802.11a or 802.11b/g Radio on page 5-48](#).

AP5131>admin(network.wireless.radio.radio2)>**Description:**

Displays a specific 802.11a radio submenu. The items available under this command include:

Syntax:

show	Displays 802.11a radio settings
set	Defines specific 802.11a radio parameters.
advanced	Displays the Advanced radio settings submenu.
mesh	Goes to the Wireless AP Connections submenu.
..	Goes to the parent menu.
/	Goes to the root menu.
save	Saves the configuration to system flash.
quit	Quits the CLI.

AP5131>admin(network.wireless.radio.802-11a)> show**Description:**

Displays specific 802.11a radio settings.

Syntax:

show	radio	Displays specific 802.11a radio settings.
	qos	Displays specific 802.11a radio WMM QoS settings.

Example:

```
admin(network.wireless.radio.802-11a)>show radio
```

Radio Setting Information

```

Placement                : indoor
MAC Address               : 00A0F8715920
Radio Type                : 802.11a

Channel Setting           : user selection
Antenna Diversity         : full
Power Level               : 5 dbm (4 mW)

Basic Rates               : 6 12 24
Supported Rates           : 6 9 12 18 24 36 48 54

Beacon Interval           : 100 K-usec
DTIM Interval per BSSID
    1                     : 10 beacon intvls
    2                     : 10 beacon intvls
    3                     : 10 beacon intvls
    4                     : 10 beacon intvls

RTS Threshold             : 2341 bytes

```

```
admin(network.wireless.radio.802-11a)>show qos
```

```
Radio QOS Parameter Set:          11a default
```

```
-----  
Access Category    CWMin    CWMax    AIFSN    TXOPs (32 sec)  TXOPs ms  
-----  
Background         15       1023     7         0                0.000  
Best Effort        15        63       3         31               0.992  
Video              7         15       1         94               3.008  
Voice              3         7        1         47               1.504
```

For information on configuring Radio 2 Configuration options available to the AP-5131 using the applet (GUI), see [Configuring the 802.11a or 802.11b/g Radio on page 5-48](#).

AP5131>admin(network.wireless.radio.802-11a)> set**Description:**

Defines specific 802.11a radio parameters.

Syntax:

set	placement	Defines the AP-5131 radio placement as indoors or outdoors.
	ch-mode	Determines how the radio channel is selected.
	channel	Defines the actual channel used by the radio.
	antenna	Sets the radio antenna power.
	power	Defines the radio antenna power transmit level.
	rates	Sets the supported radio transmit rates.
	beacon	Sets the beacon interval used by the radio.
	dtim	Defines the DTIM interval (by index) used by the radio.
	rts	Defines the RTS Threshold value for the radio.
	qos	Defines the cwmin, cwmax, aifsn and txops levels for the QoS policy used for the radio.
	qos param-set	Defines the data type proliferating the WLAN used with the mesh network. When set to a value other than manual, editing the access category values is not necessary. Options include; 11g-default, 11b-default, 11g-wifi, 11b-wifi, 11g-voice, 11b-voice or manual (for advanced users).

Example:

```

admin(network.wireless.radio.802-11a)>

admin(network.wireless.radio.802-11a)>set placement indoor
admin(network.wireless.radio.802-11a)>set ch-mode user
admin(network.wireless.radio.802-11a)>set channel 1
admin(network.wireless.radio.802-11a)>set antenna full
admin(network.wireless.radio.802-11a)>set power 4
admin(network.wireless.radio.802-11a)>set rates
admin(network.wireless.radio.802-11a)>set beacon 100
admin(network.wireless.radio.802-11a)>set dtim 1 10
admin(network.wireless.radio.802-11a)>set rts 2341
admin(network.wireless.radio.802-11a)>set qos cwmin 125
admin(network.wireless.radio.802-11a)>set qos cwmax 255
admin(network.wireless.radio.802-11a)>set qos aifsn 7
admin(network.wireless.radio.802-11a)>set qos txops 0
admin(network.wireless.radio.802-11b)>set qos param-set 11a-default

```

For information on configuring the Radio 2 Configuration options available to the AP-5131 using the applet (GUI), see [Configuring the 802.11a or 802.11b/g Radio on page 5-48](#).

AP5131>admin(network.wireless.radio.802-11a.advanced)>**Description:**

Displays the advanced submenu for the 802-11a radio. The items available under this command include:

Syntax:

show	Displays advanced radio settings for the 802-11a radio.
set	Defines advanced parameters for the 802-11a radio.
..	Goes to the parent menu.
/	Goes to the root menu.
save	Saves the configuration to system flash.
quit	Quits the CLI.

AP5131>admin(network.wireless.radio.802-11a.advanced)> show**Description:**

Displays the BSSID to WLAN mapping for the 802.11a radio.

Syntax:

show **advanced** Displays advanced settings for the 802.11a radio.
 wlan Displays WLAN summary list for 802.11a radio.

Example:

```
admin(network.wireless.radio.802-11a.advanced)>show advanced
```

```
-----
      WLAN          BSS ID      BC/MC Cipher      Status      Message
-----
      Lobby         1           Open              good        configuration is ok
      HR            2           Open              good        configuration is ok
      Office        3           Open              good        configuration is ok
-----
```

```
-----
      BSSID         Primary WLAN
-----
      1             Lobby
      2             HR
      3             Office
-----
```

```
admin(network.wireless.radio.802-11bg.advanced)>show wlan
```

```
WLAN 1:
WLAN name           : WLAN1
ESS ID              : 101
Radio               :
VLAN                :
Security Policy     : Default
QoS Policy          : Default
```

For information on configuring the Radio 2 Configuration options available to the AP-5131 using the applet (GUI), see [Configuring the 802.11a or 802.11b/g Radio on page 5-48](#).

AP5131>admin(network.wireless.radio.802-11a.advanced)> set**Description:**

Defines advanced parameters for the target 802..11a radio.

Syntax:

set wlan	<wlan-name>	<bssid>	Defines advanced WLAN to BSSID mapping for the target radio.
bss	<bss-id>	<wlan name>	Sets the BSSID to primary WLAN definition.

Example:

```
admin(network.wireless.radio.802-11a.advanced)>set wlan demoroom 1
admin(network.wireless.radio.802-11a.advanced)>set bss 1 demoroom
```

For information on configuring Radio 2 Configuration options available to the AP-5131 using the applet (GUI), see [Configuring the 802.11a or 802.11b/g Radio on page 5-48](#).

8.3.3.5 Network Quality of Service (QoS) Commands

AP5131>admin(network.wireless.qos)>

Description:

Displays the AP-5131 *Quality of Service* (QoS) submenu. The items available under this command include:

.	
show	Displays AP-5131 QoS policy information.
create	Defines the parameters of the QoS policy.
edit	Edits the settings of an existing QoS policy.
delete	Removes an existing QoS policy.
..	Goes to the parent menu.
/	Goes to the root menu.
save	Saves the configuration to system flash.
quit	Quits the CLI.

AP5131>admin(network.wireless.qos)> show**Description:**

Displays the AP-5131's current QoS policy by summary or individual policy.

Syntax:

show **summary** Displays all existing QoS policies that have been defined.
 policy <index> Displays the configuration for the requested QoS policy.

Example:

```
admin(network.wireless.qos)>show summary
```

```
-----
QOS Policy Name                      Associated WLANs
-----
1 Default                              101
2 IP Phones                            Audio Dept
3 Video                                Vidio Dept
```

```
admin(network.wireless.qos)>show policy 1
```

```
Policy Name                            IP Phones
Support Legacy Voice Mode            disable
Multicast (Mask) Address 1            01005E000000
Multicast (Mask) Address 2            09000E000000
WMM QOS Mode                          disable
```

For information on configuring the WLAN QoS options available to the AP-5131 using the applet (GUI), see [Setting the WLAN Quality of Service \(QoS\) Policy on page 5-34](#).

AP5131>admin(network.wireless.qos.create)>**Description:**

Defines an AP-5131 QoS policy.

Syntax:

show			Displays QoS policy parameters.
set	qos-name <index>		Sets the QoS name for the specified index entry.
	vop <index>		Enables or disables support (by index) for legacy VOIP devices.
	mcast <mac>		Defines primary and secondary Multicast MAC address.
	wmm-qos <index>		Enables or disables the QoS policy index specified.
	param-set <set-name>		Defines the data type used with the qos policy and mesh network. When set to a value other than manual, editing the access category values is not necessary. Options include; 11g-default, 11b-default, 11g-wifi, 11b-wifi, 11g-voice, 11b-voice or manual for advanced users).
	cwmin <access category>	<index>	Defines Minimum Contention Window (CW-Min) for specified access category and index.
	cwmax <access category>	<index>	Defines Maximum Contention Window (CW-Max) for specified access category and index.
	aifsn <access category>	<index>	Sets Arbitrary Inter-Frame Space Number (AIFSN) for specified access category and index.
	txops <access category>	<index>	Configures Opportunity to Transmit Time (TXOPs Time) for specified access category and index.
	default	<index>	Defines CWMIN, CWMAX, AIFSN and TXOPs default values.
add-policy			Completes the policy edit and exits the session.
..			Cancels the changes and exits.

For information on configuring the WLAN QoS options available to the AP-5131 using the applet (GUI), see [Setting the WLAN Quality of Service \(QoS\) Policy on page 5-34](#).

AP5131>admin(network.wireless.qos.edit)>**Descripton:**

Edits the properties of an existing QoS policy.

Syntax:

show			Displays QoS policy parameters.
set	qos-name	<index>	Sets the QoS name for the specified index entry.
	vop	<index>	Enables or disables support (by index) for legacy VOIP devices.
	mcast	<mac>	Defines primary and secondary Multicast MAC address.
	wmm-qos	<index>	Enables or disables the QoS policy index specified.
	param-set	<set-name>	Defines the data type used with the qos policy and mesh network. When set to a value other than manual, editing the access category values is not necessary. Options include; 11g-default, 11b-default, 11g-wifi, 11b-wifi, 11g-voice, 11b-voice or manual for advanced users).
	cwmin	<access category> <index>	Defines Minimum Contention Window (CW-Min) for specified access category and index.
	cwmax	<access category> <index>	Defines Maximum Contention Window (CW-Max) for specified access category and index.
	aifsn	<access category> <index>	Sets Arbitrary Inter-Frame Space Number (AIFSN) for specified access category and index.
	txops	<access category> <index>	Configures Opportunity to Transmit Time (TXOPs Time) for specified access category and index.
	default	<index>	Defines CWMIN, CWMAX, AIFSN and TXOPs default values.
change			Completes the policy edit and exits the session.
..			Cancels the changes and exits.

For information on configuring the WLAN QoS options available to the AP-5131 using the applet (GUI), see [Setting the WLAN Quality of Service \(QoS\) Policy on page 5-34](#).

AP5131>admin(network.wireless.qos)> delete

Description:

Removes a QoS policy.

Syntax:

delete <qos-name> Deletes the specified QoS policy index, or all of the policies.
 <all>

For information on configuring the WLAN QoS options available to the AP-5131 using the applet (GUI), see [Setting the WLAN Quality of Service \(QoS\) Policy on page 5-34](#).

8.3.3.6 Network Bandwidth Management Commands

AP5131>admin(network.wireless.bandwidth)>

Description:

Displays the AP-5131 Bandwidth Management submenu. The items available under this command include:

.	Displays Bandwidth Management information for how data is processed by the AP-5131.
show	Displays Bandwidth Management information for how data is processed by the AP-5131.
set	Defines Bandwidth Management parameters for the AP-5131.
..	Goes to the parent menu.
/	Goes to the root menu.
save	Saves the configuration to system flash.
quit	Quits the CLI.

AP5131>admin(network.wireless.bandwidth)> show

Description:

Displays the AP-5131's current Bandwidth Management configuration.

Syntax:

show Displays the current Bandwidth Management configuration for defined WLANs and how they are weighted.

Example:

```
admin(network.wireless.bandwidth)>show
```

```
Bandwidth Share Mode          : First In First Out
```

For information on configuring the Bandwidth Management options available to the AP-5131 using the applet (GUI), see [Configuring Bandwidth Management Settings on page 5-55](#).

AP5131>admin(network.wireless.bandwidth)> set**Description:**

Defines the AP-5131 Bandwidth Management configuration.

Syntax:

set mode	<bw-mode>	Defines bandwidth share mode of First In First Out <fifo>, Round Robin <rr> or Weighted Round Robin <wrr>
weight	<num>	Assigns a bandwidth share allocation for the WLAN <index 1-16 > when Weighted Round Robin <wrr> is selected. The weighting is from 1-10.

For information on configuring the Bandwidth Management options available to the AP-5131 using the applet (GUI), see [Configuring Bandwidth Management Settings on page 5-55](#).

8.3.3.7 Network Rogue-AP Commands

AP5131>admin(network.wireless.rogue-ap)>

Description:

Displays the Rogue AP submenu. The items available under this command include:

.	
show	Displays the current AP-5131 Rogue AP detection configuration.
set	Defines the Rogue AP detection method.
mu-scan	Goes to the Rogue AP mu-uscan submenu.
allowed-list	Goes to the Rogue AP Allowed List submenu.
active-list	Goes the Rogue AP Active List submenu.
rogue-list	Goes the Rogue AP List submenu.
..	Goes to the parent menu.
/	Goes to the root menu.
save	Saves the configuration to system flash.
quit	Quits the CLI.

AP5131>admin(network.wireless.rogue-ap)> show**Description:**

Displays the current AP-5131 Rogue AP detection configuration.

Syntax:

show Displays the current AP-5131 Rogue AP detection configuration.

Example:

```
admin(network.wireless.rogue-ap)>show
```

```
MU Scan                : disable
MU Scan Interval       : 60 minutes
On-Channel              : disable
Detector Radio Scan    : enable

Auto Authorize Symbol APs : disable

Approved APs age out   : 0 minutes
Rogue APs age out      : 0 minutes
```

For information on configuring the Rogue AP options available to the AP-5131 using the applet (GUI), see [Configuring Rogue AP Detection on page 6-53](#).

AP5131>admin(network.wireless.rogue-ap)> set**Description:**

Defines the AP-5131 ACL rogue AP method.

Syntax:

set	mu-scan	<mode>	Enables or disables to permit MUs to scan for rogue APs.
	interval	<minutes>	Define an interval for associated MUs to beacon in attempting to locate rogue APs. Value not available unless mu-scan is enabled.
	on-channel	<mode>	Enables or disables on-channel detection.
	detector-scan	<mode>	Enables or disables AP detector scan (dual-radio model only).
	symbol-ap	<mode>	Enables or disables the Authorize Any AP with a Symbol MAC address option.
	applst-ageout	<minutes>	Sets the approved AP age out time.
	roglst-ageout	<minutes>	Sets the rogue AP age out time.

Example:

```
admin(network.wireless.rogue-ap)>
```

```
admin(network.wireless.rogue-ap)>set mu-scan enable
```

```
admin(network.wireless.rogue-ap)>set interval 10
```

```
admin(network.wireless.rogue-ap)>set on-channel disable
```

```
admin(network.wireless.rogue-ap)>set detector-scan disable
```

```
admin(network.wireless.rogue-ap)>set symbol-ap enable
```

```
admin(network.wireless.rogue-ap)>set applst-ageout 10
```

```
admin(network.wireless.rogue-ap)>set roglst-ageout 10
```

```
admin(network.wireless.rogue-ap)>show
```

```

MU Scan                : enable
MU Scan Interval       : 10 minutes
On Channel              : disable
Detector Radio Scan    : disable
Detector Radio Band    : none

Auto Authorize Symbol APs : enable

Approved AP age out   : 10 minutes
Rogue AP age out      : 10 minutes

```

For information on configuring the Rogue AP options available to the AP-5131 using the applet (GUI), see [Configuring Rogue AP Detection on page 6-53](#).

AP5131>admin(network.wireless.rogue-ap.mu-scan)>**Description:**

Displays the Rogue-AP mu-scan submenu.

Syntax:

show	Displays all APs located by the MU scan.
start	Initiates scan immediately by the MU.
..	Goes to the parent menu.
/	Goes to the root menu.
save	Saves the configuration to system flash.
quit	Quits the CLI.

AP5131>admin(network.wireless.rogue-ap.mu-scan)> start

Description:

Initiates an MU scan from a user provided MAC address.

Syntax:

start <mu-mac> Initiates MU scan from user provided MAC address.

For information on configuring the Rogue AP options available to the AP-5131 using the applet (GUI), see [Configuring Rogue AP Detection on page 6-53](#).

AP5131>admin(network.wireless.rogue-ap.mu-scan)> show**Description:**

Displays the results of an MU scan.

Syntax:

show Displays all APs located by the MU scan.

For information on configuring the Rogue AP options available to the AP-5131 using the applet (GUI), see [Configuring Rogue AP Detection on page 6-53](#).

AP5131>admin(network.wireless.rogue-ap.allowed-list)>

Description:

Displays the Rogue-AP allowed-list submenu.

show	Displays the rogue AP allowed list
add	Adds an AP MAC address and ESSID to the allowed list.
delete	Deletes an entry or all entries from the allowed list.
..	Goes to the parent menu.
/	Goes to the root menu.
save	Saves the configuration to system flash.
quit	Quits the CLI.

AP5131>admin(network.wireless.rogue-ap.allowed-list)> show**Description:**

Displays the Rogue AP allowed List.

Syntax:

show Displays the rogue-AP allowed list.

Example:

```
admin(network.wireless.rogue-ap.allowed-list)>show
```

```
-----  
index          ap                essid  
-----  
1              00:A0:F8:71:59:20  *  
2              00:A0:F8:33:44:55  101  
3              00:A0:F8:40:20:01  Marketing
```

For information on configuring the Rogue AP options available to the AP-5131 using the applet (GUI), see [Configuring Rogue AP Detection on page 6-53](#).

AP5131>admin(network.wireless.rogue-ap.allowed-list)> add**Description:**

Adds an AP MAC address and ESSID to existing allowed list.

Syntax:

add <mac-addr> Adds an AP MAC address and ESSID to existing allowed list.
 <ess-id> Use a "*" for any ESSID.

Example:

```
admin(network.wireless.rogue-ap.allowed-list)>add 00A0F83161BB 103
admin(network.wireless.rogue-ap.allowed-list)>show
```

```
-----
index          ap                essid
-----
1              00:A0:F8:71:59:20  *
2              00:A0:F8:33:44:55  101
3              00:A0:F8:40:20:01  Marketing
4              00:A0:F8:31:61:BB  103
```

For information on configuring the Rogue AP options available to the AP-5131 using the applet (GUI), see [Configuring Rogue AP Detection on page 6-53](#).

AP5131>admin(network.wireless.rogue-ap.allowed-list)> delete**Description:**

Deletes an AP MAC address and ESSID to existing allowed list.

Syntax:

delete <idx> Deletes an AP MAC address and ESSID (or all addresses) from the allowed list.
 <all>

For information on configuring the Rogue AP options available to the AP-5131 using the applet (GUI), see [Configuring Rogue AP Detection on page 6-53](#).

8.3.4 Network Firewall Commands

AP5131>admin(network.firewall)>

Description:

Displays the AP-5131 firewall submenu. The items available under this command include:

show	Displays the AP-5131's current firewall configuration.
set	Defines the AP-5131's firewall parameters.
access	Enables/disables firewall permissions through the LAN and WAN ports.
advanced	Displays interoperability rules between the LAN and WAN ports.
..	Goes to the parent menu.
/	Goes to the root menu.
save	Saves the configuration to system flash.
quit	Quits the CLI.

AP5131>admin(network.firewall)> show**Description:**

Displays the AP-5131 firewall parameters.

Syntax:

show Shows all AP-5131's firewall settings.

Example:

```
admin(network.firewall)>show
```

```
Firewall Status           : disable
NAT Timeout                : 10 minutes
```

Configurable Firewall Filters:

```
ftp bounce attack filter  : enable
syn flood attack filter   : enable
unaligned ip timestamp filter : enable
source routing attack filter : enable
winnuke attack filter     : enable
seq num prediction attack filter : enable
mime flood attack filter  : enable
max mime header length    : 8192 bytes
max mime headers          : 16 headers
```

For information on configuring the Firewall options available to the AP-5131 using the applet (GUI), see [Configuring Firewall Settings on page 6-25](#).

AP5131>admin(network.firewall)> set**Description:**

Defines the AP-5131 firewall parameters.

Syntax:

set mode	<mode>	Enables or disables the firewall.
nat-timeout	<interval>	Defines the NAT timeout value.
syn	<mode>	Enables or disables SYN flood attack check.
src	<mode>	Enables or disables source routing check.
win	<mode>	Enables or disables Winnuke attack check.
ftp	<mode>	Enables or disables FTP bounce attack check.
ip	<mode>	Enables or disables IP unaligned timestamp check.
seq	<mode>	Enables or disables sequence number prediction check.
mime	filter	Enables or disables MIME flood attack check.
len	<length>	Sets the max header length in bytes as specified by <length> (with value in range 256 - 34463).
hdr	<count>	Sets the max number of headers as specified in <count> (with value in range 12 - 34463).

Example:

```
admin(network.firewall)>set mode enable
admin(network.firewall)>set ftp enable
admin(network.firewall)>set ip enable
admin(network.firewall)>set seq enable
admin(network.firewall)>set src enable
admin(network.firewall)>set syn enable
admin(network.firewall)>set win enable
admin(network.firewall)>show
```

```
Firewall Status           : enable
Override LAN to WAN Access : disable
```

Configurable Firewall Filters

```
ftp bounce attack filter   : enable
syn flood attack filter    : enable
unaligned ip timestamp filter : enable
source routing attack filter : enable
winnuke attack filter      : enable
seq num prediction attack filter : enable
mime flood attack filter   : enable
max mime header length     : 8192
max mime headers           : 16
```

AP5131>admin(network.firewall)> access**Description:**

Enables or disables firewall permissions through LAN to WAN ports.

Syntax:

show	Displays LAN to WAN access rules.
set	Sets LAN to WAN access rules.
add	Adds LAN to WAN exception rules.
delete	Deletes LAN to WAN access exception rules.
list	Displays LAN to WAN access exception rules.
..	Goes to parent menu
/	Goes to root menu.
save	Saves configuration to system flash.
quit	Quits and exits the CLI session.

Example:

```
admin(network.firewall)>set override disable
admin(network.firewall)>access
admin(network.firewall.lan-wan-access)>set rule allow
admin(network.firewall.lan-wan-access)>list
```

index	from	to	name	prot	start port	end port
1	lan	wan	HTTP	tcp	80	80
2	lan	wan	abc	udp	0	0
3	lan	wan	123456	ah	1440	2048
4	lan	wan	654321	tcp	2048	2048
5	lan	wan	abc	ah	100	1000

For information on configuring the Firewall options available to the AP-5131 using the applet (GUI), see [Configuring Firewall Settings on page 6-25](#).

AP5131>admin(network.firewall)> advanced**Description:**

Displays whether an AP-5131 firewall rule is intended for inbound traffic to an interface or outbound traffic from that interface..

Syntax:

show	Shows advanced subnet access parameters.
set	Sets advanced subnet access parameters.
import	Imports rules from subnet access.
inbound	Goes to the Inbound Firewall Rules submenu.
outbound	Goes to the Outbound Firewall Rules submenu.
..	Goes to the parent menu.
/	Goes to the root menu.
save	Saves the configuration to flash memory.
quit	Quits and exits the CLI session.

Example:

```
admin(network.firewall)>set override enable
admin(network.firewall)>advanced
admin(network.firewall.adv-lan-access)>inbound
admin(network.firewall.adv-lan-access.inb)>list
```

```
-----
Idx  SCR IP-Netmask  Dst IP-Netmask  TP  SPorts  DPorts  Rev  NAT  Action
-----
1    1.2.3.4      2.2.2.2        all 1:        1:        0.0.0.0  deny
      255.0.0.0    255.0.0.0      tcp 65535     65535     nat port 33
2    33.3.0.0     10.10.1.1      tcp 1:        1:        11.11.1.0 allow
      255.255.255.0 255.255.255.0 65535     65535     nat port 0
```

For information on configuring the Firewall options available to the AP-5131 using the applet (GUI), see [Configuring Firewall Settings on page 6-25](#).

8.3.5 Network Router Commands

AP5131>admin(network.router)>

Description:

Displays the router submenu. The items available under this command are:

show	Displays the existing AP-5131 router configuration.
set	Sets the RIP parameters.
add	Adds user-defined routes.
delete	Deletes user-defined routes.
list	Lists user-defined routes.
..	Goes to the parent menu.
/	Goes to the root menu.
save	Saves the configuration to system flash.
quit	Quits the CLI.

AP5131>admin(network.router)> show**Description:**

Shows the AP-5131 route table.

Syntax:

show Shows the AP-5131 route table.

Example:

```
admin(network.router)>show routes
```

index	destination	netmask	gateway	interface	metric
1	192.168.2.0	255.255.255.0	0.0.0.0	lan1	0
2	192.168.1.0	255.255.255.0	0.0.0.0	lan2	0
3	192.168.0.0	255.255.255.0	0.0.0.0	lan1	0
4	192.168.24.0	255.255.255.0	0.0.0.0	wan	0
5	157.235.19.5	255.255.255.0	192.168.24.1	wan	1

For information on configuring the Router options available to the AP-5131 using the applet (GUI), see [Configuring Router Settings on page 5-57](#).

AP5131>admin(network.router)> set**Description:**

Shows the AP-5131 route table.

Syntax:

set	auth	Sets the RIP authentication type.
	dir	Sets RIP direction.
	id	Sets MD5 authentication ID.
	key	Sets MD5 authentication key.
	passwd	Sets the password for simple authentication.
	type	Defines the RIP type.
	dgw-iface	Sets the default gateway interface.

For information on configuring the Router options available to the AP-5131 using the applet (GUI), see [Configuring Router Settings on page 5-57](#).

AP5131>admin(network.router)> add**Description:**

Adds user-defined routes.

Syntax:

add <dest> <netmask> <gw> <iface> <metric> Adds a route with destination IP address <dest>, IP netmask <netmask>, destination gateway IP address <gw>, interface LAN1, LAN2 or WAN <iface>, and metric set to <metric> **(1-15)**.

Example:

```
admin(network.router)>add 192.168.3.0 255.255.255.0 192.168.2.1 LAN 1 1
```

```
admin(network.router)>list
```

```
-----
index  destination      netmask          gateway          interface        metric
-----
1      192.168.3.0     255.255.255.0   192.168.2.1     lan1             1
```

For information on configuring the Router options available to the AP-5131 using the applet (GUI), see [Configuring Router Settings on page 5-57](#).

AP5131>admin(network.router)> delete**Description:**

Deletes user-defined routes.

Syntax:

delete <idx> Deletes the user-defined route <idx> (1-20) from list.
all Deletes all user-defined routes.

Example:

```
admin(network.router)>list
-----
index  destination      netmask      gateway      interface     metric
-----
1      192.168.2.0      255.255.255.0  192.168.0.1  lan1          1
2      192.168.1.0      255.255.255.0  0.0.0.0      lan2          0
3      192.168.0.0      255.255.255.0  0.0.0.0      lan2          0

admin(network.router)>delete 2
admin(network.router)>list
-----
index  destination      netmask      gateway      interface     metric
-----
1      192.168.2.0      255.255.255.0  0.0.0.0      lan1          0
2      192.168.0.0      255.255.255.0  0.0.0.0      lan1          0

admin(network.router)>
```

For information on configuring the Router options available to the AP-5131 using the applet (GUI), see [Configuring Router Settings on page 5-57](#).

AP5131>admin(network.router)> list**Description:**

Lists user-defined routes.

Syntax:

list Displays a list of user-defined routes.

Example:

```
admin(network.router)>list
```

index	destination	netmask	gateway	interface	metric
1	192.168.2.0	255.255.255.0	192.168.0.1	lan1	1
2	192.168.1.0	255.255.255.0	0.0.0.0	lan2	0
3	192.168.0.0	255.255.255.0	0.0.0.0	lan1	0

For information on configuring the Router options available to the AP-5131 using the applet (GUI), see [Configuring Router Settings on page 5-57](#).

8.4 System Commands

AP5131>admin(system)>

Description:

Displays the System submenu. The items available under this command are shown below.

restart	Restarts the AP-5131.
show	Shows AP-5131 system parameter settings.
set	Defines AP-5131 system parameter settings.
debug	Accesses AP-5131 password-protected debug information.
lastpw	Displays last debug password.
exec	Goes to a Linux command menu.
access	Goes to the AP-5131 access submenu where AP-5131 access methods can be enabled.
cmgr	Goes the Certificate Manager submenu.
snmp	Goes to the SNMP submenu.
ntp	Goes to the Network Time Protocol submenu.
logs	Displays the log file submenu.
config	Goes to the configuration file update submenu.
fw-update	Goes to the firmware update submenu.
..	Goes to the parent menu.
/	Goes to the root menu.
save	Saves the configuration to system flash.
quit	Quits the CLI.

AP5131>admin(system)>restart**Description:**

Restarts the AP-5131 access point.

Syntax:

restart Restarts the AP-5131.

Example:

```
admin(system)>restart
```

```
*****WARNING*****
** Unsaved configuration changes will be lost when the AP-5131 is reset.
** Please be sure to save changes before resetting.
*****
```

```
Are you sure you want to restart the AP-5131? (yes/no):
```

```
AP-5131 Boot Firmware Version 1.1.0.0-xxx
```

```
Copyright(c) Symbol Technologies Inc. 2006. All rights reserved.
```

```
Press escape key to run boot firmware .....
```

```
Power On Self Test
```

```
testing ram           : pass
testing nor flash     : pass
testing nand flash    : pass
testing ethernet      : pass
```

For information on restarting the AP-5131 using the applet (GUI), see [Configuring System Settings on page 4-2](#).

AP5131>admin(system)>show

Description:

Displays high-level AP-5131 system information.

Syntax:

show Displays AP-5131 system information.

Example:

```
admin(system)>show

system name           : BldgC
system location       : Atlanta Field Office
admin email address   : johndoe@mycompany.com
system uptime         : 0 days 4 hours 41 minutes
AP-5131 firmware version : 1.1.0.0-30D
country code          : us
serial number         : 05224520500336

admin(system)>
```

For information on displaying System Settings using the applet (GUI), see [Configuring System Settings on page 4-2](#).

AP5131>admin(system)>set**Description:**

Sets AP-5131 system parameters.

Syntax:

set name	<name>	Sets the AP-5131 system name to <name> (1 to 59 characters). The AP-5131 does not allow intermediate space characters between characters within the system name. For example, "ap5131 sales" must be changed to "ap5131sales" to be a valid system name.
loc	<loc>	Sets the AP-5131 system location to <loc> (1 to 59 characters).
email	<email>	Sets the AP-5131 admin email address to <email> (1 to 59 characters).
cc	<code>	Sets the AP-5131 country code using two-letters <code>.

Example:

```
admin(system)>show
```

```

system name           : AP5131
system location       : San Jose Engineering
admin email address   : SJSharkey@symbol.com
system uptime        : 0 days 4 hours 33 minutes
AP-5131 firmware version : 1.1.0.0-30D
country code         : us

```

For information on configuring System Settings using the applet (GUI), see [Configuring System Settings on page 4-2](#). Refer to [Appendix A](#) for information on the two-character country codes.

8.4.1 System Debug and Last Password Commands

AP5131>admin(system)>debug

Description:

Accesses AP-5131 debug information. This information is designed for field service use only, and should not be used by unqualified personnel.

Example:

```
admin(system)>debug
```

```
Debug Password:
```

```
AP-5131 MAC Address is 00:A0:F8:71:6A:74
```

```
Last Password was symbol12
```

AP5131>admin(system)>lastpw

Description:

Displays the last debug password.

```
admin(system)>lastpw
```

```
AP-5131 MAC Address is 00:A0:F8:71:6A:74
```

```
Last Password was symbol12
```

```
Current password used 0 times, valid 4 more time(s)
```

8.4.2 System Access Commands

AP5131>admin(system)>access

Description:

Displays the AP-5131 access submenu.

show	Displays AP-5131 system access capabilities.
set	Goes to the AP-5131 system access submenu.
..	Goes to the parent menu.
/	Goes to the root menu.
save	Saves the current configuration to the AP-5131 system flash.
quit	Quits the CLI and exits the current session.

AP5131>admin(system.access)>set**Description:**

Defines the permissions to access the AP-5131 applet, CLI, SNMP as well as defining their timeout values.

Syntax:

set	applet		Defines the applet HTTP/HTTPS access parameters.
	app-timeout	<minutes>	Sets the applet timeout. Default is 300 Mins.
	cli		Defines CLI Telnet access parameters.
	ssh		Sets the CLI SSH access parameters.
	auth-timout	<seconds>	Disables the radio interface if no data activity is detected after the interval defined. Default is 120 seconds.
	inactive-timeout	<minutes>	Inactivity interval resulting in the AP terminating its connection. Default is 120 minutes.
	snmp		Sets SNMP access parameters.
	admin-auth	local/ RADIUS	Designates a Radius server is used in the authentication verification.
	server	<ip>	Specifies the IP address the Remote Dial-In User Service (RADIUS) server.
	port	<port#>	Specifies the port on which the RADIUS server is listening. Default is 1812.
	secret	<pw>	Defines the shared secret password for RADIUS server authentication.

For information on configuring AP-5131 access settings using the applet (GUI), see [Configuring Data Access on page 4-6](#).

AP5131>admin(system.access)>show**Description:**

Displays the current AP-5131 access permissions and timeout values.

Syntax:

show Shows all of the current system access settings for the AP-5131..

Example:

```
admin(system.access)>show
```

```
-----From LAN1-----From LAN2-----From WAN
applet http access from lan      enable      enable      enable
applet http access from wan      enable      enable      enable
cli telnet access                enable      enable      enable
cli ssh access                   enable      enable      enable
snmp access                       enable      enable      enable

http/s timeout                   : 0
ssh server authentication timeout : 120
ssh server inactivity timeout    : 120
admin authentication mode        : local
```

Related Commands:

set Defines the AP-5131 system access capabilities and timeout values.

For information on configuring AP-5131 access settings using the applet (GUI), see [Configuring Data Access on page 4-6](#).

8.4.3 System Certificate Management Commands

AP5131>admin(system)>cmgr

Description:

Displays the Certificate Manager submenu. The items available under this command include:

genreq	Generates a Certificate Request.
delsel	Deletes a Self Certificate.
loadself	Loads a Self Certificate signed by CA.
listself	Lists the self certificate loaded.
loadca	Loads trusted certificate from CA.
delca	Deletes the trusted certificate.
listca	Lists the trusted certificate loaded.
showreq	Displays a certificate request in PEM format.
delprivkey	Deletes the private key.
listprivkey	Lists names of private keys.
expcert	Exports the certificate file.
impcert	Imports the certificate file.
..	Goes to the parent menu.
/	Goes to the root menu.
save	Saves the configuration to system flash.
quit	Quits the CLI.

AP5131>admin(system.cmgr)> genreq**Description:**

Generates a certificate request.

Syntax:

```
genreq <IDname> <Subject> [-ou <OrgUnit>] [-on <OrgName>] [-cn <City>] [-st <State>] ...
      ... [-p <PostCode>] [-cc <CCode>] [-e <Email>] [-d <Domain>] [-i <IP>] [-sa <SAIgo>]
```

Generates a self-certificate request for a Certification Authority (CA), where:

<IDname>	The private key ID Name (up to 7 chars)
<Subject>	Subject Name (up to 49 chars)
-ou <OrgUnit>	Organization Unit (up to 49 chars)
-on <OrgName>	Organization Name (up to 49 chars)
-cn <City>	City Name of Organization (up to 49 chars)
-st <State>	State Name (up to 49 chars)
-p <PostCode>	Postal code (9 digits)
-cc <CCode>	Country code (2 chars)
-e <Email>	E-mail Address (up to 49 chars)
-d <Domain>	Domain Name (up to 49 chars)
-i <IP>	IP Address (a.b.c.d)
-sa <SAIgo>	Signature Algorithm (one of MD5-RSA or SHA1-RSA)
-k <KSize>	Key size in bits (one of 512 , 1024 , or 2048)

Note: The parameters in [square brackets] are optional. Check with the CA to determine what fields are necessary. For example, most CAs require an email address and an IP address, but not the address of the organization.

Example:

```
admin(system.cmgr)>genreq MyCert2 MySubject -ou MyDept -on MyCompany
```

```
Please wait. It may take some time...
```

```
Generating the certificate request
```

```
Retreiving the certificate request
```

```
The certificate request is
```

```
-----BEGIN CERTIFICATE REQUEST-----
```

```
MIHzMIGeAgEAMDkxEjAQBgNVBAoTCU15Q29tcGFueTEPMA0GA1UECxMGTX1EZXB0
MRIwEAYDVQQDEw1NeVN1YmplY3QwXDANBgkqhkiG9w0BAQEFAANLADBIakEAtKcX
plKFCFAJymTFX71yuxY1fdS7UEhKjBsH7pdqnJnsASK6ZQGAqerjpKScWVlmzYn4
1q2+mgGnCvaZU1Io7wIDAQABoAAwDQYJKoZIhvcNAQEEBQADQCClQ5LHdbG/C1f
Bj8AszttSo/ba4dcX3vHvhhJcmuuWO9LHS2imPA3xhX/d6+Q1SMbs+tG4RP01RSr
iWDyuvwx
```

```
-----END CERTIFICATE REQUEST-----
```

For information on configuring certificate management settings using the applet (GUI), see [Managing Certificate Authority \(CA\) Certificates on page 4-9](#).

AP5131>admin(system.cmgr)> delself**Description:)**

Deletes a self certificate.

Syntax:

delself <IDname> Deletes the self certificate named <IDname>.

Example:

```
admin(system.cmgr)>delself MyCert2
```

For information on configuring self certificate settings using the applet (GUI), see [Creating Self Certificates for Accessing the VPN on page 4-10](#).

AP5131>admin(system.cmgr)> loadself

Description:

Loads a self certificate signed by the Certificate Authority.

Syntax:

loadself <IDname> Load the self certificate signed by the CA with name <IDname>.

For information on configuring self certificate settings using the applet (GUI), see [Creating Self Certificates for Accessing the VPN on page 4-10](#).

AP5131>admin(system.cmgr)> listself**Description:**

Lists the loaded self certificates.

Syntax:

listself Lists all self certificates that are loaded.

For information on configuring self certificate settings using the applet (GUI), see [Creating Self Certificates for Accessing the VPN on page 4-10](#).

AP5131>admin(system.cmgr)> loadca

Description:

Loads a trusted certificate from the Certificate Authority.

Syntax:

loadca Loads the trusted certificate (in PEM format) that is pasted into the command line.

For information on configuring certificate settings using the applet (GUI), see [Importing a CA Certificate on page 4-9](#).

AP5131>admin(system.cmgr)> delca**Description:**

Deletes a trusted certificate.

Syntax:

delca <IDname> Deletes the trusted certificate.

For information on configuring certificate settings using the applet (GUI), see [Importing a CA Certificate on page 4-9](#).

AP5131>admin(system.cmgr)> listca

Description:

Lists the loaded trusted certificate.

Syntax:

listca Lists the loaded trusted certificates.

For information on configuring certificate settings using the applet (GUI), see [Importing a CA Certificate on page 4-9](#).

AP5131>admin(system.cmgr)> showreq**Description:**

Displays a certificate request in PEM format.

Syntax:

showreq <IDname> Displays a certificate request named <IDname> generated from the genreq command.

For information on configuring certificate settings using the applet (GUI), see [Importing a CA Certificate on page 4-9](#).

AP5131>admin(system.cmgr)> delprivkey

Description:

Deletes a private key.

Syntax:

delprivkey <IDname> Deletes private key named <IDname>.

For information on configuring certificate settings using the applet (GUI), see [Creating Self Certificates for Accessing the VPN on page 4-10](#).

AP5131>admin(system.cmgr)> listprivkey**Description:**

Lists the names of private keys.

Syntax:

listprivkey Lists all private keys.

For information on configuring certificate settings using the applet (GUI), see [Importing a CA Certificate on page 4-9](#).

AP5131>admin(system.cmgr)> expcert

Description:

Exports the certificate file.

Syntax:

expcert Exports the certificate file.

For information on configuring certificate settings using the applet (GUI), see [Importing a CA Certificate on page 4-9](#).

AP5131>admin(system.cmgr)> impcert**Description:**

Imports the target certificate file.

Syntax:

impcert Imports the target certificate file.

For information on configuring certificate settings using the applet (GUI), see [Importing a CA Certificate on page 4-9](#).

8.4.4 System SNMP Commands

AP5131>admin(system)> snmp

Description:

Displays the SNMP submenu. The items available under this command are shown below.

access	Goes to the SNMP access submenu.
traps	Goes to the SNMP traps submenu.
..	Goes to the parent menu.
/	Goes to the root menu.
save	Saves the configuration to system flash.
quit	Quits the CLI.

8.4.4.1 System SNMP Access Commands

AP5131>admin(system.snmp.access)

Description:

Displays the SNMP Access menu. The items available under this command are shown below.

show	Shows SNMP v3 engine ID.
add	Adds SNMP access entries.
delete	Deletes SNMP access entries.
list	Lists SNMP access entries.
..	Goes to the parent menu.
/	Goes to the root menu.
save	Saves the configuration to system flash.
quit	Quits the CLI.

AP5131>admin(system.snmp.access)> show

Description:

Shows the SNMP v3 engine ID.

Syntax:

show **eid** Shows the SNMP v3 Engine ID.

Example:

```
admin(system.snmp.access)>show eid
```

```
AP-5131 snmp v3 engine id                    : 000001846B8B4567F871AC68
```

```
admin(system.snmp.access)>
```

For information on configuring SNMP access settings using the applet (GUI), see [Configuring SNMP Access Control on page 4-23](#).

AP5131>admin(system.snmp.access)> add**Description:**

Adds SNMP access entries for specific v1v2 and v3 user definitions.

Syntax:

add acl <ip1> <ip2> Adds an entry to the SNMP access control list with <ip1> as the starting IP address and <ip2> and as the ending IP address.

v1v2c <comm> <access> <oid>
Adds an SNMP v1/v2c configuration with <comm> as the community (1-31 characters), the read/write access set to **ro** (read only) or **rw** (read/write), and the Object Identifier <oid> (a string of 1-127 numbers separated by dot, such as 2.3.4.5.6).

v3 <user> <access> <oid> <sec>
<auth> <pass1> <priv> <pass2>
Adds an SNMP v3 user definition with the username <user> (1 to 31 characters), access set to **ro** (read only) or **rw** (read/write), the object ID set to <oid> (1 to 127 chars in dot notation, such as 1.3.6.1), the security type <sec> set to one of **no auth**, **authnopriv**, or **auth/priv**.

The following parameters must be specified if <sec> is not **none**:

Authentication type <auth> set to **md5** or **sha1**
Authentication password <pass1> (8 to 31 chars)

The following parameters must be specified if <sec> is set to **auth/priv**:

Privacy algorithm set to **des** or **aes**
Privacy password <pass2> (8 to 31 chars)

For information on configuring SNMP access settings using the applet (GUI), see [Configuring SNMP Access Control on page 4-23](#).

AP5131>admin(system.snmp.access)> delete**Description:**

Deletes SNMP access entries for specific v1v2 and v3 user definitions.

Syntax:

delete acl	<idx>	Deletes entry <idx> (1-10) from the access control list.
	all	Deletes all entries from the access control list.
v1v2c	<idx>	Deletes entry <idx> (1-10) from the v1/v2 configuration list.
	all	Deletes all entries from the v1/v2 configuration list.
v3	<idx>	Deletes entry <idx> (1-10) from the v3 user definition list.
	all	Deletes all entries from the v3 user definition list.

Example:

```
admin(system.snmp.access)>list acl
```

```
-----
index  start ip          end ip
-----
1      209.236.24.1      209.236.24.46
```

```
admin(system.snmp.access)>delete acl all
```

```
admin(system.snmp.access)>list acl
```

```
-----
index  start ip          end ip
-----
```

For information on configuring SNMP access settings using the applet (GUI), see [Configuring SNMP Access Control on page 4-23](#).

AP5131>admin(system.snmp.access)> list**Description:**

Lists SNMP access entries.

Syntax:

list acl Lists SNMP access control list entries.
v1v2c Lists SNMP v1/v2c configuration.
v3 <idx> Lists SNMP v3 user definition with index <idx>.
all Lists all SNMP v3 user definitions.

Example:

```
admin(system.snmp.access)>list acl
```

```
-----
index  start ip          end ip
-----
1      209.236.24.1       209.236.24.46
```

```
admin(system.snmp.access)>list v1v2c
```

```
-----
index  community          access          oid
-----
1      public              read only      1.3.6.1
2      private             read/write     1.3.6.1
```

```
admin(system.snmp.access)>list v3 2
```

```
index                : 2
username              : judy
access permission     : read/write
object identifier     : 1.3.6.1
security level        : auth/priv
auth algorithm         : md5
auth password         : *****
privacy algorithm     : des
privacy password     : *****
```

For information on configuring SNMP access settings using the applet (GUI), see [Configuring SNMP Access Control on page 4-23](#).

8.4.4.2 System SNMP Traps Commands

AP5131>admin(system.snmp.traps)

Description:

Displays the SNMP traps submenu. The items available under this command are shown below.

show	Shows SNMP trap parameters.
set	Sets SNMP trap parameters.
add	Adds SNMP trap entries.
delete	Deletes SNMP trap entries.
list	Lists SNMP trap entries.
..	Goes to the parent menu.
/	Goes to the root menu.
save	Saves the configuration to system flash.
quit	Quits the CLI.

AP5131>admin(system.snmp.traps)> show**Description:**

Shows SNMP trap parameters.

Syntax:

show **trap** Shows SNMP trap parameter settings.
 rate-trap Shows SNMP rate-trap parameter settings.

Example:

```
admin(system.snmp.traps)>show trap

SNMP MU Traps
  mu associated                               : enable
  mu unassociated                             : disable
  mu denied association                      : disable
  mu denied authentication                  : disable

SNMP Traps
  snmp authentication failure               : disable
  snmp acl violation                         : disable

SNMP Network Traps
  physical port status change               : enable
  denial of service                          : enable
  denial of service trap rate limit         : 10 seconds

SNMP System Traps
  system cold start                          : disable
  system config changed                     : disable
  rogue ap detection                         : disable
  ap radar detection                         : disable
  wpa counter measure                       : disable
  mu hotspot status                         : disable
  vlan                                       : disable
  lan monitor                                : disable
```

For information on configuring SNMP traps using the applet (GUI), see [Enabling SNMP Traps on page 4-25](#).

AP5131>admin(system.snmp.traps)> set**Description:**

Sets SNMP trap parameters.

Syntax:

set	mu-assoc	enable/disable			Enables/disables the MU associated trap.
	mu-unassoc	enable/disable			Enables/disables the MU unassociated trap.
	mu-deny-assoc	enable/disable			Enables/disables the MU association denied trap.
	mu-deny-auth	enable/disable			Enables/disables the MU authentication denied trap.
	snmp-auth	enable/disable			Enables/disables the authentication failure trap.
	snmp-acl	enable/disable			Enables/disables the SNMP ACL violation trap.
	port	enable/disable			Enables/disables the physical port status trap.
	dos-attack	enable/disable			Enables/disables the denial of service trap.
	interval	<rate>			Sets denial of service trap interval.
	cold	enable/disable			Enables/disables the system cold start trap.
	cfg	enable/disable			Enables/disables a configuration changes trap.
	rogue-ap	enable/disable			Enables/disables a trap when a rogue-ap is detected.
	ap-radar	enable/disable			Enables/disables the AP Radar Detection trap.
	wpa-counter	enable/disable			Enables/disables the WPA counter measure trap.
	hotspot-mu-status	enable/disable			Enables/disables the hotspot mu status trap.
	vlan	enable/disable			Enables/disables VLAN traps.
	lan-monitor	enable/disable			Enables/disables LAN monitor traps.
	rate	<rate>	<scope>	<value>	Sets the particular <rate> to monitor to <value> given the indicated <scope>. See table below for information on the possible values for <rate>, <scope>, and <value>.
	min-pkt	<pkt>			Sets the minimum number of packets required for rate traps to fire (1-65535).

For information on configuring SNMP traps using the applet (GUI), see [Configuring Specific SNMP Traps on page 4-28](#).

AP5131>admin(system.snmp.traps)> add**Description:**

Adds SNMP trap entries.

Syntax:

add v1v2 <ip> <port> <comm> <ver>
 Adds an entry to the SNMP v1/v2 access list with the destination IP address set to <ip>, the destination UDP port set to <port>, the community string set to <comm> (1 to 31 characters), and the SNMP version set to <ver>.

v3 <ip> <port> <user> <sec> <auth> <pass1> <priv> <pass2>
 Adds an entry to the SNMP v3 access list with the destination IP address set to <ip>, the destination UDP port set to <port>, the username set to <user> (1 to 31 characters), and the authentication type set to one of **none**, **auth**, or **auth/priv**.

The following parameters must be specified if <sec> is not **none**:
 Authentication type <auth> set to **md5** or **sha1**
 Authentication password <pass1> (8 to 31 chars)

The following parameters must be specified if <sec> is set to **auth/priv**:
 Privacy algorithm set to **des** or **aes**
 Privacy password <pass2> (8 to 31 chars)

Example:

```
admin(system.snmp.traps)>add v1v2 203.223.24.2 333 mycomm v1
admin(system.snmp.traps)>list v1v2c
-----
index      dest ip          dest port      community      version
-----
1          203.223.24.2    333           mycomm        v1

admin(system.snmp.traps)>add v3 201.232.24.33 555 BigBoss none md5
admin(system.snmp.traps)>list v3 all

index                : 1
destination ip       : 201.232.24.33
destination port     : 555
username              : BigBoss
security level       : none
auth algorithm        : md5
auth password        : *****
privacy algorithm    : des
privacy password     : *****
```

For information on configuring SNMP traps using the applet (GUI), see [Configuring SNMP RF Trap Thresholds on page 4-30](#).

AP5131>admin(system.snmp.traps)> delete

Description:

Deletes SNMP trap entries.

Syntax:

delete	v1v2c	<idx>	Deletes entry <idx> from the v1v2c access control list.
		all	Deletes all entries from the v1v2c access control list.
	v3	<idx>	Deletes entry <idx> from the v3 access control list.
		all	Deletes all entries from the v3 access control list.

Example:

```
admin(system.snmp.traps)>delete v1v2 all
```

For information on configuring SNMP traps using the applet (GUI), see [Configuring SNMP Settings on page 4-17](#).

AP5131>admin(system.snmp.traps)> list**Description:**

Lists SNMP trap entries.

Syntax:

```
list v1v2c      Lists SNMP v1/v2c access entries.
     v3        <idx> Lists SNMP v3 access entry <idx>.
     all       Lists all SNMP v3 access entries.
```

Example:

```
admin(system.snmp.traps)>add v1v2 203.223.24.2 162 mycomm v1
admin(system.snmp.traps)>list v1v2c
```

```
-----
index   dest ip           dest port         community         version
-----
1       203.223.24.2     162              mycomm           v1
```

```
admin(system.snmp.traps)>add v3 201.232.24.33 555 BigBoss none md5
admin(system.snmp.traps)>list v3 all
```

```
index           : 1
destination ip   : 201.232.24.33
destination port : 555
username        : BigBoss
security level   : none
auth algorithm   : md5
auth password    : *****
privacy algorithm : des
privacy password : *****
```

For information on configuring SNMP traps using the applet (GUI), see [Configuring SNMP RF Trap Thresholds on page 4-30](#).

|

8.4.5 System Network Time Protocol (NTP) Commands

AP5131>admin(system)> ntp

Description:

Displays the NTP menu. The correct network time is required for numerous functions to be configured accurately on the AP-5131.

Syntax:

-	
show	Shows NTP parameters settings.
date-zone	Show date, time and time zone.
zone-list	Displays list of time zones.
set	Sets NTP parameters.
..	Goes to the parent menu.
/	Goes to the root menu.
save	Saves the configuration to system flash.
quit	Quits the CLI.

AP5131>admin(system.ntp)> show**Description:**

Displays the NTP server configuration.

Syntax:

show Shows all NTP server settings.

Example:

```
admin(system.ntp)>show

current time (UTC)           : 2006-07-31 14:35:20

Time Zone:

ntp mode                     : enable
preferred Time server ip    : 203.21.37.18
preferred Time server port  : 123
first alternate server ip   : 203.21.37.19
first alternate server port : 123
second alternate server ip  : 0.0.0.0
second alternate server port: 123
synchronization interval   : 15 minutes
```

For information on configuring NTP using the applet (GUI), see [Configuring Network Time Protocol \(NTP\) on page 4-32](#).

AP5131>admin(system.ntp)> date-zone

Description:

Show date, time and time zone.

Syntax:

date-zone Show date, time and time zone.

Example:

```
admin(system.ntp)>date-zone
```

```
Date/Time           : Sat 1970-Jan-03 20:06:22 +0000 UTC
```

```
Time Zone           :
```

AP5131>admin(system.ntp)> zone-list

Description:

Displays an extensive list of time zones for countries around the world.

Syntax:

zone-list Displays list of time zones for every known zone.

Example:

```
admin(system.ntp)> zone-list
```

AP5131>admin(system.ntp)> set**Description:**

Sets NTP parameters for AP-5131 clock synchronization.

Syntax:

set	mode	<ntp-mode>	Enables or disables NTP.
	server	<idx> <ip>	Sets the NTP sever IP address.
	port	<idx> <port>	Defines the port number.
	intrvl	<period>	Defines the clock synchronization interval used between the AP-5131 and the NTP server in minutes (15 - 65535).
	time	<time>	Sets the current system time. [yyyy] - year, [mm] - month, [dd] - day of the month, [hh] - hour of the day, [mm] - minute, [ss] second, [zone -idx] Index of the zone.
	zone	<zone>	Defines the time zone (by index) for the target country.

Example:

```
admin(system.ntp)>set mode enable
admin(system.ntp)>set server 1 203.21.37.18
admin(system.ntp)>set port 1 123
admin(system.ntp)>set intrvl 15
admin(system.ntp)>set zone 1
```

For information on configuring NTP using the applet (GUI), see [Configuring Network Time Protocol \(NTP\) on page 4-32](#).

8.4.6 System Log Commands

AP5131>admin(system)> logs

Description:

Displays the AP-5131 log submenu. Logging options include:

Syntax:

show	Shows logging options.
set	Sets log options and parameters.
view	Views system log.
delete	Deletes the system log.
send	Sends log to the designated FTP Server.
..	Goes to the parent menu.
/	Goes to the root menu.
save	Saves configuration to system flash.
quit	Quits the CLI.

AP5131>admin(system.logs)> show

Description:

Displays the current AP-5131 logging settings.

Syntax:

show Displays the logging options.

Example:

```
admin(system.logs)>show
```

```
log level           : L6 Info
syslog server logging : enable
syslog server ip address : 192.168.0.102
```

For information on configuring logging settings using the applet (GUI), see [Logging Configuration on page 4-35](#).

AP5131>admin(system.logs)> set**Description:**

Sets log options and parameters.

Syntax:

set	level	<level>	Sets the level of the events that will be logged. All events with a level at or above <level> (L0-L7) will be saved to the system log. L0:Emergency L1:Alert L2:Critical L3:Errors L4:Warning L5:Notice L6:Info (<i>default setting</i>) L7:Debug
	mode	<mode>	Enables or disables syslog server logging.
	ipadr	<ip>	Sets the external syslog server IP address to <ip> (a.b.c.d).

For information on configuring logging settings using the applet (GUI), see [Logging Configuration on page 4-35](#).

AP5131>admin(system.logs)> view**Description:**

Displays the AP-5131 system log file.

Syntax:

view Displays the entire AP-5131 system log file.

Example:

```
admin(system.logs)>view
```

```
Jan  7 16:14:00 (none) syslogd 1.4.1: restart (remote reception).
Jan  7 16:14:10 (none) klogd: :ps log:fc: queue maintenance
Jan  7 16:14:41 (none) klogd: :ps log:fc: queue maintenance
Jan  7 16:15:43 (none) last message repeated 2 times
Jan  7 16:16:01 (none) CC:   4:16pm  up 6 days, 16:16, load average: 0.00, 0.01,
    0.00
Jan  7 16:16:01 (none) CC:   Mem:           62384           32520           29864
    0             0
Jan  7 16:16:01 (none) CC: 0000077e 0012e95b 0000d843 00000000 00000003 0000121
e 00000000 00000000 0037ebf7 000034dc 00000000 00000000 00000000
Jan  7 16:16:13 (none) klogd: :ps log:fc: queue maintenance
Jan  7 16:16:44 (none) klogd: :ps log:fc: queue maintenance
Jan  7 16:17:15 (none) klogd: :ps log:fc: queue maintenance
Jan  7 16:17:15 (none) klogd: :ps log:fc: queue maintenance
```

For information on configuring logging settings using the applet (GUI), see [Logging Configuration on page 4-35](#).

AP5131>admin(system.logs)> delete**Description:**

Deletes the log files.

Syntax:

delete Deletes the AP-5131 system log file.

Example:

```
admin(system.logs)>delete
```

For information on configuring logging settings using the applet (GUI), see [Logging Configuration on page 4-35](#).

AP5131>admin(system.logs)> send

Description:

Sends log and core file to an FTP Server.

Syntax:

send Sends the system log file via FTP to a location specified with the set command. Refer to the command set under the AP5131>admin(config) command for information on setting up an FTP server and login information.

Example:

```
admin(system.logs)>send
```

```
File transfer           : [ In progress ]
```

```
File transfer           : [ Done ]
```

```
admin(system.logs)>
```

For information on configuring logging settings using the applet (GUI), see [Logging Configuration on page 4-35](#).

8.4.7 System Configuration-Update Commands

AP5131>admin(system.config)>

Description:

Displays the AP-5131 configuration update submenu.

Syntax:

default	Restores the default AP-5131 configuration.
partial	Restores a partial default AP-5131 configuration.
show	Shows import/export parameters.
set	Sets import/export AP-5131 configuration parameters.
export	Exports AP-5131 configuration to a designated system.
import	Imports configuration to the AP-5131.
..	Goes to the parent menu.
/	Goes to the root menu.
save	Saves the configuration to AP-5131 system flash.
quit	Quits the CLI.

AP5131>admin(system.config)> default

Description:

Restores the full AP-5131 factory default configuration.

Syntax:

default Restores the AP-5131 to the original (factory) configuration.

Example:

```
admin(system.config)>default
```

```
Are you sure you want to default the configuration? <yes/no>:
```

For information on importing/exporting AP-5131 configurations using the applet (GUI), see [Importing/Exporting Configurations on page 4-37](#).

AP5131>admin(system.config)> partial**Description:**

Restores a partial factory default configuration. The AP-5131's LAN, WAN and SNMP settings are unaffected by the partial restore.

Syntax:

default Restores a partial AP-5131 configuration.

Example:

```
admin(system.config)>partial
```

```
Are you sure you want to partially default the AP-5131? <yes/no>:
```

For information on importing/exporting AP-5131 configurations using the applet (GUI), see [Importing/Exporting Configurations on page 4-37](#).

AP5131>admin(system.config)> show**Description:**

Displays import/export parameters for the AP-5131 configuration file.

Syntax:

show Shows all import/export parameters.

Example:

```
admin(system.config)>show
```

```
cfg filename           : cfg.txt
cfg filepath           :
ftp/tftp server ip address : 192.168.0.101
ftp user name          : myadmin
ftp password           : *****
```

For information on importing/exporting AP-5131 configurations using the applet (GUI), see [Importing/Exporting Configurations on page 4-37](#).

AP5131>admin(system.config)> set**Description:**

Sets the import/export parameters.

Syntax:

set file	<filename>	Sets the configuration file name (1 to 39 characters in length).
path	<path>	Defines the path used for the configuration file upload.
server	<ipaddress>	Sets the FTP/TFTP server IP address.
user	<username>	Sets the FTP user name (1 to 39 characters in length).
passwd	<pswd>	Sets the FTP password (1 to 39 characters in length).

Example:

```
admin(system.config)>set server 192.168.22.12
admin(system.config)>set user myadmin
admin(system.config)>set passwd georges
```

```
admin(system.config)>show
```

```
cfg filename           : cfg.txt
cfg filepath           :
ftp/tftp server ip address : 192.168.22.12
ftp user name          : myadmin
ftp password           : *****
```

For information on importing/exporting AP-5131 configurations using the applet (GUI), see [Importing/Exporting Configurations on page 4-37](#).

AP5131>admin(system.config)> export**Description:**

Exports the configuration from the system.

Syntax:

- export ftp** Exports the AP-5131 configuration to the FTP server. Use the set command to set the server, user, password, and file name before using this command.
- tfoot** Exports the AP-5131 configuration to the TFTP server. Use the set command to set the IP address for the TFTP server before using the command.
- terminal** Exports the AP-5131 configuration to a terminal.

Example:

Export FTP Example:

```
admin(system.config)>set server 192.168.22.12
admin(system.config)>set user myadmin
admin(system.config)>set file config.txt
admin(system.config)>set passwd

admin(system.config)>export ftp

Export operation           : [ Started ]
Building configuration file : [ Done ]
File transfer              : [ In progress ]
File transfer              : [ Done ]
Export Operation          : [ Done ]
```

Export TFTP Example:

```
admin(system.config)>set server 192.168.0.101
admin(system.config)>set file config.txt
admin(system.config)>export tftp

Export operation           : [ Started ]
Building configuration file : [ Done ]
File transfer              : [ In progress ]
File transfer              : [ Done ]
Export Operation          : [ Done ]
```



CAUTION Make sure a copy of the AP-5131's current configuration is exported (to a secure location) before exporting the AP-5131's configuration, as you will want a valid version available in case errors are encountered with the configuration export.

For information on importing/exporting AP-5131 configurations using the applet (GUI), see [Importing/Exporting Configurations on page 4-37](#).

AP5131>admin(system.config)> import**Description:**

Imports the AP-5131 configuration to the AP-5131. Errors could display as a result of invalid configuration parameters. Correct the specified lines and import the file again until the import operation is error free.

Syntax:

import ftp Imports the AP-5131 configuration file from the FTP server.
Use the set command to set the server, user, password, and file.

tftp Imports the AP-5131 configuration from the TFTP server.
Use the set command to set the server and file.

Example:

Import FTP Example

```
admin(system.config)>set server 192.168.22.12
admin(system.config)>set user myadmin
admin(system.config)>set file config.txt
admin(system.config)>set passwd mysecret
admin(system.config)>import ftp
Import operation : [ Started ]
File transfer : [ In progress ]
File transfer : [ Done ]
Import operation : [ Done ]
```

Import TFTP Example

```
admin(system.config)>set server 192.168.0.101
admin(system.config)>set file config.txt
admin(system.config)>import tftp
Import operation : [ Started ]
File transfer : [ In progress ]
File transfer : [ Done ]
Import operation : [ Done ]
```



CAUTION A single-radio model AP-5131 cannot import/export its configuration to a dual-radio model AP-5131. In turn, a dual-radio model AP-5131 cannot import/export its configuration to a single-radio AP-5131.



CAUTION Symbol discourages importing a 1.0 baseline configuration file to a 1.1 version AP-5131. Similarly, a 1.1 baseline configuration file should not be imported to a 1.0 version AP-5131. Importing configuration files between different version AP-5131's results in broken configurations, since new features added to the 1.1 version AP-5131 cannot be supported in a 1.0 version AP-5131.

For information on importing/exporting AP-5131 configurations using the applet (GUI), see [Importing/Exporting Configurations on page 4-37](#).

8.4.8 Firmware Update Commands

AP5131>admin(system)>fw-update

Description:

Displays the firmware update submenu. The items available under this command are shown below.



NOTE The AP-5131 must complete the reboot process to successfully update the device firmware, regardless of whether the reboot is conducted using the GUI or CLI interfaces.

show	Displays the current AP-5131 firmware update settings.
set	Defines the AP-5131 firmware update parameters.
update	Executes the firmware update.
..	Goes to the parent menu.
/	Goes to the root menu.
save	Saves the current configuration to the AP-5131 system flash.
quit	Quits the CLI and exits the current session.

AP5131>admin(system.fw-update)>show**Description:**

Displays the current AP-5131 firmware update settings.

Syntax:

show Shows the current system firmware update settings for the AP-5131.

Example:

```
admin(system.fw-update)>show
```

```
automatic firmware upgrade      : enable
automatic config upgrade       : enable
automatic upgrade interface     : WAN

firmware filename               : APFW.bin
firmware path                   : /tftpboot/
ftp/tftp server ip address     : 168.197.2.2
ftp user name                   : pkeegan
ftp password                    : *****
```

For information on updating AP-5131 device firmware using the applet (GUI), see [Updating Device Firmware on page 4-41](#).

AP5131>admin(system.fw-update)>set**Description:**

Defines AP-5131 firmware update settings and user permissions.

Syntax:

set fw-auto	<mode>	When enabled, updates device firmware each time the firmware versions are found to be different between the AP-5131 and the specified firmware on the remote system.
cfg-auto	<mode>	When enabled, updates device configuration file each time the config file versions are found to be different between the AP-5131 and the specified LAN or WAN interface.
iface	<wan/lan1/lan2>	Defines the target interface for version updates if the fw-auto and/or cfg-auto options are enabled.
file	<name>	Defines the firmware file name (1 to 39 characters).
path	<path>	Specifies a path for the file (1 to 39 characters)..
server	<ip>	The IP address for the FTP/TFTP server used for the firmware and/or config file update.
user	<name>	Specifies a username for FTP server login (1 to 39 characters)..
passwd	<password>	Specifies a password for FTP server login (1 to 39 characters).. Default is symbol.

For information on updating AP-5131 device firmware using the applet (GUI), see [Updating Device Firmware on page 4-41](#).

AP5131>admin(system.fw-update)>update**Description:**

Executes the AP-5131 firmware update over the WAN or LAN port using either ftp or tftp.

Syntax:

update <mode><iface> Defines the ftp or tftp mode used to conduct the firmware update. Specifies whether the update is executed over the AP-5131's WAN, LAN1 or LAN2 interface <iface>.



NOTE The AP-5131 must complete the reboot process to successfully update the device firmware, regardless of whether the reboot is conducted using the GUI or CLI interfaces.

For information on updating AP-5131 device firmware using the applet (GUI), see [Updating Device Firmware on page 4-41](#).

8.5 Statistics Commands

AP5131>admin(stats)

Description:

Displays the AP-5131 statistics submenu. The items available under this command are:

show	Displays AP-5131 WLAN, MU, LAN and WAN statistics.
send-cfg-ap	Sends a config file to another AP-5131 within the known AP table.
send-cfg-all	Sends a config file to all AP-5131s within the known AP table.
clear	Clears all statistic counters to zero.
flash-all-leds	Starts and stops the flashing of all AP-5131 LEDs.
echo	Defines the parameters for pinging a designated station.
ping	Initiates a ping test.
..	Moves to the parent menu.
/	Goes to the root menu.
save	Saves the current configuration to system flash.
quit	Quits the CLI.

AP5131>admin(stats)> show**Description:**

Displays AP-5131 system information.

Syntax:

show	wan	Displays stats for the AP-5131 WAN port.
	lan	Displays stats for the AP-5131 LAN port
	stp	Displays LAN Spanning Tree Status
	wlan	Displays WLAN status and statistics summary.
	s-wlan	Displays status and statistics for an individual WLAN
	radio	Displays a radio statistics transmit and receive summary.
	s-radio	Displays radio statistics for a single radio
	retry-hgram	Displays a radio's retry histogram statistics.
	mu	Displays all mobile unit (MU) status.
	s-mu	Displays status and statistics for an individual MU.
	auth-mu	Displays single MU Authentication statistics.
	wlap	Displays Wireless Bridge Statistics statistics summary.
	s-wlap	Displays single Wireless Bridge statistics.
	known-ap	Displays a Known AP summary.

For information on displaying WAN port statistics using the applet (GUI), see [Viewing WAN Statistics on page 7-2](#).

For information on displaying LAN port statistics using the applet (GUI), see [Viewing LAN Statistics on page 7-6](#).

For information on displaying Wireless statistics using the applet (GUI), see [Viewing Wireless Statistics on page 7-11](#).

For information on displaying individual WLAN statistics using the applet (GUI), see [Viewing WLAN Statistics on page 7-13](#).

For information on displaying Radio statistics using the applet (GUI), see [Viewing Radio Statistics Summary on page 7-17](#).

For information on displaying MU statistics using the applet (GUI), see [Viewing MU Statistics Summary on page 7-23](#).

For information on displaying Mesh statistics using the applet (GUI), see [Viewing the Mesh Statistics Summary on page 7-29](#).

For information on displaying Known AP statistics using the applet (GUI), see [Viewing Known Access Point Statistics on page 7-30](#).

AP5131>admin(stats)> send-cfg-ap

Description:

Copies the AP-5131's configuration to another AP-5131 within the known AP table.

Syntax:

send-cfg-ap <index> Copies the AP-5131's configuration to the AP-5131s within the known AP table. Mesh configuration attributes do not get copied using this command and must be configured manually.

Example:

```
admin(stats)>send-cfg-ap 2
admin(stats)>
```



NOTE The send-cfg-ap command copies all existing configuration parameters except Mesh settings, LAN IP data, WAN IP data and DHCP Server parameter information.

For information on copying the AP-5131 config to another AP-5131 using the applet (GUI), see [Viewing Known Access Point Statistics on page 7-30](#).

AP5131>admin(stats)> send-cfg-all**Description:**

Copies the AP-5131's configuration to all of the AP-5131s within the known AP table.

Syntax:

send-cfg-all Copies the AP-5131's configuration to all of the AP-5131s within the known AP table.

Example:

```
admin(stats)>send-cfg-all
admin(stats)>
```



NOTE The send-cfg-all command copies all existing configuration parameters except Mesh settings, LAN IP data, WAN IP data and DHCP Server parameter information.

For information on copying the AP-5131 config to another AP-5131 using the applet (GUI), see [Viewing Known Access Point Statistics on page 7-30](#).

AP5131>admin(stats)> clear**Description:**

Clears the specified statistics counters to zero to begin new data calculations.

Syntax:

clear	wan	Clears WAN statistics counters.
	lan	Clears LAN statistics counters.
	all-rf	Clears all RF data.
	all-wlan	Clears all WLAN summary information.
	wlan	Clears individual WLAN statistic counters.
	all-radio	Clears AP-5131 radio summary information.
	radio1	Clears statistics counters specific to radio1.
	radio2	Clears statistics counters specific to radio2.
	all-mu	Clears all MU statistic counters.
	mu	Clears MU statistics counters.
	known-ap	Clears Known AP statistic counters.

AP5131>admin(stats)> flash-all-leds

Description:

Starts and stops the illumination of a specified access point's LEDs.

Syntax:

flash-all-leds <index> Defines the Known AP index number of the target AP to flash.
<stop/start> Begins or terminates the flash activity.

Example:

```
admin(stats)>

admin(stats)>flash-all-leds 1 start
Password *****
admin(stats)>flash-all-leds 1 stop
admin(stats)>
```

For information on flashing AP-5131 LEDs using the applet (GUI), see [Viewing Known Access Point Statistics on page 7-30](#).

AP5131>admin(stats)> echo

Description:

Defines the echo test values used to conduct a ping test to an associated MU.

Syntax:

show	Shows the Mobile Unit Statistics Summary.
list	Defines echo test parameters and result.
set	Determines echo test packet data.
start	Begins echoing the defined station.
..	Goes to parent menu.
/	Goes to root menu.
quit	Quits CLI session.

For information on MU Echo and Ping tests using the applet (GUI), see [Pinging Individual MUs on page 7-27](#).

AP5131>admin.stats.echo)> show**Description:**

Shows Mobile Unit Statistics Summary.

Syntax:

show Shows Mobile Unit Statistics Summary.

Example:

```
admin(stats.echo)>show
```

```
-----  
Idx      IP Address      MAC Address      WLAN      Radio      T-put      ABS      Retries  
-----  
1        192.168.2.0    00:A0F8:72:57:83 demo      11a
```

AP5131>admin.stats.echo)> list

Description:

Lists echo test parameters and results.

Syntax:

list Lists echo test parameters and results.

Example:

```
admin(stats.echo)>list
```

```
Station Address           : 00A0F8213434
Number of Pings           : 10
Packet Length             : 10
Packet Data (in HEX)      : 55
```

```
admin(stats.echo)>
```

For information on MU Echo and Ping tests using the applet (GUI), see [Pinging Individual MUs on page 7-27](#).

AP5131>admin.stats.echo)>set**Description:**

Defines the parameters of the echo test.

Syntax:

set	station	<mac>	Defines MU target MAC address.
	request	<num>	Sets number of echo packets to transmit (1-539).
	length	<num>	Determines echo packet length in bytes (1-539).
	data	<hex>	Defines the particular packet data.

For information on MU Echo and Ping tests using the applet (GUI), see [Pinging Individual MUs on page 7-27](#).

AP5131>admin.stats.echo)> start

Description:

Initiates the echo test.

Syntax:

start Initiates the echo test.

Example:

```
admin(stats.echo)>start
```

```
admin(stats.echo)>list
```

```
Station Address           : 00A0F843AABB
Number of Pings           : 10
Packet Length             : 100
Packet Data (in HEX)     : 1

Number of MU Responses    : 2
```

For information on MU Echo and Ping tests using the applet (GUI), see [Pinging Individual MUs on page 7-27](#).

AP5131>admin(stats)> ping**Description:**

Defines the ping test values used to conduct a ping test to an AP with the same ESSID.

Syntax:

ping	show	Shows Known AP Summary details.
	list	Defines ping test packet length.
	set	Determines ping test packet data.
	start	Begins pinging the defined station.
	..	Goes to parent menu.
	/	Goes to root menu.
	quit	Quits CLI session.

For information on Known AP tests using the applet (GUI), see [Pinging Individual MUs on page 7-27](#).

AP5131>admin.stats.ping)> show**Description:**

Shows Known AP Summary Details.

Syntax:

show Shows Known AP Summary Details.

Example:

```
admin(stats.ping)>show
```

```
-----  
Idx      IP Address      MAC Address      MUs      KBIOS      Unit Name  
-----  
1        192.168.2.0     00:A0F8:72:57:83  3        0          AP-5131
```

AP5131>admin.stats.ping)> list**Description:**

Lists ping test parameters and results.

Syntax:

list Lists ping test parameters and results.

Example:

```
admin(stats.ping)>list
```

```
Station Address           : 00A0F8213434
Number of Pings           : 10
Packet Length             : 10
Packet Data (in HEX)      : 55
```

```
admin(stats.ping)>
```

For information on Known AP tests using the applet (GUI), see [Pinging Individual MUs on page 7-27](#).

AP5131>admin.stats.ping)> set**Description:**

Defines the parameters of the ping test.

Syntax:

set	station	Defines the AP target MAC address.
	request	Sets number of ping packets to transmit (1-539).
	length	Determines ping packet length in bytes (1-539).
	data	Defines the particular packet data.

Example:

```
admin(stats.ping)>set station 00A0F843AABB
admin(stats.ping)>set request 10
admin(stats.ping)>set length 100
admin(stats.ping)>set data 1

admin(stats.ping)>
```

For information on Known AP tests using the applet (GUI), see [Pinging Individual MUs on page 7-27](#).

AP5131>admin.stats.echo> start**Description:**

Initiates the ping test.

Syntax:

start Initiates the ping test.

Example:

```
admin(stats.ping)>start
```

```
admin(stats.ping)>list
```

```
Station Address           : 00A0F843AABB
Number of Pings           : 10
Packet Length             : 100
Packet Data (in HEX)      : 1

Number of AP Responses    : 2
```

For information on Known AP tests using the applet (GUI), see [Pinging Individual MUs on page 7-27](#).

Configuring Mesh Networking

9.1 Mesh Networking Overview

An AP-5131 can be configured in two modes to support the new mesh networking functionality. The AP-5131 can be set to a client bridge mode and/or a base bridge mode (which accepts connections from client bridges). Base bridge and client bridge mode can be used at the same time by an individual AP-5131 to optimally bridge traffic to other members of the mesh network and service associated MUs.

An AP-5131 in client bridge mode scans to locate other access points using the WLAP client's ESSID. Then it is required to go through the association and authentication process to establish wireless connections with the located devices. This association process is identical to the AP-5131's current MU association process. Once the association and authentication process is complete, the wireless client adds the connection as a port on its bridge module. This causes the client bridge to begin forwarding packets to the base bridge node. The base bridge realizes it is talking to a wireless client bridge. It then adds that connection as a port on its own bridge module. The two bridges at that point are communicating using the *Spanning Tree Protocol* (STP).

AP-5131s configured as both a base and a client bridge function as *repeaters* to transmit data with associated MUs in their coverage area (client bridge mode) as well as forward traffic to other AP-5131s in the mesh network (base bridge mode). The number of AP-5131s and their intended function within the mesh network dictate whether they should be configured as base bridges, client bridges or both (repeaters). For a use case on how AP-5131s are configured in respect to a fictional business need, see [Usage Scenario - Trion Enterprises on page 9-18](#).

The spanning tree determines the path to the root and detects if the current connection is part of a network loop with another connection in the system. Each bridge can be configurable so the administrator can control the spanning tree to define the root bridge and what the forwarding paths are. Once the spanning tree converges, both access points begin learning which destinations reside on which side of the network. This allows them to forward traffic intelligently.

After the client bridge establishes at least one wireless connection (if configured to support mobile users), it begins beaconing and accepting wireless connections. If configured as both a client bridge and a base bridge, it begins accepting client bridge connections. Therefore, the mesh network could connect simultaneously to different networks in a manner whereby a network loop is not created and then the connection is not blocked. Once the client bridge establishes at least one wireless connection, it begins establishing other wireless connections as it finds them available. Thus, the client bridge is able to establish simultaneous redundant links.

A mesh network must use one of the two AP-5131 LANs. If intending to use the AP-5131 for mesh networking support, Symbol recommends configuring at least one WLAN (of the 16 WLANs available) specifically for mesh networking support.

The client bridge creates up to three connections if it can find base bridges for connection. If the connections are redundant (on the same network), then one connection will be forwarding and the others blocked. However, if each of the connections links to a different wired network, then none are redundant and all are forwarding. Thus, the bridge automatically detects and disables redundant connections, but leaves non-redundant connections forwarding. This gives the user the freedom to configure their topology in a variety of ways without limitations. This is important when configuring multiple AP-5131s for base bridge support in areas like a shipping yard where a large radio coverage area is required. For more information on configuring the AP-5131 in respect to specific usage scenarios, see [Usage Scenario - Trion Enterprises on page 9-18](#).



NOTE Since each AP-5131 can establish up to 3 simultaneous wireless connections, some of these connections could be redundant. If this is the case, the STP algorithm defines which links are the redundant links and disables those links from forwarding.

If an AP-5131 is configured as a base bridge (but not as a client bridge) it operates normally at boot time. The base bridge AP-5131 supports connections made by other client bridge AP-5131s.

The dual-radio model AP-5131 affords users better optimization of the mesh networking feature by enabling the AP-5131 to transmit to other mesh network members using one independent radio and transmit with associated MUs using the second independent radio. A single-radio AP-5131 has its channel utilization and throughput degraded in a mesh network, as the AP's single radio must process both mesh network traffic with other AP-5131s and MU traffic with its associated devices.



CAUTION Only Symbol model AP-5131s can be used as base bridges, client bridges or repeaters within an AP-5131 supported mesh network. If utilizing a mesh network, Symbol recommends considering a dual-radio model to optimize channel utilization and throughput.

9.1.1 The AP-5131 Client Bridge Association Process

An AP-5131 in client bridge mode performs an active scan to quickly create a table of the access points nearby. The table contains the AP-5131s matching the ESS of the client bridge AP's WLAN. The table is used to determine the best AP-5131 to connect to (based on signal strength, load and the user's configured preferred connection list).

The association and authentication process is identical to the MU association process. The client AP-5131 sends 802.11 authentication and association frames to the base AP-5131. The base AP-5131 responds as if the client is an actual mobile unit. Depending on the security policy, the two AP-5131's engage in the normal handshake mechanism to establish keys.

After device association, the two AP-5131s are connected and the system can establish the bridge and run the spanning tree algorithm. In the meantime, the AP-5131 in client bridge mode continues to scan in the background attempts to establish an association with other AP-5131s using the same ESS on the same channel.



CAUTION An AP-5131 in Base Bridge mode logs out whenever a Client Bridge associates to the Base Bridge over the LAN connection. This problem is not experienced over the AP-5131's WAN connection. If this situation is experienced, log-in to the AP-5131 again.

The AP-5131 in client bridge mode attempts to establish up to 3 simultaneous wireless connections. The second and third connections are established in the background while the system is running. The first connection needs to be established before the system starts bridging traffic.

The dual-radio model AP-5131 affords users better optimization of the mesh networking feature by allowing the AP-5131 to transmit to other AP-5131s (in base or client bridge mode) using one independent radio and transmit with its associated MUs using the second independent radio. A single-radio AP-5131 has its channel utilization and throughput degraded in a mesh network, as the AP-5131's single radio must process both mesh network traffic with other AP-5131s and MU traffic with its associated devices.

9.1.2 Spanning Tree Protocol (STP)

The AP-5131 performs mesh networking using STP as defined in the 802.1d standard.



NOTE The Symbol AP-4131 access point uses a non-standard form of 802.1d STP, and is therefore not compatible as a base bridge or client bridge within an AP-5131 managed network.

Once device association is complete, the client and base bridge exchange *Configuration Bridge Protocol Data Units* (BPDUs) to determine the path to the root. STP also determines whether a given port is a redundant connection or not.

9.1.3 Defining the Mesh Topology

When a user wants to control how the spanning tree determines client bridge connections, they need to control the mesh configuration. The user must be able to define one node as the root. Assigning a base bridge the lowest bridge priority defines it as the root.



NOTE Symbol recommends using the [Mesh STP Configuration](#) screen to define a base bridge as a root. Only advanced users should use the Advanced Client Bridge Settings screen's Preferred List to define the mesh topology, as omitting a bridge from the preferred list could break connections within the mesh network.

The AP-5131 can manipulate the path cost assigned to a bridge connection based on that connection's RSSI. This results in the spanning tree selecting the optimal path for forwarding data when redundant paths exist. However, this can be overridden using the preferred list. When using the preferred list, the user enters a priority for each bridge, resulting in the selection of the forwarding link.

Limit the wireless client's connections to reduce the total number of hops required to get to the wired network. Use each radio's "preferred" base bridge list to define which AP-5131s the client bridge is allowed to connect to. For more information, see [Configuring Mesh Networking Support on page 9-6](#).

9.1.4 Mesh Networking and the AP-5131's Two Subnets

The AP-5131 now has a second subnet on the LAN side of the system. This means wireless clients communicating through the same radio can reside on different subnets. The addition of this feature adds another layer of complexity to the AP-5131's mesh networking functionality.

With a second LAN introduced, the LAN's Ethernet port (and any of the 16 WLANs) could be assigned to one of two different subnets. From a layer 2 perspective, the system has two different bridge functionalities, each with its own STP. The WLAN assignment controls the subnet (LAN1 or 2) upon which a given connection resides. If WLAN2 is assigned to LAN1, and WLAN2 is used to establish a client bridge connection, then the mesh network connection resides on LAN1.

Therefore, (depending upon the WLAN-to-LAN mapping), the AP-5131 could have multiple mesh connections on either LAN1 or LAN2.

9.1.5 Normal Operation

Once the mesh network is defined, all normal AP-5131 operations are still allowed. MUs are still allowed to associate with the AP-5131 as usual. The user can create WLANs, security policies and VLANs as with any other access point. DHCP services function normally and all layer 3 communications are allowed.

WNMP is used to send information about each mesh network so information can be displayed to the user from any AP-5131 on the system. WNMP messages are AP-AP info messages used to send system status.

9.1.6 Impact of Importing/Exporting Configurations to a Mesh Network

When using the AP-5131's Configuration Import/Export screen to migrate an AP-5131's configuration to other AP-5131s, mesh network configuration parameters will get sent or saved to other AP-5131s.

However, if using the Known AP Statistics screen's Send Cfg to APs functionality, "auto-select" and preferred list" settings do not get imported.



CAUTION When using the Import/Export screen to import a mesh supported configuration, do not import a base bridge configuration into an existing client bridge, as this could cause the mesh configuration to break.

9.2 Configuring Mesh Networking Support

Configuring the AP-5131 for Mesh Bridging support entails:

- [Setting the LAN Configuration for Mesh Networking Support](#)
- [Configuring a WLAN for Mesh Networking Support](#)
- [Configuring the AP-5131 Radio for Mesh Networking Support](#).

9.2.1 Setting the LAN Configuration for Mesh Networking Support

At least one of the two AP-5131 LANs needs to be enabled and have a mesh configuration defined to correctly function as a base or client bridge within a mesh network. This section describes the configuration activities required to define a mesh network's LAN configuration.

As the *Spanning Tree Protocol* (STP) mentions, each mesh network maintains hello, forward delay and max age timers. The base bridge defined as the root imposes these settings within the mesh network. The user does not necessarily have to change these settings, as the default settings will work. However, Symbol encourages the user to define an AP-5131 as a base bridge and root (using the base bridge priority settings within the Bridge STP Configuration screen). Members of the mesh network can be configured as client bridges or additional base bridges with a higher priority value.



NOTE For an overview on mesh networking and some of the implications on using the feature with the AP-5131, see [Configuring Mesh Networking on page 9-1](#).

To define a LAN's Mesh STP Configuration:

1. Select **Network Configuration -> LAN** from the AP-5131 menu tree.
2. Enable the LAN used to support the mesh network.

Verify the enabled LAN is named appropriately in respect to its intended function in supporting the mesh network.

3. Select **Network Configuration -> LAN -> LAN1 or LAN2** from the AP-5131 menu tree.
4. Click the **Mesh STP Configuration** button on the bottom off the screen.
5. Define the properties for the following parameters within the mesh network:



Priority

Set the **Priority** as low as possible for a to force other devices within the mesh network to defer to this client bridge as the bridge defining the mesh configuration (commonly referred to as the root). Symbol recommends assigning a Base Bridge AP with the lowest bridge priority so it becomes the root in the STP. If a root already exists, set the Bridge Priorities of new APs accordingly so the root of the STP doesn't get altered. Each AP-5131 starts with a default bridge priority of 32768.

Maximum Message age

The **Maximum Message age** timer is used with the Message Age timer. The Message Age timer is used to measure the age of the received protocol information recorded for a port, and to ensure the information is discarded when it exceeds the value set for the Maximum Message age timer.

<i>Hello Time</i>	The Hello Time is the time between each bridge protocol data unit sent. This time is equal to 2 seconds (sec) by default, but you can tune the time to be between 1 and 10 sec. If you drop the hello time from 2 sec to 1 sec, you double the number of bridge protocol data units sent/received by each bridge. The 802.1d specification recommends the Hello Time be set to a value less than half of the Max Message age value.
<i>Forward Delay</i>	The Forward Delay is the time spent in the listening and learning state. This time is equal to 15 sec by default, but you can tune the time to be between 4 and 30 sec. The 802.1d specification recommends the Forward Delay be set to a value greater than half the Max Message age timeout value.
<i>Forwarding Table Ageout</i>	The Forwarding Table Parameter value defines the length of time an entry will remain in the a bridge's forwarding table before being deleted due to lack of activity. If the entry replenishments a destination generating continuous traffic, this timeout value will never be invoked. However, if the destination becomes idle, the timeout value represents the length of time that must be exceeded before an entry is deleted from the forwarding table.

6. Click **OK** to return to either the LAN1 or LAN2 screen where updates to the Mesh STP Configuration can be saved by clicking the **Apply** button.
7. Click **Cancel** to discard the changes made to the Mesh STP Configuration and return to the LAN1 or LAN2 screen. Once the Mesh STP Configuration is defined, the AP-5131's radio can be configured for base and/or client bridge support.

9.2.2 Configuring a WLAN for Mesh Networking Support

Each AP-5131 comprising a particular mesh network is required to be a member of the same WLAN. Therefore, each base bridge, client bridge or repeater within the mesh network must use the same WLAN in order to share the same ESSID, radio designation, security policy, MU ACL and Quality of Service policy. If intending to use the AP-5131 for mesh networking support, Symbol recommends configuring at least one WLAN (of the 16 WLANs available) specifically for mesh networking support.

To define the attributes of the WLAN shared by the members of the mesh network:

1. Select **Network Configuration -> Wireless** from the AP-5131 menu tree.

The **Wireless Configuration** screen displays with those existing WLANs displayed within the table.

2. Select the **Create** button to configure a new WLAN specifically to support mesh networking.

An existing WLAN can be modified (or used as is) for mesh networking support by selecting it from the list of available WLANs and clicking the **Edit** button.

New WLAN

Configuration

ESSID: 101

Name: demo room

Available On: 802.11a Radio
 802.11b/g Radio

Maximum MUs: 127

Enable Client Bridge Backhaul

Enable Hotspot [Configure Hotspot](#)

Security

Security Policy: Default [Create](#)

MU Access Control: Default [Create](#)

Kerberos User Name: 101

Kerberos Password:

Advanced

Disallow MU To MU Communication

Use Secure Beacon

Accept Broadcast ESSID

Quality Of Service Policy: Default [Create](#)

[Apply](#) [Cancel](#) [Help](#)

Java Applet Window

3. Assign an **ESSID** and **Name** to the WLAN that each AP-5131 will share when using this WLAN within their mesh network.

Symbol recommends assigning a unique name to a WLAN supporting a mesh network to differentiate it from WLANs defined for non mesh support. The name assigned to the WLAN is what is selected from the **Radio Configuration** screen for use within the mesh network.



NOTE It is possible to have different ESSID and WLAN assignments within a single mesh network (one set between the Base Bridge and repeater and another between the repeater and Client Bridge). However, for ease of management and to not waste network bandwidth, Symbol recommends using the same ESSID across the entire mesh network.

4. Use the **Available On** checkboxes to specify the AP-5131 radio(s) used with the target WLAN within the mesh network.

The Available On checkboxes are for making this WLAN available for base bridges or repeaters to connect to. The Available On checkbox should only be selected for a mesh WLAN if this target AP-5131 is to be configured as a base bridge or repeater on the radio. If the WLAN is to be defined for client bridge support only, the Available On checkbox should not be selected. Instead, it only needs to have the Enable Client Bridge Backhaul option selected.

5. Use the **Maximum MUs** field to define the number of MUs allowed to associate with this WLAN. This number should be defined based on the number of client bridge and repeaters within this mesh network. This value can be increased as the mesh network grows and devices are added.

Only advanced users should define the number of devices allowed to associate with the WLAN, as setting the value too low could restrict devices from joining an expanding mesh network, and setting it too high could prohibit other WLANs from granting access to the all the devices needed.

6. Select the **Enable Client Bridge Backhaul** checkbox to make this WLAN available in the **Mesh Network Name** drop-down menu within the **Radio Configuration** screen. Only WLANs defined for mesh networking support should have this checkbox selected, in order to keep the list of WLANs available (within the Radio Configuration screen) restricted to just WLANs configured specifically with mesh attributes.
7. Refer to the **Security Policy** drop-down menu to select the security policy used within this WLAN and mesh network.

A security policy for a mesh network should be configured carefully since the data protection requirements within a mesh network differ somewhat compared to a typical wireless LAN. **No Encryption** is a bad idea in a mesh network, since mesh networks

are typically not guest networks, wherein public access is more important than data protection. Symbol also discourages user-based authentication schemes such as Kerberos and 802.1x EAP, as these authentication schemes are not supported within a mesh network.

If none of the existing policies are suitable, select the **Create** button to the right of the **Security Policy** drop-down menu and configure a policy suitable for the mesh network. For information on configuring a security using the authentication and encryption techniques available to the AP-5131, see [Enabling Authentication and Encryption Schemes on page 6-5](#).

8. ACL policies should be configured to allow or deny a range of MAC addresses from interoperating with the WLAN used with the mesh network. ACLs should be defined based on the client bridge and repeater (an AP-5131 defined as both a base and client bridge) association requirements within the mesh network.

For information on defining an ACL for use with the WLAN assigned to the mesh network, see [Configuring a WLAN Access Control List \(ACL\) on page 5-31](#).



NOTE The **Kerberos User Name** and **Kerberos Password** fields can be ignored, as Kerberos is not supported as a viable authentication scheme within a mesh network.

9. Select the **Disallow MU to MU Communication** checkbox to restrict MUs from interacting with each other both within this WLAN, as well as other WLANs.

Selecting this option could be a good idea, if restricting device “chatter” improves mesh network performance. If base bridges and client bridges are added at any given time to extent the coverage are of a mesh network, the data going back and forth amongst just those radios could be compromised by network interference. Adding mesh device traffic could jeopardize network throughput. If however, MU to MU communication is central to the organization (for example, scanners sharing data entry information) then this checkbox should remain unselected.

10. Select the **Use Secure Beacon** checkbox to not transmit the AP- 5131's ESSID amongst the AP-5131s and devices within the mesh network. If a hacker tries to find an ESSID via an MU, the AP- 5131's ESSID does not display since the ESSID is not in the beacon. Symbol recommends keeping the option enabled to reduce the likelihood of hacking into the WLAN.
11. Select the **Accept Broadcast ESSID** checkbox to associate an MU that has a blank ESSID (regardless of which ESSID the AP-5131 is currently using). Traffic within a mesh network probably consists of known devices, so you may want to leave the checkbox unselected and configure each MU with an ESSID. The default is selected. However, for WLANs used within a mesh network, Symbol recommends unselecting this option as it would prevent the AP from answering to blank ESSID probes from other mobile units.
12. If there are certain requirements for the types of data proliferating the mesh network, select an existing policy or configure a new QoS policy best suiting the requirements of the mesh network. To define a new QoS policy, select the **Create** button to the right of the Quality Of Service Policy drop-down menu.

For detailed information on configuring a QoS policy, see

[Setting the WLAN Quality of Service \(QoS\) Policy on page 5-34.](#)

13. Click **Apply** to save the changes made to the mesh network configured WLAN.
An AP-5131 radio is now ready to be configured for use with this newly created mesh WLAN.

9.2.3 Configuring the AP-5131 Radio for Mesh Networking Support

An AP-5131 radio intended for use within a mesh network requires configuration attributes unique from a radio intended for non-mesh support. This section describes how to configure an AP-5131 radio for mesh network support.

To configure the AP-5131 radio for mesh networking support:



NOTE The dual-radio model AP-5131 affords users better optimization of the mesh network feature by allowing the AP-5131 to transmit to other AP-5131s (in base or client bridge mode) using one independent radio and transmit with its associated devices using the second independent radio. A single-radio AP-5131 has its channel utilization and throughput degraded in a mesh network, as the AP's single radio must process both mesh network traffic with other AP-5131s and MU traffic with its associated devices.

1. Select **Network Configuration** -> **Wireless** -> **Radio Configuration** from the AP-5131 menu tree.

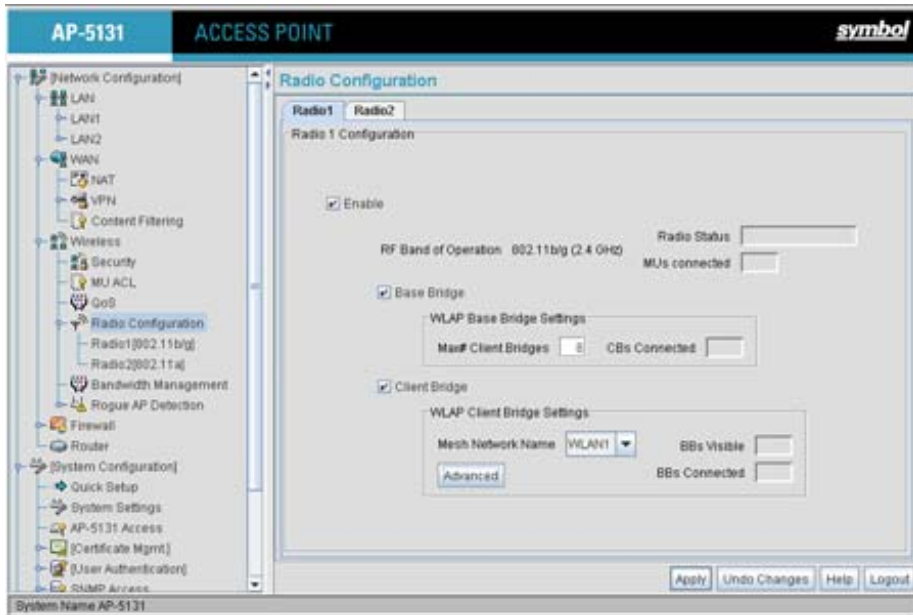

2. Enable the radio(s) using the **Enable** checkbox(es) for both Radio 1 and Radio 2. Refer to **RF Band of Operation** parameter to ensure you are enabling the correct 802.11a or 802.11b/g radio. After the settings are applied within this Radio Configuration screen, the **Radio Status** and **MUs connected** values update. If this is an existing radio within a mesh network, these values update in real-time.



CAUTION If a radio is disabled, be careful not to accidentally configure a new WLAN, expecting the radio to be operating when you have forgotten it was disabled.

3. Select the **Base Bridge** checkbox to allow the AP-5131 radio to accept client bridge connections from other AP-5131s in client bridge mode. The base bridge is the acceptor of

mesh network data from those client bridges within the mesh network and never the initiator.



CAUTION A problem could arise if a Base Bridge's Indoor channel is not available on an Outdoor Client Bridge's list of available channels. As long as an Outdoor Client Bridge has the Indoor Base Bridge channel in its available list of channels, it can associate to the Base Bridge.

4. If the Base Bridge checkbox has been selected, use the **Max# Client Bridges** parameter to define the client bridge load on a particular base bridge.

The maximum number of client bridge connections per AP-5131 radio is 12, with 24 representing the maximum for dual-radio models.



CAUTION An AP-5131 in Base Bridge mode logs out whenever a Client Bridge associates to the Base Bridge over the LAN connection. This problem is not experienced over the AP-5131's WAN connection. If this situation is experienced, log-in to the AP-5131 again.

Once the settings within the Radio Configuration screen are applied (for an initial deployment), the current number of client bridge connections for this specific radio displays within the **CBs Connected** field. If this is an existing radio within a mesh network, this value updates in real-time.

5. Select the **Client Bridge** checkbox to enable the AP-5131 radio to initiate client bridge connections with other mesh network supported AP-5131s radios on the same WLAN.

If the Client Bridge checkbox has been selected, use the **Mesh Network Name** drop-down menu to select the WLAN (ESS) the client bridge uses to establish a wireless link. The default setting, is (WLAN1). Symbol recommends creating (and naming) a WLAN specifically for mesh networking support to differentiate the Mesh supported WLAN from non-Mesh supported WLANs. For more information, see [Configuring a WLAN for Mesh Networking Support on page 9-8](#)

Once the settings within the Radio Configuration screen are applied (for an initial deployment), the current number of base bridges visible to the radio displays within the **BBs Visible** field, and the number of base bridges currently connected to the radio displays within the **BBs Connected** field. If this is an existing radio within a mesh network, these values update in real-time.



NOTE Ensure you have verified the radio configuration for both Radio 1 and Radio 2 before saving the existing settings and exiting the Radio Configuration screen.v

- Click the **Advanced** button to define a prioritized list of access points to define mesh connection links.

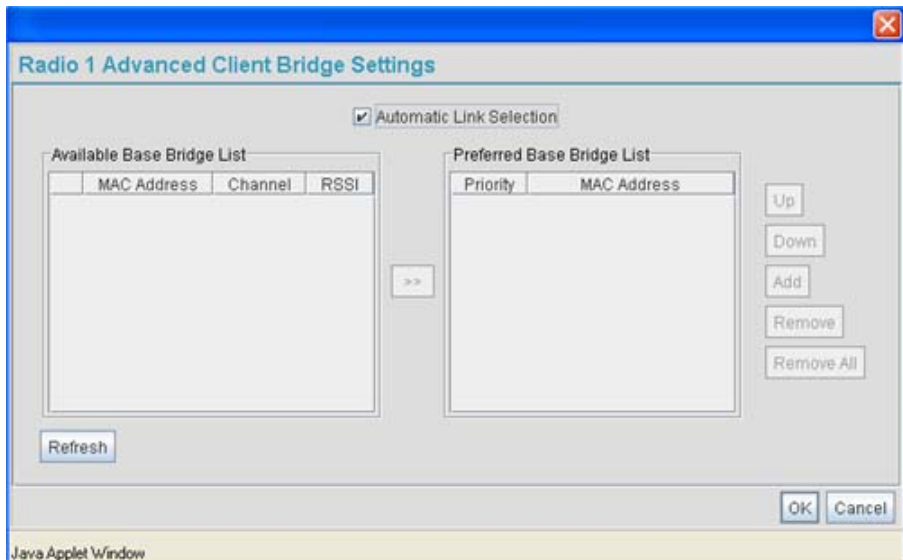

- Select the **Automatic Link Selection** checkbox to allow the AP-5131 to select the links used by the client bridge to populate the mesh network. Selecting this checkbox prohibits

the user from selecting the order base bridges are added to the mesh network when one of the three associated base bridges becomes unavailable.



NOTE Auto link selection is based on the RSSI and load. The client bridge will select the best available link when the **Automatic Link Selection** checkbox is selected. Symbol recommends you do not disable this option, as (when enabled) the AP-5131 will select the best base bridge for connection.

8. Refer to the **Available Base Bridge List** to view devices located by the AP-5131 using the WLAN selected from the Radio Configuration screen. Refer the following for information on located base bridges:

MAC The MAC field displays the factory set hard-coded MAC address that serves as a device identifier.

RSSI The *Relative Signal Strength Indicator* (RSSI) displays the located device's signal strength with the associated AP-5131 in client bridge mode. Use this information as criteria on whether to move a particular device from the available list to the preferred list.

CHANN The CHANN displays the name of the channel that both the AP-5131 and base bridge use. A client bridge can only connect to AP-5131s (Base Bridges) on the same channel. If the user selects multiple base bridges on different channels, the AP-5131 will only be able to connect to those bridges on the same channel and the others will not be able to join this particular mesh network.

9. Click **Refresh** at any time to update the list of available Base Bridge devices available to the AP-5131.
10. Use the >> button to move a selected base bridge MAC address from Available Base Bridge List
11. Refer to the **Preferred Base Bridge List** for a prioritized list of base bridges the mesh network's client bridge uses to extend the mesh network's coverage area and potentially provide redundant links. If a device does not appear on the Available Base Bridge List, there is no way it can be moved to Preferred Base Bridge List as the device has not yet been "seen." However, if you know the MAC Address corresponding to that Base Bridge, you can add that to the Preferred List using the add button.
12. Highlight a MAC address from the Preferred Base Bridge List and click the **Up** button to assign that device's MAC address a higher priority and a greater likelihood of joining the mesh network if an association with another device is lost.

If a MAC address is not desirable as others but still worthy of being on the preferred list, select it, and click the **Down** button to decrease its likelihood of being selected as a member of the mesh network.

13. If a device MAC address is on the Preferred Base Bridge List and constitutes a threat as a potential member of the mesh network (poor RSSI etc.), select it and click the **Remove** button to exclude it from the preferred list.

If all of the members of the Preferred Base Bridge List constitute a risk as a member of the mesh network, click the **Remove All** button. This is not recommended unless the preferred list can be re-populated with more desirable device MAC addresses from the Available Base Bridge List.

14. Click **Ok** to return to the Radio Configuration screen. Within the Radio Configuration screen, click **Apply** to save any changes made within the Advanced Client Bridge Settings screen.
15. Click **Cancel** to undo any changes made within the Advanced Client Bridge Settings screen. This reverts all settings for the screen to the last saved configuration.
16. Click **Apply** to save any changes to the Radio Configuration screen. Navigating away from the screen without clicking Apply results in all changes to the screens being lost.



CAUTION When defining a Mesh configuration and changes are saved, the mesh network temporarily goes down. The mesh network is unavailable because the AP-5131 radio goes down when applying the changes. This can be problematic for users making changes within a deployed mesh network. If updating the mesh network using a LAN connection, the AP-5131 applet loses connection and the connection must be re-instated. If updating the mesh network using a WAN connection, the AP-5131 applet does not lose connection, but the mesh network is unavailable until the changes have been applied.

17. Click **Undo Changes** (if necessary) to undo any changes made. Undo Changes reverts the settings displayed on the Radio Configuration screen to the last saved configuration.
18. Click **Logout** to securely exit the AP-5131 Symbol Access Point applet. A prompt displays confirming the logout before the applet is closed.

Once the target radio has been enabled from the **Radio Configuration** screen, configure the radio's properties by selecting it from the AP-5131 menu tree.

For additional information on configuring the AP-5131's radio, see [Configuring the 802.11a or 802.11b/g Radio on page 5-48](#). For fictional use case involving an AP-5131 mesh network deployment within a shipping and receiving yard, see [Usage Scenario - Trion Enterprises on page 9-18](#).

9.3 Usage Scenario - Trion Enterprises

Trion Enterprises is a new shipping and receiving company. Trion wants to create an outdoor wireless coverage area (in addition to its indoor wireless infrastructure) that can expand as they grow their business. As Trion expands the wireless coverage area within their shipping yard, they will need additional AP-5131s configured as either base or client bridges or repeaters (AP-5131s configured as both base and client bridges) to support the growing number of MUs, and forward data traffic to the client bridges on the outer areas of the mesh network. The MUs within the shipping and receiving area consist primarily of Symbol bar code scanners (to monitor Trion's inventory coming and going) as well as PDAs doing data entry.



NOTE The information presented within this use case is centered around the configuration of the mesh networking feature exclusively. It is assumed the AP-5131s used by Trion Enterprises are completely configured (beyond the mesh networking functionality) before being deployed in their shipping yard.

9.3.1 Trion's Initial Deployment

Trion's initial requirement is to configure a "point-to-point" mesh network consisting of two AP-5131s (AP1 and AP2). AP1 is to be physically connected to a pole inside the entrance to the shipping and receiving area with antennas oriented outward into the shipping yard. AP1 is intended to be a base bridge with no coverage for MUs within the shipping yard. AP2 is intended to be a client bridge associated to AP1 and be placed on a wall of a receiving shack (a remote building in the shipping yard) with antennas oriented into the shipping yard. AP2 also is also connected to a Symbol ES3000 wireless switch providing connectivity (on its own local subnet) to laptops within the receiving shack. AP1 and AP2 will be configured identically unless noted.



NOTE To optimize Trion's mesh network, the IT team decides to create a mesh WLAN to strictly support the base bridge, client bridge and repeater traffic within the mesh network. This is the configuration described in this use case. However, to optimally support the MU traffic within the shipping yard, the Trion team should create a separate (non-mesh) WLAN to support the MU traffic proliferating the shipping yard. To configure the separate (non mesh) WLAN, the IT team follows the instructions in [Creating/Editing Individual WLANs on page 5-24](#).

To configure Trion's initial deployment, the IT Team does the following:

1. The Trion IT department verifies connectivity with both of the AP-5131s following the instructions in [Testing Connectivity on page 3-13](#).
2. The Trion IT Department installs the AP1 on a wall with the antennas orienting outward into the shipping and receiving yard. The team then installs the AP2 on a wall on the receiving shack in the shipping yard.

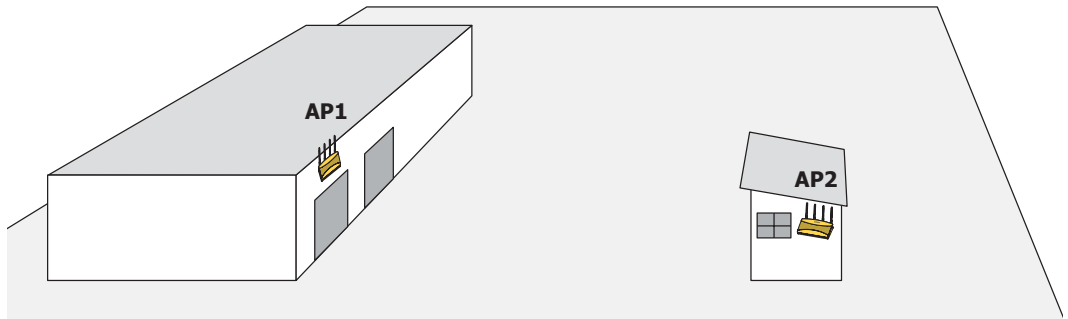

The Trion IT department follows the instructions in [Wall Mounted Installations on page 2-13](#) to install AP1 and AP2.

- The Trion IT department selects **Network Configuration -> LAN** from the AP-5131 menu tree.

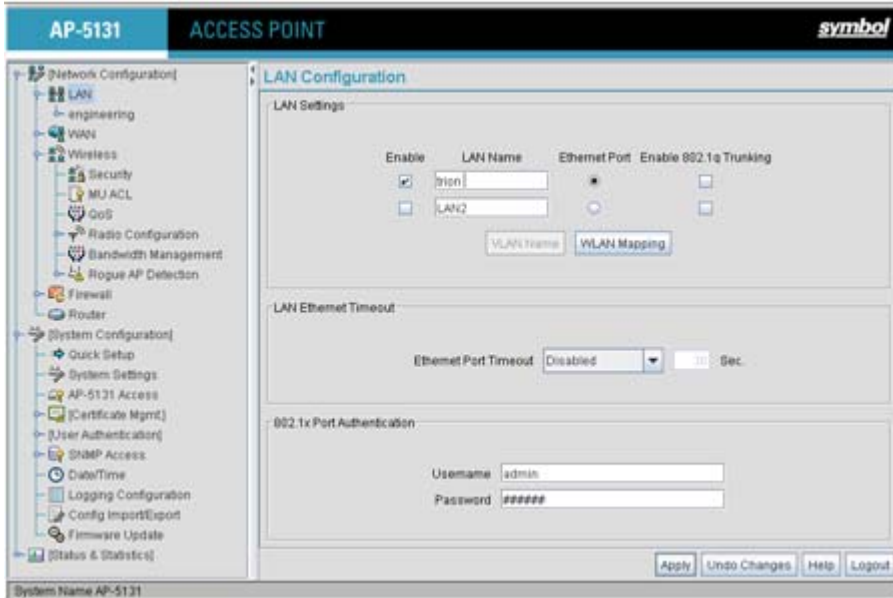

- The Trion IT department verifies the LAN used to support the mesh network is enabled for both AP1 and AP2, (by selecting the **Enable** checkbox).



NOTE

In this fictional mesh network deployment for Trion Enterprises, AP1 and AP2 should both have the AP-5131's Ethernet Port mapped to the mesh LAN. However, there are some scenarios when this is not necessary. For example, when the Ethernet is not connected, or is being used for some other purpose such as routing traffic to the WAN connection.

- The Trion IT department then selects **Network Configuration -> LAN -> trion** from the AP-5131 menu tree.

- The IT team selects the **Mesh STP Configuration** button on the bottom off the screen.



- The Trion IT department sets the **Priority** setting to 1 (for AP1) in order for future members of the mesh network to defer to AP1 as the AP defining the mesh network configuration (setting this value to 1 AP1 to what is commonly referred to as the root).



NOTE AP1 and AP2 have been configured identically up to this point. However, only AP1 is assigned a priority of 1 within the Bridge STP Configuration screen. AP2 is set to a lower priority (100) to keep AP1 as the root.

The IT team leaves the **Maximum Message age** timer at the 20 sec default interval. This setting controls the maximum length of time that passes before a bridge port saves its configuration information. The **Hello Time** (the time between each bridge protocol data unit sent) is also unchanged from 2 second default interval. The IT team also leaves the **Forward Delay** (the time the AP-5131 LAN is spent in a listening and learning state) to the factory default of 15 seconds. Since only one additional AP-5131 is to be added to this point-to-point mesh network, the **Forwarding Table Ageout** value is also unchanged from its 100 second default setting.

- The team clicks **OK** from within the Bridge STP Configuration screen and **Apply** from within the trion (LAN1) screen to save the settings. This step is repeated for AP2.

The Trion IT team now intends to create a WLAN (to use with the trion LAN) that can be dedicated to their mesh network within the shipping yard.

- Select **Network Configuration -> Wireless** from the AP-5131 menu tree.

The **Wireless Configuration** screen displays with those existing WLANs displayed within the table. This is Trion's first deployment for this new dual-radio AP-5131, upon reviewing the Wireless Page they determine the existing default WLAN should be left as is and a new WLAN should be created that can be dedicated to the mesh network supporting the shipping yard.

- The team selects the **Edit** button to revise (and rename) the existing WLAN specifically to support mesh networking.

The screenshot shows a 'New WLAN' configuration window with the following fields and options:

- Configuration:**
 - ESSID: 103
 - Name: trion mesh
 - Available On: 802.11 a Radio, 802.11 b/g Radio
 - Maximum MUs: 127
 - Enable Client Bridge Backhaul
 - Enable Hotspot (with 'Configure Hotspot' button)
- Security:**
 - Security Policy: Default (with 'Create' button)
 - MU Access Control: Default (with 'Create' button)
 - Kerberos User Name: 103
 - Kerberos Password: [Empty field]
- Advanced:**
 - Disallow MU To MU Communication
 - Use Secure Beacon
 - Accept Broadcast ESSID
 - Quality Of Service Policy: Default (with 'Create' button)

Buttons at the bottom: Apply, Cancel, Help.

- The Trion IT team assigns the WLAN a unique ESSID (103) used by each new base bridge, client bridge and repeater joining the mesh network.

12. The team assigns the name of “**trion mesh**” to the WLAN so it will not be confused with other WLANs used in other areas of the Trion facility. This name also serves to associate the name of the WLAN with its intended mesh network utilization of data. entry within the shipping yard
13. For AP1 the team selects the 802.11a checkbox. Enabling the 802.11a radio for the mesh WLAN and configuring a separate WLAN for MU traffic (using the 802.11b/g radio), allows the team the best channel utilization and throughput available since the 802.11a radio can be dedicated strictly to communications within the mesh network and the 802.11b/g radio can be dedicated to servicing the 802.11b/g MUs supporting the shipping and receiving yard.

For AP2, neither the 802.11a or 802.11b/g checkboxes are selected (see the screen displayed above). Only the **Enable Client Bridge Backhaul** checkbox needs to be selected for AP2 (as AP2 will be used as a client bridge).
14. The team does not want any MUs connecting to the mesh WLAN, only the client bridges comprising the mesh network. Therefore, the team leaves the **Maximum MUs** field as is, and will use the Radio Configuration page to control the number of client bridge connections.
15. The team verifies the **Enable Client Bridge Backhaul** checkbox is selected for AP2 to ensure the WLAN is available in the **Mesh Network Name** drop-down menu.

Unlike the user-based Kerberos authentication scheme used within the Trion Administrative office and the 802.1x EAP scheme used in the Finance department, the IT Team wants to configure a security scheme for the WLAN that emphasizes security for the data proliferating the shipping yard, not its user base, as users may come and go whereas the data traffic within the shipping yard remains continuous.
16. The IT Team selects the **Create** button to the right of the **Security Policy** drop-down menu. The New Security Policy screen displays with no authentication or encryption options selected.
17. The IT Team selects the **WPA2/CCMP** radio button.

The **WPA2/CCMP Settings** field displays within the New Security Policy screen.
18. The IT Team assigns a name of “**WPA2 mesh network**” to not only define the security scheme used, but associate this policy with its intended use for the shipping and receiving mesh network.

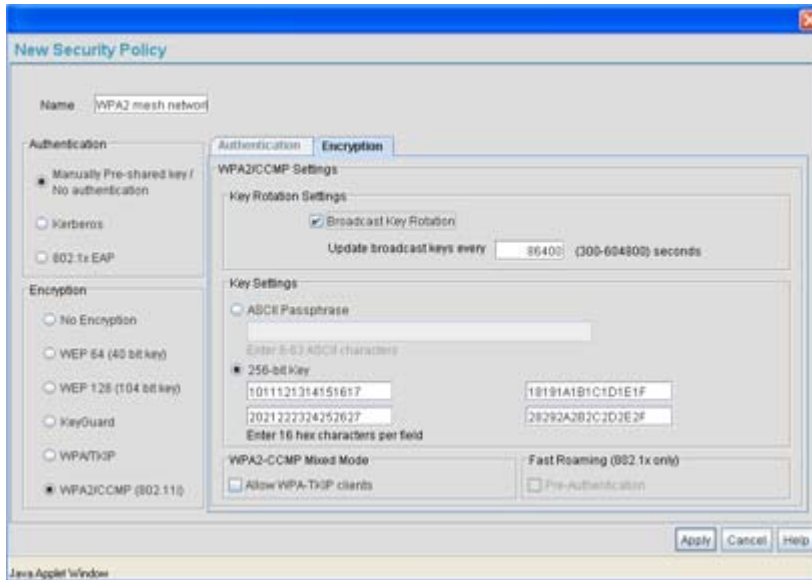

19. The **Broadcast Key Rotation** checkbox is selected, as the IT team plans to change the keys from time to time (for security purposes) and wants these keys to be broadcasted using the default interval 86400 seconds.
20. The IT team does not want to use a passphrase to represent the 256-bit keys, so the **256-bit Key** checkbox is selected, and the team enters 16 hexadecimal characters into each of the four fields displayed. Once completed the Apply button is selected and the AP-5131 applet returns to the WLAN screen.
21. The team leaves the **Allow WPA-TKIP** clients and **Pre-Authentication** checkboxes unselected.

Since the Trion Shipping and Receiving yard is considered a secure wireless network with MU traffic comprised of known 802.11b/g MUs with fixed MAC addresses, the IT team wants to create an ACL that excludes all MU traffic except the known range of Trion Enterprises deployed MAC addresses.

22. From back at the Edit WLAN screen, the IT team selects the **Create** button (to the right of the **MU Access Control** drop-down menu.

The **New MU ACL Policy** screen displays with no existing MAC address ranges.

23. The IT team assigns the name of “**trion mesh network**” to the ACL to eliminate any confusion with the ACLs intended function



24. Since the range of client bridge MAC addresses for the shipping yard mesh network is known to the IT Team, they select the **Deny** drop-down menu option, as the team wants to deny access to all MAC addresses except their own known range of device MAC addresses.
25. The IT team then selects the **Add** button and enters the base bridge MAC address that will be granted access to the AP-5131 managed WLAN. Once completed, the **Apply** button is selected and the AP-5131 applet returns to the WLAN screen.



NOTE If the Trion IT team puts the client bridge addresses into the ACL, they should also put the AP-5131's BSS ID into the ACL since there is no way to know ahead of time which BSS the client bridge will use for association.

Now a QoS policy needs to be defined for the shipping and receiving mesh network WLAN. The IT Team envisions little if any video or voice traffic within the shipping yard as the MUs within primarily scan bar codes and upload data.

26. The team decides to leave the **Disallow MU to MU Communication** checkbox unselected for the WLAN, as the team considers all MU traffic within the secure shipping and receiving yard known and not a threat to the initial 2 AP mesh network deployment.
27. The team selects the **Use Secure Beacon** checkbox from the Edit WLAN screen to not transmit the AP- 5131's ESSID between AP1 and AP2. If a hacker tries to find an ESSID via an MU, the AP- 5131's ESSID does not display since the ESSID is not in the beacon.
28. The team does not select the **Accept Broadcast ESSID** checkbox from the Edit WLAN screen to associate MUs with a blank ESSID, as they do not want MUs randomly joining their carefully constructed mesh network.
29. From the Edit WLAN screen, the IT Team selects the **Create** button to the right of the Quality Of Service Policy drop-down menu.

The **New QoS Policy** screen displays with no values selected.

New QoS Policy

Policy Name:

Support Voice prioritization.

Multicast (Mask)Address1:

Multicast (Mask)Address2:

Enable Wi-Fi Multimedia (WMM) QoS Extensions 11ag-default ▾

Access Category	CW Minimum	CW Maximum	AIFSN	TXOPs Time 32usec	TXOPs Time ms
Background	15	1023	7	0	0.0
Best Effort	15	255	3	20	0.64
Video	7	15	2	94	3.008
Voice	3	7	2	47	1.504

Java Applet Window

30. The IT Team assigns the name of “**mesh network qos**” to the QoS policy to eliminate any confusion with the policy's intended function.

31. The IT Team does not plan on supporting any legacy 802.11b voice enabled devices, so they leave the **Support Voice prioritization** checkbox unselected.
32. The IT Team selects **11ag-default** from the drop-down menu to best describe the type of data proliferating the mesh network. With this setting selected, the Access Category settings do not need to be configured for the QoS policy.
33. The IT Team selects the **Enable Wi-Fi Multimedia (WMM) QoS Extensions** checkbox, and selects the **11ag-default** setting for the intended traffic within the WLAN. If multimedia or voice traffic would have proliferated the WLAN, the team would have selected 11ag-wifi or 11ag-voice. However, since simple data transfers are planned, the 11ag-default setting is appropriate.
34. The IT Team clicks **Apply** within both the New QoS Policy and Edit WLAN screen to save the settings to the mesh network WLAN. The configuration process is repeated and saved for AP2.

The WLAN configuration has now been set similarly for both AP1 and AP2 (with the exception of the Priority setting within the Mesh STP Configuration screen). The team now needs to define the radio configuration for both AP1 and AP2.

35. The IT team selects **Network Configuration -> Wireless -> Radio Configuration** from the AP-5131 menu tree.
The **Radio Configuration** screen displays.
36. For AP1, the IT Team enables both Radio 1 and Radio 2 and defines radio 1 as a base bridge. AP1 is intended to pass along mesh network data to AP2 (as well as other AP-5131s as they are added to the mesh network).

37. For AP2, the IT Team enables both Radio 1 and Radio 2 and defines radio 1 as a client bridge.

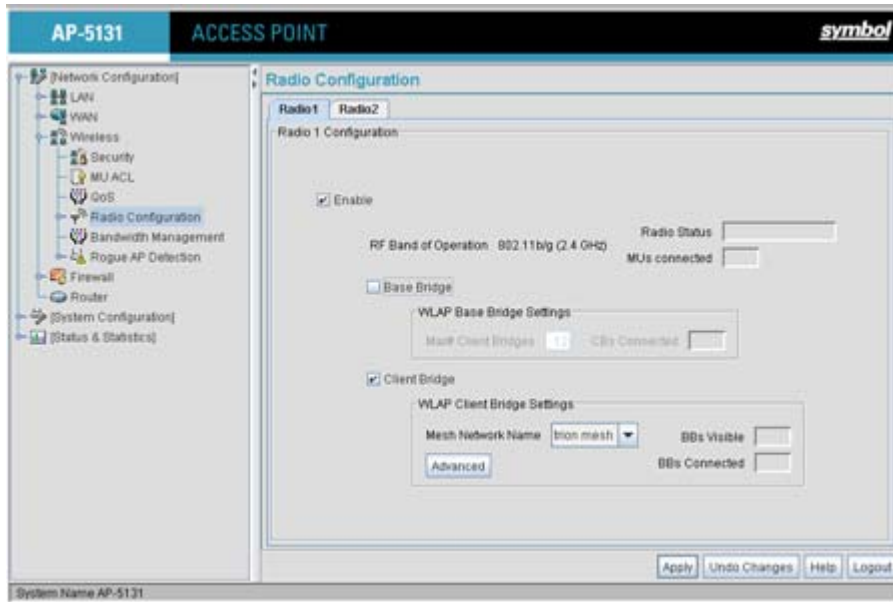

NOTE The Trion IT team is aware it is not a good idea to dedicate both radios (of a dual-radio model AP-5131) to support mesh networking. They know it is possible to dedicate both radios of a single AP-5131 for mesh support, but the Trion team wants to dedicate the 802.11b/g radio for MU operation and the 802.11a radio for backhaul support. For AP2, the Trion team will create two connections to AP1 (one over the 802.11b/g radio and one over the 802.11a radio). The connection used for forwarding data for AP2 will be the 802.11b/g radio and the 802.11a radio will be dedicated for client bridge backhaul.

38. The IT Team leaves each radio's **Max # Client Bridge** setting at the default setting of 12. This ensures as client bridges are added to the growing mesh network they can be accounted for.
39. For AP1 and AP2, the IT Team uses the **Mesh Network Name** drop-down menu to assign the "trion mesh" WLAN to the radio 1 client bridge. This is the WLAN the AP1 and AP2 radios will use to interoperate with the mesh network devices populating the shipping yard.
40. The IT Team decides to not select the **Advanced** button within the AP1 and AP2 WLAN Client Bridge Settings field.

For the next six months, Trion Enterprises' mesh network only consists of AP1 and AP2. AP1 has already been defined as the root bridge in the mesh network when it was assigned a Priority value of 1 within the Bridge STP Configuration screen.

41. The Trion IT Team clicks **Apply** within both the AP1 and AP2 Radio Configuration screens to complete the mesh network configuration of each AP1 and AP2 radio. The team does not worry about network disruption by applying the settings at this point, as AP1 and AP2 have not yet been deployed. However, in the future they are aware saving their mesh configuration will temporarily disrupt service within their mesh network.



NOTE With the mesh network configuration completed for AP1 and AP2, the Trion Enterprises IT team completes the configuration of the APs following the instructions in this *AP-5131 Product Reference Guide*. Later in the year Trion expects to grow their business to the point where 2 new client bridges are required to provide mesh networking to new areas of their shipping yard. See, [Adding 2 Client Bridges to Expand the Coverage Area on page 9-29](#).

9.3.2 Adding 2 Client Bridges to Expand the Coverage Area

After a prosperous six months with their existing 2 AP-5131 mesh network, Trion Enterprises needs and approves the addition of two additional AP-5131s (AP3 and AP4) to be configured as repeaters (both client and base bridges). Configuring AP3 and AP4 as repeaters entails configuring an AP3 and an AP4 radio as both a client bridge and a base bridge.

To configure AP3 and AP4 as repeaters, the IT Team does the following:

1. The Trion IT department verifies connectivity with AP3 and AP4 following the instructions in [Testing Connectivity on page 3-13](#).
2. The Trion IT Department installs AP3 and AP4 on light poles (in the middle of the shipping yard) where power is available and a secure mesh network (AP1 and AP2) is already within

broadcast range (see the illustration below). The Trion IT department follows the instructions in [Wall Mounted Installations on page 2-13](#) to install AP3 and AP4.

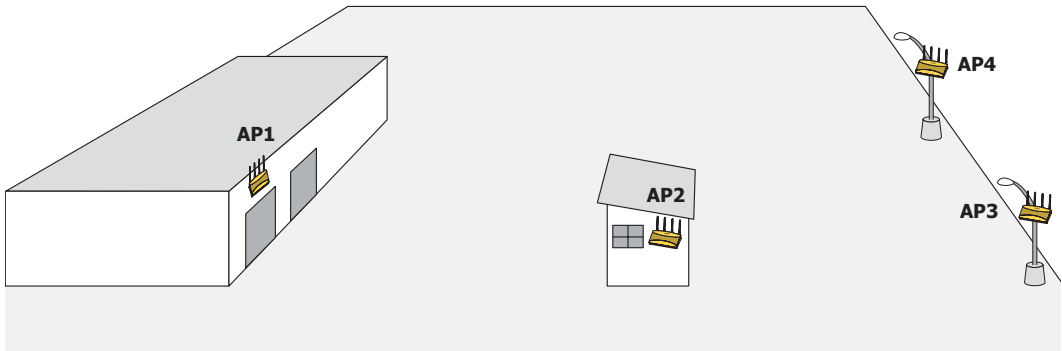

- The Trion IT department selects **Network Configuration -> LAN** from the AP-5131 menu tree.

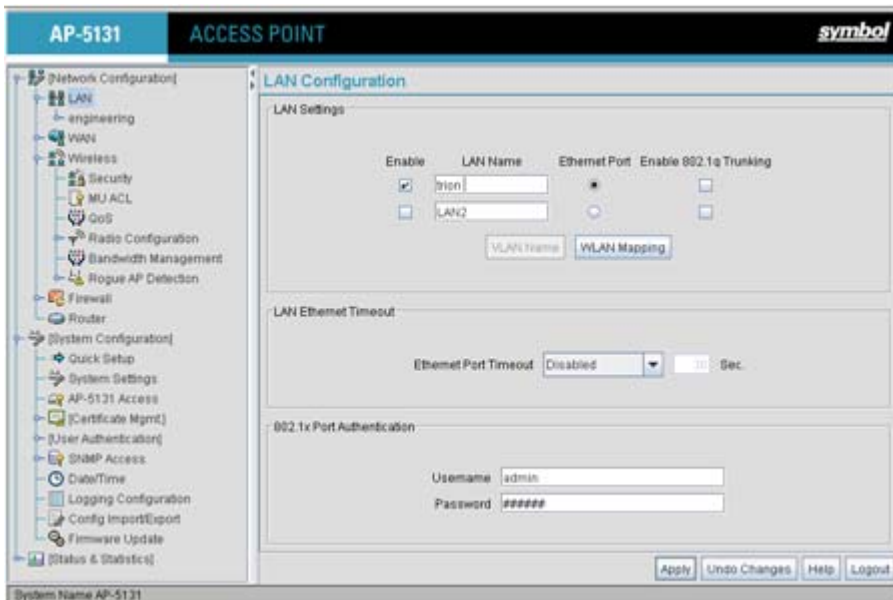

- The Trion IT department verifies the LAN used to support the mesh network is enabled for both AP3 and AP4, (by selecting the **Enable** checkbox).

5. The Trion IT department then selects **Network Configuration -> LAN -> trion** from the AP-5131 menu tree.
6. The IT team selects the **Mesh STP Configuration** button on the bottom of the screen.
7. The Trion IT department leaves the **Priority** setting to at 32768 for AP3 and AP4 for both to defer to AP1 (which was assigned a priority of 1 for root designation) as the AP-5131 defining the mesh network configuration.



The remainder of the Mesh STP Configuration settings are left unchanged from their default values. The team clicks **OK** from within the Mesh STP Configuration screen and **Apply** from within the trion (LAN1) screen to save the settings.

The Trion IT team now intends to assign WLANs (to use with the trion LAN) that can be dedicated to their mesh network within the shipping yard.

8. The team selects **Network Configuration -> Wireless** from the AP-5131 menu tree. The **Wireless Configuration** screen displays with those existing WLANs displayed within the table. Since this is Trion's first deployment for AP3 and AP4, the IT department determines the existing default WLAN should be left as is, and a new WLAN should be configured closely resembling the mesh network WLAN defined for AP1 and AP2.

9. The team selects the **Edit** button to revise (and rename) the existing default WLAN to support mesh networking.

New WLAN

Configuration

ESSID: 103

Name: trion mesh

Available On: 802.11a Radio
 802.11b/g Radio

Maximum MUs: 127

Enable Client Bridge Backhaul

Enable Hotspot

Security

Security Policy: Default

MU Access Control: Default

Kerberos User Name: 103

Kerberos Password:

Advanced

Disallow MU To MU Communication

Use Secure Beacon

Accept Broadcast ESSID

Quality Of Service Policy: Default

Java Applet Window

10. The Trion IT team assigns AP3 and AP4 an ESSID of 103. Therefore, AP1 and AP2 should be able to “see” AP3 and AP4 as soon as they are deployed.
11. The team assigns the name of “**trion mesh**” to the WLAN to be consistent with the WLAN supporting mesh networking on AP1 and AP2.
12. The team selects the 802.11a Radio checkbox for both AP3 and AP4. Like AP1, the 802.11b/g radios will be used to service MUs on a different WLAN, thus segregating MU traffic from the mesh traffic proliferating the 802.11a radio.

13. The team does not want any MUs connecting to the mesh WLAN, only the devices comprising the mesh network. Therefore, the team leaves the **Maximum MUs** field as is, and will use the Radio Configuration page to control the number of client bridge connections.
14. The team verifies the **Enable Client Bridge Backhaul** checkbox is selected for both AP3 and AP4 to ensure the WLAN is available in the **WLAN** drop-down menu within the **Radio Configuration** screen.
15. The IT team then verifies that steps 10 through 14 have been carried out identically for both AP3 and AP4.

The IT team now needs to define a security policy for AP3 and AP4 complimentary with the policy created for AP1 and AP2 to both protect the data within the mesh network and ensure all 4 AP-5131s within the network can interact with one another.

16. The IT Team selects the **Create** button to the right of the **Security Policy** drop-down menu and defines a WPA2/CCMP supported security policy exactly like the one created for AP1 and AP2. For more information, see how the team defined the security policy starting on step 16 within [Trion's Initial Deployment on page 9-18](#).

It is assumed all of the existing MU traffic defined for AP1 and AP2 will also be used in the extended coverage area for AP3 and AP4 with no known additions to the MU traffic at this time. Thus the IT team refers to the ACL created for AP1 and AP2 and defines an ACL exactly like it for AP3 and AP4.

17. The team selects the **Create** button (to the right of the **MU Access Control** drop-down menu and defines an ACL policy like the one created for AP1 and AP2. The team also remembers to go to the AP1 ACL and add AP3 and AP4 to the list of devices allowed to connect to AP1.

For more information, see how the team defined the ACL policy starting on step 22 within [Trion's Initial Deployment on page 9-18](#).

18. The team decides to leave the **Disallow MU to MU Communication** checkbox unselected for the mesh WLAN for AP3 and AP4, as the team still considers all MU traffic within the shipping yard known and not a threat to the growing mesh network.
19. The team selects the **Use Secure Beacon** checkbox from the Edit WLAN screen to not transmit the AP- 5131's ESSID between APs 1 through 4. If a hacker tries to find an ESSID via an MU, the AP- 5131's ESSID does not display since the ESSID is not in the beacon.
20. The team does not select the **Accept Broadcast ESSID** checkbox, as they still do not want MUs randomly joining their carefully constructed mesh network.

21. Now a QoS policy needs to be defined for the shipping and receiving mesh WLAN. The IT Team still envisions little (if any) video or voice traffic within the shipping as the MUs within primarily scan bar codes and upload data. This holds true for the QoS requirements for AP3 and AP4 as the required coverage area has grown, not the security, access permission or QoS considerations. For more information, see how the team defined the AP1 and AP2 QoS policy starting on step 25 within [Trion's Initial Deployment on page 9-18](#).

The WLAN configuration has now been set for both AP3 and AP4. The team now needs to define the radio configurations for AP3 and AP4.

22. The IT team selects **Network Configuration** -> **Wireless** -> **Radio Configuration** from the AP-5131 menu tree.

The **Radio Configuration** screen displays.

23. For both AP3 and AP4, the IT Team enables Radio 1 and defines the radio as a repeater (enabling each radio as both a base and client bridge).

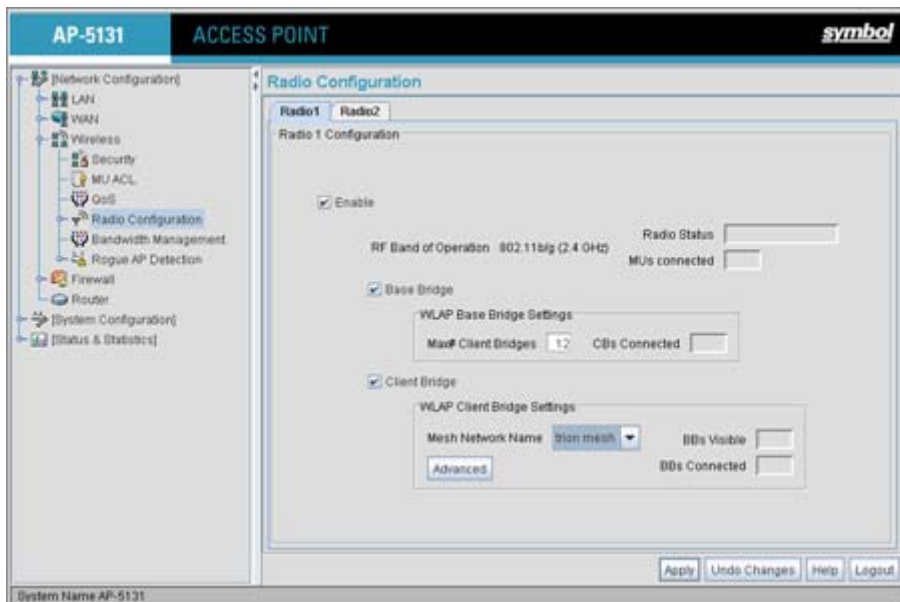

Both AP3 and AP4 are intended to pass along mesh network back data to AP1 and support the 802.11b/g MUs within the shipping yard.

24. The IT Team leaves each radio's **Max # Client Bridge** setting at the default setting of 12. This ensures as client bridges are added to the growing mesh network that they can be accounted for.

25. For both AP3 and AP4, the IT Team uses the **Mesh Network Name** drop-down menu to assign the “**trion mesh**” WLAN to radio 1. This is the WLAN the AP3 and AP4 radios will use to interoperate with the MUs populating the shipping yard.
26. As with AP1 and AP2, the IT Team decides to not select the **Advanced** button within the AP3 and AP4 WLAP Client Bridge Settings field.
27. The Trion IT Team clicks **Apply** within both the AP3 and AP4 Radio Configuration screens to complete the mesh network configuration of each AP3 and AP4 radio.

For the next 9 months, the Trion Enterprises’ mesh network consists of AP1 and AP2 and now AP3 and AP4 extending the mesh coverage range further into the shipping yard. AP1 is still the root bridge in the mesh network. The IT Team will appraise their mesh requirements in another 9 months and (if necessary) add additional AP-5131s and MUs to the mesh network.

9.3.3 Adding 2 More Client Bridges to the Trion Network

After an additional six months with their existing 4 AP-5131 mesh network, Trion Enterprises needs and approves the addition of two additional AP-5131s (AP5 and AP6) to be configured as client bridges. The team will configure AP5 and AP6 as client bridges and not base bridges or repeaters since Trion Enterprises does not plan to expand its shipping yard and the mesh network would have all the AP-5131s needed to support it. Thus, one AP5 and AP6 radio will be providing mesh coverage to the outer portion of the shipping yard without having to provide base bridge or repeater support to new members of the mesh network. The remaining AP5 and AP6 radio can support shipping yard MU traffic using a non-mesh WLAN.

To configure AP5 and AP6 as client bridges, the IT Team does the following:

1. The Trion IT department verifies connectivity with AP5 and AP6 following the instructions in [Testing Connectivity on page 3-13](#).
2. The Trion IT Department installs AP5 and AP6 on light poles (in a new expanded area of the shipping yard) where power has been made available and a secure mesh network (APs 1-4) is within broadcast range (see the illustration below). The Trion IT department follows the instructions in [Wall Mounted Installations on page 2-13](#) to install AP5 and AP6.

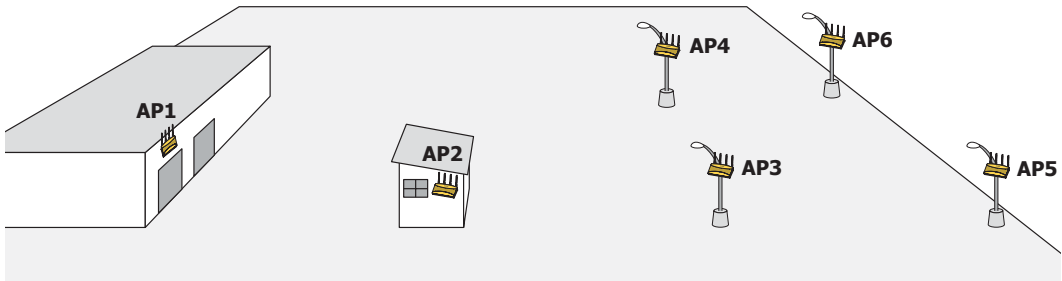

- The Trion IT department selects **Network Configuration -> LAN** from the AP-5131 menu tree.

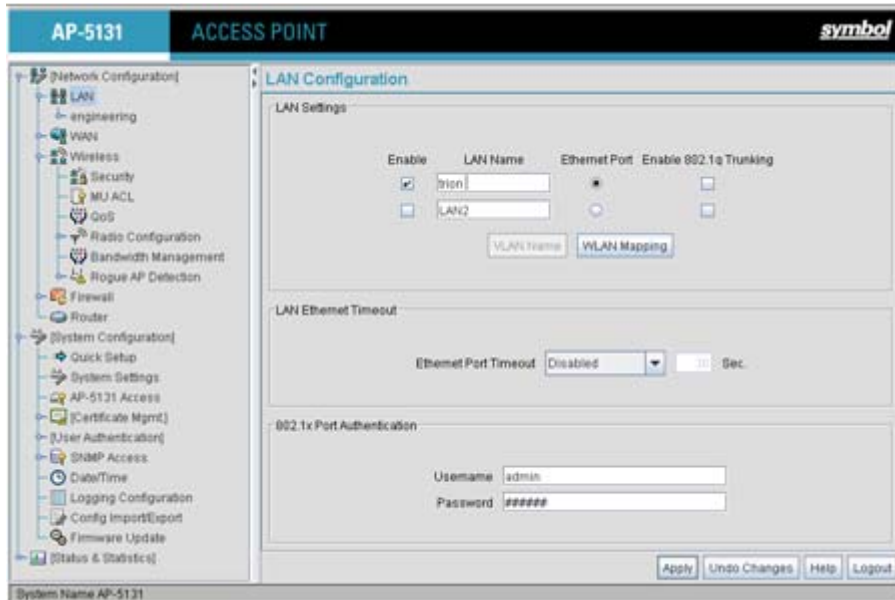

- The Trion IT department verifies the LAN used to support the mesh network is enabled for both AP5 and AP6, (by selecting the **Enable** checkbox).
- The Trion IT department then selects **Network Configuration -> LAN -> trion** from the AP-5131 menu tree.
- The IT team selects the **Mesh STP Configuration** button on the bottom of the screen.

7. The Trion IT department leaves the **Priority** setting to at 32768 for AP5 and AP6 for both to defer to AP1 (which was assigned a priority of 1 for root designation) as the AP-5131 defining the mesh network configuration.



The remainder of the Mesh STP Configuration settings are left unchanged from their default values. The team clicks **OK** from within the Mesh STP Configuration screen and **Apply** from within the trion (LAN1) screen to save the settings.

The Trion IT team now intends to assign WLANs (to use with the trion LAN) that can be dedicated to their mesh network within the shipping yard.

8. The team selects **Network Configuration -> Wireless** from the AP-5131 menu tree. The **Wireless Configuration** screen displays with those existing WLANs displayed within the table. Since this is Trion's first deployment for AP5 and AP6, the IT department determines the existing default WLAN should be left as is, and a new WLAN should be configured resembling the mesh network WLAN defined for APs 1-4.

9. The team selects the **Edit** button to revise (and rename) the existing default WLAN to support mesh networking.

New WLAN

Configuration

ESSID: 103

Name: trion mesh

Available On: 802.11a Radio
 802.11b/g Radio

Maximum MUs: 127

Enable Client Bridge Backhaul

Enable Hotspot

Security

Security Policy: Default

MU Access Control: Default

Kerberos User Name: 103

Kerberos Password:

Advanced

Disallow MU To MU Communication

Use Secure Beacon

Accept Broadcast ESSID

Quality Of Service Policy: Default

Java Applet Window

10. The Trion IT team assigns the WLAN an ESSID of 103 to be consistent with the trion mesh WLAN ESSID of the other four AP-5131s within the mesh network.
11. The team assigns the name of **"trion mesh"** to the WLAN to be consistent with the WLAN supporting mesh on APs 1-4.
12. The team selects the 802.11a Radio checkbox for both AP5 and AP6. The 802.11b/g radio on both AP5 and AP6 will be used to service MUs (on a different WLAN). Thus, MU traffic will be segregated from the mesh traffic proliferating each AP's 802.11a radio.

13. The team still does not want any MUs connecting to the mesh WLAN, only the devices comprising the mesh network. Therefore, the team leaves the **Maximum MUs** field as is, and will use the Radio Configuration page to control the number of client bridge connections within the mesh WLAN.
14. The team verifies the **Enable Client Bridge Backhaul** checkbox is selected for both AP5 and AP6 to ensure the WLAN is available in the **WLAN** drop-down menu within the **Radio Configuration** screen.
15. The IT team then verifies that steps 10 through 14 have been carried out identically for both AP5 and AP6.

The IT team now needs to define a security policy for AP5 and AP4 complimentary with the policy created for APs 1-4.
16. The IT Team defines a WPA2/CCMP security policy exactly like the one created for APs 1-4. For more information, see how the team initially defined the security policy starting on step 16 within [Trion's Initial Deployment on page 9-18](#).
17. Existing MU traffic within the mesh network will be used within the expanded shipping yard. Thus, the IT team refers to the ACLs created for APs 1-4 and defines an ACL exactly like it for AP5 and AP6. The team also remembers to go to the ACL for AP1, AP3 and AP4 and add AP5 and AP6 in order for each device in the mesh network to communicate with one another. For more information, refer to step 22 within [Trion's Initial Deployment on page 9-18](#).
18. The team decides to leave the **Disallow MU to MU Communication** checkbox unselected for AP5 and AP6, as the team still considers all MU traffic within the shipping yard known and not a threat to the growing mesh network.
19. The team selects the **Use Secure Beacon** checkbox from the Edit WLAN screen to not transmit the AP- 5131's ESSID between APs 1 through 6. If a hacker tries to find an ESSID via an MU, the AP- 5131's ESSID does not display since the ESSID is not in the beacon.
20. The team does not select the **Accept Broadcast ESSID** checkbox, as they still do not want MUs randomly joining their carefully constructed mesh network.
21. The IT Team still envisions little (if any) video or voice traffic within the shipping as the MUs within primarily scan bar codes and upload data. This still holds true for the QoS requirements for AP5 and AP6, as the required coverage area has continued to grow, but not the security, access permissions or QoS considerations. For more information, see how the team defined the QoS policy for APs 1-4 starting on step 25 within [Trion's Initial Deployment on page 9-18](#).

The team now needs to define the radio configurations for AP5 and AP6.

22. The IT team selects **Network Configuration** -> **Wireless** -> **Radio Configuration** from the AP-5131 menu tree.

The **Radio Configuration** screen displays.

23. For both AP5 and AP6, the IT Team enables Radio 1 and defines the radio as a client bridge.

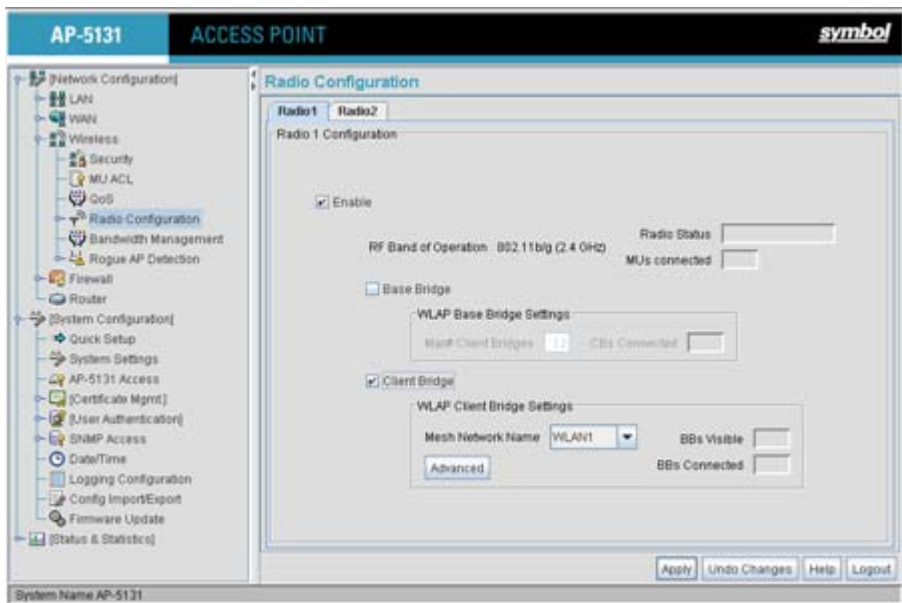

24. For both AP5 and AP6, the IT Team uses the **Mesh Network Name** drop-down menu to assign the “**trion mesh**” WLAN to radio 1.
25. As with APs 1-4, the IT Team decides to not select the **Advanced** button within the WLAN Client Bridge Settings field.
26. The Trion IT Team clicks **Apply** within both the AP5 and AP6 Radio Configuration screens to complete the mesh network configuration of each AP5 and AP6 radio.

For the foreseeable future, the Trion Enterprises’ mesh network will consist of APs 1-6. AP1 remains the root bridge in the mesh network. If the physical radio coverage area requirements of the mesh network were to grow, AP5 and AP6 would have to be changed from client bridges to repeaters to associate with the new APs required to extent the coverage area. But for now, the 802.11a radio of both AP5 and AP6 can remain defined as a client bridge to support the outer fringes of the Trion Enterprises shipping yard.



Technical Specifications

This appendix provides technical specifications in the following areas:

- *Physical Characteristics*
- *Electrical Characteristics*
- *Radio Characteristics*
- *Antenna Specifications*
- *Country Codes*

A.1 Physical Characteristics

The AP-5131 has the following physical characteristics:

<i>Dimensions</i>	5.32 inches long x 9.45 inches wide x 1.77 inches thick. 135 mm long x 240 mm wide x 45 mm thick.
<i>Housing</i>	Metal, Plenum Housing (UL2043)
<i>Weight</i>	1.95 lbs/0.88 Kg (single-radio model) 2.05 lbs/0.93 Kg (dual-radio model)
<i>Operating Temperature</i>	-20 to 50° Celsius
<i>Storage Temperature</i>	-40 to 70° Celsius
<i>Altitude</i>	8,000 feet/2438 m @ 28° Celsius (operating) 15,000 feet/4572 m @ 12° Celsius (storage)
<i>Vibration</i>	Vibration to withstand .02g ² /Hz, random, sine, 20-2k Hz
<i>Humidity</i>	5 to 95% (operating) 5 to 85% (storage)
<i>Electrostatic Discharge</i>	15kV (air) @ 50% rh 8kV (contact) @ 50% rh
<i>Drop</i>	Bench drop 36 inches to concrete (excluding side with connectors)

A.2 Electrical Characteristics

The AP-5131 has the following electrical characteristics:

<i>Operating Voltage</i>	48Vdc (Nom)
<i>Operating Current</i>	200mA (Peak) @ 48Vdc 170mA (Nom) @ 48Vdc

A.3 Radio Characteristics

The AP-5131 has the following radio characteristics:

<i>Operating Channels</i>	802.11a radio - Channels 34-161 (5170-5825 MHz)	
	802.11b/g radio - Channels 1-13 (2412-2472 MHz)	
	802.11b/g radio - Channel 14 (2484 MHz Japan only)	
	<i>Actual operating frequencies depend on regulatory rules and certification agencies.</i>	
<i>Receiver Sensitivity</i>	802.11a Radio	802.11b/g Radio
	6 Mbps -88	11 Mbps -84
	9 Mbps -87	5.5 Mbps -88
	12 Mbps -85	2 Mbps -90
	18 Mbps -81	1 Mbps -94
	24 Mbps -79	
	36 Mbps -75	
	48 Mbps -70	
	54 Mbps -68	
	<i>* all values in dBm</i>	
<i>Radio Data Rates</i>	802.11a radio 6, 9, 12, 18, 24, 36, 48, and 54 Mbit/Sec	
	802.11g radio 6, 9, 12, 18, 24, 36, 48, and 54 Mbit/Sec	
	802.11b radio 1, 2, 5.5, 11 Mbps	
<i>Wireless Medium</i>	Direct Sequence Spread Spectrum (DSSS)	
	Orthogonal Frequency Division Multiplexing (OFDM)	

A.4 Antenna Specifications

The AP-5131 antenna suite has the following specifications:



CAUTION Using an antenna other than the Dual-Band Antenna (Part No. ML-2452-APA2-01) could render the AP-5131's Rogue AP Detector Mode feature inoperable. Contact your Symbol sales associate for specific information.

A.4.1 2.4 GHz Antenna Matrix

The following table describes each 2.4 GHz antenna approved for use with the AP-5131.

Symbol Part Number	Antenna Type	Nominal Net Gain (dBi)
ML-2499-11PNA2-01R	Wide Angle Directional	8.5
ML-2499-HPA3-01R	Omni-Directional Antenna	3.3
ML-2499-BYGA2-01R	Yagi Antenna	13.9
ML-2452-APA2-01	Dual-Band	3.0

A.4.2 5.2 GHz Antenna Matrix

The following table describes each 5.2 GHz antenna approved for use with the AP-5131.

Symbol Part Number	Antenna Type	Nominal Net Gain (dBi)
ML-5299-WPNA1-01R	Panel Antenna	13.0
ML-5299-HPA1-01R	Wide-Band Omni-Directional Antenna	5.0
ML-2452-APA2-01	Dual-Band	4.0

A.4.3 Additional Antenna Components

The following table lists the Symbol part number for various antenna accessories. This table also includes the loss for each accessory at both 2.4 and 5.2 GHz.

Item	Symbol Part Number	Description	Loss (db) @ 2.4 GHz	Loss (db) @ 5.2 GHz
72PJ	ML-1499-72PJ-01R	Cable Extension	2.5	
LAK1	ML-1499-LAK1-01R	Lightning Arrestor+	0.75	
LAK2	ML-1499-LAK2-01R	Lightning Arrestor	0.25	
10JK	ML-1499-10JK-01R	Jumper Kit	0.75	1.6
25JK	ML-1499-25JK-01R	Jumper Kit	1.9	3.5
50JK	ML-1499-50JK-01R	Jumper Kit	3.75	6.6
100JK	ML-1499-100JK-01R	Jumper Kit	7.5	12.8

A.4.4 Antenna Accessory Connectors, Cable Type and Length

The following table describes each antenna accessory's connector and cable type, plus the length.

Item	Connector1	Connector2	Length (meters)	Cable Type
72PJ	RPBNC-F	RPBNC-M	1.83	RG-58
LAK1	RPBNC-F	N-F	0.305	RG-58
LAK2	N-F	N-M		
10JK	N-M	N-M	3.05	RG-8
25JK	N-M	N-M	7.62	RG-8
50JK	N-M	N-M	15.24	RG-8
100JK	N-M	N-M	30.48	RG-8

A.5 Country Codes

The following list of countries and their country codes is useful when using the AP-5131 configuration file, CLI or the MIB to configure the AP-5131:

<i>Country</i>	<i>Code</i>	<i>Country</i>	<i>Code</i>
Argentina	AR	New Zealand	NZ
Australia	AU	Norway	NO
Austria	AT	Oman	OM
Bahrain	BH	Peru	PE
Belarus	BY	Philippines	PH
Belgium	BE	Poland	PL
Brazil	BR	Portugal	PT
Bulgaria	BG	Qatar	QA
Canada	CA	Romania	RO
Chile	CL	Russian Federation	RU
China	CN	Saudi Arabia	SA
Colombia	CO	Singapore	SG
Costa Rica	CR	Slovak Republic	SK
Croatia	HR	Slovenia	SI
Cyprus	CY	South Africa	ZA
Czech Rep.	CZ	South Korea	KR
Denmark	DK	Spain	ES
Ecuador	EC	Sri Lanka	LK
Estonia	EE	Sweden	SE
Egypt	EG	Switzerland	CH
Finland	FI	Taiwan	TW
France	FR	Thailand	TH

Germany	DE	Turkey	TR
Greece	GR	Ukraine	UA
Hong Kong	HK	UAE	AE
Hungary	HU	United Kingdom	UK
Iceland	IS	USA	US
India	IN	Uruguay	UY
Indonesia	ID	Vietnam	VN
Ireland	IE	Venezuela	VE
Israel	IL		
Italy	IT		
Japan	JP		
Jordan	JO		
Kazakhstan	KZ		
Kuwait	KW		
Latvia	LV		
Liechtenstein	LI		
Lithuania	LT		
Luxembourg	LU		
Malaysia	MY		
Malta	MT		
Mexico	MX		
Morocco	MA		
Nambia	NA		
Netherlands	NL		

AP-5131 Usage Scenarios

This appendix provides practical usage scenarios for many of the AP-5131's key features. This information should be referenced as a supplement to the information contained within this AP-5131 Product Reference Guide.

The following scenarios are described:

- [*Configuring Automatic Updates using a DHCP or Linux BootP Server Configuration*](#)
- [*Configuring an IPSEC Tunnel and VPN FAQs*](#)

B.1 Configuring Automatic Updates using a DHCP or Linux BootP Server Configuration

This section provides specific details for configuring either a DHCP or Linux BootP Server to send firmware or configuration file updates to an AP-5131.

The AutoUpdate feature updates the AP-5131 firmware and configuration automatically when the AP-5131 is reset or when the AP-5131 does a DHCP discovery.

The firmware is automatically updated each time firmware versions are found to be different between the AP-5131 and the firmware file located on the DHCP/BootP server. The configuration file is automatically applied only if the filename is different than what resides on the AP-5131.

B.1.1 Windows - DHCP Server Configuration

See the following sections for information on these DHCP server configurations in the Windows environment:

- [Embedded Options - Using Option 43](#)
- [Global Options - Using Extended/Standard Options](#)
- [DHCP Priorities](#)

B.1.1.1 Embedded Options - Using Option 43

This section provides instructions for automatic update of firmware and configuration file via DHCP using extended options or standard options configured globally.

The setup example described in this section includes:

- 1 AP-5131
- 1 Microsoft Windows DHCP Server
- 1 TFTP Server

Note the following caveats regarding this procedure before beginning:

- Ensure the LAN Interface is configured as a DHCP Client
- If the existing and update firmware files are the same, the firmware will not get updated.

To configure the DHCP Server for automatic updates:

1. Set the Windows DHCP Server and AP-5131 on the same Ethernet segment.
2. Configure the Windows based DHCP Server as follows:
 - a. Highlight the Server Domain Name (for example, apfw.symbol.com). From the **Action** menu, select **Define Vendor Classes**.
 - b. Create a new vendor class. For example, AP5131 Options.
 - c. Enter the Vendor Class Identifier **SymbolAP.5131-V1-1**. Enter the value in ASCII format, the server converts it to hex automatically.
 - d. From the **Action** menu, select **Set Predefined Options**.

e. Add the following 3 new options under AP5131 Options class:

	Code	Data type
AP-5131 TFTP Server IP Address	181	IP address
(Note: Use any one option)	186	String
AP-5131 Firmware File Name	187	String
AP5131 Config File Name	129	String
(Note: Use any one option)	188	String

f. Highlight **Scope Options** from the tree and select **Configure Options**.

g. Go to the **Advanced** tab. From under the Vendor Class AP5131 Options, check all three options mentioned in the table above and enter a value for each option.

3. Copy the firmware and configuration files to the appropriate directory on the TFTP Server. By default, auto update is enabled on the AP-5131 (since the LAN Port is a DHCP Client, out-of-the-box auto update support is on the LAN Port).
4. Restart the AP-5131.
5. While the AP-5131 boots, verify the AP-5131:
 - Obtains and applies the expected IP Address from the DHCP Server
 - Downloads both the firmware and configuration files from the TFTP Server and updates both as needed. Verify the file versions at the AP-5131's **System Settings** screen.



NOTE If the firmware files are the same, the firmware will not get updated. If the configuration file name matches the last saved configuration file on the AP-5131, the configuration will not get updated.

B.1.1.2 Global Options - Using Extended/Standard Options

The following are instructions for automatic firmware and configuration file updates via DHCP using extended options or standard options configured globally.

The setup example described in this section includes:

- 1 AP-5131
- 1 Microsoft Windows DHCP Server
- 1 TFTP Server.

To configure Global options using extended/standard options:

1. Set the Windows DHCP Server and AP-5131 on the same Ethernet segment.
2. Configure the Windows based DHCP Server as follows:
 - a. Highlight the Server Domain Name (for example, apfw.symbol.com). From the **Action** menu, select **Set Predefined Options**.
 - b. Add the following 3 new options under **DHCP Standard Options** class:

Extended Options	Code	Data type
AP-5131 TFTP Server IP Address	181	IP address
(Note: Use any one option)	186	String
AP-5131 Firmware File Name	187	String
AP5131 Config File Name	129	String
(Note: Use any one option)	188	String

Standard Options	Code	Data type
AP-5131 TFTP Server IP Address	66	String
AP-5131 Firmware File Name	67	String



NOTE If using Standard Options and the configuration of the AP-5131 needs to be changed, use option 129 or 188 as specified in the Extended Options table. Standard options 66 and 67 are already present in the DHCP Standard Options Class by default.

- c. Highlight **Scope Options** and select **Configure Options**.

- d. Under the **General** tab, check all 3 options mentioned within the Extended Options table and enter a value for each option.
3. Copy both the firmware and configuration files to the appropriate directory on the TFTP Server.

By default, auto update is enabled on the AP-5131 (since the LAN Port is a DHCP Client, out-of-the-box auto update support is on the LAN Port).

4. Restart the AP-5131.
5. While the AP-5131 boots up, verify the AP-5131:
 - Obtains and applies the expected IP Address from the DHCP Server
 - Downloads the firmware and configuration files from the TFTP Server and updates both as required. Verify the file versions within the AP-5131's **System Settings** screen.



NOTE If the firmware files are the same, the firmware will not get updated. If the configuration file name matches the last saved configuration file on the AP-5131, the configuration will not get updated.

B.1.1.3 DHCP Priorities

The following flowchart indicates the priorities used by the AP-5131 when the DHCP server is configured for multiple options.

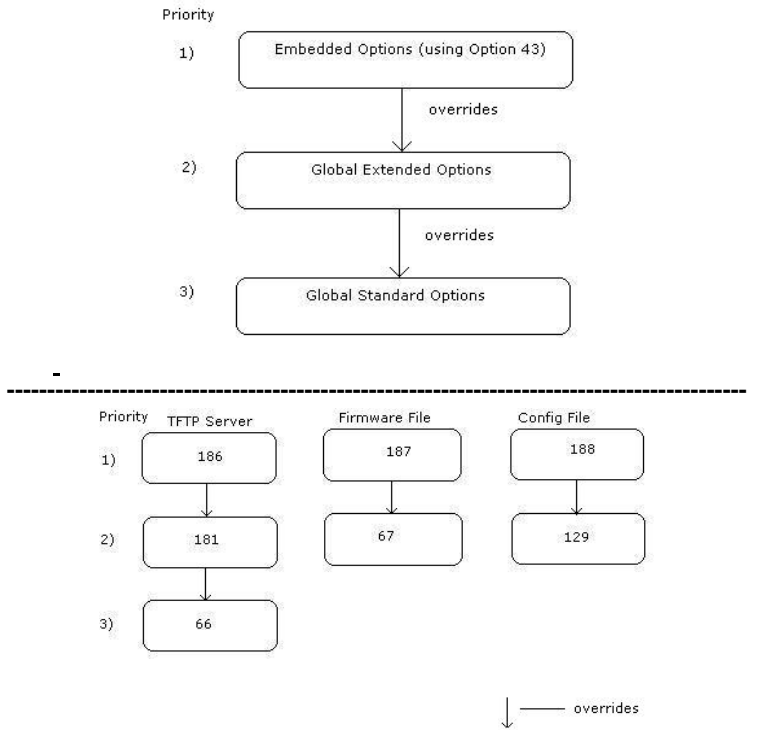

If the DHCP Server is configured for options 186 and 66 (to assign TFTP Server IP addresses) the AP-5131 uses the IP address configured for option 186. Similarly, if the DHCP Server is configured for options 187 and 67 (for the firmware file) the AP-5131 uses the file name configured for option 187. If the DHCP Server is configured for embedded and global options, the embedded options take precedence.

B.1.2 Linux - BootP Server Configuration

See the following sections for information on these BootP server configurations in the Linux environment:

- [BootP Options](#)
- [BootP Priorities](#)

B.1.2.1 BootP Options

This section contains instructions for the automatic update of the AP-5131 firmware and configuration file using a BootP Server.

The setup example described in this section includes:

- 1 AP-5131
- 1 Linux/Unix BOOTP Server
- 1 TFTP Server.

To configure BootP options using a Linux/Unix BootP Server:

1. Set the Linux/Unix BootP Server and AP-5131 on the same Ethernet segment.
2. Configure the bootptab file (/etc/bootptab) on the Linux/Unix BootP Server in any one of the formats that follows:

Using options 186, 187 and 188:

```

AP-5131:ha=00a0f88aa6d8\           < LAN MAC Address>
      :sm=255.255.255.0\           <Subnet Mask>
      :ip=157.235.93.128\          <IP Address>
      :gw=157.235.93.2\           <gateway>
      :T186="157.235.93.250"\      <TFTP Server IP>
      :T187="apfw.bin"\            <Firmware file>
      :T188="cfg.txt":             <Configuration file>

```

Using options 66, 67 and 129:

```

AP-5131:ha=00a0f88aa6d8\           < LAN MAC Address>
      :sm=255.255.255.0\           <Subnet Mask>
      :ip=157.235.93.128\          <IP Address>
      :gw=157.235.93.2\           <gateway>
      :T66="157.235.93.250"\       <TFTP Server IP>
      :T67="apfw.bin"\             <Firmware file>
      :T129="cfg.txt":             <Configuration file>

```

Using options sa, bf and T136:

AP-5131:ha=00a0f88aa6d8\	< LAN MAC Address>
:sm=255.255.255.0\	<Subnet Mask>
:ip=157.235.93.128\	<IP Address>
:gw=157.235.93.2\	<gateway>
:sa=157.235.93.250\	<TFTP Server IP>
:bf=/tftpboot/cfg.txt\	<Configuration file>
:T136="/tftpboot/":	<TFTP root directory>



NOTE The bf option prefixes a forward slash (/) to the firmware file name. This may not be supported on Windows based TFTP Servers.

- Copy the firmware and configuration files to the appropriate directory on the TFTP Server. By default, auto update is enabled on the AP-5131 (since the LAN Port is a DHCP Client, out-of-the-box auto update support is on the LAN Port).
- Restart the AP-5131.
- While the AP-5131 boots, verify the AP-5131:
 - Sends a true BootP request.
 - Obtains and applies the expected IP Address from the BootP Server.
 - Downloads both the firmware and configuration files from the TFTP Server and updates them as required. Verify the file versions within the AP-5131 **System Settings** screen.

Whenever a configuration file is specified, the AP-5131 will tftp the config file, parse it and use the firmware file name in the config file.

If T136 is provided by the server, the AP-5131 strips off the TFTP root directory from the fully qualified configuration file name to obtain a relative file name. For example, if using bf=/opt/tftpd/ftp/dist/ap.cfg and T136="/opt/tftpd", the config file name is ftp/dist/ap.cfg. T136 is only used for this purpose. It is NOT used to append to the config file name or the firmware file name. If T136 is not specified, the AP-5131 uses the entire bf field as the config file name.



NOTE If the firmware files are the same, the firmware will not get updated. If the configuration file name matches the last saved configuration file on the AP-5131, the configuration will not get updated. Additionally, the LAN port needs to be configured as a BootP client, as no BootP support exists on the WAN port (WAN only supports DHCP).

B.1.2.2 BootP Priorities

The following flowchart displays the priorities used by the AP-5131 when the BootP server is configured for multiple options:

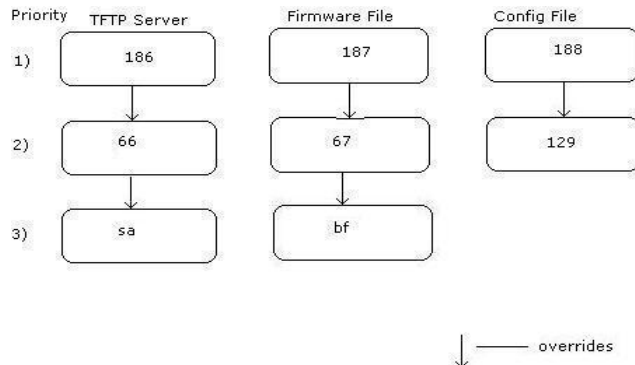

If the BootP Server is configured for options 186 and 66 (to assign TFTP server IP addresses) the AP-5131 uses the IP address configured for option 186. Similarly, if the BootP Server is configured for options 188 and 129 (for the configuration file) the AP uses the file name configured for option 188.

B.2 Configuring an IPSEC Tunnel and VPN FAQs

The AP-5131 has the capability to create a tunnel between an AP-5131 and a VPN endpoint. The AP-5131 can also create a tunnel from one AP-5131 to another AP-5131.

The following instruction assumes the reader is familiar with basic IPSEC and VPN terminology and technology.

- [Configuring a VPN Tunnel Between Two AP-5131s](#)
- [Configuring a Cisco VPN Device](#)
- [Frequently Asked VPN Questions](#)

B.2.1 Configuring a VPN Tunnel Between Two AP-5131s

The AP-5131 can connect to a non-AP device supporting IPSec, such as a Cisco VPN device - labeled as "Device #2".

For this usage scenario, the following components are required:

- 2 AP-5131s
- 1 PC on each side of the AP-5131s LAN.

To configure a VPN tunnel between two AP-5131s:

1. Ensure the WAN ports are connected via the internet.
2. On AP-5131 #1, select **WAN** -> **VPN** from the main menu tree.
3. Click **Add** to add the tunnel to the list.
4. Enter a tunnel name (tunnel names do not need to match).

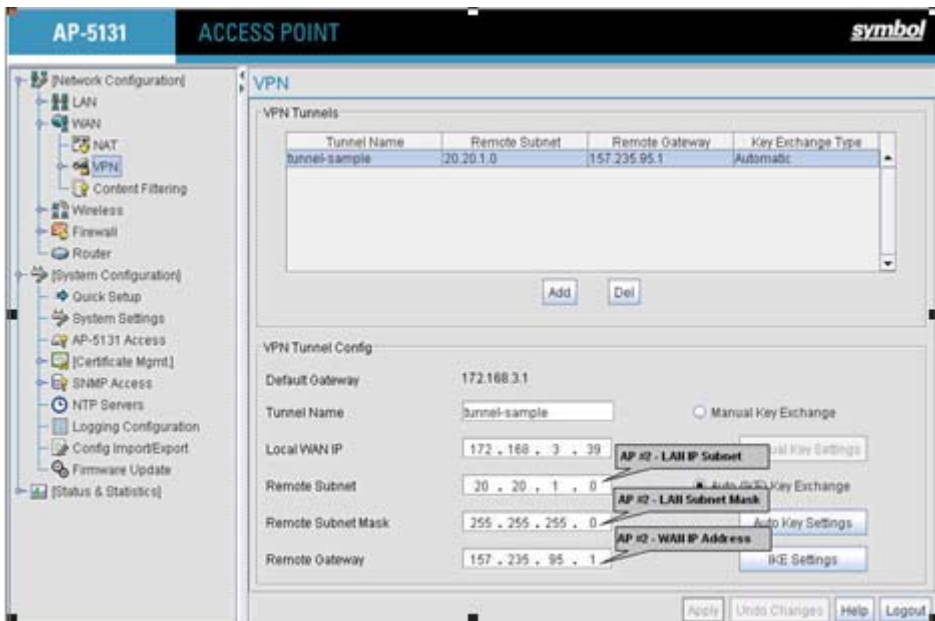

5. Enter the WAN port IP address of AP #1 for the **Local WAN IP**.
6. Within the **Remote Subnet** and **Remote Subnet Mask** fields, enter the LAN IP subnet and mask of AP #2 /Device #2.
7. Enter the WAN port IP address of AP #2/ Device #2 for a **Remote Gateway**.

- Click **Apply** to save the changes.



NOTE For this example, Auto IKE Key Exchange is used. Any key exchange can be used, depending on the security needed, as long as both devices on each end of the tunnel are configured exactly the same.

- Select the **Auto (IKE) Key Exchange** checkbox.
- Select the **Auto Key Settings** button.

The screenshot shows the 'Auto Key Settings' dialog box with the following configurations:

- Use Perfect Forward Security: No
- Security Association Life Time: 300 sec
- AH Authentication: None
- ESP Type: ESP with authentication
- ESP Encryption Algorithm: AES 128-bit
- ESP Authentication Algorithm: MD5

- For the ESP Type, select **ESP with Authentication** and use **AES 128-bit** as the ESP Encryption Algorithm. Click **OK**.
- Select the **IKE Settings** button.

The screenshot shows the 'IKE Settings' dialog box with the following configuration:

- Operation Mode: Main Mode
- Local ID Type: IP
- Local ID Data: empty
- Remote ID Type: IP
- Remote ID Data: empty
- IKE Authentication Mode: Pre Shared Key (PSK)
- IKE Authentication Algorithm: MD5
- IKE Authentication Passphrase: #####
- IKE Encryption Algorithm: AES 128-bit
- Key Lifetime: 3600 sec
- Diffie-Hellman Group: Group 2 - 1024 bit

13. Select **Pre Shared Key (PSK)** from the IKE Authentication Mode drop-down menu.
14. Enter a **Passphrase**. Passphrases must match on both VPN devices.



NOTE Ensure the IKE authentication Passphrase is the same as the Pre-shared key on the Cisco PIX device.

15. Select **AES 128-bit** as the IKE Encryption Algorithm.
16. Select **Group 2** as the Diffie-Hellman Group. Click **OK**. This will take you back to the VPN screen.
17. Click **Apply** to make the changes
18. Check the **VPN Status** screen. Notice the status displays "NOT_ACTIVE". This screen automatically refreshes to get the current status of the VPN tunnel. Once the tunnel is active, the IKE_STATE changes from NOT_CONNECTED to SA_MATURE.

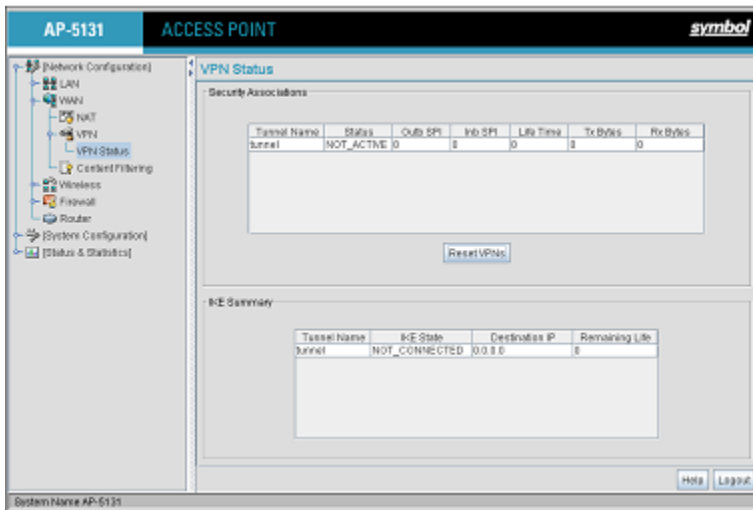

19. On AP-5131 #2/ Device #2, repeat the same procedure. However, replace AP-5131 #2 information with AP-5131 #1 information.
20. Once both tunnels are established, ping each side of the tunnel to ensure connectivity.

B.2.2 Configuring a Cisco VPN Device

This section includes general instructions for configuring a Cisco PIX Firewall 506 series device.

For the usage scenario described in this section, you will require the following:

- 1 Cisco VPN device
- 1 PC connected to the LAN side of the AP-5131 and the Cisco PIX.



NOTE The Cisco PIX device configuration should match the AP-5131 VPN configuration in terms of Local WAN IP (PIX WAN), Remote WAN Gateway (AP-5131 WAN IP), Remote Subnet (AP-5131 LAN Subnet), and the Remote Subnet Mask. The Auto Key Settings and the IKE Settings on the Cisco PIX should match the AP-5131 Key and IKE settings.

Below is how the AP-5131 VPN Status screen should look if the entire configuration is setup correctly once the VPN tunnel is active. The status field should display "ACTIVE".

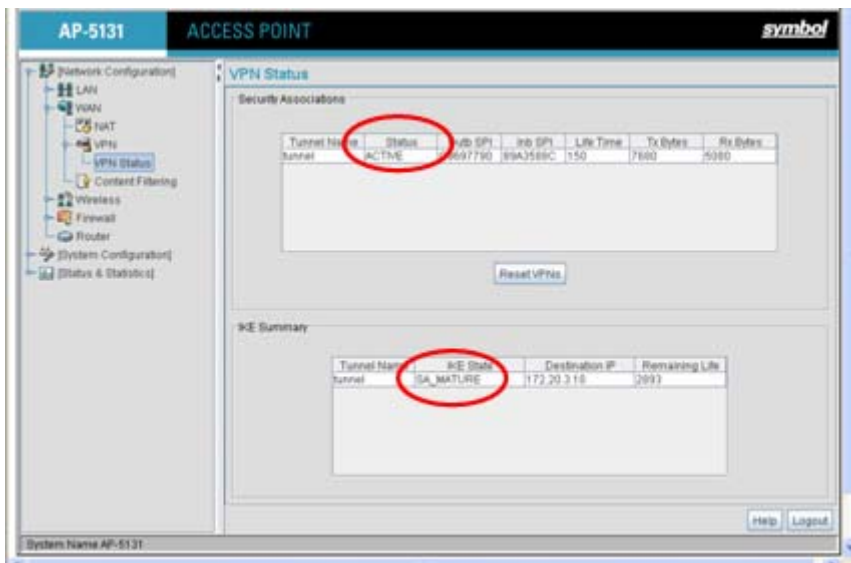

B.2.3 Frequently Asked VPN Questions

The following are common questions that arise when configuring a VPN tunnel using the AP-5131.

- **Question 1: Does the AP-5131 IPSec tunnel support multiple subnets on the other end of a VPN concentrator?**

Yes. The AP-5131 can access multiple subnets on the other end of the VPN Concentrator from the AP-5131's Local LAN Subnet by:

- Creating multiple VPN Tunnels. The AP supports a maximum of 25 tunnels.
- When using the Remote Subnet IP Address with an appropriate subnet mask, the AP can access multiple subnets on the remote end.

For example: If creating a tunnel using 192.168.0.0/16 for the Remote Subnet IP address, the following subnets could be accessed:

192.168.1.x
 192.168.2.x
 192.168.3.x, etc

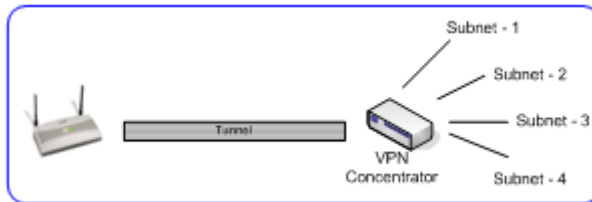

- **Question 2: Even if a wildcard entry of "0.0.0.0" is entered in the Remote Subnet field in the VPN configuration page, can the AP access multiple subnets on the other end of a VPN concentrator for the APs LAN/WAN side?**

No. Using a "0.0.0.0" wildcard is an unsupported configuration. In order to access multiple subnets, the steps in Question #1 must be followed.

- **Question 3: Can the AP be accessed via its LAN interface of AP#1 from the local subnet of AP#2 and vice versa?**

Yes.



- **Question 4: Will the default "Manual Key Exchange" settings work without making any changes?**

No. Changes need to be made. Enter Inbound and Outbound ESP Encryption keys on both APs. Each one should be of 16 Hex characters (depending on the encryption or authentication scheme used). The VPN tunnel can be established only when these corresponding keys match. Ensure the Inbound/Outbound SPI and ESP Authentication Keys have been properly specified.



- **Question 5: Can a tunnel between an AP-5131 and a WS2000 be established?**

Yes.



- **Question 6: Can an IPSec tunnel over a PPPoE connection be established - such as a PPPoE enabled DSL link?**

Yes. The AP-5131 supports tunneling when using a PPPoE username and password.

- **Question 7: Can I setup an AP-5131 so clients can access both the WAN normally and only use the VPN when talking to specific networks?**

Yes. Only packets that match the VPN Tunnel Settings will be sent through the VPN tunnel. All other packets will be handled by whatever firewall rules are set.

- **Question 8: How do I specify which certificates to use for an IKE policy from the AP-5131 certificate manager?**

When generating a certificate to use with IKE, use one of the following fields: **IP address**, **Domain Name**, or **Email** address. Also, make sure you are using NTP when attempting to use the certificate manager. Certificates are time sensitive.

Configure the following on the **IKE Settings** page:

Local ID type refers to the way that IKE selects a local certificate to use.

- IP - tries to match the local WAN IP to the IP addresses specified in a local certificate.
- FQDN - tries to match the user entered local ID data string to the domain name field of the certificate.
- UFQDN - tries to match the user entered local ID data string to the email address field of the certificate.

Remote ID type refers to the way you identify an incoming certificate as being associated with the remote side.

- IP - tries to match the remote gateway IP to the IP addresses specified in the received certificate.
- FQDN - tries to match the user entered remote ID data string to the domain name field of the received certificate.

- UFQDN - tries to match the user entered remote ID data string to the email address field of the received certificate.



- **Question 9: I am using a direct cable connection between my two VPN gateways for testing and cannot get a tunnel established, yet it works when I set them up across another network or router. Why?**

The packet processing architecture of the AP-5131 VPN solution requires the WAN default gateway to work properly. When connecting two gateways directly, you don't need a default gateway when the two addresses are on the same subnet. As a workaround, point the AP-5131's WAN default gateway to be the other VPN gateway and vice-versa.

- **Question 10: I have setup my tunnel and the status still says 'Not Connected'. What should I do now?**

VPN tunnels are negotiated on an "as-needed" basis. If you have not sent any traffic between the two subnets, the tunnel will not get established. Once a packet is sent between the two subnets, the VPN tunnel setup occurs.

- **Question 11: I still can't get my tunnel to work after attempting to initiate traffic between the two subnets. What now?**

Try the following troubleshooting tips:

- Verify you can ping each of the remote Gateway IP addresses from clients on either side. Failed pings can indicate general network connection problems.
- Pinging the internal gateway address of the remote subnet should run the ping through the tunnel as well. Allowing you to test, even if there are no clients on the remote end.
- **Question 12: My tunnel works fine when I use the LAN-WAN Access page to configure my firewall. Now that I use Advanced LAN Access, my VPN stops working. What am I doing wrong?**

VPN requires certain packets to be passed through the firewall. Subnet Access automatically inserts these rules for you when you do VPN. Advanced Subnet Access requires these rules to be in effect for each tunnel.

- An 'allow' inbound rule.

Scr	<Remote Subnet IP range>
Dst	<Local Subnet IP range>
Transport	ANY
Scr port	1:65535
Dst port	1:65535
Rev NAT	None

- An 'allow' outbound rule.

Scr	<Local Subnet IP range>
Dst	<Remote Subnet IP range>
Transport	ANY
Scr port	1:65535
Dst port	1:65535
NAT	None

- For IKE, an 'allow' inbound rule.

Scr	<Remote Subnet IP range>
Dst	<WAN IP address>
Transport	UDP
Scr port	1:65535
Dst port	500
Rev NAT	None

These three rules should be configured above all other rules (default or user defined). When Advanced LAN Access is used, certain inbound/outbound rules need to be configured to control incoming/outgoing packet flow for IPSec to work properly (with Advanced LAN Access). These rules should be configured first before other rules are configured.

- **Question 13: Do I need to add any special routes on the AP-5131 to get my VPN tunnel to work?**

No. However, clients could need extra routing information. Clients on the local LAN side should either use the AP-5131 as their gateway or have a route entry tell them to use the AP-5131 as the gateway to reach the remote subnet.

B.3 Replacing an AP-4131 with an AP-5131

The AP-5131's modified default configuration enables an AP-5131 to not only operate in a single-cell environment, but also function as a replacement for legacy Symbol AP-4131 model access points. You cannot port an AP-5131's configuration file to an AP-5131, but you can configure an AP-5131 similarly and provide an improved data rate and feature set.

An AP-4131 has only one LAN port and it is defaulted to DHCP/BOOTP enabled. The AP-5131 is optimized for single-cell deployment, so it should allow the customer to use an AP-5131 as a "drop-in" replacement for an existing AP-4131 deployment. However, to optimally serve as a replacement for existing AP-4131 deployments, the AP-5131's "out-of-box" defaults are now set as follows:

- The AP-5131's LAN1 port must default to DHCP client mode
- The AP-5131's LAN2 port must default to DHCP server mode
- The AP-5131's WAN port must default to Static mode.
- The default gateway now defaults to LAN1.

- The interface parameter has been removed from the Auto Update configuration feature.
- The WAN interface now has http/telnet/https/ssh connectivity enabled by default.



Customer Support

Symbol Technologies provides its customers with prompt and accurate customer support. Use the Symbol Support Center as the primary contact for any technical problem, question or support issue involving Symbol products.

If the Symbol Customer Support specialists cannot solve a problem, access to all technical disciplines within Symbol becomes available for further assistance and support. Symbol Customer Support responds to calls by email, telephone or fax within the time limits set forth in individual contractual agreements.

When contacting Symbol Customer Support, please provide the following information:

- serial number of unit
- model number or product name
- software type and version number.

North American Contacts

Inside North America:

Symbol Technologies, Inc.
One Symbol Plaza Holtsville, New York 11742-1300
Telephone: 1-631-738-2400/1-800-SCAN 234
Fax: 1-631-738-5990

Symbol Support Center (for warranty and service information):

telephone: 1-800-653-5350
fax: (631) 738-5410
Email: support@symbol.com

International Contacts

Outside North America:

Symbol Technologies
Symbol Place
Winnersh Triangle, Berkshire, RG41 5TP
United Kingdom
0800-328-2424 (Inside UK)
+44 118 945 7529 (Outside UK)

Web Support Sites

MySymbolCare

<http://www.symbol.com/services/msc/msc.html>

Symbol Services Homepage

<http://symbol.com/services>

Symbol Software Updates

<http://symbol.com/services/downloads>

Symbol Developer Program

<http://devzone.symbol.com>

Additional Information

Obtain additional information by contacting Symbol at:

1-800-722-6234, inside North America

+1-516-738-5200, in/outside North America

<http://www.symbol.com/>

Index

A

- access options 1-23
- access point
 - CAM 1-16
 - encryption 1-11
 - PSP 1-16
 - RSSI 1-22
- accessories bag 2-2
- addresses, Symbolviii
- administrator access 4-8
- antenna options 2-5
- antenna support 1-7
- antenna, 2.4 GHz A-4
- AP-5131 access 4-5
- AP-5131 Features 1-6
- AP-5131 Firmware 1-14
- AP-5131 management options 1-14
- AP-5131 operating modes 1-23
- AP-5131 placement 2-4
- AP-5131 statistical displays 1-16
- AP-5131 version 4-3
- AP-5131-13040-WW 2-2
- AP-5131-13041-WW 1-1, 2-3
- AP-5131-13042-WW 2-3
- AP-5131-13043-WW 2-3
- AP-5131-40020-WW 2-3
- AP-5131-40021-WW 1-1, 2-3
- AP-5131-40022-WW 2-3
- AP-5131-40023-WW 2-3
- association process
 - beacon 1-16
 - RSSI 1-22
- automatic firmware update 4-44
- available AP-5131 product configurations 2-2
- available protocols 6-31

B

- Bandwidth Management 5-55
- basic device configuration 3-3
- beacon 1-16

CAM stations	1-16	config file	3-2
PSP stations	1-16	config import/export	4-37
BSSID	1-8	configuration	
bullets, use of	viii	CLI	1-19
C		configuration file import/export	1-17
CA certificate	4-8	configuration options	3-2
CAM	1-16	configuration restoration	1-17
cellular coverage	1-19	content filtering	6-50
certificate authority	4-8	conventions, notational	viii
certificate management	4-8	country codes	4-3, A-6
client bridge association process	9-3	customer support	viii, B-1
CLI, ACL commands	8-80	D	
CLI, bandwidth management	8-107	data access, configuring	4-5
CLI, common commands	8-3	data decryption	1-11
CLI, connection	8-1	data encryption	1-9
CLI, firewall commands	8-120	data security	1-9
CLI, firmware update	8-182	desk mounting	2-11
CLI, log commands	8-169	device firmware	4-41
CLI, network commands	8-11	device settings	3-4
CLI, network LAN commands	8-12	DHCP support	1-18
CLI, network LAN, DHCP commands	8-28	DHCP, advanced settings	5-11
CLI, network wireless commands	8-57	direct-sequence spread spectrum	1-21
CLI, NTP	8-164	Document Conventions	1-vii
CLI, QoS	8-102	dual-radio sku	1-7
CLI, radio configuration	8-85	E	
CLI, rogue-AP commands	8-110	EAP	1-9, 1-10
CLI, router commands	8-125	EAP authentication	1-10
CLI, security commands	8-71	electrical characteristics	A-2
CLI, serial port	8-1	event logging	1-17
CLI, SNMP access	8-153	F	
CLI, SNMP commands	8-152	firewall	1-13
CLI, SNMP traps	8-158	firewall security	1-13
CLI, statistics	8-186	firewall, configuring	6-25
CLI, system access commands	8-136	firmware	1-14
CLI, system commands	8-131	firmware update	4-42
CLI, telnet	8-2	firmware, updates	4-41
CLI, type filter commands	8-34	H	
CLI, WAN commands	8-39	hardware installation	2-1
CLI, WAN NAT commands	8-42		
CLI, WAN VLAN Commands	8-48		
Command Line Interface (CLI)			
configuration	1-19		
command line interface (CLI)	3-2		

I	
importing certificates	4-8
importing/exporting configurations	4-37
installation, ceiling	2-17
installation, ceiling T-Bar	2-15
installation, desk mounting	2-11
installation, wall mounting	2-13
J	
Java-Based WEB UI	3-2
K	
Kerberos	1-9, 1-10
authentication	1-10
implementation	1-10
Kerberos authentication	1-10
KeyGuard	1-9, 1-12, 6-18
L	
LAN port	1-7
LAN to WAN access	6-28
LAN, configuring	5-1
LAN, statistics	7-6
LAN, timeout	5-2
LED indicators	1-18
LEDs	1-18, 2-20
logging configuration	4-35
login screen	3-3, 4-1
M	
MAC layer bridging	1-20
management options	1-23
SNMP	1-14
media types	1-21
mesh networking	
dual-radio AP-5131	9-3
STP	9-4
topology	9-4
use case	9-18
mesh overview	9-1
MIB	3-2
ML-2499-11PNA2-01	2-6
ML-2499-BYGA2-01	2-6
ML-2499-HPA3-01	2-6
ML-5299-WBPBX1-01	2-7, A-4
ML-5299-WPNA1-01	2-7, A-4
monitoring statistics	7-1, 9-1
mounting options	1-7
Mounting the AP-5131	2-11
MU	
CAM	1-16
data decryption	1-11
data encryption	1-9
MU association	1-22
MU association process	1-22
MU-MU transmission disallow	1-15
N	
NAT, configuring	5-19
Network Time Protocol (NTP)	4-32
Notational Conventions	1-viii
notational conventions	viii
NTP, configuring	4-32
O	
operating modes	1-23
P	
package contents	2-2
phone numbers, Symbol	viii
physical characteristics	A-2
power injector, cabling	2-9
power injector, installation	2-9
power injector, LEDs	2-10
power options	2-8
PPP over Ethernet	5-17
precautions	2-2
product configurations	2-2
programmable SNMP trap	1-7
PSP	1-16
PSP stations	1-16
beacon	1-16
MU	1-16
Q	
QoS support	1-9
Quality of Service (QoS)	1-9

R	
radio options	1-6
radio, retry histogram	7-22
radio, statistics	7-17
restore default configuration	4-4
roaming across routers	
TIM	1-16
rogue AP detection	6-53
rogue AP detection, allowed APs	6-56
rogue AP, details	6-59
routing information protocol (RIP)	1-5
S	
security, WPA	6-20
security	1-11
decryption	1-11
security, content filtering	6-50
security, firewall	6-25
security, KeyGuard	6-18
security, rogue AP detection	6-53
security, VPN	6-34
security, WLAN	3-9
security, WPA2-CCMP	6-22
self certificates	4-10
serial number	4-4
service information	viii
setting up MUs	2-22
single sku	1-6
site surveys	2-5
SNMP	1-14
SNMP Access	4-19
SNMP access control	4-23
SNMP settings	4-17
SNMP v1/v2	4-20
SNMP v1/v2/v3 trap support	1-14
SNMP v3	4-21
SNMP, access control	4-23
SNMP, RF trap thresholds	4-30
SNMP, specific traps	4-28
SNMP, traps	4-25
SNMP, v1/v2c	4-26
SNMP, v3 user definitions	4-21
software and documentation CDROM	2-2
statistics, AP-5131	7-30
statistics, LAN	7-6
statistics, mu	7-23
statistics, radio	7-17
statistics, WAN	7-2
statistics, WLAN	7-11
suspended T-Bar installations	2-15
Symbol support center	viii
system information	4-1
system configuration	4-1
system location	4-3
system name	4-3
system settings	4-2
system settings, configuration	4-2
system uptime	4-3
T	
technical support	viii
testing AP-5131 connectivity	3-11
testing connectivity	3-11
theory of operations	1-18
TKIP	1-12
transmit power control	1-17
type filter, configuration	5-13
V	
VLAN support	1-13
VLAN, configuring	5-4
VLAN, management tag	5-7
VLAN, name	5-3
VLAN, native tag	5-7
Voice prioritization	1-16
VPN	1-13
VPN Tunnels	1-13
VPN, auto key settings	6-42, 6-43
VPN, configuring	6-34
VPN, IKE key settings	6-44
VPN, manual key settings	6-38
VPN, status	6-48
W	
wall mounting	2-13
WAN port	1-7
WAN, configuring	5-14
WAN, port forwarding	5-21

WAN, statistics	7-2	WLAN, security	5-29
WEP	1-11	WLAN, statistics	7-11
WEP encryption	1-9, 1-11	WPA	6-20
Wi-Fi Protected Access (WPA)	1-12	WPA2-CCMP	1-12, 6-22
WLAN, ACL	5-31	WPA2-CCMP (802.11i).....	1-12
WLAN, creating	5-24	WPA-CCMP (802.11i).....	1-9
WLAN, editing	5-24	WPA-TKIP.....	1-9
WLAN, enabling.....	5-22	WPA, 256-bit keys	6-22

Symbol Technologies, Inc.
One Symbol Plaza
Holtsville, New York 11742-1300



72E-94168-01
Revision A - November 2006

Free Manuals Download Website

<http://myh66.com>

<http://usermanuals.us>

<http://www.somanuals.com>

<http://www.4manuals.cc>

<http://www.manual-lib.com>

<http://www.404manual.com>

<http://www.luxmanual.com>

<http://aubethermostatmanual.com>

Golf course search by state

<http://golfingnear.com>

Email search by domain

<http://emailbydomain.com>

Auto manuals search

<http://auto.somanuals.com>

TV manuals search

<http://tv.somanuals.com>