

Owner's Manual

Symphonic

Recording function

- This unit can record only on the DVR.
- The DVR with 80 GB hard disc allows you to record up to 34 hours.

DVR (HDD) with DVD Player

CSHP80G

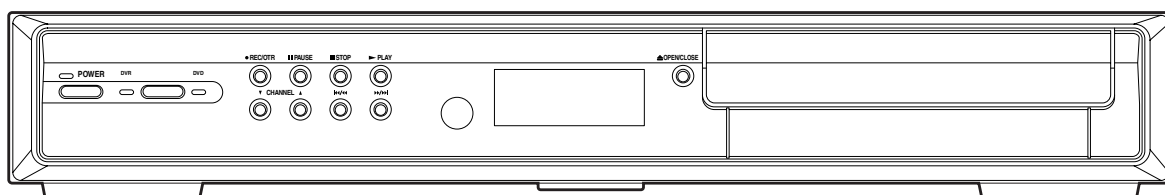

Supplied Accessories

- Remote control (NB310UD) with two AA batteries

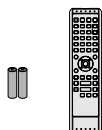

- RF cable (WPZ0901TM002)

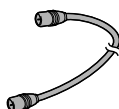

- Audio / Video cables (WPZ0102TM015)

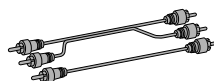

- Owner's Manual (1VMN22701)

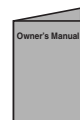

* Please use RF cable and Audio / Video cables to connect to TV.

Please read before using this equipment.
If you need additional operating assistance after reading this owner's manual or to order replacement accessories, please call
TOLL FREE: 1-800-605-8453
or visit our web site at <http://www.Symphonic.us>

Before you use this unit , you need to complete connections. Refer to 'Connections' on pages 16-18.

Before You Start

Precautions

WARNING: TO REDUCE THE RISK OF FIRE OR ELECTRIC SHOCK, DO NOT EXPOSE THIS APPLIANCE TO RAIN OR MOISTURE.



CAUTION
RISK OF ELECTRIC SHOCK
DO NOT OPEN



CAUTION:

TO REDUCE THE RISK OF ELECTRIC SHOCK, DO NOT REMOVE COVER (OR BACK). NO USER SERVICEABLE PARTS INSIDE. REFER SERVICING TO QUALIFIED SERVICE PERSONNEL.



The lightning flash with arrowhead symbol, within an equilateral triangle, is intended to alert the user to the presence of uninsulated, "dangerous voltage" within the product's enclosure that may be of sufficient magnitude to constitute a risk of electric shock to persons.



The exclamation point within an equilateral triangle is intended to alert the user to the presence of important operating and maintenance (servicing) instructions in the literature accompanying the appliance.

The important note is located on the rear of the cabinet.

Laser Safety

This unit employs a laser. Only a qualified service person should remove the cover or attempt to service this device, due to possible eye injury.

CAUTION: USE OF CONTROLS OR ADJUSTMENTS OR PERFORMANCE OF PROCEDURES OTHER THAN THOSE SPECIFIED HEREIN MAY RESULT IN HAZARDOUS RADIATION EXPOSURE.

CAUTION: VISIBLE AND INVISIBLE LASER RADIATION WHEN OPEN AND INTERLOCK DEFEATED. DO NOT STARE INTO BEAM.

LOCATION: INSIDE, NEAR THE DECK MECHANISM.

FCC WARNING-This equipment may generate or use radio frequency energy. Changes or modifications to this equipment may cause harmful interference unless the modifications are expressly approved in the manual. The user could lose the authority to operate this equipment if an unauthorized change or modification is made.

RADIO-TV INTERFERENCE

This equipment has been tested and found to comply with the limits for a Class B digital device, pursuant to Part 15 of the FCC Rules. These limits are designed to provide reasonable protection against harmful interference in a residential installation. This equipment generates, uses, and can radiate radio frequency energy and, if not installed and used in accordance with the instructions, may cause harmful interference to radio communications. However, there is no guarantee that interference will not occur in a particular installation. If this equipment does cause harmful interference to radio or television reception, which can be determined by turning the equipment off and on, the user is encouraged to try to correct the interference by one or more of the following measures:

- 1) Reorient or relocate the receiving antenna.
- 2) Increase the separation between the equipment and receiver.
- 3) Connect the equipment into an outlet on a circuit different from that to which the receiver is connected.
- 4) Consult the dealer or an experienced radio / TV technician for help.

This Class B digital apparatus complies with Canadian ICES-003.

CAUTION: TO PREVENT ELECTRIC SHOCK, MATCH WIDE BLADE OF PLUG TO WIDE SLOT, FULLY INSERT.

A NOTE ABOUT RECYCLING

This product's packaging materials are recyclable and can be reused. Please dispose of any materials in accordance with your local recycling regulations.

Batteries should never be thrown away or incinerated but disposed of in accordance with your local regulations concerning chemical wastes.

Make your contribution to the environment!!!

- Used up batteries do not belong in the dust bin.
- You can dispose of them at a collection point for used up batteries or special waste. Contact your council for details.



For Customer Use:

Read carefully the information located at the back of this unit and enter below the Serial No. Retain this information for future reference.

Model No. _____

Serial No. _____

IMPORTANT SAFEGUARDS

1. **Read Instructions** - All the safety and operating instructions should be read before the appliance is operated.
2. **Retain Instructions** - The safety and operating instructions should be retained for future reference.
3. **Heed Warnings** - All warnings on the appliance and in the operating instructions should be adhered to.
4. **Follow Instructions** - All operating and use instructions should be followed.
5. **Cleaning** - Unplug this product from the wall outlet before cleaning. Do not use liquid cleaners or aerosol cleaners. Use a damp cloth for cleaning.
EXCEPTION: A product that is meant for uninterrupted service and, that for some specific reason, such as the possibility of the loss of an authorization code for a CATV converter, is not intended to be unplugged by the user for cleaning or any other purpose, may exclude the reference to unplugging the appliance in the cleaning description otherwise required in item 5.
6. **Attachments** - Do not use attachments not recommended by the product manufacturer as they may cause hazards.
7. **Water and Moisture** - Do not use this product near water, for example, near a bath tub, wash bowl, kitchen sink, or laundry tub, in a wet basement, or near a swimming pool, and the like.
8. **Accessories** - Do not place this product on an unstable cart, stand, tripod, bracket, or table. The product may fall, causing serious injury to a child or adult, and serious damage to the appliance. Use only with a cart, stand, tripod, bracket, or table recommended by the manufacturer, or sold with the product. Any mounting of the appliance should follow the manufacturer's instructions and should use a mounting accessory recommended by the manufacturer. An appliance and cart combination should be moved with care. Quick stops, excessive force, and uneven surfaces may cause the appliance and cart combination to overturn.
9. **Ventilation** - Slots and openings in the cabinet are provided for ventilation and to ensure reliable operation of the product and to protect it from overheating, and these openings must not be blocked or covered. The openings should never be blocked by placing the product on a bed, sofa, rug, or other similar surface. This product should not be placed in a built-in installation such as a bookcase or rack unless proper ventilation is provided or the manufacturer's instructions have been adhered to.
10. **Power Sources** - This product should be operated only from the type of power source indicated on the marking label. If you are not sure of the type of power supply to your home, consult your appliance dealer or local power company. For products intended to operate from battery power, or other sources, refer to the operating instructions.
11. **Grounding or Polarization** - This product is equipped with a polarized alternating-current line plug (a plug having one blade wider than the other). This plug will fit into the power outlet only one way. This is a safety feature. If you are unable to insert the plug fully into the outlet, try reversing the plug. If the plug should still fail to fit, contact your electrician to replace your obsolete outlet. Do not defeat the safety purpose of the polarized plug.
12. **Power Cord Protection** - Power supply cords should be routed so that they are not likely to be walked on or pinched by items placed upon or against them, paying particular attention to cords at plugs, convenience receptacles, and the point where they exit from the appliance.
13. **Outdoor Antenna Grounding** - If an outside antenna or cable system is connected to the product, be sure the antenna or cable system is grounded so as to provide some protection against voltage surges and built-up static charges. Article 810 of the National Electrical Code

Code, ANSI / NFPA No. 70, provides information with regard to proper grounding of the mast and supporting structure, grounding of the lead-in wire to an antenna discharge unit, size of grounding conductors, location of antenna-discharge unit, connection to grounding electrodes, and requirements for the grounding electrode. (Fig. A)

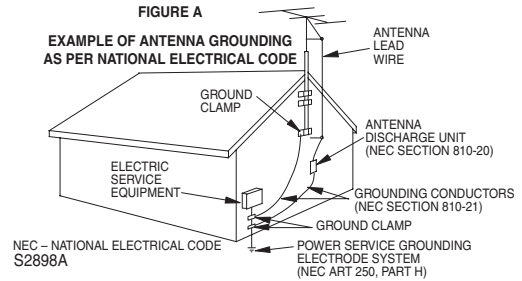

14. **Lightning** - For added protection for this product during a lightning storm, or when it is left unattended and unused for long periods of time, unplug it from the wall outlet and disconnect the antenna or cable system. This will prevent damage to the product due to lightning and power-line surges.
15. **Power Lines** - An outside antenna system should not be located in the vicinity of overhead power lines or other electric light or power circuits, or where it can fall into such power lines or circuits. When installing an outside antenna system, extreme care should be taken to keep from touching such power lines or circuits as contact with them might be fatal.
16. **Overloading** - Do not overload wall outlets and extension cords as this can result in a risk of fire or electric shock.
17. **Object and Liquid Entry** - Never push objects of any kind into this product through any openings as they may touch dangerous voltage points or short-out parts that could result in a fire or electric shock. Never spill liquid of any kind on the product.
18. **Service** - Do not attempt to service this product yourself as opening or removing covers may expose you to dangerous voltage or other hazards. Refer all servicing to qualified service personnel.
19. **Damage Requiring Service** - Unplug this product from the wall outlet and refer servicing to qualified service personnel under the following conditions:
 - a. When the power-supply cord or plug is damaged.
 - b. If liquid has been spilled, or objects have fallen into the product.
 - c. If the product has been exposed to rain or water.
 - d. If the product does not operate normally by following the operating instructions. Adjust only those controls that are covered by the operating instructions as an improper adjustment of other controls may result in damage and will often require extensive work by a qualified technician to restore the product to its normal operation.
 - e. If the product has been dropped or damaged in any way.
 - f. When the product exhibits a distinct change in performance this indicates a need for service.
20. **Replacement Parts** - When replacement parts are required, be sure the service technician has used replacement parts specified by the manufacturer or have the same characteristics as the original part. Unauthorized substitutions may result in fire, electric shock or other hazards.
21. **Safety Check** - Upon completion of any service or repairs to this product, ask the service technician to perform safety checks to determine that the product is in proper operating condition.
22. **Heat** - This product should be situated away from heat sources such as radiators, heat registers, stoves, or other products (including amplifiers) that produce heat.

PORTABLE CART WARNING
(Symbol provided by RETAC)



Before You Start

Connections

DVR

DVD

Others

Before You Start

Precautions (Cont'd)

Installation Location

For safety and optimum performance of this unit:

- Install the unit in a horizontal and stable position. Do not place anything directly on top of the unit. Do not place the unit directly on top of the TV.
- Shield it from direct sunlight and keep it away from sources of intense heat. Avoid dusty or humid places. Avoid places with insufficient ventilation for proper heat dissipation. Do not block the ventilation holes on the sides of the unit. Avoid locations subject to strong vibration or strong magnetic fields.

Avoid the Hazards of Electrical Shock and Fire

- Do not handle the power cord with wet hands.
- Do not pull on the power cord when disconnecting it from AC wall outlet. Grasp it by the plug.
- If, by accident, water is spilled on this unit, unplug the power cord immediately and take the unit to our Authorized Service Center for servicing.

Moisture Condensation Warning

Moisture condensation may occur inside the unit when it is moved from a cold place to a warm place or after heating a cold room or under conditions of high humidity. Do not use this unit at least for 2 hours until its inside gets dry.

About Copyright

Unauthorized copying, broadcasting, public performance and lending of discs are prohibited.

This product incorporates copyright protection technology that is protected by U.S. patents and other intellectual property rights. Use of this copyright protection technology must be authorized by Macrovision, and is intended for home and other limited viewing uses only unless otherwise authorized by Macrovision. Reverse engineering or disassembly is prohibited.

Notice for progressive scan outputs

Consumers should note that not all high definition television sets are fully compatible with this product and may cause artifacts to be displayed in the picture. In case of picture problems with 525p progressive scan outputs, it is recommended that the user switch the connection to the 'standard definition' output. If there are questions regarding your TV set compatibility with this model 525p DVD player, please contact our customer service center.

Manufactured under license from Dolby Laboratories. "Dolby" and the double-D symbol are trademarks of Dolby Laboratories.

Table of Contents

Before you start	2	DVR (Editing)	48
Precautions	2	Deleting Titles	48
Laser Safety	2	Deleting Selected Titles	48
IMPORTANT SAFEGUARDS	3	Deleting all Titles in DVR	49
Table of Contents	5	Protecting / Undo Protecting Titles	50
Features	6	DVR (Other Setups)	51
Information on Recording (DVR)	8	Tour of the Setup Menus	51
Information on Playback	9	Playback Setting	52
Functional overview	10	TV Aspect	53
Front Panel	10	Audio Out	53
Rear Panel	10	Recording Setting (Auto Chapter)	54
Front Panel Display	11	Reset to Factory Default	55
Remote Control	12	DVD (Disc Playback)	56
On-Screen Display for DVR Mode	14	About the Discs	56
On-Screen Display for DVD Mode	15	Playable Discs	56
Connections	16	Unplayable Discs	56
Connection to a TV	16	Playback	57
Connection to a Cable Box or Satellite Box	17	Basic Playback	57
Connection to an Audio System	18	Disc Menus	58
DVR (Initial Setups)	19	Title Menus	58
OSD Language Setting	19	Resume Playback	59
Turn on the Unit for the First Time	19	Pause	60
To change the On-Screen Language	19	Step-by-Step Playback	60
Channel Setting	20	Special Playback	61
Getting Channels Automatically	20	Fast Forward / Fast Reverse	61
Adding / Deleting Channels	21	Slow Forward / Slow Reverse	62
Clock Setting	22	Zoom	63
Auto Clock Setting	22	Playing back MP3 / WMA Discs	64
Manual Clock Setting	23	Search	65
Setting Daylight Saving Time	24	Track Search	65
TV Audio Setting	25	Using SKIP ◀◀ / ▶▶	65
DVR (Recording)	26	Using SEARCH	65
Basic Recording	26	Title / Chapter Search	66
One Touch Recording (OTR)	27	Using SKIP ◀◀ / ▶▶	66
Timer Recording	28	Using SEARCH	66
Editing the Timer Programming Information	30	Time Search	67
Hints for Timer Recording	31	Marker Setup	68
Recording & Playback Navigator	32	Repeat / Random / Programmed Playback	69
Guide to the Programmed Recordings Screen	32	Repeat Playback	69
Programming a Recording with		Repeat A-B Playback	70
the Recording & Playback Navigator	33	Random Playback	71
To Change or Cancel the Program	33	Programmed Playback	72
Playback and Edit with Programmed Recordings	33	Special Settings	73
Settings for the External Devices	34	Subtitle Language	73
Dubbing from the External Devices	35	To set subtitle ON/OFF	73
DVR (Playback)	36	Audio Language	74
Basic Playback	36	Camera Angles	75
Direct Playback	36	Black Level Setting	76
Playback from the Title List	36	Stereo Sound Mode	77
Playback from the Title List Menu	37	Virtual Surround	78
Resume Playback	37	DVD (Setups)	79
Special Playback	38	DVD SETUP	79
Fast forward / Fast reverse	38	LANGUAGE Setting	80
Slow forward / Slow reverse	38	DISPLAY Setting	81
Time Shift Playback	39	AUDIO Setting	82
Simultaneous Playback and Recording	39	PARENTAL Setting	83
Pause	40	OTHERS Setting	85
Step-by-Step Playback	40	Others	86
Repeat Playback	41	Troubleshooting	86
Search	42	Glossary	91
Title / Chapter Search	42	Language Code	92
Using SKIP ◀◀ / ▶▶	42	Maintenance	93
Using DISPLAY	42	Frequently Asked Questions	94
Time Search	43	Specification	94
Series Search	44	LIMITED WARRANTY	96
Selecting a Format of Audio and Video	46		
Audio Status	46		
Visual Noise Reduction	47		

Before You Start

Connections

DVR

DVD

Others

Features

The following features are available with this unit.

DVR

Recording

This unit only allows you to record on the DVR.

80GB Hard Disc (DVR) [➡ Pages 26~35]

This unit is equipped with a DVR with 80 GB hard disc which allows you to record up to 34 hours.

Recording and Playback Navigator

[➡ Pages 32~33]

You can easily program recording or call and replay a title which is recorded in the past on the calendar.

One Touch Recording (OTR)

[➡ Page 27]

This feature allows you to start the recording right away with just one-touch. And each press of **REC / OTR** increases the recording time by 30 minutes.

Timer programming up to 32 programs

[➡ Page 28~31]

You can program the unit to record up to 32 programs within a one-month period. Daily or weekly repeating programs can also be programmed.

Automatic Chapter Marker [➡ Page 54]

Each recorded title is automatically marked with chapter marks.

Playback

Simultaneous Recording [➡ Page 39]

You can record on the DVR during DVD playback.

Theater-quality Sound at Home [➡ Page 18]

When connecting the unit to an amplifier or a decoder that is compatible with Dolby Digital, you can experience a theater-quality sound environment.

Time Shift Playback [➡ Page 39]

You can play back from the top of the DVR Recording title while recording without waiting for the recording to end.

Series Search [➡ Page 44]

You can search for the group of titles made with the same Periodical Timer Recordings.

Editing

Deleting Titles [➡ Pages 48~49]

You can delete titles you no longer need.

Protecting Titles [➡ Page 50]

You can prevent accidental title erasing.

DVD

Playback

Progressive Scan System [➡ Page 16]

Unlike the standard definition output system (interlace scanning), the progressive scan system provides less flickering and higher resolution images than the traditional scanning system does.

Dolby Digital Sound [➡ Page 82]

By hooking this player up to a Multi - Channel Dolby Digital decoder, you can enjoy high-quality Dolby Digital Multi - Channel surround sound as heard in the movie theaters.

Pause/Step-by-Step Playback/Fast Forward/Fast Reverse/Slow Forward/Slow Reverse

[➡ Pages 60~62]

Various playback modes are available including still pictures, fast forward/reverse, slow motion and step frames.

Random Playback (for Audio CD, MP3 and WMA)

[➡ Page 71]

This player can shuffle the order of tracks to play them in random order.

Program Playback (for Audio CD, MP3 and WMA)

[➡ Page 72]

You can program the order of tracks to play them in any desired order.

DVD menus in a desired language [➡ Page 80]

You can display DVD menus in a desired language, if available on a DVD.

Auto Power Off [➡ Page 85]

The power turns off automatically if there is no activity at the player or its remote for more than 30 minutes.

Subtitles in a desired language [➡ Page 80]

You can select a desired language for the display subtitles, if that language is available on a disc.

Selecting a camera angle [➡ Page 75]

You can select the desired audio language and sound mode, if different languages and modes are available on a disc.

Choices for audio setting and sound mode

[➡ Page 82]

When connecting the unit to an amplifier or a decoder that is compatible with Dolby Digital, you can experience a theater-quality sound environment.

Parental lock [➡ Page 83]

You can set the control level to limit playback of discs which may not be suitable for children.

Automatic detection of discs [➡ Page 85]

This player automatically detects if a loaded disc is DVD-Video, Audio CD, MP3 or WMA.

Playing an MP3 /WMA disc [➡ Page 64]





You can enjoy MP3 /WMA files which are recorded on CD-RW/R.

Direct Search [➡ Pages 65–68]

You can search the desired title, chapter, marker and track with the numeric buttons during playback or in stop mode.

Symbols Used in this Manual

The available functions depend on the type of disc. To specify disc type for each function, we put the following symbols at the beginning of each function description.

Symbol	Description
	Available to DVR (internal HDD)
	Available to DVD discs
	Available to Audio CDs
	Available to CD-RW / R discs with MP3 files
	Available to CD-RW / R discs with WMA files



Windows Media and the Windows logo are trademarks or registered trademarks of Microsoft Corporation in the United States and/or other countries.

This unit is not compatible with Multiple Bit Rate (MBR: a file that contains the same content encoded at several different bit rates).

“WMA” (Windows Media Audio) is a new audio developed by Microsoft® in the United States of America.

Information on Recording (DVR)

About DVR (HDD)

DVR is a special component which has high recording density and is suited for long-time recording or high-speed cueing but by contrast, has many factors which can cause breakage. Use DVR on the premise that you should dub the recorded programs to a DVD disc or a videotape to protect your precious videos.

DVR is a temporary storage location.

DVR is not a permanent storage location of the recorded contents. Be sure to use it as a temporary storage location until you watch the programs once dub them to a DVD disc or a videotape.

Be sure to dub (back up) data promptly if you find abnormalities in DVR.

If there is mechanical trouble with the DVR, grinding or other sounds may be heard or blocky noise may appear on the image. If you continue to use as it is, deterioration may continue and eventually the DVR may not be used at all. If you notice these symptoms of a failing DVR, promptly dub the data to a DVD disc or a videotape.

When an DVR fails, recovery of recorded content (data) may be impossible.

About the remaining capacity of DVR recording time:

In recording to DVR, the Remaining Capacity Display may differ from the actual recordable time as this unit adopts Variable Bit Rate encoding, which varies the recording (storage) amount of data in conformity with the information amount of video. Before recording to the DVR, ensure there is sufficient space on the DVR by deleting unnecessary titles in advance.

Recording speed

This unit is equipped with a DVR with 80 GB hard disc which allows you to record up to 34 hours.

You can not select a recording speed.

* The recording time is an estimate and actual recording time may differ.

Restrictions on recording

You cannot record copy protected discs or tapes using this unit. Copy protected material includes DVD-Video and some satellite broadcasts.

If copy protected material is encountered during a recording, recording will be paused or stop automatically and an error message will be displayed on-screen.

Copy-once programs can be recorded on the DVR

Maximum Recordable numbers of title / chapters

DVR: 300 titles
999 chapters per title

Information on copy control

Some satellite broadcasts include copy-protected information. For their recording, refer to the following.

Information on Playback

Before you play back DVD discs, read the following information.

Playable discs

This unit is compatible with the discs mentioned on page 56.

To play back a DVD, make sure that it meets the requirements for region codes and color systems described in this section. Discs with the following logos can be played back on the unit. Playback of other disc types is not guaranteed.

Color systems

DVDs are recorded in different color systems throughout the world. The most common color system is NTSC (which is used primarily in the United States and Canada).

This unit uses NTSC, you must use DVDs recorded in the NTSC system. You cannot play back DVDs recorded in other color systems.

Region codes

This unit has been designed to play back DVD discs with Region One (1). DVDs must be labeled for ALL regions or for Region 1. You cannot play back DVDs labeled for other regions. Look for the symbols below on your DVDs. If these region symbols are not on your DVD, you cannot play back the DVD on this unit.



The number inside the globe refers to region of the world. A DVD labeled for a specific region can only be played back on the unit with the same region code.

Play the recorded contents

You can select the title you want to play from the Title List. The Title List can easily be accessed by pressing **TOP MENU**. The recorded titles can also be called up by pressing **PROGRAM RECORDINGS** (DVR only).

What are titles and chapters?

The contents on the DVR / DVD are generally divided into titles. Titles may be further divided into chapters.

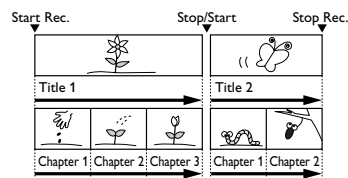

Note

- DVD-RW/R discs and CD-RW/R discs recorded on a personal computer or a DVD or CD recorder may not be played back if the disc is damaged or dirty or if there is dirt or condensation on the player's lens.
- If you record on a disc using a personal computer, there are cases in which it may not be played back because of the settings of the application software used to create the disc, even if it is recorded in a compatible format. (Check with the software publisher for more detailed information.)

Before You Start

Functional Overview

*The unit can also be turned on by pressing these buttons.

Front Panel

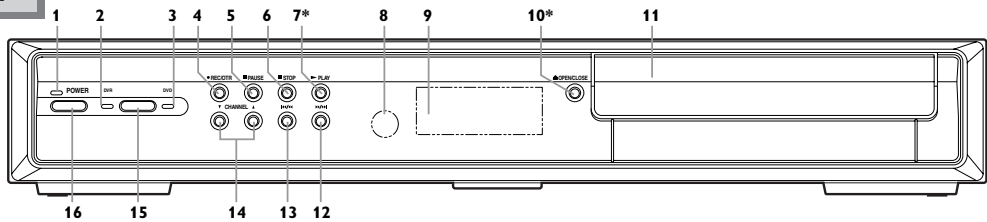

Rear Panel

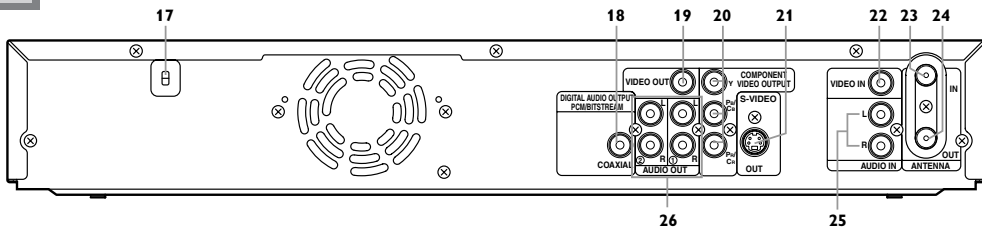

- 1 **POWER indicator:** Lights up when the power is on.
- 2 **DVR indicator:** Lights up when DVR mode is selected.
- 3 **DVD indicator:** Lights up when DVD mode is selected.
- 4 **● REC / OTR :** Press once to start a basic recording. Press repeatedly to start an OTR (One Touch Recording). Each press increases the recording time by 30 minutes up to eight hours.
- 5 **|| PAUSE :** Press to pause playback or recording.
- 6 **■ STOP :** Press to stop playback or recording.
- 7 **▶ PLAY * :** Press to start or resume playback. Press and hold for 5 seconds to set the Progressive Scan mode on / off. (DVD mode only)
- 8 **Remote control sensor:** Receives signals from the remote control.
- 9 **Display:** Shows information and messages.
- 10 **▲ OPEN / CLOSE * :** Press to open / close the disc tray.
- 11 **Disc tray:** Place a DVD here.
- 12 **▶▶/▶▶ (SKIP/FWD) :** During playback, press to skip to the next title, chapter, or track. During playback, press and hold for 2 seconds for fast forward. When playback is paused, press and hold for 2 seconds for slow forward and press repeatedly for step by step playback.
- 13 **◀◀/◀◀ (SKIP/REV) :** During playback, press to skip to the previous title, chapter, or track. During playback, press and hold for 2 seconds for fast reverse. When playback is paused, press and hold for 2 seconds for slow reverse and press repeatedly for step by step playback.
- 14 **CHANNEL ▲ / ▼:** Press to change the channel.
- 15 **Device select button :** Press to switch the device mode between DVR and DVD.
- 16 **POWER:** Press to turn the unit on / off. The red LED is lit when the power is on.
- 17 **AC Power Cord:** Connect to a standard AC outlet to supply power to this unit.
- 18 **COAXIAL DIGITAL AUDIO OUT:** Connect an AV receiver, Dolby Digital decoder or other equipment with a coaxial digital input jack with an audio coaxial digital cable.
- 19 **VIDEO OUT:** Connect the video input of a TV monitor, AV receiver, or other equipment here using the supplied video cable.
- 20 **COMPONENT VIDEO OUTPUT:** Connect the component video input of a TV monitor, AV receiver, or other equipment here using a commercially available component video cable. (DVD mode only)
- 21 **S-VIDEO OUT:** Connect the S-Video input of a TV monitor, AV receiver, or other equipment here using a commercially available S-Video cable.
- 22 **VIDEO IN(LINE1) :** Connect the video output of an external device here using the supplied video cable.
- 23 **TV ANTENNA IN:** Use to connect an antenna.
- 24 **TV ANTENNA OUT:** Use to connect an antenna cable to pass the signal from the TV ANTENNA IN to your TV monitor.
- 25 **AUDIO IN(LINE1) :** Connect an external equipment here using a supplied audio cables.
- 26 **AUDIO OUT :** Connect the audio input of a TV monitor, AV receiver, or other equipment here using the supplied audio (L / R) cables.

Note: Do not touch the inner pins of the jacks on the rear panel. Electrostatic discharge may cause permanent damage to the unit.

Functional Overview (Cont'd)

Front Panel Display

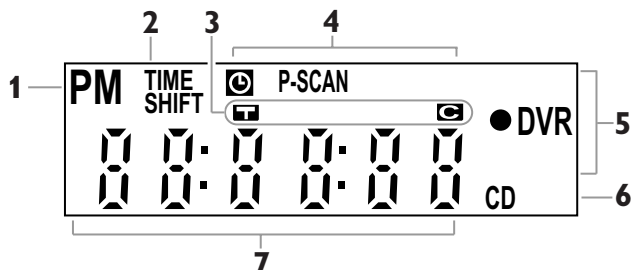

- 1 **PM** : Appears in the afternoon with the Clock Display.
- 2 **TIME SHIFT(DVR)** :
Appears during the Time Shift Playback.
- 3 Title /Track and Chapter mark
 - T** : Appears when indicating a title / track number.
 - C** : Appears when indicating a chapter number.
- 4 Current status of the unit
 - ⏸** : Appears when Timer Recording is in standby, or is proceeding.
Disappears when all the Timer Recordings are finished.
- P-SCAN** :
Appears when the picture output is progressive scan. (DVD mode only)
- 5 **●DVR** : Lights up during recording with DVR.
- 6 Disc type and current status of the unit
 - CD** : Appears when an audio CD or the other disc is on the disc tray.
- 7 Displays the following
 - Played-back time
 - Current title / chapter / track number
 - Recording time
 - Clock
 - Channel number
 - Remaining time for a One Touch Recording

Display message



Appears when the unit is turning on.



Appears when the unit is turning off.



Appears when the disc tray is opening.



Appears when a disc is loaded on the disc tray.



Appears when the disc tray is closing.

Functional Overview (Cont'd)

Remote Control

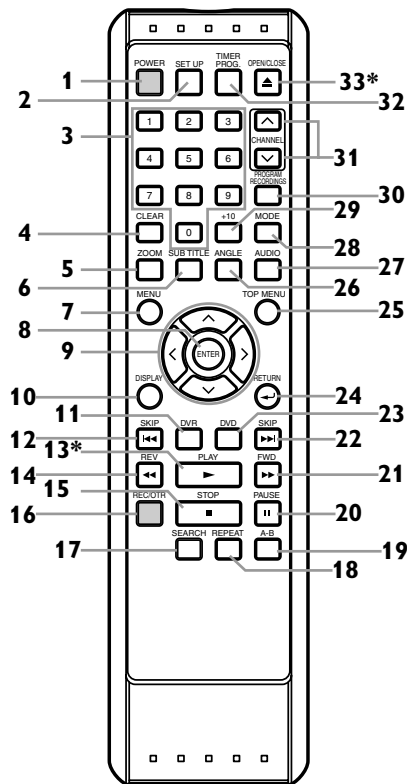

*The unit can also be turned on by pressing these buttons.

- 1 **POWER:** Turns the unit on / off.
- 2 **SET UP:** Press to display the Setup menu.
- 3 **Number Buttons:**
Press to select channel number.
Press to select a title / chapter / track on display.
Press to enter setting values.
Press to start the index / time search.
- 4 **CLEAR: (DVR)** Press to clear the program once entered in the Timer Recording setting mode.
(DVD) Press to clear the password entered or the program once entered, etc.
- 5 **ZOOM: (DVD)** Press to access the zoom function.
- 6 **SUBTITLE: (DVD)** Press to access the subtitle menu.
- 7 **MENU: (DVD)** Displays the Disc menu.
- 8 **ENTER:** Press to confirm or select menu items.
- 9 **^ / v / < / >:** Selects items or settings.
- 10 **DISPLAY:** Displays the on-screen menu.
- 11 **DVR: (DVR)** Press to activate the remote control and switches the unit in DVR mode (refer to page 13).

- 12 **SKIP <<<: (DVR)** Press to skip to the chapter.
Or when playback is paused, press to play back in reverse step by step.
(DVD) Press to skip to the previous title, chapter or track.
- 13 **PLAY >:*** Press to start or resume playback.
- 14 **REV <<:** During playback, press to play back in fast reverse. Or when playback is paused, press to play back in slow reverse.
- 15 **STOP ■: (DVR)** Press to stop playback or recording.
(DVD) Press to stop playback.
- 16 **REC / OTR: (DVR)**
Press once to start a basic recording. Press repeatedly to set a One Touch Recording.
- 17 **SEARCH: (DVD)** Press to access the search menu.
- 18 **REPEAT: (DVD)** Press to access the repeat function.
- 19 **A-B: (DVD)** Press to access the repeat A-B function.
- 20 **PAUSE II: (DVR)** Press to pause playback or basic recording.
(DVD) Press to pause playback.
- 21 **FWD >>>:** During playback, press to play back in fast forward. Or when playback is paused, press to play back in slow forward.
- 22 **SKIP >>>: (DVR)** Press to skip to the chapter.
Or when playback is paused, press to play back in forward step by step.
(DVD) Press to skip to the next title, chapter or track.
- 23 **DVD: (DVD)** Press to activate the remote control and switches the unit in DVD mode (refer to page 13).
- 24 **RETURN ↵:** Press to return to the previously displayed screen.
- 25 **TOP MENU:** Press to call up the Title menu.
- 26 **ANGLE: (DVD)** Press to select camera angles on a disc.
- 27 **AUDIO: (DVD)** Press to select audio languages on a disc.
- 28 **MODE: (DVD)** Press to set the black level and virtual surround on / off.
(CD / MP3 / WMA) Press to set the virtual surround on / off. Press to access the program / random play screen.
- 29 **+10: (DVD)** Press to enter the desired numbers which are higher than 9.
- 30 **PROGRAM RECORDINGS: (DVR)** Press to call up the Programmed Recordings Screen.
- 31 **CHANNEL ^ / v:** Press to change the channel up / down.
- 32 **TIMER PROG.: (DVR)** Press to access the timer program menu.
- 33 **OPEN / CLOSE ▲*:** **(DVD)** Press to open / close the disc tray.

Note

- Buttons indicated in blue effects only DVR mode.
- Buttons indicated in orange effects only DVD mode.

Functional Overview (Cont'd)

Installing batteries in the remote control

Install two AA-size batteries (supplied), matching their polarity to those indicated inside the battery compartment of the remote control.

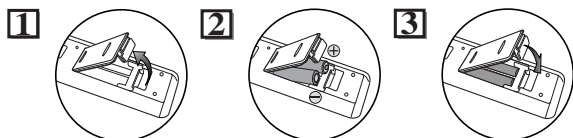

Battery use and care

Incorrect use of batteries can result in hazards such as leakage and bursting. Please follow the instruction below:

- Do not mix new and old batteries together.
- Do not use different kinds of batteries together. Although they may look similar, different batteries may have different voltages.
- Make sure that the plus and minus ends of each battery match the indications in the battery compartment.
- Remove batteries from equipment that is not going to be used for a month or more.
- When disposing of used batteries, please comply with governmental regulations or public rules for environmental protection that apply in your country or area.
- Do not recharge, short-circuit, heat, burn or disassemble batteries.

Using a remote control

Keep in mind the following when using the remote control:

- Make sure that there is no obstacle between the remote control and the remote sensor of the unit.
- Remote operation may become unreliable if strong sunlight or fluorescent light shines on the remote sensor of the unit.
- Remote control for different devices can interfere with each other. Avoid using remote controls for other equipment located close to the unit.
- Replace the batteries when you notice a fall-off of the operating range of the remote control.
- The maximum operable ranges (approximate) from the unit are as follows.
 - Straight line: 23 feet (7 m)
 - Either side of center: 16 feet (5 m) within 30°
 - Above: 16 feet (5 m) within 15°
 - Below: 10 feet (3 m) within 30°

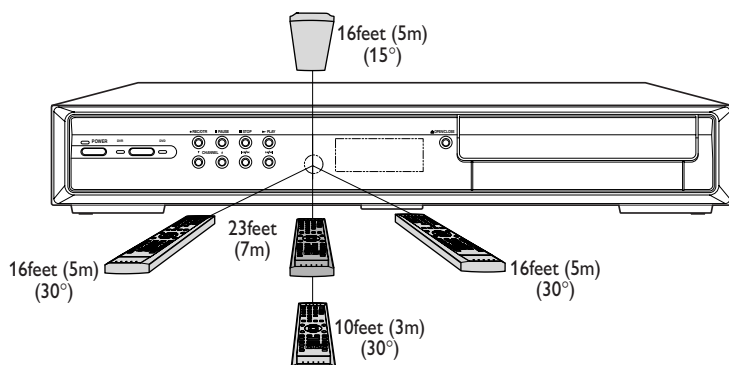

IR signal check

Use the AM radio or the digital camera to check if the remote control properly sends out the infrared signal. It will help to define the cause of malfunction.

Using AM radio

Tune the AM radio to no broadcasting band. Press any button on the remote control toward the radio. If the radio receives the signal from the remote control properly, the sound will flutter.

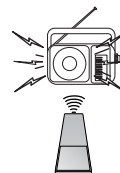

Using digital camera

(including built-in camera of cellular phone)

Press and hold any button on the remote control toward a digital camera. The remote control is working if you confirm infrared light through the digital camera.



Switching DVR / DVD

Because this product is a combination of a DVR and DVD Player, you must select first which component you wish to operate.

DVR mode

Press **DVR** on the remote control. (Verify that the DVR indicator is lit.)

DVD mode

Press **DVD** on the remote control. (Verify that the DVD indicator is lit.)

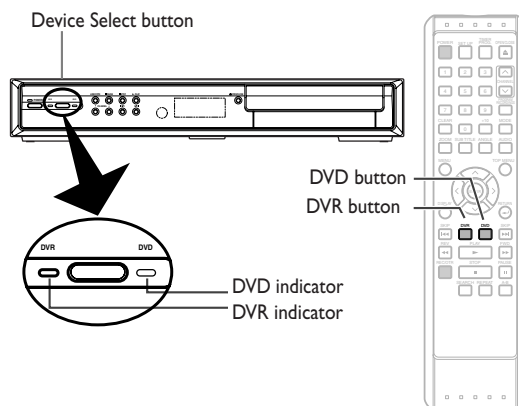

Functional Overview (Cont'd)

On-Screen Display for DVR Mode

General Information:

Press **DVR** first.

In stop mode, press **DISPLAY** once to show the general information.

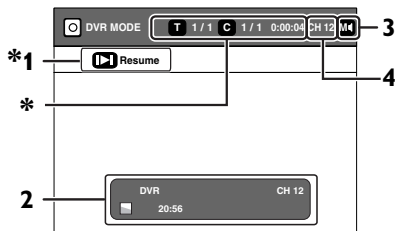

Each section includes the information as listed below:

- 1 Resume Playback status
- 2 Recording status
 - Recording channel number
 - Remained time of the DVR
- 3 Current audio status
- 4 Current channel number
- * These information will appear during playback or when the resume playback point is memorized.

Display Menu:

During playback in DVR mode, press **DISPLAY** once to show the information on the current operation status.

Press **DISPLAY** one more time to show the icons for the available features.

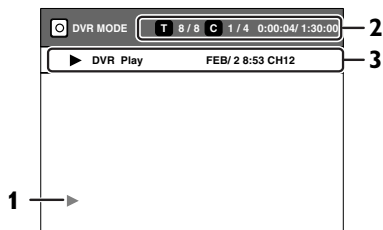

Press **DISPLAY**.

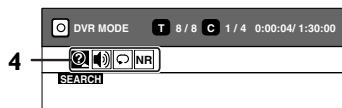

Each section includes the information as listed below:

- 1 Playback status icon
- 2
 - Current title number / total number of the titles
 - Current chapter number / total number of the chapters
 - Elapsed playback time of the current title / total time of the title
- 3
 - Playback status
 - Name of the current title
- 4 Icons for the available features:

: Search

: Audio

: Repeat

: Noise Reduction

Setup Menu:

Press **DVR** first.

Press **SET UP** to display “Easy Setting Menu” or “Advanced Menu”. Choose either menu using \wedge / \vee , then press **ENTER**.

(“Easy Setting Menu” consists of those frequently needed. You can make all required settings using “Advanced Menu”.)

Example :Advanced Menu

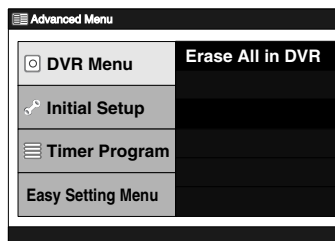

Using \wedge / \vee , select a menu, then press **ENTER**.

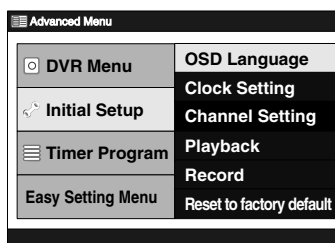

Using \wedge / \vee , select an Item to set, then press **ENTER**. Sub menu or option window will appear.

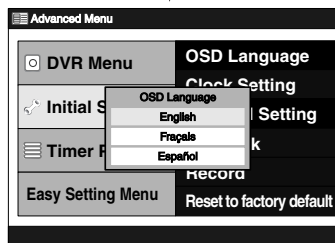

Using $\wedge / \vee / < / >$, make your desirable selection, then press **ENTER**.

Note

- This is an example screen only for explanation. Displayed items varies depending on the actual mode.
- The information will not appear, when there is no title recorded in the DVR.
- Closed Caption and V-Chip will not be displayed while the Display Information is shown on the screen.
- The Setup Menu in DVR mode will automatically disappear without any operation during 5 minutes.

Functional Overview (Cont'd)

On-Screen Display for DVD Mode

Display Menu:

Press **DVD** first.
Press **DISPLAY** repeatedly to see the information you need. The information will change in the order described in the example below every time you press **DISPLAY**.

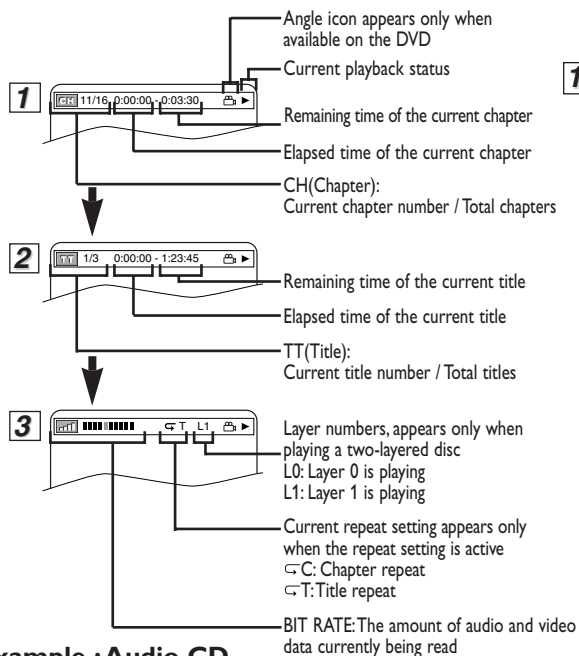

Example : Audio CD

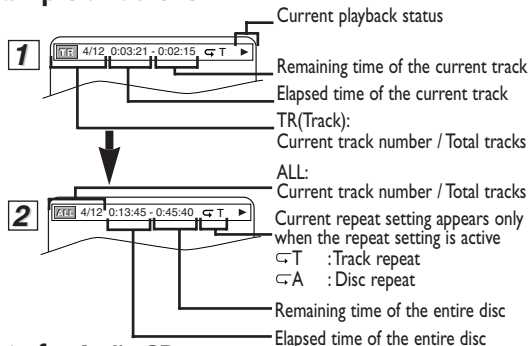

Note for Audio CD:

- When you are playing a disc in PROGRAM or RANDOM mode, PROGRAM (or RANDOM) will be displayed instead of 2.

Example : MP3 / WMA

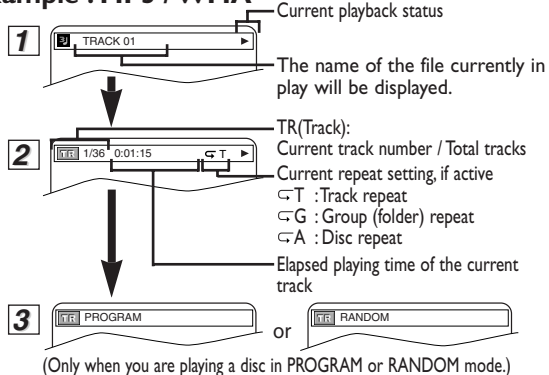

Note for WMA files:

1-A and 1-B will be displayed after 1.

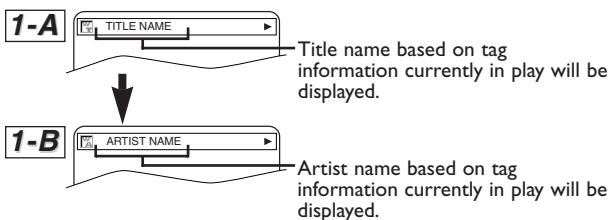

Setup Menu:

Press **DVD** first.

Press **SET UP** to display SETUP Menu. Choose QUICK SETUP Menu or CUSTOM Menu using < / >, then press **ENTER** to display it. These menus allow you to perform all main functions and change setting for them.

Example : DVD (CUSTOM Menu)

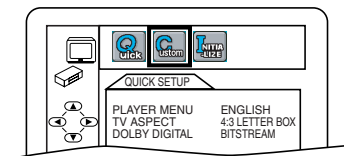

Using < / >, select a menu, then press **ENTER**.

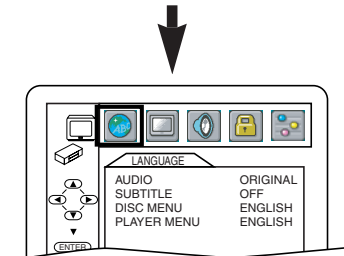

Using < / >, select an Item to set, then press **ENTER**.
Sub menu or option window will appear.

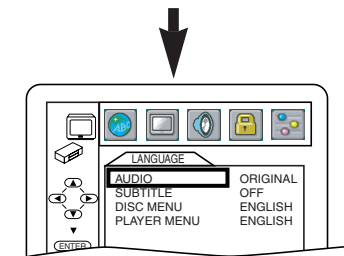

Using ^ / v, make your desirable selection, then press **ENTER**.

- : LANGUAGE menu
- : DISPLAY menu
- : AUDIO menu
- : PARENTAL menu
- : OTHERS menu

Connections

Connection to a TV

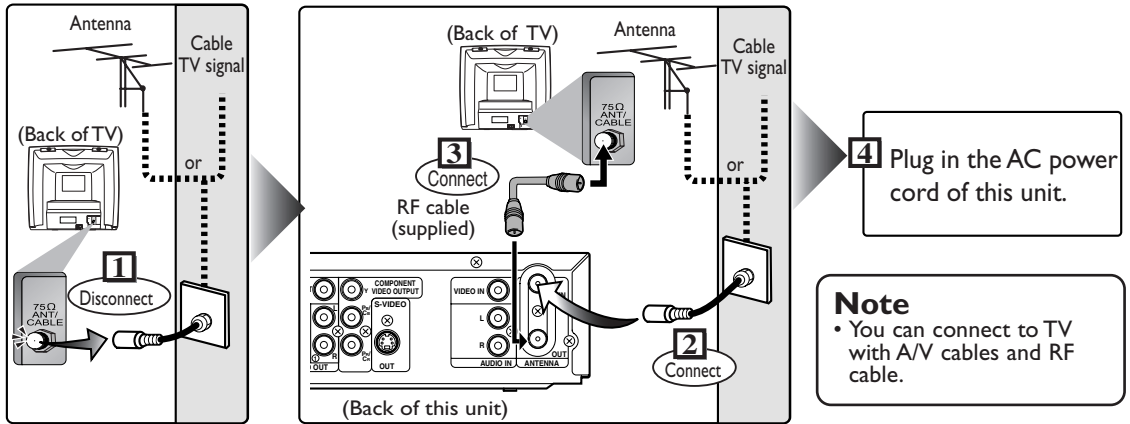

Choose one of the following connections, depending on the capabilities of the equipment you possess.

Basic Audio Connection

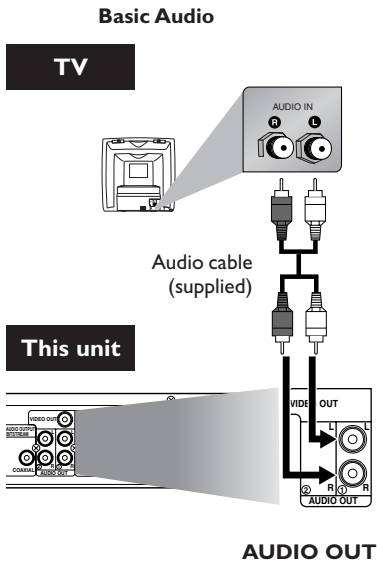

Video Connections

Method 1

Good picture

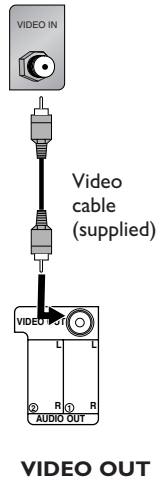

Method 2

Better picture

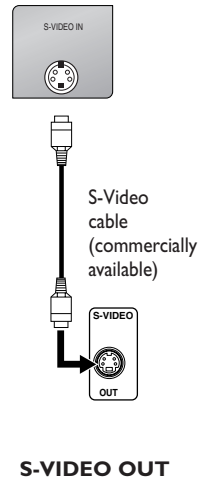

Method 3

Best picture

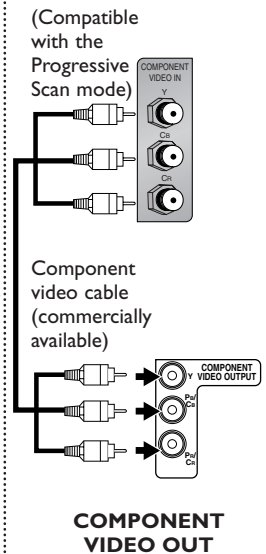

Note

- Connect this unit directly to the TV.
- **You will not be able to hear all of the sound being output by this unit if you use the video/audio cables (supplied) to a monaural TV that has only one audio input jack.**
- Be sure that the colors of the jacks and plugs match up when connecting the cable.
- If your TV is compatible with the Progressive Scan System, and you want to utilize its feature, use the COMPONENT VIDEO OUT connection. If you use any other connection such as VIDEO OUT or S-VIDEO OUT, the picture will not be output in the Progressive Scan mode but in the standard output mode (Interlace).

If your TV is compatible with 525p (480p) progressive scanning and you want to enjoy the high quality picture;

You must select the connection Method 3 to utilize the progressive scanning mode. To set the mode on/off, press and hold ► **PLAY** on the front panel for more than 5 seconds so that “P-SCAN” will appear on the Front Panel Display. (The progressive scanning is not available in the DVR mode.)

If your TV is not compatible with Progressive Scan;

Use this unit in the interlace mode. Make sure that no “P-SCAN” is on the Front Panel Display. If “P-SCAN” is on the Front Panel Display, press and hold ► **PLAY** on the front panel for more than 5 seconds to turn it off.

Connections

Connection to a TV (Cont'd)

After you have completed connections

Turn your TV to the appropriate external input channel (usually near channel 0) in order to view the pictures output from this unit on the TV. To find the external input channel press the channel button on your TV's remote repeatedly until the picture appears. External input channels may vary depending on the connection you made. Check your TV owner's manual for details.

Input Mode Names for Common TV Brands (Example)

Admiral	AUX	Panasonic	TV/VIDEO
Curtis Mathis	LINE1, LINE2, 00, 90, 91, 92, 93	RCA	INPUT, TV / VCR, 00, 90, 91, 92, 93
GE	INPUT, TV / VCR, 00, 90, 91, 92, 93	Samsung	TV / VIDEO
Hitachi	INPUT, AUX	Sanyo	VIDEO
JVC	VIDEO, VIDEO1, VIDEO2, VIDEO3	Sharp	00
Kenwood	AUX	Sony	VIDEO1, VIDEO2, VIDEO3
LXI-Series	00	Toshiba	TV / GAME
Magnavox	AUX CHANNEL	Zenith	00

Connection to a Cable Box or Satellite Box

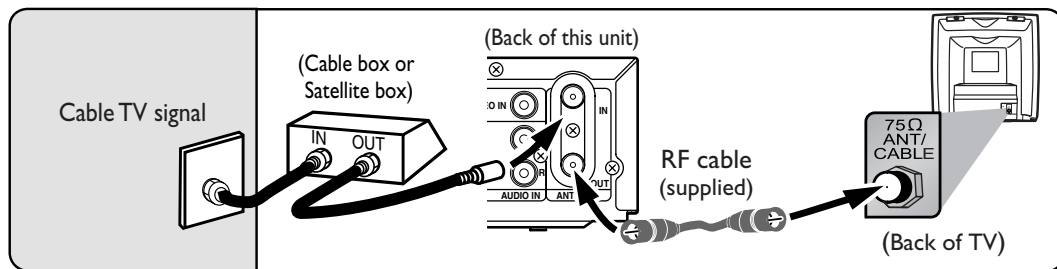

This connection allows you to view or record a scrambled channel. With this connection, channels cannot be changed on this unit. You can view or record ONLY the channels you have selected on the cable box or the satellite box.

- Read the instruction manual of the cable box or the satellite box also.

Note to the Cable TV System Installer:

This reminder is provided to call the Cable TV system installer's attention to Article 820-40 of the National Electrical Code, which provides guidelines for proper grounding—in particular, specifying that the cable ground shall be connected to the grounding system of the building, as close to the point of cable entry as possible.

Connections

Connection to an Audio System

- When you change the connections, all devices should be turned off.
- Refer to the operation manual accompanying external devices for more information.

Method 1

Stereo system

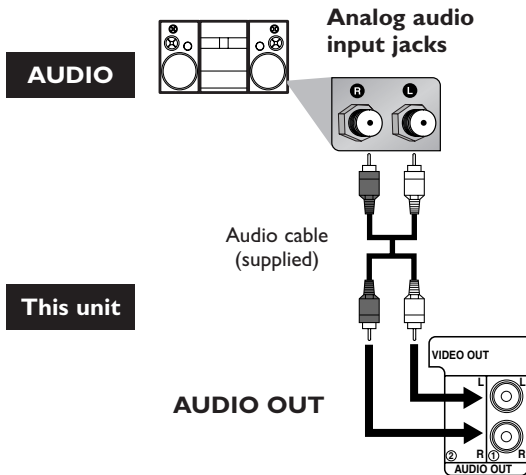

Method 2

Dolby Digital decoder, MD deck or DAT deck

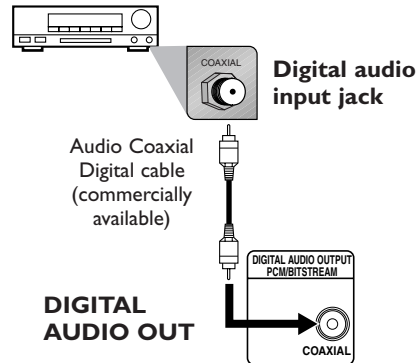

For DVR mode:

Connection	Setting	SETUP > Initial Setup > Playback > Audio Out >
		Dolby Digital
If output is Dolby Digital encoded audio, connect to a Dolby Digital decoder.		Stream
Unless connected to a Dolby Digital decoder.		PCM
Connecting to an MD deck or DAT deck.		PCM

For DVD mode:

Connection	Setting	SETUP > QUICK > DOLBY DIGITAL >
		DOLBY DIGITAL
If output is Dolby Digital encoded audio, connect to a Dolby Digital decoder.		BITSTREAM
Unless connected to a Dolby Digital decoder.		PCM
Connecting to an MD deck or DAT deck.		PCM

*To complete these settings. (See page 53 for DVR and 82 for DVD.)

Note

- By connecting this unit to a Multi-channel Dolby Digital decoder, you can enjoy high-quality Dolby Digital Multi-channel surround sound as heard in the movie theaters.
- The audio source on a disc in a Dolby Digital Multi-channel surround format cannot be recorded as digital sound by an MD or DAT deck.
- Playing back a DVD using incorrect settings may generate noise distortion and may also damage the speakers.

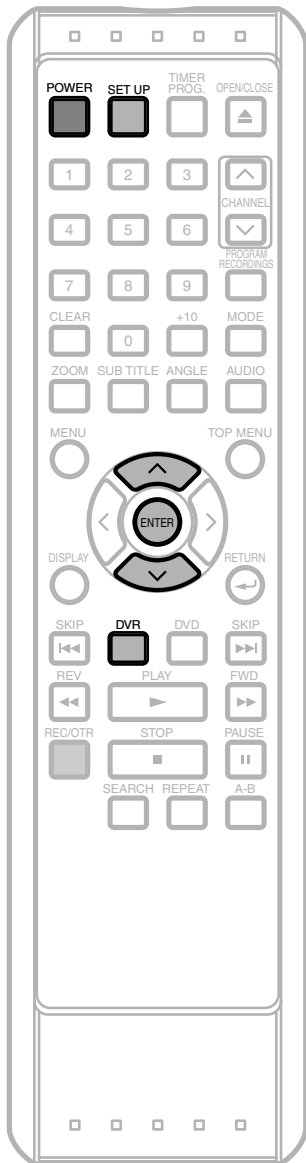

Turn on the Unit for the First Time

Right after the purchase of the unit, do the initial setting by taking the following procedures.

- 1 Press **POWER**.
- 2 Turn on the TV. Select the appropriate external input channel. (See page 17.)

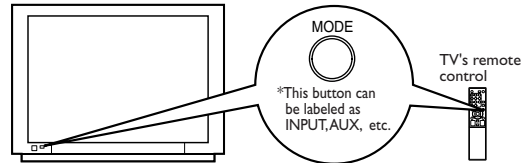

- 3 Using \wedge / \vee , select a desired language.

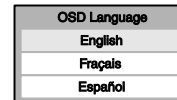

- 4 Press **ENTER** to start Auto Setups.

To change the On-Screen Language

- 1 Press **DVR** first, then press **SET UP**.
“Easy Setting Menu” or “Advanced Menu” will appear.

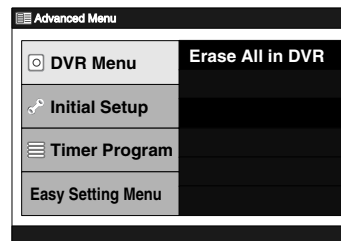

- 2 Using \wedge / \vee , select “Initial Setup”. Press **ENTER**.

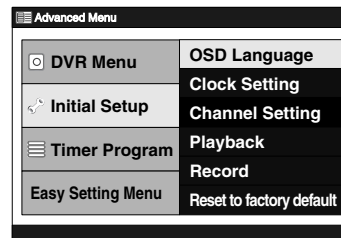

- 3 Using \wedge / \vee , select “OSD Language”. Press **ENTER**.

OSD Language Menu will appear.

- 4 Using \wedge / \vee , select a language. Press **ENTER**.
Your setting is now activated.
 - The default setting is “English”.

- 5 Press **SET UP** to exit.

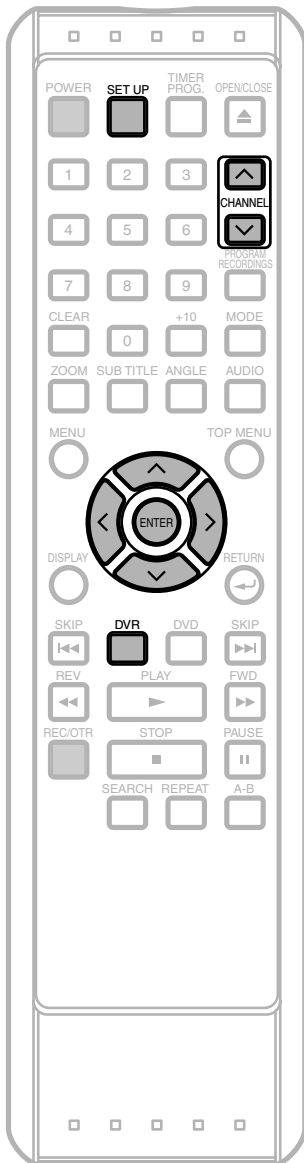

Getting Channels Automatically

Whenever you move to a new area, we recommend you to do this again to get available channels in your area.

Press **DVR** first.

- 1 Press **SET UP**.
“Easy Setting Menu” or “Advanced Menu” will appear.

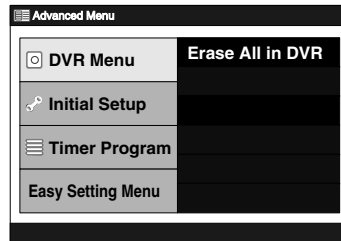

- 2 Using \wedge / \vee , select “Initial Setup”. Press **ENTER**.

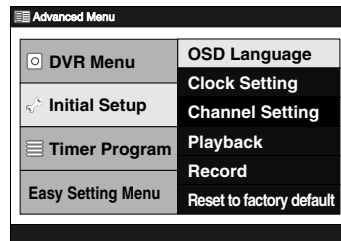

- 3 Using \wedge / \vee , select “Channel Setting”. Press **ENTER**.

Channel Setting Menu will appear.

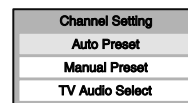

- 4 Using \wedge / \vee , select “Auto Preset”. Press **ENTER**.

The unit will start getting channels available in your area.



Wait for several minutes for channel scanning to be completed.

Note

- If the auto presetting is canceled during presetting, some of the channels not yet preset may not be received.
- The selection will depend on how you receive the TV channels.
- To cancel the Auto Preset during scanning, press **RETURN** \leftarrow .

After Auto Preset has stopped:

- Use **CHANNEL** \wedge / \vee or **the Number Buttons** to change the channel.
- When you use **the Number Buttons**, press **0** first for a single digit number.

Adding / Deleting Channels

The channels you no longer receive or seldom watch can be deleted from the memory. You can also add channels manually into the memory.

- 1 Press **SET UP**.
"Easy Setting Menu" or "Advanced Menu" will appear.

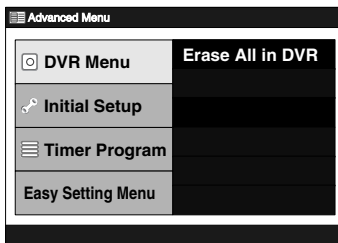

- 2 Using \wedge / \vee , select "Initial Setup".
Press **ENTER**.

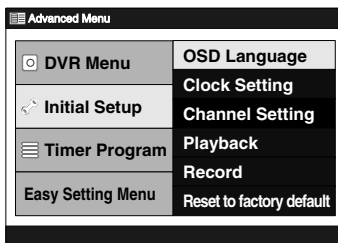

- 3 Using \wedge / \vee , select "Channel Setting".
Press **ENTER**.

Channel Setting Menu will appear.

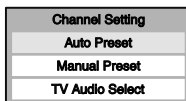

- 4 Using \wedge / \vee , select "Manual Preset".
Press **ENTER**.

Option window will appear.

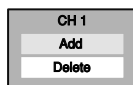

- 5 Using \lt / \gt , select the channel number to add or delete.
 - Use \lt / \gt or **CHANNEL** \wedge / \vee to change the channels one by one, or use the **Number Buttons** to select the channel directly.

- 6 Using \wedge / \vee , select "Add" or "Delete".
Press **ENTER**.

The channel number will be added or deleted from the channel memory. Then, the next channel number will appear so that you can continue adding or deleting channels.

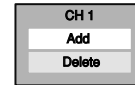

- 7 Press **SET UP** to exit.

Note

- External input channels ("L1") cannot be skipped.
- You cannot change the channel while the unit (DVR) is in the basic recording, OTR or Timer Recording mode.

DVR (Initial Setups)

Clock Setting

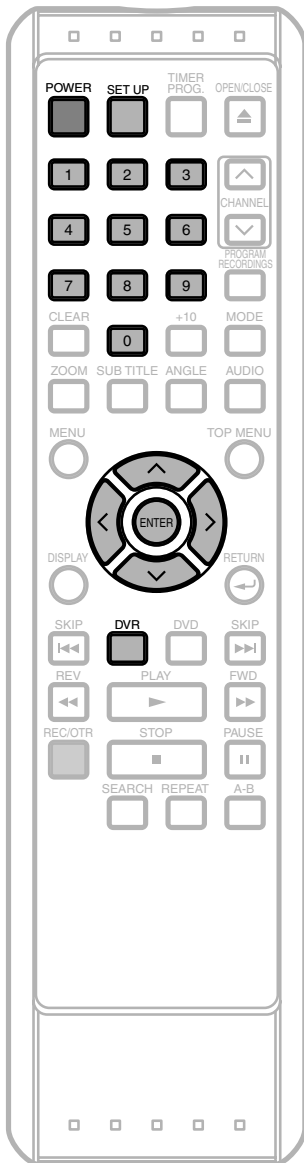

Set the clock before you try Timer Recording. If Public Broadcasting Service (PBS) is available in your area, follow the Auto Clock Setting below. If not, refer to 'Manual Clock Setting' on page 23.

Make sure the antenna / cable TV connections are correct.

- You cannot set the clock while the unit is in the basic recording, OTR or Timer Recording mode.

Auto Clock Setting

If this unit is connected to a Cable Box or Satellite Box, select the local PBS station to set the clock automatically. Press **DVR** first.

- 1 Press **SET UP**.
"Easy Setting Menu" or "Advanced Menu" will appear.

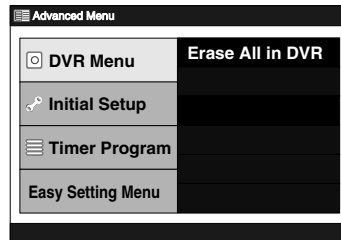

- 2 Using \wedge / \vee , select "Initial Setup". Press **ENTER**.

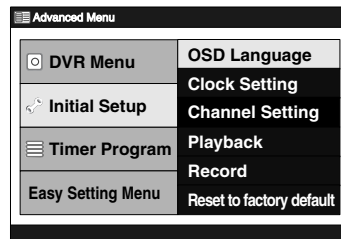

- 3 Using \wedge / \vee , select "Clock Setting". Press **ENTER**.

Clock Setting Menu will appear.

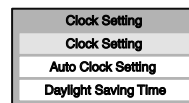

- 4 Using \wedge / \vee , select "Auto Clock Setting". Press **ENTER**.

Option window will appear.

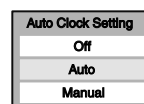

DVR (Initial Setups)

Clock Setting (Cont'd)

5 If you do not know the PBS channel number in your area :

Using \wedge / \vee , select **"Auto"**. Press **ENTER**.
Your setting is now activated.

If you know the PBS channel number in your area :

Using \wedge / \vee , select **"Manual"**. Press **ENTER**.
Input window will appear.



Using the **Number Buttons** or \wedge / \vee , enter the PBS channel number. Press **ENTER**.
Your setting is now activated.

If you want to set the clock manually and to cancel the Auto Clock Setting :

Using \wedge / \vee , select **"Off"**. Press **ENTER**.
The Auto Clock Setting will be canceled.

- The default setting is **"Auto"**.

6 Press **SET UP** to exit.

7 Press **POWER** to turn off the unit.

This unit will search for the clock time only when the power is off. Leave it off for several minutes to give the unit a time to set the clock.

Note

- The clock may set itself automatically after you connect the antenna / cable signal to this unit and plug in the power cord. In this case, the current time will appear on the Front Panel Display.
- If the current time is not displayed or the displayed clock time is not correct, set the clock manually.

Manual Clock Setting

- 1 Press **SET UP**.
"Easy Setting Menu" or **"Advanced Menu"** will appear.

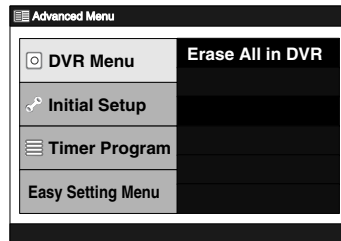

- 2 Using \wedge / \vee , select **"Initial Setup"**. Press **ENTER**.

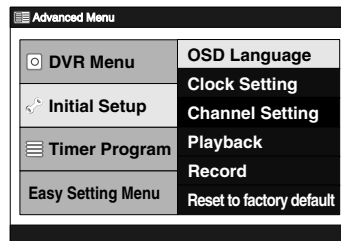

- 3 Using \wedge / \vee , select **"Clock Setting"**. Press **ENTER**.

Clock Setting Menu will appear.

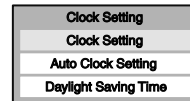

- 4 Using \wedge / \vee , select **"Clock Setting"**. Press **ENTER**.

Clock Setting Window will appear.

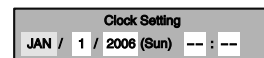

- 5 Using \lt / \gt , move to the item you want to set and using \wedge / \vee , change the setting the current date and time.

- 6 When all the information is entered, press **ENTER**.
Your setting is now activated.

Although seconds are not displayed, they will be counted from zero.

- 7 Press **SET UP** to exit.

Note

- Your clock setting will be lost if either there is a power failure or this unit has been unplugged for more than 30 seconds.

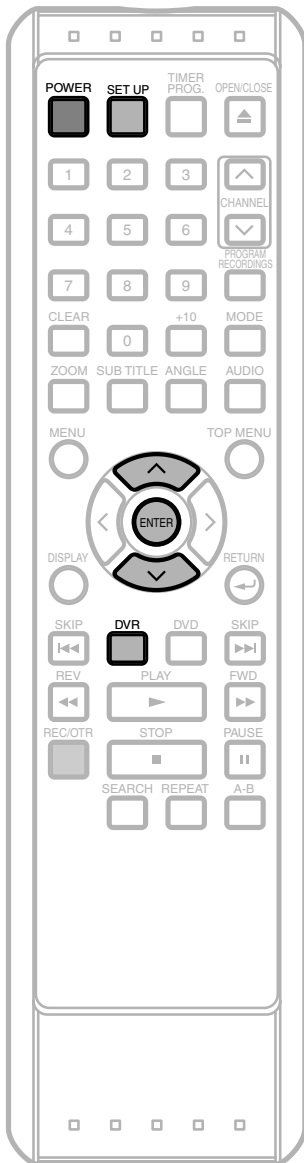

Setting Daylight Saving Time

When Daylight Saving Time is on, the clock will automatically move forward one hour at 2:00 AM on the first Sunday in April and move back one hour at 2:00 AM on the last Sunday in October.

Press **DVR** first.

- 1 Press **SET UP**.
“Easy Setting Menu” or “Advanced Menu” will appear.

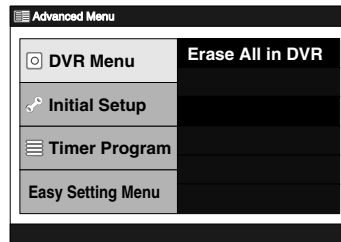

- 2 Using \wedge / \vee , select “Initial Setup”. Press **ENTER**.

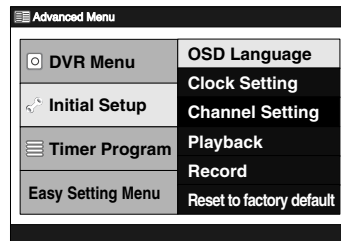

- 3 Using \wedge / \vee , select “Clock Setting”. Press **ENTER**.

Clock Setting Menu will appear.

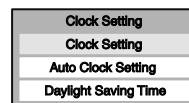

- 4 Using \wedge / \vee , select “Daylight Saving Time”. Press **ENTER**.

Option window will appear.

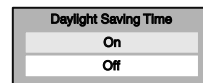

- 5 Using \wedge / \vee , select “On” to activate the Daylight Saving Time. Press **ENTER**.

If you do not want to use the Daylight Saving Time feature select “Off”.

- The default setting is “On”.

- 6 Press **SET UP** to exit.

DVR (Initial Setups)

TV Audio Setting

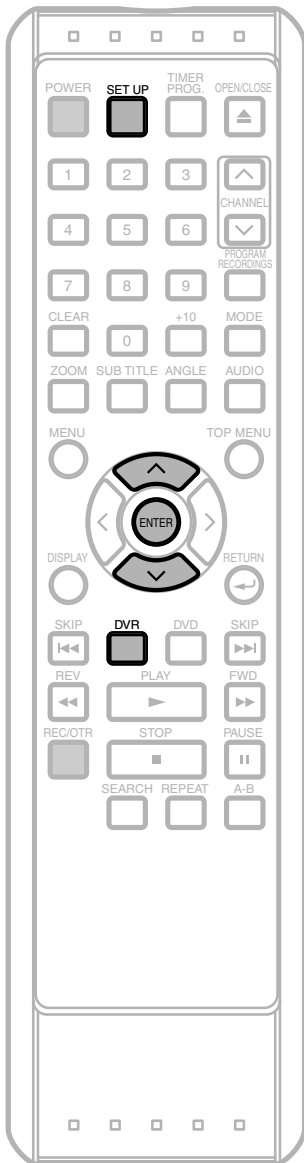

You can select an audio channel to output from TV.

Press **DVR** first.

1 Follow steps 1 to 4 on page 20 to display the Setup Menu.

2 Using \wedge / \vee , select “**Channel Setting**”. Press **ENTER**.

Channel Setting Menu will appear:

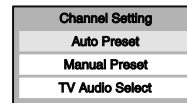

3 Using \wedge / \vee , select “**TV Audio Select**”. Press **ENTER**.

Option window will appear:



4 Using \wedge / \vee , select “**Stereo**” or “**SAP**”. Press **ENTER**.

Stereo:

Outputs main-audio.

SAP (Secondary Audio Program):

Outputs sub-audio.

Refer to the item in ‘Glossary’ on page 91 for more information.

- The default setting is “**Stereo**”.

5 Press **SET UP** to exit.

Notes on TV channel audio

- If you want to record a TV program available in second audio or stereo on DVR, you have to select either “**Stereo**” or “**SAP**” beforehand. Refer to the following table to check the appropriate setting.

Broadcast audio		Selected audio	DVR recording
Main-audio channel	Sub-audio channel		
STEREO	SAP	Stereo	STEREO
STEREO	NONE		STEREO
MONO	SAP		MONO
MONO	NONE		MONO
STEREO	SAP	SAP	SAP
STEREO	NONE		STEREO
MONO	SAP		SAP
MONO	NONE		MONO

- You can only play back the disc in second audio if a TV program is available in second audio and you set TV Audio Select to SAP.

Note

- This unit CANNOT record in both STEREO and SAP (Secondary Audio Program) at the same time.

SAP (Secondary Audio Program);

- SAP is the Secondary Audio Program which is usually used as an alternate in bilingual broadcasting, such as a broadcasting in Spanish. The SAP signal is delivered using the sub-audio channel. While the main-audio channel has 2 channels for L & R, the sub-audio channel has only 1 channel. Therefore, the SAP will always be broadcasted in monaural sound (outputting the same sound from the left and the right speakers).

DVR (Recording)

Basic Recording

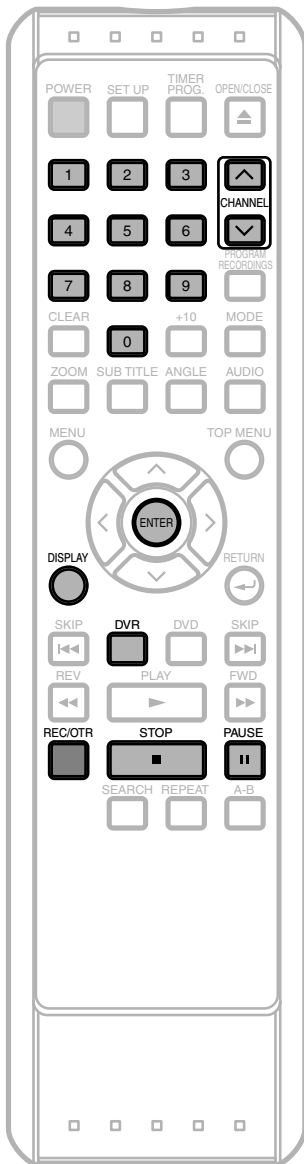

Follow steps below to record TV programs.

Press **DVR** first.

- 1 Turn on the TV. Select the appropriate external input channel. (See page 17.)
- 2 Using **CHANNEL** \wedge / \vee , or the **Number Buttons**, select a desired channel to record.



- 3 Press **REC / OTR** to start recording.
The information will be displayed for 5 seconds.

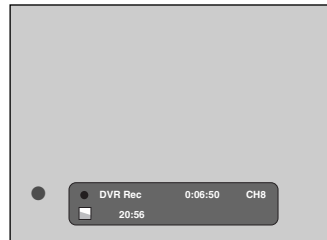

Press **PAUSE** \parallel to pause recording.
Press **REC / OTR** or **PAUSE** \parallel to resume recording.

- 4 Press **STOP** \blacksquare to stop recording.

Note

- This unit is equipped with a DVR with 80 GB hard disc which allows you to record up to 34 hours. You can not select a recording speed.
- Recording starts immediately after you press **REC / OTR** and continues until the DVR is full or you stop recording.
- When the Clock Setting has not been made, the space for a date and time of title names in the Title List will be blank.
- **When you record a TV program broadcasted in both Stereo and SAP-audio on the DVR, you have to select the TV channel audio (Stereo or SAP) beforehand. Only the selected channel audio will be recorded. Refer to 'TV Audio Setting' on page 25 for more details.**
- Up to 300 titles can be recorded on the DVR.

DVR (Recording)

One Touch Recording (OTR)



This is a simple way to set the recording time in blocks of 30 minutes.

Press **DVR** first.

Preparing for OTR:

- Check that the DVR has enough recordable space for the time you set.

1 Turn on the TV. Select the appropriate external input channel. (See page 17.)

2 Using **CHANNEL** \wedge / \vee or the **Number Buttons**, select a desired channel to record.

3 Press **REC / OTR**.
Recording will start.



4 Press **REC / OTR** repeatedly to change the recording time.

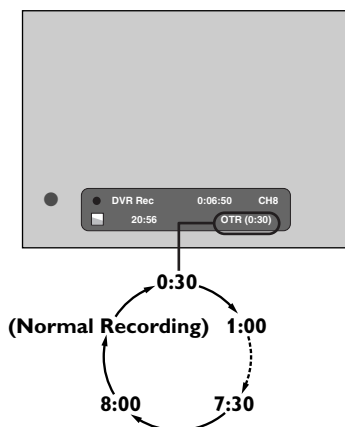

The recording time will be extended by 30 minutes every time you press **REC / OTR**.

- The maximum recording time is 8 hours.
- With OTR, the recording time that exceeds the remaining time will not be displayed.
- To change the recording time during the One Touch Recording, Press **REC / OTR** repeatedly.

5 When OTR ends, the unit will turn off automatically except under conditions listed below.

- If a Timer Recording is programmed to start in 5 minutes.
- During playback of DVR.
- While displaying menus or information on the screen.
- When DVD mode is selected.
- To cancel the OTR in progress, press **STOP** ■.

Note

- The remaining recording time will be displayed on the Front Panel Display during a One Touch Recording. Press **DISPLAY** to see it on the TV screen.
- You cannot pause a One Touch Recording.
- When a power failure occurs, the unit will turn off automatically in DVR mode.

Timer Recording

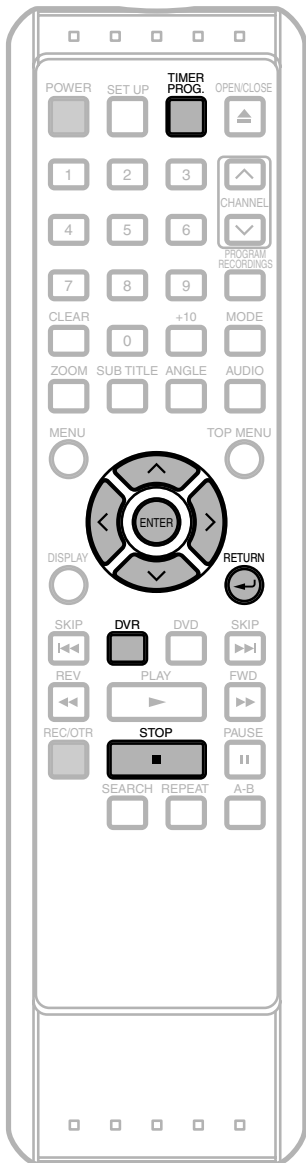

You can program the unit to record up to 32 programs within a month in advance. Daily or weekly recordings are also available.

Preparing for Timer recording:

- Be sure to set the clock before programming a Timer Recording. Refer to 'Clock Setting' on pages 22-24.
- Check that the DVR has enough recordable space for the time you set.

Press **DVR** first.

1 Press **TIMER PROG..**

Timer Programming List will appear.

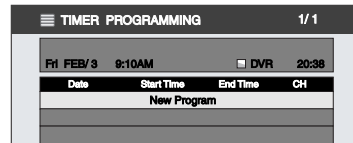

- You can access this screen from the Setup Menu also.

2 Using \wedge / \vee , select a line indicated "New Program". Press **ENTER**.

Timer Programming Window will appear.

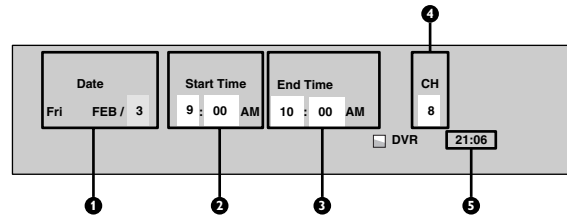

Timer Recording (Cont'd)

1 Recording Date:

When pressing \downarrow at the current date, the setting will change as follows. To go backward, press \wedge .

e.g.: January 1st

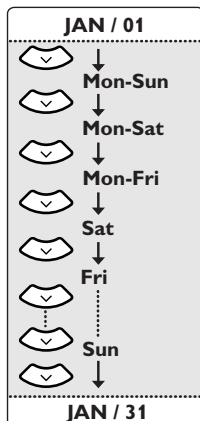

2 Start Time:

3 End Time:

4 Recording Channel:

To record from the external input, select “L1”.
(Using camcorder, or other source.)

5 Available recording time left on the DVR.

- If there are more than one program, the recording time of the programs other than the one being edited currently will not be counted in the calculation of the total remaining time on the DVR.

3 Using \langle / \rangle , select an item to set and using \wedge / \downarrow , set the contents to suit your preference.

- Pressing **RETURN** \leftarrow will resets all the information entered.

4 Press **ENTER** when all the information is entered.

\odot will appear in the Front Panel Display indicating one or more Timer Recordings are in standby.

- To set another program, repeat steps 2 to 4.
- When programs are overlapped, a warning message will appear. For details on overlapped Timer Programmings, refer to ‘Hints for Timer Recording’ on page 31.

5 To exit, press **TIMER PROG.**

- If you turn the unit off, it automatically turns on and starts recording 3 minutes before the Timer Recording begins, and when the recording is completed, you will be asked whether to turn off the unit. The unit will be turned off automatically if you select “Yes” or if you do not reply in 1 minute.
- To stop the recording in progress, press **STOP** \blacksquare and hold it for 2 seconds, or press **STOP** \blacksquare on the front panel.

Note

- If you have not set the clock yet:
The Clock Setting Window will appear at step 1 instead of Timer Programming List. Continue with step 4 in ‘Auto Clock Setting’ on page 22 or ‘Manual Clock Setting’ on page 23 before setting a Timer Recording.
- After step 5, you can use DVD mode as usual.
- If the starting time and the end time are the same, it will be recognized as 24 hours recording.
- If the starting time you entered is already in the past, the recording will start as soon as you activate the Timer Recording by pressing **ENTER** at step 4.
- If the Timer Recording you want to make starts at 11:00 PM, for example, and ends at 1:00 AM next day, enter the date of the starting time, then enter the starting time as 11:00 PM and end time as 1:00 AM.

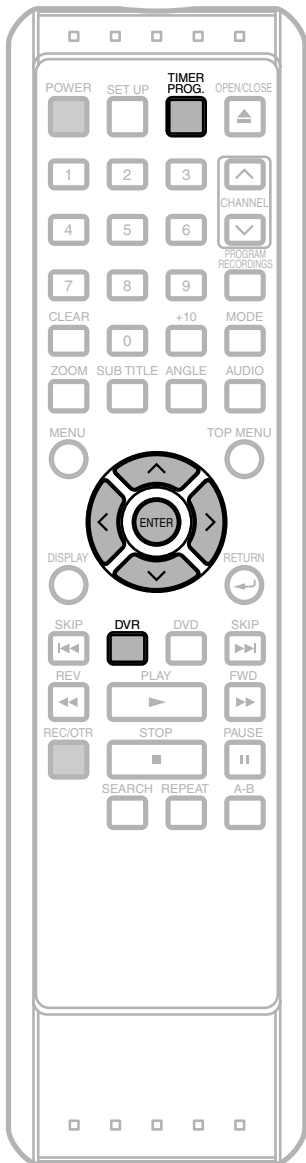

Editing the Timer Programming Information

Press **DVR** first.

- 1 Press **TIMER PROG.**.
Timer Programming List will appear.

TIMER PROGRAMMING				1/1
Fri FEB/3	9:10AM	<input type="checkbox"/> DVR	20:38	
Date	Start Time	End Time	CH	
Fri FEB/3	9:00AM	10:00AM	8	
Fri FEB/3	9:30AM	10:30AM	6	
Fri FEB/3	10:30AM	11:00AM	4	

- 2 Using \wedge / \vee , select the program you want to edit.
Press **ENTER**.

Editing Menu will appear.

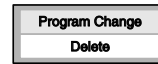

- 3 To change the setting of a program:
 1. Using \wedge / \vee , select "Program Change", then press **ENTER**.
Timer Programming Window will appear.

Date	Start Time	End Time	CH	
Fri FEB / 3	9 : 00 AM	10 : 00 AM	8	<input type="checkbox"/> DVR 20:06

2. Using \lt / \gt , move to the item you want to change, then press \wedge / \vee to change the setting.
Then, press **ENTER**.

Timer Recording (Cont'd)

To delete a program from the list:

- Using \wedge / \vee , select “Delete”, then press **ENTER**.

Confirmation window will appear.



You can access this screen by pressing **CLEAR** instead of **ENTER** at step 2.

- Using \lt / \gt , select “Yes” if you want to delete the title. Then, press **ENTER**.

4 Press **TIMER PROG.** to exit.

Note

- As to the timer program in progress (which is shown in red in the Timer Programming List), you only can edit the end time. The changes made during recording will be recognized as only specific to that recording in progress and it will not affect the daily or the Weekly Recording Setting.

Hints for Timer Recording

The priority of overlapped settings

When the timer programmings are overlapped, you will receive a warning message.

If this happens, check the timer programming and change the programming as necessary. Otherwise, the unit will prioritize recording as described below.

Same start time and different end time:

The program set first has the priority.

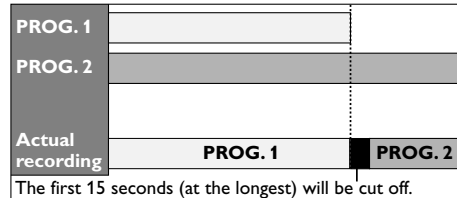

Different start time and different end time:

A program with the earlier start time has the priority.

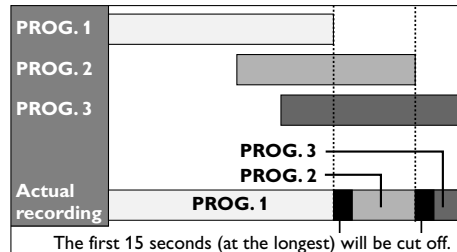

Recording time is entirely overlapped:

PROG. 2 will not be recorded.

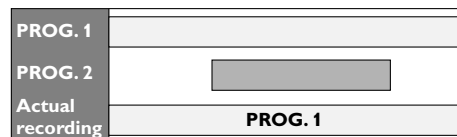

End time of Program 1 is the same as the start time of Program 2:

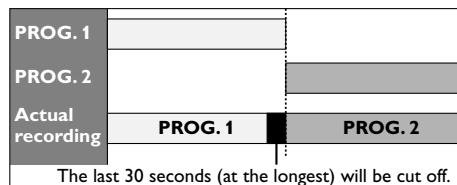

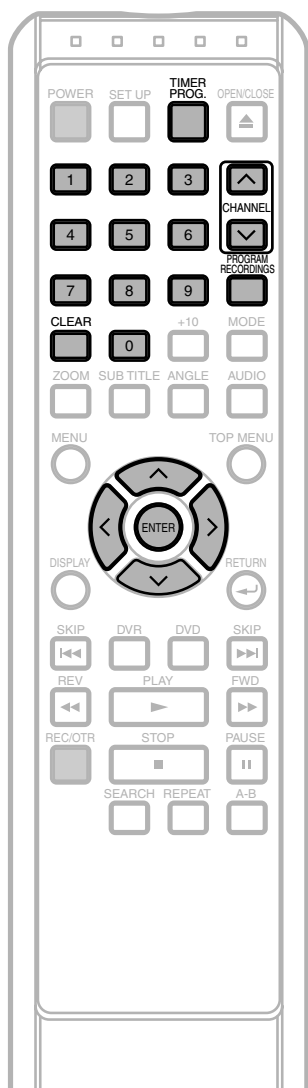

Guide to the Programmed Recordings Screen



With the Recording & Playback Navigator, you can easily program the Timer Recordings for the DVR by using the calendar displayed on the screen. Also the recorded titles (programs) can be played back or edited just by selecting the titles on the display.

- When you press **PROGRAM RECORDINGS**, the Programmed Recordings Screen will be displayed on the TV screen.

Programmed Recordings Screen

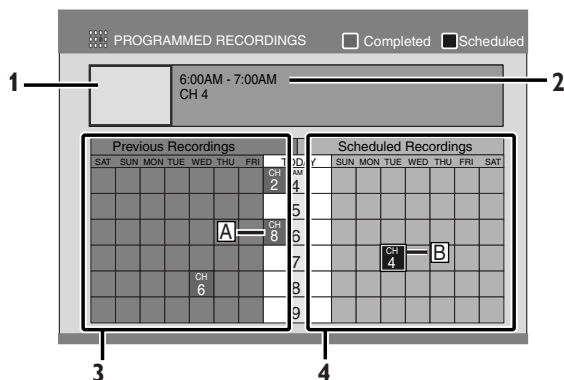

1 Preview window:

Playback the preview of recorded programs.

2 Information:

Shows the information on the selected program.

3 Previous recordings:

When the normal recording / Timer Recording has started, the cell turns blue and the channel number will be displayed. (e.g. **A**)

4 Scheduled Recordings:

When a programming is completed, the cell turns pink and the channel number will be displayed. (e.g. **B**)

Programmed Recordings Screen shows a two-week calendar. (One week prior to and one week after the current day.)

- Programmed Recordings can be programmed in this screen for programs broadcasted during next week.
- If more than one week has passed since recording, the recorded programs cannot be replayed or edited with Programmed Recordings.
- The screen describes each day as a day of the week, other than TODAY.

Note

- With the Recording & Playback Navigator, you can program Timer Recordings up to one week ahead. The recordings programmed for the days more than one week ahead will not be displayed in the Programmed Recordings Screen.
- You can program more than 1 Timer Recordings in one cell, but only the timer program that has the earlier starting time will be displayed in the Programmed Recordings Screen.
- To see all the programs entered in a cell, press **REV** ◀◀ or **FWD** ▶▶.
- If power is failed or unplugged from the outlet, some information in the Programmed Recordings Screen may be lost.
- Only the titles in the DVR can be played back using the Recording & Playback Navigator.

Programming a Recording with the Recording & Playback Navigator

1 Press **PROGRAM RECORDINGS**.
The Programmed Recordings Screen will appear.

2 Using $\wedge / \vee / < / >$, select the desired cell.
• For example, to record from 4:00 pm in two days from the present day, choose the cell as follows.

ordings		Scheduled Recordings							
THU	FRI	TODAY	SUN	MON	TUE	WED	THU	FRI	SAT
		PM 3							
		4							
		5							

Present day Tomorrow Day after tomorrow Cell

There are two ways to program a recording.

- 1) Direct Program---Press **CHANNEL** \wedge / \vee or the **Number Buttons** to select a channel. Press **ENTER**. The cell turns pink indicating that the timer programming is now set in that cell. Press **PROGRAM RECORDINGS** to exit.
- 2) Detailed Program---Press **ENTER** "New Program" will appear. With "New Program" selected, press **ENTER** again. Timer Programming Window will appear.

Date	Start Time	End Time	CH
Fri FEB / 3	9 : 00 AM	10 : 00 AM	8
<input type="checkbox"/> DVR			29:06

Enter the necessary information by following the instructions described in 'Timer Recording' on pages 28-31.

To Change or Cancel the Program

- 1 Repeat steps 1-2 above.
- 2 Press **ENTER** to call up the menu window.

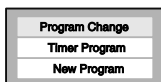

3 To change the program
Using \wedge / \vee , select "**Program Change**", then press **ENTER**.
Timer Programming Window will appear.
Correct the information, then press **ENTER**.

To cancel the program
Using \wedge / \vee , select "**Timer Program**", then press **ENTER**.
Timer Programming List will appear.
Press **CLEAR**.

Confirmation window will appear. Select "**Yes**", using $< / >$ and press **ENTER**.

To program a new Timer Recording
Using \wedge / \vee , select "**New Program**", then press **ENTER**.

4 Press **TIMER PROG.** to exit.

Playback and Edit with Programmed Recordings

- 1 Press **PROGRAM RECORDINGS**.
The Programmed Recordings Screen will appear.
- 2 Using $\wedge / \vee / < / >$, select the recorded program.
The recorded program plays back in the preview window.
- 3 Press **ENTER** to call up the menu window.

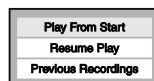

- 4** Using \wedge / \vee , select "**Play From Start**".
Press **ENTER**.
The recorded program is played back.
If you want to resume playback from the last viewed point:
Select "**Resume Play**".
Refer to 'Resume Playback' on page 37.
To display a Title List:
Select "**Previous Recordings**".
Refer to 'Playback from the Title List' on page 37.

DVR (Recording)

Settings for the External Devices

Connect the external source properly to the unit by using input jack, LINE1 (Rear).
When connecting an external equipment of monaural output to this unit, use AUDIO L jack of LINE 1 (Rear).
Use commercially available Video cable and an Audio cable for this type of connection.

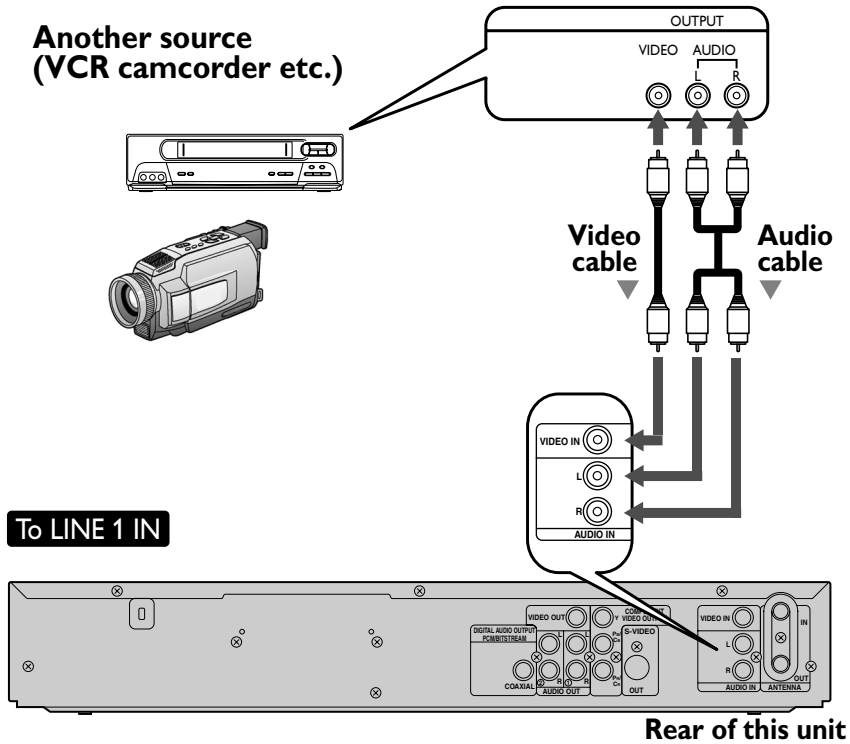

Note

- After all the connections are completed, set the DVR to the external input channel ("L1") using **CHANNEL** ^ / v.

Dubbing from the External Devices

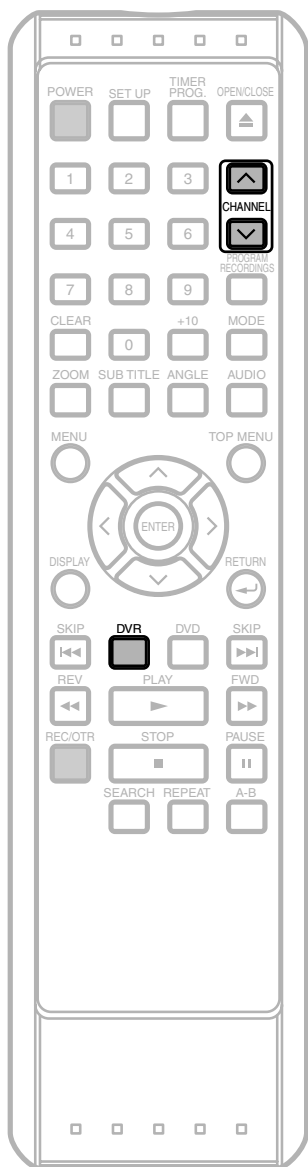

Before recording from the external device, connect the external device correctly by following the direction on page 34, and turn the power of the unit and the external device on.

- 1** Turn on the TV. Select the appropriate external input channel. (See page 16.)
- 2** Press **DVR**.
- 3** Select the appropriate external input channel of this unit by using **CHANNEL ^ / v** to set the channel to **"L1"**.
- 4** Press **REC/OTR** on the unit to start recording.
- 5** Press **PLAY** button on the external device to record from.
- 6** For DVR:
Press **■ STOP** on the front panel (this unit) first to stop recording.

This operation may take a while to be completed.

Then, stop the external device.

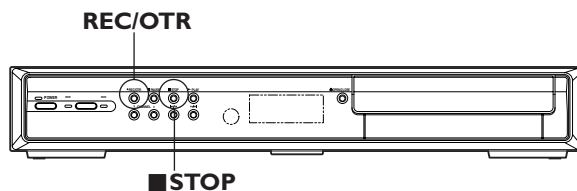

Note

- To avoid mistakes, it is recommended to use the buttons on the front panel to operate.
- Read also the instructions for the external device thoroughly.

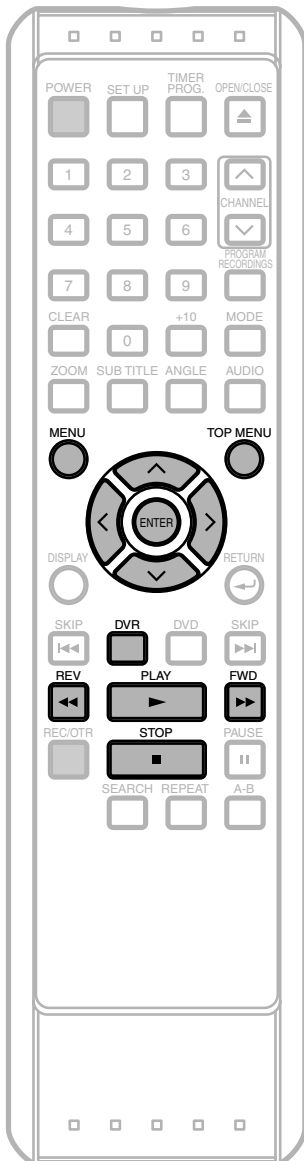

Direct Playback



Press **DVR** first.

- 1** Turn on the TV. Select the appropriate external input channel. (See page 17.)
- 2** Press **PLAY ▶** to start playback.
Playback of the last title will start.
 - The playback may start from a resume point. (See page 37.)
- 3** Press **STOP ■** to stop playback.

Playback from the Title List



Press **DVR** first.

- 1** Press **TOP MENU**.
Title List will appear.

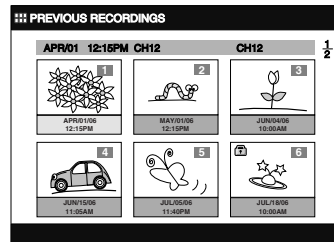

- To exit the Title List, press **TOP MENU**.

- 2** Using **↑ / ↓ / < / >**, select a desired title, then press **PLAY ▶**.
Playback will start.
 - Use **↑ / ↓ / < / >** to move among the titles one by one, and use **FWD ▶▶ / REV ◀◀** to jump to the next / previous Title List page.
 - For DVR, playback will start from the resume point. If you want to start it from the beginning, use the Title List Menu.

- 3** Press **STOP ■** to stop playback.

Playback from the Title List Menu



Press **DVR** first.

- 1 Press **TOP MENU**.
Title List will appear.

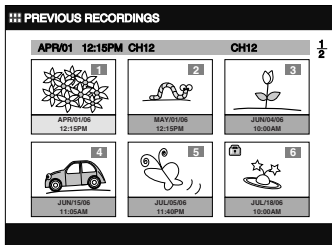

- To exit the Title List, press **TOP MENU**.

- 2 Using **^ / v / < / >**, select a desired title, then press **ENTER**.
Title List Menu will appear.

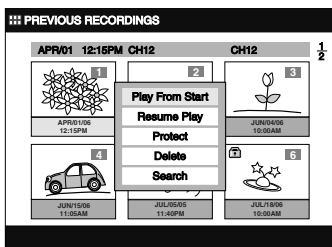

- Use **^ / v / < / >** to move among the titles one by one, and use **FWD ►► / REV ◀◀** to jump to the next / previous Title List Page.

- 3 Using **^ / v**, select **"Play From Start"** if you want to play the title from the beginning.
Select **"Resume Play"** if you want to play the title from the point where it is stopped last time.
Press **ENTER**.
Playback will start.

- 4 Press **STOP ■** to stop the playback.

Resume Playback



You can resume playback from where you stopped last time.

Press **DVR** first.

- 1 During playback, press **STOP ■**.
Pressing **STOP ■** twice will cancel the Resume function.

- 2 Press **PLAY ►**.
Within a few seconds, playback will resume from the point at which it stopped last. Resume function stays in effect even if you turn off the power.

You can set a resume point per every title.

- If you play back from the Title List Menu, you can choose **"Play From Start"** or **"Resume Play"**. Otherwise the playback will start from the resume point of the last played title.
- Press **STOP ■** twice at step 1 if you do not want to set a resume point. In this case, next time you press **PLAY ►**, the playback will start from the beginning of the last title in the Title List.

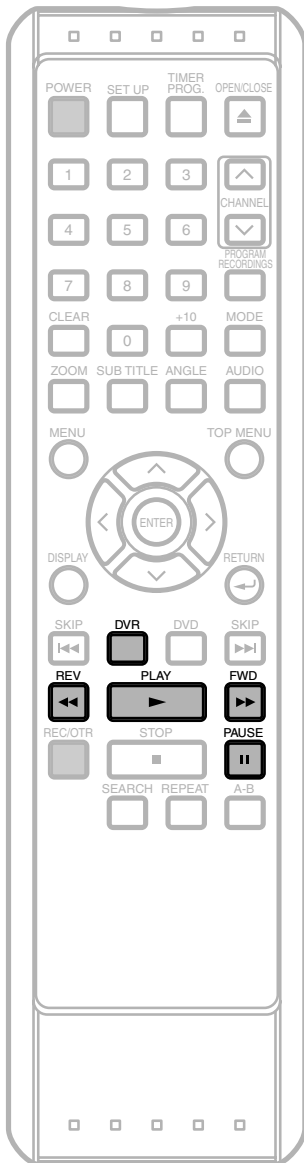

Fast forward / Fast reverse



Press **DVR** first.

- 1 During playback, press **FWD** ►► or **REV** ◀◀. Every time you press **FWD** ►► or **REV** ◀◀, approximate speed will change as follows. The sound will remain muted.

press button	-3	-2	-1	0	+1	+2	+3
►►: +1 ◀◀: -1							
speed (DVR)	x40	x20	x1	Normal speed	x1.5	x20	x40
OSD indication	▶▶▶▶	▶▶▶	▶▶	N/A	▶▶	▶▶▶	▶▶▶▶

- To return to the normal playback, press **PLAY** ►.
- Fast forward or fast reverse playback across titles is not possible.

Slow forward / Slow reverse



Press **DVR** first.

- 1 During playback, press **PAUSE** ||.
- 2 Press **FWD** ►► or **REV** ◀◀. Every time you press **FWD** ►► or **REV** ◀◀, approximate speed will change as follows. The sound will remain muted.

press button	-3	-2	-1	0	+1	+2	+3
►►: +1 ◀◀: -1							
speed (DVR)	x1/4	x1/8	x1/16	Normal speed	x1/16	x1/8	x1/2
OSD indication	▶▶▶▶	▶▶▶	▶▶	N/A	▶▶	▶▶▶	▶▶▶▶

- To return to the normal playback, press **PLAY** ►.

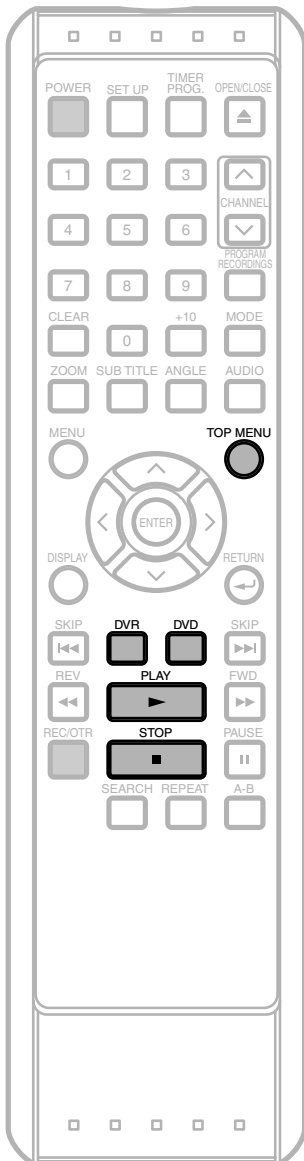

Time Shift Playback



You can playback a title being recorded from the beginning while recording continues.

Press **DVR** first.

- 1 Press **PLAY** ► during recording.
Playback of the title you are recording will start from the beginning.
 - Elapsed playback time will be displayed in the Front Panel Display.
- 2 To stop the playback, press **STOP** ■ **ONCE**.
 - The Front Panel Display will switch back to show the elapsed recording time.

IMPORTANT: If you press **STOP** ■ twice, it will stop the recording.

Simultaneous Playback and Recording



You can record a title on the DVR during a DVD playback. To do so, simply select the DVD mode for the playback by pressing **DVD** during DVR recording, then follow the normal procedure of playback.

You can also playback a title in the same device (DVR). To do so, press **TOP MENU** during recording and select a title you like to play, and then press **PLAY** ►. To playback a title being recorded while continuing to record, refer to 'Time Shift Playback' on this page.

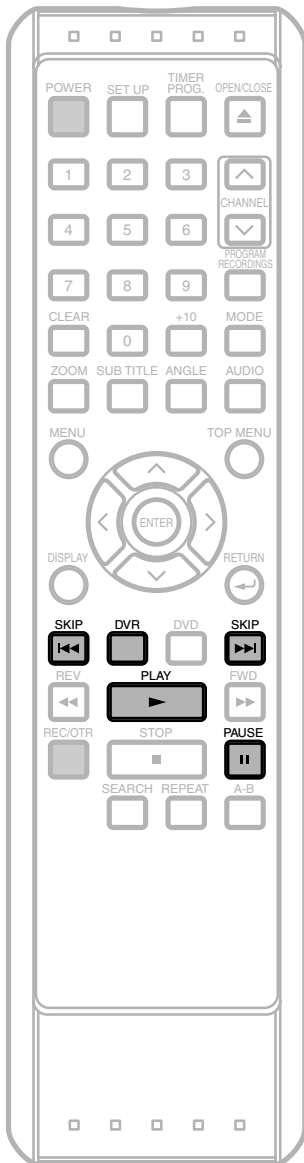

Pause



Press **DVR** first.

- 1 During playback, press **PAUSE II**. Playback will pause and sound will be muted.

- 2 Press **PLAY ►** to resume play.

Step-by-Step Playback



Press **DVR** first.

- 1 During playback, press **PAUSE II**. Playback will pause and the sound will be muted.

- 2 Press **SKIP ◀◀** or **▶▶** repeatedly. Every time you press **SKIP ◀◀** or **▶▶**, the playback will go backward or forward one frame at a time.

- 3 Press **PLAY ►** to resume normal playback.

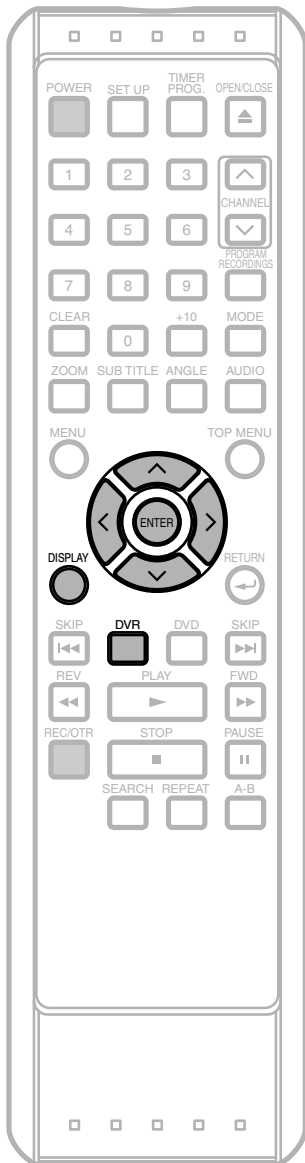



Repeat Playback

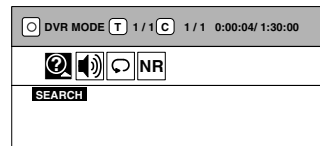

Press **DVR** first.

- 1 During playback, press **DISPLAY** twice. Icons for the available features will appear.



- 2 Using **< / >**, select  icon. Press **ENTER**. Option window will appear.

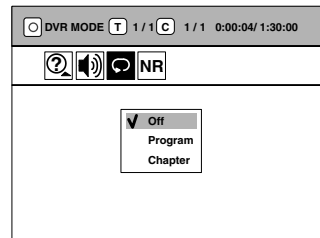

- 3 Using **^ / v**, select a desired option for repeat playback. Press **ENTER**.

The selected repeat playback will start.

Program:

The current title will be played back repeatedly.

Chapter:

The current chapter will be played back repeatedly.

Note

- To cancel the repeat playback, select **“Off”** at step 3. The Repeat Setting will be also cleared when you stop playback.
- Repeat playback is not available during Time Shift playback.

DVR (Playback)

Search

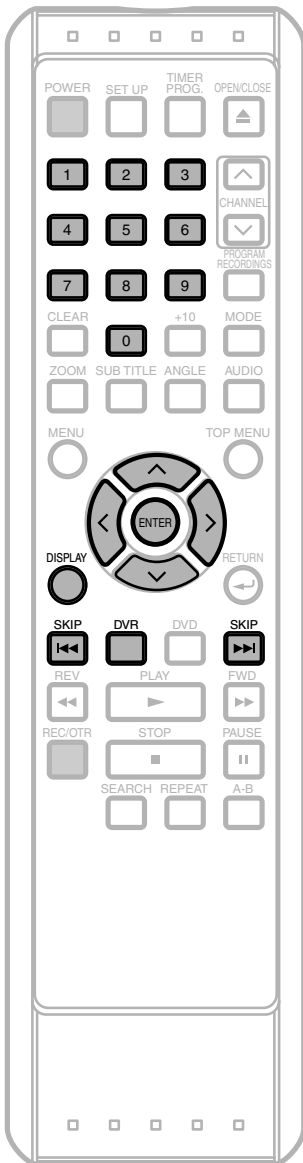

Title / Chapter Search



Press **DVR** first.

Using **SKIP** << / >>

- 1 During playback, press **SKIP** >> to skip to the next chapter.
Press **SKIP** << once to skip back to the beginning of the current chapter. Press **SKIP** << twice to skip back to the previous chapter.

Using **DISPLAY**

- 1 During playback, press **DISPLAY** twice.
Icons for the available features will appear.
- 2 Using < / >, select icon. Press **ENTER**.
The title number next to **T** will be highlighted.

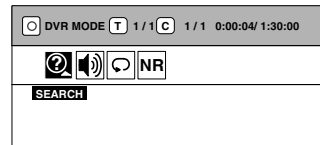

Title:

Using \wedge / \vee or the **Number Buttons**, enter a desired title number to search. Then, press **ENTER**.
Title Search will start.

Chapter:

Using $\>$, move to the number next to **C** for chapter.
Using \wedge / \vee or the **Number Buttons**, enter a desired chapter number to search. Then, press **ENTER**.
Chapter Search will start.

Note

- In Search Mode Display, total numbers of each search contents (title / chapter / time) are shown as a denominator.

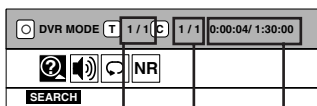

Current title number /
Total number of titles

Current chapter number /
Total number of chapters

Elapsed time of the
current title /
Total time of the
current title

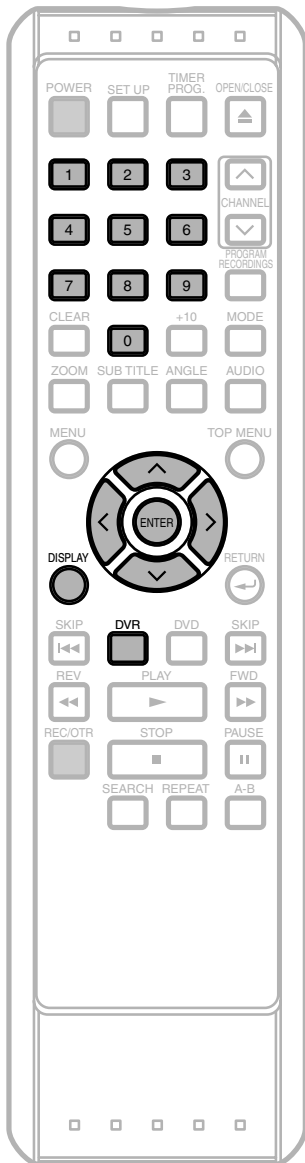

Time Search



Press **DVR** first.

- 1** During playback, press **DISPLAY** twice. Icons for the available features will appear.
- 2** Using **< / >**, select  icon. Press **ENTER**. The number next to **T** will be highlighted.

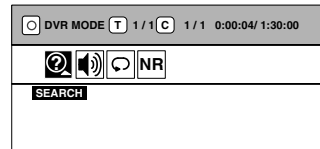

- 3** Move the cursor to the elapsed time counter using **>**.

Elapsed time counter

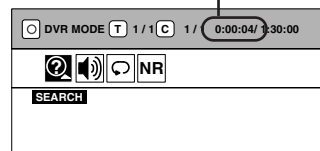

- 4** Using **^ / v** or the **Number Buttons**, enter a desired time to search. Press **ENTER**. Time Search will start.

Note

- Time Search is available only within the same title.
- Time Search is available only during playback.

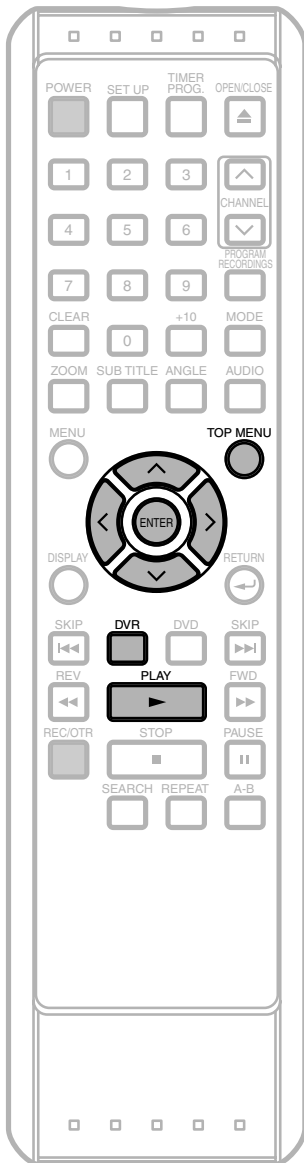

Series Search



You can search for the group of titles made with the same Periodical Timer Recordings. We refer to such a group of titles as "series".

Press **DVR** first.

1 Press **TOP MENU**.

Title List will appear.

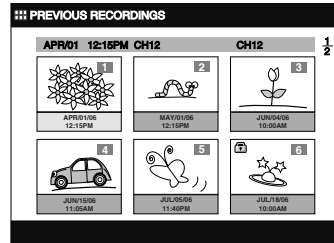

2 Using **^ / v / < / >**, select any title that belongs to the series you want to search and press **ENTER**.

Title List Menu will appear.

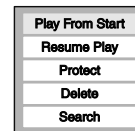

3 Using **^ / v**, select "**Search**". Press **ENTER**.

Series List will appear.

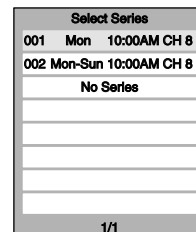

Highlight will be on the series that contains the selected title.

- 4** Using \wedge / \vee , select the desired series. Press **ENTER**.

Title List of the selected series will appear.

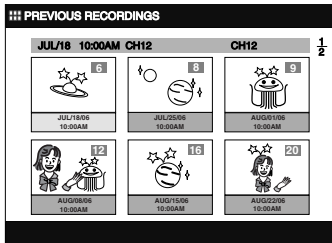

- 5** Using $\wedge / \vee / \leftarrow / \rightarrow$, select a desired title to play, then press **PLAY ▶**. Or press **ENTER** to call up the Title List Menu and select your desired playback style. To show the regular Title List, select **“Display All Program”** from the Title List Menu. Then press **ENTER**.

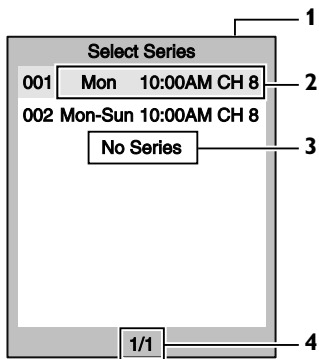

- 1** Series List
 - Up to 8 series can be displayed on 1 page.
 - The series that contains the oldest title comes first on the list.
- 2** Information on the series.
 - Type of the Periodical Recording (ex. every Monday), start time, and the recording channel. (In the example here, the information tells you this series is recorded on every Monday, starting at 10:00 AM on channel 8.)
- 3** No Series
 - All recordings which are not periodical fall into this category.
 - **“No Series”** will always be at the last on the list.
- 4** Current page / Total number of pages.
 - Up to 38 pages (300 series) are available.

Selecting a Format of Audio and Video

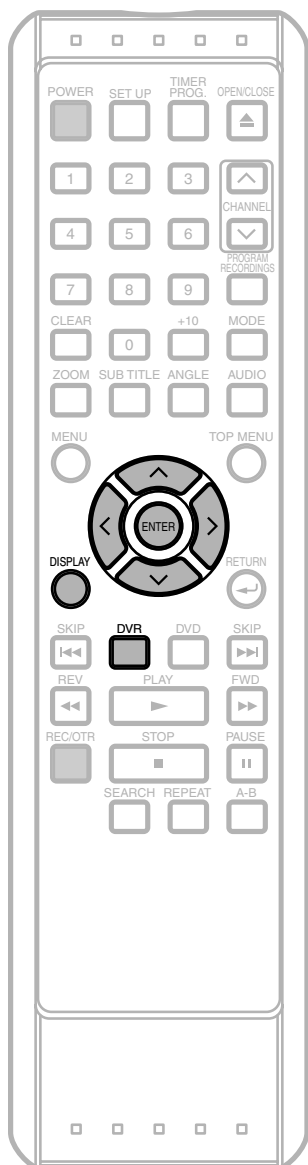

Audio Status



This feature allows you to check the current audio status. **It only affects during the playback of DVR.**

Press **DVR** first.

- 1 During playback, press **DISPLAY** twice. Icons for the available features will appear.

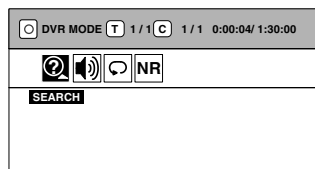

- 2 Using **< / >**, select  and press **ENTER**. Current audio status will appear.

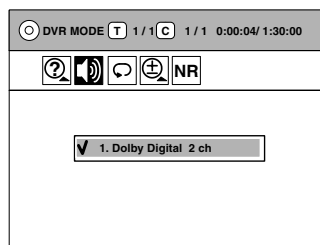

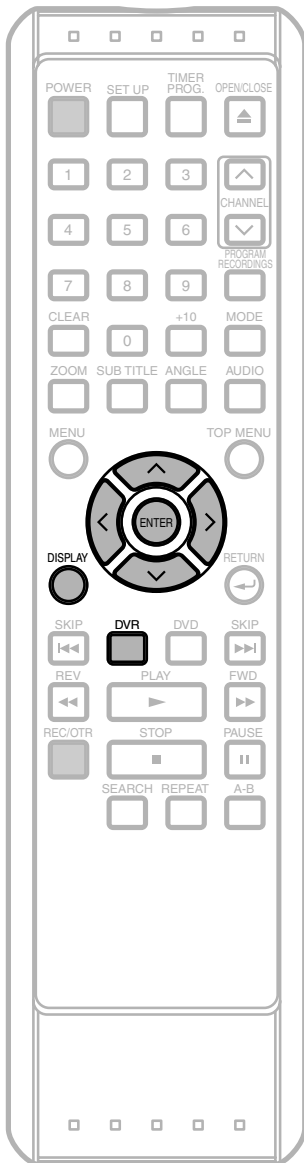

Visual Noise Reduction



This feature allows you to reduce visual noise during playback.

Press **DVR** first.

- 1 During playback, press **DISPLAY** twice. Icons for the available features will appear.

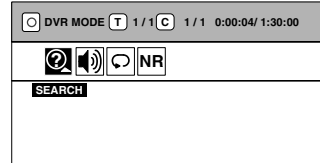

- 2 Using **< / >**, select **NR** icon. Press **ENTER**. Option window will appear.

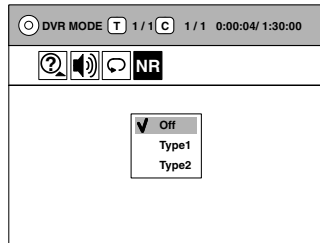

Off : No effect.

Type1 : Reduces the visual noise of the playback image.

Type2 : Same as type 1, only more effective.

- 3 Using **^ / v**, select a desired option. Press **ENTER**. Your setting is now activated.

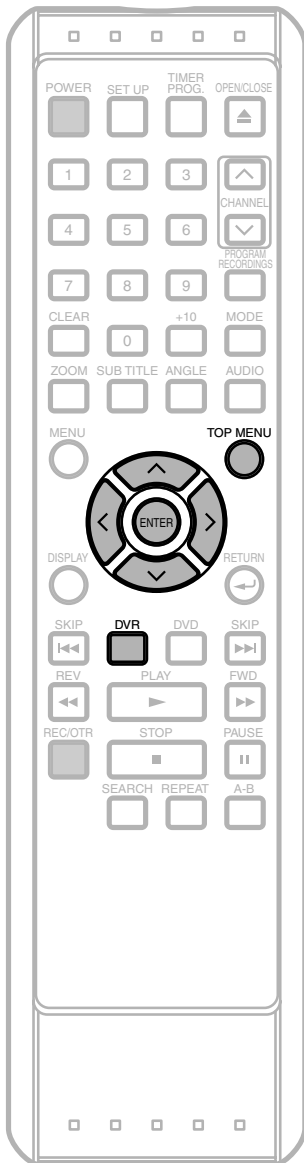

Deleting Selected Titles



You can delete titles which you do not need anymore. Be advised that the titles once deleted cannot be recovered.

Press **DVR** first.

- 1 Press **TOP MENU**. Title List will appear.

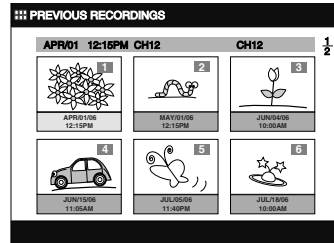

- 2 Using $\wedge / \vee / \langle / \rangle$, select a desired title to delete. Press **ENTER**. Title List Menu will appear.

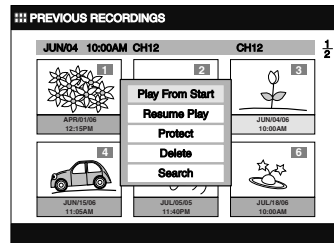

- 3 Using \wedge / \vee , select **"Delete"**. Press **ENTER**. Confirmation window will appear.

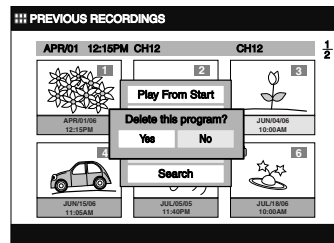

Deleting Titles (Cont'd)

- 4 Using **< / >**, select **"Yes"**. Press **ENTER**.
Final confirmation window will appear.

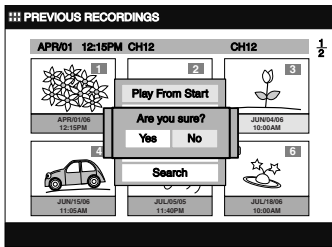

- 5 Using **< / >**, select **"Yes"**. Press **ENTER**.
The selected title is now deleted.

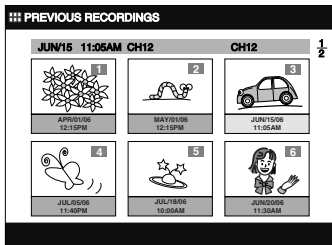

- 6 Press **TOP MENU** to exit.

Note

- Deleting titles will increase the recordable DVR space.

Deleting all Titles in DVR



Press **DVR** first.

- 1 Press **SET UP**.

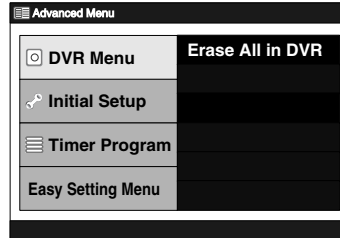

- 2 Using **^ / v**, select **"DVR Menu"**.
Press **ENTER**.

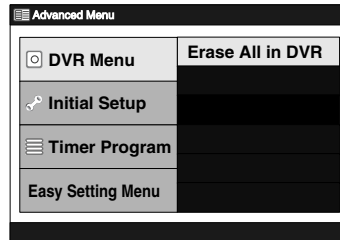

- 3 Press **ENTER** again.
Confirmation window will appear.

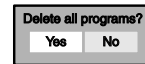

- 4 Using **< / >**, select **"Yes"**. Press **ENTER**.
Final confirmation window will appear.

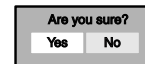

- 5 Using **< / >**, select **"Yes"**. Press **ENTER**.
All titles are erased.

Note

- Protected title will not be deleted, even if you select "Erase All in DVR".

Protecting / Undo Protecting Titles

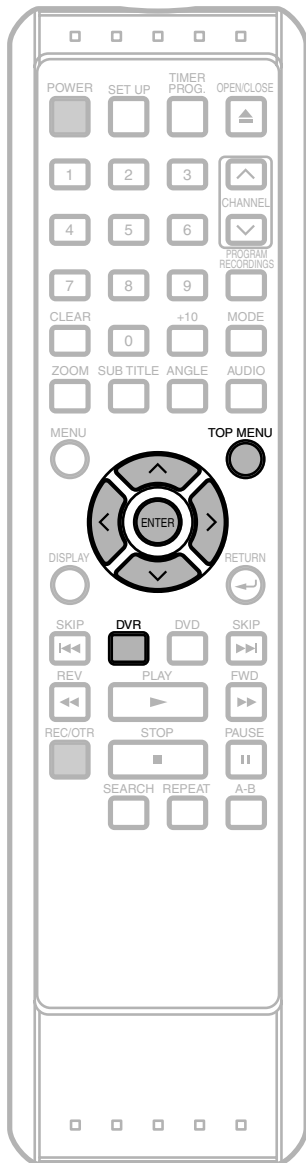

To prevent accidental title erasing, you can protect the contents in the Title List.

Press **DVR** first.

1 Press **TOP MENU**.

Title List will appear.

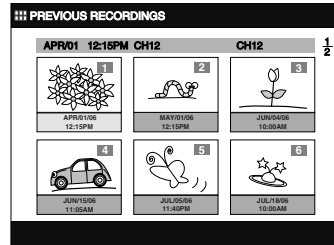

2 Using **^ / v / < / >**, select a desired title to protect. Press **ENTER**.

Title List Menu will appear.

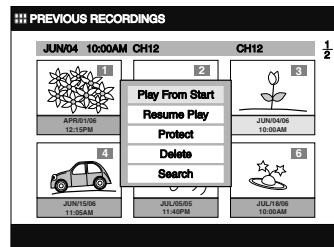

3 Using **^ / v**, select **“Protect”**. Press **ENTER**.

The key icon will appear at the upper left corner of the thumbnail.

If the title has already been protected **“Undo Protect”** will be listed in the Title List Menu instead of **“Protect”**. To cancel the protection, select **“Undo Protect”** and press **ENTER**. The key icon will disappear.

4 Press **TOP MENU** to exit.

DVR (Other Setups)

Tour of the Setup Menus

The following table shows the items which you can change the setting and their default settings. Refer to the following table for your convenience.

Setting menu	Items	Selection (highlight is the default)	Contents
OSD Language	➡ Page 19	English Français Español	Set the language for OSD (On Screen Display).
Clock Setting	Manual Clock Setting	➡ Page 23	
	Auto Clock Setting ➡ Pages 22-23	Off Auto Manual	
	Daylight Saving Time ➡ Page 24	On Off	
Channel Setting	Auto Preset	➡ Pages 20-21	
	Manual Preset	➡ Page 21	
	TV Audio Select ➡ Page 25	Stereo SAP	
Playback	TV Aspect ➡ Page 53	4 : 3 Letter Box 4 : 3 Pan & Scan 16 : 9 Wide	
	Audio Out ➡ Page 53	Dolby Digital PCM Stream	Set the type of sound signal output from the digital audio output jack.
Record	Auto Chapter ➡ Page 54	Off 5 minutes 10 minutes 15 minutes 30 minutes 60 minutes	
Reset to Factory Default	➡ Page 55		

Note

- If you change the settings in the Setup Menus, the information of the contents remain memorized even after the power is turned off.

DVR (Other Setups)

Playback Setting

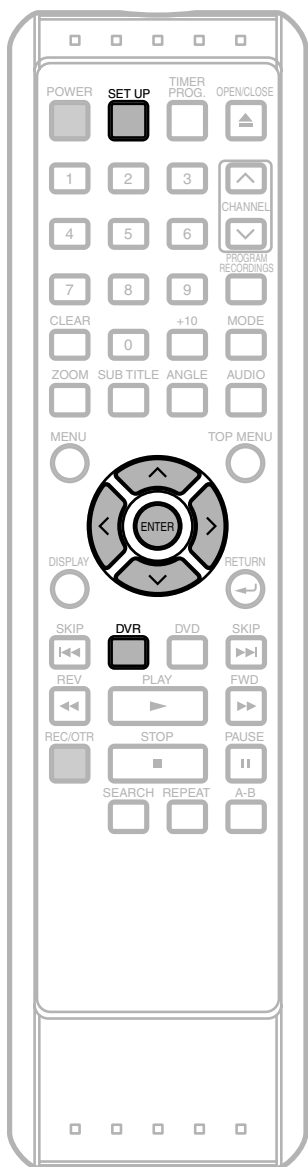

Press **DVR** first.

- 1 Press **SET UP**.
“Easy Setting Menu” or “Advanced Menu” will appear.
If “Advanced Menu” is displayed, proceed to step 3.

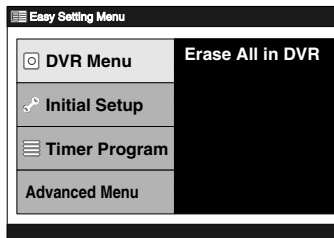

- 2 Using \wedge / \vee , select “Advanced Menu”.
Press **ENTER**.

- 3 Using \wedge / \vee , select “Initial Setup”.
Press **ENTER**.

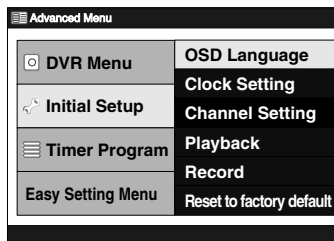

- 4 Using \wedge / \vee , select “Playback”. Press **ENTER**.
Playback Menu will appear.

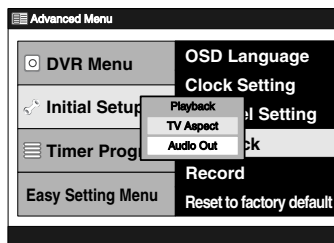

- 5 Using \wedge / \vee , select a desired item to set.
Press **ENTER**.
Menu or option window will appear.
- 6 Referring to the page 53, set the selected item.
- 7 When you finish with the setting, press **SET UP** to exit.

Playback Setting (Cont'd)

TV Aspect

You can select the TV aspect ratio to match the formats of what you are playing back on the unit and your TV screen (4:3 standard or 16:9 widescreen TV).
(Follow steps 1 to 4 on page 52.)

Using \wedge / \vee , select “**TV Aspect**”.

Press **ENTER**.

Menu window will appear.

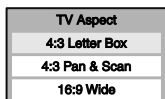

- Using \wedge / \vee , select a desired setting.

Press **ENTER**.

Your setting is now activated.

4:3 Letter Box:

For full-length picture with black bars on the top and bottom of the screen

4:3 Pan & Scan:

For a full-height picture with both sides trimmed

16:9 Wide:

For a widescreen TV

Audio Out

You can set the digital audio output.
(Follow steps 1 to 4 on page 52.)

Using \wedge / \vee , select “**Audio Out**”.

Press **ENTER**.

Menu window will appear.

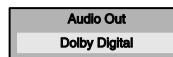

- Using \wedge / \vee , select a desired item to set.
Press **ENTER**.
Menu or Option window will appear.
Referring to the explanations below, set the selected item.

Dolby Digital (Default: Stream)

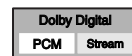

- Using \lt / \gt , select a desired setting.

Press **ENTER**.

Your setting is now activated.

PCM: Convert the Dolby Digital into “**PCM**” (2 channel).
When your amplifier / decoder is NOT compatible with Dolby Digital, set to PCM.

Stream: Outputs Dolby Digital signals.
When your amplifier / decoder is compatible with Dolby Digital, set to “**Stream**”.

Note

- If the audio on DVR is recorded in Dolby Digital format, set Dolby Digital to PCM so that you can switch to main audio (L), sub audio (R), or a mix of both (L / R) with your amplifier / decoder.

Recording Setting (Auto Chapter)

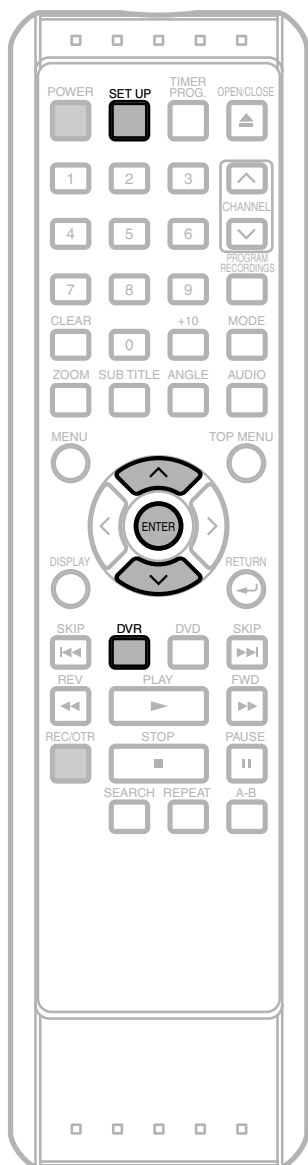

You can sort out the recording by inserting chapter marks every set time interval.

Press **DVR** first.

- 1 Press **SET UP**.
“Easy Setting Menu” or “Advanced Menu” will appear.
If “Advanced Menu” is displayed, proceed to step 3.

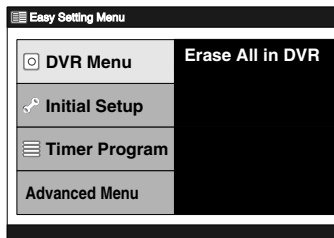

- 2 Using \wedge / \vee , select “Advanced Menu”. Press **ENTER**.

- 3 Using \wedge / \vee , select “Initial Setup”. Press **ENTER**.

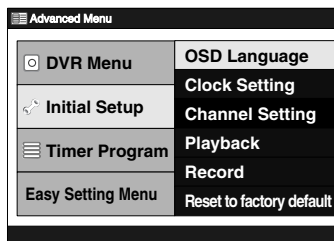

- 4 Using \wedge / \vee , select “Record”. Press **ENTER**.
Record Menu will appear.

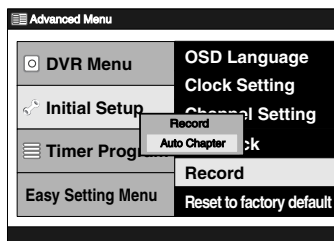

- 5 Press **ENTER** again.
Option window will appear.

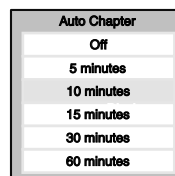

- 6 Using \wedge / \vee , select desired time option.
Press **ENTER**.

Your setting is now activated.

- The default setting is “10 minutes”.

- 7 Press **SET UP** to exit.

Note

- Depending the recording time, a chapter with no image may be created at the end.

Reset to Factory Default

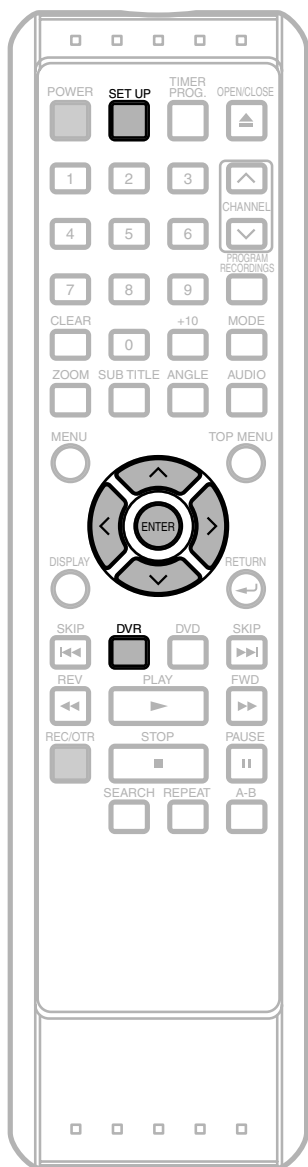

Resets the settings to the factory default (refer to the 'Note' on this page for the exceptions).
Press **DVR** first.

- 1 Press **SET UP**.
"Easy Setting Menu" or "Advanced Menu" will appear.
If "Advanced Menu" is displayed, proceed to step 3.

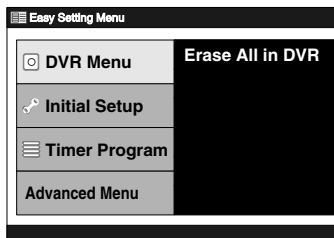

- 2 Using \wedge / \vee , select "Advanced Menu".
Press **ENTER**.

- 3 Using \wedge / \vee , select "Initial Setup".
Press **ENTER**.

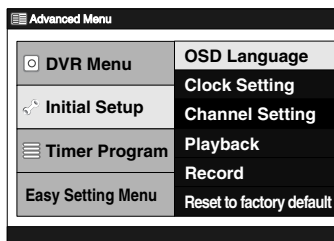

- 4 Using \wedge / \vee , select "Reset to factory default".
Press **ENTER**.

Confirmation window will appear.

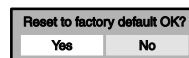

- 5 Using \lt / \gt , select "Yes". Press **ENTER**.
Final confirmation window will appear.

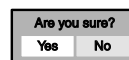

- 6 Using \lt / \gt , select "Yes". Press **ENTER**.
All settings are now reset to the factory default.

- 7 Press **SET UP** to exit.

Note

- The settings listed below will remain unchanged even after resetting to the factory default.
 - OSD Language Setting
 - Channel Setting
 - Clock Setting
 - DVR Timer Programs

DVD (Disc Playback)

About the Discs

Playable Discs

Playable discs	Mark (logo)	Region code	Recorded signals	Disc size	Disc types
DVD-Video * 1, 2, 4, 6, 10		or	Digital video (MPEG2)	5 inch (12 cm) or 3 inch (8 cm)	<p>Example</p> <p>Title 1 Chapter 1 Chapter 2 Chapter 3 Chapter 4 Title 2 Chapter 1 Chapter 2</p>
DVD-RW DVD-R * 1, 3, 4, 5, 6, 7, 9, 10	 	-			
DVD+RW DVD+R * 1, 3, 4, 5, 6, 8, 9, 10	 	-			
Audio CD * 4, 6, 10		-	Digital audio	5 inch (12 cm) or 3 inch (8 cm)	<p>Example</p> <p>Track 1 Track 2 Track 3 Track 4 Track 5 Track 6</p>
CD-RW CD-R * 4, 5, 6, 9, 10	 	-	Digital audio or MP3/ WMA *11	5 inch (12 cm) or 3 inch (8 cm)	<p>Example</p> <p>Group 1 Track 1 Track 2 Track 3 Track 4 Group 2 Track 5 Track 6</p>

DVD is a trademark of DVD Format/Logo Licensing Corporation.

If you cannot play back a disc which bears one of the marks above, check the following notes.

- *1: This unit conforms to the NTSC color system. Discs recorded in other color systems such as PAL cannot be played back.
- *2: Certain DVD-Video discs do not operate as described in this manual due to the intentions of the disc's producers.
- *3: Discs recorded in the VR (Video Recording) format cannot be played back.
- *4: Scratched or stained discs may not be played back.
- *5: Some discs cannot be played back because of incompatible recording conditions, characteristics of the recorder or special properties of discs.
- *6: You can play back discs which bear the marks above. If you use nonstandardized discs, this unit may not play them back. Even if they are played back, the sound or video quality will be compromised.
- *7: You may play back the unfinalized DVD-RW/R disc recorded in the video format on our brand's DVD recorder. However, depending on the recording status of a disc, the disc may not be played back at all or normally (the picture or sound may not be smooth, etc.). In this case, you need to finalize the disc with the DVD recorder. Refer to the manual accompanying the DVD recorder.
- *8: Only the discs recorded in the video format and finalized can be played back. Unfinalized discs cannot be played back. Depending on the recording status of a disc, the disc may not be played back at all or normally (the picture or sound may not be smooth, etc.).
- *9: If there is too much recording space left on a disc (less than 2 3/16 inches (55 mm) across), it may not play back properly.
- *10: Do not glue paper or put stickers on to the disc. These may damage the disc and the unit may not read it correctly.
- *11: This unit cannot playback the disc contents protected by Windows Media Digital Rights Management (DRM).

Unplayable Discs

- **NEVER play back the following discs. Otherwise, malfunction may result!**
DVD-RAM / CD-i / Photo CD / Video CD / DVD with region codes other than 1 or ALL
DTS-CD / DVD-ROM for personal computers / CD-ROM for personal computers
- **On the following disc, the sound MAY NOT be heard.**
Super Audio CD / DVD-Audio
NOTE: Only the sound recorded on the normal CD layer can be delivered.
The sound recorded on the high density Super Audio CD layer cannot be delivered.
- Any other discs without compatibility indications

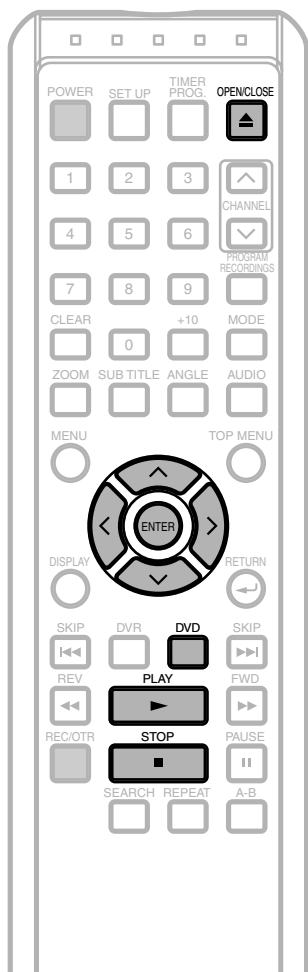

Basic Playback



Before: Turn on the TV, this unit, the amplifier and any other equipment which are connected to this unit. Make sure the TV is set to the correct channel.

Press **DVD** first.

1 Press **OPEN / CLOSE ▲**.
The disc tray will open.

2 Insert your disc with its label facing up. Align the disc to the disc tray guide.

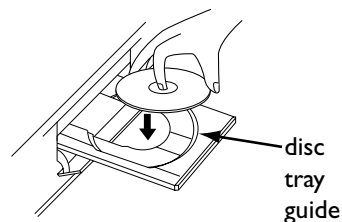

3 Press **OPEN / CLOSE ▲** to close the disc tray.

This operation may take a while to be recognized.

4 Press **PLAY ►**.
Playback will start.

5 Press **STOP ■** to stop playback.

To eject the disc, press **OPEN / CLOSE ▲** to open the disc tray, then remove the disc before turning off the unit.

General Features

DVD may contain menus to navigate the disc and access special features. Press the appropriate Numeric buttons or use **▲ / ▼ / ◀ / ▶** to highlight your selection in the DVD main menu and press **ENTER** to confirm.

TIP:

You can change the On-Screen language in "PLAYER MENU" setting. (Refer to pages 79, 80.)

Note

- For playing back an MP3/WMA file, see page 64.
- A "prohibited icon" may appear at the top-right on the TV screen when the operation is prohibited by the disc or this unit. 
- Some DVDs may start playback from title 2 or 3 due to specific programs.
- During the playback of a two-layered disc, pictures may stop for a moment. This happens while the 1st layer is being switched to the 2nd layer. This is not a malfunction.
- Don't leave the disc exiting halfway from the slot. Tracking will be automatically adjusted upon playback.
- The tray will close automatically, and playback will then start from the first chapter or track of the disc.
- When you play back a DVD with a title menu recorded, it may appear on the screen. In this case, refer to "Title Menus" on page 58.

Menu operations may vary depending on the disc. Refer to the manual accompanying the disc for more details.

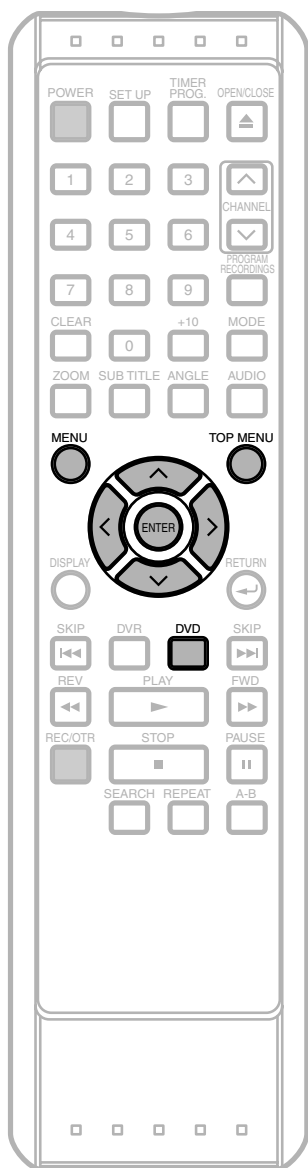

Disc Menus



Press **DVD** first.

- 1** Press **MENU**.
 - The DVD menu will appear.

- 2** If the feature is not available, ⓧ symbol may appear on the TV screen.

- 3** If disc menu is available on the disc, audio language, subtitle options, chapters for the title and other options will appear for selection.

- 4** Press **^ / v / < / >** to select an item, and the **ENTER** button to confirm selection.

Title Menus



Press **DVD** first.

- 1** Press **TOP MENU**.
 - The title menu will appear.

- 2** If the feature is not available, ⓧ symbol may appear on the TV screen.

- 3** Press **^ / v / < / >** to select an item, and the **ENTER** to confirm selection.
 - Playback will begin at the selected title.

Note

- Contents of menus and corresponding menu operations may vary between discs. Refer to the manual accompanying the disc for details.

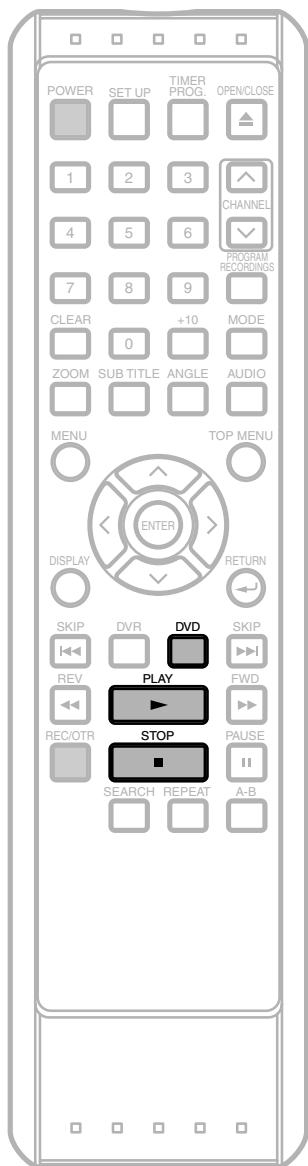

Resume Playback



You can resume playback from where you stopped last time.

Press **DVD** first.

1 During playback, press **STOP** ■.

Resume message will appear.

Example: DVD and CD

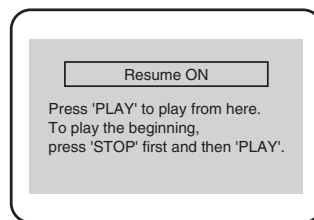

- Pressing **STOP** ■ twice will cancel the Resume function.

2 Press **PLAY** ►.

Within a few seconds, playback will resume from the point at which it stopped last. Resume function stays in effect even if you turn off the power.

Note

- For MP3/WMA, playback will resume from the beginning of the track at which playback was stopped.

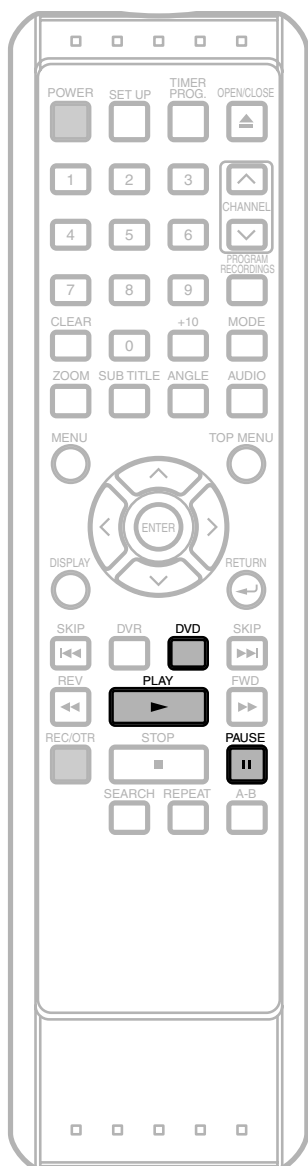

Pause



Press **DVD** first.

- 1 During playback, press **PAUSE II**. Playback will pause and sound will be muted.



- 2 Press **PLAY ►** to resume play.

Step-by-Step Playback



Press **DVD** first.

- 1 The disc goes forward by one frame each time **PAUSE II** is pressed in the pause mode. To continue playback, press **PLAY ►**. The sound will be muted.

Note

- On DVDs, set "STILL MODE" to "FIELD" in the Display menu if pictures in the pause mode are blurred. (Refer to page 81.)
- During paused and step-by-step playback, sound will be muted.
- Playback will be paused and sound will be muted.

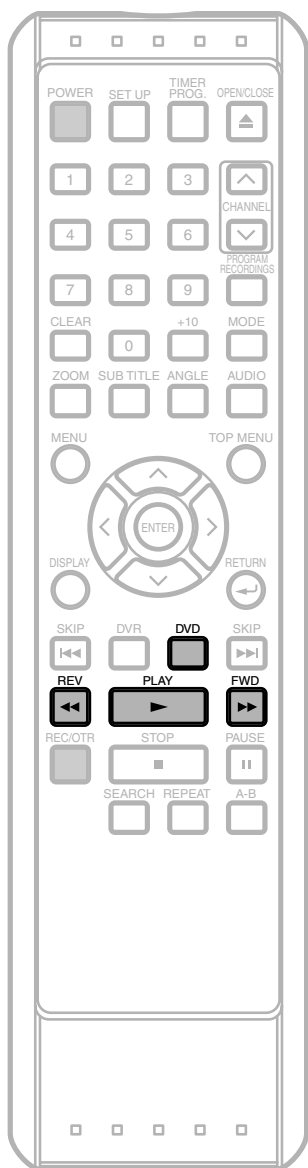

Fast Forward / Fast Reverse



Press **DVD** first.

- 1 During playback, press **FWD** ►► or **REV** ◄◄. Every time you press **FWD** ►► or **REV** ◄◄, approximate speed will change as follows.

press button ►►: +1 ◄◄: -1	-5	-4	-3	-2	-1	0	+1	+2	+3	+4	+5
speed (DVD)	x100	x50	x20	x8	x2	Normal speed	x2	x8	x20	x50	x100
speed (CD)	-	-	x30	x8	x2	Normal speed	x2	x8	x30	-	-
speed (MP3, WMA)	-	-	x30	x8	x2	Normal speed	x2	x8	x30	-	-
OSD indication	◄◄5	◄◄4	◄◄3	◄◄2	◄◄1	N/A	►►1	►►2	►►3	►►4	►►5

- 2 Press **PLAY** ► to continue playback.

Note

- For DVDs, fast forward or reverse search speed is different depending on the disc.
- If you are using ◄◄◄/◄◄, ►►►/►► on the front panel, press and hold it for than 2 sec (the longer you hold it, the faster the speed will be). When you reach the desired speed, release the button.
- On DVDs, set “STILL MODE” to “FIELD” in the DISPLAY menu if pictures during fast forward and reverse search are blurred. (Refer to page 81.)

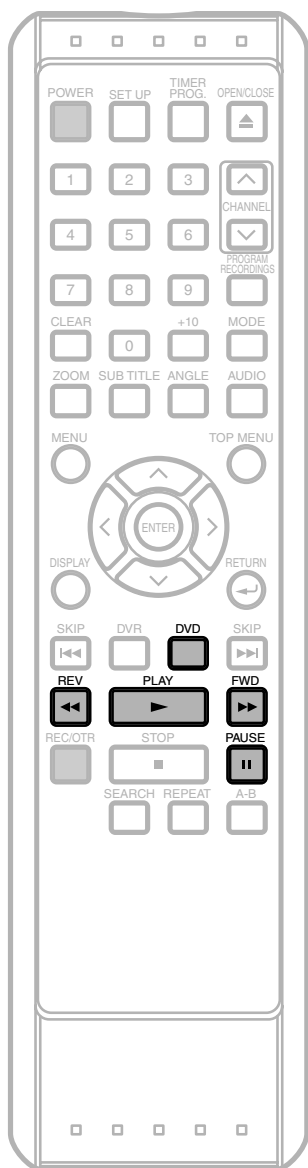

Slow Forward / Slow Reverse



Press **DVD** first.

- 1** During playback, press **PAUSE II**.
- 2** Press **FWD ►►** or **REV ◄◄**.
Every time you press **FWD ►►** or **REV ◄◄**, approximate speed will change as follows.

press button ►►: +1 ◄◄: -1	-3	-2	-1	0	+1	+2	+3
speed (DVD)	x1/2	x1/8	x1/16	Normal speed	x1/16	x1/8	x1/2
OSD indication	◄◄3	◄◄2	◄◄1	N/A	►►1	►►2	►►3

- 2** Press **PLAY ►** to continue playback.

Note

- Slow forward or reverse speed is different, depending on the disc.
- Set "STILL MODE" to "FIELD" in the Display menu if pictures in the slow playback mode are blurred. (Refer to page 81.)
- If you are using ◄◄◄◄, ►►►► on the front panel, press and hold it for than 2 sec(the longer you hold it, the slower the speed will be).When you reach the desired speed, release the button.

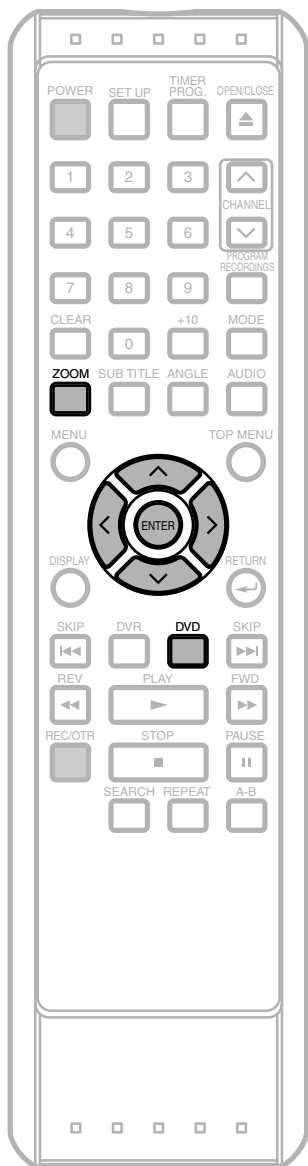

Zoom



Press **DVD** first.

- 1** During playback, press **ZOOM**.
Icons for the available features will appear.

- 2** Press **ZOOM** repeatedly to select the required zoom factor: x2, x4 or OFF.
Option window will appear.



- 3** Using **^ / v / < / >**, slide the zoomed picture across the screen.
During zoomed playback, the position guide box appears at the bottom-right on the TV screen. The position of the blue box inside the blue box indicates the position of the zoomed image within the overall picture. To remove the box or show it, press **ENTER**.

- 4** To exit zoom mode, press **ZOOM** repeatedly to select OFF.

Note

- Zooming function does not work while the disc menu is showing up.
- x4 zoom is not available on some discs.
- It may take several seconds to slide the zoomed picture.

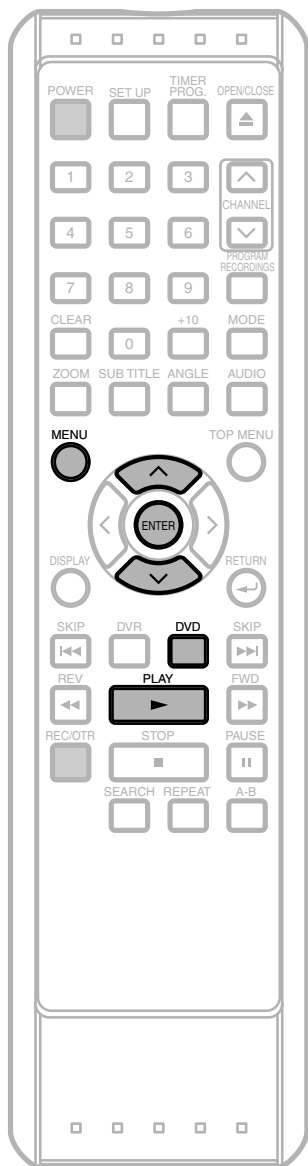

Playing back MP3 / WMA Discs



MP3/WMA are methods of compressing files. You can copy MP3/WMA files on CD-RW/Rs from the computer and play the files on this unit.

Press **DVD** first.

- 1 Insert an MP3/WMA-format disc, then press **MENU** to call up the MP3 / WMA List.

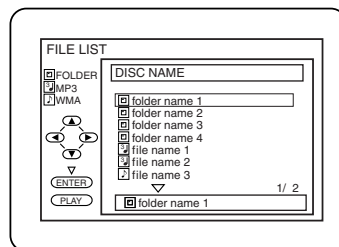

- To exit the menu, press **MENU** again.

- 2 Using **^ / v** to select a desired folder (group) or track. Press **ENTER** or **PLAY**.

When a track is selected:

Playback will start.

When a folder is selected:

The files and the folders will appear.

Using **< / >** to go to the next or previous hierarchy (except for the top hierarchy).

Using **^ / v** to select a track or a folder you want, then press **ENTER**.

Hints for MP3 / WMA files:

- Some selections may take a while to be recognized.
- Press **TOP MENU** to return to the first item.
- Folders are known as Groups; files are known as Tracks.
- MP3 files are accompanied by icon.
- WMA files are accompanied by icon.
- Folders are accompanied by icon.
- A maximum of 255 folders can be recognized.
- A maximum of 999 files can be recognized.
- Up to 8 hierarchies can be created. This unit recommends the files recorded under the following circumstances:
 - Sampling frequency: 44.1kHz or 48kHz (MP3/WMA)
 - Constant bit rate: 32kbps ~ 320kbps (MP3) 48kbps ~ 192kbps (WMA)
- For MP3/WMA file recorded in Variable Bit Rate (VBR), the unit may not display the actual elapsed time.
- Copyright protected WMA files will not play on this unit.
- The name of group and track can be displayed in up to 25 characters. Unrecognizable characters will be replaced with asterisks. The ninth and deeper hierarchies cannot be displayed.
- Unplayable groups and tracks may be displayed depending on the recording conditions.

Note

- The audio source of MP3 / WMA files cannot be recorded as digital sound by an MD or DAT deck.
- Files that bear an extension other than .mp3 or .wma (MP3 / WMA) will not appear in the MP3 / WMA Menu.
- Some unplayable folders or tracks may appear in the MP3 / WMA Menu depending on their recording status.

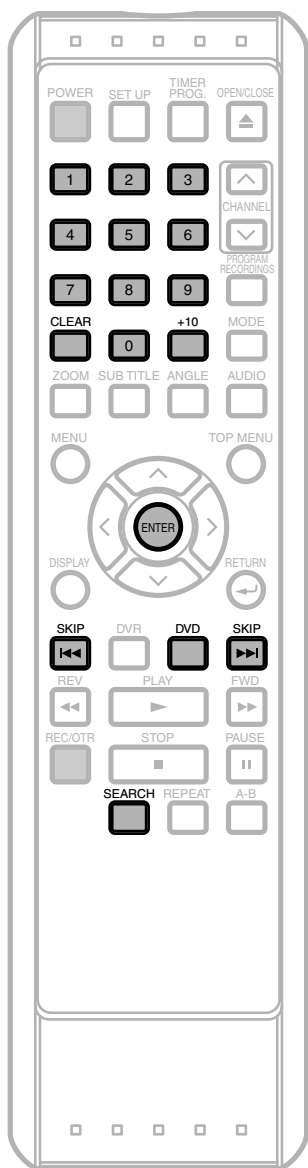

Track Search



Press **DVD** first.

Using **SKIP**

- 1 During playback, press **SKIP** to skip to the next track.
Press **SKIP** once to skip back to the beginning of the current track.
Press **SKIP** twice to skip back to the previous track.

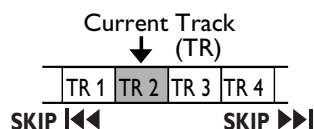

Using **SEARCH**

- 1 During playback, press **SEARCH**.
Option window will appear.

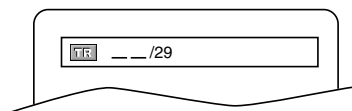

- 2 Select track number by using the **Number Buttons** within 30 seconds.
Track Search will start.
 - Press **CLEAR** to erase the incorrect input.
 - **+10** is also available for discs with more than 9 tracks.

Note

- Track number will appear briefly on the front panel display.
- If **SKIP** / are pressed while the playback is paused, the playback will be paused again after skipping to the next track.
- **SKIP** / are not available when playback is stopped.
- Track Search is not available on some discs.
- For CDs and MP3/WMA, Track Search is not available during Programmed or Random Playback.
- For discs with less than 10 tracks, press the track number directly.
- For discs with more than 9 and less than 100 tracks (total track number is 2 digit), to play a single digit track press **0** first. Then enter the track number: (e.g. for track 3, press **0, 3**). To play a double-digit track, press the track number.
- For discs with more than 99 tracks, to play a single or a double-digit track, press **0** first, then the track number (e.g. for track 3, press **0, 0, 3**, and for track 26, press **0, 2, 6**). To play a triple-digit track, press the track number.
- **+10** can also bring the Track Search display, except for the disc with less than 10 tracks. For such a disc, track search can be done by just pressing the track number.

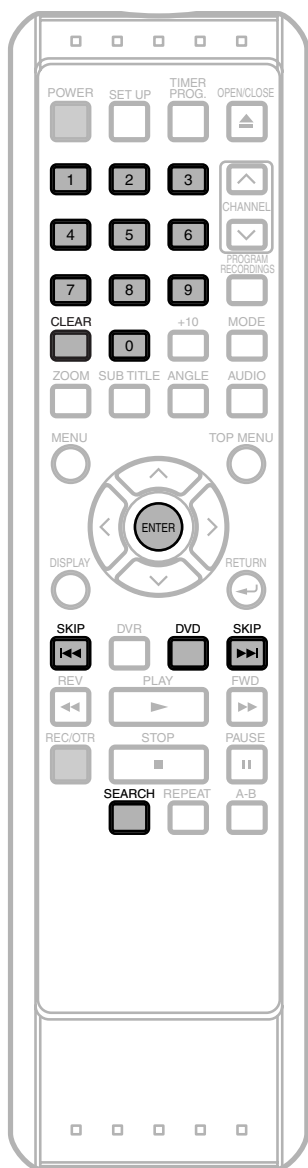

Title / Chapter Search



Press **DVD** first.

Using **SKIP** ◀◀ / ▶▶

- 1 During playback, press **SKIP** ▶▶ to skip to the next title or chapter.

Press **SKIP** ◀◀ once to skip back to the beginning of the current title or chapter.

Press **SKIP** ◀◀ twice to skip back to the previous title or chapter.

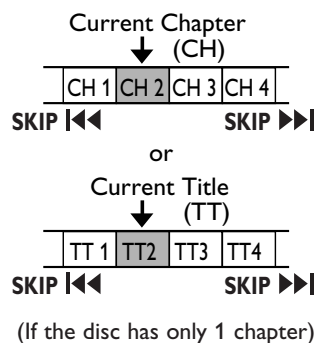

Using **SEARCH**

- 1 During playback, press **SEARCH** repeatedly until the Title / Chapter Search display appears.

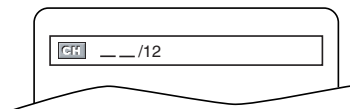

- 2 Enter the desired title / chapter number by using the **Number Buttons** within 30 seconds.

Title Search and Chapter Search will start.

- Press **CLEAR** to erase the incorrect input.

Note

- Depending on the disc being played, this function can also be performed by directly entering the desired chapter number with the **Number buttons**. Refer to the manual accompanying the disc.

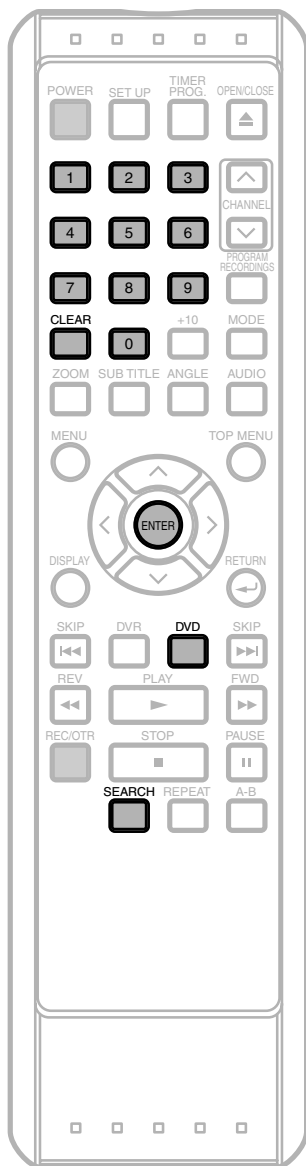

Time Search



Press **DVD** first.

- 1 During playback, press **SEARCH** repeatedly until the Time Search display appears.

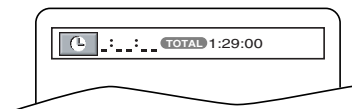

- 2 Select a desired disc time by using the **Number Buttons** within 30 seconds.

Time Search will start.

- Press **CLEAR** to erase the incorrect input.

Note

- When there is no need to enter a number, "0" appears automatically.
For example, "0 : 0 _ : _ _" appears in the Time Search display if the total time of the title or track is less than 10 minutes.
- Time Search is not available on some discs.

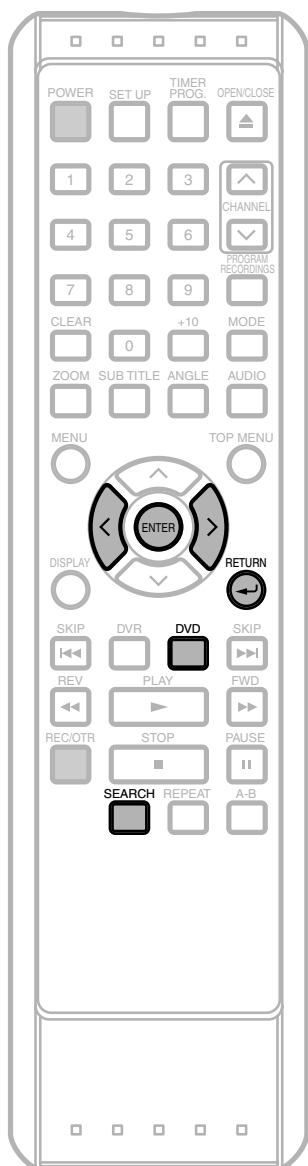

Marker Setup



This feature allows you to assign a specific point on a disc to be called back later.

Press **DVD** first.

- 1 During playback, press **SEARCH** repeatedly until the marker display appears.

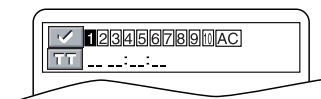

- 2 Using **< / >**, select a desired marker number. When it reaches the desired point, press **ENTER**. The title (track) number and the time will appear.

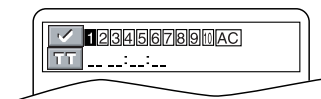

To return to the marker later:

- Playback will restart from the specific point which you set.

- 3 To exit the marker menu, press **RETURN** **↵**.

Note

- The Marker display will disappear in about 30 seconds when there is no output.
- To clear a marker, select the marker to be cleared at step 2, and then press **CLEAR**.
- Removing the disc or turning off the power will erase all markers.
- Selecting "AC" at step 2 will also erase all markers.
- You can mark up to 10 points.
- Marker Setup is not available on some discs.

Repeat / Random / Programmed Playback

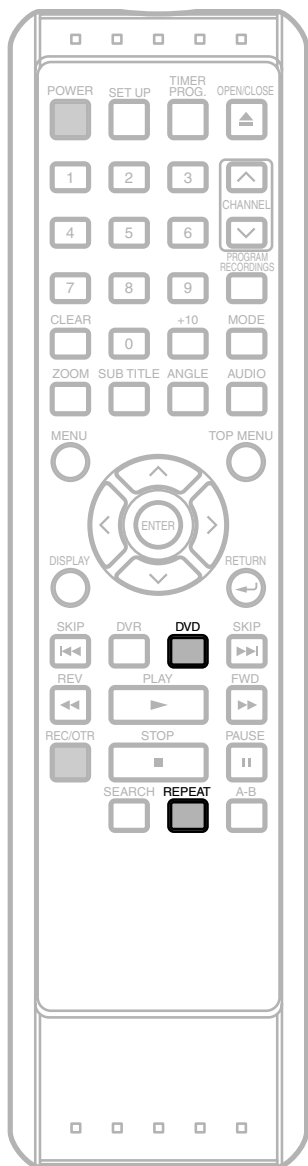

Repeat Playback



Repeat function is available only during playback.

Press **DVD** first.

- 1 During playback, press **REPEAT**.

Option window will appear.



Each time you press **REPEAT**, repeat function changes as example below.

Hints for DVD Repeat:

- Repeat Chapter / Title is not available with some scenes.
- Repeat Playback does not function during repeat A-B playback.
- The Repeat Chapter / Title setting will be cleared when moving to other title or chapter.

Example: DVD

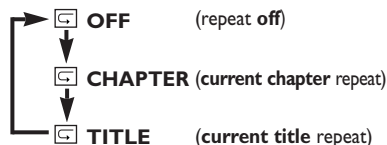

Hints for CD Repeat:

- Repeat playback does not function during repeat A-B playback.
- The Repeat Track setting will be cleared when moving to other track.

Example: CD



Hints for MP3 and WMA Repeat:

- Repeat setting will be cleared when moving to another track or group.
- Repeat playback may not function with some discs.

Example: MP3, WMA

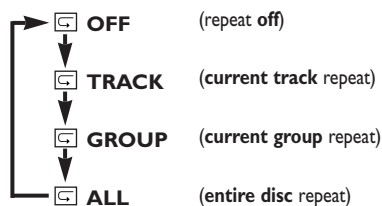

Note

- Repeat setting will be cleared when moving to another title, chapter, track or group.
- Repeat playback may not function with some discs or during repeat A-B playback.

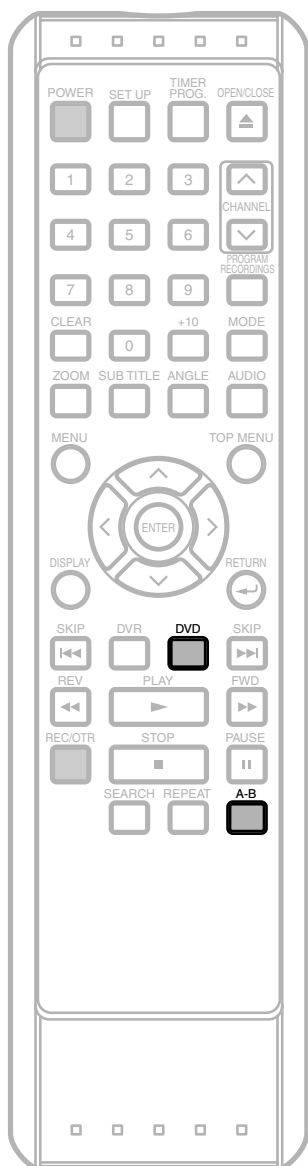

Repeat A-B Playback



The part between the point A and B will be played back repeatedly.

Press **DVD** first.

- 1 Play back the title up to the point where you want to set point "A". Then, press **A-B**.

Option window will appear.

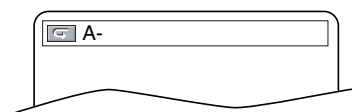

- 2 Play back the title up to the point where you want to set point "B". Then, press **A-B**.



The A-B Repeat Playback is now activated.

Note

- To exit the sequence, press **A-B** so that "[OFF]" appears.
- To cancel Point A, press **CLEAR** at step 1.
- This function does not work in the other repeat modes.
- The Repeat A-B section can only be set within the current title (for DVDs), or the current track (Audio CDs).
- Repeat A-B is not available with some scenes in DVD.

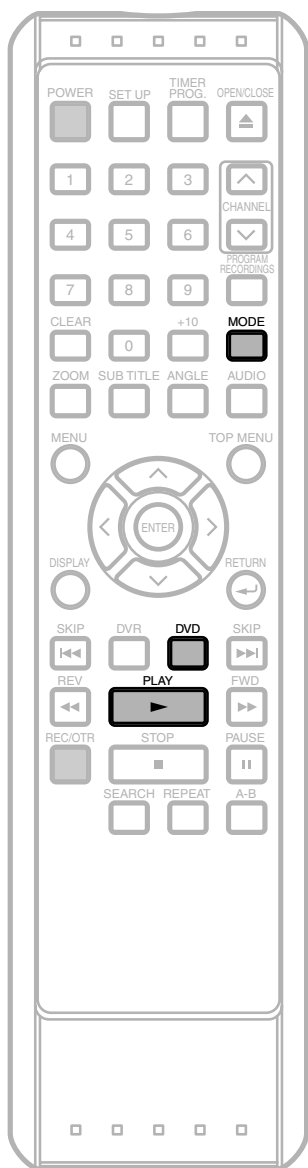

Random Playback



This function shuffles the playing order of tracks instead of playback in the sequence.

Press **DVD** first.

- 1 In stop mode, press **MODE** repeatedly until Random Screen appears.

Example: CD

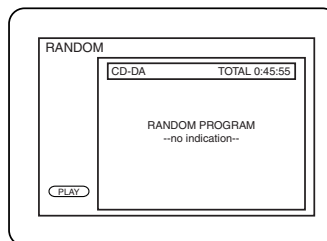

- 2 Press **PLAY** ►.

Random Playback will start.



Note

- To repeat the current track in the random selections, press **REPEAT** repeatedly until "TRACK" appears during playback.
- To repeat the entire random selections, press **REPEAT** repeatedly until "ALL" appears during playback.
- You cannot go back to the previous track during Random Playback.

Repeat / Random / Programmed Playback (Cont'd)

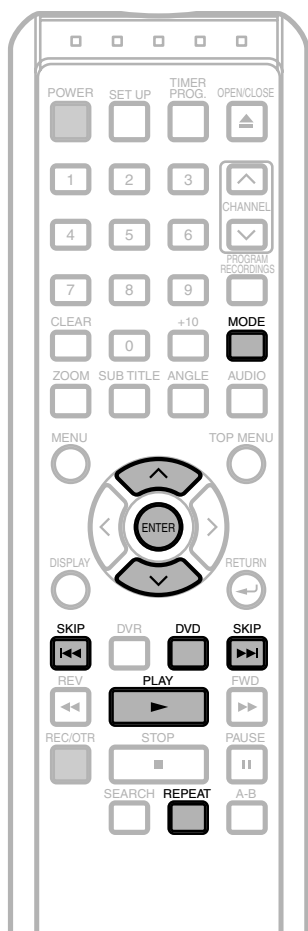

Programmed Playback



You may determine the order in which tracks will play.
Press **DVD** first.

- 1 In stop mode, press **MODE**.
Program screen will appear.

Example: CD

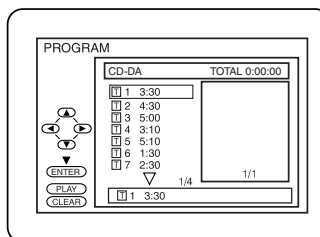

- 2 Using **^** / **v**, enter a desired track. Press **ENTER**.

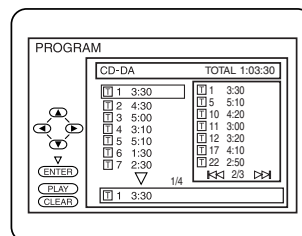

- Up to 99 tracks can be programmed.
- If eight or more tracks are in the program, use **SKIP** **◀◀**, **SKIP** **▶▶** to see all the tracks.
- **If a folder is selected:**
Press **>** to go to the next hierarchy.
Press **<** to go back to the previous hierarchy (except when you are already in the top hierarchy).

- 3 Press **PLAY** **▶**.
Program Playback will start.

Note

- Press **CLEAR** at step 2 to erase the most recently entered track.
- To erase all programmed tracks at once, select "ALL CLEAR" and press **ENTER** at step 2.
- While a program is being played back, **STOP** **■** works as follows:
- Press **STOP** **■** and **PLAY** **▶** next, so that the programmed playback restarts. (CD playback restarts from the current point. MP3/WMA playback restarts from the beginning of the current track.)
- Press **STOP** **■** twice and **PLAY** **▶** next, so that playback restarts from the first track in the original order. However, your programmed playback can be restarted when you follow the above steps. (Your programs are still stored until either the disc is removed or power is turned off.)
- To repeat the current track in the program, press **REPEAT** repeatedly until "TRACK" appears during playback.
- To repeat the entire program, press **REPEAT** repeatedly until "ALL" appears during playback.

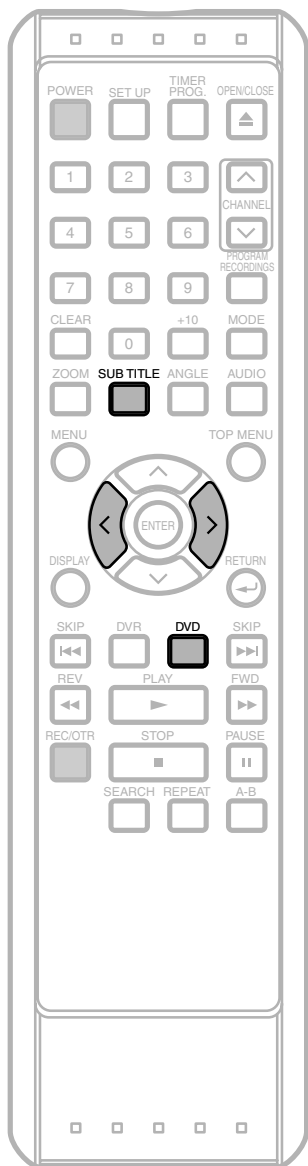

Subtitle Language



This unit allows you to select a subtitle language (if available) during DVD playback.

Press **DVD** first.

- 1 During playback, press **SUBTITLE**.
Option window will appear.



Each time you press **SUBTITLE**, subtitle language changes as example below.

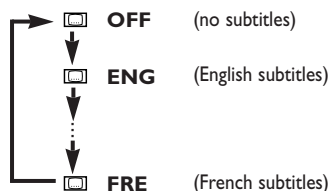

To set subtitle ON/OFF



- 1 During playback, press **SUBTITLE**, and then **< / >**.

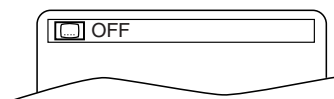

Note

- If your language is not shown after pressing **SUBTITLE** several times, the disc may not have that language. However, some discs allow audio subtitle language setting on the disc menu. (Operation varies depending on the disc, so refer to the manual along with the disc.)
- When “NOT AVAILABLE” appears on the TV screen, it means no subtitle is recorded on the scene.
- If you choose a language that has a three-letter language code, the code will be displayed every time you change the subtitle language setting. If you choose any other languages, ‘---’ will be displayed instead. (Refer to page 92.)
- Some discs will only allow you to change the subtitle from the disc menu. Refer to the manual accompanying the discs for details.

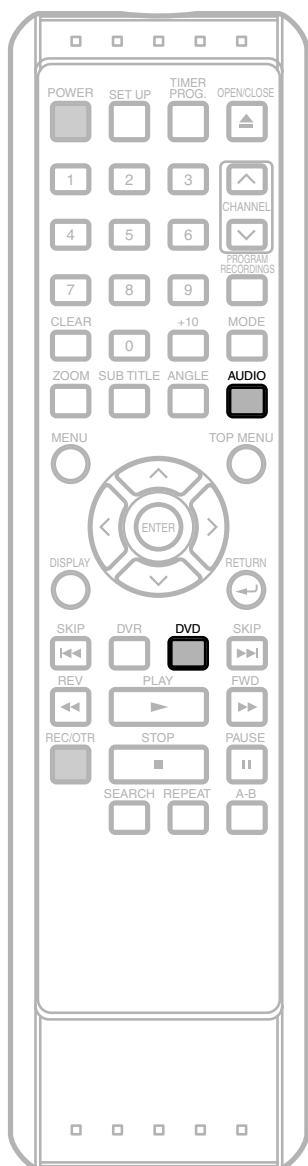

Audio Language



This unit allows you to select an audio language (**if multiple languages are available on disc**) during DVD playback.

Press **DVD** first.

- 1 During playback, press **AUDIO**.
Option window will appear.

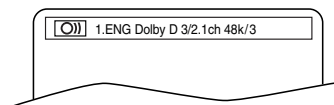

Each time you press **AUDIO**, audio language changes as example below.

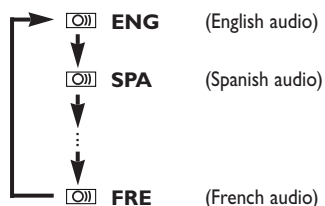

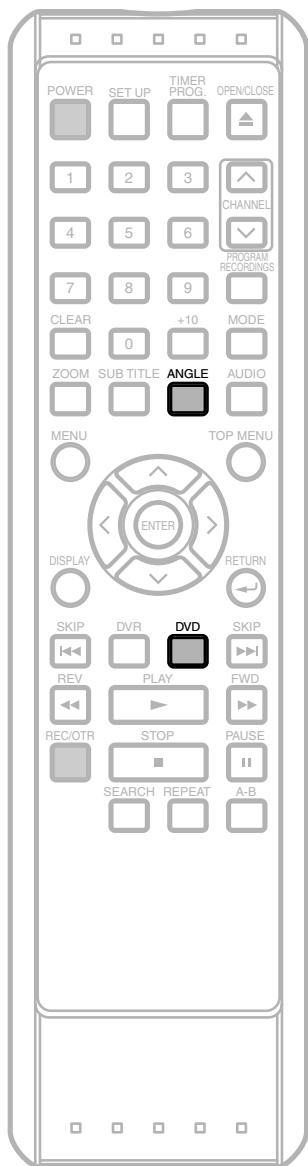

Note

- Some discs will only allow you to change the audio setting from the disc menu. Refer to the manual accompanying the discs for details.
- If your language is not shown after pressing **AUDIO** several times, the disc may not have that language. However, some discs allow you to change audio language setting in the disc menu. (Operation varies with the disc, so refer to the manual included in the disc.)
- If you choose a language that has a three-letter-language code, the code will be displayed every time you change the subtitle language setting. If you choose any other languages, '---' will be displayed instead. (Refer to page 92.)



Camera Angles



Some DVD discs may contain scenes which have been shot simultaneously from various angles. You can change the camera angle if the () icon appears on the screen. If the "ANGLE ICON" setting is "OFF" in the OTHERS menu, the () icon will not appear. (Refer to page 85.)

Example: DVD



Press **DVD** first.

- 1** During playback, press **ANGLE**.
Option window will appear.

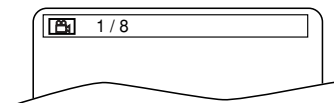

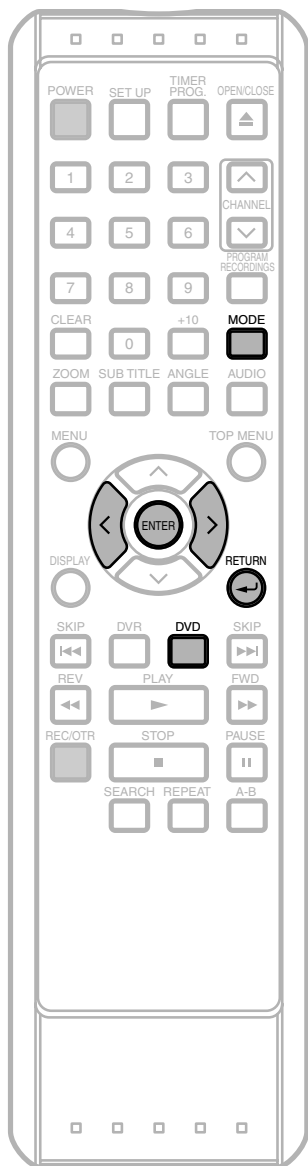

Black Level Setting



Adjust the Black Level Setting to make the dark areas of the TV picture brighter.

Press **DVD** first.

- 1 During playback, press **MODE**.
Option window will appear.



- 2 Press **< / >** or **ENTER** to select a desired setting.

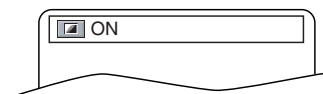

ON: Makes the dark areas brighter.

OFF: Shows the original picture as recorded.

- 3 To exit the black level setting menu, press **RETURN** .

Note

- The setting will be saved even if the unit is turned off or stopped playback.

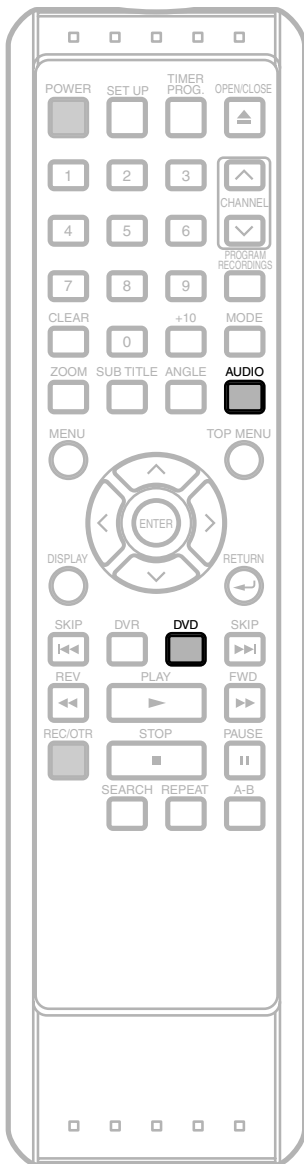

Stereo Sound Mode



This unit allows you to select a sound mode during CD playback.

Press **DVD** first.

- 1 During playback, press **AUDIO**.
Option window will appear.

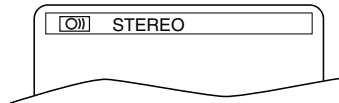

Each time you press **AUDIO**, sound mode changes as example below.

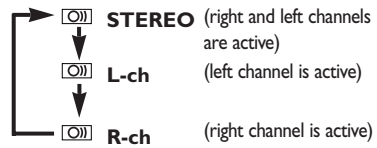

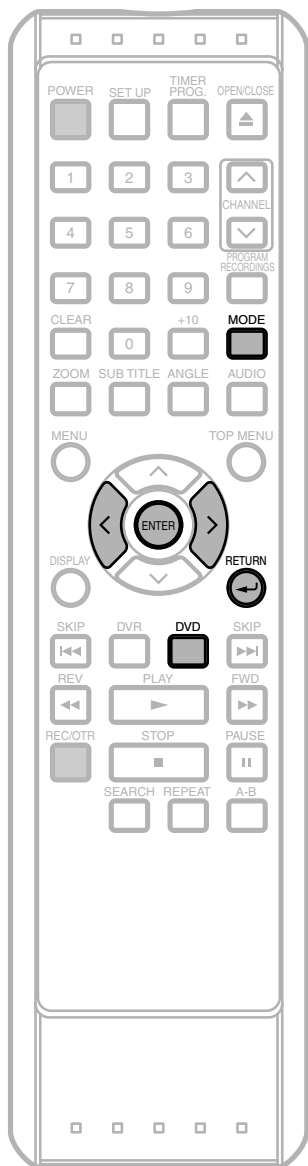

Virtual Surround



You can enjoy stereophonic virtual world on your existing 2 channel stereo system.

Press **DVD** first.

- 1 During playback, press **MODE** repeatedly until the Virtual Surround icon  appears.



- 2 Press **< / >** or **ENTER** to select a desired setting.



OFF: No effects (original sound)

1: Natural effect

2: Emphasized effect

- 3 To exit the virtual surround setting menu, press **RETURN** .

Note

For CD play back only

- Virtual Surround will not be effective if the sound mode is set to something other than STEREO. Refer to "Stereo Sound mode".
- When playing back a 96kHz with Virtual Surround function, the sound will be down sampling at 48kHz and output as digital audio.

DVD (Setups)

DVD SETUP

Press **DVD** first.

Press **SET UP** to display SETUP Menu. Choose QUICK Menu, CUSTOM Menu or INITIALIZE Menu using < / >, then press **ENTER** to display it. These menus allow you to perform all main functions and change setting for them.

QUICK Menu

You can select the "PLAYER MENU", "TV ASPECT" or "DOLBY DIGITAL" on the QUICK menu quickly.

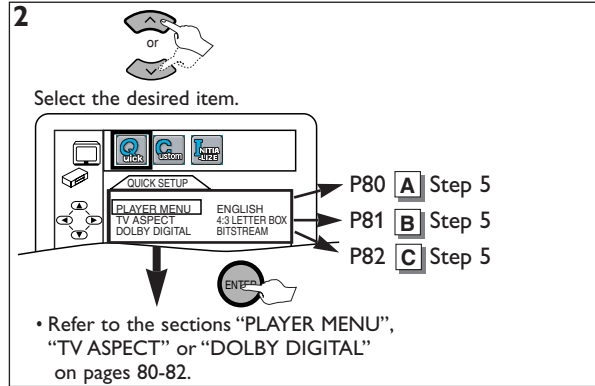
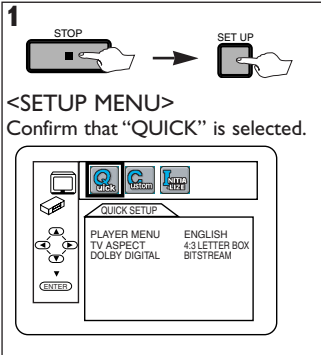

CUSTOM Menu

You can change the settings of the unit.
Items with **QUICK** are also accessible from the QUICK menu.

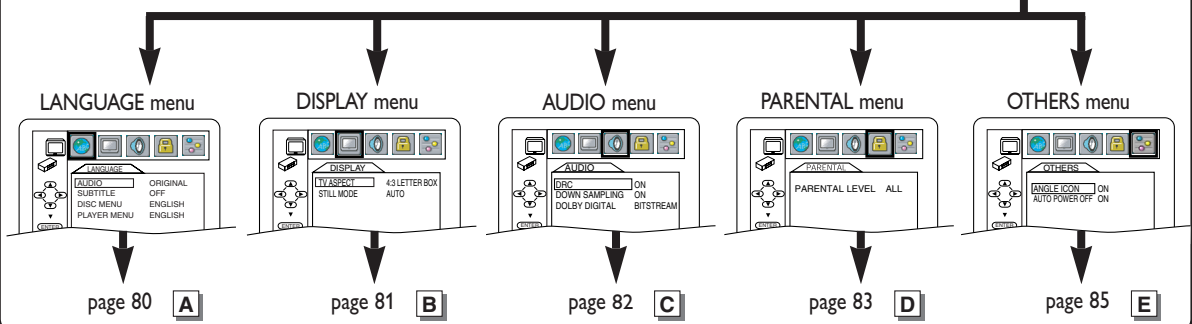
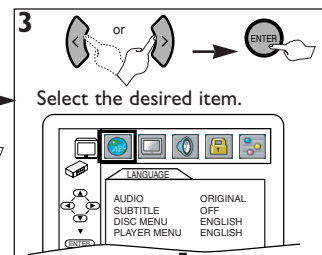
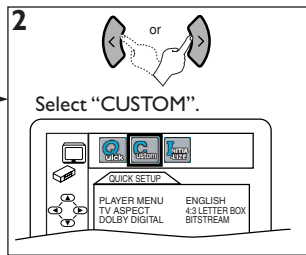
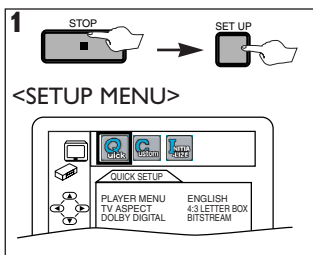

INITIALIZE Menu

You can reset the default setting of the unit. (Except PARENTAL Setting.)

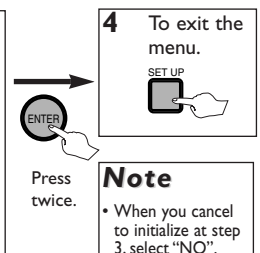
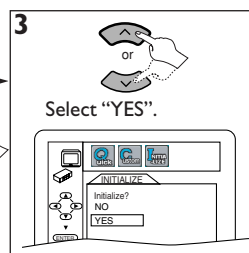
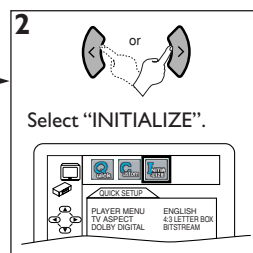
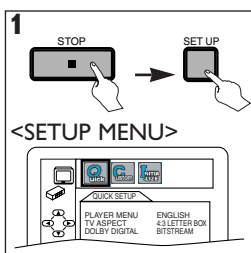

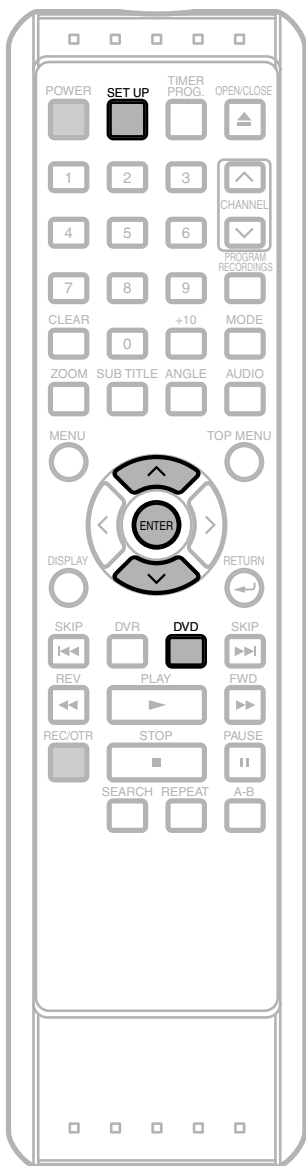

A LANGUAGE Setting

Follow steps 1 to 3 in the “CUSTOM Menu” section on page 79.

4 Using \wedge / \vee , select a desired item. Press **ENTER**.

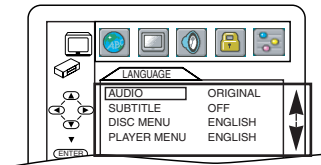

LANGUAGE items will appear.

5 Using \wedge / \vee , select a desired language. Press **ENTER**.

AUDIO *1 *2 (Default: ORIGINAL)
Sets the audio language.

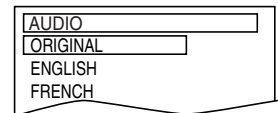

SUBTITLE: *1 *2 (Default: OFF)
Sets the subtitle language.

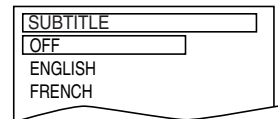

DISC MENU: *1 (Default: ENGLISH)
Sets the language in DVD menu.

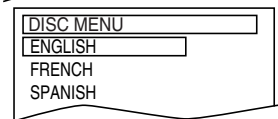

PLAYER MENU: **QUICK** (Default: ENGLISH)
Sets the language for the On-Screen Display.

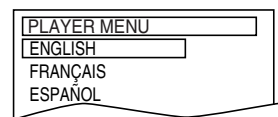

6 To exit the menu, press **SET UP**.

Note

*1

- Language options are not available with some discs.
- If OTHER is selected in the AUDIO, SUBTITLE or DISC MENU screen, press four-digit number to enter the code for the desired language. (Refer to the language code list on page 92.)
- Only the languages supported by the disc can be selected.

*2

- Language setting for Audio and Subtitle are not available with some discs. Then press **SUBTITLE** or **AUDIO**. Details are on pages 73-74.

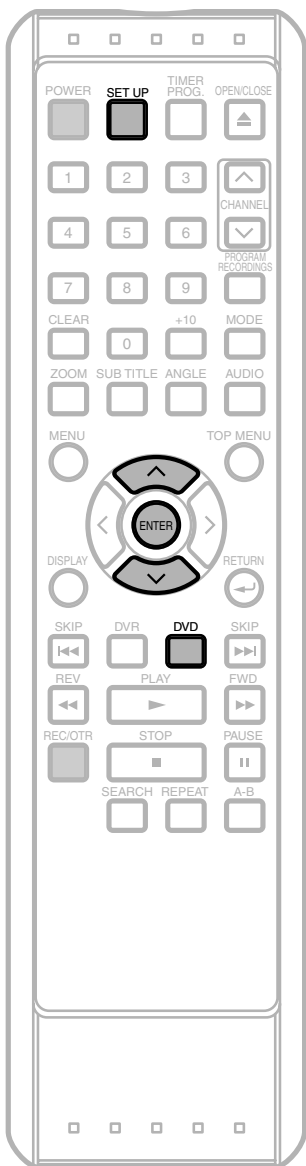

B DISPLAY Setting

You can change the display functions. Follow steps 1 to 3 in the “CUSTOM Menu” section on page 79.

4 Using \wedge / \vee , select a desired item. Press **ENTER**.

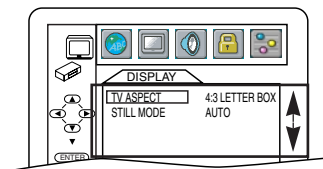

DISPLAY items will appear.

5 Using \wedge / \vee , select a desired setting. Press **ENTER**.

TV ASPECT: **QUICK** (Default: 4:3 LETTER BOX)

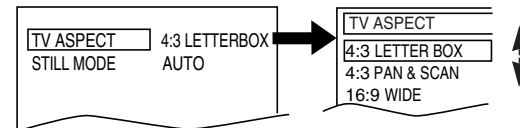

- Select “4:3 LETTER BOX”, so that black bars may appear on the top and bottom of the screen.
- Select “4:3 PAN & SCAN” for a full height picture with both sides adjusted.
- Select “16:9 WIDE” if a wide-screen TV is connected to this unit.

STILL MODE: (Default: AUTO)

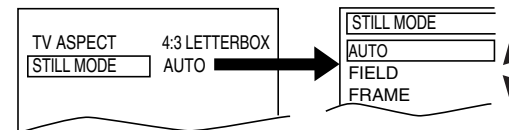

- Select “AUTO” usually.
- If you select AUTO, automatically select the best resolution setting (FRAME or FIELD) based on the data characteristics of the pictures. (default)
- If you select “FIELD”, the picture in the still mode will be stabilized.
- If you select “FRAME”, the picture in the still mode will be highly defined.
- An individual picture on TV screen is called a “frame”, which consists of two separate images called a “field”.
- Some pictures may be blurred at if you select “AUTO” in the still mode due to their data characteristics.

6 To exit the menu, press **SET UP**.

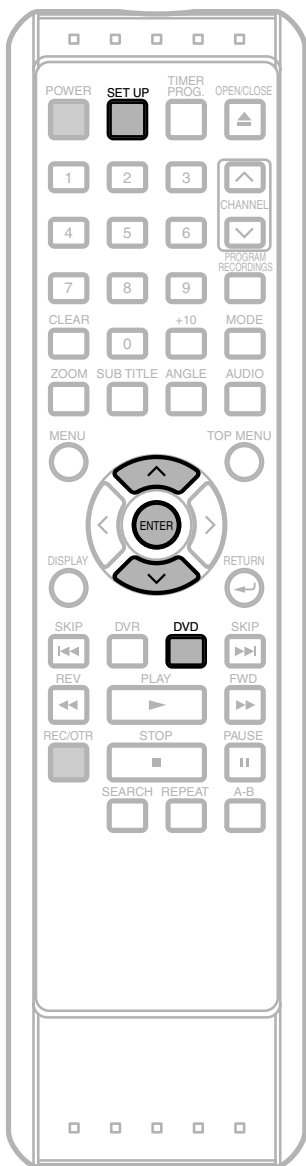

C AUDIO Setting

Choose the appropriate audio settings for your equipment. **It only affects during the playback of DVD discs.** Follow steps 1 to 3 in the “CUSTOM Menu” section on page 79.

4 Using \wedge / \vee , select a desired item.

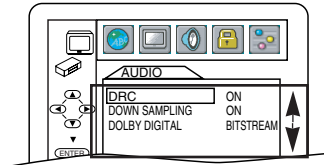

AUDIO items will appear.

5 Press **ENTER** to change the setting.

DRC (Dynamic Range Control): (Default: ON)
Set to “ON” to compress the range between soft and loud sounds.

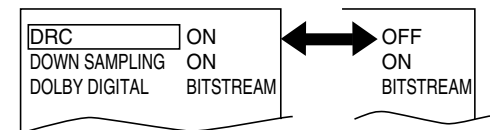

DOWN SAMPLING: (Default: ON)
Set to “ON” when outputting in 48kHz.
Set to “OFF” when outputting the original sound.



DOLBY DIGITAL: **QUICK** (Default: BITSTREAM)
Set to “BITSTREAM” when the unit is connected to a Dolby Digital decoder.

- BITSTREAM: Outputs a Dolby Digital Signals.
- PCM: Convert the Dolby Digital into PCM (2 channel).



6 To exit the menu, press **SET UP**.

Note

DRC:

- This function is available only on the discs which are recorded in the Dolby Digital format.

DOWN SAMPLING:

- When playing disc with copyright Protection, the sound will be down sampled at 48kHz, even if you set to “OFF”.
- **This function is available only on digital outputting of a disc recorded in 96kHz.**

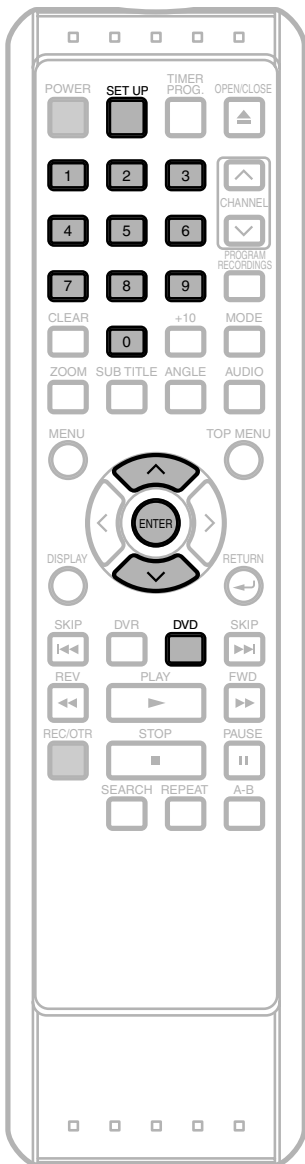

D PARENTAL Setting

Parental Control limits the disc viewing that exceed your settings. (An incorrect password will be not acceptable.) This feature prevents your children from viewing inappropriate materials.

Parental Levels

Parental Level allows you to set the rating levels of your DVD discs. Playback will stop if the ratings exceed the levels you set. Follow steps 1 to 3 in the "CUSTOM Menu" section on page 79.

- 4 If a password is not yet set, enter your desired password (except for 4737) using the **Number Button**. Press **ENTER**.

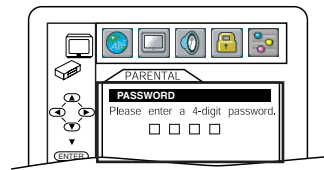

If a password is already set, enter the current four-digit password using the **Number Button**. Press **ENTER**.

PARENTAL menu will appear.

- 5 Using \wedge / \vee , select "PARENTAL LEVEL". Press **ENTER**.

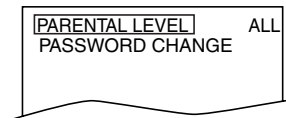

- 6 Using \wedge / \vee , select desired level. Press **ENTER**.

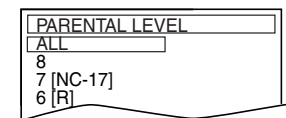

CONTROL LEVELS

- ALL: All parental locks are canceled.
- Level 8: DVD softwares of any grades (adult/general/children) can be played back.
- Levels 7 to 2: Only DVD softwares intended for general use and children can be played back.
- Level 1: Only DVD softwares intended for children can be played back, with those intended for adult and general use prohibited.

TIPS FOR LEVELS

- 7 [NC-17]: No one under 17 admitted
- 6 [R]: Restricted; under 17 requires accompanying parent or adult guardian
- 4 [PG13]: Unsuited for children under 13
- 3 [PG]: Parental Guidance suggested
- 1 [G]: General Audience

- 7 To exit the menu, press **SET UP**.

Note

- DVD-Video discs may not respond to the parental lock settings. Make sure this function works with your DVD-Video discs.

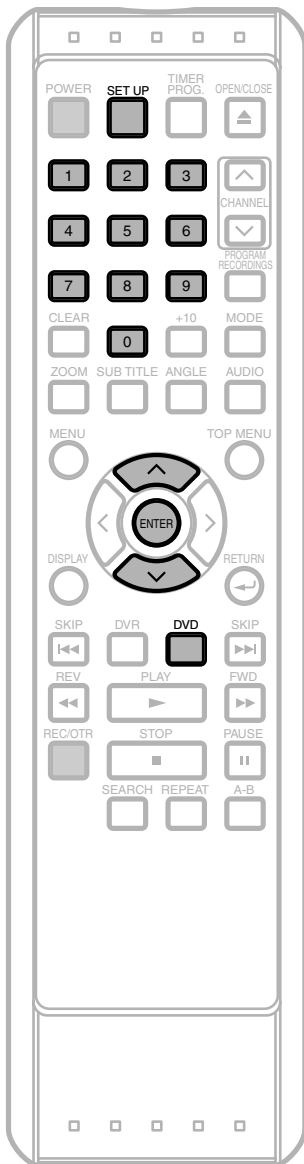

D PARENTAL Setting (Cont'd)

To Change the Password for Parental Controls

You can change your password for parental controls. Follow steps 1 to 3 in the "CUSTOM Menu" section on page 79.

- Using the **Number Button**, enter your current password.

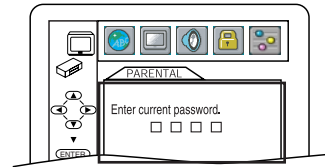

PARENTAL menu will appear.

- Using \wedge / \vee , select "PASSWORD CHANGE". Press **ENTER**.

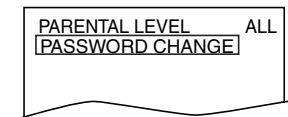

- Using the **Number Button**, enter your new four-digit password (except for 4737). Press **ENTER**.

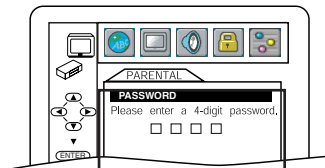

- To exit the menu, press **SET UP**.

Note

- Record the password in case you forget it.
- If you forget the password, press [4], [7], [3], [7] at step 4, then enter your new password. Password will be cleared and parental levels will be set to "ALL".

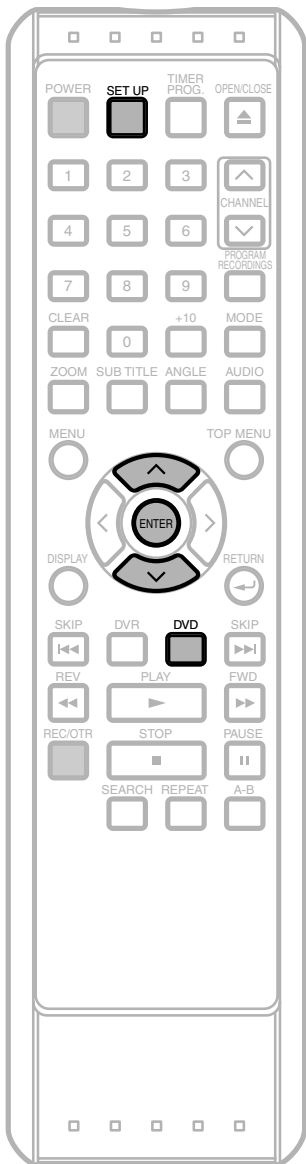

E OTHERS Setting

You can change other functions. Select "OTHERS" at step 3 in the "CUSTOM Menu" section on page 79.

4 Using \wedge / \vee , select a desired item.

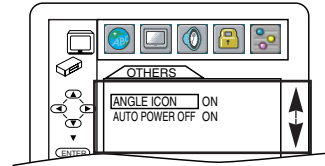

5 Press **ENTER** to change the setting.

ANGLE ICON: (Default: ON)

Set to "ON" to show the angle icon when multiple camera angles are available during DVD playback.

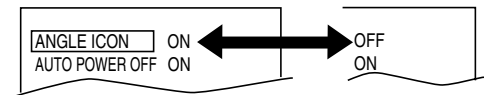

AUTO POWER OFF: (Default: ON)

Set to "ON" to turn the DVD device off automatically after 30 minutes of no use.

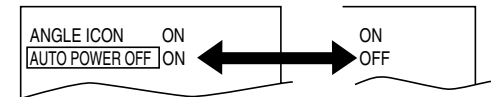

6 To exit the menu, press **SET UP**.

Troubleshooting

Before requesting service for this unit, check the table below for a possible cause of the problem you are experiencing. Some simple checks or a minor adjustment on your part may eliminate the problem and restore proper performance.

General Operation

Error message	Cause & Solution
	<ul style="list-style-type: none"> The operation is not available.
<div style="border: 1px solid black; padding: 2px; width: fit-content;">Error</div> Timer program starts soon.	<ul style="list-style-type: none"> The operation is not available since a Timer Recording will start soon.

Discs

Error message	Cause & Solution
<div style="border: 1px solid black; padding: 2px; width: fit-content;">Disc Error</div> --Please eject the disc.-- Playback feature may not be available on this disc.	<ul style="list-style-type: none"> Invalid disc is inserted. Please insert a disc supported by this unit. (See page 56.)
<div style="border: 1px solid black; padding: 2px; width: fit-content;">Region Error</div> --Please eject the disc.-- Playback is not authorized in your region.	<ul style="list-style-type: none"> A disc with the invalid region code is inserted. This unit only supports the discs with region code 1 or ALL.

Timer Recording / Recording & Navigator

Error message	Cause & Solution
<div style="border: 1px solid black; padding: 2px; width: fit-content;">Error</div> Prohibited timer program.	<ul style="list-style-type: none"> The entry for the Timer Recording is invalid. The recording duration must be in 24 hour period. The end time must be later than the present time, and the start time must be before 1-1-2055. Re-program the Timer Recording correctly. (See pages 28-31.)
<div style="border: 1px solid black; padding: 2px; width: fit-content;">Error</div> Cannot register timer program.	<ul style="list-style-type: none"> The maximum number of timer programs is exceeded. Delete unnecessary timer programs. (See pages 28-31.)

Playback / Editing

Error message	Cause & Solution
<div style="border: 1px solid black; padding: 2px; width: fit-content;">Parental Lock On</div> The current selected parental level prohibits playback.	<ul style="list-style-type: none"> The current Parental Lock setting prohibits the playback. Change the Parental Level. (See page 83-84.)

Troubleshooting (Cont'd)

Symptom	Solution
The power does not turn on.	<ul style="list-style-type: none"> • Check that the AC power cord is connected securely. • Batteries of the remote control are weak.
The unit turns on automatically without any operation.	<ul style="list-style-type: none"> • The unit turns on automatically 3 minutes before the Timer Recording.
The OSD Language Setting Menu appears every time the power turns on.	<ul style="list-style-type: none"> • Finish up the Language Setting procedure by selecting a language in the OSD Language Setting Menu. Press ENTER to activate the setting.
The power turns off automatically .	<ul style="list-style-type: none"> • The power turns off automatically when abnormality is detected on the disc. Press POWER or OPEN / CLOSE ▲ to open the disc tray, and before it is opened completely, press the button again. Then take out the disc. • The power turns off automatically when an OTR is completed.

POWER

Symptom	Solution
The unit does not function.	<ul style="list-style-type: none"> •  or error message appears if the operation is prohibited. • Batteries of the remote control are weak or exhausted
No picture, sound or menu appears on the screen.	<ul style="list-style-type: none"> • Check if the connections are made securely and correctly. • Check if the cables are not damaged. • Check if a correct external input channel is selected on your TV. (See page 17.) • Check if you have completed the Channel Setting.
No picture or menu appears on the screen in the DVR mode.	<ul style="list-style-type: none"> • COMPONENT VIDEO OUT connection is not available in the DVR mode. Use other connection such as VIDEO OUT or S-VIDEO OUT.
Clock Setting and Channel Setting cannot be performed.	<ul style="list-style-type: none"> • If a Timer Recording is in standby or if a recording is in progress, these operations cannot be performed. Delete timer programs or stop the recording.
The unit does not operate properly.	<ul style="list-style-type: none"> • Moisture has condensed inside the unit. Remove the disc and leave the unit turned on until the moisture evaporates. (See page 4.)

GENERAL

Troubleshooting (Cont'd)

	Symptom	Solution
C H A N N E L	TV channels cannot be changed.	<ul style="list-style-type: none"> • Check if the connections are made securely and correctly. • Check if the cables are not damaged. • Try Channel Setting by following the steps on page 20-21.
	Only specific channels do not appear.	<ul style="list-style-type: none"> • The channels may be set to be skipped.
	The external input channels (such as L1) cannot be skipped.	<ul style="list-style-type: none"> • This unit does not skip the external input channels. This is not a malfunction.

	Symptom	Solution
R E C O R D I N G	Recording is impossible.	<ul style="list-style-type: none"> • This unit cannot record a program that contains copy protection signal. This is not a malfunction. • The space of the DVR may be used up. Try deleting unnecessary titles from the Title List. • The maximum number of titles has exceeded. Delete the unnecessary titles to make the total numbers of titles less than 300. • Check if the connections are made securely and correctly.
	Recording on the DVD disc is impossible.	<ul style="list-style-type: none"> • This unit cannot record any type of discs.
	The image from the external device cannot be displayed or recorded.	<ul style="list-style-type: none"> • Turn on the all connected devices. • Check if the connections are made securely and correctly.
	Timer Recording cannot be performed.	<ul style="list-style-type: none"> • The internal clock of the unit may have been stopped due to a power failure that lasted for more than 30 seconds. Reset the clock. (See pages 29-31.)

Troubleshooting (Cont'd)

Symptom	Solution
Disc Playback cannot be performed.	<ul style="list-style-type: none"> • Check if the playable disc is inserted. • Check if the disc is loaded correctly with the labeled side facing up. • Discs made on other devices or on personal computers cannot be played back on this unit unless it is finalized on the device. Even if it is finalized, the performance of those discs are not guaranteed on this unit. • The disc may be dirty or flawed. Clean the disc. • Check if all the connections are made correctly. • Check if the setting for the Progressive Scan is correct. (See page 16.) • Check the Parental Lock Setting. (See pages 83-84.)
Playback does not start from the beginning.	<ul style="list-style-type: none"> • Resume function may be activated. See page 37, 59 to cancel the resume point.
TV aspect ratio does not match for your TV screen.	<ul style="list-style-type: none"> • Check the TV Aspect Ratio. (See pages 53, 81.) • A different aspect ratio will be used when the aspect ratio specified by the disc is not supported by this unit.
Playback picture is distorted. Color of the picture is abnormal.	<ul style="list-style-type: none"> • During fast forward or fast reverse, playback picture may be distorted. This is not a malfunction. • Connect to TV directly. When you connect this unit with the television via VCR or other devices, the picture may be distorted due to the copy-protection signal. • Check if the cables are damaged. • Keep the equipment which may cause electrical disturbances, such as a cellular phone, away.
There is no sound, or no subtitle.	<ul style="list-style-type: none"> • Turn on all connected devices. • Check if the external input channel is set correctly. • Check if the connections are made securely and correctly. • Check if the Audio Out Setting is set correctly. (See pages 53, 82) • There is a possibility that the selected subtitle language is not supported by the disc.
Audio Out Setting can not be changed.	<ul style="list-style-type: none"> • If the audio source is in the Dolby Digital format, set the Dolby Digital Setting to "PCM" in the Setup Menu. (See pages 53, 82)
Audio Language or the Subtitle Language of the DVD can not be changed.	<ul style="list-style-type: none"> • Multilingual subtitles are not supported by the disc. • Some audio languages or the subtitle languages can be changed only from the Disc Menu. Please refer to the disc's manual.
Camera angles can not be changed.	<ul style="list-style-type: none"> • Even though the multi-angle feature is supported by the disc, that does not mean all the scenes are shot from multi-angles. Changing angles are available only for those scenes shot from the multi-angle.

PLAYBACK

Troubleshooting (Cont'd)

	Symptom	Solution
E D I T I N G	Titles can not be edited or deleted.	<ul style="list-style-type: none"> • The titles itself may be protected. Cancel the protection by following the steps on page 48.

	Symptom	Solution
R E M O T E C O N T R O L	No operation by remote control	<ul style="list-style-type: none"> • Check if the batteries are weak or inserted incorrectly. Replace weak batteries and insert with their polarities (+/- signs) as indicated. • Aim the remote control at the remote sensor and operate within 23 feet (7 m) of the unit. • Remove all obstacles to clear the path of the infrared signal. • Refer to the infrared signal. (See page 13.) • Select the correct mode to operate by pressing DVR or DVD. • The operable range from the unit is 10 feet (3m) within 15°.
	Pressing SET UP does not do anything.	<ul style="list-style-type: none"> • While the Programmed Recordings Screen, or the Title List is displayed or while the disc is loading, SET UP does not respond.

	Symptom	Solution
O T H E R S	The Clock display does not appear in the Front Panel Display.	<ul style="list-style-type: none"> • Check that the AC power cord is connected securely. • (In case of power failure) Check the breaker and Clock Setting.
	When you forget the password for Parental Lock.	<ul style="list-style-type: none"> • Please cancel the password and the set level. (See pages 83-84.)

* If you are still having trouble with this unit after checking 'Troubleshooting', write down the error code and the error description, and call our helpline mentioned on the front page to locate an Authorized Service Center.

Analog audio

An electrical signal that directly represents sound. In contrast, digital audio which can be an electrical signal, but is an indirect representation of sound. See also Digital audio.

Aspect ratio

The width of a TV screen relative to its height. Conventional TVs are 4:3 (in other words, the screen is almost square); widescreen models are 16:9 (the screen is almost twice as wide as it is high).

Chapter

Just as a book is split up into several chapters, a title on a DVD disc is usually divided into chapters. See also Title.

Component video output

This is a video signal format that conveys each of three principal colors of light (red, blue and green) through different signal lines. This allows the viewers to experience picture colors as original as it is. There are several signal formats, including Y / P_B / P_R and Y / C_B / C_R.

Digital audio

An indirect representation of sound by numbers. During recording, the sound is measured at discrete intervals (44, 100 times a second for CD audio) by an analog-to-digital converter, generating a stream of numbers. On playback, a digital-to-analog converter generates an analog signal based on these numbers. See also Sampling frequency and Analog audio.

Dolby Digital

The system developed by Dolby Laboratories to compress digital sound. It offers you sound of stereo (2ch) or multi-channel audio.

Finalize

To make recorded contents on DVD discs possible to be played back on DVD players.

MP3 (MPEG Audio Layer 3)

MP3 is a method of compressing files. You can copy MP3 files on CD-RW / R discs from the computer and play back the files on this unit.

PCM (Pulse Code Modulation)

PCM is a format that converts audio into digital data. It is mainly used for Audio CDs and DAT. This unit can play back sounds as realistic as possible by converting even compressed Dolby Digital and MPEG audio to PCM.

Progressive scan (480p)

A type of display that does not split each frame into fields, and instead scans directly through all the scanlines of each frame in order. Progressive scan provides less flickering and higher image resolution than traditional (480i) TV signals.

See page 16 for instructions on selective Progressive Scan mode.

Regions code

Regions associate discs and players with particular areas of the world. This unit will only play back discs that have compatible region codes. You can find the region code of your unit by looking at the rear panel. Some discs are compatible with more than one region (or all regions).

Sampling frequency

The rate which sound is measured by a specified interval to turn it into digital audio data. The numbers of sampling in one second defines as sampling frequency. The higher the rate, the better the sound quality is.

SAP (Secondary Audio Program)

Sub-audio channel which is delivered separately from main-audio channel. This audio channel is used as an alternate in bilingual broadcasting.

S-Video output

It delivers independently each signal of color(C) and luminance(Y) to TV as video signals, so that higher-quality picture will be materialized.

Title (DVD only)

A collection of chapters on DVD disc. See also chapter.

Track

Audio CDs use tracks to divide the content of a disc. The DVD equivalent is called a chapter. See also Chapter.

WMA

WMA is the audio file compressing technology developed by Microsoft. You can copy WMA files on CD-RW / R discs from a computer and play them back on this unit.

Others

Language Code

Language	Code	Language	Code	Language	Code	Language	Code
Abkhazian	4748	French [FRE]	5264	Lithuanian	5866	Sindhi	6550
Afar	4747	Frisian	5271	Macedonian	5957	Singhalese	6555
Afrikaans	4752	Galician	5358	Malagasy	5953	Siswat	6565
Albanian	6563	Georgian	5747	Malay	5965	Slovak	6557
Amharic	4759	German [GER]	5051	Malayalam	5958	Slovenian	6558
Arabic	4764	Greek [GRE]	5158	Maltese	5966	Somali	6561
Armenian	5471	Greenlandic	5758	Maori	5955	Spanish [SPA]	5165
Assamese	4765	Guarani	5360	Marathi	5964	Sundanese	6567
Aymara	4771	Gujarati	5367	Moldavian	5961	Swahili	6569
Azerbaijani	4772	Hausa	5447	Mongolian	5960	Swedish [SWE]	6568
Bashkir	4847	Hebrew	5569	Nauru	6047	Tagalog	6658
Basque	5167	Hindi	5455	Nepali	6051	Tajik	6653
Bengali; Bangla	4860	Hungarian [HUN]	5467	Norwegian [NOR]	6061	Tamil	6647
Bhutani	5072	Icelandic	5565	Occitan	6149	Tatar	6666
Bihari	4854	Indonesian	5560	Oromo (Afan)	6159	Telugu	6651
Bislama	4855	Interlingua	5547	Oriya	6164	Thai	6654
Breton	4864	Interlingue	5551	Panjabi	6247	Tibetan	4861
Bulgarian	4853	Inupiak	5557	Pashto; Pushto	6265	Tigrinya	6655
Burmese	5971	Irish [IRI]	5347	Persian	5247	Tonga	6661
Byelorussian	4851	Italian [ITA]	5566	Polish	6258	Tsonga	6665
Cambodian	5759	Japanese [JPN]	5647	Portuguese [POR]	6266	Turkish [TUR]	6664
Catalan	4947	Javanese	5669	Quechua	6367	Turkmen	6657
Chinese [CHI]	7254	Kannada	5760	Rhaeto-Romance	6459	Twi	6669
Corsican	4961	Kashmiri	5765	Romanian [RUM]	6461	Ukrainian	6757
Croatian	5464	Kazakh	5757	Russian [RUS]	6467	Urdu	6764
Czech	4965	Kinyarwanda	6469	Samoan	6559	Uzbek	6772
Danish [DAN]	5047	Kirghiz	5771	Sangho	6553	Vietnamese	6855
Dutch [DUT]	6058	Kirundi	6460	Sanskrit	6547	Volapuk	6861
English [ENG]	5160	Korean [KOR]	5761	Scots Gaelic	5350	Welsh	4971
Esperanto	5161	Kurdish	5767	Serbian	6564	Wolof	6961
Estonian	5166	Laothian	5861	Serbo-Croatian	6554	Xhosa	7054
Faroese	5261	Latin	5847	Sesotho	6566	Yiddish	5655
Fiji	5256	Latvian; Lettish	5868	Setswana	6660	Yoruba	7161
Finnish [FIN]	5255	Lingala	5860	Shona	6560	Zulu	7267

Maintenance

SERVICING

- Please refer to relevant topics on the 'Troubleshooting' on pages 86–90 before returning the product.
- If this unit becomes inoperative, do not try to correct the problem by yourself. There are no user-serviceable parts inside. Turn off, unplug the power plug and please call our help line mentioned on the front page to locate an Authorized Service Center.

CLEANING THE CABINET

- Use a soft cloth slightly moistened with a mild detergent solution. Do not use a solution containing alcohol, spirits, ammonia or abrasive.

DVR DVR HANDLING

- DVR is a precision apparatus that is susceptible to vibration, strong impact or dirt. Depending on the installation environment or handling, the unit may become partially damaged or in the worst case, recording or replaying may not be available. Especially while the DVR is in motion, do not subject it to vibration or strong impact or pull out the power plug. And if a power failure occurs the content of the recording/replaying program may be lost.

DVR MOVING THE UNIT

- DVR rotates at high speed when in operation. Be sure that rotation has stopped and then move the unit without subjecting it to strong impact or vibration.

DVD CLEANING DISCS

- When a disc becomes dirty, clean it with a cleaning cloth. Wipe the disc from the center out. Do not wipe in a circular motion.
- Do not use solvents such as benzene, thinner, commercially available cleaners, detergent, abrasive cleaning agents or antistatic spray intended for analog records.

DVD CLEANING THE DISC LENS

- If this unit still does not perform properly although you refer to the relevant sections and to 'Troubleshooting' in this Owner's Manual, the laser optical pickup unit may be dirty. Consult your dealer or an Authorized Service Center for inspection and cleaning of the laser optical pickup unit.

DVD DISC HANDLING

- Handle the discs so that fingerprints and dust do not adhere to the surfaces of the discs.
- Always store the disc in its protective case when it is not used.

Frequently Asked Questions

- Can I play back DVD-Video that is bought in another country?
Possible only if the region code of the disc is 1 or ALL.
- Is this unit JPEG compatible?
No.
- Can I connect the unit to my PC?
No, you cannot control the unit by PCs.

Specification

General

System	DVR, DVD Player	Dimensions (width x height x depth)	17 3/16" x 2 3/4" x 11 11/16" (435 x 69.5 x 296 mm)
DVR	Internal 3.5 inch HDD 80 GB	Operating temperature	41°F to 104°F (5°C to 40°C)
Power requirements	AC120V, 60 Hz	Operating humidity	less than 80% (non condensing)
Power consumption	30 W (standby: 2.5 W)	TV format	NTSC
Weight	8.2 lbs (3.7 kg)		

Recording

Audio recording format	Video recording format
Sampling frequency 13.5MHz	Sampling frequency 48kHz
Compression format MPEG	Compression format Dolby Digital

Tuner

Receiveable channels	
VHF	2-13ch
UHF	14-69ch
CATV	C1-C125ch

Input/Output

Video input	Video output
Input 1 (rear)	Output level 1 Vp-p (75Ω)
Input level 1 Vp-p (75Ω)	Jacks RCA jack
Jacks RCA jack	
S-Video output	Component video output
Y (luminance)	Output level Y: 1.0 Vp-p (75Ω),
- Output level 1 Vp-p (75Ω)	Pb/Cb, Pr/Cr: 0.7 Vp-p (75Ω)
C (color)	Jacks RCA jacks
- Output level 286 mVp-p (75Ω)	
Jack 4 pin mini DIN	
Audio input	Digital audio output
Input 1 (rear)	Output level 500 mVp-p (75Ω)
During audio input 2V rms (47kΩ)	Jack RCA jack
Jacks RCA jacks	
Audio output	VHF/UHF antenna
Output 1,2 L/R	input/output terminal VHF/UHF set 75Ω
During audio output 2V rms (47kΩ)	
Jacks RCA jacks	

Note

The specifications and design of this product are subject to change without notice.

Others

Memo

Before You Start

Connections

DVR

DVD

Others

Symphonic

LIMITED WARRANTY

FUNAI CORP. will repair this product, free of charge in CANADA in the event of defect in materials or workmanship as follows :

DURATION :

PARTS : FUNAI CORP. will provide parts to replace defective parts without charge for one (1) year from the date of original retail purchase. Certain parts are excluded from this warranty.

LABOR : FUNAI CORP. will provide the labor without charge for a period of ninety (90) days from the date of original retail purchase.

LIMITS AND EXCLUSIONS :

THIS WARRANTY IS EXTENDED ONLY TO THE ORIGINAL RETAIL PURCHASER. A PURCHASE RECEIPT OR OTHER PROOF OF ORIGINAL RETAIL PURCHASE WILL BE REQUIRED TOGETHER WITH THE PRODUCT TO OBTAIN SERVICE UNDER THIS WARRANTY.

This warranty shall not be extended to any other person or transferee.

This warranty is void and of no effect if any serial numbers on the product are altered, replaced, defaced, missing or if service was attempted by AN UNAUTHORIZED SERVICE CENTER. This limited warranty does not apply to any product not purchased and used in CANADA.

This warranty only covers failures due to defects in material or workmanship which occurs during normal use. It does not cover damage which occurs in shipment, or failures which are caused by repairs, alterations or product not supplied by FUNAI CORP. or damage which results from accident, misuse, abuse, mishandling, misapplication, alteration, faulty installation, improper maintenance, commercial use such as hotel, rental or office use of this product or damage which results from fire, flood, lightning or other acts of God.

THIS WARRANTY DOES NOT COVER PACKING MATERIALS, ANY ACCESSORIES (EXCEPT REMOTE CONTROL), ANY COSMETIC PARTS, COMPLETE ASSEMBLY PARTS, DEMO OR FLOOR MODELS.

FUNAI CORP. AND ITS REPRESENTATIVES OR AGENTS SHALL IN NO EVENT BE LIABLE FOR ANY GENERAL, INDIRECT OR CONSEQUENTIAL DAMAGES ARISING OUT OF OR OCCASIONED BY THE USE OF OR THE INABILITY TO USE THIS PRODUCT. THIS WARRANTY IS MADE IN LIEU OF ALL OTHER WARRANTIES, EXPRESS OR IMPLIED AND OF ALL OTHER LIABILITIES ON THE PART OF FUNAI, ALL OTHER WARRANTIES INCLUDING THE WARRANTY OF MERCHANTABILITY AND FITNESS FOR A PARTICULAR PURPOSE, ARE HEREBY DISCLAIMED BY FUNAI AND ITS REPRESENTATIVES IN CANADA.

ALL WARRANTY INSPECTIONS AND REPAIRS MUST BE PERFORMED BY AN AUTHORIZED SERVICE CENTER. THIS WARRANTY IS ONLY VALID WHEN THE UNIT IS CARRIED-IN TO AN AUTHORIZED SERVICE CENTER.

THE PRODUCT MUST BE ACCOMPANIED BY A COPY OF THE ORIGINAL RETAIL PURCHASE RECEIPT. IF NO PROOF OF PURCHASE IS ATTACHED, THE WARRANTY WILL NOT BE HONORED AND REPAIRS COSTS WILL BE CHARGED.

ATTENTION :

FUNAI CORP. RESERVES THE RIGHT TO MODIFY ANY DESIGN OF THIS PRODUCT WITHOUT PRIOR NOTICE.

WARRANTY STATEMENT REGARDING NON AUTHORIZED REPAIRS :

To obtain warranty service, you must take the product, or deliver the product freight prepaid, in either its original packaging or packaging affording an equal degree of protection, to any AUTHORIZED SERVICE CENTER. FUNAI CORP. will not reimburse you for any service done by unauthorized service providers without prior written approval.

To locate your nearest AUTHORIZED SERVICE CENTER or for general service inquiries, please contact us at:

FUNAI CORPORATION

Customer Service

Tel: 1-800-605-8453

<http://www.Symphonic.us>

19900 Van Ness Avenue, Torrance, CA 90501

Free Manuals Download Website

<http://myh66.com>

<http://usermanuals.us>

<http://www.somanuals.com>

<http://www.4manuals.cc>

<http://www.manual-lib.com>

<http://www.404manual.com>

<http://www.luxmanual.com>

<http://aubethermostatmanual.com>

Golf course search by state

<http://golfingnear.com>

Email search by domain

<http://emailbydomain.com>

Auto manuals search

<http://auto.somanuals.com>

TV manuals search

<http://tv.somanuals.com>