

Symphonic

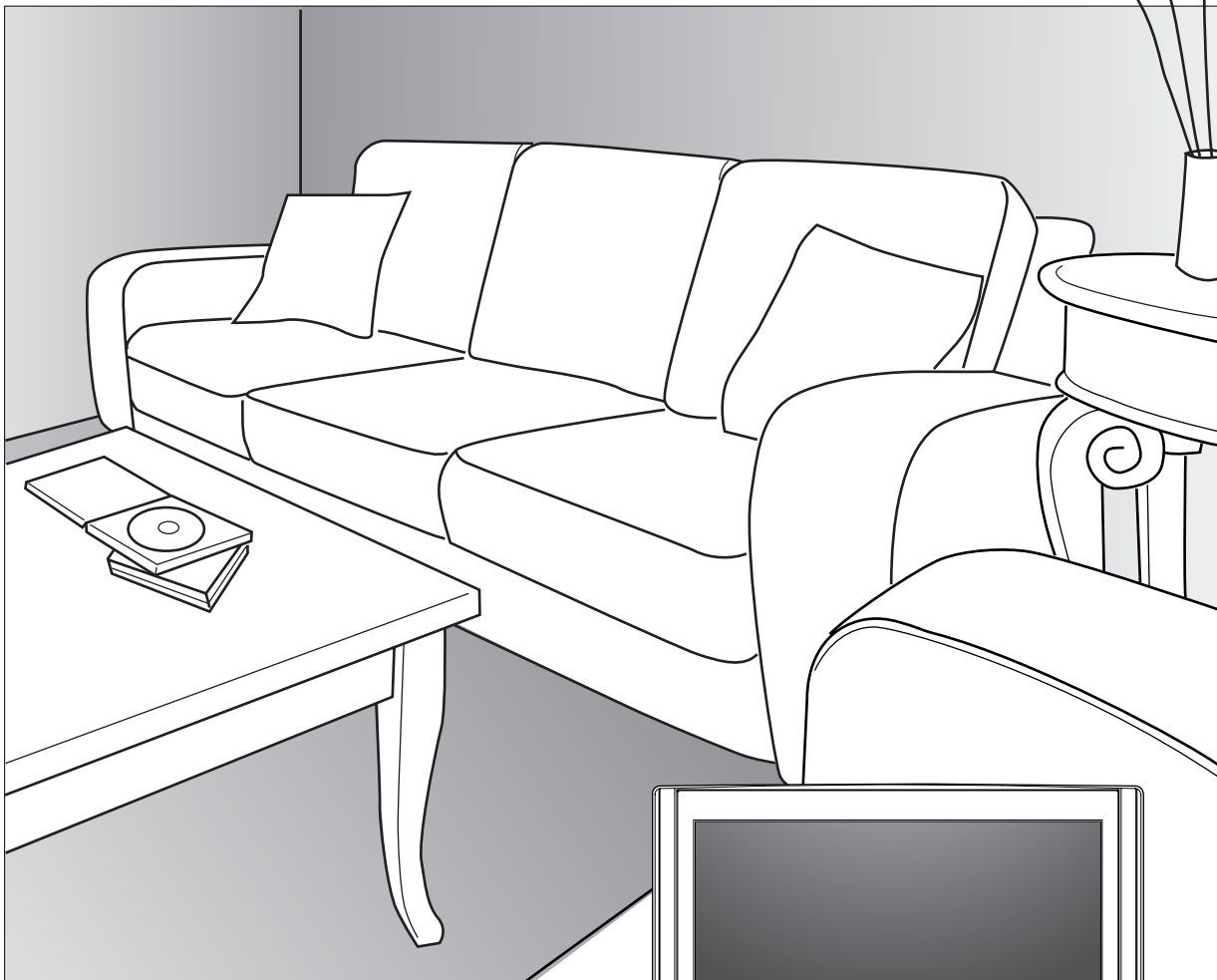

OWNER'S MANUAL

LCD
TV/DVD

5 inch
Disc ONLY

STL20D5 (20 inch)

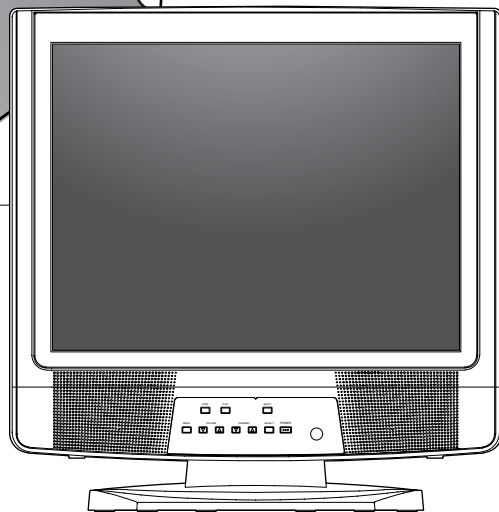



INSTRUCCIONES EN ESPAÑOL INCLUIDAS

If you need additional operating assistance after reading this owner's manual or to order replacement accessories, please call
TOLL FREE : 1-800-242-7158 or visit our
WEB SITE at <http://www.Symphonic.us>.

Please read before using this equipment

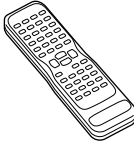
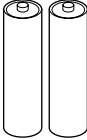
SUPPLIED ACCESSORIES

<p>Remote Control Unit</p>  <p>(NE240UD)</p>	<p>Batteries</p>  <p>2 AA Batteries</p>	<p>Owner's Manual</p>  <p>(1EMN21009)</p>
---	--	--

- If you need to replace these accessories, please refer to the PART NO. under the illustrations and call our help line mentioned on the front page.
- Depending on your antenna system, you may need different types of Combiners (Mixer) or Separators (Splitter). Contact your local electronics store for these items.

The serial number of this product may be found on the back of the unit. No other unit has the same serial number as yours. You should record the number and other vital information here and retain this book as a permanent record of your purchase to aid identification in case of theft. Serial numbers are not kept on file.

Date of Purchase	
Dealer Purchase from	
Dealer Address	
Dealer Phone No.	
Model No.	
Serial No.	

IMPORTANT SAFEGUARDS

- 1.Read instructions-**All the safety and operating instructions should be read before the appliance is operated.
- 2.Retain Instructions-**The safety and operating instructions should be retained for future reference.
- 3.Heed Warnings-**All warnings on the appliance and in the operating instructions should be adhered to.
- 4.Follow Instructions-**All operating and use instructions should be followed.
- 5.Cleaning-**Unplug the unit from the wall outlet before cleaning. Do not use liquid cleaners or aerosol cleaners. Use a damp cloth for cleaning.
EXCEPTION: A product that is meant for uninterrupted service and, that for some specific reason, such as the possibility of the loss of an authorization code for a CATV converter, is not intended to be unplugged by the user for cleaning or any other purpose, may exclude the reference to unplugging the appliance in the cleaning description otherwise required in item 5.
- 6.Attachments-**Do not use attachments not recommended by the unit manufacturer as they may cause hazards.
- 7.Water and Moisture-**Do not use this unit near water-for example, near a bath tub, wash bowl, kitchen sink, or laundry tub, in a wet basement, or near a swimming pool, and the like.

- 8.Accessories-**Do not place this unit on an unstable cart, stand, tripod, bracket, or table. The unit may fall, causing serious injury to someone, and serious damage to the appliance. Use only with a cart, stand, tripod, bracket, or table recommended by the manufacturer, or sold with the unit. Any mounting of the appliance should follow the manufacturer's instructions and should use a mounting accessory recommended by the manufacturer. An appliance and cart combination should be moved with care. Quick stops, excessive force, and uneven surfaces may cause the appliance and cart combination to overturn.

PORTABLE CART WARNING



S3126A

- AMEUBLES-** Cet appareil ne doit être placé que sur un meuble (avec ou sans roulettes) recommandé par le fabricant. Si vous l'installez sur un meuble à roulettes, déplacez les deux ensembles avec précaution. Un arrêt brusque, l'utilisation d'une force excessive et des surfaces irrégulières risquent de déstabiliser l'ensemble et de le renverser.

SYMBOLE D'AVERTISSEMENT POUR LES COMPOSANTES APPAREIL ET MEUBLE A ROULETTES



S3126A

9. Ventilation-Slots and openings in the cabinet and the back or bottom are provided for ventilation and to ensure reliable operation of the unit and to protect it from overheating, and these openings must not be blocked or covered. The openings should never be blocked by placing the unit on a bed, sofa, rug, or other similar surface. This unit should never be placed near or over a radiator or heat register. This unit should not be placed in a built-in installation such as a bookcase or rack unless proper ventilation is provided or the manufacturer's instructions have been adhered to.

10. Power Sources-This unit should be operated only from the type of power source indicated on the marking label. If you are not sure of the type of power supply to your home, consult your appliance dealer or local power company. For the units intended to operate from battery power, or other sources, refer to the operating instructions.

11. Grounding or Polarization-This unit is equipped with a polarized alternating-current line plug (a plug having one blade wider than the other). This plug will fit into the power outlet only one way. This is a safety feature. If you are unable to insert the plug fully into the outlet, try reversing the plug. If the plug should still fail to fit, contact your electrician to replace your obsolete outlet. Do not defeat the safety purpose of the polarized plug.

12. Power-Cord Protection-Power-supply cords should be routed so that they are not likely to be walked on or pinched by items placed upon or against them, paying particular attention to cords at plugs, convenience receptacles, and the point where they exit from the appliance.

13. Outdoor Antenna grounding-If an outside antenna or cable system is connected to the unit, be sure the antenna or cable system is grounded so as to provide some protection against voltage surges and built-up static charges. Article 810 of the National Electrical Code, ANSI/NFPA No. 70, provides information with respect to proper grounding of the mast and supporting structure, grounding of the lead-in wire to an antenna discharge unit, size of grounding conductors, location of antenna-discharge unit, connection to grounding electrodes, and requirements for the grounding electrode. (Fig. A)

FIGURE A
EXAMPLE OF ANTENNA GROUNDING AS PER
NATIONAL ELECTRICAL CODE

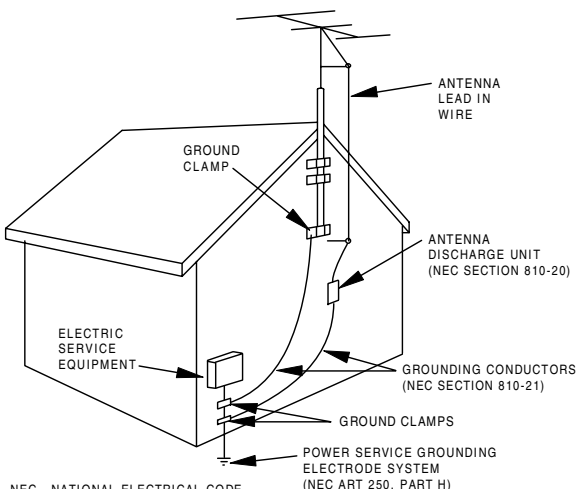

NEC - NATIONAL ELECTRICAL CODE
S2898A

14. Lightning-For added protection for this unit receiver during a lightning storm, or when it is left unattended and unused for long periods of time, unplug it from the wall outlet and disconnect the antenna or cable system. This will prevent damage to the unit due to lightning and power-line surges.

15. Power Lines-An outside antenna system should not be located in the vicinity of overhead power lines or other electric light or power circuits, or where it can fall into such power lines or circuits. When installing an outside antenna system, extreme care should be taken to keep from touching such power lines or circuits as contact with them might be fatal.

16. Overloading-Do not overload wall outlets and extension cords as this can result in a risk of fire or electric shock.

17. Object and Liquid Entry-Never push objects of any kind into this unit through openings as they may touch dangerous voltage points or short out parts that could result in a fire or electric shock. Never spill liquid of any kind on the unit.

18. Servicing-Do not attempt to service this unit yourself as opening or removing covers may expose you to dangerous voltage or other hazards. Refer all servicing to qualified service personnel.

19. Damage Requiring Service-Unplug this unit from the wall outlet and refer servicing to qualified service personnel under the following conditions:

- When the power-supply cord or plug is damaged or frayed.
- If liquid has been spilled, or objects have fallen into the unit.
- If the unit has been exposed to rain or water.
- If the unit does not operate normally by following the operating instructions. Adjust only those controls that are covered by the operating instructions, as improper adjustment of other controls may result in damage and will often require extensive work by a qualified technician to restore the unit to its normal operation.
- If the unit has been dropped or damaged in any way.
- When the unit exhibits a distinct change in performance, this indicates a need for service.

20. Replacement Parts-When replacement parts are required, be sure the service technician has used replacement parts specified by the manufacturer that have the same characteristics as the original part. Unauthorized substitutions may result in fire, electric shock, injury to persons or other hazards.

21. Safety Check-Upon completion of any service or repairs to this unit, ask the service technician to perform routine safety checks to determine that the unit is in proper operating condition.

22. Heat-This unit product should be situated away from heat sources such as radiators, heat registers, stoves, or other products (including amplifiers) that produce heat.

PRECAUTIONS

IMPORTANT COPYRIGHT INFORMATION

Unauthorized copying, broadcasting, public performance and lending of discs are prohibited.

This product incorporates copyright protection technology that is protected by U.S. patents and other intellectual property rights. Use of this copyright protection technology must be authorized by Macrovision, and is intended for home and other limited viewing uses only unless otherwise authorized by Macrovision. Reverse engineering or disassembly is prohibited.

FCC WARNING- This equipment may generate or use radio frequency energy. Changes or modifications to this equipment may cause harmful interference unless the modifications are expressly approved in the instruction manual. The user could lose the authority to operate this equipment if an unauthorized change or modification is made.

RADIO-TV INTERFERENCE

This equipment has been tested and found to comply with the limits for a Class B digital device, pursuant to Part 15 of the FCC Rules. These limits are designed to provide reasonable protection against harmful interference in a residential installation. This equipment generates, uses, and can radiate radio frequency energy and, if not installed and used in accordance with the instructions, may cause harmful interference to radio communications.

However, there is no guarantee that interference will not occur in a particular installation. If this equipment does cause harmful interference to radio or television reception, which can be determined by turning the equipment off and on, the user is encouraged to try to correct the interference by one or more of the following measures:

- 1) Reorient or relocate the receiving antenna.
- 2) Increase the separation between the equipment and receiver.
- 3) Connect the equipment into an outlet on a circuit different from that to which the receiver is connected.
- 4) Consult the dealer or an experienced radio/TV technician for help.

LASER SAFETY

This unit employs a laser. Only a qualified service person should remove the cover or attempt to service this device, due to possible eye injury.

CAUTION: USE OF CONTROLS OR ADJUSTMENTS OR PERFORMANCE OF PROCEDURES OTHER THAN THOSE SPECIFIED HEREIN MAY RESULT IN HAZARDOUS RADIATION EXPOSURE.

CAUTION: VISIBLE AND INVISIBLE LASER RADIATION WHEN OPEN AND INTERLOCK DEFEATED. DO NOT STARE INTO BEAM.

LOCATION: INSIDE, NEAR THE DECK MECHANISM.

This Class B digital apparatus complies with Canadian ICES-003.

Cet appareil numérique de la classe B est conforme à la norme NMB-003 du Canada.

CAUTION: TO PREVENT ELECTRIC SHOCK, MATCH WIDE BLADE OF PLUG TO WIDE SLOT, FULLY INSERT.

ATTENTION: POUR ÉVITER LES CHOC ÉLECTRIQUES, INTRODUIRE LA LAME LA PLUS LARGE DE LA FICHE DANS LA BORNE CORRESPONDANTE DE LA PRISE ET POUSSER JUSQU'AU FOND.

A NOTE ABOUT RECYCLING

Batteries should never be thrown away or incinerated but disposed of in accordance with your local regulations concerning chemical wastes.

WARNING: TO REDUCE THE RISK OF FIRE OR ELECTRIC SHOCK, DO NOT EXPOSE THIS APPLIANCE TO RAIN OR MOISTURE.



CAUTION
RISK OF ELECTRIC SHOCK
DO NOT OPEN



CAUTION: TO REDUCE THE RISK OF ELECTRIC SHOCK, DO NOT REMOVE COVER (OR BACK). NO USER SERVICEABLE PARTS INSIDE. REFER SERVICING TO QUALIFIED SERVICE PERSONNEL.



THIS SYMBOL INDICATES THAT DANGEROUS VOLTAGE CONSTITUTING A RISK OF ELECTRIC SHOCK IS PRESENT WITHIN THIS UNIT.



THIS SYMBOL INDICATES THAT THERE ARE IMPORTANT OPERATING AND MAINTENANCE INSTRUCTIONS IN THE LITERATURE ACCOMPANYING THE APPLIANCE.

The caution marking is located on the rear of the cabinet.

LOCATION

For safe operation and satisfactory performance of your unit, keep the following in mind when selecting a place for its installation:

- Shield it from direct sunlight and keep it away from sources of intense heat.
- Avoid dusty or humid places.
- Avoid places with insufficient ventilation for proper heat dissipation. Do not block the ventilation holes at the top or bottom of the unit. Do not place the unit on a carpet because this will block the ventilation holes.
- Install unit in a horizontal position.
- Avoid locations subject to strong vibration.
- Do not place the unit near strong magnetic fields.
- Avoid moving the unit to locations where temperature differences are extreme.
- Be sure to remove a disc and unplug the AC power cord from the outlet before carrying the unit.

AVOID THE HAZARDS OF ELECTRICAL SHOCK AND FIRE

- Do not handle the power cord with wet hands.
- Do not pull on the power cord when disconnecting it from an AC wall outlet. Grasp it by the plug.
- If by accident, water is spilled on your unit, unplug the power cord immediately and take the unit to our Authorized Service Center for servicing.
- Do not put your fingers or objects into the unit disc slot.
- Do not place anything directly on top of the unit.

WARNING

Moisture condensation may occur inside the unit when it is moved from a cold place to a warm place or after heating a cold room or under conditions of high humidity. If a DVD is played in a unit which has moisture, it may damage the DVD and the unit. Therefore when the condensation occurs inside the unit, turn the unit on and allow at least 2 hours for the unit to dry out.

SYMBOLS USED IN THIS MANUAL

The following symbols below appear in some headings in this manual.



: Description refers to playback of DVD video discs (in the DVD mode).



: Description refers to playback of Audio CDs (in the DVD mode).



: Description refers to playback of CDs with MP3 files (in the DVD mode).



: Description refers to the items to be set by the QUICK mode (in the DVD mode).

TILT STAND

You can adjust the stand to change the angle of the TV (-5° to 10°).

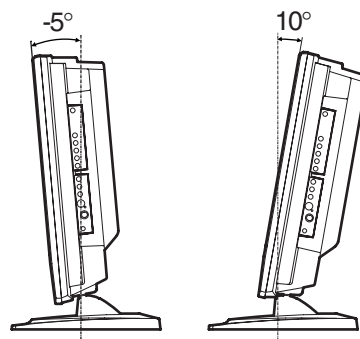

TABLE OF CONTENTS

SUPPLIED ACCESSORIES2	SEARCH FUNCTION22
IMPORTANT SAFEGUARDS2	TRACK SEARCH22
PRECAUTIONS4	TITLE / CHAPTER SEARCH22
LOCATION5	TIME SEARCH23
AVOID THE HAZARDS OF ELECTRICAL SHOCK AND FIRE5	MARKER SETUP SCREEN23
WARNING5	SPECIAL PLAYBACK FUNCTION24
SYMBOLS USED IN THIS MANUAL5	REPEAT24
TILT STAND5	A-B REPEAT24
TABLE OF CONTENTS6	PROGRAM25
FEATURES7	RANDOM PLAYBACK25
OPERATING CONTROLS AND FUNCTIONS8	CHANGING THE SETTINGS26
INSTALLING THE BATTERIES9	SUBTITLE LANGUAGE26
PREPARATION FOR USE10	AUDIO LANGUAGE26
ANTENNA/CABLE CONNECTION10	STEREO SOUND MODE26
EXTERNAL CONNECTION11	CAMERA ANGLE27
		BLACK LEVEL SETTING27
		VIRTUAL SURROUND27
		THE ON-SCREEN INFORMATION28
		CHANGING THE DVD SET UP ITEMS29
		CUSTOM MENU29
		[D] LANGUAGE SETTING29
		[E] DISPLAY SETTING30
		[F] AUDIO SETTING30
		[G] PARENTAL CONTROL31
		[H] OTHER SETTINGS31
		INITIALIZE32
		TROUBLESHOOTING GUIDE33
		MAINTENANCE36
		DISC HANDLING36
		SPECIFICATIONS37
		ESPAÑOL38
		WARRANTYBack Cover
TV SECTION			
TV OPERATION AND SETTINGS12		
WATCHING A TV PROGRAM12		
CHANNEL SET UP13		
PICTURE CONTROL14		
BACK LIGHT SETTING14		
SLEEP TIMER14		
CLOSED CAPTION SYSTEM15		
MTS (Multi-Channel Television Sound) System15		
V-CHIP SET UP16		
[A] TV RATING SET UP16		
[B] MPAA RATING SET UP17		
[C] CHANGE ACCESS CODE17		
MENU LANGUAGE17		
DVD SECTION			
ABOUT THE DISCS18		
PLAYABLE DISCS18		
UNPLAYABLE DISCS18		
PLAYING A DISC19		
BASIC PLAYBACK19		
DISC MENU20		
TITLE MENU20		
RESUME20		
PAUSE20		
STEP BY STEP PLAYBACK20		
FAST FORWARD / FAST REVERSE21		
SLOW FORWARD / SLOW REVERSE21		
ZOOM21		

FEATURES

TV Mode

- **MTS/SAP Tuner**
- **Infrared remote control**
- **Trilingual on screen TV setup display available in English, Spanish or French**
- **181 channel capability PLL frequency synthesizer tuner with direct station call** (A converter may be necessary to view scrambled cable channels.)
- **Closed Caption Decoder**—You may view specially labeled (cc) TV programs, movies, news, etc. with either a dialogue caption or text display added to the program.
- **Auto power off system**—If there is no air signal input from the antenna terminal and no operation for 15 minutes, the unit will turn itself off automatically.
- **Sleep timer**—Allows you to have the unit automatically turn off at a desired time.
- **V-CHIP**—Enables parents to prevent their children from watching inappropriate material on TV.

DVD Mode

- **Dolby Digital sound**
This unit can handle Dolby Digital surround sound having 5.1 channels when connected to a Dolby Digital decoder.
- **Still/fast/slow/step playback**
Various playback modes are available including still pictures, fast forward/reverse, slow motion and step frames.
- **Random playback for Audio CD and MP3**
This unit can shuffle the order of tracks to play them in random order.
- **Program playback for Audio CD and MP3**
You can program the order of tracks to play them in any desired order.
- **DVD menus in a desired language**
You can display DVD menus in a desired language, if available on a DVD.
- **Screen saver**
If the screen saver program is set to ON, it starts when there is no input from the unit for 5 minutes in stop mode.
- **Subtitles in a desired language**
You can select a desired language for the display subtitles, if that language is available on a disc.
- **Selecting a camera angle**
You can select the desired camera angle, if a disc contains sequences recorded from different angles.
- **Choices for audio language and sound mode**
You can select the desired audio language and sound mode, if different languages and modes are available on a disc.
- **Parental lock**
You can set the control level to limit playback of discs which may not be suitable for children.
- **Automatic detection of discs**
This unit automatically detects if the loaded disc is DVD, Audio CD or MP3 on disc.
- **On-screen display**
Information about the current operation can be displayed on a TV screen, allowing you to confirm the currently active functions (such as program playback), on the TV screen using the remote control.
- **Search**
Chapter search / Title search / Track search / Time search
- **Repeat**
Chapter / Title / Track / Group / All / A-B
- **Zoom**
Allows you to enlarge video image.
- **Marker**
The part designated by user can be called back.
- **Resume Play**
User can resume to playback from the part at which the play was stopped.
- **Virtual Surround**
- **Bit rate indication**
- **DRC (Dynamic range control)**
You can control the range of sound volume.

OPERATING CONTROLS AND FUNCTIONS

NOTE

- When you select DVD mode, press [PLAY ▷] or [EJECT ▲] first or insert a disc into the disc slot. Otherwise, the DVD features are not operated.

REMOTE CONTROL

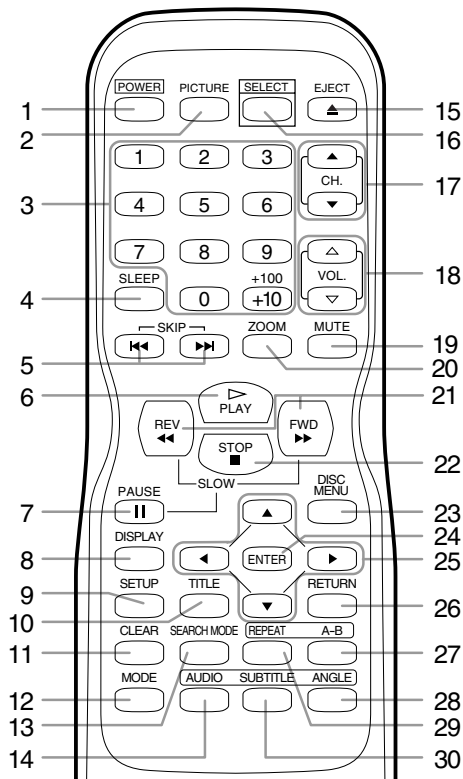

[Fig. 1]

- POWER button** (P.12)
Press to turn the power on and off.
- PICTURE button** (P.14)
Press to adjust the picture.
- Number buttons** (P.13)
Press to select a desired channel number directly.
+100 button (For TV mode)
Press to select channels higher than 99.
+10 button (For DVD mode)
Press to enter desired numbers higher than 9.
- SLEEP button** (P.14)
Press to set the Sleep Timer.
- SKIP ◀◀ / ▶▶ buttons** (P.22)
Press once to skip chapters/tracks to a desired point.
- PLAY ▷ button** (P.19)
Press to playback the disc.
- PAUSE || button** (P.20)
Press to pause the current disc operation.
- DISPLAY button**
For TV mode (P.15):
Press to display the current channel number on the TV screen.
For DVD mode (P.28):
Press to display the current status on the TV screen.
- SETUP button** (P.13, P.29)
Press to enter or exit the setup menu of TV/DVD.
- TITLE button** (P.20)
Press to display the title menu.
- CLEAR button** (P.12, P.22)
Press to clear/cancel a setting currently entered.
Press to clear "DISC INSIDE" display.
- MODE button** (P.25)
Press to call up the program/random screen in stop mode.
Press to call up the Black Level Setting/Virtual Surround screen during playback.
- SEARCH MODE button** (P.22, P.23)
Press to locate a desired point.
- AUDIO button** (P.26)
For TV mode (P.15): Press to select TV sound mode (STEREO/SAP/MONO).
For DVD mode (P.26): Press to select a desired audio language (if available).
- EJECT ▲ button** (P.19)
Press to remove a disc from the unit.
- SELECT button** (P.12)
Press to select the TV mode, external input mode or DVD mode.
- CH. ▲ / ▼ buttons** (P.12)
Press to select memorized channels.
- VOL. Δ / ▽ buttons** (P.12)
Press to control the volume level for the DVD and TV.
- MUTE button** (P.12)
Press to mute the sound or press it again to restore sound.
- ZOOM button** (P.21)
Press to enlarge the part of a DVD-reproduced image.
- REV ◀◀ button** (P.21)
Press to view the DVD picture in fast/slow reverse motion.
FWD ▶▶ button (P.21)
Press to view in fast/slow forward motion.
- STOP ■ button** (P.19)
Press to stop operation of the disc.
- DISC MENU button** (P.20)
Calls up the DVD menu.
Calls up the file list in MP3 disc.
- ENTER button** (P.16)
Press to accept a setting.
- ▲ (Up) / ▼ (Down) / ◀ (Left) / ▶ (Right) buttons**
Press to select or adjust menu items.

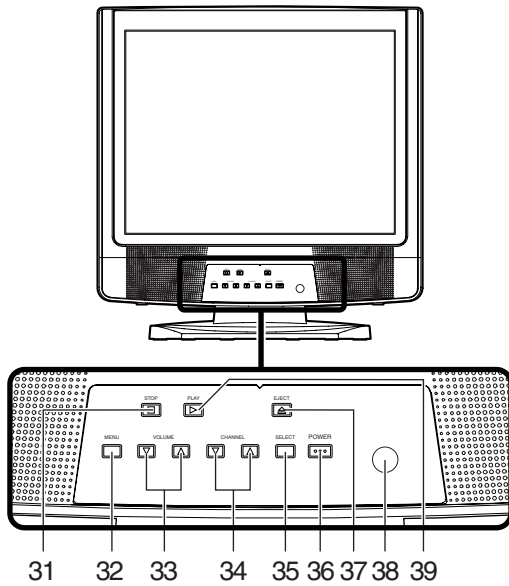

- 26. RETURN button** (P.27)
Press to return to the previous screen in the setup menu.
- 27. A-B button** (P.24)
Press to repeat the playback of a selected section.
- 28. ANGLE button** (P.27)
Press to change the camera angle to see the sequence being played back from a different angle (if available).

- FRONT PANEL



[Fig. 2]

- 29. REPEAT button** (P.24)
Repeats playback of the current disc, title, chapter, group or track.
- 30. SUBTITLE button** (P.26)
Press to select a desired subtitle language.

- 31. STOP**  button (P.19)
Press to stop operation of the disc.
- 32. MENU button**
Press to enter or exit the setup menu of TV/DVD.
- 33. VOLUME** Δ / ∇ buttons (P.12)
Press to control the volume level for the DVD and TV.
- 34. CHANNEL** Δ / ∇ buttons (P.12)
Press to select memorized channels.
- 35. SELECT button** (P.12)
Press to select to TV mode, external input mode or DVD mode.
- 36. POWER button** (P.12)
Press to turn the power on and off.
- 37. EJECT**  button (P.19)
Press to remove a disc from the unit.
- 38. Remote sensor window**
- 39. PLAY**  button (P.19)
Press to playback of the disc.

INSTALLING THE BATTERIES

- 1 Open the battery compartment cover by pressing the cover on the remote unit in the direction of the arrow.
- 2 Insert 2 "AA" penlight batteries into the battery compartment in the direction indicated by the polarity (+/-) markings.
- 3 Replace the cover.

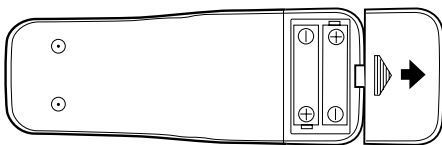

NOTE

- We do not recommend the use of universal remote controls. Not all of the functions may be controlled with a universal remote control. If you decide to use a universal remote control with this unit, please be aware that the code number given may not operate this unit. In this case, please call the manufacturer of the universal remote control.

BATTERY PRECAUTIONS

- Be sure to follow the correct polarity as indicated in the battery compartment. Reversed batteries may cause damage to the device.
- Do not mix different types of batteries together (e.g. Alkaline and Carbon-Zinc) or old batteries with fresh ones.
- If the device is not to be used for a long period of time, remove the batteries to prevent damage or injury from possible battery leakage.
- Do not try to recharge batteries not intended to be recharged; they can overheat and rupture.

PREPARATION FOR USE

ANTENNA/CABLE CONNECTION

NOTE

- Cables used here are commercially available.
- For your safety and to avoid damages to the unit, unplug the antenna cable from the ANT. jack before moving the unit.

- ANTENNA/CABLE CONNECTION (WITH OR WITHOUT BOX)

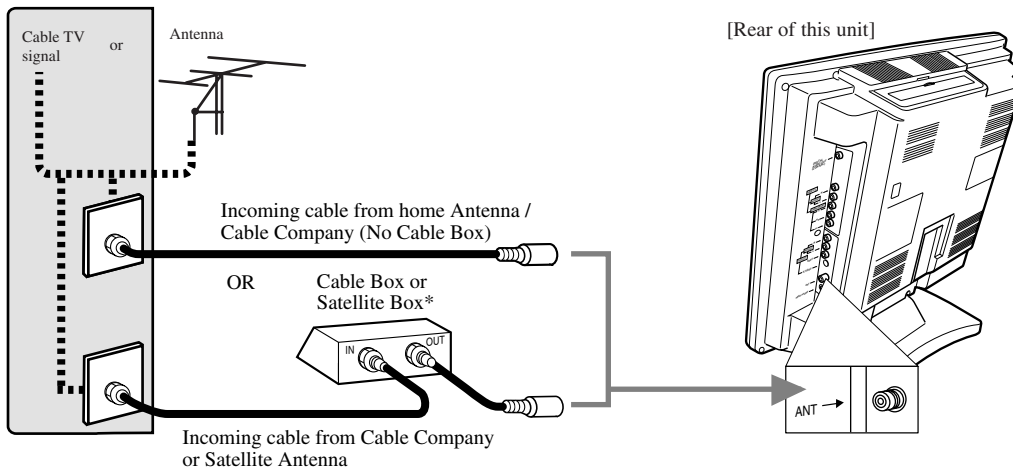

*Some cable TV systems use scrambled signals and require a special converter to receive these channels. Consult your local cable company.

IF YOU HAVE A JACK ON THE WALL

Connect the TV to the wall-mounted antenna jack with on RF cable (commercially available).

IF YOU HAVE A WIRED CABLE

Connect the TV to the wired antenna cable.

WHEN USING CABLE BOX/SATELLITE BOX

If your cable service supplies you with a converter box or if you use a satellite system, you can use the basic connection shown above.

Channel selection must be made with the converter box or satellite box. This means that channels cannot be changed using the remote control of this unit.

NOTE

- Before plugging the antenna into the ANT. jack of the unit, check that the pin is not bent. If it is bent, straighten the pin as illustrated, then plug the pin into the ANT. jack of the unit.

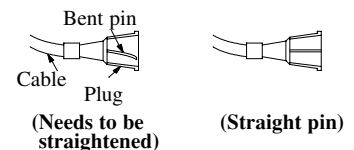

For CATV system installer:

- This reminder is provided to call the CATV system installer's attention to Article 820-40 of the NEC that provides guidelines for proper grounding and in particular, specifies that the cable ground shall be connected to the grounding system of the building as close to the point of cable entry as practical.

EXTERNAL CONNECTION

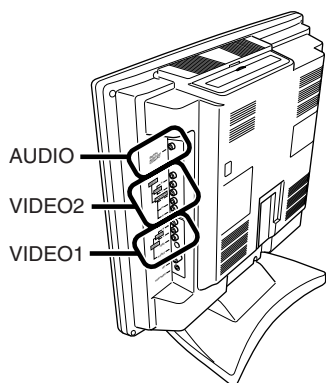

You can connect this unit to your own Audio/Video equipment.

- Be sure to turn off the power to all components in the system before connecting another component.
- Refer to the Owner's Manuals for the equipments to be connected to the unit.

NOTE

When you use the external input, select "VIDEO1" or "VIDEO2" by pressing **[SELECT]**. (Refer to page 12.)

- To use the VIDEO1 input jacks, select "VIDEO1".
- To use the VIDEO2 input jacks, select "VIDEO2".

- VIDEO1 INPUT

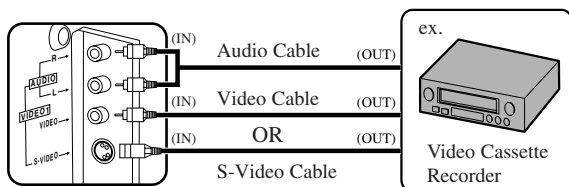

Use this connection if your own A/V equipment (e.g. VCR) has Video output and Audio out jacks. When using S-Video cable, better picture is available.

NOTE

- If your own equipment is monaural (has only one Audio jack), connect the Audio cable to AUDIO L jack of this unit.
- If you connect Video jack and S-VIDEO jack simultaneously, the S-VIDEO jack is given priority over the VIDEO jack.

- VIDEO2 INPUT

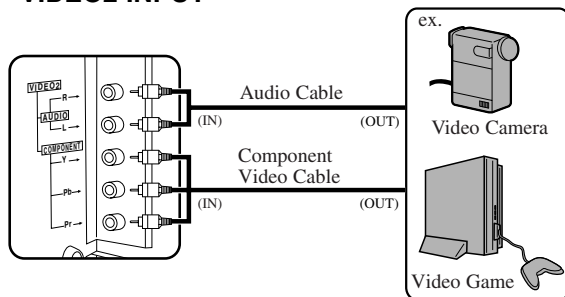

Use this connection if your own A/V equipment (e.g. video camera, video game) has COMPONENT Video output (Y, Pb, Pr) jacks. You can enjoy the best picture with this connection.

- AUDIO OUTPUT

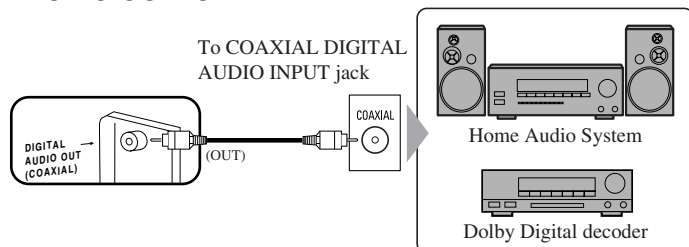

You can enjoy DVD sound with more presence by connecting digital audio equipment such as Dolby Digital decoder.

NOTE

- The audio source on a disc in a 5.1 channel Dolby Digital surround format cannot be recorded as digital sound by an MD or DAT deck.
- If connected to a Dolby Digital decoder, set "DOLBY DIGITAL" to "BITSTREAM" for audio output in the setup mode. (Refer to page 30.)
- Unless connected to a Dolby Digital decoder, set "DOLBY DIGITAL" to "PCM" for audio output in the setup mode. Playing a unit using incorrect settings may generate noise distortion and may also damage the speakers. (Refer to page 30.)

Manufactured under license from Dolby Laboratories. "Dolby" and the double-D symbol are trademarks of Dolby Laboratories.

TV OPERATION AND SETTINGS

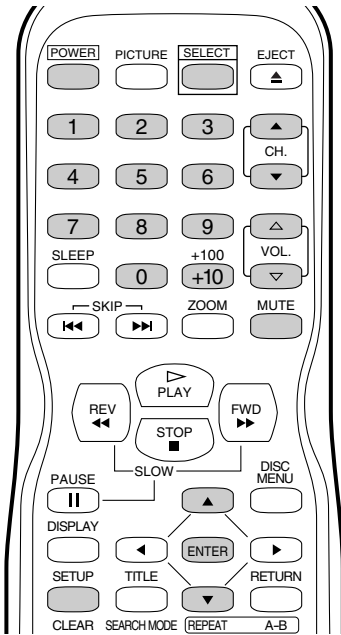

- Shaded buttons are used for following operation.

NOTE

For channel number selection with number buttons:

- To select single-digit channel number, press [0] first. (e.g. Press [0] [2] for channel 2.)
- To select cable channels which are higher than 99, press [+100/+10] first. (e.g. Press [+100/+10] [2] [5] for channel 125.)

- 4 Use [VOL. Δ / ▽] to select the desired volume level.

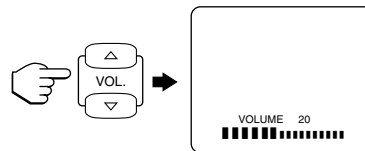

- Press [MUTE] to instantly mute the sound. Press it again to restore the previous volume level.

NOTE

- If you use [CH. ▲ / ▼] in the DVD mode, you can change the TV channels. Even if you turn off the unit in the DVD mode, when you turn it on again, it will go into the TV mode.

WATCHING A TV PROGRAM

- 1 Plug the power cord into a standard AC outlet.

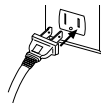

NOTE

- If any digits are displayed in the corner of the screen, press [POWER] without unplugging the power cord.

- 2 Press [POWER] to turn on the unit.



- 3 Use [CH. ▲ / ▼] to select the desired channel number.

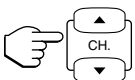

OR

Use the **Number buttons** to enter the desired channel number.

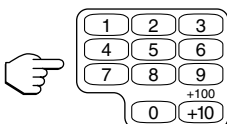

TO WATCH CABLE OR SATELLITE CHANNEL

If the unit is connected to a cable box or satellite box, using [CH. ▲ / ▼] select CH3 or CH4 according to the output channel setting of the device and select desired channel on that device.

TO WATCH EXTERNAL INPUT

When an external equipment is connected to the front AUDIO/VIDEO input jacks, press [SELECT] or [CH. ▲ / ▼] repeatedly until "VIDEO1" or "VIDEO2" appears on the screen.

NOTE

- If a disc is inside the unit, "DISC INSIDE" message is displayed on the screen for 10 seconds.

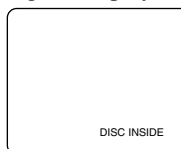

- To clear the message instantly, press [CLEAR].

CHANNEL SET UP

AUTO CHANNEL PROGRAMMING

As the initial setting, this unit has memorized all channels, including the ones not available in your area. This feature automatically puts only available channels into the memory.

- 1 Press **[SETUP]** then press **[▲]** or **[▼]** to point to "CHANNEL SET UP".

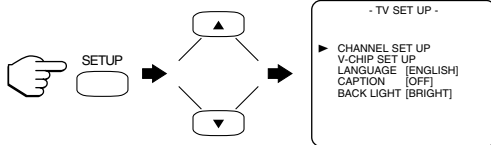

- 2 Press **[ENTER]** then press **[▲]** or **[▼]** to point to "AUTO PRESET CH".

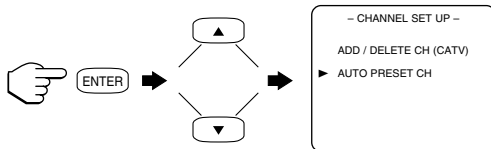

- 3 Press **[ENTER]**.



- The tuner scans and memorizes all the active channels in your area.
- The tuner stops on the lowest memorized channel.

NOTE

- When "AUTO PRESET CH" is activated where there is no TV signal input, "NO TV SIGNAL" will appear on the display after the completion of channel scanning.
- The unit may recognize CATV channels to be TV channels if reception condition is poor. In this case, check the antenna connection and try "AUTO PRESET CH" again when reception conditions are better.
- Channel memory programming is NOT necessary when connected to a cable box or satellite box. Just select the channel for cable box or satellite input (ex. CH3) on the unit, then select your desired channel on the cable box or satellite box.

ADDING/DELETING CHANNELS

The channels you no longer receive or seldom watch can be deleted from the memory. (Of course, you can add the deleted channel into the memory again.)

- 1 Press **[SETUP]** then press **[▲]** or **[▼]** to point to "CHANNEL SET UP".

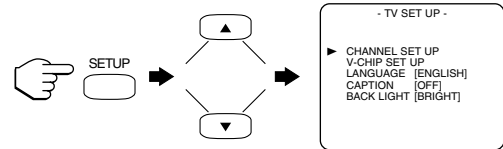

- 2 Press **[ENTER]** then press **[▲]** or **[▼]** to point to "ADD/DELETE CH".

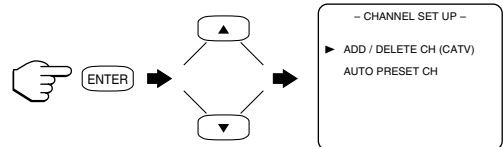

- 3 Press **[ENTER]** then press the **Number buttons** or **[CH. ▲ / ▼]** to select the desired channel number.

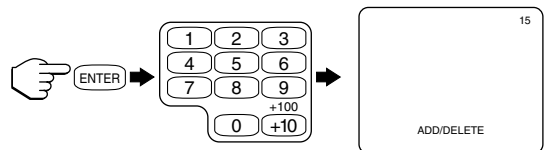

- 4 Press **[ENTER]** then the channel number turned to red. The channel is deleted from memory. If the channel number turned to blue, the channel is added into memory.



- To delete another channel, repeat steps 3 to 4.
- If you press **[ENTER]** again, the channel is memorized again.

Added channel : Light blue
Deleted channel : Light red

- 5 Press **[SETUP]** to exit the menu.



NOTE

- To confirm that channel(s) has been deleted or added, use **[CH. ▲ / ▼]**.

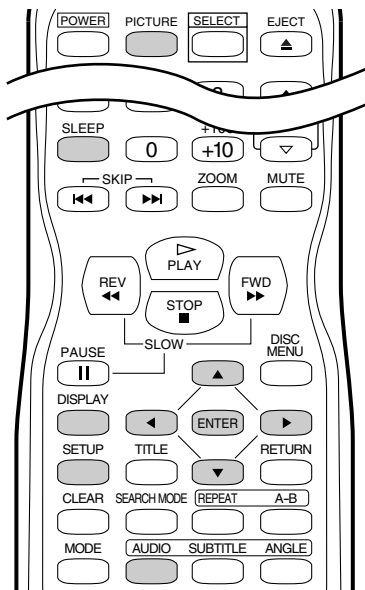

- Shaded buttons are used for following operation.

PICTURE CONTROL

The unit's picture controls, brightness, contrast, color, tint and sharpness, are preset to factory specifications. Although they are usually the best, you may need to make some further adjustments for a more natural looking image.

- 1 Press **[PICTURE]** then press **[▲]** or **[▼]** to select the desired control "BRIGHTNESS", "CONTRAST", "COLOR", "TINT" or "SHARPNESS".

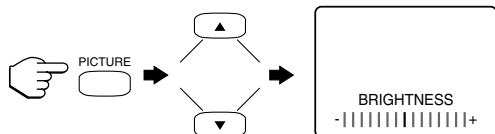

- 2 Press **[◀]** or **[▶]** to adjust to your desired level within 5 seconds.

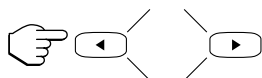

	[◀]	[▶]
BRIGHTNESS	to decrease brightness	to increase brightness
CONTRAST	to decrease contrast	to increase contrast
COLOR	to pale	to brilliant
TINT	to purple	to green
SHARPNESS	to soft	to clear

- Even if there is a power failure of any kind, the unit will retain its memory for this feature.

NOTE

- The picture control display will disappear automatically after 10 seconds unless you press any buttons.

BACK LIGHT SETTING

- 1 Press **[SETUP]** then press **[▲]** or **[▼]** to point to "BACK LIGHT".

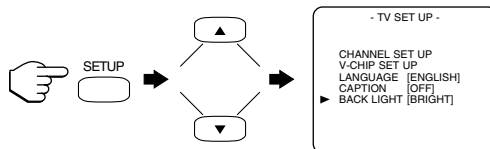

- 2 Press **[ENTER]** then press **[◀]** or **[▶]** to select to "BRIGHT", "NORMAL" or "DARK".

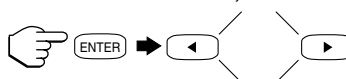

- 3 Press **[SETUP]**.

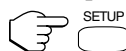

SLEEP TIMER

The Sleep Timer function turns off the unit without using **[POWER]** after a desired period of time.

- 1 Press **[SLEEP]**.

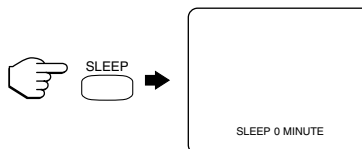

- 2 Press **[SLEEP]** repeatedly until the desired sleep time is displayed.

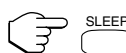

- Each press increases the time by 10 minutes up to 90 minutes.
- After 5 seconds, the Sleep Timer setting will disappear automatically.
- If you select "SLEEP 0 MINUTE", Sleep Timer setting is cancelled.

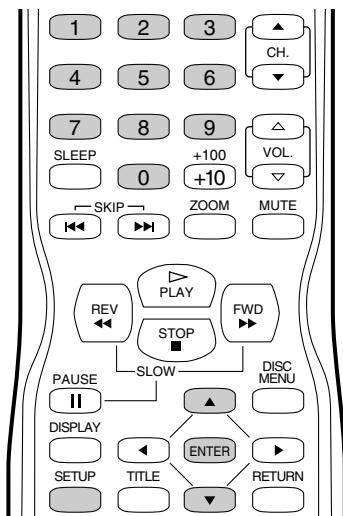

- Shaded buttons are used for following operation.

V-CHIP SET UP

V-CHIP SET UP

This feature enables parents to prevent their children from watching inappropriate material on TV. When you try to access a program which is blocked, “PROTECTED PROGRAM by ...” message appears on the TV screen.

- 1 Press **[SETUP]** then press **[▲]** or **[▼]** to point to “V-CHIP SET UP”.

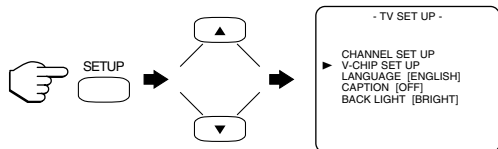

- 2 Press **[ENTER]** then press the Number Buttons to enter the access code.

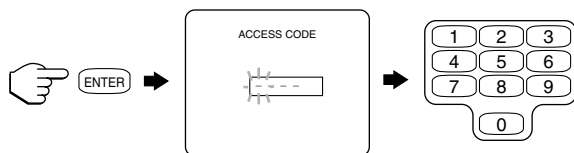

- For the first time set-up or in the event the unit has lost power, enter the default code of 0000.

- 3 Press **[▲]** or **[▼]** to select “TV RATING”, “MPAA RATING” or “CHANGE CODE” then press **[ENTER]**.

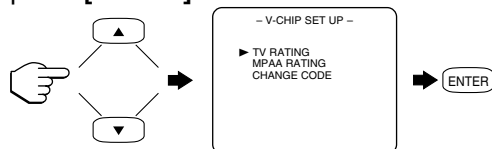

- TV RATING: See **A TV RATING SET UP**
 MPAA RATING: See **B MPAA RATING SET UP**
 CHANGE CODE: See **C CHANGE ACCESS CODE**

A TV RATING SET UP

Follow steps **1** to **3** in the *V-CHIP SET UP*.

- 4 Press **[▲]** or **[▼]** to select the desired TV rating to be blocked then press **[ENTER]** repeatedly to set “BLOCK” or “VIEW”.

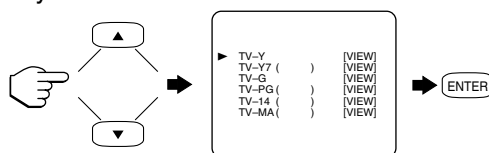

Selection	Rating Category Explanations
TV-Y	Appropriate for all children
TV-Y7	Appropriate for children seven and older
TV-G	General Audience
TV-PG	Parental Guidance suggested
TV-14	Unsuitable for children under 14
TV-MA	Mature audience only

NOTE

- When you select a rating and set it to “BLOCK”, the higher ratings will be blocked automatically. The lower ratings will be available for viewing.

TV-Y	()	[VIEW]
TV-Y7	()	[VIEW]
TV-G	()	[BLOCK]
TV-PG(DLSV)	()	[BLOCK]
TV-14 (DLSV)	()	[BLOCK]
TV-MA (LSV)	()	[BLOCK]

- When you set the lowest rating to “VIEW”, all other ratings will automatically be available for viewing.

- 5 When you select the ratings of TV-Y7, TV-PG, TV-14 or TV-MA you will have the option of setting sub rating categories.

Press **[▲]** or **[▼]** to select a rating with sub-ratings you wish to block, then press **[ENTER]** twice.

Press **[▲]** or **[▼]** to select a sub-rating, then press **[ENTER]** to set it to “BLOCK” or “VIEW”.

Selection	Rating Category Explanations
TV-Y7	
FV	Fantasy Violence
TV-PG, TV-14, TV-MA	
D	Suggestive Dialog (TV-PG, TV-14 only)
L	Coarse Language
S	Sexual Situation
V	Violence

NOTE

- The blocked sub-ratings will appear next to the rating category in the “TV RATING” menu.

6 Press **[SETUP]** to exit the menu.

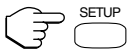

NOTE

- To change the rating, the TV must be turned to an unprotected program. If “PROTECTED PROGRAM by ...” appears on the screen, please change the channel to a station that is not protected.

B MPAA RATING SET UP

Follow steps **1** to **3** in the *V-CHIP SET UP* on page 16.

4 Press **[▲]** or **[▼]** to point to your desired item, then press **[ENTER]** to select “BLOCK” or “VIEW”.

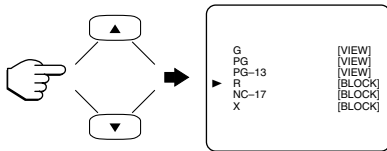

Selection	Rating Category Explanations
G	General Audience
PG	Parental Guidance suggested.
PG-13	Unsuitable for children under 13
R	Restricted; under 17 requires accompanying parent or adult guardian
NC-17	No one under 17 admitted
X	Mature audience only

- When you select a rating and set it to “BLOCK”, the higher ratings will be blocked automatically. The lower ratings will be available for viewing.
- When you set the lowest rating to “VIEW”, all other ratings will automatically be available for viewing.

5 Press **[SETUP]** to exit the menu.

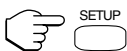

C CHANGE ACCESS CODE

Follow steps **1** to **3** in the *V-CHIP SET UP* on page 16.

4 Press the number buttons to enter your desired access code in the “NEW CODE” space, then enter the same code in the “CONFIRM CODE” space. When completed, the menu will return to “V-CHIP SET UP”.

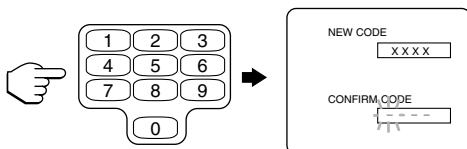

- Make sure you enter exactly the same new code in the “CONFIRM CODE” space as one in the “NEW CODE” space. If they are different, the “NEW CODE” space is cleared for redoing.

5 Press **[SETUP]** to exit the menu.

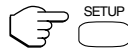

NOTE

- Your personal access code will be erased and will return to the default (0000) when a power failure occurs or when you turn off the power using a wall switch. If you have forgotten the code, unplug the power cord for 10 seconds to restore the access code to 0000.

MENU LANGUAGE

1 Press **[SETUP]** then press **[▲]** or **[▼]** to point to “LANGUAGE”.

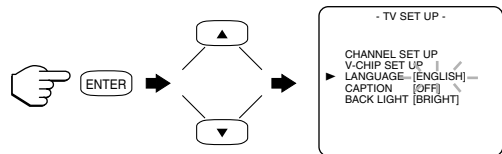

2 Press **[ENTER]** repeatedly to select “ENGLISH”, “ESPAÑOL”= Spanish or “FRANÇAIS”= French.



3 Press **[SETUP]** to exit the menu.

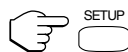









NOTE

- This function effects only the language on the screen menu and not the audio source.
- If for some reason the menu is in Spanish or French, press **[SETUP]**, press **[▲]** or **[▼]** to point to “IDIOMA [ESPAÑOL]” or “LANGAGE [FRANÇAIS]”, then press **[ENTER]** repeatedly to select desired language, then press **[SETUP]**.

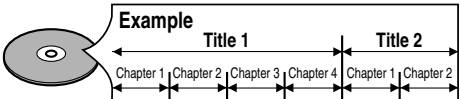
DVD SECTION

ABOUT THE DISCS

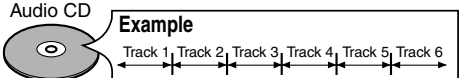
PLAYABLE DISCS

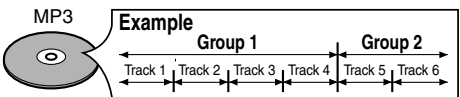
Playable discs	Mark (logo)	Region code	Recorded signals	Disc size	Disc type
DVD-Video * 1,2,4,6,10,11			Digital video (MPEG2)	5 inches (12cm)	
DVD-RW DVD-R * 1,3,4,5, 6,7,9,10		-			
DVD+RW DVD+R * 1,3,4,5, 6,8,9,10		-			
Audio CD * 4,6,10		-	Digital audio	5 inches (12cm)	
CD-RW CD-R * 4,5,6,9,10		-	Digital audio or MP3		

 is a trademark of DVD Format/Logo Licensing Corporation.

If you cannot play back a disc which bears one of the marks above, check the following notes.

- *1: This unit conforms to the NTSC color system. Discs recorded in other color systems such as PAL cannot be played back.
- *2: Certain DVD-Video discs do not operate as described in this manual due to the intentions of the disc's producers.
- *3: Discs recorded in the VR (Video Recording) format cannot be played back.
- *4: Scratched or stained discs may not be played back.
- *5: Some discs cannot be played back because of incompatible recording conditions, characteristics of the recorder or special properties of discs.
- *6: You can play back discs which bear the marks above. If you use nonstandardized discs, this unit may not play them back. Even if they are played back, the sound or video quality will be compromised.
- *7: You may play back the unfinalized DVD-R/RW disc recorded in the video format on our brand's DVD recorder. However, depending on the recording status of a disc, the disc may not be played back at all or normally (the picture or sound may not be smooth, etc.). In this case, you need to finalize the disc with the DVD recorder. Refer to the manual accompanying the DVD recorder.
- *8: Only the discs recorded in the video format and finalized can be played back. Unfinalized discs cannot be played back. Depending on the recording status of a disc, the disc may not be played back at all or normally (the picture or sound may not be smooth, etc.).
- *9: If there is too much recording space left on a disc (the used portion is less than $2\frac{3}{16}$ " (55mm) across), it may not play back properly.
- *10: Do not glue paper or put stickers on to the disc. These may damage the disc and the unit may not read it correctly.
- *11: The number inside the symbol refers to a region of the world and a disc encoded in a specific region format can only be played back on unit with the same region code.

UNPLAYABLE DISCS

- **NEVER play back the following discs. Otherwise, the unit may result in malfunction.**
DVD-RAM / CD-I / Photo CD / Video CD / DVD with region codes other than 1 or ALL / DTS-CD / DVD-ROM for personal computers / CD-ROM for personal computers
- **Never insert a disc which is broken or whose form is abnormal (other than 5 inch (12cm) round disc).**
- **On the following disc, the sound MAY NOT be heard.**
Super Audio CD

NOTE

Only the sound recorded on the normal CD layer can be delivered.
The sound recorded on the high density Super Audio CD layer cannot be delivered.

- *Any other discs without compatibility indications*

PLAYING A DISC

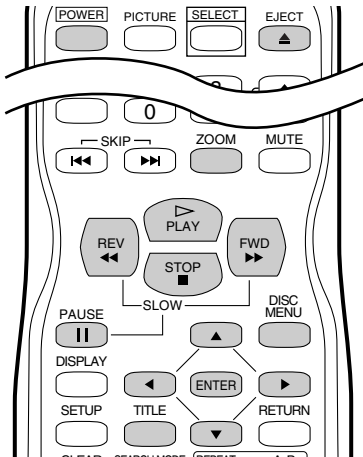

- Shaded buttons are used for following operation.

BASIC PLAYBACK

GETTING STARTED



Turn on the power of amplifier and any other components, if necessary.

- 1 Press **[POWER]** then the power will turn on.



- 2 Open the disc door manually.

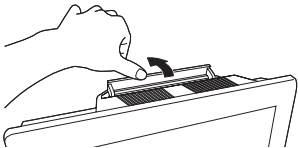

- 3 Insert a disc with the label facing back of the unit to start playing it. By simply placing the disc gently into the slot, it will be loaded automatically.

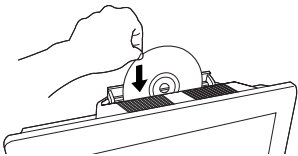

- Playback will start from the first chapter/track of the disc.
- If the playback does not start automatically, press **[PLAY ▷]**.
- When you playback a DVD which features a title menu, it may appear on the screen. In this case, refer to "TITLE MENU" on page 20.

- 4 Press **[STOP ■]** to stop playback.

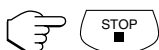

- 5 Press **[EJECT ▲]** to remove the disc from the unit.

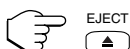

NOTE

- When the DVD mode has been switched to the TV mode, the DVD mode shuts down first and then the TV picture and sound appears in about 4 seconds. Similarly, when **[POWER]** is pressed to turn off in the DVD mode, this mode shuts down first and then the unit is turned off.
- "⊘" may appear at the top-right on the TV screen during operation, warning that a prohibited operation has been encountered by the DVD or the disc.
- With DVDs that use titles for playback program signals, playback may start from the second title or it may skip these titles.
- During the playback of a two layered disc, pictures may stop for a moment. This happens when the 1st layer switches to the 2nd layer. This is not a malfunction.

MP3 PLAYBACK



- 1 In stop mode, press **[DISC MENU]**, then press **[▲]** or **[▼]** to select the desired group or track.

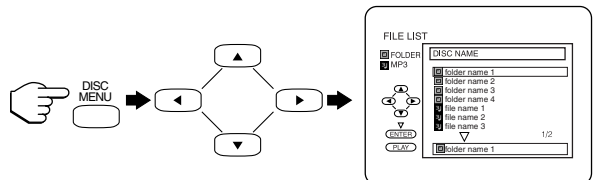

- If a group is selected, press **[▶]** or **[ENTER]** to go on to the track selection screen. Press **[◀]** to go back to previous screen.(except for the top page.)
- If a track is selected, press **[ENTER]** to start playing tracks. Starting from the one you've just chosen the subsequent tracks will be played.
- If the entire file list cannot be displayed at once on a screen, "▽" appears to go to the next page.
- Press **[TITLE]** to return to the top file of the highest hierarchy in the program and file list.

- 2 Press **[STOP ■]** to stop playback.



NOTE

- Folders are known as Groups; files are known as Tracks.
 - MP3 files are accompanied by icon.
 - Maximum of 255 folders can be recognized.
 - Maximum of 999 files can be recognized.
 - Up to 8 hierarchies can be created.
- This unit recommends the use of files recorded at the below specifications:
- Sampling frequency: 44.1kHz or 48kHz
 - Constant bit rate: 32kbps ~ 320kbps
 - For MP3 file recorded in Variable Bit Rate (VBR), the unit may not display the actual elapsed time.

DISC MENU



1 Press [DISC MENU].



- The DVD main menu will appear.
- If the feature is not available, symbol may appear on the TV screen.
- If disc menu is available on the disc, audio language, subtitle options, chapters for the title and other options will appear for selection.

2 Use [▲], [▼], [◀] or [▶] to select an item and press [ENTER] to confirm selection.

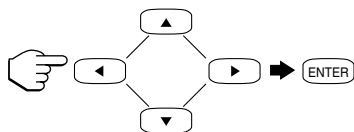

TITLE MENU



1 Press [TITLE].



- The title menu will appear.
- If the feature is not available, symbol may appear on the TV screen.

2 Use [▲], [▼], [◀] or [▶] to select an item then press [ENTER] to confirm selection.

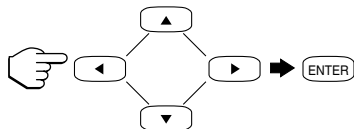

CALLING UP A MENU SCREEN DURING PLAYBACK

Press [DISC MENU] to call up the DVD menu or press [TITLE] to call up the title menu.

NOTE

- Contents of menu and corresponding menu operations may vary between discs. Refer to the manual accompanying the disc for details.

RESUME



1 During playback, press [STOP ■].

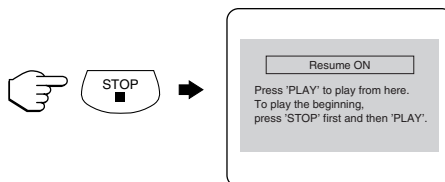

(Example: DVD or Audio CD)

- Resume message will appear on the TV screen.

2 Press [PLAY ▶], playback will resume from the point at which playback was stopped.

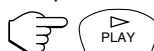

- To cancel resume, press [STOP ■] twice.
- For MP3, playback will resume from the beginning of the current track.
- The resume information stays on even when the power is turned off.

PAUSE



1 During playback, press [PAUSE II].



- Playback will pause and sound will be muted.

2 To continue playback, press [PLAY ▶].



STEP BY STEP PLAYBACK



1 During playback, press [PAUSE II].



- Playback will pause and sound will be muted.

2 The disc goes forward by one frame each time [PAUSE II] is pressed.

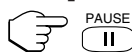

3 To exit step by step playback, press [PLAY ▶].



FAST FORWARD / FAST REVERSE



- 1 During playback, press **[FWD ►►]** or **[REV ◄◄]**.

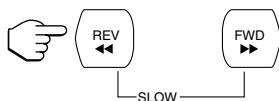

- “►► 1” or “◄◄ 1” appears on the screen.

- 2 To select another speed, repeat step 1 until your required speed number appears on the screen.

- For DVDs, fast forward/reverse search speed is different depending on the disc. Approximate speed is 1 (x2), 2 (x8), 3 (x20), 4 (x50) and 5 (x100).
- For Audio CDs and MP3 approximate speed is 1 (x2), 2 (x8) and 3 (x30).

- 3 To return to normal playback, press **[PLAY ►]**.



SLOW FORWARD / SLOW REVERSE



- 1 During playback, press **[PAUSE II]**.

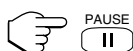

- 2 Press **[FWD ►►]** or **[REV ◄◄]**.

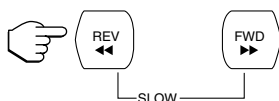

- “►► 1” or “◄◄ 1” appears on the screen.

- 3 To select another speed, repeat step 2 until your required speed number appears on the screen.

- Slow forward or reverse speed varies with the disc. Approximate speed is 1 (1/16), 2 (1/8) and 3 (1/2).

- 4 To return to normal playback, press **[PLAY ►]**.

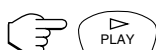

ZOOM



The Zoom function allows you to enlarge the video image and to pan through the enlarged image.

- 1 Press **[ZOOM]** during playback.



- Playback will continue.

- 2 Press **[ZOOM]** repeatedly to select the required zoom factor: ZOOM1, ZOOM2, ZOOM3 or OFF.



- 3 Press **[▲]**, **[▼]**, **[◄]** or **[►]** to move the zoomed picture across the screen.

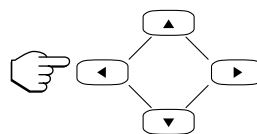

- 4 To exit zoom mode, press **[ZOOM]** to OFF.



NOTE

- Zooming function does not work while disc menu is shown.
- Zooming function is not available on some discs.
- It may take several seconds to slide the zoomed picture.
- The picture may be distorted if you operate other functions repeatedly (ex. **[PAUSE II]** or **[REV ◄◄]**, etc.) in the zoom mode.

SEARCH FUNCTION

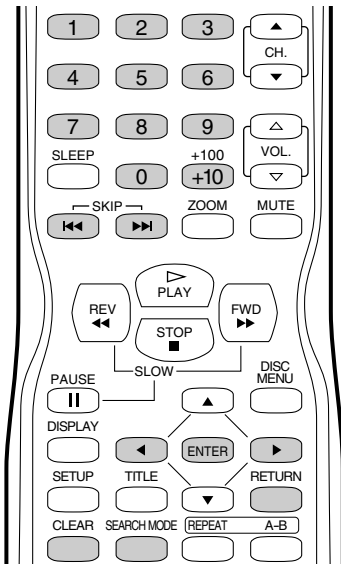

- Shaded buttons are used for following operation.

TRACK SEARCH



There are three ways to begin playback on an Audio CD and MP3 at a specific track.

Using the number buttons

- 1 Press the **Number buttons** to enter the desired track number.

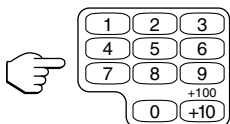

- Playback will start at the selected track.
- To select single-digit track number, press single number. (e.g. Press **[3]** for track number 3.)
- To select track numbers which are higher than 9, press **[+100/+10]** first. (e.g. Press **[+100/+10] [2] [5]** for track number 25.)

Using [SEARCH MODE]

- 1 Press **[SEARCH MODE]**.

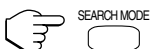

- The track search display appears.

- 2 Within 30 seconds, select the desired track number using the **Number buttons**.

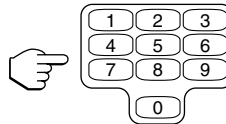

- To select single-digit track number, press **[0]** first if the total number of track in the disc is 10 or more. (e.g. Press **[0] [3]** for track number 3.)
- Playback will start at the selected track.

Using [SKIP <<< / >>>]

During playback, press **[SKIP >>>]** to move the next track. Press it repeatedly to skip subsequent tracks. Press **[SKIP <<<]** to go back to beginning of the current track. Press it repeatedly to go to the previous tracks.

- If **[SKIP <<< / >>>]** is pressed while the playback is paused, the playback will be paused again after skipping to the next track.

NOTE

- **[SKIP <<< / >>>]** are not operative when playback is stopped.

TITLE / CHAPTER SEARCH



- 1 Press **[SEARCH MODE]** once for the Chapter search, twice for the Title search during playback.

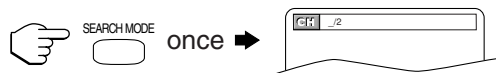

- 2 Within 30 seconds, enter the desired chapter/ title number using the **Number buttons**.

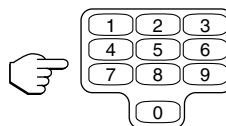

- Playback will start at the selected chapter or title.
- Press **[CLEAR]** to erase the incorrect input.
- To select single-digit chapter/title number, press **[0]** first if the total number of chapter/title in the disc 10 or more. (e.g. Press **[0] [2]** for chapter/title 2.)

TIME SEARCH



- 1 During playback, press **[SEARCH MODE]** repeatedly to display the Time Search on the TV screen.



- 2 Within 30 seconds, enter a desired disc time using the **Number buttons**.

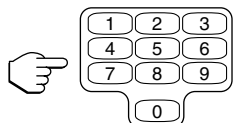

- Playback will start at the specified time.
- Press **[CLEAR]** to erase the incorrect input.
- When there is no need to enter a number, “0” appears automatically. For example, “0 : 0 - : - : -” appears in the Time Search display if the total time of the track or title is less than 10 minutes.

MARKER SETUP SCREEN



Use markers to memorize your favorite places on a disc.

- 1 Press **[SEARCH MODE]** repeatedly during playback to display the Marker screen.



- 2 Press **[◀]** or **[▶]** to select 1, 2, 3, 4, 5, 6, 7, 8, 9, or 10 and ensure that “- - - - -” appears in the display.

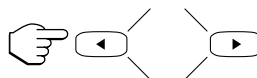

- 3 When you reach the desired point, press **[ENTER]**.



- The Title or Track and elapsed playing time will appear in the TV screen.

- 4 To return to the Marker later, press **[SEARCH MODE]** repeatedly during playback to display the Marker screen. Then press **[◀]** or **[▶]** to choose the desired marker, then press **[ENTER]**.



NOTE

- Operations which erase all Markers:
 - Turning off the power.
 - Ejecting a disc from the unit.
 - Pressing **[SELECT]**.
 - Selecting “AC” at step 2 and pressing **[ENTER]**.
- To clear a marker:
 - Press **[◀]** or **[▶]** to select a cursor on to the marker number and press **[CLEAR]**.
- You can mark up to 10 points.

- 5 Press **[SEARCH MODE]** or **[RETURN]** to exit.

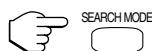

SPECIAL PLAYBACK FUNCTION

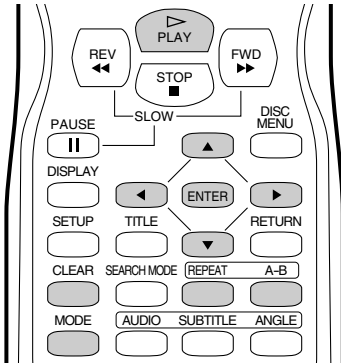

- Shaded buttons are used for following operation.

REPEAT

REPEAT is available only during playback.

For DVD-Vs



- 1 To activate the repeat function, press **[REPEAT]** during playback.

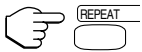

- The repeat mode changes as described below every time you press the button.



NOTE

- Repeat Title/Chapter is not available with some scenes.
- Repeat setting will be cleared when moving to other title or chapter.

For Audio CDs



- 1 To activate the repeat function, press **[REPEAT]** during playback.

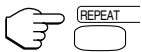

- The repeat mode changes as described below every time you press the button.



NOTE

- Repeat Track setting will be cleared when moving to other track.
- Repeat playback does not function during A-B repeat playback.

For MP3



- 1 Press **[REPEAT]** during playback.

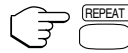

- The repeat mode changes as described below every time you press the button.

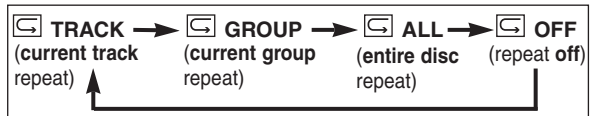

NOTE

- Repeat Track/Group setting will be cleared when moving to other track or group.

A-B REPEAT



- 1 Press **[A-B]** at your chosen starting point.



- “A-” appears briefly on the TV screen.

- 2 Press **[A-B]** again at your chosen end point.



- “A-B” appears briefly on the TV screen, and the repeat sequence begins.

- 3 To exit the sequence, press **[A-B]**.

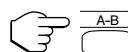

NOTE

- The A-B repeat section can only be set within the current title (for DVDs) or current track (for Audio CDs).
- A-B repeat is not available with some scenes in DVD.
- To cancel the A point which was set, press **[CLEAR]**.
- A-B repeat playback does not function during title, chapter, track or all repeat playback.

PROGRAM



You may determine the order in which tracks will play.

1 In stop mode, press **[MODE]**.

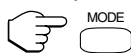

- The “PROGRAM” screen will appear.

2 Press **[▲]** or **[▼]** to select a track, then press **[ENTER]**.

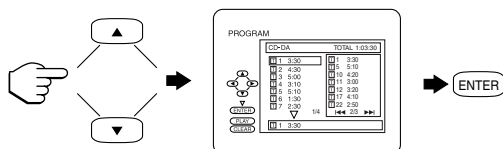

- Press **[CLEAR]** to erase the most recently entered track.
- If the entire Program cannot be displayed at once on a screen, “▶▶” appears to go to the next page and “◀◀” appears to go back to the previous page.

While an MP3 folder is open:

- Press **[▶]** when you want to go to the next hierarchy.
- Press **[◀]** when you want to go back to the previous hierarchy.

3 Repeat step 2 until you have selected all the tracks you want to play in the program.

4 Press **[PLAY ▶]** to play the programmed tracks.



NOTE

- While the program is being played back, pressing **[STOP ■]** works as follows.
- Press **[STOP ■]** once and then **[PLAY ▶]** again, playback will restart from the point where **[STOP ■]** was pressed (MP3: from the beginning of the current track). (Program continued)
- Press **[STOP ■]** twice and then **[PLAY ▶]** again, playback will restart from the track in the usual way. (Program canceled)
- Up to 99 tracks can be entered.
- To erase all tracks in the program at once, select “ALL CLEAR” at the bottom of the list at step 2.
- If you like to repeat the current track in the program, press **[REPEAT]** several times until “**[☐] TRACK**” appears during playback. If you like to repeat the entire program press **[REPEAT]** several times until “**[☐] ALL**” appears during playback.

RANDOM PLAYBACK



This function shuffles the playing order of tracks instead of playback in the sequence.

1 In stop mode, press **[MODE]** twice.

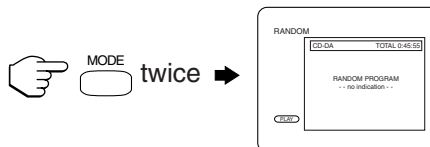

- “RANDOM” screen appears.

2 Press **[PLAY ▶]** to start random playback.



NOTE

- If you like to repeat the current track in the random selection, press **[REPEAT]** several times until “**[☐] TRACK**” appears during playback. If you like to repeat the entire random selection press **[REPEAT]** several times until “**[☐] ALL**” appears during playback.

CHANGING THE SETTINGS

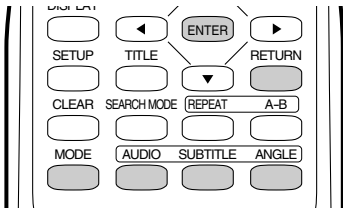

- Shaded buttons are used for following operation.

SUBTITLE LANGUAGE



The unit allows you to select a language for subtitles during DVD disc (if available) playback.

- 1 Press **[SUBTITLE]** during playback.

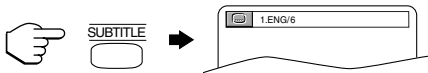

- The subtitle language will appear on the display bar at the top of the TV screen.

- 2 Press **[SUBTITLE]** repeatedly to select your desired subtitle language.

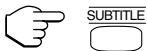

- 3 To turn off subtitles, press **[SUBTITLE]** repeatedly until "OFF" appears.

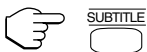

NOTE

- Pressing **[SUBTITLE]** may not work on some DVDs with multiple subtitle languages. In this case, set it on the disc menu. (Operation varies between discs Refer to the manual of the disc.)
- If the desired language is not shown after pressing **[SUBTITLE]** several times, the disc does not have subtitles in that language.
- When "NOT AVAILABLE" appears on the TV screen, it means no subtitle is recorded on the scene.



- If you choose a language that has a 3 letter language code, the code will be displayed every time you change the Subtitle language setting. If you choose any other languages, "---" will be displayed instead. (Refer to page 29.)

AUDIO LANGUAGE



The unit allows you to select a language during DVD disc (if multi languages are available) playback.

- 1 Press **[AUDIO]** during playback.



- 2 Press **[AUDIO]** repeatedly to select your desired language.



NOTE

- Pressing **[AUDIO]** may not work on some DVDs with multiple audio languages (e.g. DVDs which allow audio language setting on the disc menu).

STEREO SOUND MODE



- 1 Press **[AUDIO]** repeatedly during playback to select between "STEREO", "L-ch" or "R-ch".

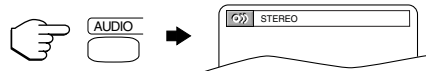

- STEREO - both right and left channels are active (stereo)
L-ch - only left channel is active
R-ch - only right channel is active

CAMERA ANGLE



Some DVD discs contain scenes which have been shot simultaneously from various angles. You can change the camera angle when the “” icon appears on the screen.

1 Press [ANGLE] during playback.

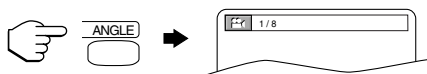

- The selected angle will be displayed on the display bar at the top of the screen.
- If the “ANGLE ICON” setting is “OFF” in the “OTHERS” menu, the “” icon will not appear. (Refer to page 31.)

2 Press [ANGLE] repeatedly to select your desired angle.

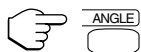

BLACK LEVEL SETTING



Adjust the Black Level Settings to make the black parts of the picture brighter.

1 Press [MODE] during playback then press [ENTER] to switch “ON” or “OFF”.

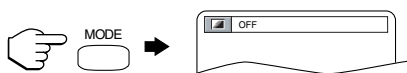

- ON: Makes the dark parts brighter.
- OFF: Shows the original picture as recorded. (Initial setting)

2 Press [MODE] twice or [RETURN] to exit.

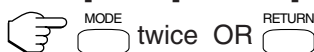

NOTE

- The setting will be saved even if the unit is turned off.

VIRTUAL SURROUND



You can enjoy surround-sound effect over two speakers on this unit.

1 Press [MODE] repeatedly during playback then press [ENTER] to set it “1”, “2” or “OFF”.



- 1: Natural effect
- 2: Emphasized effect
- OFF: Original Sound

2 Press [MODE] to exit.

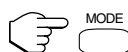

- You can also exit the menu by pressing [RETURN].

NOTE

For CD play only:

- Virtual Surround will not be effective if the sound mode is set to something other than STEREO. (Refer to “STEREO SOUND MODE” on page 26.)

THE ON-SCREEN INFORMATION

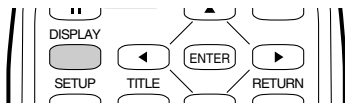

- Shaded buttons are used for following operation.

You can check the information about the current disc by pressing **[DISPLAY]**.

For DVD-Vs



- 1 Press **[DISPLAY]** during playback to show current Chapter.

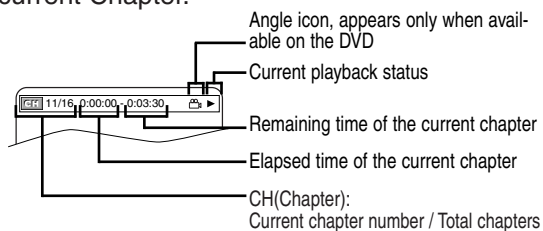

- 2 Press **[DISPLAY]** again to show current Title.

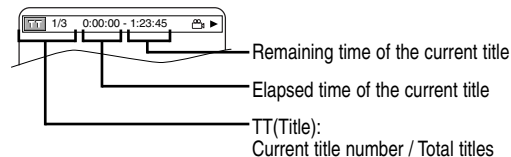

- 3 Press **[DISPLAY]** again.

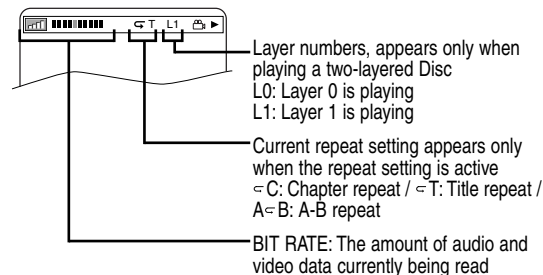

- 4 Press **[DISPLAY]** again to exit.

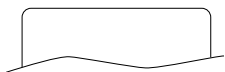

For Audio CDs



- 1 Press **[DISPLAY]** during playback to show the current Track.

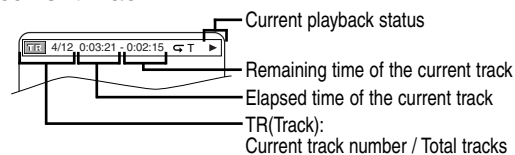

- 2 Press **[DISPLAY]** again to show current Total Track.

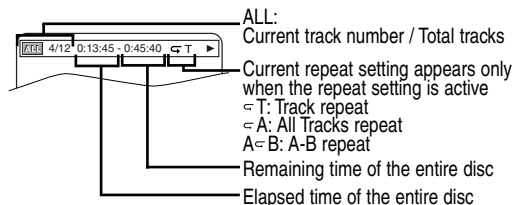

- 3 Press **[DISPLAY]** again to exit.



NOTE

- When you are playing a disc in PROGRAM or RANDOM mode, "PROGRAM" (or RANDOM) will be displayed at step 2.

For MP3



- 1 Press **[DISPLAY]** during playback.

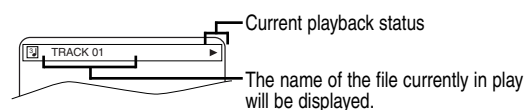

- 2 Press **[DISPLAY]** again.

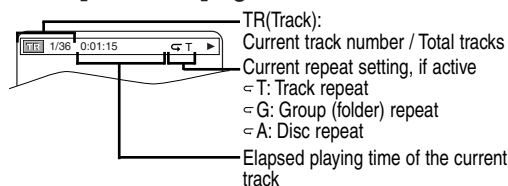

- 3 Press **[DISPLAY]** again to show the current-playback mode.

(Only when you are playing a disc in PROGRAM or RANDOM mode.)

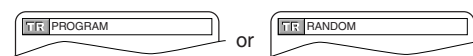

- 4 Press **[DISPLAY]** again to exit.



CHANGING THE DVD SET UP ITEMS

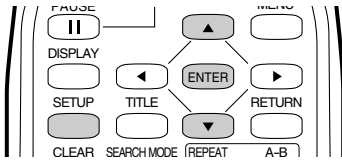

- Shaded buttons are used for following operation.

CUSTOM MENU

You can change the DVD player's settings.

- 1 In stop mode, press **[SETUP]** twice, **[▼]** to select "CUSTOM" then press **[ENTER]**.

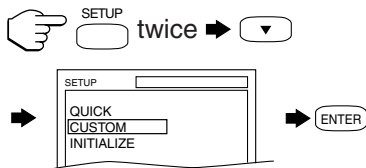

NOTE

- If the menu does not appear, press **[PLAY ▷]** first, then press **[STOP ■]**. Make sure the disc is in stop mode, then slowly press **[SETUP]** twice.

- 2 Press **[▲]** or **[▼]** to select the desired item then press **[ENTER]** to confirm.

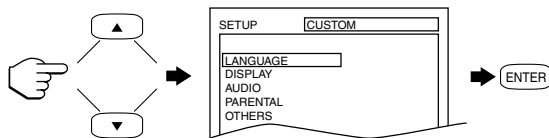

Refer to the pages below to set up each item.

- LANGUAGE: See **D LANGUAGE SETTING**
- DISPLAY: See **E DISPLAY SETTING**
- AUDIO: See **F AUDIO SETTINGS**
- PARENTAL: See **G PARENTAL CONTROL**
- OTHERS: See **H OTHER SETTINGS**

D LANGUAGE SETTING

Follow steps 1 to 2 in the **CUSTOM MENU**.

- 3 Press **[▲]** or **[▼]** to select the desired item then press **[ENTER]**.

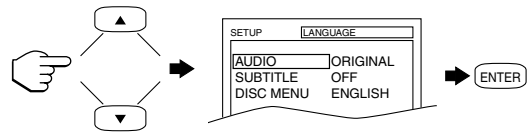

- AUDIO: Sets the audio language.
- SUBTITLE: Sets the subtitle language
- DISC MENU: Sets the language for DVD menu.

- 4 Press **[▲]** or **[▼]** to select a setting then press **[ENTER]**.

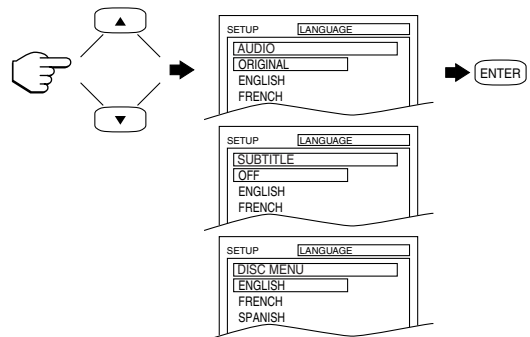

- If "OTHER" is selected on the "AUDIO", "SUBTITLE" or "DISC MENU" screen, press four-digit number to enter the code for the desired language.
- Only the languages supported by the disc can be selected.

- 5 Press **[SETUP]** to exit the menu.

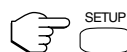

NOTE

- Language Setting for Audio and Subtitle are not valid for some discs due to default setting of the disc. In this case, set them by pressing **[AUDIO]** and **[SUBTITLE]**. (Refer to page 26.)
- If you select a language that is not supported by the disc, subtitle will automatically be set OFF and the first item of the audio languages will be automatically set.

E DISPLAY SETTING

Follow steps **1** to **2** in the **CUSTOM MENU** on page 29.

3 Press **[▲]** or **[▼]** to select the below items then press **[ENTER]**.

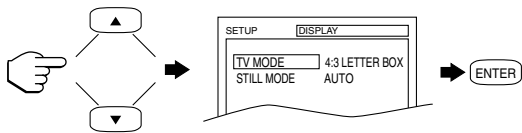

TV MODE: **QUICK**

You can change certain aspects of the DVD display screens and on-screen messages on the TV screen.

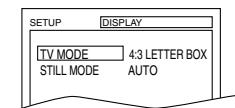

- **4:3 LETTER BOX** (default): To show black bars on top and bottom of the screen.
- **4:3 PAN & SCAN**: To show a full height picture with both sides trimmed.

STILL MODE:

This function allows you to adjust picture resolution and quality in the still mode.

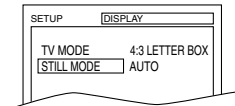

- **AUTO** (default): Automatically select the best resolution setting (FRAME or FIELD) based on the data characteristics of the pictures.
- **FIELD**: Select "FIELD" when the pictures are still unstable even if "AUTO" is selected. FIELD stabilizes the pictures, although the picture quality may become coarse due to the limited amount of data.
- **FRAME**: Select "FRAME" to display relatively motionless pictures in higher resolution. FRAME improves the picture quality, although it may unstabilize the pictures due to simultaneous output of two field data.

4 Press **[SETUP]** to exit the menu.

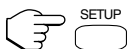

QUICK MENU

- You can select the "TV MODE" or "DOLBY DIGITAL" from the QUICK menu quickly. To access the QUICK menu, select "QUICK" instead of "CUSTOM" at step **1** on page 29.

TV SET UP MENU IN DVD MODE

- You can access the TV SETUP menu by pressing **[SETUP]** from the DVD mode, and select only "LANGUAGE" and "BACK LIGHT".

F AUDIO SETTING

Choose the appropriate Audio settings for your equipment as it only affects during the playback of DVD discs.

Follow steps **1** to **2** in the **CUSTOM MENU** on page 29.

3 Press **[▲]** or **[▼]** to select the below items then press **[ENTER]**.

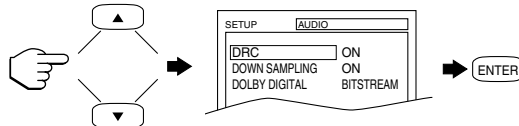

DRC (Dynamic Range Control):

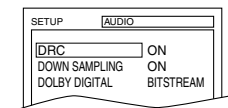

- To compress the range of soft to loud sound.
- The default setting is "ON".

DOWN SAMPLING:

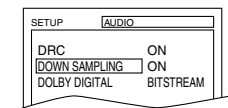

- **ON** : Output in 48 kHz. (default)
- **OFF** : Output the original sound.

When playing disc with copyright Protection

- If you select "OFF", copyright protection will be activated and sound will be down sampled at 48kHz.

DOLBY DIGITAL: **QUICK**

Set to "BITSTREAM" when the unit is connected to a Dolby Digital Decoder.

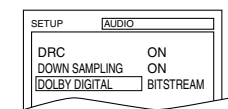

- **BITSTREAM**: Output a Dolby Digital signal (default)
- **PCM**: Convert the Dolby Digital to PCM (2 channel stereo)

4 Press **[SETUP]** to exit the menu.

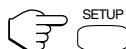

G PARENTAL CONTROL

Parental Control limits the disc viewing that exceed your setting (with a password or playback will stop). This feature allows you to prevent discs with alternative scenes from being played by your children.

PARENTAL LEVEL

Parental Level allows you to set the rating level of your DVD discs. Playback will stop if the disc's ratings exceed the level you set.

Follow steps 1 to 2 in the **CUSTOM MENU** on page 29.

3 Enter your four-digit password then press [ENTER].

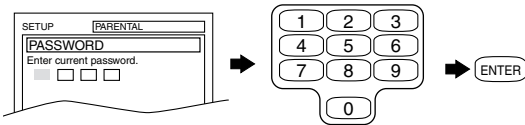

- Press [4], [7], [3], [7] then enter your password if you forget the password.

4 Press [▲] or [▼] to select "PARENTAL LEVEL" then press [ENTER].

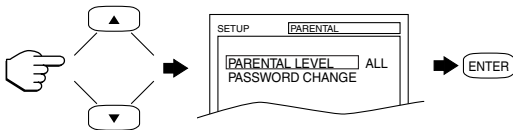

5 Press [▲] or [▼] to select the desired level then press [ENTER].

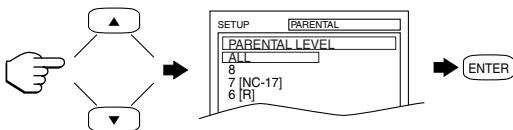

6 Press [SETUP] to exit the menu.

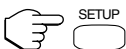

NOTE

- When doing this for the first time, enter any 4 digits. (except for 4737) That number will be used as the password. (in the event you forget the password, see below)
- To change the password, press [▲] or [▼] to select "PASSWORD CHANGE" at step 4 then press [ENTER]. Enter the four-digit password, then press [ENTER].
- With some DVDs, it may be difficult to find if they are compatible with parental lock. Be sure to check if the parental lock function operates in the way that you have set.
- Record the password in case you forget it.

CONTROL LEVELS

- **ALL**
All parental lock is cancelled.
- **Level 8**
DVD software of any grade (adult/general/children) can be played back.
- **Levels 7 to 2**
Only DVD software intended for general use and children can be played back.
- **Level 1**
Only DVD software intended for children can be played back, with those intended for adult and general use prohibited.

H OTHER SETTINGS

Follow steps 1 to 2 in the **CUSTOM MENU** on page 29.

3 Press [▲] or [▼] to select the below items then press [ENTER].

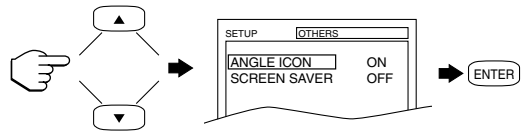

ANGLE ICON:

- Press [ENTER] repeatedly to turn Angle icon "ON" or "OFF".
- The default setting is "ON".

SCREEN SAVER:

- Press [ENTER] repeatedly to turn Screen Saver "ON" or "OFF".
- The default setting is "OFF". If you select "ON", the screen saver program starts when there is no input from the unit for 5 minutes in stop mode.

4 Press [SETUP] to exit the menu.

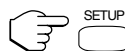

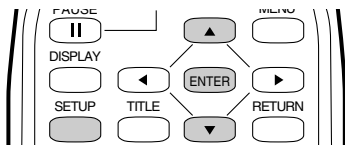

- Shaded buttons are used for following operation.

INITIALIZE

This allows you to return all selections of SETUP (except for “PARENTAL” and **menu language**) to their default settings.

- 1 Press **[SETUP]** twice in stop mode so that the “INITIALIZE” menu appears.

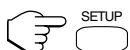

- 2 Press **[▲]** or **[▼]** to select “INITIALIZE” then press **[ENTER]**.

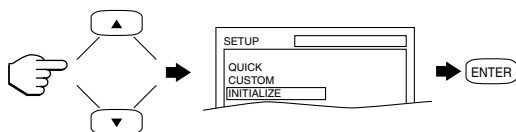

- 3 Press **[▲]** or **[▼]** to select “YES” then press **[ENTER]** twice.

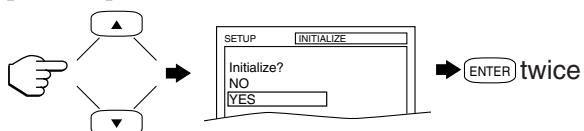

All the settings (except for “PARENTAL” and **menu language**) will be cleared.

- To cancel the initialization, select “NO”.

- 4 Press **[SETUP]** to exit the menu.

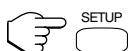

TROUBLESHOOTING GUIDE

If the unit does not perform properly when operated as instructed in this Owner's Manual, check the unit, consulting the following checklist.

PROBLEM	CORRECTIVE ACTION
No power	<ul style="list-style-type: none"> • Make sure the power plug is connected to an AC outlet. • Make sure the power is turned on.
The unit does not respond to the remote control	<ul style="list-style-type: none"> • Aim the remote control directly at the sensor on the front of the unit. • Reduce the distance to the unit. You have to be within 23 feet. • Replace the batteries in the remote control. • Re-insert the batteries with their polarities (+/- signs) as indicated. • Tune your radio to an empty AM station so that you hear a lot of noises. Then, turn the volume up. If you hear some signal sound from the radio when pressing buttons on the remote control, the remote control is working. • Check if the correct mode is selected. If not switch the mode by pressing [SELECT], whichever you need.

TV Mode

Sometimes a performance problem can be easily solved by checking seemingly apparent but often overlooked possibilities. Before arranging for service, check these items. It could save your time and money.

PROBLEM	CORRECTIVE ACTION
No picture or sound	<ul style="list-style-type: none"> • Make sure the AC cord is connected to an AC outlet. • Check antenna connection. • Press [SELECT] to select TV mode. Then try other TV feature. • Let the unit program its tuner memory.
No picture or poor picture on the unit	<ul style="list-style-type: none"> • Adjust direction or replace antenna. • Adjust picture controls. • Check for broken pin of the antenna cable.
No sound or poor sound	<ul style="list-style-type: none"> • Adjust volume control on remote control or main unit. • Press [MUTE] to restore sound.
Bars On Screen	<ul style="list-style-type: none"> • If outside antenna is being used, check for broken wire. • Check for local interference.
Picture Distorted or Blurred	<ul style="list-style-type: none"> • Try a new channel, if OK, then possible station trouble. • If outside antenna is being used, check for broken wire.
Picture Rolls Vertically Lines or Streaks in Picture	<ul style="list-style-type: none"> • Try a new channel, if OK, then possible station trouble. • If outside antenna is being used, check for broken wire. • Check for local interference.
No Color	<ul style="list-style-type: none"> • Try a new channel, if OK, then possible station trouble. • Is antenna connected to jack on the back of the set? • If outside antenna is being used, check for broken wire. • Adjust "COLOR" control.
Poor Reception on Some Channels Ghosts in Picture	<ul style="list-style-type: none"> • Try a new channel, if OK, then possible station trouble. • Is antenna connected to jack on the back of the set? • If outside antenna is being used, check for broken wire. • Check for local interference.
Weak Picture	<ul style="list-style-type: none"> • Try a new channel, if OK, then possible station trouble. • Is antenna connected to jack on the back of the set? • If outside antenna is being used, check for broken wire. • Adjust "CONTRAST" & "BRIGHT" control.

PROBLEM	CORRECTIVE ACTION
Sound OK, Picture Poor	<ul style="list-style-type: none"> • Try a new channel, if OK, then possible station trouble. • Is antenna connected to jack on the back of the set? • If outside antenna is being used, check for broken wire. • Check for local interference. • Adjust "CONTRAST" & "BRIGHT" control.
Picture OK, Sound Poor	<ul style="list-style-type: none"> • Try a new channel, if OK, then possible station trouble. • Check for local interference.
No operation by infrared Remote Control	<ul style="list-style-type: none"> • Make sure the AC cord is connected to an AC outlet. • Check batteries in remote control.
Different color marks on screen	<ul style="list-style-type: none"> • Magnetism from nearby appliances and geomagnetism might affect the color of the TV picture. Move the unit away from the appliances, the unit can repair itself automatically. If you want to repair immediately, unplug the power cord, then plug it in again 30 minutes later or so. This automatically resets the unit.

CLOSED CAPTION PROBLEM	POSSIBLE REMEDY
Misspelling in captions	<ul style="list-style-type: none"> • Error committed by the closed captioning production company. Possible in a live broadcast. Not in case of a prerecorded program.
Text is not shown in its entirety or a delay occurs from what is being said.	<ul style="list-style-type: none"> • A few seconds of delay is common for live broadcast. • Display capacity may not exceed 220 words per minute. If a dialogue exceeds that rate, selective editing is used to insure that the captions remain up-to-date with the current TV screen dialogue.
Captions scrambled with white boxes	<ul style="list-style-type: none"> • Caused by interferences of building, power lines, thunderstorms, etc.
No captions in a program which must contain closed caption	<ul style="list-style-type: none"> • The broadcast may use a time compression process to speed up the program. The decoder cannot read the compressed information and captions will be lost.
Black box in the TV screen	<ul style="list-style-type: none"> • You are in TEXT mode. Select a CAPTION mode ("C1", "C2") or Caption "OFF".

DVD Mode

PROBLEM	CORRECTIVE ACTION
No picture	<ul style="list-style-type: none"> • Insert a correct video disc that plays on this unit. • Press [SELECT] to select DVD mode, then try other DVD feature.
Disc cannot be played	<ul style="list-style-type: none"> • Insert the disc. • Clean the disc. • Place the disc correctly, with the label side up. • Cancel the parental lock or change the control level.
No sound	<ul style="list-style-type: none"> • Connect the audio cables firmly. • Turn the power of the audio component on. • Correct the audio output settings. • Correct the input settings on the audio component.
No DTS audio is output	<ul style="list-style-type: none"> • This unit does not support DTS audio. This is not a malfunction.
Distorted picture	<ul style="list-style-type: none"> • There are some cases where pictures may be slightly distorted, which are not a sign of a malfunction. • Although pictures may stop for a moment, this is not a malfunction.
Audio or subtitle language does not match the set up	<ul style="list-style-type: none"> • The selected language is not available for audio or subtitles on the DVD. (This is not a malfunction.)
The camera angle cannot be changed	<ul style="list-style-type: none"> • The DVD does not contain sequences recorded from different camera angles. (This is not a malfunction.)
Audio or subtitle language cannot be changed	<ul style="list-style-type: none"> • The DVD does not contain audio source or subtitles in the selected language. (This is not a malfunction.)
“Prohibited icon” appears on the screen, prohibiting an operation	<ul style="list-style-type: none"> • That operation is prohibited by the unit or the disc. (This is not a malfunction.)
CD sound dropout No CD reproduction DVD picture dropout DVD picture freeze DVD picture in mosaic No DVD reproduction	<ul style="list-style-type: none"> • Scratched disc. Replace the disc with an unscratched one.
Disc cannot be inserted	<ul style="list-style-type: none"> • Check if any disc is already in.
Disc cannot be taken out	<ul style="list-style-type: none"> • Unplug and plug again the power cord to the outlet, and then press [EJECT ▲]. • Press and hold [EJECT △] on the unit for more than 5 seconds.

NOTE

- Some functions are not available in specific modes, but this is not a malfunction. Read the description in this Owner’s Manual for details on correct operations.
- Playback from a desired track and random playback are not available during program playback.

MAINTENANCE

CABINET CLEANING

- Wipe the front panel and other exterior surfaces of the unit with a soft cloth immersed in lukewarm water and wrung dry.
- Never use a solvent or alcohol. Do not spray insecticide liquid near the unit. Such chemicals may cause damage and discoloration to the exposed surfaces.

SERVICING

- Should your unit become inoperative, do not try to correct the problem by yourself. There are no user-serviceable parts inside. Turn off, unplug the power cord and **please call our help line mentioned on the front page**, to locate an Authorized Service Center.

IF THE LASER OPTICAL PICKUP UNIT IS DIRTY

- If the unit still does not perform properly when it is operated, while referring to the relevant sections and to “TROUBLESHOOTING GUIDE” in this Owner’s Manual, the laser optical pickup unit may be dirty. Consult your dealer or an Authorized Service Center for inspection and cleaning of the laser optical pickup unit.

DISC HANDLING

- Handle the discs so that fingerprints and dust do not adhere to the surfaces of the discs.

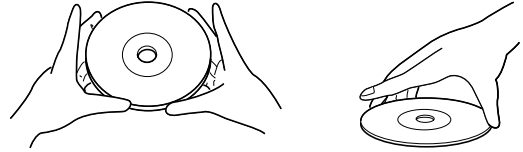

- Always store the disc in its protective case when it is not used.

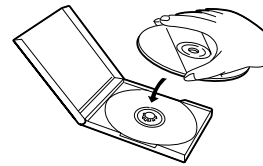

- To clean-off, use a soft cloth.
- Do not use a hard cloth since this will mar the disc.
- Wipe the disc in a straight line from center to edge.
- Never wipe with a circular motion.
- Do not use detergent or abrasive cleaning agents.

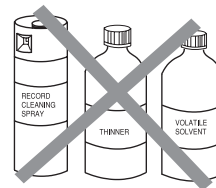
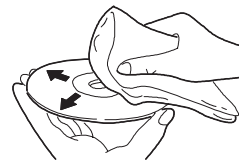

SPECIFICATIONS

GENERAL SPECIFICATIONS

TV

LCD :	20 inch
Television system :	NTSC-M
Closed caption system :	§15.119/FCC
Channel coverage:	
VHF:	2 ~ 13
UHF:	14 ~ 69
CATV:	2 ~13, A ~ W, W+1 ~ W+84, A-5 ~ A-1, 5A
Tuning System:	181 channel frequency synthesized tuning system
Channel access:	Direct access keyboard, programmable scan and up/down

DVD

Product type:	DVD Player
Discs:	DVD video, Audio CD CD with MP3 files

ELECTRICAL SPECIFICATIONS

Sound output: 2 speakers, 1W, 8 ohm

OTHER SPECIFICATIONS

Terminals

Antenna input:	VHF/UHF/CATV 75 ohm unbalanced (F-type)
S-Video input:	Mini DIN 4-pin jack
Video input:	RCA connector × 1
Audio L/R input:	RCA connector × 4
Component video input:	
One pin jack (Y), 1Vpp (75 ohm)	
Two pin jacks (Pr)/(Pb), 700mVpp (75 ohm)	
Coaxial digital audio output:	
One pin jack, 500mVpp (75 ohm)	
Headphone:	1/8" stereo (3.5mm)
Remote control:	Digital encoded infrared light system

Operating

temperature:	5°C to 40°C (41°F~104°F)
Power requirements:	AC 120V, 60Hz
Power consumption (Maximum):	65W
LCD:	20"
Dimensions:	H :20-1/16"(510mm) W :19-1/2" (495mm) D :14-7/16"(366mm)
Weight:	16.3 lbs. (7.4kg)

- Designs and specifications are subject to change without notice.
- If there is a discrepancy between languages, the default language will be English.

INDICE

■ INDICE	38
■ CONTROLES DE OPERACIÓN Y FUNCIONES	38
PARA INSERTAR LAS PILAS	39
■ PREPARACIÓN PARA LA UTILIZACIÓN	40
CONEXIONES DE ANTENA/CABLE	40
CONEXIÓN EXTERNA	41

SECCIÓN DE TV

■ OPERACIÓN DE TV Y AJUSTES	42
PARA MIRAR UN PROGRAMA DE TV	42
AJUSTE DE CANAL	43
IDIOMA DE MENÚ	43

SECCIÓN DE DVD

■ REPRODUCCIÓN DE UN DISCO	44
REPRODUCCIÓN BÁSICA	44
MENÚ DE DISCO	45
REANUDACIÓN	45

CONTROLES DE OPERACIÓN Y FUNCIONES

NOTE

- Para elegir el modo de DVD presione primero [**PLAY ▷**] o [**EJECT ▲**], o introduzca un disco en la ranura. De otra manera, el DVD no funcionará.

- MANDO A DISTANCIA

- Para saber cómo funciona el mando a distancia, consulte la [Fig.1] de la página 8.

- 1. Botón POWER**
Presione para encender y apagar la unidad.
- 2. Botón PICTURE**
Presione para ajustar la imagen.
- 3. Botones numéricos**
Presione para seleccionar directamente el número de canal deseado.
Botón +100 (para modo TV)
Presione para seleccionar canales cuyo número sea superior a 99.
Botón +10 (para modo DVD)
Presione para introducir los números superiores a 9 deseados.
- 4. Botón SLEEP**
Presione para ajustar el temporizador de reposo
- 5. Botones SKIP ◀◀ / ▶▶**
Presione una vez para omitir capítulos o pistas y desplazarse a un punto específico.
- 6. Botón PLAY ▷**
Presione para reproducir el disco.
- 7. Botón PAUSE ||**
Presione para hacer una pausa en la reproducción del disco actual.
- 8. Botón DISPLAY**
Para modo TV :
Presione para visualizar el número actual de canal en la pantalla del televisor.
Para modo DVD :
Presione para visualizar el estado actual en la pantalla del televisor.
- 9. Botón SETUP**
Presione para entrar o salir del menú de configuración del TV/DVD.
- 10. Botón TITLE**
Presione para visualizar el menú de títulos.
- 11. Botón CLEAR**
Presione para cancelar o borrar un ajuste introducido actualmente.
Presione para borrar la pantalla “DISCO ADENTRO”.
- 12. Botón MODE**
Presione para visualizar la pantalla de la reproducción programada o la de reproducción aleatoria en el modo de parada.
Presione para visualizar la pantalla de ajuste del nivel del negro o la pantalla de sonido envolvente durante la reproducción.
- 13. Botón SEARCH MODE**
Presione para localizar un punto deseado.
- 14. Botón AUDIO**
Para modo TV: Presione para seleccionar el modo de sonido de TV (ESTEREO/SAP/MONO).
Para modo DVD: Presione para seleccionar un idioma de audio deseado (si está disponible).
- 15. Botón EJECT ▲**
Presione para extraer un disco de la unidad.
- 16. Botón SELECT**
Presione para seleccionar el modo TV, modo de entrada externa o modo de DVD.
- 17. Botones CH. ▲ / ▼**
Presione para seleccionar canales memorizados.
- 18. Botones VOL. △ / ▽**
Presione para controlar el nivel de volumen del DVD y el televisor.
- 19. Botón MUTE**
Presione para silenciar el sonido. Presiónelo de nuevo para restablecer el sonido.
- 20. Botón ZOOM**
Presione para ampliar la parte de la imagen reproducida en un DVD.

- 21. Botón REV ◀◀**
Presione para ver la imagen en DVD en retroceso o en cámara lenta de retroceso.
- Botón FWD ▶▶**
Presione para mover en avance rápido o en cámara lenta en el disco.
- 22. Botón STOP ■**
Presione para detener la reproducción del disco.
- 23. Botón DISC MENU**
– Muestra el menú del DVD.
– Muestra la lista de archivos del disco MP3.
- 24. Botón ENTER**
Presione para establecer un ajuste.
- 25. Botones ▲ (Arriba) / ▼ (Abajo) / ◀ (Izquierda) / ▶ (Derecha)**
Presione para seleccionar o ajustar los ítems del menú.

- 26. Botón RETURN**
Presione para volver a la pantalla anterior en el menú de configuración.
- 27. Botón A-B**
Presione para repetir la reproducción de una sección seleccionada.
- 28. Botón ANGLE**
Presione para cambiar el ángulo de la cámara y ver la secuencia que se está reproduciendo desde un ángulo diferente (si existe).
- 29. Botón REPEAT**
Repita la reproducción del disco, título, capítulo, grupo o pista actual.
- 30. Botón SUBTITLE**
Presione para seleccionar el idioma de los subtítulos.

- PANEL FRONTAL

• Para ver la ilustración del panel frontal, vaya a la página 9, [Fig. 2].

- 31. Botón STOP □**
Presione para detener la reproducción del disco.
- 32. Botón MENU**
Presione para entrar o salir del menú de configuración del TV/DVD.
- 33. Botones VOLUME ▲ / ▼**
Presione para controlar el nivel de volumen del DVD y el televisor.
- 34. Botones CHANNEL ▲ / ▼**
Presione para seleccionar canales memorizados.
- 35. Botón SELECT**
Presione para seleccionar el modo TV, modo de entrada externa o modo de DVD.
- 36. Botón POWER**
Presione para encender y apagar la unidad.
- 37. Botón EJECT △**
Presione para extraer un disco de la unidad.
- 38. Ventana de sensor remoto**
- 39. Botón PLAY ▷**
Presione para reproducir el disco.

PARA INSERTAR LAS PILAS

- 1 Abra la cubierta del compartimiento de las pilas empujando la cubierta del mando a distancia en el sentido de la flecha.
- 2 Inserte 2 pilas "AA" en el compartimiento de las pilas, en el sentido indicado por las marcas de polaridad (+/-).
- 3 Vuelva a poner la cubierta.

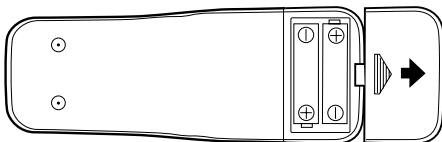

PRECAUCIONES A LA HORA DE INSERTAR LAS PILAS

- Asegúrese de seguir la polaridad correcta, tal como se indica en el compartimiento de las pilas. Si se colocan las pilas con la polaridad invertida se pueden ocasionar daños a la unidad.
- No mezcle distintos tipos de pilas (ej. alcalina y de carbón-zinc) o pilas viejas con nuevas.
- Si no va a usarse la unidad durante un período largo de tiempo, quite las pilas para prevenir daños o lesiones ocasionadas por posibles fugas de las pilas.
- No intente recargar las pilas que no sean para recargar; pueden sobrecalentarse y estropearse.

NOTA

- No se recomienda el uso de mandos a distancia universales. No todas las funciones pueden controlarse con un mando a distancia universal. Si decide usar un mando a distancia universal con esta unidad, sea consciente de que el número de código suministrado puede no adecuarse a la unidad. En este caso, llame al fabricante del mando a distancia universal.

PREPARACIÓN PARA LA UTILIZACIÓN

CONEXIONES DE ANTENA/CABLE

NOTA

- Los cables utilizados aquí están disponibles en los comercios.
- Para su seguridad y para evitar daños a la unidad, desconecte el cable de antena de la toma ANT. antes de trasladar la unidad.

- CONEXIONES DE ANTENA/CABLE (CON O SIN CAJA)

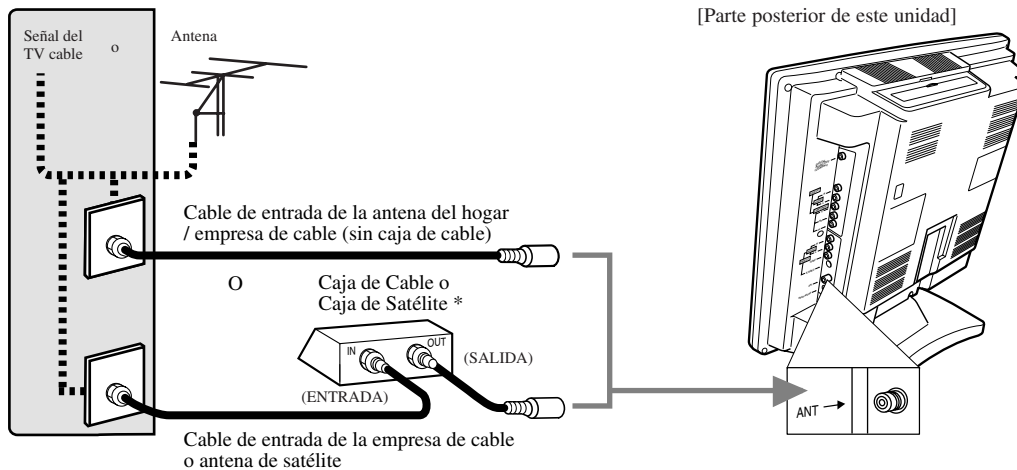

*Algunos sistemas de TV por cable utilizan señales codificadas y requieren un convertidor especial para recibir estos canales. Consulte con su empresa de cable local.

SI TIENE UNA TOMA DE PARED

Conecte el televisor a la toma de antena de pared con el cable RF (disponible en los comercios).

SI TIENE CABLE DE HILOS

Conecte el televisor al cable de antena.

CUANDO SE USA UNA CAJA DE CONVERTIDOR/CAJA DE SATELITE

Si su compañía de televisión por cable le suministra una caja de convertidor o si usa un sistema de satélite, podrá utilizar la conexión básica que se muestra anteriormente.

La selección de los canales deberá hacerse con la caja de convertidor o caja de satélite. Esto significa que no es posible cambiar de canal utilizando el mando a distancia de la unidad.

NOTA

- Antes de conectar la antena en la toma ANT. de la unidad, compruebe que la patilla no esté torcida. Si lo está, ponga la patilla recta tal como se muestra en la ilustración y a continuación conecte la patilla a la toma ANT. de la unidad.

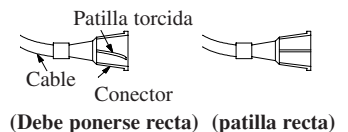

Para el instalador de sistemas CATV:

- Esta nota tiene la finalidad de llamar la atención del instalador de sistemas CATV para que tenga en cuenta el Artículo 820-40 de la NEC, que proporciona recomendaciones para hacer una conexión a tierra apropiada y, en particular, especifica que la tierra del cable debe conectarse al sistema de puesta a tierra del edificio, tan cerca del punto de entrada del cable como sea posible.

CONEXIÓN EXTERNA

[Parte posterior de este unidad]

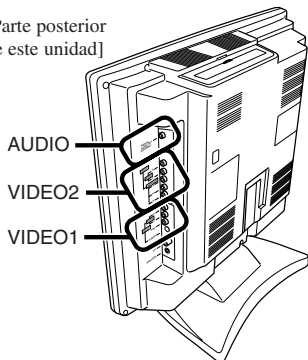

Puede conectar esta unidad a su equipo de audio/vídeo.

- Asegúrese de apagar todos los componentes del sistema antes de conectar otro componente.
- Consulte los manuales de instrucciones de los componentes que va a conectar a la unidad.

NOTA

Cuando utilice las tomas de entrada externa seleccione el "AUX1" o "AUX2" presionando [INPUT SELECT]. (Consulte la página 42.)

- Para utilizar la tomas VIDEO1, seleccione "AUX1".
- Para utilizar la tomas VIDEO1, seleccione "AUX2".

- ENTRADA DE VIDEO1

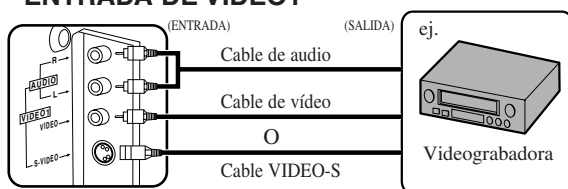

Use esta conexión si su propio equipo A/V (ej. videogradora) tiene tomas de salida de audio y vídeo. Cuando se usa un cable Vídeo-S, se obtiene una imagen mejor.

NOTA

- Si su propio equipo es monofónico (sólo tiene una toma de audio), conecte el cable de audio a la toma AUDIO L de esta unidad.
- Si conecta la toma VIDEO y la toma S-VIDEO simultáneamente, se da prioridad a la S-VIDEO. .

- ENTRADA DE VIDEO2

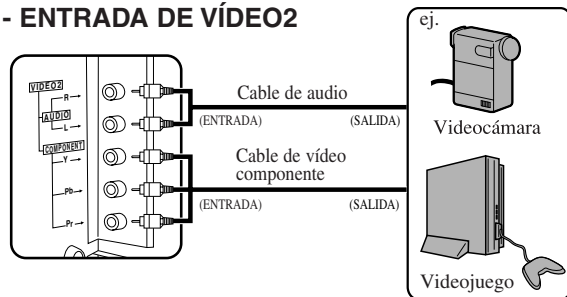

Use esta conexión si el equipo A/V (ej. videocámara o videojuego) tiene tomas de salida de vídeo COMPONENTE (Y,Pb,Pr). Podrá disfrutar de una mejor imagen con esta conexión.

- SALIDA DE AUDIO

A toma de ENTRADA DIGITAL COAXIAL DE AUDIO

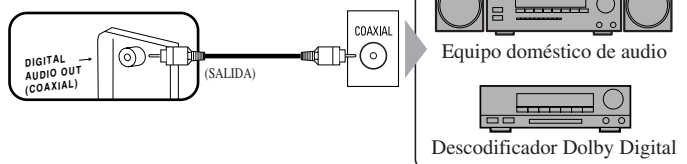

Podrá disfrutar de un sonido de DVD con más presencia desconectando el equipo de audio digital, tal como el decodificador Dolby Digital.

NOTA

- La fuente de audio de un disco en un formato de sonido envolvente Dolby Digital de 5,1 canales no se puede grabar como sonido digital mediante una pletina MD o DAT.
- Si conecta un decodificador Dolby Digital, ajuste la función "DOLBY DIGITAL" a "BITSTREAM" para salida de audio en el modo de configuración. (Consulte la página 30).
- A menos que se haga la conexión a un decodificador "DOLBY DIGITAL" a "PCM" para salida de audio en el modo de configuración.

La reproducción en una unidad utilizando ajustes incorrectos puede generar ruido y distorsión, y también puede provocar daños a los altavoces. (Consulte la página 30).

Fabricado bajo licencia de Dolby Laboratories. "Dolby" y el símbolo de la doble D son marcas comerciales de Dolby Laboratories.

OPERACIÓN DE TV Y AJUSTES

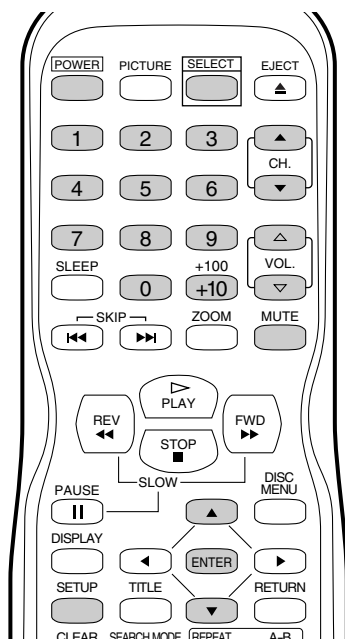

- Los botones sombreados se utilizan para las siguientes operaciones.

PARA MIRAR UN PROGRAMA DE TV

- 1 Conecte el cable de alimentación de la unidad a una toma estándar CA.

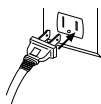

NOTA

- Si se visualiza algún dígito en la esquina de la pantalla, presione **[POWER]** sin desconectar el cable de alimentación.

- 2 Presione **[POWER]** para encender la unidad.



- 3 Presione **[CH. ▲ / ▼]** para seleccionar el número de canal deseado.

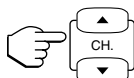

o

Presione los **botones numéricos** para introducir el número de canal deseado.

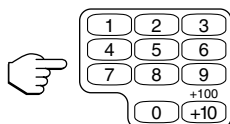

NOTA

Para seleccionar el número de canal mediante los botones numéricos:

- Para seleccionar un número de canal de un solo dígito, presione primero **[0]** (ej. Para el canal 2, presione **[0] [2]**).
- Para seleccionar canales por cable cuyos números sean superiores a 99, presione primero **[+100/+10]**. (ej. Para el canal 125, presione **[+100/+10] [2] [5]**).

- 4 Presione **[VOL. ▲ / ▼]** para seleccionar el nivel de volumen deseado.

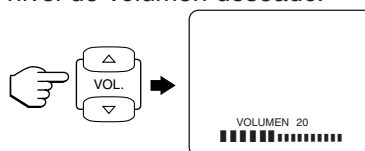

- Presione **[MUTE]** para silenciar el sonido al instante. Vuelva a presionarlo para restaurar el nivel de volumen anterior.

NOTA

- Si se presiona **[CH. ▲ / ▼]** en el modo DVD, puede cambiar los canales del televisor. Incluso si apaga la unidad en el modo DVD, cuando vuelve a encenderlo se pondrá en el modo TV.

PARA VER UN CANAL POR CABLE O SATÉLITE

Si la unidad está conectada a una caja de convertidor o caja de satélite, presione **[CH. ▲ / ▼]** para seleccionar CH3 o CH4 según el ajuste de canal de salida del aparato, y seleccione en él el canal deseado.

PARA VER SEÑALES DE ENTRADA DE UN DISPOSITIVO EXTERNO

Cuando conecte un equipo externo a las tomas de entrada delanteras AUDIO/VIDEO, presione **[SELECT]** o **[CH. ▲ / ▼]** repetidamente hasta que aparezca en la pantalla "AUX1" o "AUX2".

NOTA

- Si hay un disco dentro de la unidad, se visualizará el mensaje "DISCO ADENTRO" en la pantalla durante 10 segundos.



- Para borrar el mensaje al instante, presione **[CLEAR]**.

AJUSTE DE CANAL

PROGRAMACIÓN AUTOMÁTICA DE CANAL

De acuerdo con la configuración de fábrica, esta unidad ha memorizado todos los canales, incluidos los que no están disponibles en su localidad. Esta función solo pone automáticamente en memoria los canales disponibles.

- 1 Presione [SETUP] y a continuación presione [▲] o [▼] para señalar "AJUSTE DE CANAL".

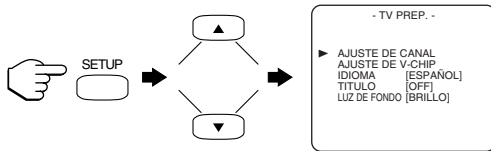

- 2 Presione [ENTER] y a continuación presione [▲] o [▼] para señalar "PREA. AUTO CA.".

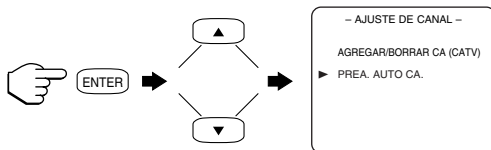

- 3 Presione [ENTER].



- El sintonizador explora y memoriza todos los canales activos de su localidad.
- El sintonizador se detiene en el canal memorizado inferior.

NOTA

- Cuando está activado "PREA. AUTO CA." donde no hay entrada de señal de TV, aparecerá "NO HAY SEÑAL DE TV" en la pantalla después de completarse la exploración de los canales

- La unidad puede reconocer canales CATV como canales de TV si las condiciones de recepción son malas. En este caso, compruebe la conexión de la antena y vuelva a intentar "PREA. AUTO CA." cuando las condiciones de recepción mejoren.
- La programación de canales memorizados NO es necesaria cuando la unidad está conectada a una caja de convertidor o caja de satélite. Sólo tiene que seleccionar el canal para caja de convertidor o entrada de satélite (ej. CH3) de la unidad y a continuación seleccione el canal que desee en la caja de convertidor o la caja de satélite.

IDIOMA DE MENÚ

- 1 Presione [SETUP] y a continuación presione [▲] o [▼] para seleccionar el "LANGUAGE".

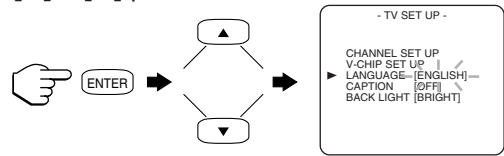

- 2 Presione [ENTER] repetidamente para seleccionar "ENGLISH" = inglés, "ESPAÑOL" o "FRANÇAIS" = francés.



- 3 Presione [SETUP] para salir del menú.

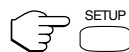

NOTA

- Esta función selecciona sólo el idioma del menú de pantalla; no la fuente de audio.
- Si por alguna razón el menú está en español o en francés, presione [SETUP], luego [▲] o [▼] para seleccionar "IDIOMA [ESPAÑOL]" o "LANGAGE [FRANÇAIS]", y a continuación presione [ENTER] repetidamente para seleccionar el idioma deseado y luego presione [SETUP].

SECCIÓN DE DVD

REPRODUCCIÓN DE UN DISCO

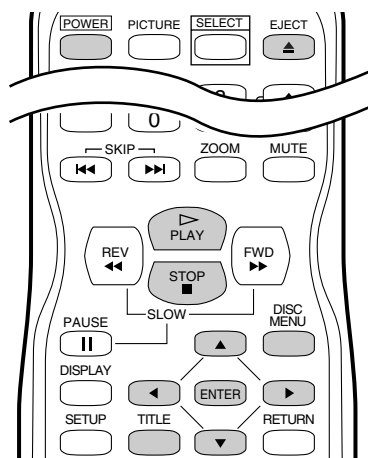

- Los botones sombreados se utilizan para las siguientes operaciones.

REPRODUCCIÓN BÁSICA

PARA EMPEZAR



Si es necesario, encienda el amplificador y cualquier otro componente.

- 1 Presione **[POWER]** para encender la unidad.



- 2 Abra la bandeja del disco manualmente.

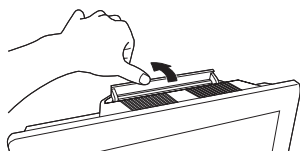

- 3 Introduzca el disco elegido con la etiqueta hacia la parte trasera de la unidad para reproducirlo. Al presionar suavemente el disco para introducirlo en la ranura, su reproducción empezará automáticamente.

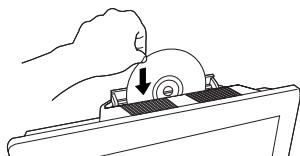

- La reproducción empezará desde el primer capítulo/pista del disco.
- Si la reproducción no empieza automáticamente, presione **[PLAY ▷]**.

- 4 Presione **[STOP ■]** para detener la reproducción.

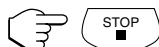

- 5 Presione **[EJECT ▲]** para extraer el disco de la unidad.

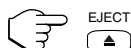

NOTA

- Cuando el modo DVD se ha cambiado al modo TV, el modo DVD se desactiva primero y a continuación aparece la imagen y suena el sonido en el TV al cabo de unos 4 segundos. De la misma manera, cuando se presiona **[POWER]** para apagar la unidad en el modo DVD, este modo se desactiva primero y a continuación se apaga la unidad.
- Puede aparecer “⊘” en la parte superior derecha de la pantalla del TV durante su funcionamiento, que avisa de que el DVD o el disco han encontrado una operación prohibida.
- Con los DVD que utilizan títulos para señales de reproducción programada, la reproducción puede empezar desde el segundo título y puede omitir estos títulos.
- Durante la reproducción de un disco de dos capas, las imágenes pueden detenerse durante un rato. Esto ocurre cuando la 1ª capa cambia a la 2ª. No se trata de una anomalía.

REPRODUCCIÓN DE MP3



- 1 En el modo de parada, presione **[DISC MENU]** y presione **[▲]** o **[▼]** para seleccionar el grupo o pista que desee.

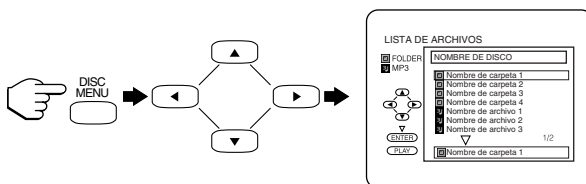

- Si ha seleccionado un grupo, presione **[▶]** o **[ENTER]** para ir a la pantalla de selección de pistas. Presione **[◀]** para volver a la pantalla anterior (excepto la página superior).
- Si ha seleccionado una pista, presione **[ENTER]** para empezar a reproducir pistas. Si empieza por la que acaba de elegir se reproducirán las pistas siguientes.
- Si no puede visualizarse enseguida en pantalla la lista entera de archivos, aparece la “▽” para ir a la página siguiente. appears to go to the next page.
- Presione **[TITLE]** para volver al archivo superior de la jerarquía más alta del programa y de la lista de archivos.

- 2 Presione **[STOP ■]** para detener la reproducción.



NOTA

- Las carpetas se conocen como grupos; los archivos, como pistas.
- Los archivos MP3 van acompañados de  iconos.
- Se puede reconocer un máximo de 255 carpetas.
- Se puede reconocer un máximo de 999 archivos.
- Pueden crearse hasta 8 jerarquías.

Se recomienda para esta unidad el uso de archivos grabados según las especificaciones siguientes:

- Frecuencia de muestreo: 44,1 kHz o 48kHz
- Velocidad de transmisión de bits constante: 32kbps ~ 320kbps
- Para archivos MP3 grabados en velocidad de transmisión de bits variable (VBR), la unidad puede no mostrar el tiempo real transcurrido.

REANUDACIÓN



- 1 Durante la reproducción, presione **[STOP ■]**.

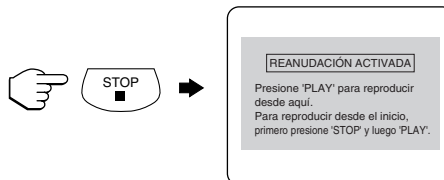

(Ejemplo: DVD o CD audio)

- Aparecerá el mensaje de reanudación en la pantalla del TV.
- 2 Presione **[PLAY ▷]**, la reproducción continuará desde el punto donde se paró la reproducción.





- Para cancelar el modo de reanudación, presione dos veces **[STOP ■]**.
- Para MP3, la reproducción se reanuda desde el principio de la pista actual.
- La información de reanudación permanece activada incluso cuando apaga el interruptor principal.

MENÚ DE DISCO

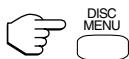

- 1 Presione **[DISC MENU]**.



- Aparecerá el menú principal de DVD
- Si esta función no está disponible,  el símbolo puede aparecer en la pantalla del televisor.
- Si el menú de disco está disponible en el disco, aparecerán las opciones de idioma de audio, de subtítulos, capítulos del título y otras para su selección.

- 2 Presione **[▲]**, **[▼]**, **[◀]** o **[▶]** para seleccionar un ítem y presione **[ENTER]** para confirmar la selección.

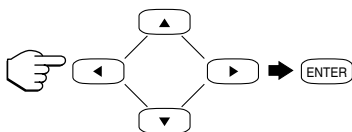

MEMO

MEMO

FUNAI CORPORATION LIMITED WARRANTY

FUNAI CORP. will repair this product, free of charge in the USA in the event of defect in materials or workmanship as follows:

DURATION:

PARTS: FUNAI CORP. will provide parts to replace defective parts without charge for one (1) year from the date of original retail purchase. Certain parts and LCD image burn-in are not covered under this warranty.

LABOR: FUNAI CORP. will provide the labor without charge for a period of ninety (90) days from the date of original retail purchase.

LIMITS AND EXCLUSIONS:

This warranty is extended only to the original retail purchaser. A purchase receipt or other proof of original retail purchase will be required together with the product to obtain service under this warranty.

This warranty shall not be extended to any other person or transferee.

This warranty is void and of no effect if any serial numbers on the product are altered, replaced, defaced, missing or if service was attempted by an unauthorized service center. This FUNAI CORPORATION Limited warranty does not apply to any product not purchased and used in the United States.

This warranty only covers failures due to defects in material or workmanship which occurs during normal use. It does not cover damage which occurs in shipment, or failures which are caused by repairs, alterations or product not supplied by FUNAI CORP., or damage which results from accident, misuse, abuse, mishandling, misapplication, alteration, faulty installation, improper maintenance, commercial use such as hotel, rental or office use of this product or damage which results from fire, flood, lightning or other acts of God.

THIS WARRANTY DOES NOT COVER PACKING MATERIALS, ANY ACCESSORIES (EXCEPT REMOTE CONTROL), ANY COSMETIC PARTS, COMPLETE ASSEMBLY PARTS, DEMO OR FLOOR MODELS.

FUNAI CORP. AND ITS REPRESENTATIVES OR AGENTS SHALL IN NO EVENT BE LIABLE FOR ANY GENERAL, INDIRECT OR CONSEQUENTIAL DAMAGES ARISING OUT OF OR OCCASIONED BY THE USE OF OR THE INABILITY TO USE THIS PRODUCT. THIS WARRANTY IS MADE IN LIEU OF ALL OTHER WARRANTIES, EXPRESS OR IMPLIED, AND OF ALL OTHER LIABILITIES ON THE PART OF FUNAI. ALL OTHER WARRANTIES INCLUDING THE WARRANTY OF MERCHANTABILITY AND FITNESS FOR A PARTICULAR PURPOSE, ARE HEREBY DISCLAIMED BY FUNAI AND ITS REPRESENTATIVES IN THE UNITED STATES. ALL WARRANTY INSPECTIONS AND REPAIRS MUST BE PERFORMED BY AN AUTHORIZED SERVICE CENTER. THIS WARRANTY IS ONLY VALID WHEN THE UNIT IS CARRIED-IN TO AN AUTHORIZED SERVICE CENTER.

IMPORTANT:

THIS LIMITED WARRANTY GIVES YOU SPECIFIC LEGAL RIGHTS. YOU MAY HAVE OTHER RIGHTS THAT VARY FROM STATE TO STATE. IF, AT ANY TIME DURING THE WARRANTY PERIOD, YOU ARE UNABLE TO OBTAIN SATISFACTION WITH THE REPAIR OF THIS PRODUCT, PLEASE CONTACT FUNAI CORP.

ATTENTION:

FUNAI CORP. RESERVES THE RIGHT TO MODIFY ANY DESIGN OF THIS PRODUCT WITHOUT PRIOR NOTICE.

To locate your nearest AUTHORIZED SERVICE CENTER or for general service inquiries, please contact us at:

FUNAI CORPORATION
Customer Service

Tel :1-800-242-7158

<http://www.Symphonic.us>

19900 Van Ness Avenue, Torrance, CA 90501

Free Manuals Download Website

<http://myh66.com>

<http://usermanuals.us>

<http://www.somanuals.com>

<http://www.4manuals.cc>

<http://www.manual-lib.com>

<http://www.404manual.com>

<http://www.luxmanual.com>

<http://aubethermostatmanual.com>

Golf course search by state

<http://golfingnear.com>

Email search by domain

<http://emailbydomain.com>

Auto manuals search

<http://auto.somanuals.com>

TV manuals search

<http://tv.somanuals.com>