

OWNER'S MANUAL

Symphonic

VIDEO CASSETTE RECORDER SE436D

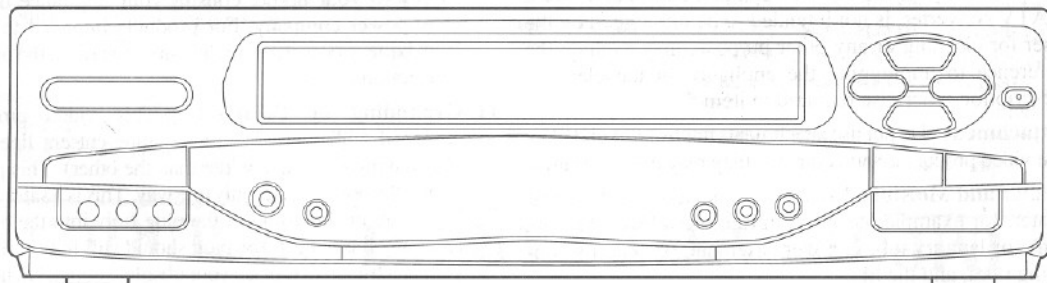

VHS

If you need additional assistance for set-up or operating
after reading owner's manual, please call
TOLL FREE : 1-800-242-7158 (Eastern time 9:00AM-4:30PM / Monday - Friday).

Please read before using this equipment

WARNING:

TO REDUCE THE RISK OF FIRE OR ELECTRIC SHOCK, DO NOT EXPOSE THIS APPLIANCE TO RAIN OR MOISTURE.



CAUTION

RISK OF ELECTRIC SHOCK
DO NOT OPEN



CAUTION: TO REDUCE THE RISK OF ELECTRIC SHOCK, DO NOT REMOVE COVER (OR BACK). NO USER SERVICEABLE PARTS INSIDE. REFER SERVICING TO QUALIFIED SERVICE PERSONNEL.

The caution marking is located on the rear of the cabinet.



THIS SYMBOL INDICATES THAT DANGEROUS VOLTAGE CONSTITUTING A RISK OF ELECTRIC SHOCK IS PRESENT WITHIN THIS UNIT.



THIS SYMBOL INDICATES THAT THERE ARE IMPORTANT OPERATING AND MAINTENANCE INSTRUCTIONS IN THE LITERATURE ACCOMPANYING THE APPLIANCE.

IMPORTANT SAFEGUARDS

- 1. Read instructions**-All the safety and operating instructions should be read before the appliance is operated.
- 2. Retain Instructions**-The safety and operating instructions should be retained for future reference.
- 3. Heed Warnings**-All warnings on the appliance and in the operating instructions should be adhered to.
- 4. Follow Instructions**-All operating and use instructions should be followed.
- 5. Cleaning**-Unplug this video product from the wall outlet before cleaning. Do not use liquid cleaners or aerosol cleaners. Use a damp cloth for cleaning.
EXCEPTION: A product that is meant for uninterrupted service and, that for some specific reason, such as the possibility of the loss of an authorization code for a CATV converter, is not intended to be unplugged by the user for cleaning or any other purpose, may exclude the reference to unplugging the appliance in the cleaning description otherwise required in item 5.
- 6. Attachments**-Do not use attachments not recommended by the video product manufacturer as they may cause hazards.
- 7. Water and Moisture**-Do not use this video product near water, for example, near a bath tub, wash bowl, kitchen sink, or laundry tub, in a wet basement, or near a swimming pool, and the like.
- 8. Accessories**-Do not place this video product on an unstable cart, stand, tripod, bracket, or table. The video product may fall, causing serious injury to a child or adult, and serious damage to the appliance. Use only with a cart, stand, tripod, bracket, or table recommended by the manufacturer, or sold with the video product. Any mounting of the appliance should follow the manufacturer's instructions and should use a mounting accessory recommended by the manufacturer. An appliance and cart combination should be moved with care. Quick stops, excessive force, and uneven surfaces may cause the appliance and cart combination to overturn.
- 9. Ventilation**-Slots and openings in the cabinet are provided for ventilation and to ensure reliable operation of the video product and to protect it from overheating, and these openings must not be blocked or covered. The openings should never be blocked by placing the video product on a bed, sofa, rug, or other similar surface. This video product should not be placed in a built-in installation such as a bookcase or rack unless proper ventilation is provided or the manufacturer's instructions have been adhered to.
- 10. Power Sources**-This video product should be operated only from the type of power source indicated on the marking label. If you are not sure of the type of power supply to your home, consult your appliance dealer or local power company. For products intended to operate from battery power, or other sources, refer to the operating instructions.
- 11. Grounding or Polarization**-This video product is equipped with a polarized alternating-current line plug (a plug having one blade wider than the other). This plug will fit into the power outlet only one way. This is a safety feature. If you are unable to insert the plug fully into the outlet, try reversing the plug. If the plug should still fail to fit, contact your electrician to replace your obsolete outlet. Do not defeat the safety purpose of the polarized plug.
- 12. Power Cord Protection**-Power supply cords should be routed so that they are not likely to be walked on or pinched by items placed upon or against them, paying particular attention to cords at plugs, convenience receptacles, and the point where they exit from the appliance.
- 13. Outdoor Antenna Grounding**-If an outside antenna or cable system is connected to the video product, be sure the antenna or cable system is grounded so as to provide some protection against voltage surges and built-up static charges. Article 810 of the National Electrical Code, ANSI/NFPA No. 70, provides information with regard to proper grounding of the mast and supporting structure, grounding of the lead-in wire to an antenna discharge unit, size of grounding conductors, location of antenna-dis-

PORTABLE CART WARNING
(Symbol provided by RETAC)



S3125A

FIGURE A
EXAMPLE OF ANTENNA GROUNDING AS PER
NATIONAL ELECTRICAL CODE

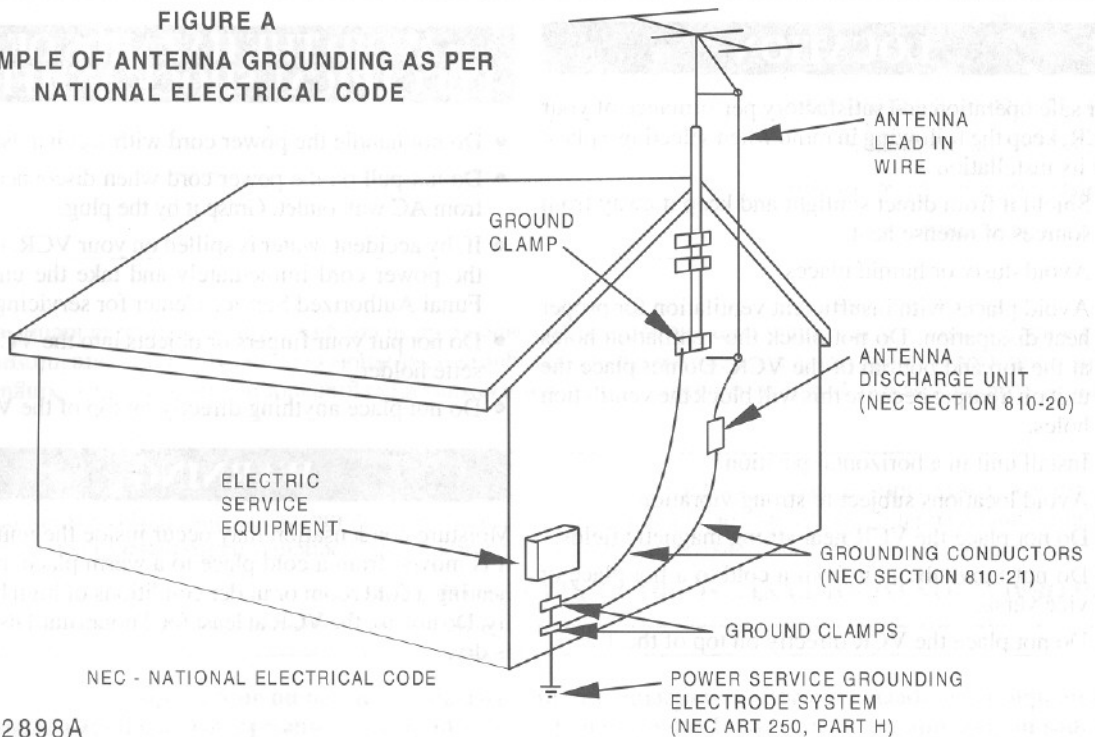

NEC - NATIONAL ELECTRICAL CODE

S2898A

charge unit, connection to grounding electrodes, and requirements for the grounding electrode. (Fig. A)

14. Lightning—For added protection for this video product during a lightning storm, or when it is left unattended and unused for long periods of time, unplug it from the wall outlet and disconnect the antenna or cable system. This will prevent damage to the video product due to lightning and power-line surges.

15. Power Lines—An outside antenna system should not be located in the vicinity of overhead power lines or other electric light or power circuits, or where it can fall into such power lines or circuits. When installing an outside antenna system, extreme care should be taken to keep from touching such power lines or circuits as contact with them might be fatal.

16. Overloading—Do not overload wall outlets and extension cords as this can result in a risk of fire or electric shock.

17. Object and Liquid Entry—Never push objects of any kind into this video product through any openings as they may touch dangerous voltage points or short-out parts that could result in a fire or electric shock. Never spill liquid of any kind on the video product.

18. Servicing—Do not attempt to service this video product yourself as opening or removing covers may expose you to dangerous voltage or other hazards. Refer all servicing to qualified service personnel.

19. Damage Requiring Service—Unplug this video product from the wall outlet and refer servicing to qualified service personnel under the following conditions:

a. When the power-supply cord or plug is damaged.

b. If liquid has been spilled, or objects have fallen into the video product.

c. If the video product has been exposed to rain or water.

d. If the video product does not operate normally by following the operating instructions. Adjust only those controls that are covered by the operating instructions as an improper adjustment of other controls may result in damage and will often require extensive work by a qualified technician to restore the video product to its normal operation.

e. If the video product has been dropped or damaged in any way.

f. When the video product exhibits a distinct change in performance—this indicates a need for service.

20. Replacement Parts—When replacement parts are required, be sure the service technician has used replacement parts specified by the manufacturer or have the same characteristics as the original part. Unauthorized substitutions may result in fire, electric shock or other hazards.

21. Safety Check—Upon completion of any service or repairs to this video product, ask the service technician to perform safety checks to determine that the video product is in proper operating condition.

22. Heat—This video product should be situated away from heat sources such as radiators, heat registers, stoves, or other products (including amplifiers) that produce heat.

PRECAUTIONS

LOCATION

For safe operation and satisfactory performance of your VCR, keep the following in mind when selecting a place for its installation:

- Shield it from direct sunlight and keep it away from sources of intense heat.
- Avoid dusty or humid places.
- Avoid places with insufficient ventilation for proper heat dissipation. Do not block the ventilation holes at the top and bottom of the VCR. Do not place the unit on a carpet because this will block the ventilation holes.
- Install unit in a horizontal position.
- Avoid locations subject to strong vibration.
- Do not place the VCR near strong magnetic fields.
- Do not move the unit from a cold to a hot place or vice versa.
- Do not place the VCR directly on top of the TV.

AVOID THE HAZARDS OF ELECTRICAL SHOCK AND FIRE

- Do not handle the power cord with wet hands.
- Do not pull on the power cord when disconnecting it from AC wall outlet. Grasp it by the plug.
- If, by accident, water is spilled on your VCR, unplug the power cord immediately and take the unit to a Funai Authorized Service Center for servicing.
- Do not put your fingers or objects into the VCR cassette holder.
- Do not place anything directly on top of the VCR.

WARNING

Moisture condensation may occur inside the unit when it is moved from a cold place to a warm place, or after heating a cold room or under conditions of high humidity. Do not use the VCR at least for 2 hours until its inside is dry.

FCC WARNING- This equipment may generate or use radio frequency energy. Changes or modifications to this equipment may cause harmful interference unless the modifications are expressly approved in the instruction manual. The user could lose the authority to operate this equipment if an unauthorized change or modification is made.

IMPORTANT COPYRIGHT INFORMATION

Unauthorized recording or use of broadcast television programming, video tape, film or other copyrighted material may violate applicable copyright laws. We assume no responsibility for the unauthorized duplication, use or other acts which infringe upon the rights of copyright owners.

The serial number of this product may be found on the back of the VCR. No others have the same serial number as yours. You should record the number and other vital information here and retain this book as a permanent record of your purchase to aid identification in case of theft.

Date of Purchase	
Dealer Purchase from	
Dealer Address	
Dealer Phone No.	
Model No.	
Serial No.	

TABLE OF CONTENTS

■ IMPORTANT SAFEGUARDS	2	■ SPECIAL PLAY BACK	19
■ PRECAUTIONS	4	AUTO REPEAT PLAYBACK	19
LOCATION	4	RENTAL PLAY	19
AVOID THE HAZARDS OF ELECTRICAL SHOCK AND FIRE	4	■ SEARCH	20
WARNING	4	COUNTER MEMORY	20
■ FEATURES	6	TIME SEARCH	20
■ SUPPLIED ACCESSORIES	6	INDEX SEARCH	21
■ VIDEO CASSETTE TAPE	7	BLANK SEARCH.....	21
■ OPERATING CONTROLS AND FUNCTIONS ..	8	■ RECORDING	22
■ PREPARATION FOR USE	10	VIEWING AND RECORDING THE SAME PROGRAM.....	22
CABLE CONNECTIONS	10	SKIPPING SOME MATERIALS DURING RECORDING	22
SETTING A VIDEO CHANNEL.....	11	RECORDING ONE PROGRAM WHILE VIEWING ANOTHER.....	23
CONNECTING TO INPUT JACKS.....	11	TO MONITOR THE PROGRESS OF YOUR RECORDING	23
A/V TERMINALS.....	11	OTR (One Touch Recording)	23
INSTALLING THE BATTERIES	11	■ TIMER RECORDING	24
■ MTS (Multi-Channel Television Sound) SYSTEM . 12		AUTOMATIC TIMER RECORDING.....	24
CHECKING THE SELECTED MTS MODE... 12		HINTS FOR TIMER RECORDING.....	26
MTS RECORDING/MONITOR MODE..... 12		AUTO RETURN	26
SELECTING THE MTS SYSTEM..... 13		JUST-IN TIME RECORDING	27
■ PRESET FOR USE	14	■ SETTING THE REMAINING TIME	28
AUTOMATIC CHANNEL PRESET (Without a Cable Box).....	14	■ COPYING A VIDEO TAPE	29
TO DELETE PRESET CHANNEL	15	■ TROUBLESHOOTING GUIDE	30
CHANNEL PRESET AGAIN.....	15	■ MAINTENANCE	31
SETTING THE CLOCK	16	■ SPECIFICATIONS	31
SELECTING THE LANGUAGE	17	■ CABLE CHANNEL DESIGNATIONS	32
■ ON SCREEN DISPLAY	17		
■ PLAYBACK	18		
NORMAL PLAYBACK	18		

FEATURES

- **Hi-Fi System**—The Hi-Fi stereo recording system offers you super sound quality with a dynamic range of 80dB and frequency response from 20Hz to 20kHz and 0.005% wow and flutter.
- **Rotary 4-head Record/Playback System**—Rotary 4-heads to ensure excellent picture quality and special effects playback.
- **Bilingual on-screen menu display selectable in English or Spanish**
- **Infrared remote control**
- **Real time counter**—This shows the elapsed recording or playback time in hours, minutes, and seconds. The "-" indication will appear when the tape is rewound further than the tape counter position "0:00:00".
- **181 channel capability PLL frequency synthesizer tuner with direct station call**— (A converter may be necessary to view scrambled cable channels.)
- **Auto power on system**— (when inserting a tape)
- **Auto counter reset**— (when inserting a tape)
- **Auto rewind when the end of a tape is reached**—(not in the case of timer recording).
- **Direct Button Operation**—When a tape is in the VCR and the power is off, just press PLAY, REWIND or F.FWD button on the main unit and it will automatically turn on the VCR and playback, rewinding or fast-forwarding will start immediately.
- **2 Step Picture Search Operation**— You can view a video program at a high speed or super high speed in either a forward or reverse direction in LP and SLP mode.
- **Still**—"Freeze" the picture at any time, for close viewing of a particular scene.
- **Digital Auto Tracking (DTR)**— Adjusts the tracking automatically for each tape you play.
- **Auto Repeat**—Allows you to repeat a tape indefinitely without pressing the PLAY button.
- **Rental Play Mode**—Improves playback picture quality of worn tapes, especially rental tapes.
- **Three different tape speeds : SP/LP/SLP**
- **OTR (One Touch Recording)**—Instant timed recording from 30 to 480 minutes is possible at the push of the REC/OTR button.
- **1 Year, 7 events (including Daily and Weekly Timer Recording)**—The built-in timer allows you to record up to 7 programs at different times on different channels up to 1 year in advance. The daily timer allows recordings to be made of daily broadcasts, and the weekly timer allows recording to be made once a week up to the end of the tape.
- **Auto Return**—After finished timer recording, the beginning of the recorded program(s) can be searched.
- **Time Search**— Lets you set the VCR to advance the tape by entering the desired playback time you want to skip.
- **Blank Search**— Lets you set the VCR to search for an unrecorded portion on the tape.
- **Index Search**— Lets you Index the start of a recording.
- **Edit Search**— Lets you set the VCR to edit an unwanted segment of a recording.
- **Just-In-Time Recording**— Measures the remaining tape and automatically adjusts the tape speed so that the automatic timer recording fits on a cassette.
- **Remaining Tape Running Time Display**— You can check the remaining running time of your tape.
- **Slow Motion**— You can view the video program at a slower than normal playback speed. Slow speed can be controlled by pressing F.FWD button (faster) or REWIND button (slower).
- **Auto Head Cleaner**—Automatically clean heads as you insert or remove a cassette.

SUPPLIED ACCESSORIES

Coaxial Cable



Remote Control Unit



Batteries
(AA x 2)



User Friendly Quick Start Up



VIDEO CASSETTE TAPE

This VCR will operate with any cassette that has the VHS mark. For best results, we recommend the use of high-quality tapes. *Do not use poor quality or damaged tapes.*

PRECAUTIONS

- Avoid moisture. Moisture condensation may occur on the tape if it is moved from a cold place to a warm place. Before using a tape with these conditions, to avoid a damage of the tape and your VCR, wait until the tape has warmed to room temperature and the moisture has evaporated.
- Avoid extreme heat, high humidity and magnetic fields.
- Do not tamper with the cassette mechanism.
- Do not touch the tape with your fingers.

THREE DIFFERENT TAPE SPEEDS

Before recording, select the tape speed from : **SP mode** (Standard Play), **LP mode** (Long Play) or **SLP mode** (Super Long Play).

The table below shows the maximum recording/playback time using T60, T120 or T160 tapes in each mode.

Tape Speed	Recording/Playback Time			
	Type of tape	T60	T120	T160
SP mode		1 hour	2 hours	2-2/3 hours
LP mode		2 hours	4 hours	5-1/3 hours
SLP mode		3 hours	6 hours	8 hours

INSERTING A CASSETTE

Insert the cassette in the direction as shown. Push in gently, but continuously, on the center-back of the cassette until it is drawn into the VCR.

The VCR will automatically turn on.

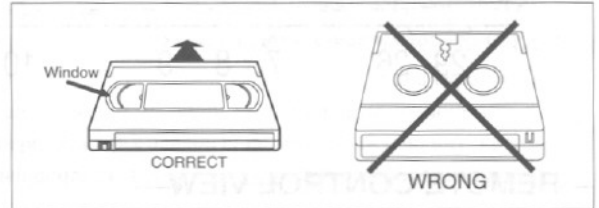

REMOVING A CASSETTE

- 1) In the Stop mode, press EJECT button on the remote control or press STOP/EJECT button on the VCR. The cassette will be ejected.
- 2) Pull the cassette out of the cassette compartment.
- 3) Store the cassette in its case as shown.

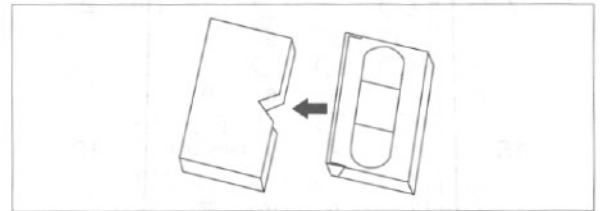

ERASE PREVENTION

You can prevent accidental erasing of recording by breaking off the tab on the back edge of the cassette.

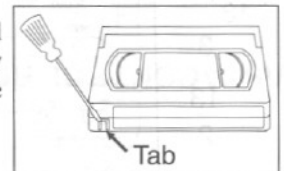

If you decide to record on the tape again, cover the hole with a plastic tape.

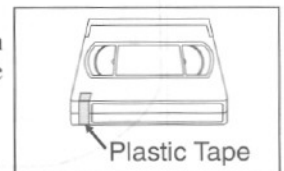

OPERATING CONTROLS AND FUNCTIONS

FRONT VIEW

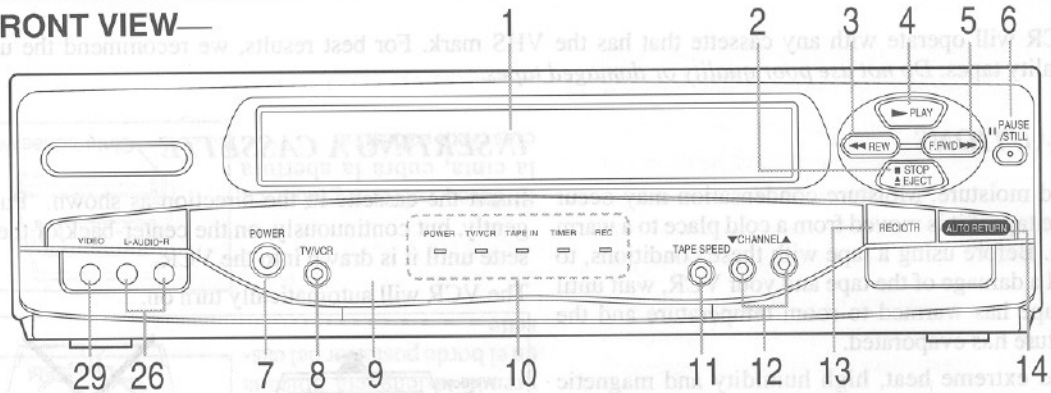

REMOTE CONTROL VIEW

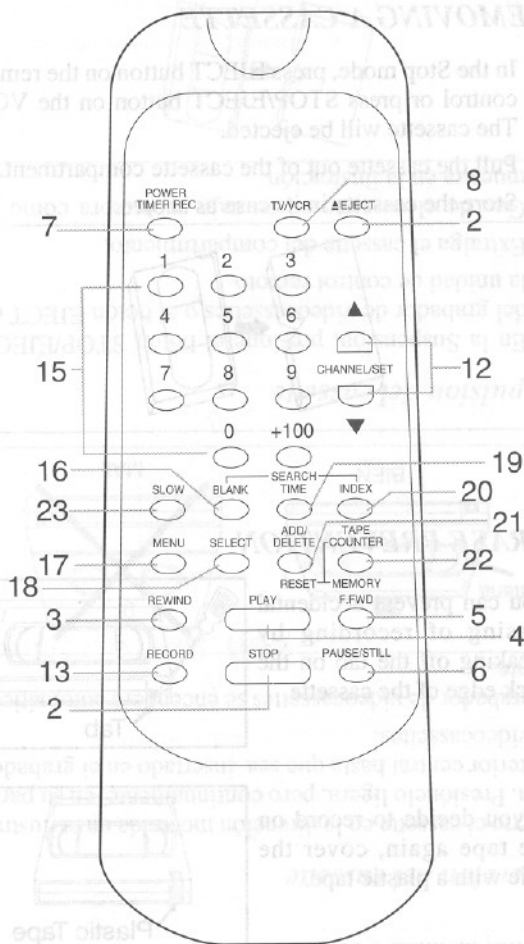

1. Cassette Compartment

2. STOP button—Press to stop the tape motion.

EJECT button—Press to remove a tape from the VCR.

3. REWIND button—Press to rewind the tape, or to view the picture rapidly in reverse during the playback mode. (Rewind Search)

4. PLAY button—Press to begin playback.

5. F.FWD button—Press to rapidly advance the tape, or view the picture rapidly in forward during playback. (Forward Search)

6. PAUSE/STILL button—Press to temporarily stop the tape during recording or to view a still picture during playback.

Frame Advance Function—Press to advance the picture by one frame during the still mode.

7. POWER/TIMER REC button—Press to turn VCR on and off. Press to activate a timer recording.

8. TV/VCR button—Press to select TV or VCR mode.

VCR position: to view playback, to monitor video recordings or watch TV using the VCR tuner.

TV position: to watch TV or to view one program while recording another.

9. Remote sensor window—Receives the infrared signals from the remote control.

10. Indicators

- **POWER indicator**—Indicates that the power is turned on.
- **TV/VCR indicator**—Indicates that the VCR is in VCR position.
- **TAPE IN indicator**—Indicates that there is a tape in the VCR.
- **TIMER indicator**—Indicates that a timer recording or OTR has been set. It flashes when the clock has not been set.
- **REC indicator**—Indicates that a recording is occurring. It flashes when a recording has been paused.

REAR VIEW

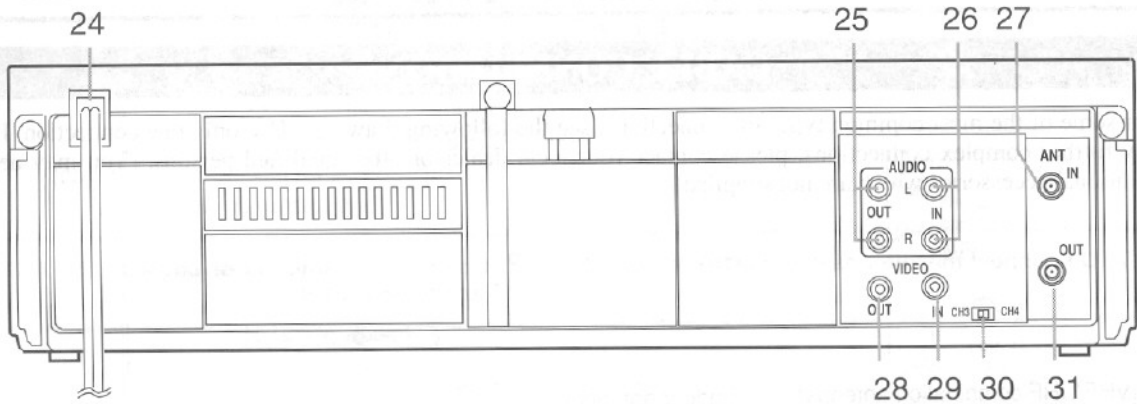

11. **TAPE SPEED button**—Press to set desired recording speed : SP/LP/SLP.
12. **CHANNEL buttons**—Press to select desired channels for viewing or recording.
SET buttons—Press to enter digits when setting program (for example: setting clock or timer program). Press to select setting modes from on screen menu.
Tracking function—Press to minimize video 'noise' (lines or dots on screen) during playback or slow mode. (only on the VCR)
Press to stabilize the picture in the Still mode when the picture begins to vibrate vertically.
13. **RECORD button**—Press to begin manual recording.
OTR button—Press to activate One Touch Recording. (only on the VCR)
14. **AUTO RETURN button**—Press to rewind to the beginning of a timer recording.
15. **NUMBER buttons**—Press to select desired channels for viewing or recording. To select channels from 1 to 9, first press "0" button then 1 to 9.
+100 button—When selecting cable channels which are more than 100, press this button first, then press the last two digits. (To select channel 125, first press "+100" button then press "2" and "5").
16. **BLANK SEARCH button**—Press to use Blank Search mode.
17. **MENU button**—Press to display the main menu on the TV screen.
18. **SELECT button**—When setting program (for example: setting clock or timer program), press to determine your selection and proceed to a next step you want to input. Press to determine setting modes from on screen menu.
Status function—Press to display the remain, counter, or the current channel number and current time on the TV screen.
19. **TIME SEARCH button**—Press to use Time Search mode.
20. **INDEX SEARCH**—Press to use Index Search mode.
21. **ADD/DELETE button**—Press to add or delete channel numbers during channel preset. Press to cancel a setting of timer program. Press to correct digits when setting program (for example: setting clock or timer program).
TAPE COUNTER RESET button—Press to reset counter to 0:00:00.
22. **TAPE COUNTER MEMORY button**—Press to set counter memory on and off.
23. **SLOW button**—Press to reduce the playback speed. Slow speed can be controlled by pressing F.FWD button (faster) or REWIND button (slower).
24. **Power cord**—Connect to a standard AC outlet (120V/60Hz).
25. **AUDIO OUT jacks**—Connect to an audio inputs jack of your audio equipment or another VCR.
26. **AUDIO IN jacks**—Connect to an audio output jacks of your audio equipment or another VCR.
27. **ANT. IN terminal**—Connect to an antenna or CATV.
28. **VIDEO OUT jack**—Connect to a video input jack of your video camera or another VCR.
29. **VIDEO IN jack**—Connect to a video output jack of your video camera or another VCR.
30. **CH3/CH4 selector switch**—Use to select a video output channel (3 or 4) for playback from the VCR.
31. **ANT. OUT terminal**—Connect to an antenna input terminal of your TV.

CABLE CONNECTIONS

For some of the most common types of connections, see the following drawings. Use only one connection. For any further complex connections, please contact your local dealer or other qualified persons. (You may need additional accessories which are not supplied).

1 Disconnect the antenna or cable from your TV.

2 Connect the antenna or cable to the ANT.IN jack of your VCR.

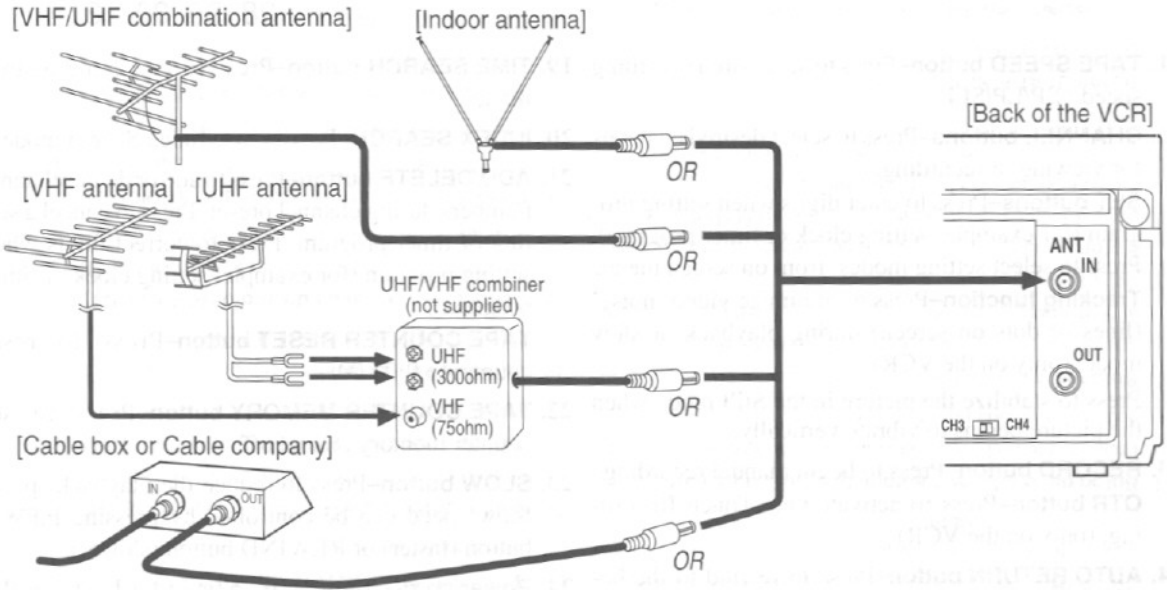

3 Connect one end of the coaxial cable (supplied) to the ANT.OUT jack of your VCR.

4 Connect the other end of the coaxial cable (supplied) to the UHF/VHF antenna jacks.

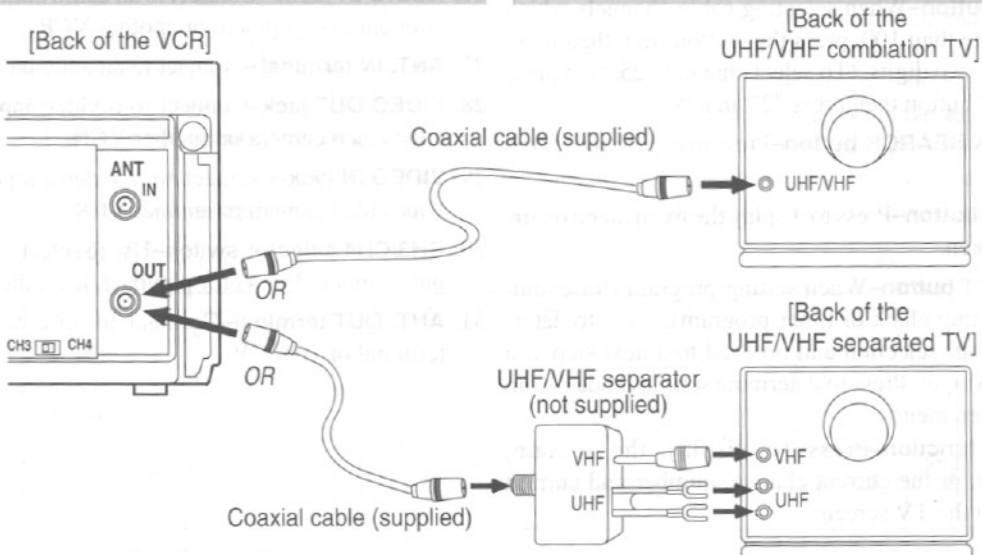

SETTING A VIDEO CHANNEL

If your TV does not have A/V terminals;

When the VCR is in the Playback mode or when the TV/VCR button is in the VCR position, your TV will receive the signals from the VCR on either channel 3 or 4.

To use the VCR with your TV, set the selector switch to CH3 or CH4, whichever is not used or least used for normal broadcasts in your area. Then set your TV to that same channel.



CONNECTING TO INPUT JACKS

When you copy a video tape, or watch a program recorded on an another source, use audio/video input jacks.

NOTE: You can use the audio and video input jacks on the front panel of VCR instead of using jacks on the back.

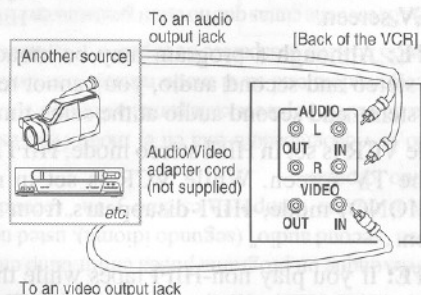

- When you connect the monaural VCR (another source) to this VCR, connect the Audio output jack of the monaural VCR (another source) to the AUDIO IN L jack of this VCR. The audio signal will be recorded in both L and R channel equally.

INPUT SELECT

To use the external input jacks, select the "L1" or "L2" position.

- If you use the audio and video input jacks **on the back of the unit**, press 0, 0, 1 on the remote control to select the "L1" position.
- If you use the audio and video input jacks **on the front of the unit**, press 0, 0, 2 on the remote control to select the "L2" position.

You can select "L1", "L2" as a channel by using the CHANNEL "▲" or "▼" button.

Note: "L1" and "L2" are found before the lowest memorized channel. (Example: CH2)

A/V TERMINALS

If your TV has A/V input jacks, you may connect your VCR's AUDIO/VIDEO OUTPUT jacks to the audio/video input jacks on back of your TV.

Direct audio/video connections usually result in a better picture and sound quality for tape playback. Please see your TV's owner's manual for A/V input connections.

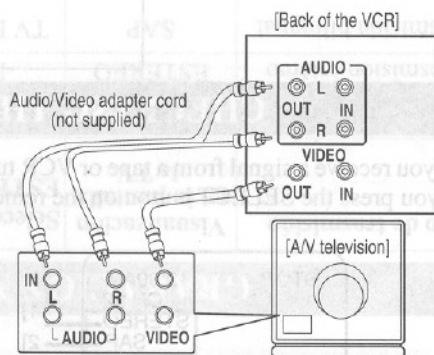

INSTALLING THE BATTERIES

- 1) Open the battery compartment cover by pressing the cover on the remote unit in the direction of the arrow.
- 2) Insert 2 "AA" penlight batteries into the battery compartment in the direction indicated by the polarity (+/-) markings.
- 3) Replace the cover.

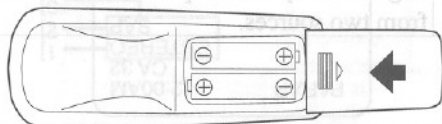

Note to CATV system installer

This reminder is provided to call the CATV system installer's attention to Article 820-40 of the NEC that provides guidelines for proper grounding and, in particular, specifies that the cable ground shall be connected to the grounding system of the building, as close to the point of cable entry as practical.

MTS (Multi-Channel Television Sound) SYSTEM

You can record or listen to a program in MTS broadcast, by using a stereo amplifier and speakers.

Connect your VCR to your stereo source using the following diagram.

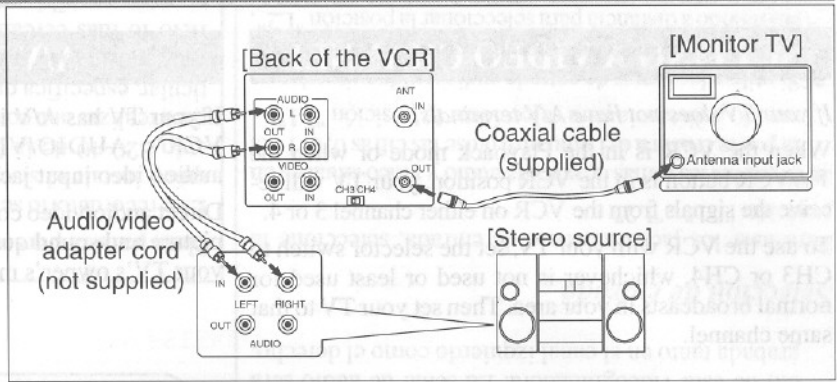

CHECKING THE SELECTED MTS MODE

When you receive a signal from a tape or VCR tuner channel you are watching, the status shown below will appear when you press the SELECT button on the remote control.

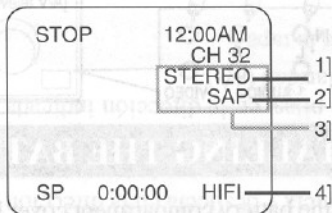

- 1] When a program broadcast in stereo can be received, STEREO appears on the TV screen.
- 2] When a program broadcast in second audio can be received, SAP appears on the TV screen.
- 3] When a program broadcast both in stereo and second audio can be received, STEREO and SAP appear on the TV screen.

NOTE: Although a program may be broadcast in both stereo and second audio, you cannot record in both stereo and second audio at the same time.

- 4] While VCR is set in HIFI stereo mode, HIFI appears on the TV screen. While VCR is set in monaural(MONO) mode, HIFI disappears from the TV screen.

NOTE: If you play non-HIFI tapes while the VCR is set in HIFI, HIFI will disappear from the TV screen and the VCR play automatically in monaural.

SAP	A Second Audio Program which means your program is received in a second language.
HIFI	High Fidelity which produces a clear sound from two sources.

MTS RECORDING/MONITOR MODE

Type of broadcast	Display on the TV screen	STEREO/SAP SELECTION	Hi-Fi audio track (2-channel)		Normal audio track
			L-channel	R-channel	
Regular (monaural audio)	-None-	-Invalid-	Mono	Mono	Mono
Stereo broadcast	STEREO	-Invalid-	L	R	L + R
Bilingual broadcast	SAP	TV STEREO*	Main audio program	Main audio program	Main audio program
		SAP*	Sub audio program	Sub audio program	Sub audio program
Stereo & Bilingual broadcast	STEREO SAP	TV STEREO*	L	R	L + R
		SAP*	Sub audio program	Sub audio program	Sub audio program

* You must select the recording mode in TV STEREO or SAP when you record broadcast.

Refer to "TO SELECT STEREO OR SAP MODE" on the next page.

SELECTING THE MTS SYSTEM

NOTE: You must use the remote control for this procedure.

Make sure ...

- VCR power must be turned on.
- Turn on the TV and set the TV channel to the same video output channel as located on the back of the VCR. (CH 3 or 4)
- Press TV/VCR button so that the TV/VCR indicator on the VCR comes on.

TO SELECT HIFI MODE

1 Select the main menu

Press MENU button. The main menu appears on the TV screen.



2 Select "VCR SET UP"

Press CHANNEL ▲ or ▼ button repeatedly to point to "VCR SET UP".

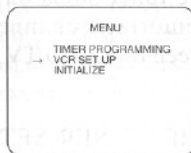

Then, press SELECT button.

3 Select "AUDIO OUT"

Press CHANNEL ▲ or ▼ button repeatedly to point to "AUDIO OUT".

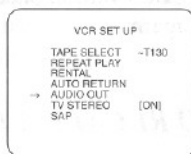

Then, press SELECT button.

4 Select "HIFI"

Press CHANNEL ▲ or ▼ button repeatedly to point to "HIFI".

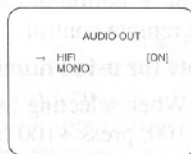

5 To return to TV mode

Press MENU button.

Notes:

- Normally, "HIFI" should be selected for playback with HIFI sound.
- When you play non-HIFI tapes, VCR play automatically in monaural.
- The VCR records automatically MTS broadcasts in HIFI stereo sound.

TO SELECT MONO MODE

You can change the selection to "MONO" if you want to listen to HIFI tapes in normal audio playback.

- 1) Press MENU button.
- 2) Press CHANNEL ▲ or ▼ button repeatedly to point to "VCR SET UP". Then, press SELECT button.
- 3) Press CHANNEL ▲ or ▼ button repeatedly to point to "AUDIO OUT". Then, press SELECT button.
- 4) Press CHANNEL ▲ or ▼ button repeatedly to point to "MONO".
- 5) Press MENU button to return to original mode.

TO SELECT STEREO OR SAP MODE

1 Select the main menu

Press MENU button. The main menu appears on the TV screen.

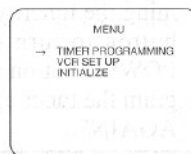

2 Select "VCR SET UP"

Press CHANNEL ▲ or ▼ button repeatedly to point to "VCR SET UP".

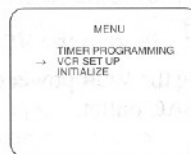

Then, press SELECT button.

3 Select "TV STEREO" or "SAP"

Press CHANNEL ▲ or ▼ button repeatedly to point to "TV STEREO" or "SAP".



Then, press SELECT button.

4 To return to TV mode

Press MENU button.

Notes:

- You must select the recording mode in TV STEREO or SAP when you record broadcast. Refer to "MTS RECORDING/MONITOR MODE" on previous page. When you play the tape on the VCR later, it will be in stereo or second audio.
- If you select second audio when second audio is not available, the VCR will record normal audio.

PRESET FOR USE

Channel memory programming is NOT needed when connected to a cable box. You can program the tuner to scan only the channels you receive in your area. See page 32 for channel designations.

NOTE: You must use the remote control for this procedure.

AUTOMATIC CHANNEL PRESET (Without a Cable Box)

NOTES:

- Follow the steps below once. Repeat it only if there is a power failure or the VCR is unplugged for more than 30 seconds. (In these cases, the programmed channels are erased.)
- You must follow the steps below before attempting to play or record a video tape. If you want to play or record a video tape **BEFORE** programming the tuner, you must first press the **POWER** button to turn off the VCR. Then, press the **POWER** button again to turn it back on. To program the tuner again, see "CHANNEL PRESET AGAIN".

1 Plug in the VCR power cord

Plug the VCR power cord into a standard AC outlet.

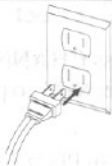

2 Select channel 3 or 4 on the TV

Turn on the TV and set the TV channel to the same video output channel as located on the back of the VCR. (CH3 or 4)

3 Turn on the VCR

Press **POWER** button to turn on the VCR. The **POWER** indicator on the VCR comes on.

4 Select the VCR mode

Press **TV/VCR** button so that the **TV/VCR** indicator on the VCR comes on.

5 Select "ENGLISH" or "ESPAÑOL"

Select "ENGLISH" or "ESPAÑOL=Spanish" using **CHANNEL ▲** or **▼** button.

Then, press **SELECT** or **MENU** button.

LANGUAGE SELECT
→ ENGLISH (ON)
ESPAÑOL

6 Begin channel preset

Press **SELECT** button once. The tuner scans and memorizes all the active channels in your area. (TV mode: from CH2/ CATV mode: from CH1)



- The VCR distinguishes between standard TV channels and cable channels.

7 After scanning

The tuner stops on the lowest memorized channel. The TV screen returns to TV mode.

CH02

- If "TUNER SET UP" appears on the TV screen again, check the cable connections. Then, press **SELECT** button once again. The VCR will begin preset again.

TO RECALL A DESIRED CHANNEL

You can select the desired channel by using **CHANNEL ▲** or **▼** button or directly pressing number buttons on the remote control.

Note for using number buttons:

- When selecting cable channels which are higher than 100, press **+100** button first, then press the last two digits. (To select channel 125, first press "**+100**" button then press "**2**" and "**5**").
- You must precede single-digit channel numbers with a zero (02, 03, 04 and so on).

TO DELETE PRESET CHANNEL

The channels you no longer receive or seldom watch can be deleted from the memory. (Of course, you can add the deleted channel into the memory again.)

NOTE: You must use the remote control for this procedure.

Make sure ...

- VCR power must be turned on.
- Turn on the TV and set the TV channel to the same video output channel as located on the back of the VCR. (CH 3 or 4)
- Press TV/VCR button so that the TV/VCR indicator on the VCR comes on.

1 Select the main menu

Press MENU button. The main menu appears on the TV screen.

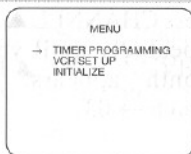

2 Select "INITIALIZE"

Press CHANNEL ▲ or ▼ button repeatedly to point to "INITIALIZE".

Then, press SELECT button.

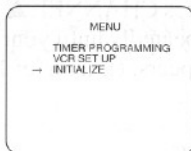

3 Select "CHANNEL SET UP"

Press CHANNEL ▲ or ▼ button repeatedly to point to "CHANNEL SET UP".

Then, press SELECT button.

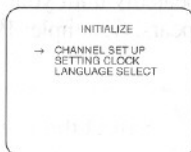

4 Select "ADD/DELETE CH"

Press CHANNEL ▲ or ▼ button repeatedly to point to "ADD/DELETE CH".

Press SELECT button.

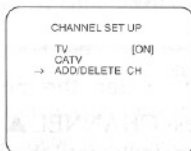

5 Enter the desired channel number

Press the number buttons or CHANNEL ▲ or ▼ button repeatedly until your desired channel number appears. (Example: CH02)



6 Delete it from memory

Press ADD/DELETE button so that "DELETE" flashes on the TV screen.

- To delete another channel, repeat steps [5] and [6].
- If you press ADD/DELETE button again, the channel is memorized again.

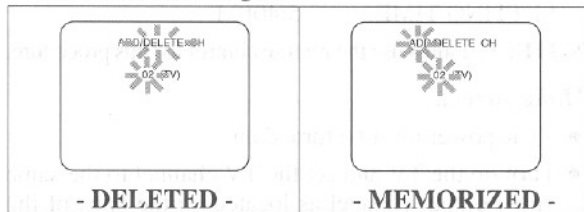

7 Exit the preset mode

Press MENU button to return to TV mode.

NOTE: To confirm that channel(s) has been deleted or added, press CHANNEL ▲ or ▼ button.

CHANNEL PRESET AGAIN

1 Select the main menu

Press MENU button. The main menu appears on the TV screen.

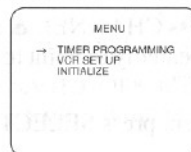

2 Select "INITIALIZE"

Press CHANNEL ▲ or ▼ button repeatedly to point to "INITIALIZE".

Then, press SELECT button.

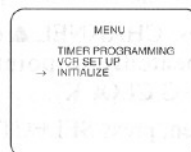

3 Select "CHANNEL SET UP"

Press CHANNEL ▲ or ▼ button repeatedly to point to "CHANNEL SET UP".

Then, press SELECT button.



4 Select "TV" or "CATV"

Press CHANNEL ▲ or ▼ button repeatedly to point to "TV" or "CATV".

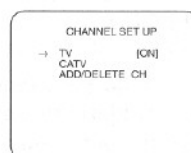

5 Begin channel preset

Press SELECT button once. After scanning, the tuner stops on the lowest memorized channel.

SETTING THE CLOCK

Set the clock accurately for proper automatic timer recording. We suggest that you use a TV or radio station as your time source.

In the example below, the clock is to be set to:

DATE 1st March, 1996
SETTING TIME 5:40PM

NOTE: You must use the remote control for this procedure.

Make sure ...

- VCR power must be turned on.
- Turn on the TV and set the TV channel to the same video output channel as located on the back of the VCR. (CH 3 or 4)
- Press TV/VCR button so that the TV/VCR indicator on the VCR comes on.

1 Select the main menu

Press MENU button.

2 Select "INITIALIZE"

Press CHANNEL ▲ or ▼ button repeatedly to point to "INITIALIZE".

Then, press SELECT button.

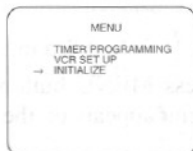

3 Select "SETTING CLOCK"

Press CHANNEL ▲ or ▼ button repeatedly to point to "SETTING CLOCK".

Then, press SELECT button.



Make sure ...

- If you did not set your desired digit within 2 seconds after pressing CHANNEL ▲ or ▼ button during steps [4] to [8], the input mode will forward to next step.
- When you press SELECT button after pressing CHANNEL ▲ or ▼ button during steps [4] to [8], you may forward to next step.
- Press ADD/DELETE button to go back one step from current step during steps [5] to [9].

4 Select the month

Press CHANNEL ▲ or ▼ button repeatedly until your desired month appears. (Example: March → 03)

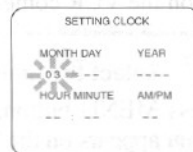

5 Select the day

Press CHANNEL ▲ or ▼ button repeatedly until your desired day appears. (Example: 1st → 01)



6 Select the year

Press CHANNEL ▲ or ▼ button repeatedly until your desired year appears. (Example: 1996)



7 Select the hour

Press CHANNEL ▲ or ▼ button repeatedly until your desired hour appears. (Example: 05)



8 Select the minute

Press CHANNEL ▲ or ▼ button repeatedly until the desired minute appears. (Example: 40)



9 Select "AM" or "PM"

Press CHANNEL ▲ or ▼ button repeatedly to point to "AM" or "PM". (Example: PM)



10 Start the clock

Press MENU or SELECT button.

Although seconds are not displayed, they begin counting from 00 when you press MENU or SELECT button. Use this feature to synchronize the clock with the correct time.

NOTES:

- When unplugging the AC-cord or if there is a power failure for more than 30 seconds, the TIMER indicator on the VCR flashes.
- If the display shows an abnormal reading or no reading, unplug the power cord for more than 30 seconds. Then plug it back in.

TO CHANGE CLOCK SETTING

If you want to change the clock,

- 1) Press MENU button.
- 2) Press CHANNEL ▲ or ▼ button repeatedly to point to "INITIALIZE".
Then, press SELECT button.
- 3) Press CHANNEL ▲ or ▼ button repeatedly to point to "SETTING CLOCK".
Then, press SELECT button.
- 4) Select a digit you want to change using SELECT button or ADD/DELETE button.
- 5) Enter correct numbers using CHANNEL ▲ or ▼ button.
- 6) Press MENU button to return to original mode.

SELECTING THE LANGUAGE

If you want to change the language on the TV screen, follow the steps below:

1 Select the main menu

Press MENU button.

2 Select "INITIALIZE"

Press CHANNEL ▲ or ▼ button repeatedly to point to "INITIALIZE".

Then, press SELECT button.

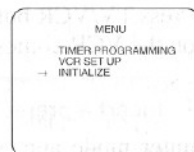

3 Select "LANGUAGE SELECT"

Press CHANNEL ▲ or ▼ button repeatedly to point to "LANGUAGE SELECT".

Then, press SELECT button.

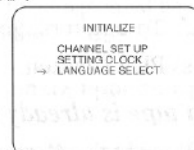

4 Select "ENGLISH" or "ESPAÑOL"

Select "ENGLISH" or "ESPAÑOL= Spanish" using CHANNEL ▲ or ▼ button.



5 Exit the Language select

Press MENU button to return to TV mode.

ON SCREEN DISPLAY

To check the Remain, Count, Clock and Channel number on the TV screen, press SELECT button.

Each time you press SELECT button, TV screen will change as the illustration:

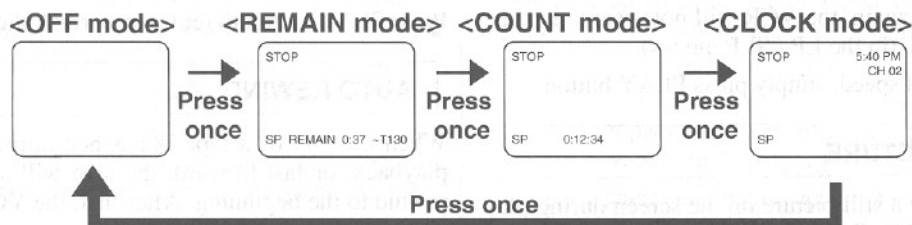

NORMAL PLAYBACK

Make sure ...

- Turn on the TV and set the TV channel to the same video output channel as located on the back of the VCR. (CH 3 or 4)
- Press TV/VCR button so that the TV/VCR indicator on the VCR comes on.

1 Insert a prerecorded tape

Counter mode appears at counter 0:00:00 on the TV screen. If the erase-protection tab has been removed, the VCR will start playback automatically.

2 To begin playback

Press PLAY button.

If a tape is already in the VCR

2A) Using button on the VCR

Just press PLAY button on the VCR. Power will automatically turn on and playback will start. (Direct Button Operation)

2B) Using button on the remote control

Press POWER button to turn on, and then press PLAY button on the remote control.

3 To stop playback

Press STOP button.

PICTURE SEARCH

This feature is useful in finding or skipping over a particular scene on a tape. In this mode, the sound will be muted.

- 1) You may view a video tape at a high speed in either a forward or reverse direction by pressing F.FWD or REWIND button. (in the SP / LP / SLP modes)
- 2) Depress it again, the VCR will now search in super high speed. (in the LP / SLP modes)
- 3) For normal speed, simply press PLAY button.

STILL PICTURE

You can view a still picture on the screen during playback (the Still mode). Press PAUSE/STILL button during playback. Press PLAY button to return to playback.

NOTE: If it is left in the Still mode for more than five minutes, the VCR will automatically switch to the Stop mode.

VERTICAL HOLD CONTROL

When the picture begins to vibrate vertically, stabilize the picture by pressing CHANNEL ▲ or ▼ button in the Still mode.

NOTES:

- When the picture is distorted or rolling vertically, adjust vertical hold control on your TV.
- Some latest TV's do not have a user adjustable vertical hold control.

TRACKING ADJUSTMENT

- Tracking adjustment will be set automatically (Digital TRacking function) when you start playback.

NOTE: The following function is controlled only by the buttons on the VCR.

- When playing pre-recorded tapes or tapes recorded on units other than your own, noise lines (black and white streaks) may appear on the playback picture. If this occurs, you can adjust the tracking control manually by pressing CHANNEL ▲ or ▼ button until the streaks disappear. To return to the DTR function, stop the tape once and start playback again.
- You can reduce the noise lines by pressing CHANNEL ▲ or ▼ button in slow mode, too. Slow tracking adjustment will not be set automatically.

Note: In Still mode, press SLOW button and press CHANNEL ▲ or ▼ button until the streaks disappear. To return to Still mode, press PAUSE/STILL button again.

SLOW MOTION

Press SLOW button to reduce the playback speed. The VCR mutes the sound during slow motion. You can control the speed by pressing F.FWD button (faster) or REWIND button (slower).

Press PLAY button to return to normal playback.

AUTO REWIND

When the end of a tape is reached during recording, playback, or fast-forward, the tape will automatically rewind to the beginning. After that, the VCR will eject the tape and turn itself off.

NOTES:

- The tape will not auto-rewind during timer recording or One Touch Recording.
- When the Counter Memory is activated, the tape will rewind to the 0:00:00 and the VCR will be in the Stop mode.

Make sure ...

- VCR power must be turned on.
- Turn on the TV and set the TV channel to the same video output channel as located on the back of the VCR. (CH 3 or 4)

AUTO REPEAT PLAYBACK

The VCR has the auto repeat function that allows you to repeat a tape indefinitely without touching the PLAY button.

- Insert a prerecorded tape.

1 Select the main menu

Press MENU button.

2 Select "VCR SET UP"

Press CHANNEL ▲ or ▼ button repeatedly to point to "VCR SET UP".

Then, press SELECT button.

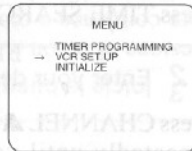

3 Select "REPEAT PLAY"

Press CHANNEL ▲ or ▼ button repeatedly to point to "REPEAT PLAY".

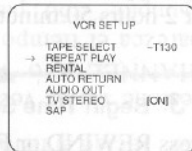

4 Begin Auto repeat playback

Press SELECT button so that [ON] will appear next to "REPEAT PLAY" on the TV screen.

Repeat playback will start automatically.

NOTES:

- Once you select the repeat play mode, it stays in effect even after you turn off the VCR.
- When the Counter Memory is activated, the tape will rewind to 0:00:00 and the VCR will be in the Stop mode.
- If the Rental mode is set [ON], the "RENTAL PLAY▶" display has priority.

TO STOP PLAYBACK

Press STOP button.

TO EXIT THE AUTO REPEAT MODE

Repeat steps [1] to [3]. Then, press SELECT button. [ON] will then disappear from the menu. Press MENU button to return to TV mode.

- Press TV/VCR button so that the TV/VCR indicator on the VCR comes on.
- You must use the remote control for the following procedure.

RENTAL PLAY

This function enables you to improve the picture quality when playing back worn cassettes such as those rented from a video shop.

- Insert rental tape into VCR and begin playback.

1 Select the main menu

Press MENU button **during playback**.

2 Select "VCR SET UP"

Press CHANNEL ▲ or ▼ button repeatedly to point to "VCR SET UP".

Then, press SELECT button.

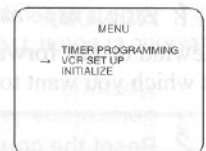

3 Select "RENTAL"

Press CHANNEL ▲ or ▼ button repeatedly to point to "RENTAL".

Then, press SELECT button.

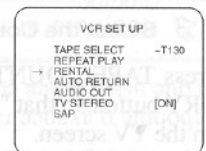

4 Select "RENTAL" to [ON]

Press SELECT button so that "RENTAL ON" will appear on the TV screen.

NOTES:

- Once you select the rental play mode, it stays in effect even after you turn off the VCR.
- Selecting ON or OFF must be done in the play mode only.

TO STOP PLAYBACK

Press STOP button.

TO EXIT THE RENTAL PLAY MODE

Repeat steps [1] to [3]. Then, press SELECT button so that "RENTAL OFF" appears on the TV screen.

Make sure ...

- VCR power must be turned on.
- Turn on the TV and set the TV channel to the same video output channel as located on the back of the VCR. (CH 3 or 4)

COUNTER MEMORY

This feature can be used to memorize a beginning point that you want to review. And you can search it easily by rewinding or fast forwarding.

- Insert a prerecorded tape.
- **If the counter is not displayed, the Counter Memory will not be activated. Press SELECT button so that the counter appears on the TV screen.**

1 Stop a tape at your desired point

Rewind or fast forward the tape to the beginning point at which you want to review.

2 Reset the counter to 0:00:00

Press TAPE COUNTER RESET button.

3 Select the Counter Memory mode

Press TAPE COUNTER MEMORY button so that "M" appears on the TV screen.



4 Begin recording or playback

Press RECORD or PLAY button.

Press STOP button when recording or playback is completed.

5 To activate the Counter Memory

Press REWIND (or F.FWD) button. The tape will automatically stop when the counter returns to 0:00:00 (approx.).

TO EXIT THE COUNTER MEMORY

When the counter appears on the TV screen, press TAPE COUNTER MEMORY button once and then the SELECT button twice so that the "M" and the counter disappears from the TV screen.

- Press TV/VCR button so that the TV/VCR indicator on the VCR comes on.
- You must use the remote control for the following procedure.
- A video cassette must be inserted in the VCR for these functions to work.

TIME SEARCH

The Time Search function makes it possible to quickly advance the tape to your desired position from any position by entering the exact amount of playback time of the part that you want to skip.

Example: To watch a program after 2 hour 50 minutes from present position to forward direction.

1 Select "TIME SEARCH" mode

Press TIME SEARCH button.

2 Enter your desired time

Press CHANNEL ▲ or ▼ button repeatedly until your desired time appears. (Example: "2:50" for 2 hours 50 minutes)

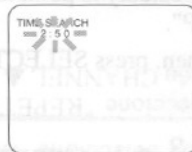

3 Begin Time Search

Press REWIND or F.FWD button. The VCR begins rewinding or fast forwarding to the specified point.

The time counts down as the searching progresses.

4 After Time Search

When 0:00 is reached, the VCR will start playback automatically.

NOTES:

- Time Search can be set up to 9 hours 59 minutes (9:59).
- This function will not operate in recording mode.
- Procedures must be followed within 30 seconds, from steps [1] to [2]. Otherwise the Time Search mode will be cancelled.
- Press STOP button to exit the Time Search mode.

INDEX SEARCH

This feature provides a method of indexing the starting point so that it can be easily returned to in either fast forward or rewind mode.

- The index mark will be made automatically when the RECORD button is pressed. It will also be marked at the starting point of Timer recording and OTR.
- The index mark is not recorded if the PAUSE/STILL button is pressed and released during recording.
- The time gap between making the index marks on the tape should be greater than 1 minute for SP recording, 2 minutes for LP recording and 3 minutes for SLP recording.

Example: You are watching program number 4 and want to fast forward to program number 7. You must skip three programs.

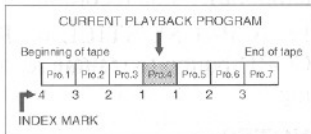

1 Select "INDEX SEARCH" mode

Press INDEX SEARCH button.

2 Enter your desired number

Press CHANNEL ▲ or ▼ button repeatedly until the number of programs that you want to skip appears. (Example: "03" for 3 programs)



3 Begin Index Search

Press REWIND or F.FWD button. The VCR begins rewinding or fast forwarding to the beginning of desired program.

Note: Every time an index signal is skipped, the number in the program indicator decreases by one.

4 After Index Search

When the preset program is reached, the VCR will start playback automatically.

NOTES:

- Index Search can be set up to 20.
- This function will not operate in recording mode.
- Procedures must be followed within 30 seconds, from steps [1] to [2]. Otherwise the Index Search mode will be cancelled.
- Press STOP button to exit the Index Search mode.

BLANK SEARCH

This function enables you to search for the unrecorded portion of the tape in the forward direction.

- Tape must be fully rewound.

1 Select "BLANK SEARCH" mode

Press BLANK SEARCH button. The VCR begins fast forwarding to the beginning of the blank part of the tape.



2 After Blank Search

The VCR will automatically stop.

Make sure ...

- VCR power must be turned on.
- Turn on the TV and set the TV channel to the same video output channel as located on the back of the VCR. (CH 3 or 4)
- Press TV/VCR button so that the TV/VCR indicator on the VCR comes on.

VIEWING AND RECORDING THE SAME PROGRAM

1 Select the channel to be recorded

Press number buttons on the remote control or the CHANNEL ▼ or ▲ button.



NOTE: When you record with a cable converter box, the VCR channel must be selected to 3 or 4 then the actual channel that you wish to record must be selected on the cable converter box.

2 Select the tape speed

Press TAPE SPEED button on the VCR to select the desired tape speed (SP/LP/SLP).



3 Begin recording

Press RECORD button. The REC indicator on the VCR comes on.



4 Stop recording

Press STOP button when recording is completed.

SKIPPING SOME MATERIALS DURING RECORDING

Press PAUSE/STILL button to temporarily stop recording.



Press PAUSE/STILL or RECORD button to resume recording.

NOTES:

- To prevent tape damage, after five minutes, the VCR will automatically switch to the Stop mode. You may review the time remaining with "■" marks on the TV screen. Each "■" mark shows one minute.
- To edit an unwanted segment from the already recorded portion of tape, press and hold REWIND button during the Pause mode until you have reached the beginning of the unwanted segment. (If you rewind past the beginning of the unwanted segment, press and hold F.FWD button during the Pause mode until you have reached it.) (Edit Search)

RECORDING ONE PROGRAM WHILE VIEWING ANOTHER

You can record one program while viewing another. To start recording, follow steps [1] to [3] under "VIEWING AND RECORDING THE SAME PROGRAM".

NOTE: When you record with a cable converter box, you cannot record one program while viewing another.

4 Select the TV mode

Press TV/VCR button to select TV so that the TV/VCR indicator on the VCR *disappears*.

5 Select the channel on the TV

Set the TV to the channel you want to watch.

TO MONITOR THE PROGRESS OF YOUR RECORDING

1 Select the VCR mode

Press TV/VCR button so that the TV/VCR indicator on the VCR comes on.

2 Select channel 3 or 4 on the TV

Turn on the TV and set the TV channel to the same video output channel as located on the back of the VCR. (CH3 or 4)

OTR (One Touch Recording)

This function enables you to set a recording length simply by pressing REC/OTR button on the VCR.

NOTE: This function cannot be done by the remote control.

Make sure ...

- VCR power must be turned on.
- Turn on the TV and set the TV channel to the same video output channel as located on the back of the VCR. (CH3 or 4)
- Press TV/VCR button so that the TV/VCR indicator on the VCR comes on.
- Insert a cassette tape with its erase prevention tab in place. (If necessary, rewind or fast forward the tape to the point at which you want to begin recording.)

PUSH(ES)	DISPLAY	RECORDED LENGTH
1 push	(normal recording)	
2 pushes	0:30	30 minutes
3 pushes	1:00	60 minutes
↓	↓	↓
17 pushes	8:00	480 minutes
18 pushes	(normal recording)	

1 Select the channel to be recorded

Press number buttons on the remote control or the CHANNEL ▼ or ▲ button.

2 Begin OTR

Press REC/OTR button on the VCR as many times as needed. The recording length will be determined by the number of times you press REC/OTR button.

Each additional push will increase the recording time by 30 minutes. It is set up to 8 hours.

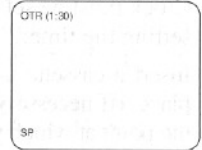

NOTES:

- Recording starts immediately when the REC/OTR button is pressed, whether you are watching the same or a different channel.
- When REC/OTR button is pressed 18 times, the VCR returns to the normal recording mode.
- To stop the OTR operation, press STOP button on the VCR or on the remote control.
- To show the remaining time, press SELECT button so that "OTR" appears on the TV screen.
- Recording stops when 0:00 is reached.
- Please note that in the SLP mode maximum recording time, assuming the tape is started at the beginning, is 8 hours using T-160 (or 6 hours using T-120).
- The TV that is connected to your VCR may be turned on or off during OTR.
- If the tape runs out before the end time, the VCR will switch to the Stop mode immediately, eject the tape and the VCR power will be turned off.

TIMER RECORDING

AUTOMATIC TIMER RECORDING

You may set the VCR to start and end a recording while you are away. You can set seven programs to record on specific days, daily or weekly within a 1 year period.

In the example below, the timer is being set to record:

DATE: 6th May, 1996
SETTING TIME: from 7:30PM to 8:30PM
CHANNEL: CH16
TAPE SPEED: SP
PROGRAM NO: No. 1

NOTE: You must use the remote control for this procedure.

Make sure ...

- VCR power must be turned on to program it.
- Turn on the TV and set the TV channel to the same video output channel as located on the back of the VCR. (CH3 or 4)
- Press TV/VCR button so that the TV/VCR indicator on the VCR comes on.
- Clock must be set to the correct time and date before setting the timer.
- Insert a cassette tape with its erase prevention tab in place. (If necessary, rewind or fast forward the tape to the point at which you want to begin recording.)

Avoid overlap of programs ...

There is a case that a program will not be performed. When programs overlap:

- The program that the start time is set earliest has priority.
- When the earliest program has finished and the programs which should start still overlap, the recording will start in order of the program number.
- If you programmed as the illustration, the timer recording would be carried out as follows (shaded part is the carried period):

9:00AM - 10:00AM for PROGRAM 2
10:00AM - for PROGRAM 1

1 Select the main menu

Press MENU button.

2 Select "TIMER PROGRAMMING"

Press CHANNEL ▲ or ▼ button to point to "TIMER PROGRAMMING".

Then, press SELECT button.

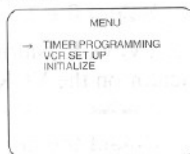

NOTE: If you have not yet set the clock, "SETTING CLOCK" appears. If so, follow the steps [4] to [10] on pages 16, 17. Then, set the timer recording.

3 Select your desired program number (1-7)

Program number which is not set up flashes.

Press CHANNEL ▲ or ▼ button repeatedly until your desired program number appears. (Example: 1)

Then, press SELECT button.

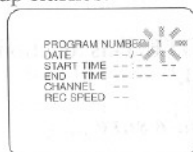

4 Select once, daily or weekly recording

For once recording :

Press CHANNEL ▼ or ▲ button repeatedly to point to "ONCE". Then, press SELECT button.

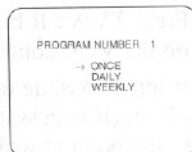

For daily recording : To record a TV program at the same time on the same channel every day. (Example: Monday through Sunday)

Press CHANNEL ▼ or ▲ button repeatedly to point to "DAILY". Then, press SELECT button.



For weekly recording : To record a TV program at the same time on the same channel every week. (Example: every Monday on channel 7 at 5:00PM)

Make sure ...

- If you did not set your desired digit within 2 seconds after pressing CHANNEL ▲ or ▼ button during steps [5] to [8], the input mode will forward to next step.
- When you press SELECT button after pressing CHANNEL ▲ or ▼ button during steps [5] to [8], you may forward to next step.
- Press ADD/DELETE button to go back one step from current step during steps [3] to [9].

5 Set the date when you want to start

First, press CHANNEL ▲ or ▼ button repeatedly until your desired month appears. (Example: "05" for May)

Next, enter a date. (Example: "06" for 6th)

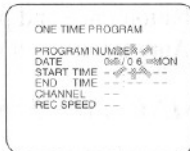

6 Set the start time

First, press CHANNEL ▲ or ▼ button repeatedly until your desired hour appears. (Example: 07)

Next, enter a minute. (Example: 30)

Then, press CHANNEL ▲ or ▼ button to point to AM or PM. (Example: PM)

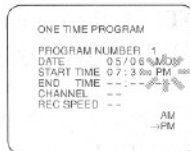

7 Set the end time

First, press CHANNEL ▲ or ▼ button repeatedly until your desired hour appears. (Example: 08)

Next, enter a minute. (Example: 30)

Then, press CHANNEL ▲ or ▼ button to point to AM or PM. (Example: PM)

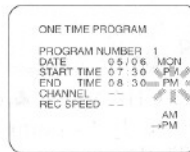

8 Set the channel number

Press CHANNEL ▲ or ▼ button repeatedly until your desired channel number appears. (Example: 16)



9 Set the tape speed

Press CHANNEL ▲ or ▼ button repeatedly until your desired tape speed appears. (Example: SP)



- "AUTO" is available only with Program No. 1.
See "Just-In Time Recording" on page 27 for the use of "AUTO" setting.

10 Exit the program mode

Press MENU button. Program 1 is now completed.

To set another program, repeat steps [1] to [10].

11 Set the timer

Press POWER/TIMER REC button. The TIMER indicator on the VCR comes on.

TO CORRECT AN AUTOMATIC TIMER PROGRAM

If you want to correct an automatic timer after you finished setting program,

- 1) Repeat steps [1] to [3] on previous page.
- 2) Select a digit you want to change using SELECT button or ADD/DELETE button.
- 3) Enter correct numbers using CHANNEL ▲ or ▼ button.
- 4) Press MENU button to return to original mode.
- 5) Press POWER button to return to timer stand-by mode.

TO STOP AN AUTOMATIC TIMER PROGRAM WHICH HAS ALREADY STARTED

Press STOP/EJECT button on the VCR.

NOTE: STOP button on the remote control will not function in the Automatic Timer Recording mode.

TO CANCEL OR CHECK THE START/END TIME

- 1) Repeat steps [1] and [2] on previous page.
- 2) Select a program number you want to check using CHANNEL ▲ or ▼ button. The details of selected program appears on the TV screen.
You may cancel the entire program by pressing ADD/DELETE button.

HINTS FOR TIMER RECORDING

- If there is a power failure or the VCR is unplugged for more than 30 seconds, the clock setting and all timer settings are lost.
- If the tape runs out before the end time, the VCR will switch to the Stop mode immediately, eject the tape and the VCR power will be turned off. The **TIMER** indicator will flash.
- If a tape is not inserted or the erase-protection tab is removed, the **TIMER** indicator flashes and automatic timer recording cannot occur. Insert a tape that allows recording.
- The TV that is connected to your VCR may be turned ON or OFF when the VCR is in the timer-record mode.
- When you record a cable channel program with cable converter box, first set the VCR's channel to 3 or 4 whichever is the output channel of your cable converter box. Then set your cable converter box to the channel you want to record and leave on while you are recording with power on.

AUTO RETURN

USING THE AUTO RETURN BUTTON

After recording the program(s) by using the timer, you can return to the beginning of the program(s) automatically by pressing the **AUTO RETURN** button.

1 Start Auto Return

When all the timer recordings are completed (**TIMER** indicator flashes), press **AUTO RETURN** button on the VCR *at once*. The VCR will rewind to the beginning of the recorded program(s).

NOTE: If there are any remaining programs, press **POWER** button to turn on, then press **AUTO RETURN** button. But In this case, if you press any other button once and press **AUTO RETURN** button, the Auto Return will not be done.

USING THE MAIN MENU

If you select auto return to [AUTO] from the menu, when all the timer recordings are completed, the VCR will rewind to the beginning of the recorded program(s) **without pressing AUTO RETURN button**.

NOTE: If there are any remaining programs including Daily & Weekly, this function does not be done.

1 Select the main menu

Press **MENU** button.

2 Select "VCR SET UP"

Press **CHANNEL ▲** or **▼** button repeatedly to point to "VCR SET UP".

Then, press **SELECT** button.

3 Select "AUTO RETURN"

Press **CHANNEL ▲** or **▼** button repeatedly to point to "AUTO RETURN".

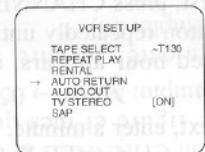

4 Select "AUTO RETURN" to [AUTO]

Press **SELECT** button so that [AUTO] will appear next to "AUTO RETURN".

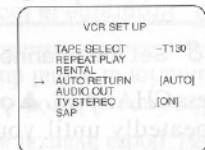

5 To return to TV mode

Press **MENU** button.

WATCH THE RECORDED PROGRAM

Press **PLAY** button.

JUST-IN TIME RECORDING

This function allows you to fully utilize the available tape length for timer recording. The VCR calculates the remaining tape amount and then adjusts the tape speed from SP to SLP as needed.

If it is suspected that the end of the tape will be reached before the reserved program ends (as long as SP mode is kept all the way), set recording mode to AUTO. This function is available only with Program No. 1 (Timer Recording).

The auto mode starts recording in SP mode. The internal circuit compares the rest of the program against the available tape length. If the internal circuit determines that the available tape is not long enough to record the program in the SP mode, the Recording mode is automatically changed to SLP mode. This will assure coverage of the desired timer program before the end of the tape is reached.

Conventional Video Recording

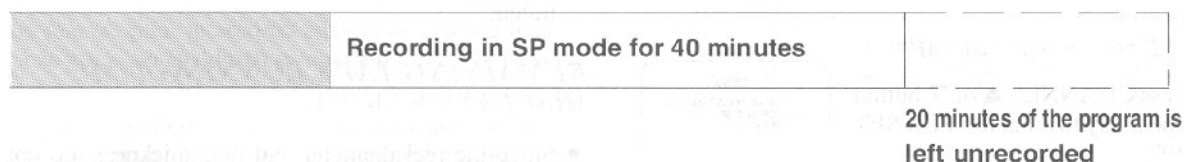

Just-in Time Recording

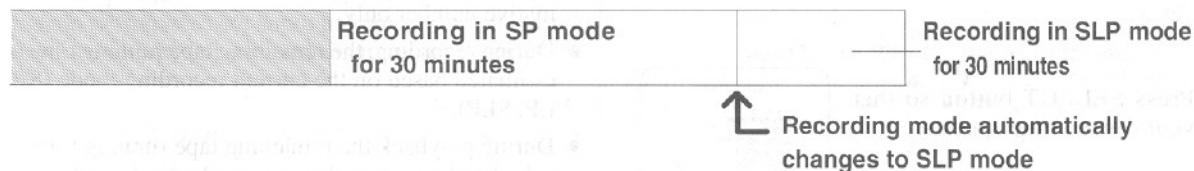

Notes:

- Set the tape remainder switch ("~T60", "~T130" or "T140~") to the tape loaded. See "Setting the Remaining Time" on next page.
- Even if SLP mode is selected, just-in time recording cannot compensate for a tape length which may be too short.
- A momentary picture break up will occur at the point on the tape when the recording speed changes from SP to SLP.
- The displayed remaining tape running time may not always match the actual remaining time on the tape (usually longer than the actual time). It is recommended to set the end of the reserved recording time several minutes after the end of the TV program.

SETTING THE REMAINING TIME

You can set the remaining tape running time of your tape. Follow the steps below to correct the tape remaining indication.

Make sure ...

- VCR power must be turned on.
- Turn on the TV and set the TV channel to the same video output channel as located on the back of the VCR. (CH 3 or 4)
- Press TV/VCR button so that the TV/VCR indicator on the VCR comes on.
- You must use the remote control for the following procedure.
- A video cassette must be inserted in the VCR for this function to work.

1 Select the main menu

Press MENU button.

2 Select "VCR SET UP"

Press CHANNEL ▲ or ▼ button repeatedly to point to "VCR SET UP".

Then, press SELECT button.

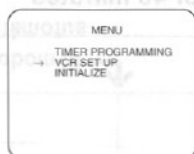

3 Select "~T60", "~T130" or "T140~"

Press SELECT button so that your desired time appears.

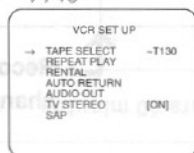

Selection	Your cassette tape length
~T60	60 minutes or less
~T130	61 ~ 130 minutes
T140~	140 minutes or greater

For example, the popular T-120 cassette tape calls for the "~T130" selection.

4 Exit the preset mode

Press MENU button to return to TV mode.

5 To check the remain time

Press SELECT button until RE-MAIN appears on TV screen.



Note:

- In the Remain Time Mode calculating will start when the cassette tape is inserted and PLAY button is pressed.
- While calculating, the TV screen shows as illustrated.

REMAINING TAPE RUNNING TIME DISPLAY

- Since the reel diameter and tape thickness are not common to all cassettes, the time count differs from cassette to cassette. Use the time display as an informative number only.
- During recording, the remaining tape running time is estimated based on the current recording mode (SP, LP, SLP).
- During playback the remaining tape running time is calculated based on the current playback mode.
- Remain time will not appear on TV screen while in the Fast forward or Rewind Mode.
- There will be a delay of up to 1 minute before the remain time appears on the TV display.

Note:

The use of the following tapes will result in difference between the displayed remaining time and actual time to the end of the tape:

- Tape housed in a VHS-C cassette adapter.
- Shorter tape length such as a 10-minute cassette
- T-180 cassette. In this case the display may read 2 Hours, 40 Minutes at the start point of the tape in SP mode.

COPYING A VIDEO TAPE

Connect the Funai/Symphonic editing (recording) VCR, source (playing) VCR and your TV using the following diagram.

NOTES:

- You can use the audio and video input jacks on the front panel of the Funai/Symphonic editing (recording) VCR instead of using jacks on the back.
- When you connect the monaural VCR(another source) to this VCR, connect the Audio output jack of the monaural VCR(another source) to the AUDIO IN L jack of this VCR. The audio signal will be recorded in both L and R channel equally.

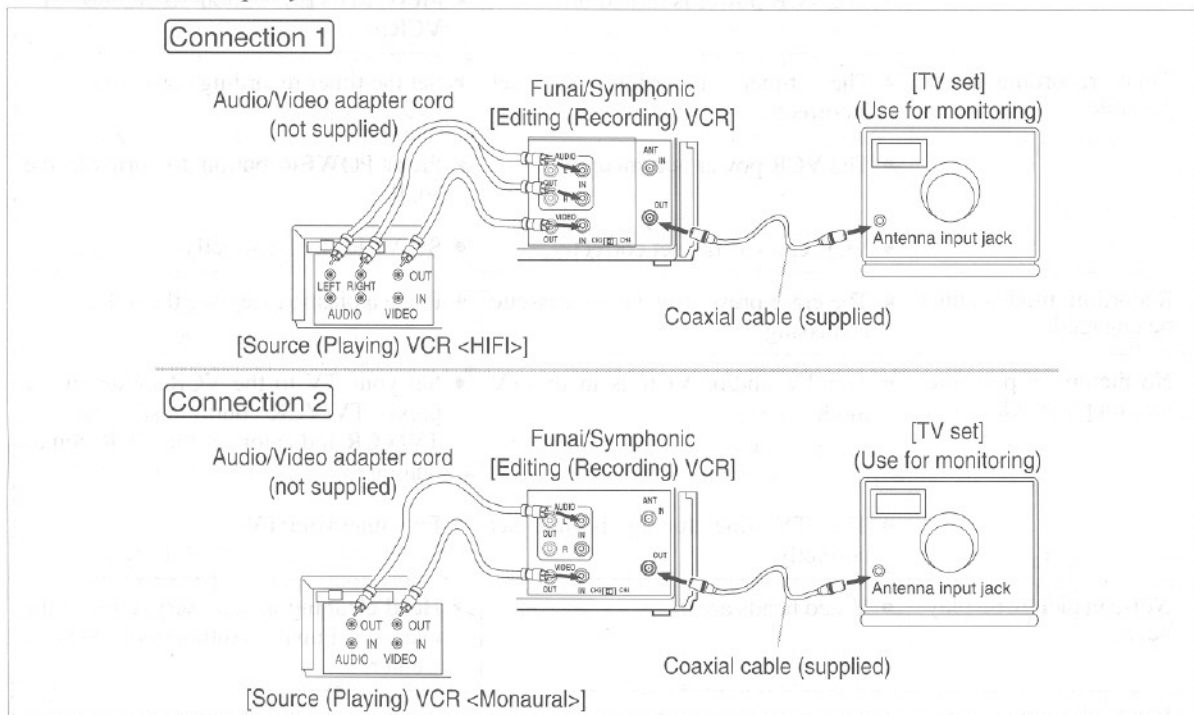

- 1) Insert a pre-recorded video cassette into the source(playing) VCR.
- 2) Insert a blank video cassette, or one you want to record over, into the Funai/Symphonic editing(recording) VCR cassette compartment.
- 3) Press TAPE SPEED button on the Funai/Symphonic editing(recording) VCR to select the desired recording speed (SLP, LP or SP).
- 4) Select L1 or L2 position on the Funai/Symphonic editing(recording) VCR. See page 11, under "Input Select".
- 5) Press REC button on the Funai/Symphonic editing (recording) VCR.
- 6) Begin playback of the tape in the source(playing) VCR.

NOTES:

- For best results during dubbing, use the VCR's front panel controls whenever possible. The remote control might affect the playback VCR's operation.
- Always use video-quality shielded cables with RCA-type connectors. Standard audio cables are not recommended.
- You can use a video disc player, satellite receiver, or other audio/video component with A/V outputs in place of the playback VCR.

TO MONITOR THE RECORDING

- 1) Turn on the TV, and set it to the same output channel as the Funai/Symphonic editing(recording) VCR channel 3 or 4.
- 2) Press TV/VCR button on the Funai/Symphonic editing VCR so that the TV/VCR indicator on the VCR comes on.

TROUBLESHOOTING GUIDE

If you have followed the instructions contained in this manual and have difficulty in operating your VCR, locate the SYMPTOM in the left column below. Check the corresponding POSSIBLE CAUSE and CORRECTIVE ACTION columns to remedy the problem.

SYMPTOM	POSSIBLE CAUSE	CORRECTIVE ACTION
No power.	<ul style="list-style-type: none"> • Power cord is not connected. • The VCR power is turned off. 	<ul style="list-style-type: none"> • Connect power cord to AC outlet. • Press POWER button to turn on the VCR.
Timer recording is not possible.	<ul style="list-style-type: none"> • The timer recording is set incorrectly. • The VCR power is turned on. • VCR clock is not set correctly. 	<ul style="list-style-type: none"> • Set the timer recording correctly. • Press POWER button to turn off the VCR. • Set VCR clock correctly.
Recording mode cannot be engaged.	<ul style="list-style-type: none"> • The erase prevention tab on cassette is missing. 	<ul style="list-style-type: none"> • Place a plastic tape over the hole.
No picture or poor picture on playback.	<ul style="list-style-type: none"> • The TV and/or VCR is in the TV mode. • The TV fine tuning is not set correctly. 	<ul style="list-style-type: none"> • Set your TV to the VCR mode and/or press TV/VCR button so that the TV/VCR indicator on the VCR comes on. • Fine tune your TV.
Noise in picture on playback.	<ul style="list-style-type: none"> • Video heads are dirty. 	<ul style="list-style-type: none"> • Head cleaning is necessary, consult the nearest Funai Authorized Service Center.
Playback picture is partially noisy.	<ul style="list-style-type: none"> • The tracking control is not set correctly. 	<ul style="list-style-type: none"> • Adjust tracking control for a better picture.
On-the-air TV programs cannot be seen.	<ul style="list-style-type: none"> • Connections are not correctly made. • The TV and/or VCR is in VCR mode. 	<ul style="list-style-type: none"> • Re-check the ANT. IN and ANT. OUT connections. • Set your TV to the TV mode and/or press TV/VCR button so that the TV/VCR indicator on the VCR disappears.
No operation by infrared Remote Control.	<ul style="list-style-type: none"> • Weak batteries. 	<ul style="list-style-type: none"> • Check the batteries in the remote control.
Operation buttons do not work after there is a power failure or you move your VCR.	<ul style="list-style-type: none"> • Channel Memory Programming is required because programmed channels are erased. 	<ul style="list-style-type: none"> • See "NOTES" under "AUTOMATIC CHANNEL PRESET" on page 14.

Free Manuals Download Website

<http://myh66.com>

<http://usermanuals.us>

<http://www.somanuals.com>

<http://www.4manuals.cc>

<http://www.manual-lib.com>

<http://www.404manual.com>

<http://www.luxmanual.com>

<http://aubethermostatmanual.com>

Golf course search by state

<http://golfingnear.com>

Email search by domain

<http://emailbydomain.com>

Auto manuals search

<http://auto.somanuals.com>

TV manuals search

<http://tv.somanuals.com>