



If you need additional operating assistance after reading this owner's manual or to order replacement accessories, please call TOLL FREE : 1-800-242-7158.

WARNING: TO REDUCE THE RISK OF FIRE OR ELECTRIC SHOCK, DO NOT EXPOSE THIS APPLIANCE TO RAIN OR MOISTURE.



CAUTION: TO REDUCE THE RISK OF ELECTRIC SHOCK, DO NOT REMOVE COVER (OR BACK). NO USER SERVICEABLE PARTS INSIDE. REFER SERVICING TO QUALIFIED SERVICE PERSONNEL.

The caution marking is located on the rear of the cabinet.



The lightning flash with arrowhead symbol, within an equilateral triangle, is intended to alert the user to the presence of uninsulated "dangerous voltage" within the product's enclosure that may be of sufficient magnitude to constitute a risk of electric shock to persons.



The exclamation point within an equilateral triangle is intended to alert the user to the presence of important operating and maintenance (servicing) instructions in the literature accompanying the product.

IMPORTANT SAFEGUARDS

- 1. Read Instructions-** All the safety and operating instructions should be read before the appliance is operated.
- 2. Retain Instructions-** The safety and operating instructions should be retained for future reference.
- 3. Heed Warnings-** All warnings on the appliance and in the operating instructions should be adhered to.
- 4. Follow Instructions-** All operating and use instructions should be followed.
- 5. Cleaning-** Unplug this video product from the wall outlet before cleaning. Do not use liquid cleaners or aerosol cleaners. Use a damp cloth for cleaning.
EXCEPTION: A product that is meant for uninterrupted service and, that for some specific reason, such as the possibility of the loss of an authorization code for a CATV converter, is not intended to be unplugged by the user for cleaning or any other purpose, may exclude the reference to unplugging the appliance in the cleaning description otherwise required in item 5.
- 6. Attachments-** Do not use attachments not recommended by the video product manufacturer as they may cause hazards.
- 7. Water and Moisture-** Do not use this video product near water, for example, near a bath tub, wash bowl, kitchen sink, or laundry tub, in a wet basement, or near a swimming pool, and the like.
- 8. Accessories-** Do not place this video product on an unstable cart, stand, tripod, bracket, or table. The video product may fall, causing serious injury to a child or adult, and serious damage to the appliance. Use only with a cart, stand, tripod, bracket, or table recommended by the manufacturer, or sold with the video product. Any mounting of the appliance should follow the manufacturer's instructions and should use a mounting accessory recommended by the manufacturer. An appliance and cart combination should be moved with care. Quick stops, excessive force, and uneven surfaces may cause the appliance and cart combination to overturn.
PORTABLE CART WARNING (Symbol provided by IEC/ENEC) S3125A
- 9. Ventilation-** Slots and openings in the cabinet are provided for ventilation and to ensure reliable operation of the video product and to protect it from overheating, and these openings must not be blocked or covered. The openings should never be blocked by placing the video product on a bed, sofa, rug, or other similar surface. This video product should not be placed in a built-in installation such as a bookcase or rack unless proper ventilation is provided or the manufacturer's instructions have been adhered to.
- 10. Power Sources-** This video product should be operated only from the type of power source indicated on the marking label. If you are not sure of the type of power supply to your home, consult your appliance dealer or local power company. For products intended to operate from battery power, or other sources, refer to the operating instructions.
- 11. Grounding or Polarization-** This video product is equipped with a polarized alternating-current line plug (a plug having one blade wider than the other). This plug will fit into the power outlet only one way. This is a safety feature. If you are unable to insert the plug fully into the outlet, try reversing the plug. If the plug should still fail to fit, contact your electrician to replace your obsolete outlet. Do not defeat the safety purpose of the polarized plug.
- 12. Power Cord Protection-** Power supply cords should be routed so that they are not likely to be walked on or pinched by items placed upon or against them, paying particular attention to cords at plugs, convenience receptacles, and the point where they exit from the appliance.
- 13. Outdoor Antenna Grounding-** If an outside antenna or cable system is connected to the video product, be sure the antenna or cable system is grounded so as to provide some protection against voltage surges and built-up static charges. Article 810 of the National Electrical Code, ANSI/NFPA No. 70, provides information with regard to proper grounding of the mast and supporting structure, grounding of the lead-in wire to an antenna discharge unit, size of grounding conductors, location of antenna-discharge unit, connection to grounding electrodes, and requirements for the grounding electrode. (Fig. A)

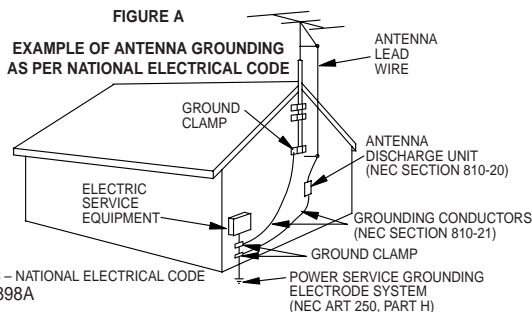

- 14. Lightning-** For added protection for this video product during a lightning storm, or when it is left unattended and unused for long periods of time, unplug it from the wall outlet and disconnect the antenna or cable system. This will prevent damage to the video product due to lightning and power-line surges.
- 15. Power Lines-** An outside antenna system should not be located in the vicinity of overhead power lines or other electric light or power circuits, or where it can fall into such power lines or circuits. When installing an outside antenna system, extreme care should be taken to keep from touching such power lines or circuits as contact with them might be fatal.
- 16. Overloading-** Do not overload wall outlets and extension cords as this can result in a risk of fire or electric shock.
- 17. Object and Liquid Entry-** Never push objects of any kind into this video product through any openings as they may touch dangerous voltage points or short-out parts that could result in a fire or electric shock. Never spill liquid of any kind on the video product.
- 18. Servicing-** Do not attempt to service this video product yourself as opening or removing covers may expose you to dangerous voltage or other hazards. Refer all servicing to qualified service personnel.
- 19. Damage Requiring Service-** Unplug this video product from the wall outlet and refer servicing to qualified service personnel under the following conditions:
 - a. When the power-supply cord or plug is damaged.
 - b. If liquid has been spilled, or objects have fallen into the video product.
 - c. If the video product has been exposed to rain or water.
 - d. If the video product does not operate normally by following the operating instructions. Adjust only those controls that are covered by the operating instructions as an improper adjustment of other controls may result in damage and will often require extensive work by a qualified technician to restore the video product to its normal operation.
 - e. If the video product has been dropped or damaged in any way.
 - f. When the video product exhibits a distinct change in performance-this indicates a need for service.
- 20. Replacement Parts-** When replacement parts are required, be sure the service technician has used replacement parts specified by the manufacturer or have the same characteristics as the original part. Unauthorized substitutions may result in fire, electric shock or other hazards.
- 21. Safety Check-** Upon completion of any service or repairs to this video product, ask the service technician to perform safety checks to determine that the video product is in proper operating condition.
- 22. Heat-** This video product should be situated away from heat sources such as radiators, heat registers, stoves, or other products (including amplifiers) that produce heat.

PRECAUTIONS

INSTALL LOCATION

For safety and optimum performance of your VCR:

- Install the VCR in a horizontal and stable position. Do not place anything directly on top of the VCR. Do not place the VCR directly on top of the TV.
- Shield it from direct sunlight and keep it away from sources of intense heat. Avoid dusty or humid places. Avoid places with insufficient ventilation for proper heat dissipation. Do not block the ventilation holes on the sides of the VCR. Avoid locations subject to strong vibration or strong magnetic fields.

AVOID THE HAZARDS OF ELECTRICAL SHOCK AND FIRE

- Do not handle the power cord with wet hands.
- Do not pull on the power cord when disconnecting it from AC wall outlet. Grasp it by the plug.
- If, by accident, water is spilled on your VCR, unplug the power cord immediately and take the unit to our Authorized Service Center for servicing.
- Do not put your fingers or objects into the VCR cassette holder.

MOISTURE CONDENSATION WARNING

Moisture condensation may occur inside the unit when it is moved from a cold place to a warm place, or after heating a cold room or under conditions of high humidity. Do not use the VCR at least for 2 hours until its inside is dry.

FCC WARNING

This equipment may generate or use radio frequency energy. Changes or modifications to this equipment may cause harmful interference unless the modifications are expressly approved in the instruction manual. The user could lose the authority to operate this equipment if an unauthorized change or modification is made.

IMPORTANT COPYRIGHT INFORMATION

Unauthorized recording or use of broadcast television programming, video tape, film or other copyrighted material may violate applicable copyright laws. We assume no responsibility for the unauthorized duplication, use, or other acts which infringe upon the rights of copyright owners.

A NOTE ABOUT RECYCLING

This product's packaging materials are recyclable and can be reused. Please dispose of any materials in accordance with your local recycling regulations. Batteries should never be thrown away or incinerated but disposed of in accordance with your local regulations concerning chemical wastes.

Note to the Cable TV System Installer:

This reminder is provided to call the Cable TV system installer's attention to Article 820-40 of the National Electrical Code, which provides guidelines for proper grounding – in particular, specifying that the cable ground shall be connected to the grounding system of the building, as close to the point of cable entry as possible.

CAUTION:
TO PREVENT ELECTRIC SHOCK, MATCH WIDE BLADE OF PLUG TO WIDE SLOT, FULLY INSERT.

ATTENTION:
POUR ÉVITER LES CHOC ÉLECTRIQUES, INTRODUIRE LA LAME LA PLUS LARGE DE LA FICHE DANS LA BORNE CORRESPONDANTE DE LA PRISE ET POUSSER JUSQU'AU FOND.

DESCRIPTION OF CONTROLS

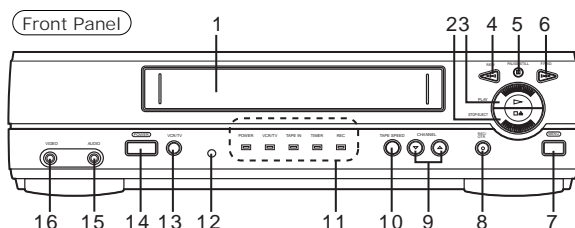

- | | |
|-------------------------|-----------------------|
| 1. Cassette Compartment | 9. CHANNEL buttons |
| 2. STOP/EJECT button | 10. TAPE SPEED button |
| 3. PLAY button | 11. Display Window |
| 4. REW button | 12. Remote Sensor |
| 5. PAUSE/STILL button | 13. VCR/TV button |
| 6. F.FWD button | 14. POWER button |
| 7. MENU button | 15. AUDIO Input jack |
| 8. REC/OTR button | 16. VIDEO Input jack |

Display Window

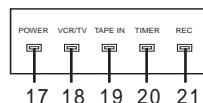

- | | |
|-----------------------|---------------------|
| 17. POWER indicator | 20. TIMER indicator |
| 18. VCR/TV indicator | 21. REC indicator |
| 19. TAPE IN indicator | |

Rear Panel

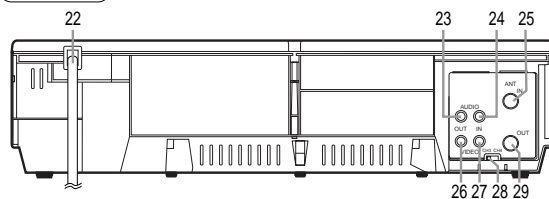

- | | |
|--------------------|-----------------------------|
| 22. AC Power Cord | 26. VIDEO OUT jack |
| 23. AUDIO OUT jack | 27. VIDEO IN jack |
| 24. AUDIO IN jack | 28. CH3/CH4 selector switch |
| 25. ANT. IN jack | 29. ANT. OUT jack |

Remote Control

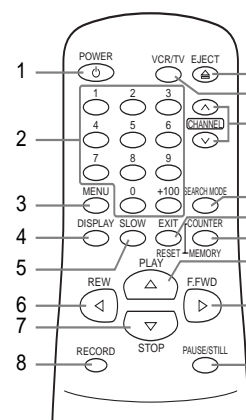

- | |
|---------------------------|
| 1. POWER button |
| 2. NUMBER buttons |
| 3. MENU button |
| 4. DISPLAY button |
| 5. SLOW button |
| 6. REW button |
| 7. STOP button |
| 8. RECORD button |
| 9. PAUSE/STILL button |
| 10. F.FWD button |
| 11. PLAY button |
| 12. COUNTER/MEMORY button |
| 13. EXIT/RESET button |
| 14. SEARCH MODE button |
| 15. CHANNEL (∧/∨) buttons |
| 16. VCR/TV button |
| 17. EJECT button |

To insert the batteries

Install two AA batteries matching the polarity indicated inside the battery compartment.

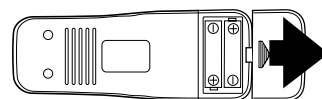

PREPARATION FOR USE

1 Check contents

Make sure the package contains all of the accessories listed in "as below".

SUPPLIED ACCESSORIES

ACCESSORIES	PART NO.
Coaxial Cable	WPZ0901TM002
Remote Control Unit	NA301UD/NA351UD
Batteries	AA x 2

2 Situate VCR

Place the VCR in a stable, horizontal surface.

3 Connect VCR to TV

VCR to TV Connection

1. Disconnect the AC power cord of the TV from the AC outlet.
2. Disconnect the antenna or cable from the TV.
3. Connect the antenna or cable to the ANT. IN jack of the VCR.
4. Connect the VCR to the TV using the coaxial cable.
5. Plug the AC power cords of the VCR and TV into the AC outlets.

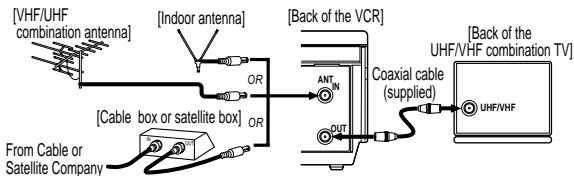

VCR to AV TV connection using AUDIO/VIDEO Cables

Using Optional AUDIO/ VIDEO Output Jacks

With this connection, you can get better pictures and sounds when playing back a tape if your TV has A/V Input jacks. Please refer to your TV's owner's manual.

Using AUDIO/VIDEO Input Jacks

You can use the A/V input jacks on the front or the back of the VCR.

- To use the input jacks on the back of the VCR, select "L1" position by pressing [0], [0], [1] on the remote control or [CHANNEL (Λ/∨)].
- To use the input jacks on the front of the VCR, select "L2" position by pressing [0], [0], [2] on the remote control or [CHANNEL (Λ/∨)].

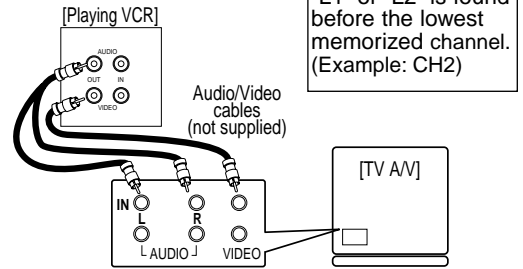

SETTING THE CH3/CH4 SWITCH

If your TV does not have A/V terminals:

When the VCR is in the Playback mode or when the VCR is in the VCR mode, your TV will receive signals from the VCR on either channel 3 or 4. To use the VCR with your TV, set the selector switch to CH3 or CH4 (which is located in the back of your VCR), whichever is not used for normal broadcasts in your area. Then set your TV to the same channel.

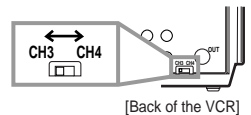

SETUP

AUTOMATIC CHANNEL SET UP

You can automatically program the tuner to scan only the channels you receive in your area.

- Channel memory programming is NOT needed when you connected the VCR to a cable box or satellite box as in "Connect VCR to TV". In this case, select the VCR and TV to channel 3 or 4 the same channel as the CH3 or CH4 switch on the back of the VCR. Then, the channel you want to record or view may be selected at the cable box or satellite box.
- Follow the steps below once. Repeat it only if there is a power failure or if the VCR is unplugged for more than 30 seconds. (In these cases, the programmed channels are erased.)
- You must follow the steps below before attempting to play or record a video tape. If you want to play or record a video tape **BEFORE** programming the tuner, you can cancel it by pressing [EXIT/RESET].

1 You need to connect the antenna or cable to the VCR first. Then, connect the VCR power plug into a standard AC outlet.

2 Turn on the TV and set the TV to channel 3 or 4. Now set the CH3/CH4 switch on the back of the VCR to match the channel selected on the TV.

3 Turn on the VCR by pressing [POWER]. It comes on that both the POWER and the VCR/TV indicator.

4 Select the On Screen Language ("ENGLISH" or "ESPAÑOL")

by pressing [PLAY] or [STOP]. Then, press [F.FWD].

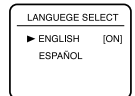

5 Begin channel preset

by pressing [F.FWD] once. The tuner scans and memorizes all active channels in your area.

- The VCR distinguishes between standard TV channels and cable channels.

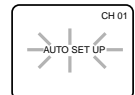

6 After scanning,

the tuner stops on the lowest memorized channel. The TV screen returns to TV mode.

- If "AUTO SET UP" appears on the TV screen again, check the cable connections. Press [F.FWD] once again and the VCR will begin preset again.

TO SELECT A DESIRED CHANNEL

You can select the desired channel by using [CHANNEL (Λ/∨)] or directly pressing [Number] on the remote control.

Note for using the Number buttons:

- When selecting cable channels which are higher than 99, press [+100] first, then press the last two digits.
- You must precede single-digit channel numbers with a zero (For example: 02, 03, 04 and so on).

PLAYBACK FUNCTION

NORMAL PLAYBACK

- 1 Insert the prerecorded tape.** The VCR will turn on. If the safety tab has been removed, the VCR will start playback automatically.

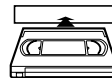

- 2 Turn on the TV and set the TV to channel 3 or 4.** Now set the CH3/CH4 switch on the back of the VCR to match the channel selected on the TV.

- 3 Begin playback by pressing [PLAY].**
 - Tracking adjustment will be set automatically (Digital Tracking function) when you start playback. To adjust the tracking manually, press [CHANNEL (^/v)] on the VCR.
 - When a tape has reached the end, the VCR will rewind the tape to the beginning, eject the tape, and turn off the VCR automatically.
 - S-VHS Quasi Playback (SQPB): This unit allows you to view a tape recorded in S-VHS format. (Noise lines may appear on the picture.)

- To stop playback, press [STOP].

STILL/SLOW

You can freeze the picture on TV screen by pressing [PAUSE/STILL] during playback.

- You can advance the picture by one frame at a time by pressing [PAUSE/STILL] during the still mode.
- If the picture begins to vibrate vertically during the still mode, stabilize the picture by pressing [CHANNEL (^/v)].
- If the picture is distorted or rolling vertically, adjust the vertical hold control on your TV, if equipped.

You can see the slow motion by pressing [SLOW] during playback or the still mode.

- If the noise bar appears on the TV screen, you can reduce it by pressing [CHANNEL (^/v)].
- After the VCR has been in Still/Slow mode for 5 minutes, it will stop automatically to protect the tape and the video head from damage.
- To return playback, press [PLAY].

AUTO REPEAT PLAYBACK

This feature allows you to play a tape over and over.

- 1 Select main menu** by pressing [MENU].
- 2 Select "AUTO REPEAT"** by pressing [PLAY] or [STOP].
- 3 Begin auto repeat playback** by pressing [F.FWD] so that [ON] appears next to "AUTO REPEAT".
 - If the on-screen menu still remains, press [EXIT/RESET] to exit the menu.
 - To cancel the Auto repeat mode, press [F.FWD] at step [3] so that [OFF] appears next to "AUTO REPEAT".
 - When you set the Auto repeat mode to [ON] while the Counter memory mode is ON, the VCR will exit the Counter memory mode automatically.

SEARCH FUNCTIONS

PICTURE SEARCH

If you want to skip or repeat a scene during playback, press [F.FWD] or [REW].

- Press it again and the VCR will now search in super high speed. (in the LP/SLP modes only)

TO PRESET THE CHANNEL AGAIN

- 1 Press [MENU]** until the main menu appears.
- 2 Select "CHANNEL SET UP"** by pressing [PLAY] or [STOP]. Then, press [F.FWD].
- 3 Select "AUTO SET UP"** by pressing [PLAY] or [STOP]. Then, press [F.FWD]. After scanning, the tuner stops on the lowest memorized channel.

TO ADD/DELETE CHANNELS

When the VCR automatically program the tuner to scan only the channels you receive in your area, some channels may be skipped due to weak signal. You can manually add the channel in the VCR memory.

- 1 Press [MENU]** until the main menu appears.
- 2 Select "CHANNEL SET UP"** by pressing [PLAY] or [STOP]. Then, press [F.FWD].
- 3 Select "MANUAL SET UP"** by pressing [PLAY] or [STOP]. Then, press [F.FWD].
- 4 Enter the desired channel number** by pressing [PLAY] or [STOP].
- 5 Add or Delete it from memory** by pressing [F.FWD] or [REW] so that "ADD" or "DELETE" flashes on the TV screen accordingly.
- 6 Exit the Preset mode** by pressing [EXIT/RESET].

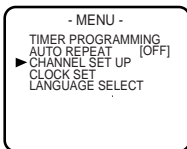

TO CHANGE THE ON-SCREEN LANGUAGE

- 1 Press [MENU]** until the main menu appears.
- 2 Select "LANGUAGE SELECT"** by pressing [PLAY] or [STOP]. Then, press [F.FWD].
- 3 Select "ENGLISH" or "ESPAÑOL"** by pressing [PLAY] or [STOP]. Then, press [EXIT/RESET].

CLOCK SET UP

Set the clock accurately for proper automatic timer recording. We suggest that you use a TV or radio station as your time source.

- 1 Select main menu** by pressing [MENU]. (If the clock is not set, the CLOCK SET menu appears first. In this case, follow step [3].)
- 2 Select "CLOCK SET"** by pressing [PLAY] or [STOP]. Then, press [F.FWD].
- 3 Set the clock.**

Set the month	Press [PLAY] or [STOP] repeatedly. Then, press [F.FWD].
Set the day	Press [PLAY] or [STOP] repeatedly. Then, press [F.FWD].
Set the year	Press [PLAY] or [STOP] repeatedly. Then, press [F.FWD]. The day of the week will appear automatically.
Set the hour	Press [PLAY] or [STOP] repeatedly. Then, press [F.FWD].
Set the minute	Press [PLAY] or [STOP] repeatedly. Then, press [F.FWD].
Set the AM or PM	Press [PLAY] or [STOP] repeatedly.

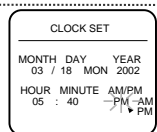

- To go back one step, press [REW].

- 4 Start the clock** by pressing [EXIT/RESET] or [F.FWD].

INDEX SEARCH

The index signal is recorded on the tape automatically when the recording is started. If you want to view a recording at a specific start point, it can easily be done.

- 1 Press **[SEARCH MODE]** so that the Index Search menu appears.
 - 2 Enter your desired number by pressing **[PLAY]** or **[STOP]** within 30 seconds.
 - 3 Press **[F.FWD]** or **[REW]** to start index search. If you want to go in the forward direction, press **[F.FWD]**. If you want to go in the reverse direction, press **[REW]**.
- After index search, the VCR will play the tape automatically.

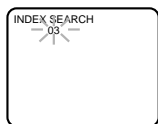

TIME SEARCH

This feature allows you to fast forward or rewind the tape for a desired length of time.

- 1 Press **[SEARCH MODE]** so that the Time Search menu appears.
 - 2 Enter your desired time to skip by pressing **[PLAY]** or **[STOP]** within 30 seconds.
 - 3 Press **[F.FWD]** or **[REW]** to start time search. If you want to go in the forward direction, press **[F.FWD]**. If you want to go in the reverse direction, press **[REW]**.
- After time search, the VCR will play the tape automatically.

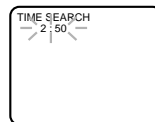

RECORDING FUNCTION

It may be unlawful record play back copyrighted material without the consent of the copyright owner.

Accidental erasure prevention

To prevent accidental recording on a recorded cassette, remove its record safety tab. To record on it later, cover the hole with cellophane tape.

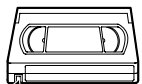

Record safety tab

Before recording, make sure:

- The desired channel is selected by pressing **[Number]** on the remote control or the **[CHANNEL (▲/▼)]**. (If you connected the VCR to a cable box or satellite box as in "VCR to TV connections" on page 3, select the VCR to channel 3 or 4 the same channel as the CH3 or CH4 switch on the back of the VCR. Then, select the channel you want to record at the cable box or satellite box. In this case, you can ONLY record and view the SAME channel.)
- There is a tape with its safety tab into the VCR.
- The desired recording speed is selected in SP(standard play) or SLP(super long play) mode by pressing **[TAPE SPEED]** on the VCR.

Tape Speed	Recording/Playback Time		
Type of tape	T60	T120	T160
SP mode	1hour	2hours	2-2/3hours
SLPmod	3hour	6hour	8hour

VIEWING AND RECORDING THE SAME PROGRAM

1 Begin the recording by pressing **[RECORD]**.

- To temporarily stop recording or resume it, press **[PAUSE/STILL]**. After the VCR has been in Pause mode for 5 minutes, it will stop automatically to protect the tape and the video head from damage.

2 Press **[STOP]** when recording is completed.

OTR(One Touch Recording)

This feature allows you to set the recording length simply by pressing **[REC/OTR]** on the VCR.

- 1 Begin OTR by pressing **[REC/OTR]** on the VCR repeatedly until the desired recording length appears.

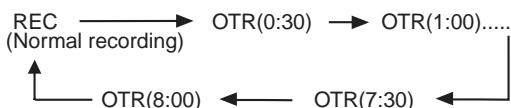

TIMER RECORDING

You may set the VCR to start recording while you are away. You can set seven programs to record on specific days, daily or weekly within a 1 year period.

- 1 Insert a tape with its safety tab into the VCR.
- 2 Select main menu by pressing **[MENU]**.
- 3 Select "TIMER PROGRAMMING" by pressing **[PLAY]** or **[STOP]**. Then, press **[F.FWD]**.
 - If you have not yet set the clock, "CLOCK SET" appears. If so, follow the steps [3] and [4] in "CLOCK SET UP" section. Then, set the timer recording.
- 4 Set the timer.

Set the program number (1-7)
 Program number which is not set up flashes. Press **[PLAY]** or **[STOP]** repeatedly for the desired program number. Then, press **[F.FWD]**.

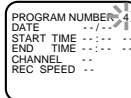

Select once, daily or weekly recording

- **For once:** Press **[PLAY]** or **[STOP]** to point to "ONCE".
- **For daily (Monday-Friday):** Press **[PLAY]** or **[STOP]** to point to "DAILY".
- **For weekly:** Press **[PLAY]** or **[STOP]** to point to "WEEKLY". Then, press **[F.FWD]**.

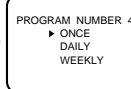

Set the date
 First, press **[PLAY]** or **[STOP]** for the month. Then, press **[F.FWD]**. Next, press **[PLAY]** or **[STOP]** for the day. Then, press **[F.FWD]**.

Set the start time
 First, press **[PLAY]** or **[STOP]** for the hour. Then, press **[F.FWD]**. Next, press **[PLAY]** or **[STOP]** for the minute. Then, press **[F.FWD]**. And then, press **[PLAY]** or **[STOP]** for AM or PM. Then, press **[F.FWD]**.

Set the end time
 Follow the instructions of "Set the start time" to set the end time.

Set the channel number
 Press **[PLAY]** or **[STOP]** repeatedly for the desired channel number. Then, press **[F.FWD]**.
 • If you connected the VCR to a cable box or satellite box as in "Connect VCR to TV" on page 3, select the VCR to channel 3 or 4 the same channel as the CH3 or CH4 switch on the back of the VCR.
 • Then, select the channel you want to record at the cable box or satellite box. Leave the cable box or satellite box on for timer recording.

Set the tape speed
 Press **[PLAY]** or **[STOP]** repeatedly for the desired tape speed. Then, press **[F.FWD]**.

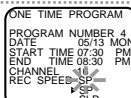

- To go back one step, press **[REW]**.
- 5 To set another program, repeat step [4]. To exit, press **[EXIT/RESET]**.
 - 6 Press **[POWER]** to set the timer. The TIMER indicator on the VCR comes on.

RECORDING PLAYBACK FUNCTION

HINTS FOR TIMER RECORDING

- If there is a power failure or the VCR is unplugged for more than 30 seconds, the clock setting and all timer settings will be lost.
- If the tape runs out before the end time, the VCR will switch to the Stop mode immediately, eject the tape and the VCR power will be turned off. The TIMER indicator will flash.
- If a tape is not in the VCR or does not have the safety tab, the TIMER indicator flashes and timer recording cannot be performed. Please insert a recordable tape.

TO STOP AN AUTOMATIC TIMER PROGRAM ALREADY STARTED

Press [STOP/EJECT] on the VCR.

TO CHECK, CORRECT, OR CANCEL AN AUTOMATIC TIMER PROGRAM

- 1 Turn the power on by pressing [POWER].
- 2 Select main menu by pressing [MENU].
- 3 Select "TIMER PROGRAMMING" by pressing [PLAY] or [STOP]. Then, press [F.FWD].
- 4 Select the program number which you want to check by pressing [PLAY] or [STOP]. The details of the selected program appears on the TV screen.

- Go to the digit you want to change by pressing [F.FWD] or [REW]. Then, enter correct numbers by pressing [PLAY] or [STOP].
- You may cancel the entire program by pressing [REW] during the program number flashes.

5 Press [EXIT/RESET] to exit.

6 Press [POWER] to return to timer stand-by mode.

COUNTER MEMORY FUNCTION

Use this feature to memorize the beginning of recording start point.

- 1) Press [COUNTER RESET] on the remote control to reset the counter.
 - 2) Press [COUNTER MEMORY] on the remote control so that "M" appears on the TV screen.
 - 3) Record the program.
 - 4) After recording, press [STOP] then [REW].
- When "0:00:00" is reached, rewinding operation goes to stop. And you can view the recording program.
 - [COUNTER MEMORY] does not function if the Auto repeat mode is set to [ON]. In this case, set the Auto repeat mode to [OFF].
 - To cancel the Counter memory mode, press [COUNTER MEMORY] so that "M" disappears from the TV screen.

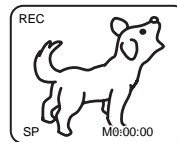

SPECIAL FEATURES

COPYING A VIDEO TAPE

You can make copies of video tapes made by friends or relatives for your enjoyment.

Warning: Unauthorized recordings of copyrighted video tapes may be an infringement of copyright laws. Connect the recording VCR (this unit), the playing VCR (another source) and your TV using the following diagram.

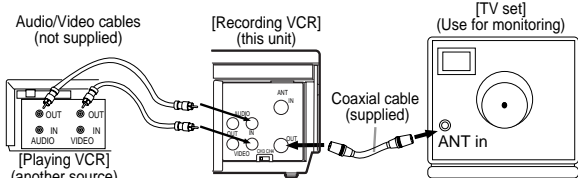

- 1) Insert a pre-recorded tape into the playing VCR.
 - 2) Insert a tape with its safety tab into the recording VCR.
 - 3) Press [TAPE SPEED] on the recording VCR to select the desired recording speed (SP/SLP).
 - 4) Select the "L1" or "L2" position on the recording VCR. See page 3, under "Using AUDIO/VIDEO Input jacks".
 - 5) Press [REC/OTR] on the recording VCR.
 - 6) Begin playback of the tape in the playing VCR.
- For best results during dubbing, use the VCR's front panel controls whenever possible. The remote control might affect the playing VCR's operation.
 - Always use video-quality shielded cables with RCA-type connectors. Standard audio cables are not recommended.
 - You can use a video disc player, satellite receiver, or other audio/video component with A/V outputs in place of the playing VCR.

TO MONITOR THE RECORDING

- 1) Turn on the TV and set the TV to channel 3 or 4. Now set the CH3/CH4 switch on the back of the VCR to match the channel selected on the TV.
- 2) Press [VCR/TV] on the recording VCR so that the VCR/TV indicator comes on.

AUTO REWIND

When a tape has reached the end during recording, playback, or fast-forward, the tape will automatically rewind to the beginning. After rewinding finishes, the VCR will eject the tape and turn itself to off.

- The VCR will not rewind the tape automatically during timer recording or One Touch Recording.
- When the Counter Memory is activated, the tape will rewind to the M0:00:00 and the VCR will go into the Stop mode.

REAL TIME TAPE COUNTER

- This shows the elapsed recording or playback time in hours, minutes, and seconds. (The displayed time will not change during blank portions on the tape.)
- The indication will appear when the tape is rewound further than "0:00:00" on the tape counter.

TROUBLESHOOTING GUIDE

If you have followed the instructions contained in this manual and have difficulty in operating your VCR, locate the **PROBLEM** in the left column below. Check the corresponding **CORRECTIVE ACTION** column to remedy the problem.

PROBLEM	CORRECTIVE ACTION
No power.	<ul style="list-style-type: none"> • Make sure the power plug is connected to an AC outlet. • Make sure the power is turned on.
Timer recording is impossible.	<ul style="list-style-type: none"> • Make sure the timer recording is set correctly. • Make sure the power is off. • Make sure the VCR clock is set correctly.
Cannot go into Record mode. Playback picture is partially noisy.	<ul style="list-style-type: none"> • Make sure the tape has a safety tab. If needed, cover the hole with cellophane tape. • Adjust tracking control for a better picture by pressing [CHANNEL (△/▽)] on the VCR.
Cannot view a tape but the audio is OK.	<ul style="list-style-type: none"> • Head cleaning may be necessary. Refer to "AUTO HEAD CLEANING". • Make sure the VCR is not in the Menu mode.
No or poor playback picture.	<ul style="list-style-type: none"> • Select channel 3 or 4 at your TV, then press [VCR/TV] so that the VCR/TV indicator on the VCR comes on. • Fine tune your TV.
TV programs cannot be seen normally.	<ul style="list-style-type: none"> • Re-check the ANT. IN and ANT. OUT connections. See page 3. • Press [VCR/TV] so that the VCR/TV indicator on the VCR disappears.
No VCR operation from the infrared Remote Control.	<ul style="list-style-type: none"> • Make sure the power plug is connected to an AC outlet. • Check batteries in remote control.
Video or color fades in and out when making a copy of a video tape.	<ul style="list-style-type: none"> • You cannot copy a copyrighted video tape. You are experiencing copy guard protection.

SPECIFICATIONS

Operating temperature :	5°C~40°C (41°F~104°F)	Power requirement :	120V, 60Hz
Converter output :	VHF Channel 3 or 4.	Power consumption :	14 Watts
		Dimensions :	W 14-1/4" (360mm) H 3-5/8" (92mm) D 8-1/2" (215.5mm)
		Weight :	4.4 lbs. (2.0 Kg.) (approx.)

• Designs and specifications are subject to change without notice and legal obligation.

• If there is a discrepancy between languages, the default language will be English.

MAINTENANCE

SERVICING

Should your VCR become inoperative, do not try to correct the problem by yourself. There are no user-serviceable parts inside. Turn off, unplug the power plug, and please call our help line at

1-800-242-7158,

to locate an Authorized Service Center.

CABINET CLEANING

- Wipe the front panel and other exterior surfaces of the VCR with a soft cloth immersed in lukewarm water and wrung dry.
- Never use a solvent or alcohol. Do not spray insecticide liquid near the VCR. Such chemicals may cause damage and discoloration to the exposed surfaces.

AUTO HEAD CLEANING

- Automatically cleans video heads as you insert or remove a cassette, so you can see a clear picture.
- Playback picture may become blurred or interrupted while the TV program reception is clear. Dirt accumulated on the video heads after long periods of use, or the usage of rental or worn tapes can cause this problem. If a streaky or snowy picture appears during playback, the video heads in your VCR may need to be cleaned.

1. Please visit your local Audio/Video store and purchase a good quality VHS Video Head Cleaner.
2. If a Video Head Cleaner does not solve the problem, please call our help line at 1-800-242-7158, to locate an Authorized Service Center.

NOTES:

- Remember to read the instructions included with the video head cleaner before use.
- Clean video heads only when problems occur.

CONTROLES DE FUNCIONAMIENTO Y FUNCIONES

Panel frontal

1. Compartimiento del videocasete
2. Botón de parada/expulsión
3. Botón de reproducción
4. Botón de rebobinado
5. Botón de pausa/imagen fija
6. Botón de avance rápido
7. Botón de menús
8. Botón de grabación con un toque
9. Botones de selección de canales
10. Botón de la velocidad de cinta
11. Indicadores
12. Sensor de control remoto
13. Botón de videogradora/televisor
14. Botón de la alimentación
15. Terminal de entrada de audio
16. Terminal de entrada de vídeo

Indicadores

17. Indicador de alimentación
18. Indicador de videogradora/televisor
19. Indicador de videocasete introducido
20. Indicador del temporizador
21. Indicador de grabación

Panel trasero

22. Cable de alimentación
23. Terminal de salida de audio
24. Terminal de entrada de audio
25. Terminal de entrada de antena
26. Terminal de salida de vídeo
27. Terminal de entrada de vídeo
28. Conmutador selector de canales CH3/CH4
29. Terminal de salida de antena

Mando a distancia

1. Botón de la alimentación (POWER)
2. Botones de número (NUMBER)
3. Botón de menús (MENU)
4. Botón de visualizador (DISPLAY)
5. Botón de cámara lenta (SLOW)
6. Botón de rebobinado (REW)
7. Botón de parada (STOP)
8. Botón de grabación (RECORD)
9. Botón de pausa/imagen fija (PAUSE/STILL)
10. Botón de avance rápido (F.FWD)
11. Botón de reproducción (PLAY)
12. Botón de memoria del contador (COUNTER/MEMORY)
13. Botón de salida/reposición (EXIT/RESET)
14. Botón del modo de búsqueda (SEARCH MODE)
15. Botones de selección de canales (CHANNEL)
16. Botón de videogradora/televisor (VCR/TV)
17. Botón de expulsión (EJECT)

PREPARACIÓN DE CANALES (La antena o la caja de televisión por cable deberá estar conectada)

NOTA: Cuando utilice su nueva videogradora por primera vez, o en el caso de ser necesario después de producirse un fallo en la alimentación, la videogradora se pondrá inicialmente en el modo de preajuste cuando se pulse [POWER].

1. Encienda el televisor y ponga el televisor en el canal 3 ó 4. Ahora ponga el conmutador de la parte trasera de la videogradora para que concuerde con el canal seleccionado en el televisor.
2. Pulse [POWER] para encender la videogradora.
3. Seleccione "ENGLISH" o "ESPAÑOL" (Spanish) pulsando [PLAY] o [STOP]. Y luego pulse [F.FWD].
4. Pulse una vez [F.FWD].

El sintonizador explora y memoriza todos los canales activos de su zona. Tras la exploración, el sintonizador se detiene en el canal memorizado más bajo.

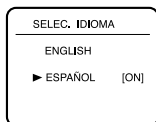

PREPARACIÓN DEL RELOJ

1. Pulse [MENU] hasta que aparezca el menú principal. (Si el reloj no está puesto en hora y se pulsa [MENU], el menú AJUSTE DE RELOJ aparece en primer lugar. En este caso, siga el paso 3.)
2. Pulse [PLAY] o [STOP] para indicar a "AJUSTE DE RELOJ". Luego, pulse [F.FWD].
- 3.

Ajuste el mes.	Pulse repetidamente [PLAY] o [STOP]. Luego, pulse [F.FWD].
Ajuste el día.	Pulse repetidamente [PLAY] o [STOP]. Luego, pulse [F.FWD].
Ajuste el año.	Pulse repetidamente [PLAY] o [STOP]. Luego, pulse [F.FWD].
Ajuste la ora.	Pulse repetidamente [PLAY] o [STOP]. Luego, pulse [F.FWD].
Ajuste el minuto.	Pulse repetidamente [PLAY] o [STOP]. Luego, pulse [F.FWD].
Ajuste la mañana (AM) o la tarde (PM).	Pulse repetidamente [PLAY] o [STOP].



- Para volver atrás un paso, pulse [REW].
- 4. Pulse [EXIT/RESET] o [F.FWD] para poner en funcionamiento el reloj.

FUNAI CORPORATION LIMITED WARRANTY

Funai Corporation will exchange or repair this product, at its option, in the event of defect in materials or workmanship as follows:

EXCHANGE DURATION:

- 1-90 DAYS:** FUNAI CORPORATION will exchange for a new unit without charge for a period of ninety (90) days from the date of original retail purchase.
- 91-365 DAYS:** FUNAI CORPORATION will exchange for a factory-service-to-new-condition unit for a charge of \$49.00 for the period of ninety one (91) days to three hundred sixty five (365) days from the date of original retail purchase.

REPAIR DURATION:

LABOR: FUNAI CORPORATION will provide the labor without charge for a period of ninety (90) days from the date of original retail purchase.

PARTS: FUNAI CORPORATION will provide parts to replace defective parts without charge for a period of one (1) year from the date of original retail purchase. Two (2) years for Picture Tube. Certain parts are excluded from this warranty.

LIMITS AND EXCLUSIONS:

This warranty is extended only to the original retail purchaser. A purchase receipt or other proof of original retail purchase will be required together with the product to obtain exchange or service under this warranty.

This warranty shall not be extended to any other person or transferee. This warranty is void and of no effect if any serial numbers on the product are altered, replaced, defaced or missing. This FUNAI CORPORATION Limited warranty applies only to product purchased and used in the United States.

This warranty only covers failures due to defects in material or workmanship, which occur during normal use. It does not cover damage which occurs in shipment, or failures which are caused by repairs, alterations, or parts not supplied by FUNAI CORPORATION, or damage which results from accident, misuse, abuse, mishandling, misapplication, alteration, faulty installation, improper maintenance, commercial use such as hotel, rental or office use of this product, or damage which results from fire, flood, lightning or other acts of God.

THIS WARRANTY DOES NOT COVER PACKING MATERIALS, ANY ACCESSORIES (EXCEPT REMOTE CONTROL UNITS), ANY COSMETIC PARTS, COMPLETE ASSEMBLY PARTS, DEMONSTRATION OR FLOOR MODELS.

FUNAI CORPORATION AND ITS REPRESENTATIVES OR AGENTS SHALL IN NO EVENT BE LIABLE FOR ANY GENERAL, INDIRECT OR CONSEQUENTIAL DAMAGES ARISING OUT OF OR OCCASIONED BY THE USE OF OR THE INABILITY TO USE THIS PRODUCT. THIS WARRANTY IS MADE IN LIEU OF ALL OTHER WARRANTIES INCLUDING THE WARRANTY OF MERCHANT ABILITY, AND FITNESS FOR A PARTICULAR PURPOSE, THAT ARE HEREBY DISCLAIMED BY FUNAI CORPORATION AND ITS REPRESENTATIVES OR AGENTS IN THE UNITED STATES.

ALL WARRANTY INSPECTIONS AND REPAIRS MUST BE PERFORMED BY A FUNAI AUTHORIZED CENTER. THIS WARRANTY IS VALID WHEN THE PRODUCT IS DELIVERED PREPAID TO A FUNAI AUTHORIZED SERVICE FACILITY.

IMPORTANT:

THIS LIMITED WARRANTY GIVES YOU SPECIFIC LEGAL RIGHTS. YOU MAY HAVE OTHER RIGHTS THAT VARY FROM STATE TO STATE, IF AT ANY TIME DURING THE WARRANTY PERIOD YOU ARE UNABLE TO OBTAIN SATISFACTION WITH THE EXCHANGE OR REPAIR OF THIS PRODUCT, PLEASE CONTACT FUNAI CORPORATION.

ATTENTION:

FUNAI CORPORATION RESERVES THE RIGHT TO MODIFY ANY DESIGN OF THIS PRODUCT WITHOUT PRIOR NOTICE. For information about your product, or for information on how to exchange or repair your product, telephone or write to the following:

FUNAI CORPORATION

Customer Service
100 North Street; Teterboro, NJ 07608
Telephone (800)242-7158

PLEASE DO NOT SHIP YOUR UNIT TO THE TETERBORO ADDRESS.

Free Manuals Download Website

<http://myh66.com>

<http://usermanuals.us>

<http://www.somanuals.com>

<http://www.4manuals.cc>

<http://www.manual-lib.com>

<http://www.404manual.com>

<http://www.luxmanual.com>

<http://aubethermostatmanual.com>

Golf course search by state

<http://golfingnear.com>

Email search by domain

<http://emailbydomain.com>

Auto manuals search

<http://auto.somanuals.com>

TV manuals search

<http://tv.somanuals.com>