

**TANITA®**

# TBF-531 BODY FAT MONITOR/SCALE

Instruction Manual



Thank you for your selection of the TANITA Body Fat Monitor/Scale TBF-531. This family model uses the BIA (Bioelectrical Impedance Analysis) technique, a state-of-the-art technology for body fat measurement.

**NOTE:** Read this Instruction Manual carefully and keep it handy for future reference.



## Safety precautions

- Persons with implanted medical equipment, such as a pacemaker, should not use the TBF-531. This Body Fat Monitor/Scale passes a very low electrical signal through the body during measurement, which may interfere with the operation of a pacemaker.
- The TANITA Body Fat Monitor/Scale TBF-531 is intended for home use only. This unit is not intended for professional use in hospitals or other medical facilities. It is not equipped with the quality standards required for professional use.
- Do not use this unit on slippery surfaces such as tile flooring or wet floors.
- Children or disabled people should be assisted by someone else, or use a handrail when using the TBF-531.

**NOTE:** Measurements will vary with the amount of moisture in the body, and can be affected by dehydration caused by such things as alcohol consumption, menstruation, illness, strenuous exercise, etc.

## Important notes for users

The TBF-531 is intended for use by male and female adults and by children up to the age of 18, over 3.6 ft. (107 cm) tall, whose bodies are still developing. Body fat percentage measurements may be slightly lower or higher for the following categories of people:

- Children seven years old or younger
- Adults seventy years old or older
- Pregnant women
- Persons undergoing dialysis
- Persons suffering from edema

Body fat percentage measurements for these persons should not be treated as absolute values, but may be used as relative values for checking body fat percent variations over a period of time.

The TBF-531 is not intended for use by *persons involved in intense aerobic exercise* of at least 10 hours per week and who have a resting heart rate of less than 60 beats per minute. It is also not intended for *professional athletes* or *bodybuilders* who may experience physical changes due to dehydration.

Recommendations for exercise programs or diets based on measured data should be determined by a doctor or licensed medical professional. Do not attempt to evaluate the data by yourself.

Recorded data may be lost if the TBF-531 is used incorrectly or is exposed to electrical power surges. TANITA takes no responsibility for any kind of loss caused by the loss of recorded data.

TANITA takes no responsibility for any kind of damage or loss caused by these units, or any kind of claim made by a third person.

# Principles of body fat percentage measurement

The Tanita Body Fat Monitor/Scale TBF-531 allows you to estimate your body fat percentage at home as easily as you measure your weight.

## What is body fat percentage?

Body fat percentage is the percentage of fat in your body. Until now, your absolute weight has determined whether or not you were considered overweight or obese. In recent years, the definition of obesity has been refined to mean the presence of excess body fat. Too much body fat has been linked to conditions such as high blood pressure, heart disease, diabetes, cancer, and other disabling conditions.

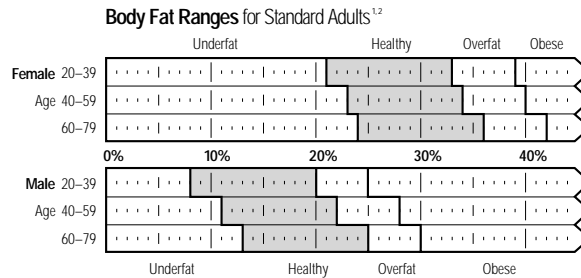

<sup>1</sup> Based on NIH/WHO BMI Guidelines.  
<sup>2</sup> As reported by Gallagher, et al., at NY Obesity Research Center.  
 To determine the percentage of body fat that is appropriate for your body, consult your physician.



Tanita's patented "foot-pad" design sends a safe, low-level electrical signal through the body to determine its composition.

## The BIA method

The TBF-531 uses the BIA (Bioelectrical Impedance Analysis) technique. In this method, a safe low-level electrical signal is passed through the body. It is difficult for the signal to flow through fat in the human body, but easy to flow through moisture in the muscle and other body tissues. The difficulty with which a signal flows through a substance is called impedance. So the amount of fat in the body can be accurately estimated by measuring the impedance. The signal used is very low, making it safe and imperceptible.

The illustration on the left show how the signal travels through the body.

## Body fat percentage fluctuations in a day

Hydration levels in the body may affect body fat readings. Readings are usually highest in the early waking hours, since the body tends to be dehydrated after a long night's sleep. For the most accurate reading, a person should take a body fat percentage reading at a consistent time of day under consistent conditions.

Besides this basic cycle of fluctuations in the daily body fat readings, variations may be caused by hydration changes in the body due to eating, drinking, menstruation, illness, exercising, and bathing. Daily body fat readings are unique to each person, and depend upon one's lifestyle, job and activities.

The graph on the left shows an example of daily body fat percentage fluctuations.

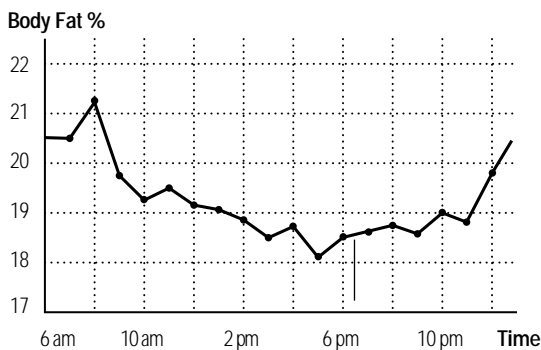

Daily fluctuations in body fat percentage based on the BIA method

## Advantages of the Tanita TBF-531

Previously, body fat percentage was determined by measuring the thickness of subcutaneous fat by pinching it with calipers, or by laying a person on a scanning bed and passing a current from hand to foot. However, these methods had problems; measurement values varied, professional skills were required, and extensive time was required for measurement. Currently, the standard methods of fat percentage measurement are DEXA (dual energy x-ray absorptiometry) and Hydrodensitometry (underwater weighing).

Based on data from both the DEXA and underwater weighing methods, Tanita established a formula for estimating the percentage of body fat. There is a high correlation between measurements taken with the TBF-531 and those obtained through DEXA and underwater weighing.

# Table of contents



1	<b>Safety precautions</b> Important notes for users
2	<b>Principles of body fat percentage measurement</b> What is body fat percentage? Reasonable ranges of body fat percentage Body fat percentage measurement Body fat percentage fluctuations in a day Advantages of the TANITA Body Fat Monitor/Scale TBF-531
4	<b>Features and functions of the TBF-531</b> Components Measuring platform Accessories Useful features of the TBF-531
6	<b>Preparations before use</b> Inserting the batteries Positioning the unit Attaching the support feet Handling tips
7	<b>How to measure body fat percentage</b> Overview of measuring Setting and storing data in memory Taking measurements Taking weight measurement only Changing values in memory Replacing the batteries
10	<b>Troubleshooting</b> Specifications
11	<b>Warranty</b>

## FEDERAL COMMUNICATIONS COMMISSION NOTICE

This equipment has been tested and found to comply with the limits for a Class B digital device, pursuant to Part 15 of the FCC Rules. These limits are designed to provide reasonable protection against harmful interference in a residential installation. This equipment generates, uses and can radiate radio frequency energy and, if not installed and used in accordance with the instructions, may cause harmful interference to radio communications. However, there is no guarantee that interference will not occur in a particular installation. If this equipment does cause harmful interference to radio or television reception, which can be determined by turning the equipment off and on, the user is encouraged to try to correct the interference by one or more of the following measures:

- Reorient or relocate the receiving antenna.
- Increase the separation between the equipment and receiver.
- Connect the equipment into an outlet on a circuit different from that to which the receiver is connected.
- Consult the dealer or an experienced radio or television technician for help.

## Modifications

The FCC requires the user to be notified that any changes or modifications made to this device that are not expressly approved by Tanita Corporation may void the user's authority to operate the equipment.

# Features and functions of the TBF-531

## Components

Measuring platform	(1)
Support feet	(4)
AA-size batteries	(4)
Instruction manual	(1)
Warranty	(1)
Educational booklet	(1)
Getting started workbook	(1)

## Measuring platform

1. Display screen
2. Set button
3. Selection buttons (Up/Down)
4. Toe electrodes
5. Heel electrodes
6. Guide marks sticker  
*For positioning heels when standing on the unit.*
7. PERSONAL keys (start switch)  
*Setting of age (Adult/Child), gender, and height for up to four persons can be stored in the memory of the PERSONAL keys.*
8. Weight measurement key  
*Use for weight measurement only.*

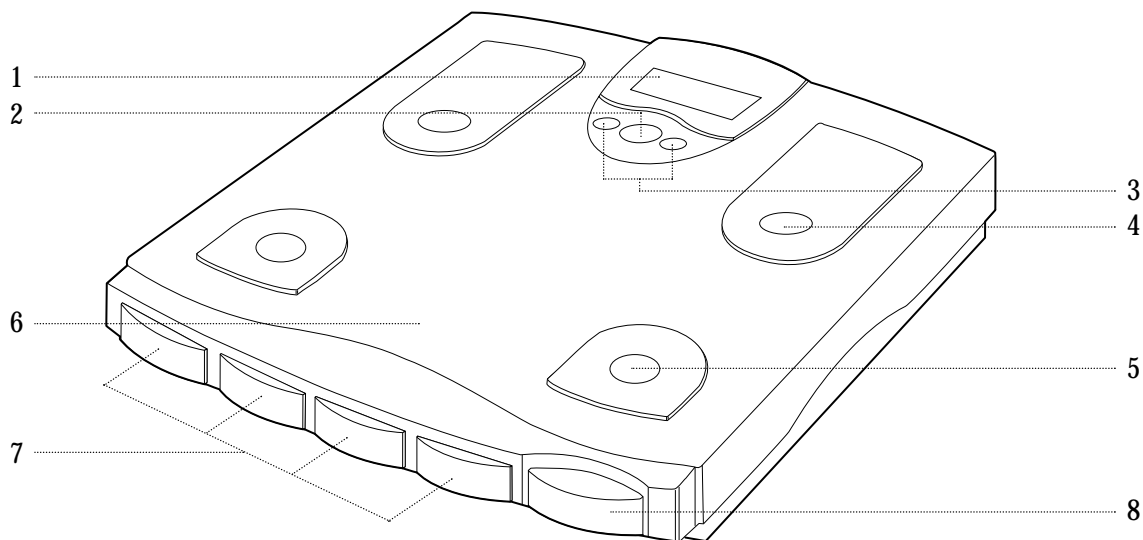

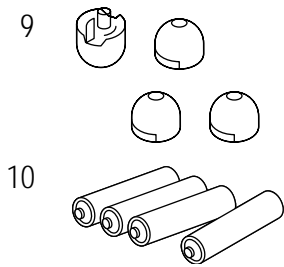

## Accessories

9. Support feet (4)  
*For use on carpeting 0.8 inches thick or less; a hard, uncarpeted surface is recommended.*
10. AA-size batteries (4)  
*These are trial batteries. Their service life will be short. New batteries will last for about a year when this unit is used by a family of four once every day.*

## Useful features of the TBF-531

The TBF-531 allows you to measure both weight and body fat percentage simultaneously as easily and simply as stepping on a scale.

The TBF-531 can be set for Adult/Child, gender and height, increasing the accuracy of the measurements.

Personal data (Adult/Child, gender, height) can be pre-set in memory for up to four persons.

The unit also features a weight only mode.

### Switching the weight mode

The TBF-531 can record measurements in lb (pounds), kg (kilograms), or st-lb (British stone pounds). Select the preferred weight mode by using the switch on the back of the measuring platform (see illustration at left).

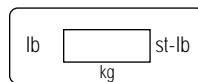
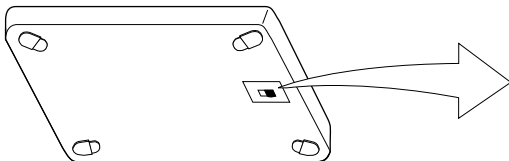

lb, kg, or st-lb version

### Automatic shut-down function

The automatic shut-down function shuts off the power automatically in the following cases:

- If you interrupt the measurement process.  
*The power will shut down automatically within 10 to 20 seconds, depending upon the type of operation.*
- If an extraordinary weight is applied to the platform.
- If you make a mistake during measurement or a key operation.
- After you have completed the measurement process.

**NOTE:** If the power shuts off automatically due to a problem, repeat the steps from the beginning (see pp. 7-8 for steps).

## Preparations before use:

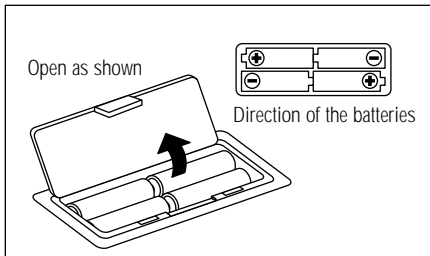

### Inserting the batteries

1. Open the battery cover on the back of the measuring platform.
2. Insert the supplied AA-size batteries as indicated.



**NOTE:** Be sure that the polarity of the batteries is set properly. If the batteries are incorrectly positioned the fluid may leak and damage floors. If you do not intend to use this unit for a long period of time, it is advisable to remove the batteries before storage.

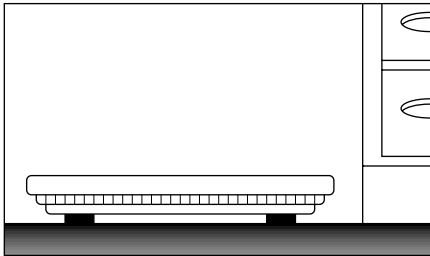

### Positioning the monitor

Place the measuring platform on a hard, flat surface where there is minimal vibration to ensure safe and accurate measurement.



**NOTE:** To avoid possible injury, do not step on the edge of the platform.

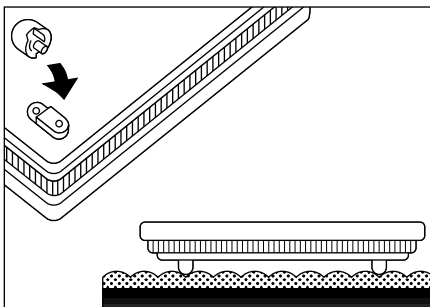

### Attaching the support feet (carpet use only)

Insert the support feet into the holes at the four corners on the bottom of the measuring platform.

**NOTE:** Do not use the monitor on any carpeting that is more than 0.8 inches in thickness.



Do not use the support feet on hard, flat surfaces, as the unit may tip over.

### Handling tips

This monitor is a precision instrument utilizing state-of-the-art technology. To keep the unit in the best condition, follow these instructions carefully:

- Do not attempt to disassemble the measuring platform.
- Store the unit horizontally, and place it so that the PERSONAL keys will not be pressed accidentally.
- Avoid excessive impact or vibration to the unit.
- Place the unit in an area free from direct sunlight, heating equipment, high humidity, or extreme temperature change.
- Never submerge in water. To clean, use a dampened cloth and mild detergent. Use alcohol to clean the electrodes.
- When you change the batteries, exchange all four batteries at the same time with new AA-size batteries.

*If you need assistance, please call our toll-free customer service number at 1-800-TANITA-8.*

# How to measure body fat percentage

## Overview of measuring

To get the most accurate absolute values, measurements should be taken while wearing no clothing, preferably in the evening, and after urinating. If you do not undress, always remove your socks or stockings, and be sure the soles of your feet are clean before stepping on the measuring platform. Stand erect on the platform. If used after bathing, the body must be completely dry.

**NOTE:** Accurate measurement will not be possible if the soles of your feet are not clean, or if your knees are bent or you are in a sitting position.

It is best to take measurements at the same time each day, preferably in the evening. If doing so is not convenient, remember to wait about three hours after rising, eating, or hard exercise before taking measurements. While readings taken under other conditions may not have the same absolute values, they are accurate for determining the percentage of change as long as the readings are taken in a consistent manner. To monitor progress, compare weight and body fat percentage measurements taken under the same conditions over a period of time.

## Setting and storing data in memory

The TBF-531 can be operated as a body fat monitor only if data has been pre-programmed into one of the four PERSONAL keys. The weight only function works independently. The unit has an automatic shut-down function. If you do not step on the platform after selecting a PERSONAL key, the unit will automatically shut off in about 30 seconds.

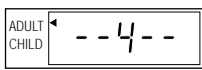
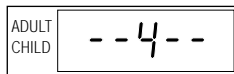
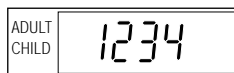

Adult (over 18 years old)

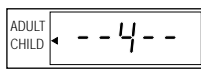

Child (up to 18 years old)



Female



Male

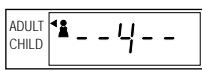

Female

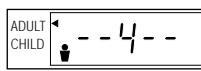

Male

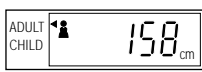

For the kg version

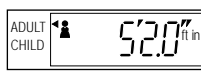

For the lb version

### 1. Turn on the power

Use the Set button to turn the unit on. The numbers (1-2-3-4) will appear and the display will flash.

### 2. Select a personal number

Use the Up or Down buttons to select a personal number. After selecting the number, press the Set button.

### 3. Select Adult or Child

Use the Up or Down buttons to specify Adult/Child, then press the Set button.

Child = up to the age of 18, over 3.6 ft (107 cm)

Adult = age 18 or older

*The TBF-531 is not intended for use by persons involved in intense aerobic exercise of at least 10 hours per week and who have a resting heart rate of less than 60 beats per minute.*

*It is also not intended for professional athletes or bodybuilders who may experience physical changes due to dehydration.*

### 4. Select Male or Female

Press the Up or Down buttons to specify the appropriate gender, then press the Set button.

### 5. Specify the height

Press the Up or Down buttons to specify the height (hold the button down continuously for speed setting). Then press the Set button.

Once the height is specified, data storage is complete. The display will flash all data (Adult/Child, gender, and height) for 3 seconds to confirm the programming. The power will automatically turn off after the confirmation. To set the next PERSONAL key, repeat steps 1 through 5 after the power shuts off.



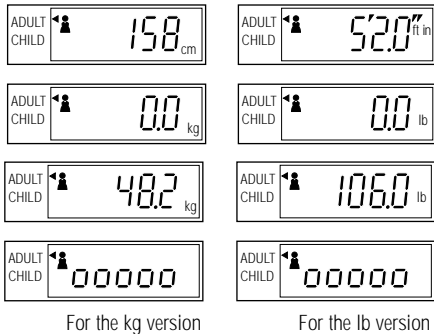

## Taking measurements

### 1. Select PERSONAL key

Using your toe, tap the PERSONAL key for the person whose measurement is to be taken. Release the key within 3 seconds.

**NOTE:** Do not hold the switch down or the display will show "error" and the programmed data will be erased and require resetting.

The TBF-531 switches on, and the display shows the programmed data.

After 2 or 3 seconds, the display will show "0.0 lb".

### 2. Take measurement

Wait for "0.0 lb" to appear before stepping onto the measuring platform.

**NOTE:** If you do not wait for "0.0 lb." to appear, the display will read "error".

Be sure you are barefoot, and that the soles of your feet are clean and dry.

Be sure that your toes and heels are correctly aligned with the toe and heel electrodes on the measuring platform. Stand erect on the platform.

**NOTE:** If you do not step onto the measuring platform within about 20 seconds after "0.0 lb" appears, the power shuts off automatically.

Your weight will be shown first. "0000" will appear in the display and then the zeroes will disappear one by one until your body fat percentage is displayed.

Continue to stand erect on the platform. The values of body fat percentage and body weight will be displayed alternately at 2-second intervals. If you remain on the platform, the display will continue for about 30 seconds, and then the power will automatically turn off.

When you step off the platform, the alternating display of body fat percentage and body weight will be repeated 3 times, and then the power shuts off automatically.

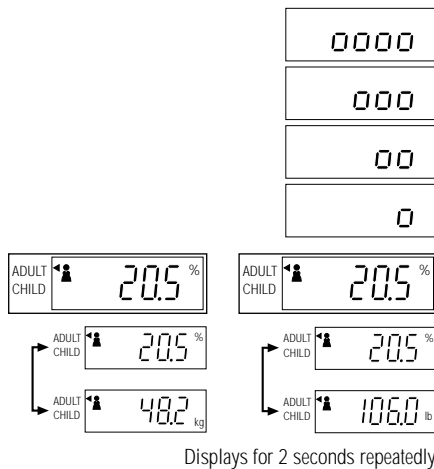

Displays for 2 seconds repeatedly

## Taking weight measurement only

### 1. Select weight only key

Using your toe, tap the weight only key to select weight measurement. After 2 or 3 seconds, "88888" will appear in the display and then it will show "0.0 lb".

### 2. Take measurement

Step onto the measuring platform.

Be sure that your toes and heels are correctly aligned with the toe and heel electrodes on the measuring platform.

The body weight will appear. If you remain on the platform, the display will flash for about 30 seconds, and then the power shuts off automatically. If you step off the platform, the weight will continue to show for about 5 seconds.

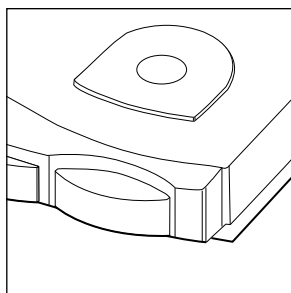

Tap the weight only key by using your toe

## Changing values in memory

Perform steps 1 through 5 in “Setting and storing data in memory” on p. 7.



## Replacing the batteries

When the batteries run low, the “Lo” message will appear on the display window. When this message appears, be sure to replace the batteries immediately, since weak batteries will affect the accuracy of your measurements.

Your settings will not be erased from the memory when you remove the batteries.

Fresh batteries will last for about one year if a family of four uses the unit once every day. The unit comes with 4 trial batteries. Their service life will be short.

# Troubleshooting

## If the following problems occur...

## Then...

- Nothing appears in the LCD after initial display.
- Nothing appears when a PERSONAL key is pressed, or

The display shows “-----” and goes off when a PERSONAL key is pressed.

- The body fat percentage measurement does not appear after the weight is measured.
- The body fat percentage measurement is extremely low.
- The body fat percentage measurement is extremely high.
- The display reads “error” instead of the weight.

Check foot alignment. Make sure you wait for “0.0 lb” to appear before stepping on the platform. Check to see that the batteries are new and are in the correct position.

No data (Adult/Child, gender, height) has been pre-set in memory for that key. Enter data.

Vibration will interfere with measurement of the fat percentage. Be sure to stand erect and still on the measuring platform. Do not bend your knees. Be sure that shoes and socks are removed and check foot alignment. Step off and repeat steps on pp. 7-8.

Be sure you are measuring in the correct user mode (Adult/Child, gender), and that the soles of your feet are clean and properly aligned with the guides on the measuring platform. Consider whether or not you are over-hydrated. Step off and repeat steps on pp. 7-8.

Be sure you are measuring in the correct user mode (Adult/Child, gender), and that the soles of your feet are clean and properly aligned with the guides on the measuring platform. Dehydration, exercise, foot calluses, etc. will interfere with measurement of the fat percentage. Step off and repeat steps on pp. 7-8.

Wait for “0.0 lb” to appear in the display before stepping onto the platform.

### SPECIFICATIONS: TBF-531 BODY FAT MONITOR/SCALE

Capacity	Unit: lb	Unit: kg	Unit: st-lb
	300 lb	136 kg	21 st-6 lb
Graduation	0-300 lb / 0.5 lb	0-136 kg / 0.2 kg	0-21 st-6 lb / 0.5 lb
Fat Percentage	0.5%		
Power Supply	DC 6V AA-size (UM3-type) dry battery (x4) included		
Power Consumption	60 mA maximum		
Measuring Current	50 kHz 500 µA		
<b>UPC No:</b>	TBF-531-LG (Light Grey) 742496-163905		

#### After sales service

Please contact the store at which you bought this monitor for any inquiry regarding operation or trouble, request for repair and/or placement of an order for parts or products. Or call 1-800-TANITA-8 (USA and Canada only).

Not for trade use.

# TANITA PRODUCTS LIMITED WARRANTY

## Not Valid Without Proof of Purchase

Your Tanita product is warranted to the original consumer only, for one (1) year, to be free from defects in materials and workmanship under normal use. This product is designed **for Personal use only**. Tanita Corporation of America reserves the right to nullify the warranty agreement should the product be used in a commercial environment. This warranty is void if the product has been tampered with or mistreated, or if the defect is related to servicing or parts not supplied by us. Our obligation under this warranty is limited solely to the charge of repairing the product, plus the cost of parts or, at the option of Tanita, replacing the product with an equivalent model. There are no express or implied warranties except as listed above. **Tanita is not liable for incidental or consequential damages for failure or malfunction of the product and any recovery may not be greater than the purchase price paid for this product.** Some states do not allow limitation on how long an implied warranty lasts, or the exclusion or limitation of incidental or consequential damages, so the above limitations may not apply to you. This warranty gives you specific legal rights and you may also have other rights which vary from state to state. **No person is authorized to change the terms of this warranty.**

### IF PRODUCT IS DEFECTIVE OR NEEDS REPAIR

*Do not return this product to the place of purchase; doing so may delay the processing of your warranty claim.*

Call Tanita at: 1-800-TANITA-8 to receive a Return Authorization Number before returning this product. Include \$12.50 for handling, return postage and insurance to the facility listed below. **Proof of purchase must accompany the product.** Because of possible loss, we recommend insuring your product, return receipt requested, when using the mail. If you do not receive a receipt within a reasonable time, start a tracer through the originating post office. It is important that you pack the product carefully prior to shipment to prevent damage in transit and that you include a letter describing in detail the specific condition requiring adjustment or repair.

### TANITA PRODUCTS LIMITED AFTER WARRANTY

All terms and conditions apply as specified above in the original Tanita Limited Warranty **except** for the cost of labor and parts:

- Minimum charge for After Warranty labor is \$30 per hour, plus the cost of parts.
- You will be notified by mail or telephone of the total cost to repair your product to working condition, so prepayment can be arranged.
- Your approval is required before any repair work can be performed on your product.

*Please complete the following information and retain for your records.*

MODEL: \_\_\_\_\_ DATE PURCHASED:        /        /

PURCHASED FROM: \_\_\_\_\_

ADDRESS: \_\_\_\_\_

**TANITA**<sup>®</sup>  
A Step Toward A Healthier Life.

*Please send all returns to:*  
**Tanita Corporation**  
2625 S. Clearbrook Drive  
Arlington Heights, IL 60005 USA

---

# TANITA®

©1998 Tanita Corporation 5/98 HDI

## **TANITA Corporation**

14-2, 1-Chome, Maeno-Cho  
Itabashi-Ku, Tokyo, Japan  
Tel. 03-3968-2123 Fax 03-3967-3766  
**ISO 9001 Certified**

## **TANITA Corporation of America Inc.**

2625 S. Clearbrook Drive  
Arlington Heights, IL 60005 USA  
Tel. 847-640-9241 Fax 847-640-9261  
Toll Free 1-800-TANITA-8

[http:// WWW.TANITA.COM](http://WWW.TANITA.COM) (English)  
[http:// WWW.TANITA.CO.JP](http://WWW.TANITA.CO.JP) (Japanese)

## **TANITA France S.A.**

3-3 Bis, Rue Charcot 92200  
Neuilly-sur-Seine, France  
Tel. 01-5524-9999  
Fax 01-5524-9868

## **TANITA Health Equipment H.K. Ltd.**

Unit 301-303 3/F Wing On Plaza  
62 Mody Road, Tsimshatsui East  
Kowloon, Hong Kong  
Tel. 852-2838-7111 Fax 852-2838-8667

## **TANITA Europe GmbH**

Dresdener Strasse 25  
D-71065 Sindelfingen, Germany  
Tel. 07031-61896  
Fax 07031-618971

## **TANITA UK Ltd.**

Tanita House, Willow Avenue, Denham  
Uxbridge, Middlesex UB9 4AF, Great Britain  
Tel. 01895-232355  
Fax 01895-233116

## Free Manuals Download Website

<http://myh66.com>

<http://usermanuals.us>

<http://www.somanuals.com>

<http://www.4manuals.cc>

<http://www.manual-lib.com>

<http://www.404manual.com>

<http://www.luxmanual.com>

<http://aubethermostatmanual.com>

Golf course search by state

<http://golfingnear.com>

Email search by domain

<http://emailbydomain.com>

Auto manuals search

<http://auto.somanuals.com>

TV manuals search

<http://tv.somanuals.com>