

Product Description

The Definition Install iw60 EFX is a multi purpose in wall surround / effects speaker designed around the unique Tannoy Dual Concentric™ drive unit. The speaker is conveniently configurable between two modes of operation: 'Cinema Mode', where the two optimally aligned 100mm (4.00") Dual Concentric™ drivers generate a wide and even flow of acoustic energy over a large area for a diffuse room filling ambience and the direct radiating 'Music Mode', where the 165mm (6.50") constant directivity Dual Concentric™ driver produces a more localised and focused sound, highlighting the distinct separation afforded by modern programme material. In Music mode the direct radiating pattern is auto switched using a 12V trigger.

Claims are made that having more drivers is better. While multiple drivers are needed to cover the full frequency spectrum it is a fact that a discrete woofer and tweeter array will produce a large null at the crossover frequency when you move through the vertical plane. In a product concept such as the iw60 EFX, using three sets of discrete drivers would cause this negative acoustic effect to occur three times in a single cabinet; something no amount of DSP could compensate for. The point source Dual Concentric™ units in the Tannoy iw60 EFX ensure that no such acoustical anomalies occur.

The Dual Concentric™ is effectively two drivers properly merged into one where, unlike ordinary drive units, the high frequency unit is positioned on the back of the low frequency driver. As a result they are on same axis, so ensuring that sound energy is effectively propagated from the same point and delivered through the centre of the low frequency cone as true point source. Such integration optimises reproduction quality by providing a constant time delay over the frequency spectrum, exceptional transient performance, wide dispersion and superior harmonic alignment; all of which delivers to the listening position a natural, clean and integrated sound with greatly enhanced intelligibility, sound staging and dynamics.

Characteristic of the Dual Concentric™ design is a very wide 'sweet spot' with an exceptionally even response throughout the listening area, as well as an extraordinary transient response; reasons enough for this phase accurate Tannoy designed drive unit to have been the choice of professional studio engineers all over the world for many years.

The heavily braced and comprehensively damped MDF cabinet is supplied with a paintable, flush mounting grille designed to blend seamlessly into any architectural space. A unique isolation mounting system optimises low frequency performance by controlling unwanted resonances within the install structure. A mounting frame is available as an optional pre-installation accessory to fit into standard construction 2" x 4" stud walls.

The exceptionally versatile, high power handling iw60 EFX is able to extract the full potential of contemporary multi-channel soundtracks; an in wall surround / effects speaker designed to reproduce the same bandwidth and sound pressure levels as the main speakers.

Features

- 165mm (6.50") high sensitivity, point source and constant directivity Dual Concentric™ drive unit (music mode)
- Two 100mm (6.50") Dual Concentric™ drive units in dipole configuration (cinema mode)
- Constant time delay over the frequency spectrum
- Exceptional transient performance
- 90 degree conical dispersion (music mode 120 degrees horizontal by 90 degrees (cinema mode)
- Superior harmonic alignment
- Natural, clean and integrated sound
- Enhanced intelligibility, sound staging and dynamics
- Recommended amplifier power 100 to 200W @ 8 Ohms
- Sensitivity 90dB (1W = 2.83V for 8 Ohms)
- Maximum SPL 117dB average
- Rugged construction MDF closed enclosure, internally braced and finished with textured black paint
- Isolation mounting system minimises energy transfer to the wall material
- Optional pre-installation frame available

Applications

- Media rooms
- Home theatre
- Boardrooms
- High end marine interiors

Tannoy United Kingdom
Tannoy North America
Tannoy Deutschland
Tannoy France

T: 00 44 (0) 1236 420199
T: 00 1 (519) 745 1158
T: 00 49 (180) 1111 881
T: 00 33 (0)1 7036 7473

E: enquiries@tannoy.com
E: inquiries@tannoyna.com
E: anfragen@tannoy.com
E: ventes@tannoy.com

tannoy.com



Definition Install iw60 EFX

TANNOY®

TECHNICAL SPECIFICATIONS

System Definition Install iw60 EFX

Frequency Response ⁽¹⁾⁽⁴⁾	110Hz - 23kHz
Frequency Range ⁽¹⁾⁽⁴⁾	74Hz - 27kHz
System Sensitivity (1W @1m) ⁽²⁾⁽⁴⁾	90dB (1W = 2.83V for 8 Ohms)
Nominal Coverage Angle	90 degrees conical in music mode
Coverage Angle (1kHz to 6kHz)	120 degrees horizontal x 90 degrees in cinema mode
Directivity Factor (Q)	3.50 averaged 1kHz to 6kHz
Directivity Index (DI)	5.50 averaged 1kHz to 6kHz
Rated Maximum SPL ⁽³⁾	
Average	110dB
Peak	116dB
Power Handling ⁽³⁾	
Average	100W
Programme	200W
Peak	400W
Recommended Amplifier Power	200W @ 8 Ohms
Nominal Impedance	8 Ohms in music mode 4 Ohms in cinema mode

Distortion

10% Full Power (8.94V)	2nd Harmonic	3rd Harmonic
250Hz	1.84%	0.30%
1kHz	0.34%	0.61%
10kHz	0.91%	0.17%
1% Full Power (2.83V)	2nd Harmonic	3rd Harmonic
250Hz	0.19%	0.35%
1kHz	0.40%	0.32%
10kHz	0.46%	0.89%

Crossover 1.6kHz

Notes:

- (1) Average over stated Bandwidth. Measured in an IEC baffle in an Anechoic Chamber
- (2) Unweighted Pink noise input, measured at 1m on axis
- (3) Long term power handling capacity as defined in EIA - 426B test
- (4) Music mode
- (5) Cinema mode. For music mode refer to iw63 data

A full range of measurements, performance data, CLF and Ease™ Data can be downloaded from www.tannoy.com

Full independent verification of published specifications carried out by NWA Labs, California can also be obtained from the downloads section of www.tannoy.com

Tannoy operates a policy of continuous research and development. The introduction of new materials or manufacturing methods will always equal or exceed the published specifications, which Tannoy reserves the right to alter without prior notice. Please verify the latest specifications when dealing with critical applications.

Ordering Information

PART NUMBER	MODEL NAME	COLOUR	PACKED QUANTITY
8000 5270	Definition Install iw63 EFX	Black	1

Transducers

Music mode	1 x 165mm (6.5") constant directivity Dual Concentric™
Cinema mode	2 x 100mm (4.0") Dual Concentric™ in dipole configuration

Construction

Enclosure	11.5 litre (net total volume), closed and internally braced MDF enclosure
Finish	Textured black paint White powder coated perforated steel grille, foam behind
Connectors	Gold plated spring terminals
Controls	Mode selection input (12V DC relay activated via Dinkle connector)
Dimensions	590 x 345 x 94mm (H x W x D) (23.23 x 13.58 x 3.70 ") (H x W x D)
Optional Accessory	Pre-installation mounting frame
NET Weight	9.50Kg (20.94lbs)

Tannoy United Kingdom
Tannoy North America
Tannoy Deutschland
Tannoy France

T: 00 44 (0) 1236 420199
T: 00 1 (519) 745 1158
T: 00 49 (180) 1111 881
T: 00 33 (0)1 7036 7473

E: enquiries@tannoy.com
E: inquiries@tannoyna.com
E: anfragen@tannoy.com
E: ventes@tannoy.com

tannoy®.com



PERFORMANCE MEASUREMENTS

1m on-axis frequency response

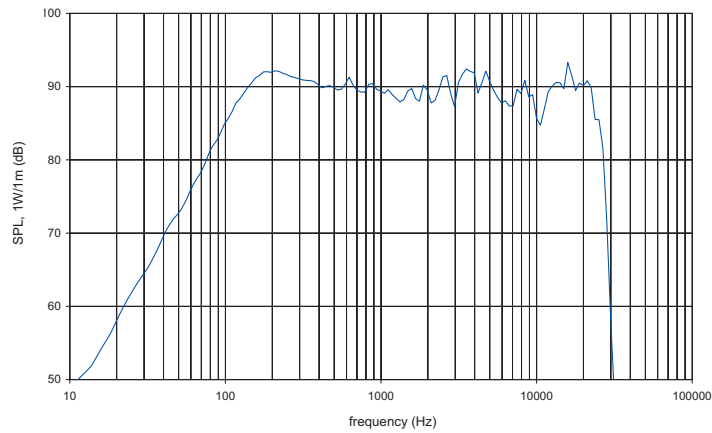

ANECHOIC
FREQUENCY
RESPONSE

Impedance vs frequency

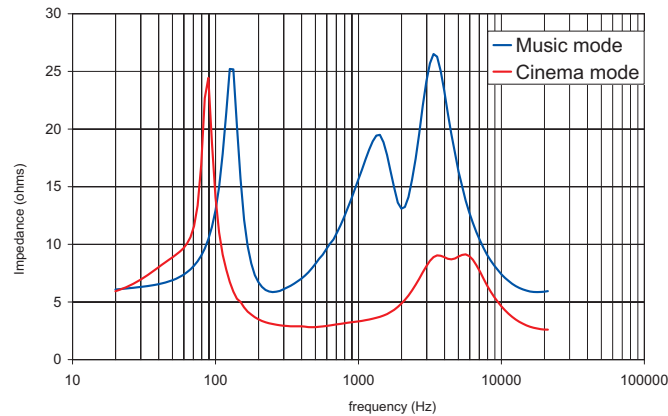

IMPEDANCE

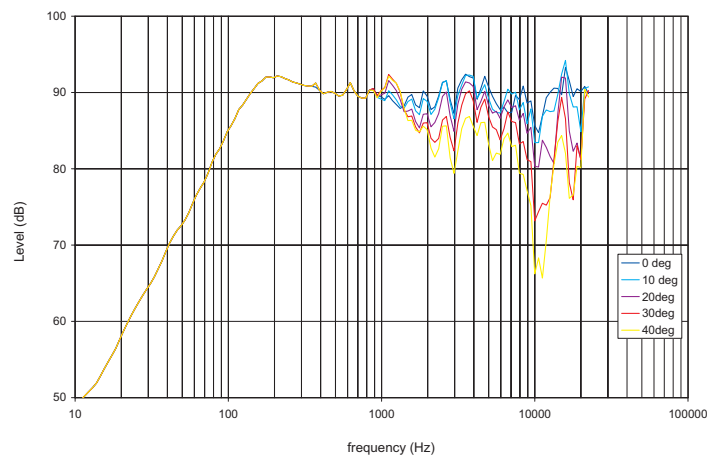

OFF AXIS
RESPONSE

Tannoy United Kingdom
Tannoy North America
Tannoy Deutschland
Tannoy France

T: 00 44 (0) 1236 420199
T: 00 1 (519) 745 1158
T: 00 49 (180) 1111 881
T: 00 33 (0)1 7036 7473

E: enquiries@tannoy.com
E: inquiries@tannoyna.com
E: anfragen@tannoy.com
E: ventes@tannoy.com

tannoy.com



Definition Install iw60 EFX

TANNOY®

PERFORMANCE MEASUREMENTS

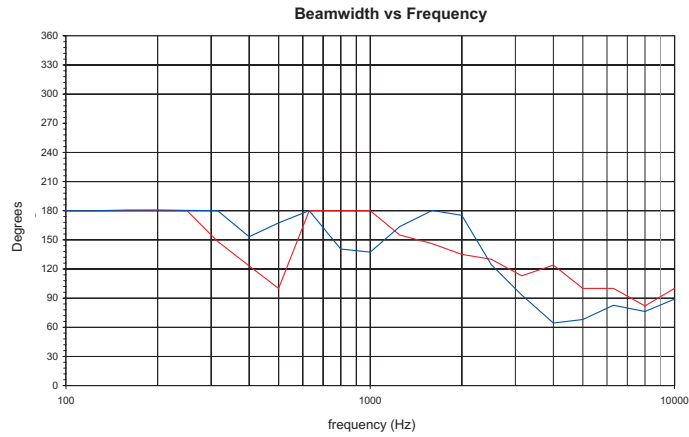

BEAMWIDTH

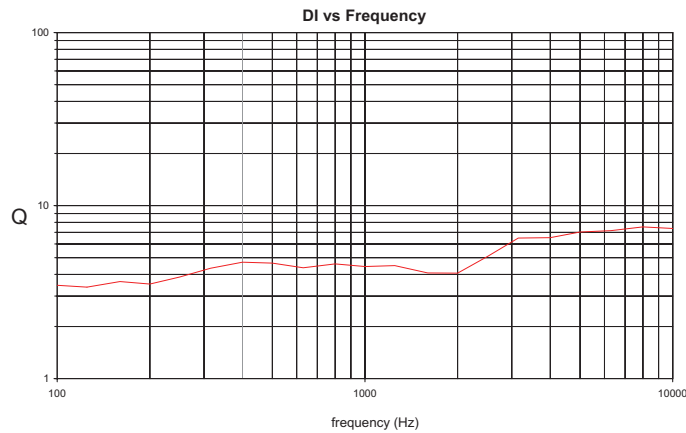

DIRECTIVITY INDEX

Tannoy United Kingdom
Tannoy North America
Tannoy Deutschland
Tannoy France

T: 00 44 (0) 1236 420199
T: 00 1 (519) 745 1158
T: 00 49 (180) 1111 881
T: 00 33 (0)1 7036 7473

E: enquiries@tannoy.com
E: inquiries@tannoy.com
E: anfragen@tannoy.com
E: ventes@tannoy.com

tannoy.com



Definition Install iw60 EFX

TANNOY®

PERFORMANCE MEASUREMENTS POLAR PLOTS (1/3 OCTAVE)

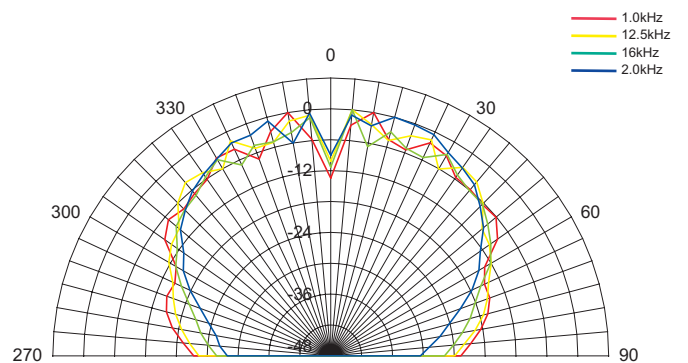
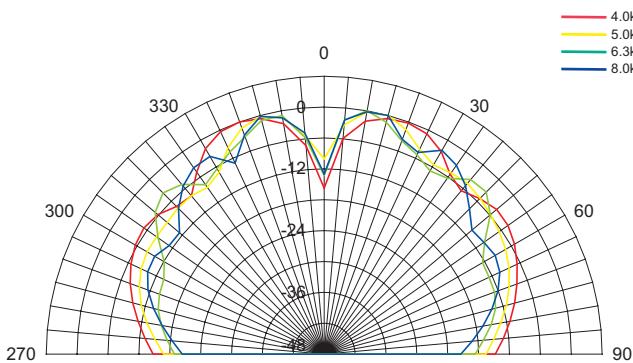
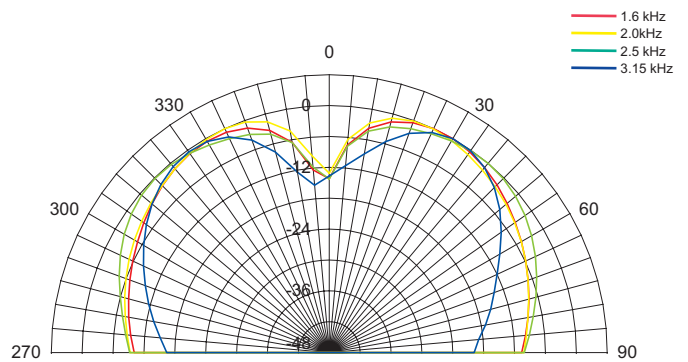
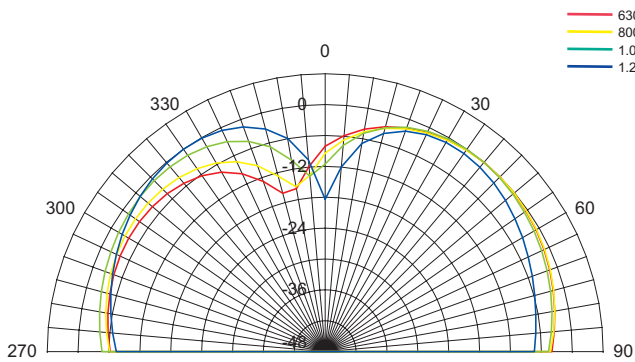
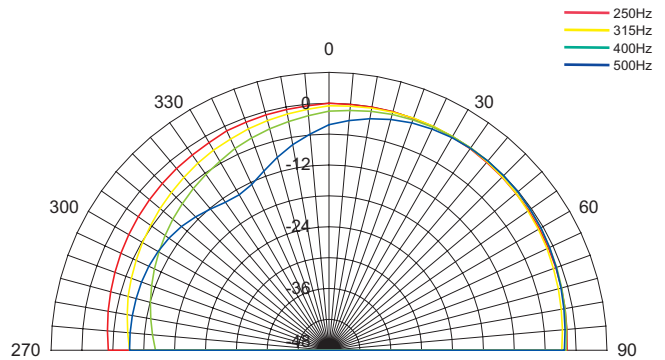
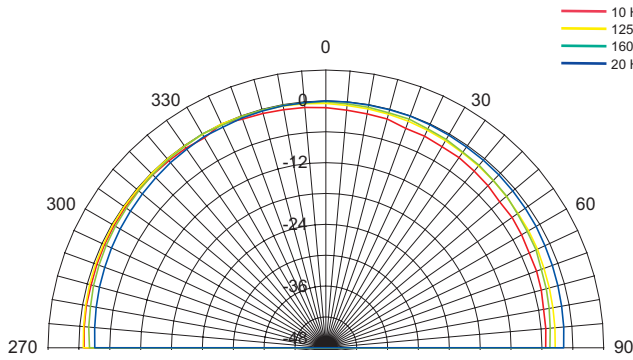

Tannoy United Kingdom
 Tannoy North America
 Tannoy Deutschland
 Tannoy France

T: 00 44 (0) 1236 420199
 T: 00 1 (519) 745 1158
 T: 00 49 (180) 1111 881
 T: 00 33 (0) 1 7036 7473

E: enquiries@tannoy.com
 E: inquiries@tannoyna.com
 E: anfragen@tannoy.com
 E: ventes@tannoy.com

tannoy.com



Definition Install iw60 EFX

TANNOY®

PERFORMANCE MEASUREMENTS POLAR PLOTS (1/3 OCTAVE)

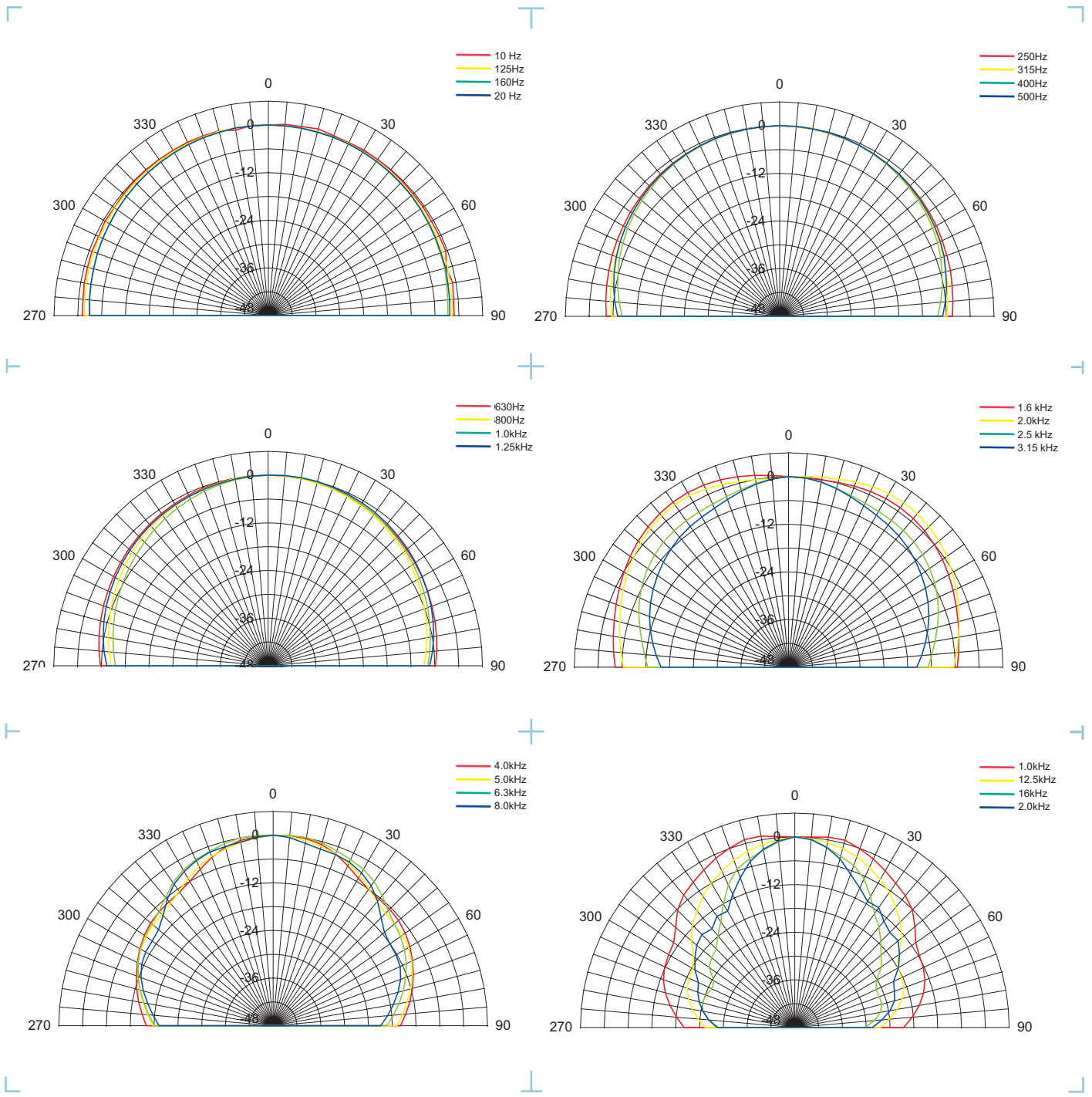

Tannoy United Kingdom
 Tannoy North America
 Tannoy Deutschland
 Tannoy France

T: 00 44 (0) 1236 420199
 T: 00 1 (519) 745 1158
 T: 00 49 (180) 1111 881
 T: 00 33 (0)1 7036 7473

E: enquiries@tannoy.com
 E: inquiries@tannoyna.com
 E: anfragen@tannoy.com
 E: ventes@tannoy.com

tannoy.com

DIMENSIONAL SKETCHES

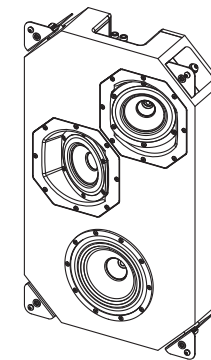
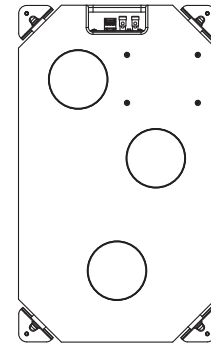
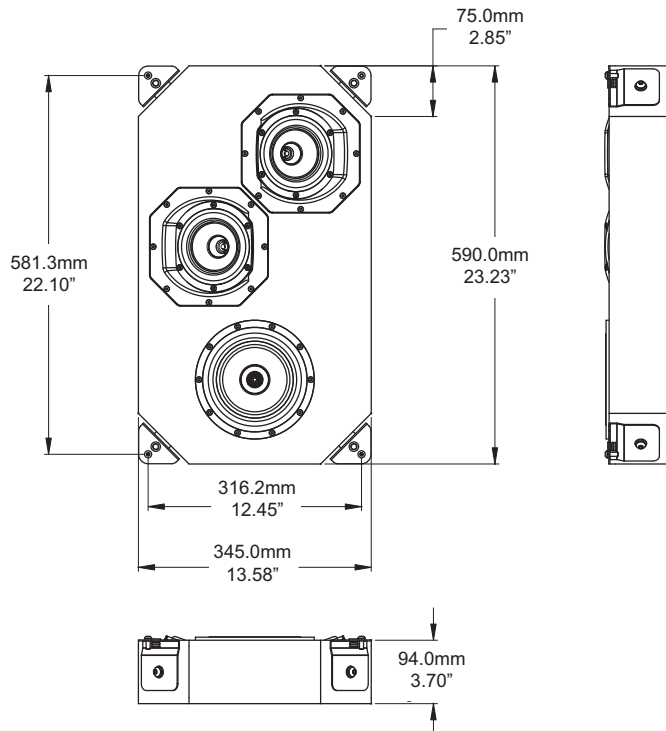

OPTIONAL ACCESSORY PRE-INSTALLATION FRAME

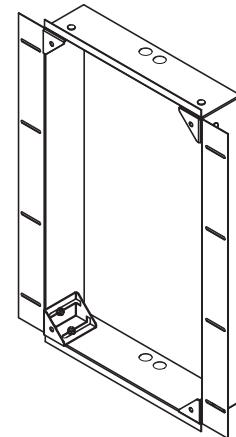
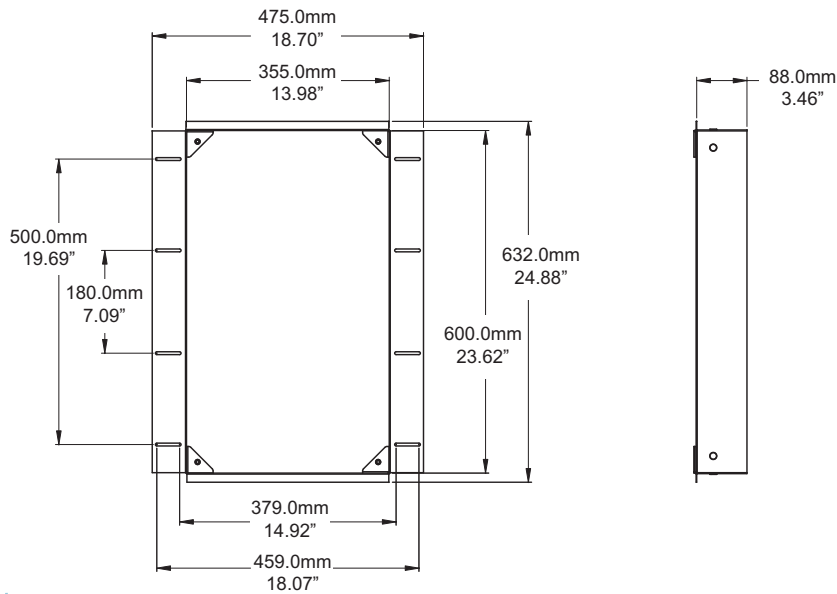

Ordering Information

PART NUMBER	MODEL NAME	COLOUR	PACKED QUANTITY
8000 5640	Pre-Install Frame - Definition Install	Unpainted metal	1

Tannoy United Kingdom
Tannoy North America
Tannoy Deutschland
Tannoy France

T: 00 44 (0) 1236 420199
T: 00 1 (519) 745 1158
T: 00 49 (180) 1111 881
T: 00 33 (0)1 7036 7473

E: enquiries@tannoy.com
E: inquiries@tannoyna.com
E: anfragen@tannoy.com
E: ventes@tannoy.com

tannoy®.com



Architectural specifications

The loudspeaker shall consist of one 165mm (6.50") full range, point source Dual Concentric™ for Music Mode and two further 100mm (4.00") full range, point source Dual Concentric™ transducers in dipole configuration for Cinema Mode. The low and high frequency elements of the Dual Concentric™ shall be combined by an internal passive crossover network operating at 1.6kHz, with dynamic HF protection.

Performance of the loudspeaker, without any electronic control, shall meet or exceed the following criteria: Frequency range measured at 1 metre on axis with swept sine wave shall be 74Hz to 27kHz. Sensitivity shall be at least 90dB (anechoic) for 2.83 Volts @ 1 metre and shall be capable of producing a peak output level of 116dB (anechoic) on axis at 1 metre. The nominal coverage angles of the loudspeaker shall be 90 degrees conical in music mode and 120 degrees horizontal by 90 degrees in cinema mode. The system shall have a nominal impedance of 8 Ohms in music mode and 4 ohms in cinema mode. The maximum power handling shall be 200 Watts (programme).

The enclosure shall be an optimally tuned 11.50 litre closed MDF construction finished in textured black paint and supplied with a white powder coated perforated steel grille. Connectors shall be gold plated spring terminals. Controls shall be a mode selection input activated by a 12V DC relay via a Dinkle connector and a polarity switch.

The enclosure shall not exceed the following dimensions: 590 x 345 x 94mm (23.23 x 13.58 x 3.70") (H x W x D).

The in wall loudspeaker shall be the Tannoy... Definition Install iw60 EFX.

Tannoy United Kingdom
Tannoy North America
Tannoy Deutschland
Tannoy France

T: 00 44 (0) 1236 420199
T: 00 1 (519) 745 1158
T: 00 49 (180) 1111 881
T: 00 33 (0)1 7036 7473

E: enquiries@tannoy.com
E: inquiries@tannoyna.com
E: anfragen@tannoy.com
E: ventes@tannoy.com

tannoy®.com

Free Manuals Download Website

<http://myh66.com>

<http://usermanuals.us>

<http://www.somanuals.com>

<http://www.4manuals.cc>

<http://www.manual-lib.com>

<http://www.404manual.com>

<http://www.luxmanual.com>

<http://aubethermostatmanual.com>

Golf course search by state

<http://golfingnear.com>

Email search by domain

<http://emailbydomain.com>

Auto manuals search

<http://auto.somanuals.com>

TV manuals search

<http://tv.somanuals.com>