

TANNOY®



REVEAL

6D 66D & 8D ACTIVE STUDIO MONITORS

OWNERS MANUAL

REVEAL | **WIDEBAND**
TECHNOLOGY

Tannoy United Kingdom	T: +44 (0) 1236 420199	F: +44 (0) 1236 428230	E: enquiries@tannoy.com
Tannoy North America	T: (519) 745 1158	F: (519) 745 2364	E: inquiries@tannoyna.com
Tannoy Deutschland	T: (04102) 888 393	F: (04102) 888 959	E: info@tannoy.com

Tannoy adopts a policy of continuous improvement and product specification is subject to change.

tannoy.com

6481 0412

1.0: IMPORTANT SAFETY INSTRUCTIONS	1.1	Introduction
2.0: THE BASICS	2.1	Unpacking and visual checks
	2.2	Preliminary recommendation
3.0: REVEAL D SERIES FEATURES	3.1	Analog Input
	3.2	Digital SPDIF Input
	3.3	Connecting your speakers
	3.4	User Controls
4.0: EQUALISATION POSSIBILITIES		
5.0: GUIDE TO SETTING THE EQUALISATION		
6.0: PLACEMENT OF THE SPEAKERS	6.1	Orientation (R6D & R8D)
	6.2	Positioning (R6D & R8D)
	6.3	Positioning (R66D)
	6.4	Speaker Mounting
	6.5	Bass Ports
7.0: PERFORMANCE DATA		Reveal 6D Reveal 8D Reveal 66D
8.0: TECHNICAL SPECIFICATIONS		
9.0: DIMENSIONS		
10.0: SERVICING	6.1	Cabinet Finish
	6.2	Driver Removal
	6.3	Amplifier Removal
	6.4	Spare parts
11.0: WARRANTY		
12.0: DECLARATION OF CONFORMITY		

1.0: IMPORTANT SAFETY INSTRUCTIONS

1. Read these instructions.
2. Keep these instructions.
3. Heed all warnings.
4. Follow all instructions.



The lightning flash with an arrowhead symbol within an equilateral triangle, is intended to alert the user to the presence of uninsulated "dangerous voltage" within the product's enclosure that may be of sufficient magnitude to constitute a risk of electric shock to persons.



The exclamation point within an equilateral triangle is intended to alert the user to the presence of important operating and maintenance (servicing) instructions in the literature accompanying the product.

5. Do not use this apparatus near water.
6. Clean only with dry cloth.
7. Do not block any ventilation openings. Install in accordance with manufacturer's instructions.
8. Do not install near any heat sources such as radiators, heat registers, stoves, or other apparatus (including amplifiers) that produce heat and ensure adequate air circulation around the rear of the product.
9. Do not defeat the safety purpose of the polarised or grounding-type plug. A polarised plug has two blades with one wider than the other. A grounding type plug has two blades and a third grounding prong. The wide blade or the third prong are provided for your safety. If the provided plug does not fit into your outlet, consult an electrician for replacement of the obsolete outlet.
10. Protect the power cord from being walked on or pinched particularly at plugs, wall sockets, and the point where they exit from the apparatus.
11. Only use attachments/accessories specified by the manufacturer.
12. Unplug this apparatus during lightning storms or when unused for long periods of time.
13. Refer all servicing to qualified service personnel. Servicing is required when the apparatus has been damaged in any way, such as power-supply cord or plug is damaged, liquid has been spilled or objects have fallen into the apparatus, the apparatus has been exposed to rain or moisture, does not operate normally, or has been dropped.
14. **WARNING:** To reduce the risk of fire or electrical shock, this apparatus should not be exposed to rain or moisture and objects filled with liquids, such as vases, should not be placed on this apparatus.
15. To completely disconnect this equipment from the mains, disconnect the power supply cord plug from the wall socket.
16. The mains plug on the power supply cord shall remain readily accessible.
17. **SAFETY WARNING:** This product design uses amplifier output stages with substantial standing currents for optimal sound quality. Fit and use the protective heat shield when adjusting the feature controls above the heatsink, to prevent contact with uncomfortably hot surfaces when monitoring at continuously high sound pressure levels. Use the small tool provided to adjust the switches in accordance with the instructions in the user manual.

ELECTRICAL REQUIREMENTS

Check that the voltage rating displayed on the rear panel is correct for your area before connecting. If it is incorrect, please refer to your local dealer or authorised service agent, as no user adjustment is provided.

Warning!

- To reduce the risk of fire or electric shock, do not expose this apparatus to rain or moisture.
- Be advised that different operating voltages require the use of different types of line cord and attachment plugs.
- Check the voltage in your area and use the correct type. See table below:

Voltage	Line plug according to standard
110-125V	UL817 and CSA C22.2 no 42.
220-230V	CEE 7 page VII, SR section 107-2-D1/IEC 83 page C4.
240V	BS 1363 of 1984. Specification for 13A fused plugs and switched and un-switched socket outlets.

Service

There are no user-serviceable parts inside. Qualified personnel must perform all service. Servicing is required when: -

- The unit has been damaged in any way, such as when the power-supply cord or plug is damaged.
- The unit has been exposed to rain or moisture, or liquid has been spilled into the unit.
- Objects have fallen into the unit.
- The unit does not work properly.
- The unit has been dropped.

EUROPEAN MODELS

A mains cable is supplied with an IEC moulded socket at one end and a moulded mains plug at the other end. Where the moulded plug is fitted with a mains fuse, always replace with the same 5A rated fuse. If the fitted plug is unsuitable for your type of outlet sockets, it should be cut off and disposed of safely, in case it is inserted into a live socket elsewhere. The wires in the mains cable are coloured in accordance with the following code:

GREEN AND YELLOW EARTH BLUE NEUTRAL BROWN LIVE

AS THE COLOURS OF THE WIRES IN THE MAINS CABLE MAY NOT CORRESPOND WITH THE COLOURED MARKINGS IDENTIFYING THE TERMINALS IN YOUR PLUG, PROCEED AS FOLLOWS:

The wire which is coloured GREEN AND YELLOW must be connected to the terminal in the plug which is marked either by the letter E, the earth safety symbol, or coloured GREEN or GREEN and YELLOW.

The wire which is coloured BLUE must be connected to the terminal in the plug which is marked by the letter N or coloured BLACK

The wire which is coloured BROWN must be connected to the terminal in the plug which is marked by the letter L or coloured RED.

Ensure that the terminals are tightened securely, and no loose strands of wire are present. Ensure cord grip is clamped over outer sheath of cable, rather than over the wires.

FUSE PROTECTION

An additional mains fuse is provided in the IEC power inlet on the back of the loudspeaker, which can only be removed with the power cord unplugged. This must be replaced by a fuse of the same type and ratings (see Specifications or refer to rear panel).

INSTALLATION

Do not install this equipment in an enclosed space. Do not limit free ventilation and movement of air around the back panel. Do not install this equipment in a cupboard with a closed door. Allow for a distance of 150mm (6 inches) of free air space around all sides, top, bottom and the back panel of this product. The user must be able to see the blue coloured front panel of this product when in use.

EMC

This equipment has been tested and found to comply with the limits for a Class B digital device, pursuant to part 15 of the FCC Rules. These limits are designed to provide reasonable protection against harmful interference in a residential installation. This equipment generates uses and can radiate radio frequency energy and, if not installed and used in accordance with the instructions, may cause harmful interference to radio communications. However, there is no guarantee that interference will not occur in a particular installation. If this equipment does cause harmful interference to radio or television reception, which can be determined by turning the equipment off and on, the user is encouraged to try to correct the interference by one or more of the following measures:

- Reorient or relocate the receiving antenna.
- Increase the separation between the equipment and receiver.
- Connect the equipment into an outlet on a circuit different from that to which the receiver is connected.
- Reorient or coil cables.
- If necessary, consult the dealer or an experienced radio/television technician for additional suggestions.

Any cables the user adds to the device must be shielded to be in compliance with the FCC standards. Any unauthorised modification to this device could result in the revocation of the end user's authority to operate this device.

This device complies with Part 15 of FCC rules. Operation is subject to the following two conditions: (1) This device may not cause harmful interference, and (2) This device must accept any interference received, including interference that may cause undesired operation.

Canada

Industry Canada Class B emission compliance statement. This Class B digital apparatus complies with Canadian ICES-003. Avis de conformité à la réglementation d'Industrie Canada. Cet appareil numérique de classe B est conforme à la norme NMB-003 du Canada.

1.1: INTRODUCTION

The Tannoy Reveal Digital range of near field monitoring speakers builds upon the success and worldwide reputation of the famous original Tannoy Reveal Active. Since the launch of the original Tannoy Reveal Active in 1998 there have been significant advances in digital speaker measuring techniques, acoustic CAD design and simulation, and precision manufacturing processes.

The Tannoy Reveal Digital range now provides greater bandwidth, significantly lower levels of distortion, smoother responses, more accurate phase control, and higher sensitivity levels; all within compact cabinet sizes. Also, much has been learnt about the near field listening environment - the effects of boundary walls, acoustic reflections from mixing console surfaces and the acoustic properties of often sparsely prepared PC/Mac post production editing situations.

The Tannoy Reveal Digital range of monitoring speakers can be optimised for far field, mid field and near/close field free space situations right through to far field, mid field and near/close field situations in difficult acoustic spaces such as meter bridge positions, adjacent to walls or reflecting surfaces and space restricted PC/Mac based sound editing environments.

Acoustic space environments are referred to as 4pi, 2pi and pi representing the solid angle in space (steradians) into which the speaker is radiating. These environments are frequently referred to as free space, half space and quarter space listening conditions. The type of acoustic space into which a speaker radiates, defined by nearby solid boundaries, affects the acoustic air load presented to the speaker and so the relative radiating efficiency at various frequencies. In different pi spaces the linearity of the amplitude response changes, especially within the band 50Hz to 800Hz.

Varying distances encountered between the monitors and the listener are generally referred to as far field (greater than 3m or 10 feet), mid field (2 to 3m or 6 to 10 feet), near field (1 to 2m or 3 to 6 feet) and close field (around 0.5m or 1.5 feet). The proximity of the listener to the speaker changes the way the listener perceives the sound balance from the speaker. At large distances from an acoustic source plane waves are perceived. At small distances from an acoustic source the waves appear spherical.

2.0: THE BASICS 2.1: UNPACKING AND VISUAL CHECKS

The Reveal 6D's are packed in pairs and the Reveal 8D and 66D's are packed singly. To remove the speakers from the carton without damage open the end flaps fully and bend them right back (remember they are packed in pairs). Turn the package upside-down on the floor and lift the carton vertically up to leave the speakers resting on their packing tray. Nothing on or in your speakers should rattle about. Inspect each speaker for signs of transit damage. In the unlikely event of this having occurred inform the carrier and the supplier. Keep all the packaging if damage has occurred, as this will show evidence of excessive handling forces. It is also a good idea to keep the packaging if possible for future transportation.

2.2: PRELIMINARY RECOMMENDATION

Initially we would like to give a word of warning on high sound levels, which these speakers are capable of generating over sustained periods of time. Levels over 95 dB for 8 hours per day can eventually cause permanent hearing loss. Because Tannoy monitors have very low levels of time, amplitude and frequency distortion it is not always obvious that the sound level is high while working with them.

For continuous exposure we recommend the occasional use of a sound level meter capable of integrating the sound level over a period of exposure according to noise control standards. This should be used just to check that noise levels are always within safety limits.

3.0: REVEAL D SERIES FEATURES

A set of DIP switches on the rear panel of each speaker can be set to choose the optimum speaker response for these real life and often difficult situations, so that the frequency response from the speaker is always substantially flat. We are not equalising the room modes due to standing waves or resonant structures, we are equalising the speaker to take account of the varying air load presented by the room and surrounding large structures such as the mixing desk.

The switches are arranged in groups according to their function and each switch can be set to the 'on' (down) or 'off' (up) position in various combinations to achieve a flatter, more balanced response within a wide variety of acoustic spaces and with far, mid, near and close field monitoring positions.

Figure 1 shows the range of equalisation available in the 50Hz to 800Hz region and also shows the degree of trim available in the bass, upper midrange and high frequency areas,

An A/V 80Hz high pass filter switch provides instant conversion to 5.1 and higher order systems where a separate subwoofer below 80Hz is required. Filter characteristics are according to the international standards for this setup. This response is also shown diagrammatically in Figure 1.

Listening to well recorded male or female spoken word or vocals at the normal listening position is a good way to check and optimise the available settings. Difficult environments and variable listening distances produce varying degrees of boost from the flat position in the 50Hz to 800Hz area. Graphical representations of the responses available by setting the switches are shown below. The linear or flat response positions for the DIP switches are always clearly shown in the diagrams below and also on the rear panel of the speaker.

The Tannoy ActivAssist™ software package is available to help with the DIP switch settings. Using a standard laptop with the microphone and cables supplied in the pack, the performance of the speaker in a particular environment can be assessed and a recommended set of switches set up.

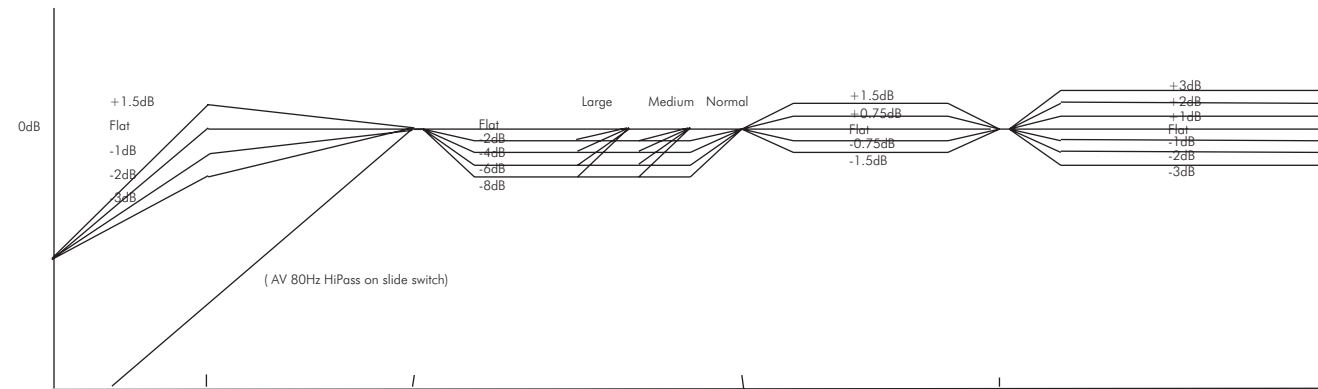

Fig. 1. Full range of equalisation and trim available.

3.1: ANALOG INPUT

XLR: 2= +ve (hot), 3= -ve (cold), 1= screen, shield or signal ground.
 3 way Jack: tip= +ve (hot), ring= -ve (cold), sleeve= screen, shield or signal ground.
 For unbalanced XLR connection short pin 1 to pin 3 and use 2= +ve (hot), 3= -ve (ground).
 For unbalanced 3 way Jack short ring to sleeve and use tip= +ve (hot), sleeve= -ve (ground).

3.2: DIGITAL SPDIF INPUT

The input impedance is the SPDIF specification at 75 ohms and the 24 bit DAC supports 44.1, 48 and 96kHz sampling rates. Please use a high quality* SPDIF coaxial phono (RCA) cable to connect the source equipment (eg CD player, DAT/ADAT or PC sound card) to one of the speakers. Connect a second (phono to phono) high quality cable from this speaker to the second speaker of the stereo pair. Select whether each speaker converts left channel or right channel audio as appropriate using the switch adjacent to the SPDIF input connector. For true mono requirements set the switch to mono. If volume can be controlled from the source equipment, set the source equipment volume level to minimum and the speaker volume control to maximum (fully clockwise). If volume cannot be controlled by the source equipment (eg a simple CD or DAT etc) set the volume control on the speaker to minimum (fully anticlockwise) to prevent excessive sound levels. The volume control adjusts the analogue level after the DA converters to preserve the full digital dynamic range.

* In order to comply fully with EMC regulations, the SPDIF input and SPDIF thru should be connected using metal-shelled connectors and good quality shielded cable suitable for digital audio.

3.3: CONNECTING YOUR SPEAKERS

Having chosen an appropriate location for your monitors and arranged them accordingly, connect the power cord to the mains socket and turn the power on. The LED on the front panel will now glow red. Push the Tannoy logo on the front panel to operate the switch to bring the amplifier out of standby mode and into operational mode. Set the volume control on the rear panel to zero (fully anticlockwise). Connect the audio signal source (console output) to the input connector (combined XLR/jack socket) or SPDIF at the back of the monitor.

3.4: USER CONTROLS

A/V (80Hz): a switch to the bottom left of the bank of DIP switches sets the system high pass filter to either flat or -6dB at 80Hz. The 80Hz setting is used when the speakers are in combination with a subwoofer for low frequency effects such as Dolby Digital, AC3, DTS etc playback situations. For all other situations set this switch to flat. This response can be seen in Figure 1 above.

Left/Right/Mono: a switch at the bottom left of the bank of DIP switches sets the SPDIF DAC to sense the left, right or combined stereo information (mono) from the digital stream. Set the left hand speaker to 'Left' and the right hand speaker to 'Right' for 2 channel stereo, or to 'mono' for single speaker monitoring.

Analogue/Digital: a switch adjacent to the XLR/Jack combi socket selects whether the speaker is receiving a signal from the balanced/unbalanced analogue input combi socket, or, from the SPDIF phono (RCA) digital input. Both may be connected simultaneously but only one can be selected at any one time.

4.0: EQUALISATION POSSIBILITIES

Note: In the diagrams which follow, the corner frequency shown as 50Hz will vary according to the specification relating to the particular model which has been chosen. Please refer to the detailed specification section at the end of this manual for more details. Smaller models will have a slightly higher corner frequency and larger models will have a lower corner frequency. The diagrams have been prepared to make the visualisation of the EQ possibilities easier to understand. The transitions of the speaker amplitude response between frequency bands will be gradual and not as sharp as the diagrams show. Note the +10dB and -10dB calibrations on the charts. EQ settings should never be at opposite extremes eg -8dB low mid contour with -2dB mids and +3dB highs.

There are 4 basic frequency bands that can be adjusted. The range of adjustment is purposely restricted so that although effective in the majority of environments, it is difficult to set the speaker to have a totally unacceptable response. A 'flat' setting means flat within specification as measured in an anechoic chamber, on axis, under free field conditions in the far field (3 metres away). The frequency bands are:

Bass Corner Frequency: The 'Q' value of the bass unit and cabinet volume alignment can be altered giving +3dB, flat, -1.5, -3, and -4.5 dB relative to the -3dB point shown in the specification. This provides a degree of boost and cut in the 45Hz to 65Hz area. Figure 2 shows the range of adjustment available together with the DIP switch settings for the first 4 DIP switches. All other DIP switches are shown in the anechoic flat positions.

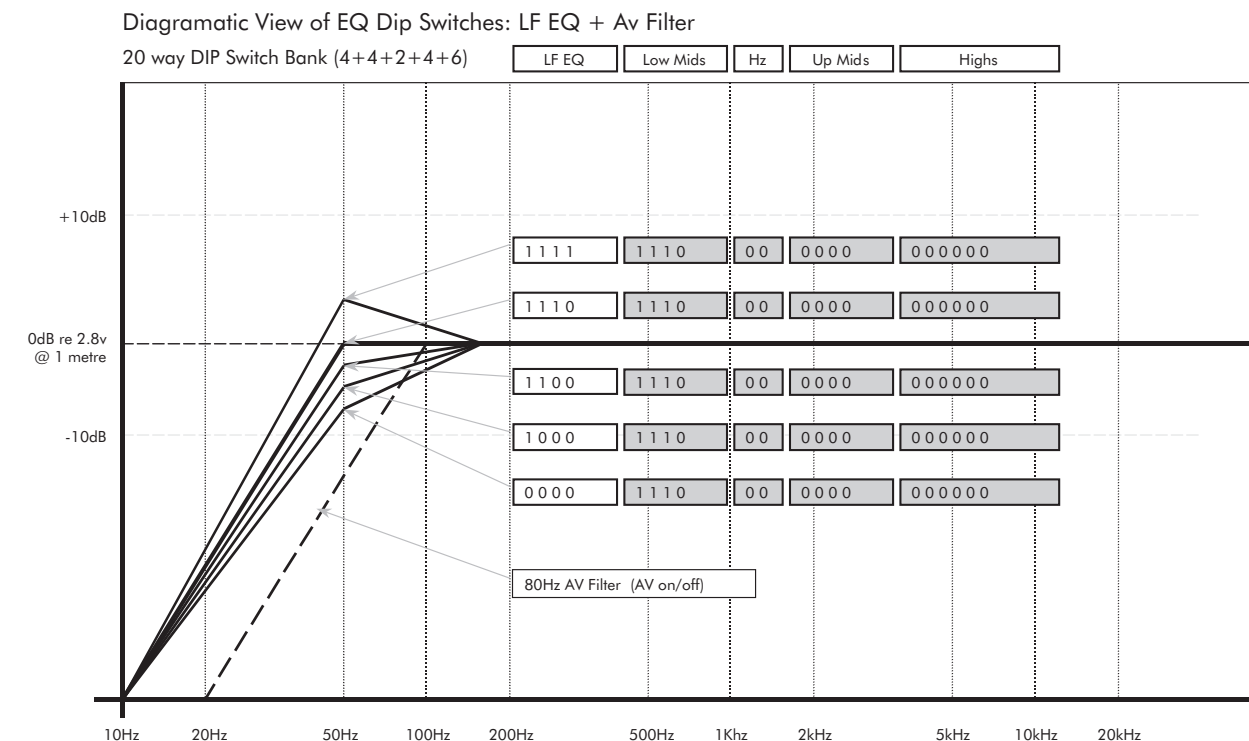

Fig. 2. Range of adjustment available and settings for the first 4 DIP switches. All other DIPs set to 'Flat'

Low Mid Contour Frequency: A shelving filter can be set to the flat anechoic response or set to shelve at frequencies of 800Hz, 400Hz, or 200Hz in combination with the low mid contour amplitude (below) to correct half space ($\pi/2$), quarter space ($\pi/4$) and very difficult close field boundary conditions ($\pi/8$ space).

Low Mid Contour: a shelving filter can be set to a flat anechoic response or to -2dB, -4dB, -6dB or -8dB in combination with the low mid contour frequency (above) to correct mid, near and close field listening positions compared with free space, far field conditions.

Figures 3, 4 and 5 below show the range of amplitude settings at 800Hz, 400Hz and 200Hz and the DIP switch settings. DIPs 5 to 8 (inclusive) control the amplitude responses and switches 9 and 10 control the frequency at which the shelving starts. All other DIPs are shown in the 'Flat' position.

Baffle Step Effect: Both low mid frequency and low mid contour are used together to correct for the baffle step effect. the baffle step effect is a well known property of speakers and is caused by a change in air load on the moving diaphragm at a frequency dependant on the effective size of the baffle or cabinet frontal area compared with the wavelength of the sound being reproduced. Most speakers are designed to have a flat amplitude and phase response over the audio band in anechoic or 'free field' conditions where there are no boundary walls close to the bass drive unit. When the speaker is placed against a wall, in a corner, on a mixing console or on a table adjacent to a PC editor the wall boundaries effectively increase the baffle size. This produces a boost in the frequency band around 100 to 800 Hz depending on the effective size and proximity of the boundary surfaces, the size of the bass driver and the distance of the listener from the source.

More at: Olson, H. F. "Direct Radiator Loudspeaker Enclosures" Journal of the Audio Engineering Society Vol. 17, No. 1, 1969 October, pp.22-29

There are many more references to these effects by searching the web for 'Baffle Step Effect'.

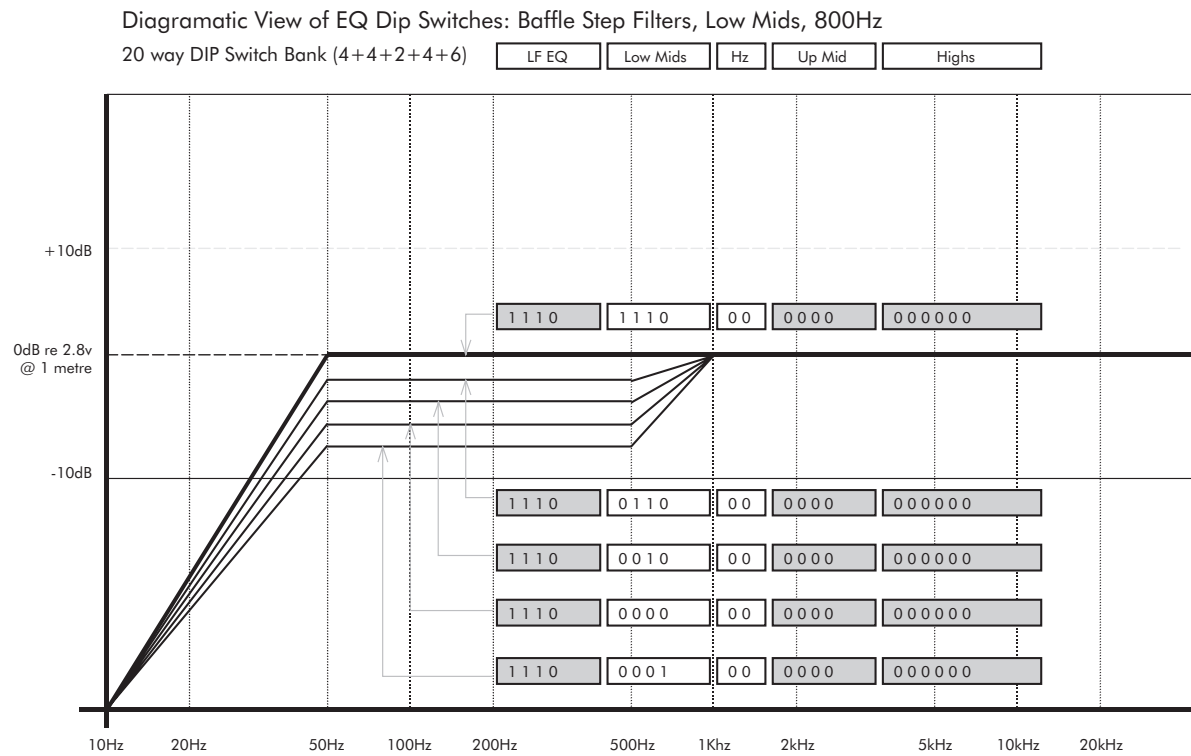

Fig. 3. DIP switches 5 to 8 control amplitude, 9 & 10 control frequency - set here to 800Hz. All other DIPs set to 'flat'.

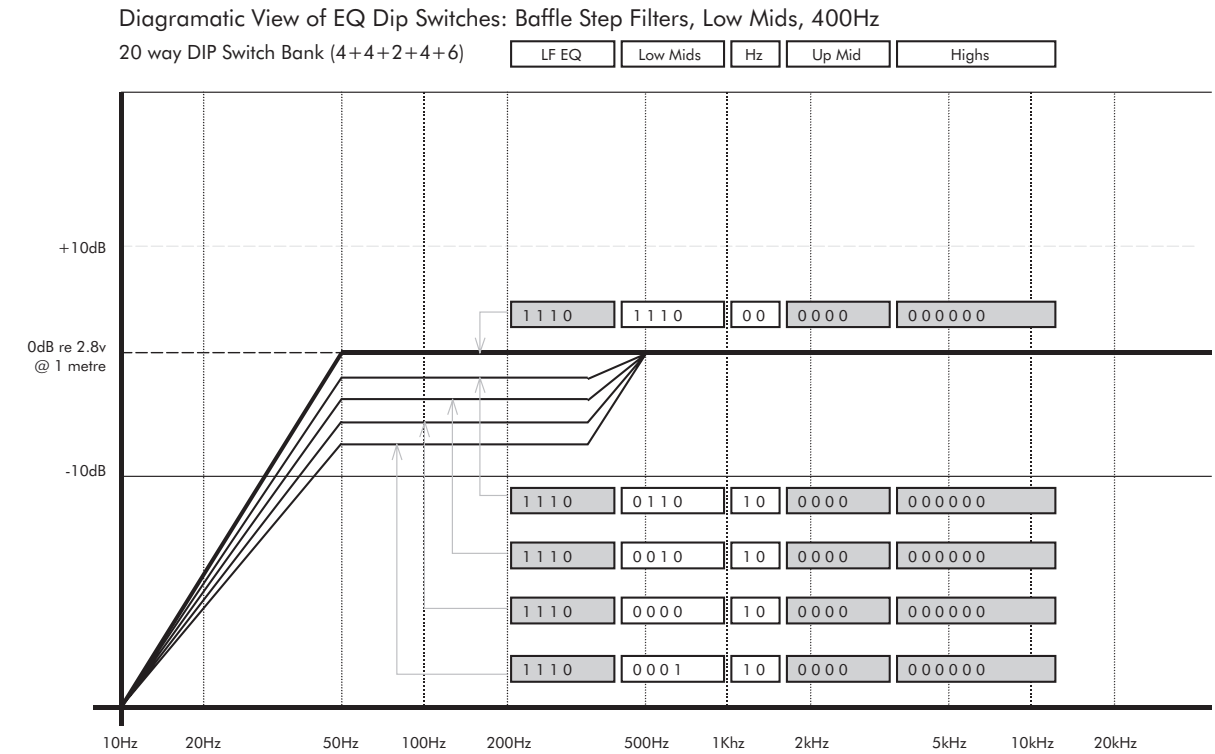

Fig. 4. DIP switches 5 to 8 control amplitude, 9 & 10 control frequency - set here to 400Hz. All other DIPs set to 'flat'.

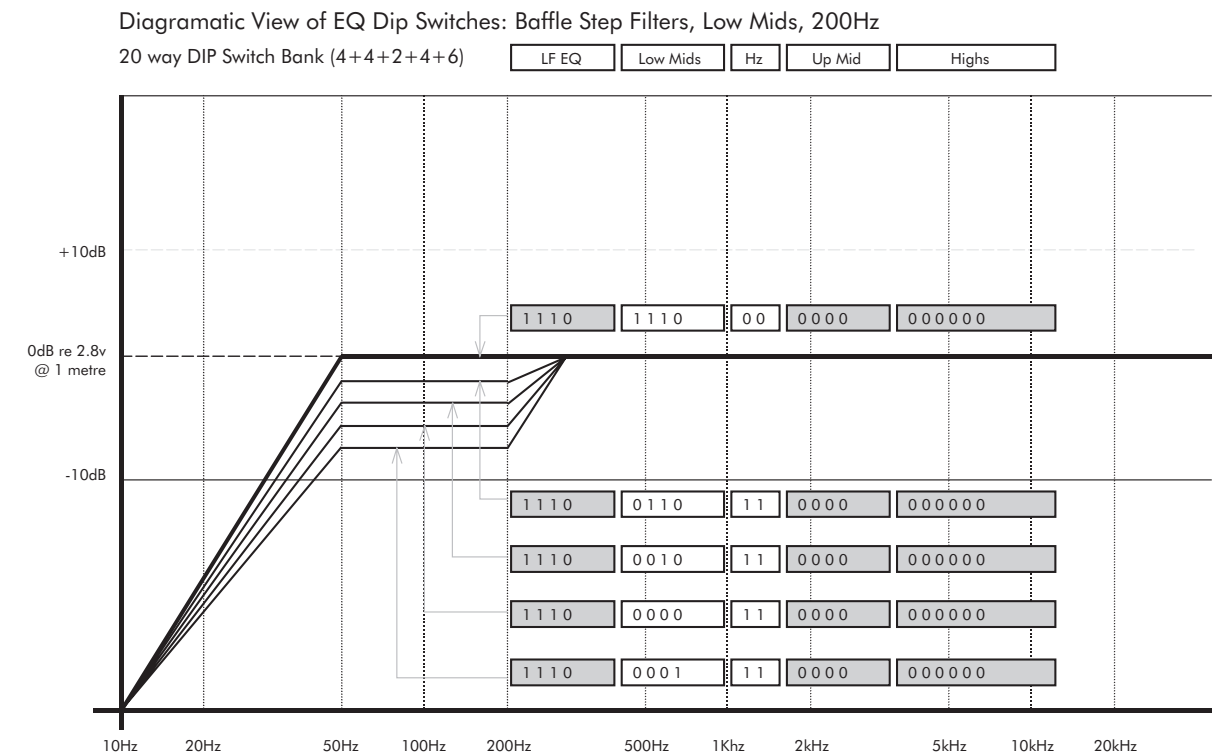

Fig. 5. DIP switches 5 to 8 control amplitude, 9 & 10 control frequency - set here to 200Hz. All other DIPs set to 'flat'.

Hi-Mid Shelf Boost/Cut: a shelving filter between 1kHz and 3kHz can be set to +2, +1dB, flat, -1dB, -2dB, to take account of room characteristics and personal preference. Editing news broadcast material is often easier with an increased output in this band. Figure 6 shows the range of adjustment in this area controlled by DIP switches 11 to 14.

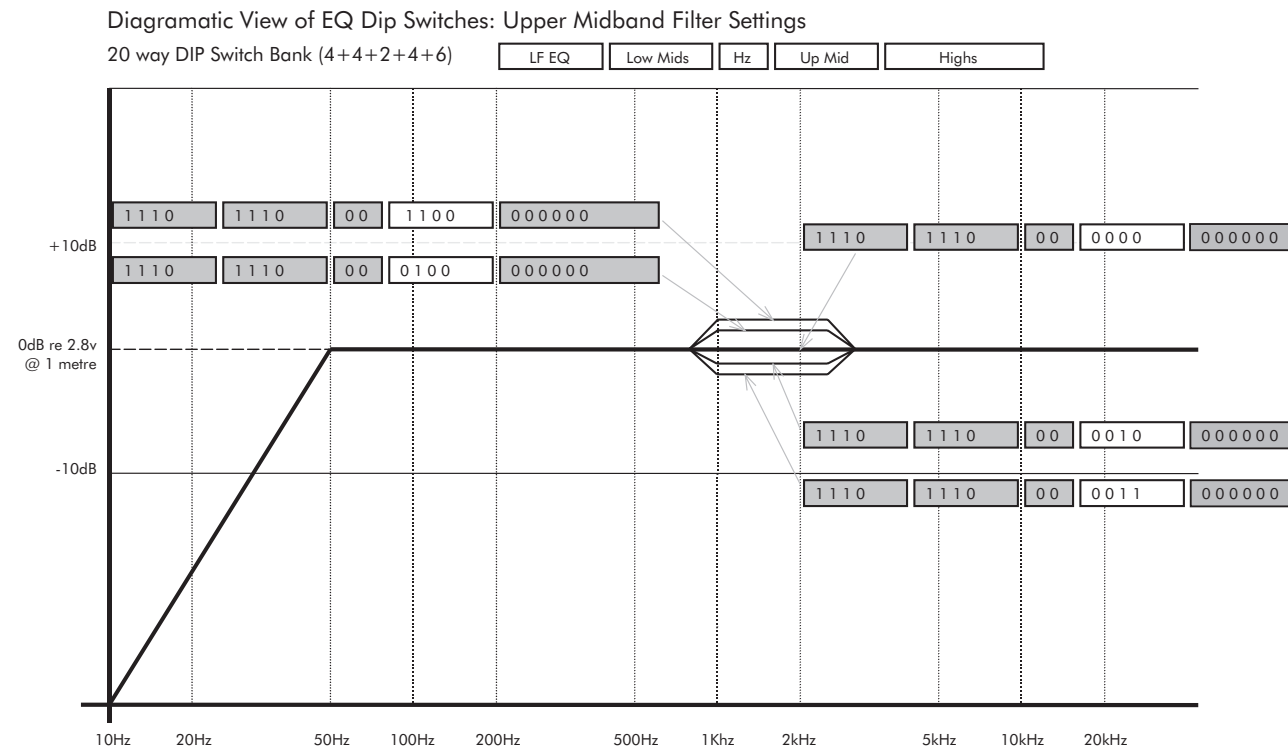

Fig. 6. Range of EQ available for DIP switches 11 to 14. All other DIPs set to 'Flat'.

High Frequency Shelf Boost/Cut: a shelving filter between 5kHz and 50kHz can be set to +3dB, +2dB; +1dB, flat anechoic, -1dB, -2dB, -3dB to take account of RT60 decay times for the environment within this band and to allow a degree of personal preference. Figure 7 shows the range available diagrammatically.

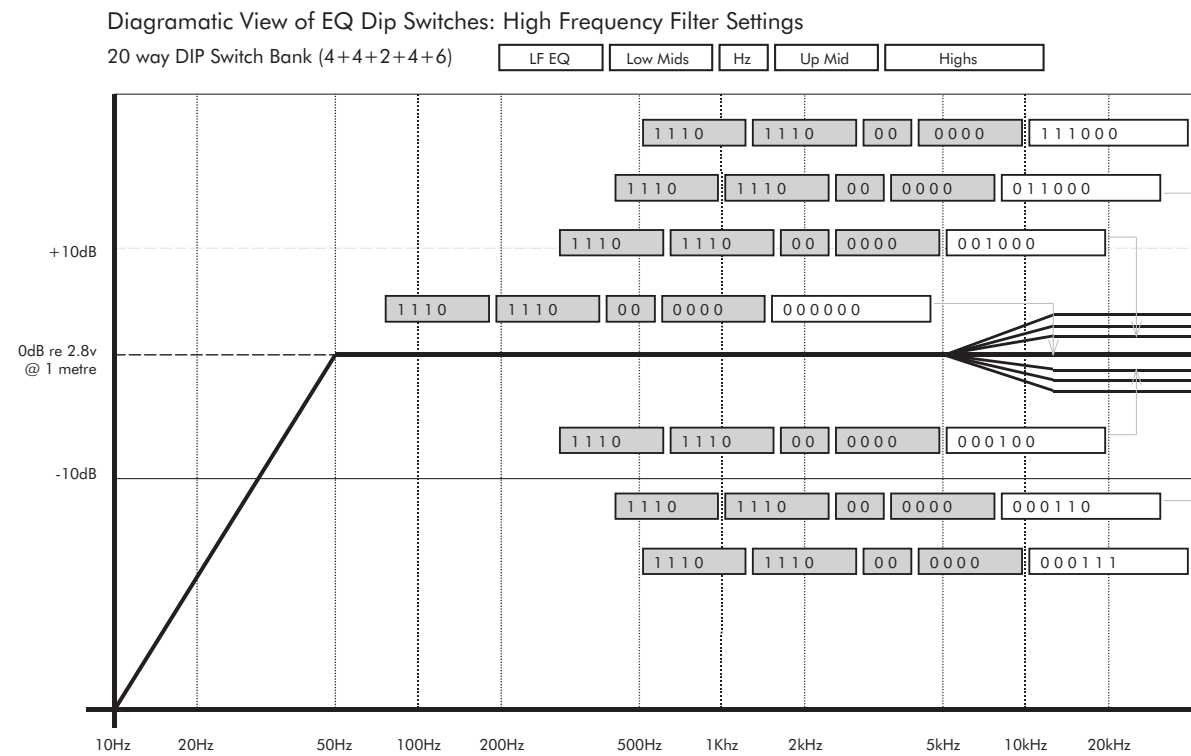

Fig. 7. The range of upper HF EQ controlled by DIP switches 15 to 20. All other DIPs set to 'Flat'

5.0: A GUIDE TO SETTING THE EQUALISATION

Assess the monitoring conditions and consider these 4 main factors:

1. The environment: free space (4pi), half space (2pi), quarter space (pi) and in the extreme, a "Difficult Space" (pi/2)
2. The distance from the speakers: far field (2 to 3m), mid field (1 to 2m), near field (0.5 to 1m) or close field (less than 0.5m)
3. The room: absorbent or reflective surfaces, estimate the RT 60 decay time above 1kHz
4. The nature of the source material: prolonged sessions working on editing bright or forward material can produce fatigue.

Free Space (4Pi): An example of free space conditions would be with the speakers mounted on tall (0.5m to 1.2m) speaker stands well away from the wall at one end of a room and with the listener 2 to 3 meters away. Under these conditions set all the DIP switches to the 'flat anechoic' position. This then provides a high quality high fidelity installation operating in good acoustically treated environments.

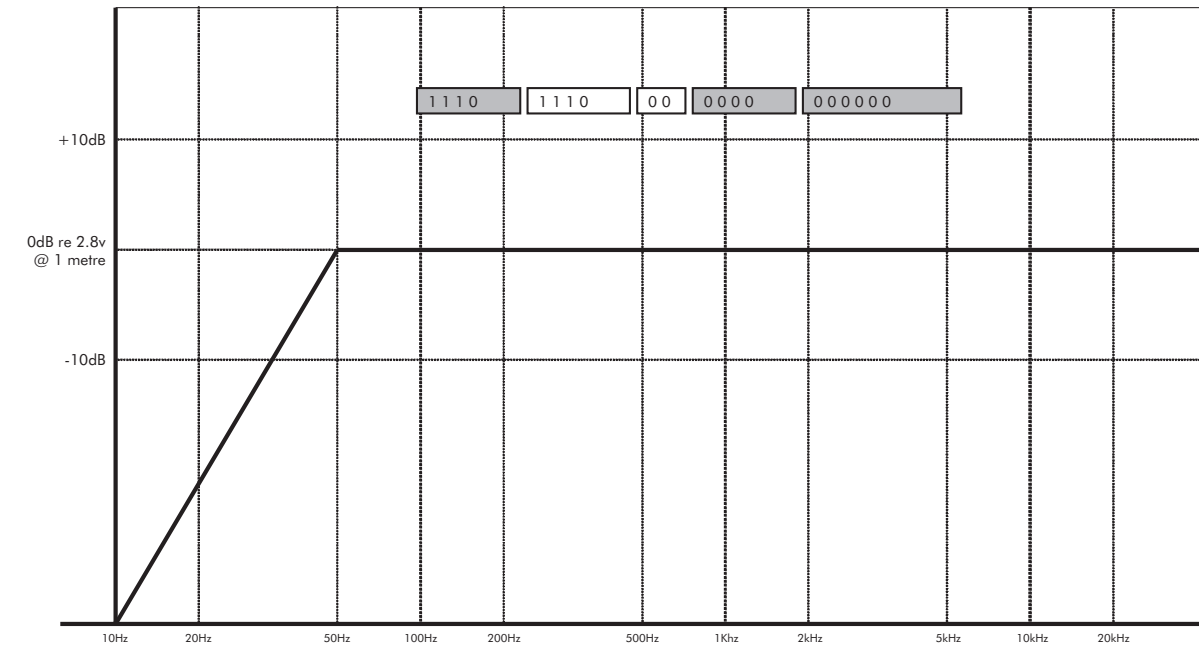

Half Space (2Pi): An example of half space would be with speakers against a wall mounted on stands as above, or on the meter bridge with the console in the centre of a room. Follow the DIP settings in the diagram below for half space (Pi/2) and adjust for the listening distance accordingly. Adjust the LF-Q settings to balance the system.

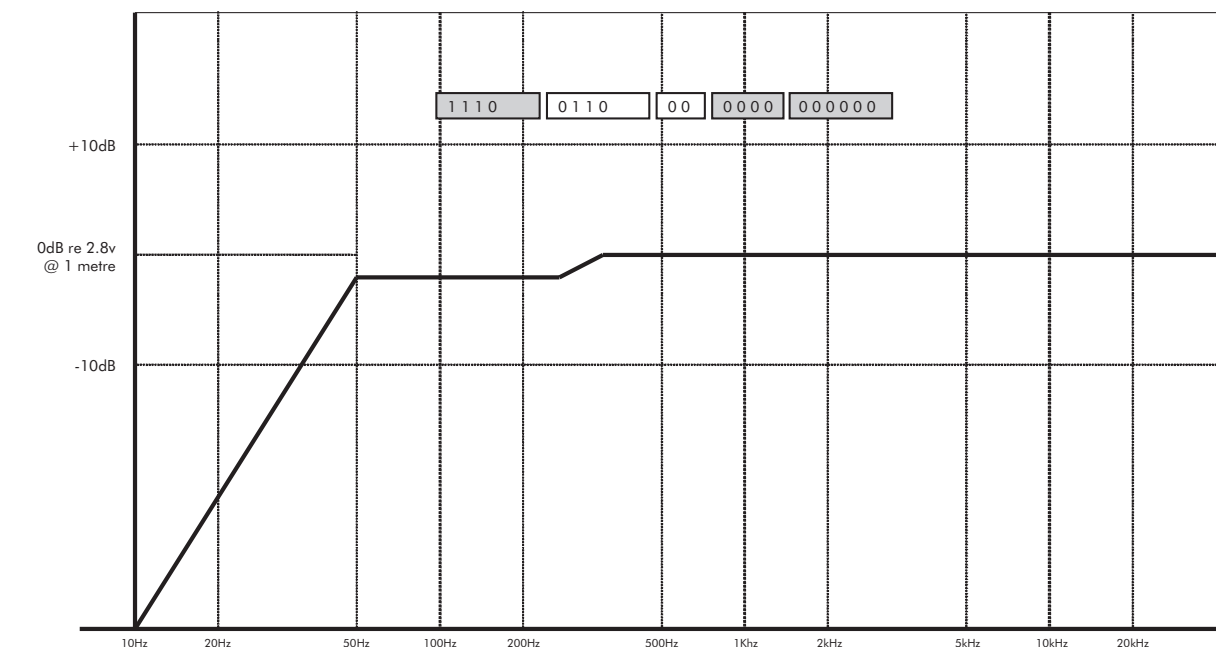

Quarter Space (Pi): An example of quarter space would be with speakers mounted on stands in a corner, or on the meter bridge against a wall or mounted on small stands or shelves against a wall. Also typical PC/Mac editing in a confined space on a desk near a wall. This is usually also a close field situation. Follow the DIP settings below for Quarter Space and adjust for the listening distance accordingly. Adjust the LF-Q settings to balance the system.

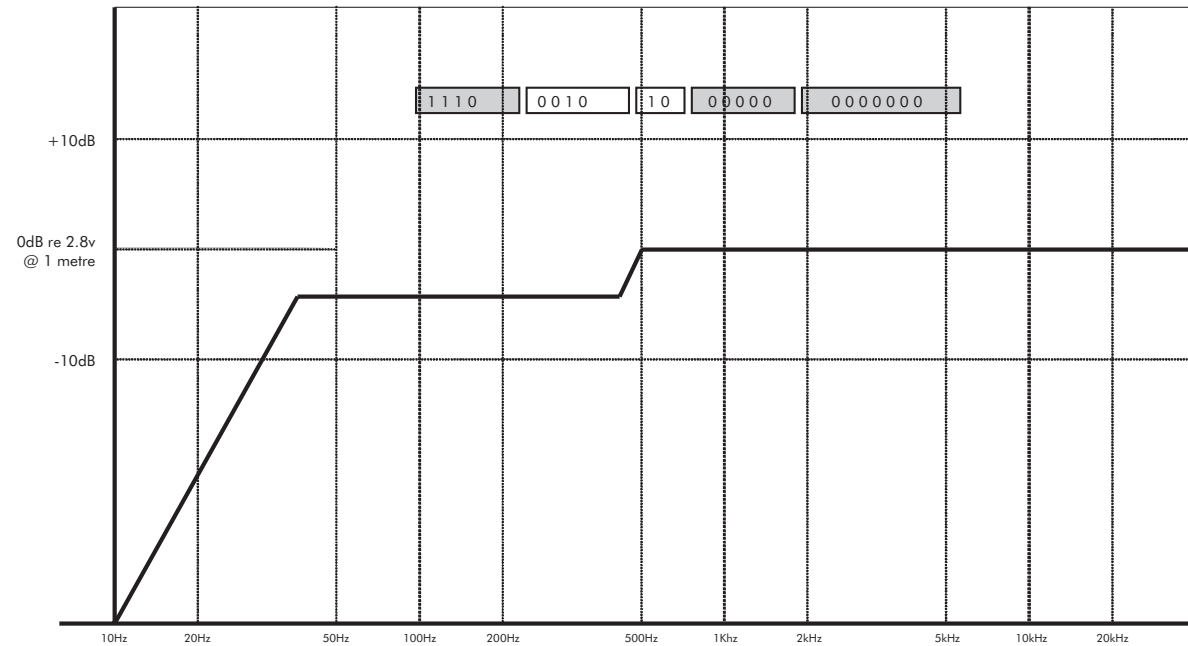

Notes

"Difficult Space" (pi/2): An example of a difficult space would be with speakers against a wall, mounted on the same surface as the PC/Mac machine tilted upwards towards the listener with one or other (or both!) speakers in a corner. This is also a close field situation and demands extreme EQ to make the speakers measure reasonably flat. Typical examples might be a mobile or temporary sound booth set up during an outside broadcast or live field event. Follow the DIP settings in the diagram below for "Difficult Space" for the speakers in corners and adjust for the listening distance accordingly. Adjust the LF-Q settings to balance the system.

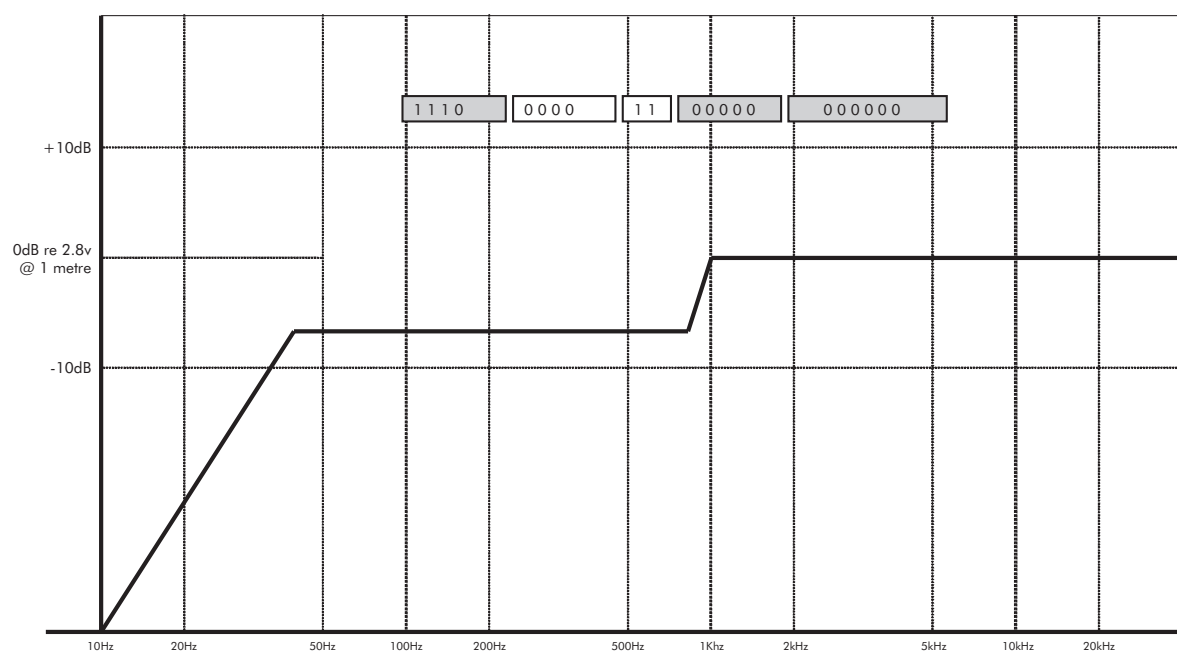

MID AND HIGH EQ SETTINGS

RT60 Decay Time: An estimation of the RT60 decay time above 1kHz within the monitoring environment will help to set the mid and high frequency equalisation. Hard surfaces in general and particularly if close to the speakers will increase the amount of reverberant energy to direct energy above 1kHz (RT60 above 500ms) and may justify setting the mid or high EQ (or both) to -1dB. Absorbent surfaces in general and particularly if close to the speakers (RT60 below 200ms) will reduce the reverberant to direct energy and may justify setting the mid or high (or both) EQ to +1dB. In both cases the LF-Q may be adjusted to compensate the overall balance. If the monitor environment is well designed with a flat RT60 time of around 200 to 250ms then no LF-Q, mid or high EQ should be required.

Source Material: For prolonged sessions working on bright, forward or difficult news/location material where the content of material is being edited rather than control of the sound quality the full range of mid and high EQ can be used to prevent fatigue. This is a matter of individual taste and the EQ can be set accordingly. Alternatively, boosting mid and high frequencies can make decisions during editing easier with limited bandwidth material.

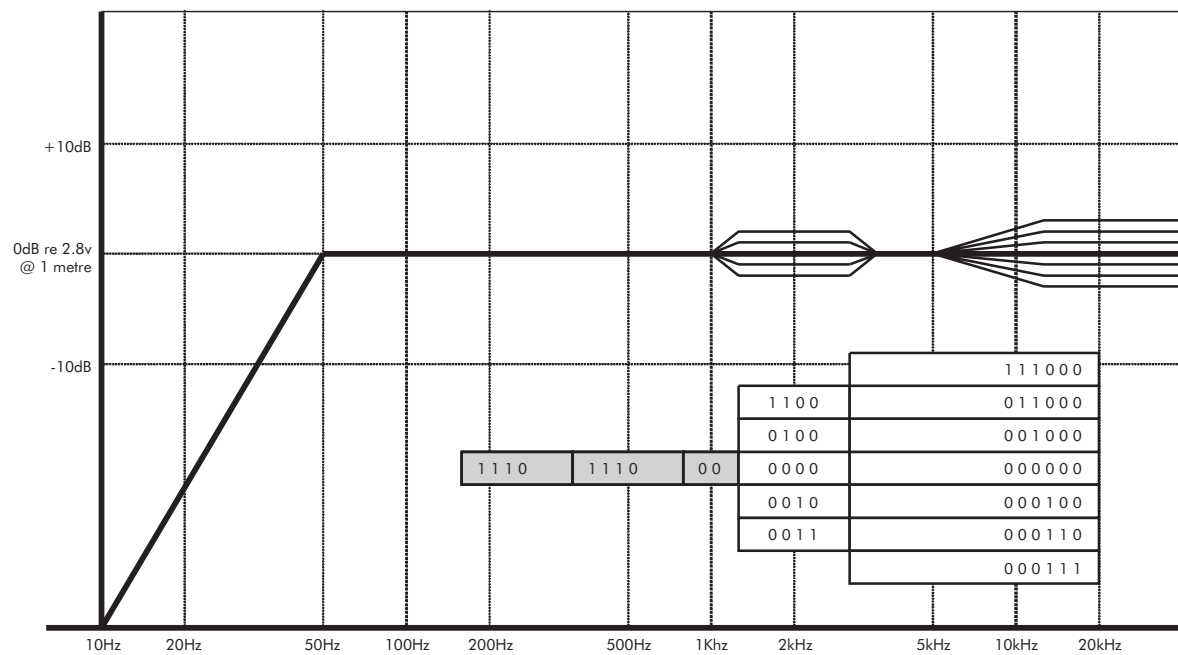

6.0: PLACEMENT OF THE SPEAKERS

Now here's the truly critical stuff. Speaker placement and the listening environment can completely compromise the performance of any loudspeaker, no matter how much it costs. It is important to understand some limitations of near-field speakers, and the operating environment, in order for you to gain the maximum performance from the pair sitting in front of you.

6.1: ORIENTATION (R6D & R8D)

Two-way speakers have a correct orientation for the serious listener. Two way systems use a separate woofer and tweeter mounted in a vertical line on the baffle. There is a fixed vertical distance between the centre of the two devices on the baffle, and there is fixed distance between the apparent acoustic center of each device and the plane of the baffle at the crossover point. By stacking the woofer and tweeter vertically, we minimise the problems caused by these physical offsets. The near-field listening conditions magnify the effects of the driver offsets, so we really need to optimise the speaker orientation. When you are very close to a speaker system, vertical head movements are significant because your movement represents a large change in angle of arc, and therefore the number of degrees above and below the axis (that's the line between the woofer and tweeter). In other words, bob your head up and down a few centimeters within a metre of the cabinet, and your ear moves through a larger angle relative to the speaker axis than it does with the same vertical motion 4 or 5 metres away. Need proof? Put on some music, not loud, and get really close, about 500mm (20") away. Move your head up and down now, and you can actually get the musical image to break into a separate high frequency and low frequency source. This is a wildly exaggerated example of what we're talking about. It isn't that bad out here in the normal listening position, but the variations are still there.

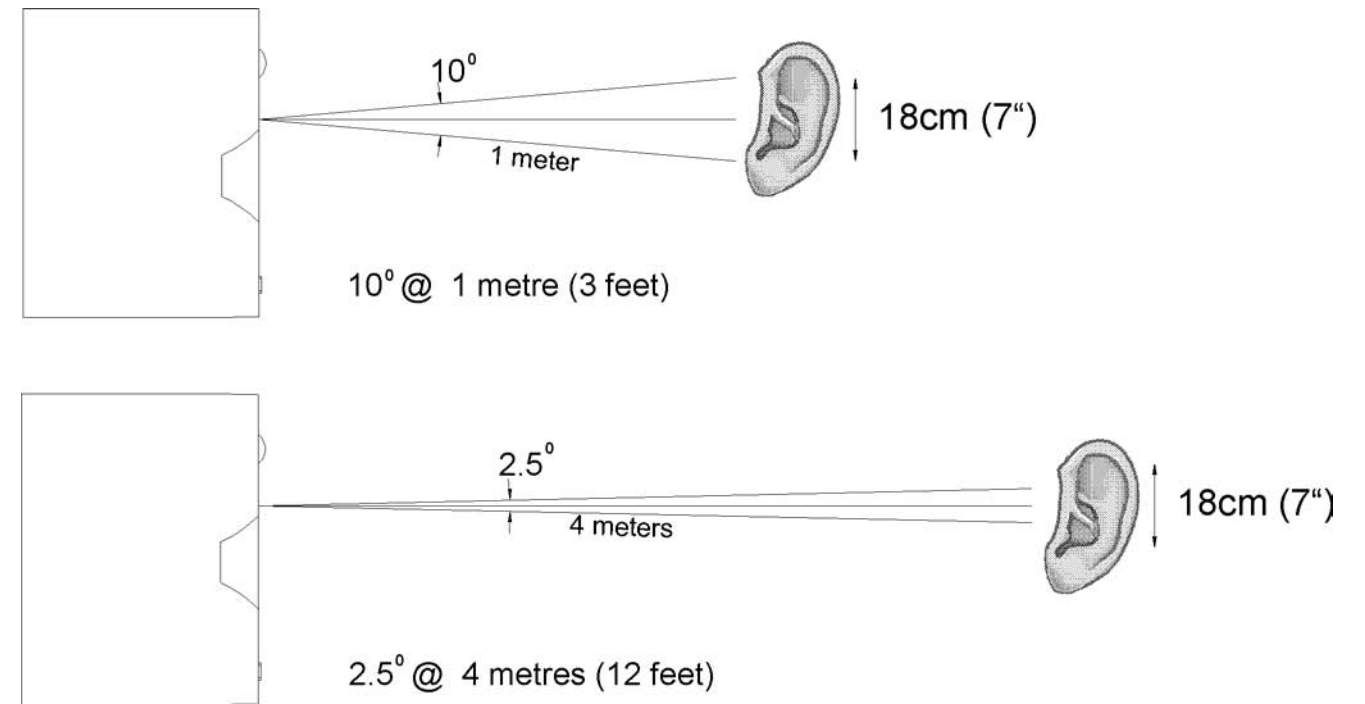

All two way component systems have to live with some listening position dependent compromises at the crossover point. The crossover frequency of all of these small systems falls into the center of the midband (2.0kHz to 3.0kHz), where we are most capable of recognising frequency/phase response deviations.

In the diagrams below we have a graphical representation of the speaker systems operating at the crossover point where both high and low frequency drivers produce the same output level. The first one shows a pair of two-way loudspeakers lying on their side. Note that each driver is producing sound, and because there is a physical distance separating them on the baffle, there is also a time difference separating the drivers, and the result is what you see here. Around the crossover point, the speaker will produce numerous lobes, producing changes in midrange sound character as you move across the horizontal listening plane.

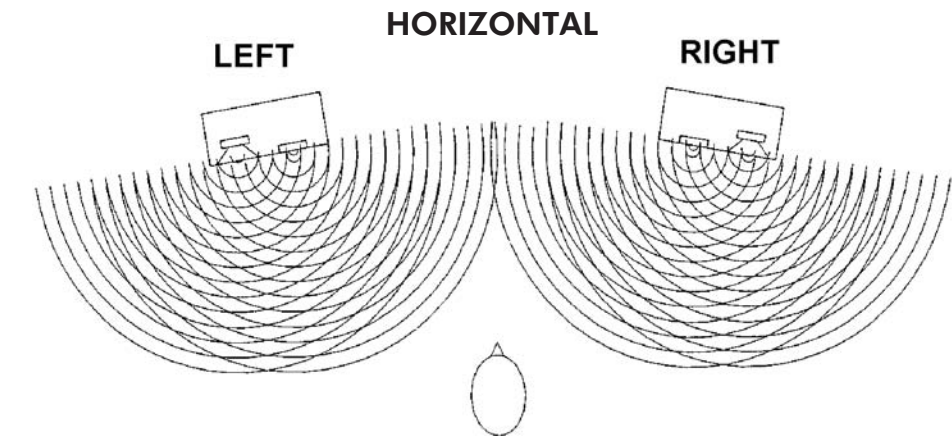

With the monitors laying horizontally, you will move through the largest number of variations caused by the physical/time offsets between the drivers, if you think this is hard to look at, imagine listening to it!

Stereo occurs from left to right, so that is the listening plane in which we try to minimise the changes in physical/time offset between the woofers and tweeters. And we have to be honest, it's not perfect, the driver offset is still there, but by stacking the woofer and tweeter vertically on the baffle we can give the mix engineer the widest range of movement in the horizontal plane. You can roll your chair across the length of your mixing console and not change the relationship between the woofer and tweeter (just don't bob your head up and down while you do it).

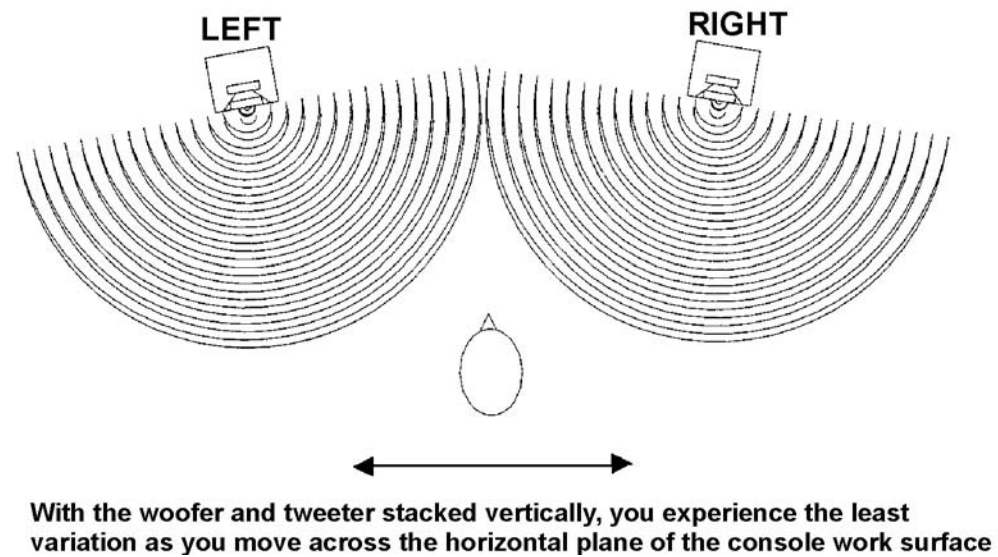

Now, if you were to follow the all too common practice of lying your two way monitors on their side to give you better sight lines over your meter bridge, you can see (and hear) what will happen. With the monitor on its side, moving your head horizontally means you are now moving through all those rays, or lobes, where the wavefronts from the woofers and tweeters interfere with each other. The midrange frequency response will be different for each head position. All two way component monitors, no matter who manufactures them, need to be used with the multi-driver axis vertical (that's just the way it has to be when you're in the near-field). And if you're wondering how three-way near-fields work with a whole bunch of speakers stuck all over the baffle, well... you'll quickly realise why we stopped at two way speaker systems.

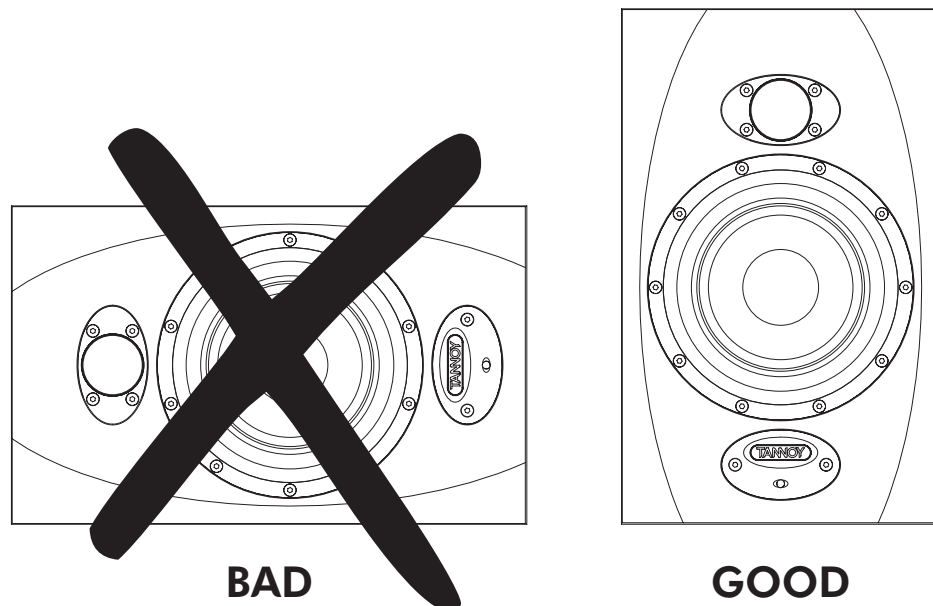

6.2: POSITIONING (R6D & R8D)

This is the monitor equivalent of a wheel alignment. Where do you aim the speakers to give you the smoothest and most consistent sound, and how far apart do you place them to give you a good stereo image? The basic rule is to follow the layout of an equilateral triangle. The distance between the two monitors should be roughly the same as the distance between one monitor and your nose in the listening position where you are leaning forward on the console armrest. See the following diagram.

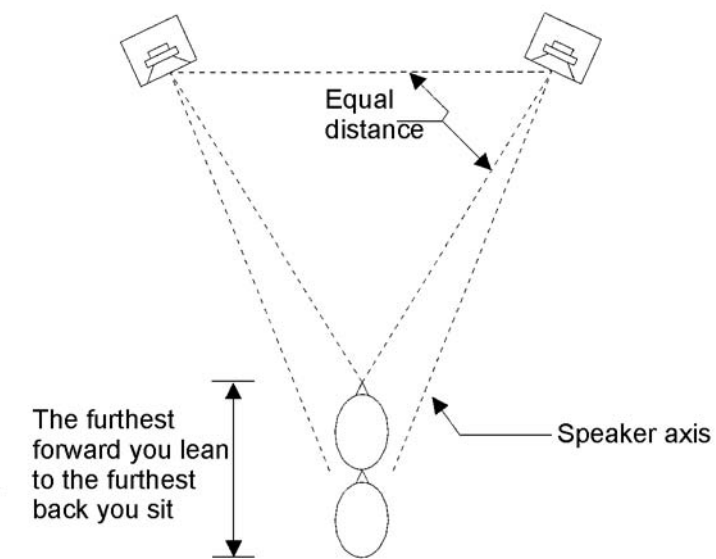

The speaker axis (shown on the diagram) should be aimed at the halfway point between your furthest forward and the furthest back listening positions (as indicated by the two heads on the diagram). This is typically a range of about 24" (600mm). If you can, you should line your ears up with the vertical speaker axis (half way between the woofer and the tweeter). Remember the earlier drawings showing your ears and the speaker, these were to get your normal listening position lined up in the best spot possible. If this would have you resting your chin on the console, you could tilt the monitor back slightly. This keeps your head in the sweet spot whether you're leaning forward adjusting level or EQ, or leaning back and listening to the mix. Don't go crazy trying to get this exact to three decimal places, within a few inches will suffice. Your Tannoy monitors have a wide sweet spot both horizontally and vertically to reduce the variations in sound quality as you move around doing your recording engineer stuff. Turning the monitors in like this has an added benefit of keeping the high frequencies from reflecting off the walls and outboard gear.

6.3: POSITIONING (R66D)

In order to ensure a uniform acoustical environment, the room should be symmetrical about the centre loudspeaker axis; room treatments should be applied symmetrically throughout the room. Mixed "Live end/Dead end" environments should be avoided. If the lateral speakers are positioned close to walls then the constitution of the wall surfaces should be identical. As the main effects speaker for the front soundstage, the Reveal 66D's placement is a critical factor in its performance. In all cases the centre channel speaker should be placed as close to the TV screen as possible. The Reveal 66D is fully magnetically shielded, permitting use in close proximity to TV monitors without colour-fringing effects. The viewing position when seated determines the ideal mounting height, but in all cases this should be as close as possible to ear height, if this is not possible the monitor should be tilted towards ear height in the mix position. The centre speaker should be positioned along the centre axis of the picture and the left/right monitors just outside the picture, ideally the three front effects speakers would be placed with the front baffles in line with the screen surface. If an acoustically transparent screen is used, the left/right monitors should be placed just inside the edges of the picture. The surround speakers should be positioned at the same distance to the mix position as the main front speakers. As the subwoofer/LFE channel only produces low frequencies it is difficult to localise its position by ear. As a result it could effectively be situated anywhere in the room, though optimum performance will be gained by placing the subwoofer in the same plane as the main front speakers.

4.4: SPEAKER MOUNTING

You've probably got your monitors delicately balanced on your console meter bridge, or sitting on a counter top beside your hard disc editor. Find some music with some real solid low end that you know well. Try listening to this music with the speaker sitting directly on the mounting surface and then with it sitting on a thin piece of rubber pad. Hear a difference? Which one sounds more like the recording should? Does one get tubby, or muddy? Depending on the type of mounting surface, you may find it beneficial to use a thin layer of flexible material (i.e. Blu tack) beneath the enclosure. This not only absorbs some vibration, but will help prevent the monitor from vibrating off of its mounting surface.

4.5: BASS PORTS

All Reveal monitor bass ports are located on the back panel. You should keep the back panels at least 150mm (6") away from the nearest wall surface to avoid an overblown bass sound. If you cannot avoid being close to the wall or if you're using a separate subwoofer, you may want to consider plugging the port tubes on your near-fields with a closed cell foam-rubber plug, friction fit for a full seal. Because the ports aren't needed if the monitor speakers are being used with a high pass filter, you won't be losing any bass performance and you can improve the mid-bass response by plugging the ports.

7.0: PERFORMANCE DATA

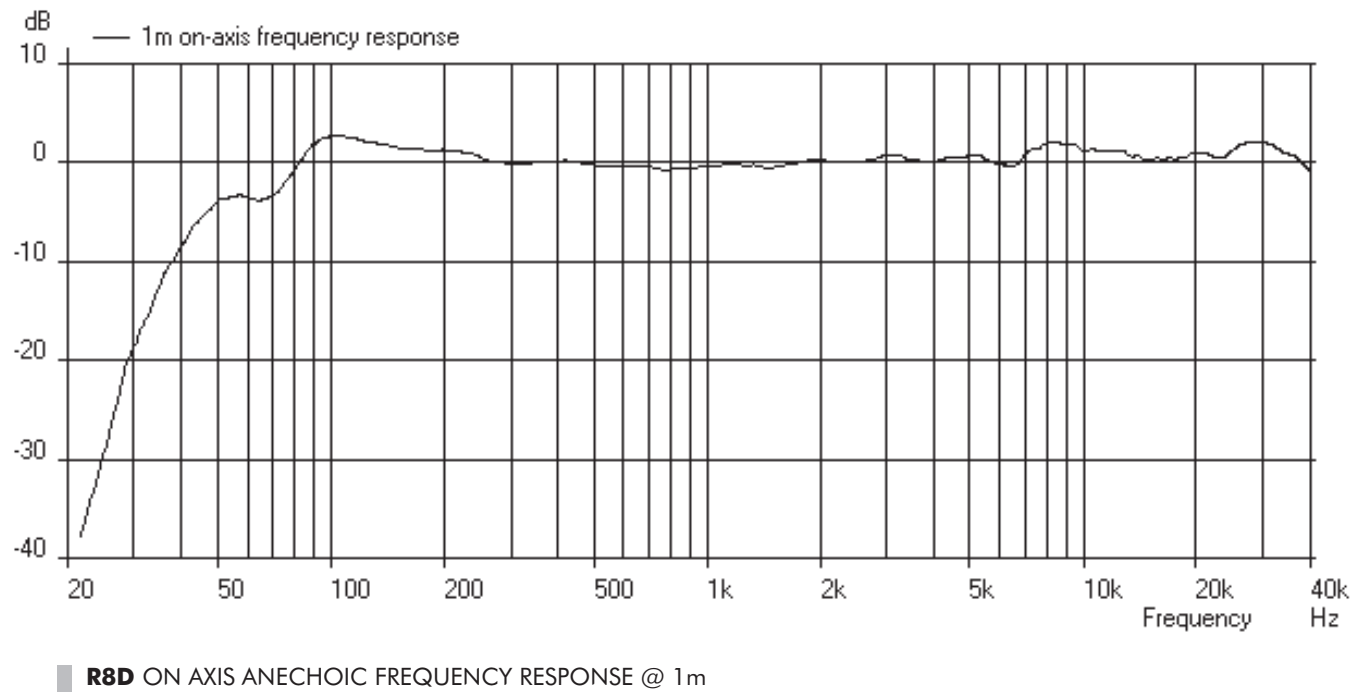
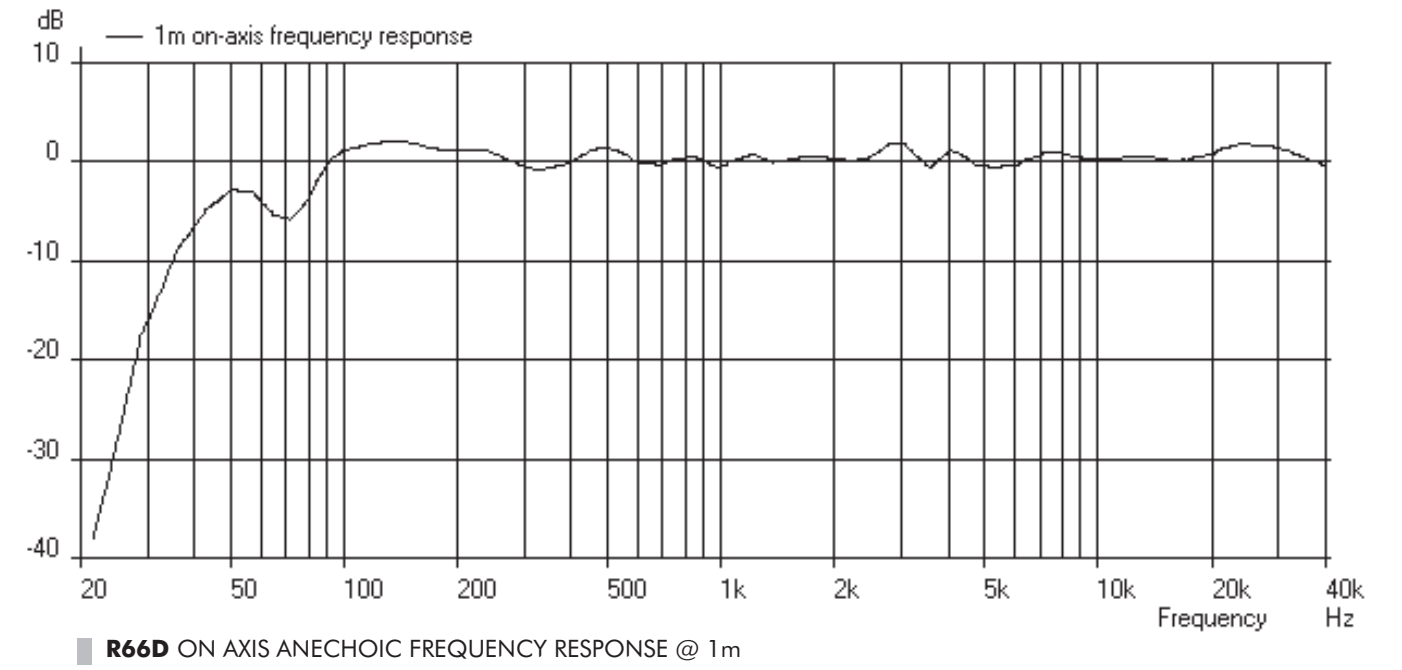
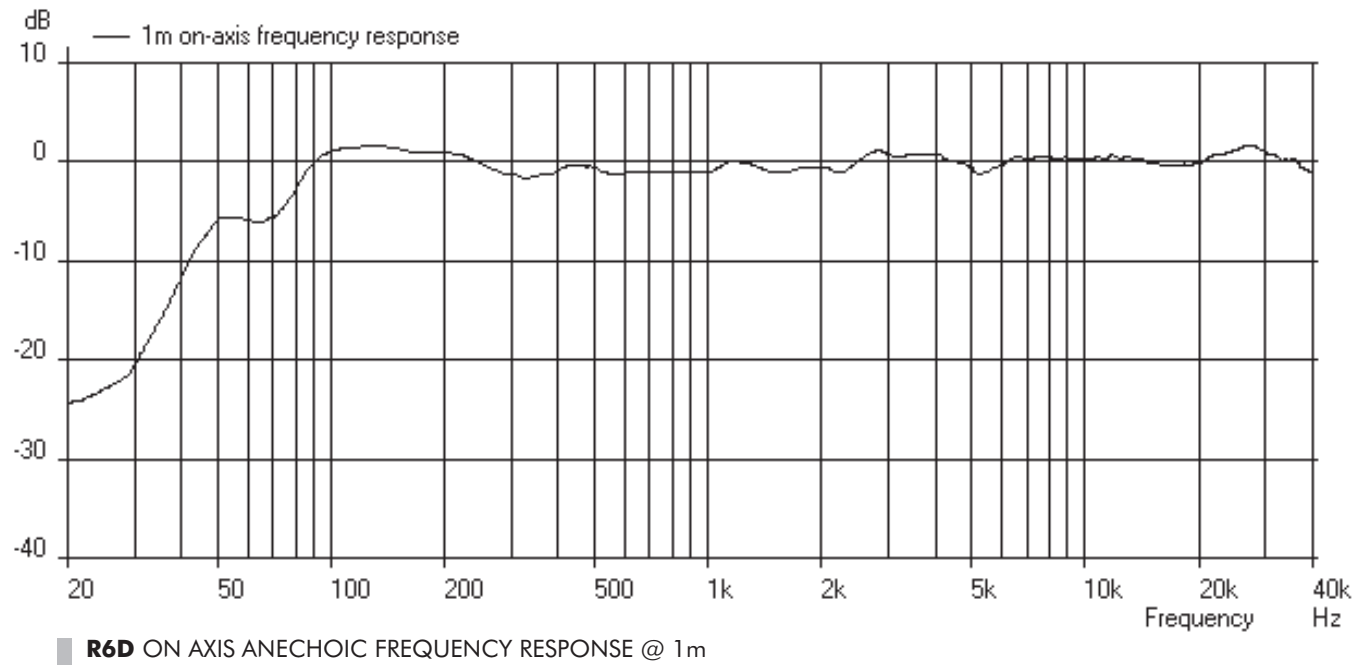

8.0: TECHNICAL SPECIFICATIONS

SYSTEM	R6D	R8D	R66D
Frequency response (1)	60Hz – 51 kHz	46Hz-51kHz	47Hz-51kHz
Maximum SPL (2)	115dB	118dB	117dB
Distortion	<0.5%	<0.4%	<0.4%
Dispersion (@-6dB)	90 degrees	90 degrees	90 degrees
Drive unit LF/MID	165mm (6") multi fibre paper pulp cone	2 x 165mm (6") multi fibre paper pulp cone	200mm (8") multi fibre paper pulp cone
WideBand™ HF	25mm (1") titanium dome neodymium magnet system	25mm (1") titanium dome neodymium magnet system	25mm (1") titanium dome neodymium magnet system
Shielded	Yes	Yes	Yes

ELECTRONIC SECTION

Input	600Ω balanced on combined XLR/jack	600Ω balanced on combined XLR/jack	600Ω balanced on combined XLR/jack
Sensitivity	0.775 Vrms for Full Output	0.775 Vrms for Full Output	0.775 Vrms for Full Output
Crossover frequency	2.6kHz	2.5kHz	2.6kHz
Amplifier output power	LF 75 W rms HF 35 W rms	LF 120 W rms HF 60 W rms	LF 100 W rms HF 50 W rms
User Controls	Front panel mounted on/standby/mute LED indicator Rear Trim +6/-12dB 80Hz High-Pass switch (for AV use) 16-way DIP switch selection for response optimisation	Front panel mounted on/standby/mute LED indicator Rear Trim +6/-12dB 80Hz High-Pass switch (for AV use) 16-way DIP switch selection for response optimisation	Front panel mounted on/standby/mute LED indicator Rear Trim +6/-12dB 80Hz High-Pass switch (for AV use) 16-way DIP switch selection for response optimisation
Power supply	Fixed mains voltage IEC inlet with detachable power cord Region Specific (to order) 110/220/230v	Fixed mains voltage IEC inlet with detachable power cord Region Specific (to order) 110/220/230v	Fixed mains voltage IEC inlet with detachable power cord Region Specific (to order) 110/220/230v

CABINET

Low frequency design	Optimised bass-reflex loaded	Optimised bass-reflex loaded	Optimised bass-reflex loaded
Cabinet construction	MDF cabinet and front baffle, tongue and groove front and back	MDF cabinet and front baffle, tongue and groove front and back	MDF cabinet and front baffle, tongue and groove front and back
Cabinet finish	Grey cabinet with blue painted baffle	Grey cabinet with blue painted baffle	Grey cabinet with blue painted baffle
Cabinet dimensions (HxWxD)	340mm x 210mm x 381mm 13 ³ / ₈ " x 8 ¹ / ₄ " x 15"	425mm x 262mm x 363.5mm 16 ³ / ₄ " x 10 ⁵ / ₁₆ " x 14 ⁵ / ₁₆ "	230mm x 527mm x 408.5mm 9 ¹ / ₁₆ " x 20 ³ / ₄ " x 13 ¹ / ₁₆ "
Total Cabinet weight	7.8kg (17.15lbs)	16kg (35.2lbs)	17.3kg (38lbs)

NOTES

(1) +/- 3 dB, measured at 1m in an anechoic chamber. (2) Peak SPL at mix position for 1 pair driven.

Tannoy operates a policy of continuous research and development. The introduction of new materials or manufacturing methods will always equal or exceed the published specifications which Tannoy reserve the right to alter without prior notice. Please verify the latest specifications when dealing with critical applications.

9.0: DIMENSIONS

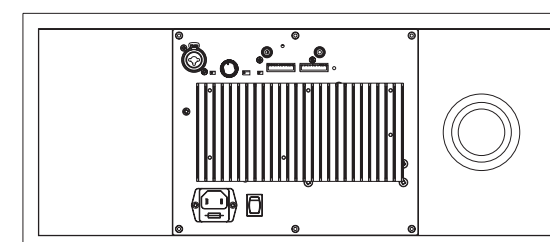
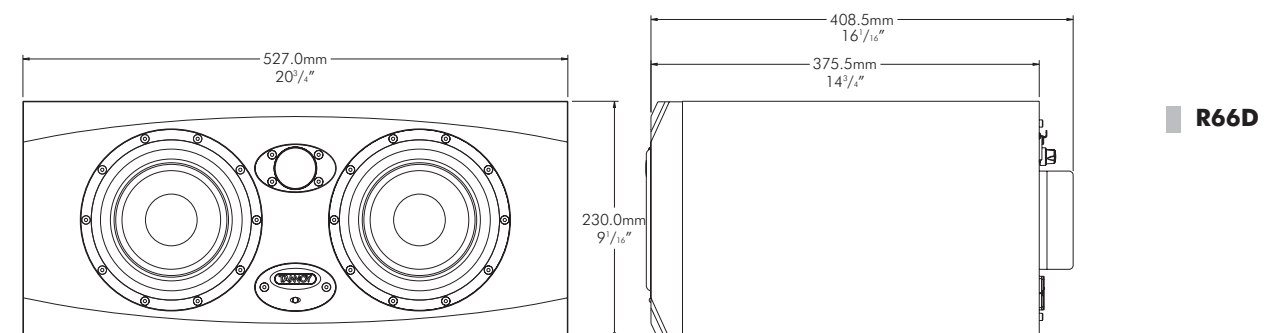
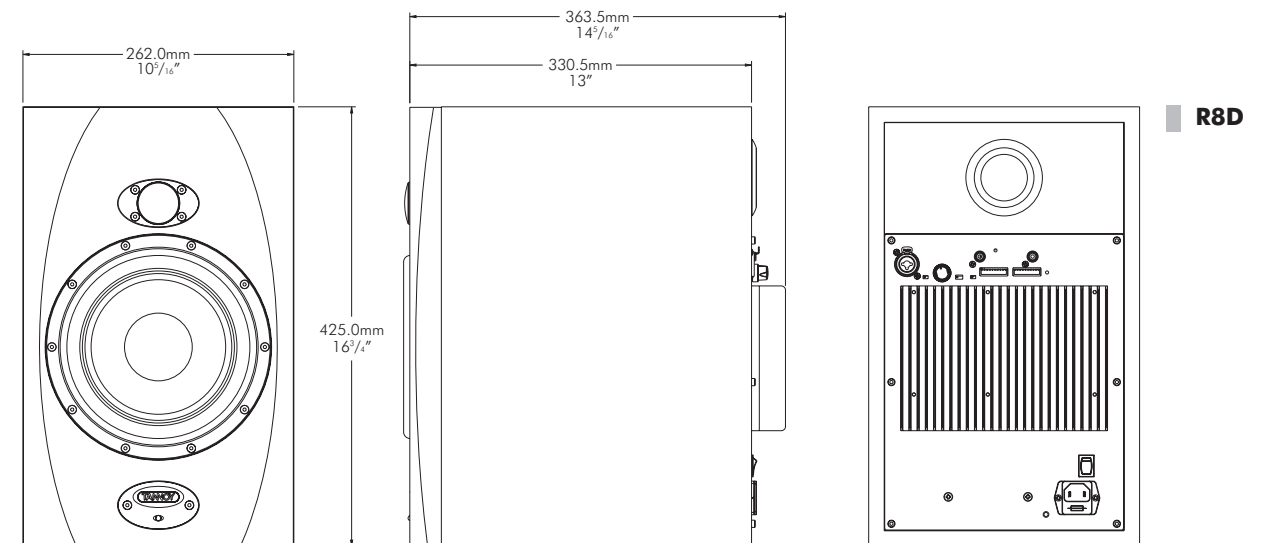
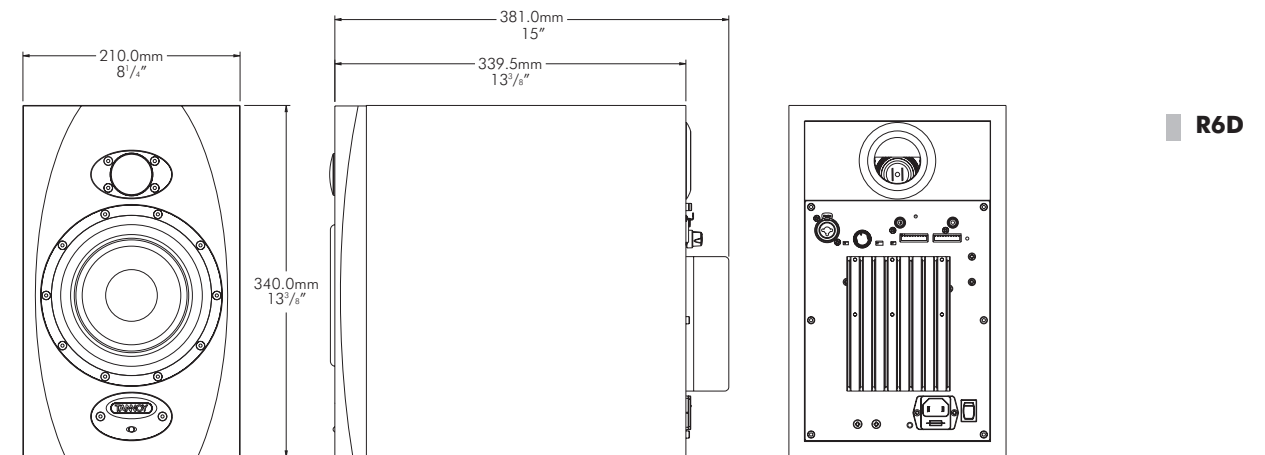

10.0: SERVICING | **10.1: CABINET FINISH**

To remove marks and scuffs use a soft brush. If necessary, a little warm water and detergent can be used but under no circumstances use a solvent or abrasive cleaner.

10.2: DRIVER REMOVAL

Lay the cabinet on its back. Remove the ten hexagonal screws and set aside. Ease the driver from the front of the cabinet taking care not to mark the front surface. Remove the driver, note the polarity of the internal connections and disconnect the internal wiring. Take care not to damage the moving parts of the LF driver. To refit the driver, connect the cables from the crossover to the LF terminals. Fit the driver into the mounting hole, making sure that the internal connecting cables are not trapped or able to touch the LF cone. Fasten the screws finger tight and then progressively tighten them down with the appropriate Allen key. Repeat the same procedure for the HF driver.

10.3: AMPLIFIER

A fuse is located just under the mains input (fig 1). Replacement is simple and a spare fuse is provided inside the fuse housing itself. Always use the correctly rated fuse, as indicated on the silk screen-printing. Only qualified and authorised personnel should undertake any other servicing regarding the amplifier section.

In case of any malfunction of the unit, the first thing to check should be the input connection, more especially if the source has unbalanced outputs (see "Connecting your speakers" section) as improper connection can result in significant level reduction and affect the response.

10.4: LIST OF SPARE PARTS

DESCRIPTION	REVEAL 6D (PART NO)	REVEAL 8D (PART NO)	REVEAL 66D (PART NO)
Driver Kit	Type 1603 -7900 0747	Type 2076 -7900 0748	Type 1603 -7900 0747
High Frequency Unit	Type 0294 – 7900 0891B	Type 0294 – 7900 0891B	Type 0294 – 7900 0891B
Amplifier Complete	7300 0932 (230V)	7300 0933 (230V)	7300 0934 (230V)
Amplifier Complete	7300 1026 (110V)	7300 1027 (110V)	7300 1028 (110V)
Filter Board Assembly	7600 1550	7600 1551	7600 1552
Power Board Assembly	7600 1556	7600 1557	7600 1557
Digital I/O Board Assembly	7600 1558	7600 1558	7600 1558
Features Board Assembly	7600 1409	7600 1409	7600 1409
Transformer	3212 0132	3212 0133	3212 0132
Passive Crossover			Type 1509 – 7300 1044

11.0: WARRANTY**NO MAINTENANCE OF THE REVEAL 6D, 8D & 66D MONITORS IS NECESSARY.**

All components are guaranteed for a period of one year from the date of manufacture, subject to the absence of, or evidence of, misuse, overload or accidental damage.

For further information please contact your dealer or the distributor in your country.

If you cannot locate your distributor please contact:

Customer Services, Tannoy Ltd., Coatbridge, Strathclyde, ML5 4TF, Scotland
 Telephone: 01236 420199 (UK) +44 1236 420199 (International)
 Fax: 01236 428230 (UK) +44 1236 428230 (International)
 Internet: <http://www.tannoy.com>

DO NOT SHIP ANY PRODUCT TO TANNOY WITHOUT PREVIOUS AUTHORISATION

This warranty in no way affects your statutory rights.

12.0: DECLARATION OF CONFORMITY

The following apparatus is/are manufactured in China by Tannoy Ltd of Rosehall Industrial Estate, Coatbridge, Scotland, ML5 4TF. The following equipment is marked with the CE label and conform(s) to the protection requirements of the European Electromagnetic Compatibility Standards and Directives. The apparatus is designed and constructed such that electromagnetic disturbances generated do not exceed levels allowing radio and telecommunications equipment and other apparatus to operate as intended, and, the apparatus has an adequate level of intrinsic immunity to electromagnetic disturbance to enable operation as specified and intended.

Details of the Apparatus: Reveal 6D Studio Monitor
 Reveal 8D Studio Monitor
 Reveal 66D Studio Monitor

The equipment listed above is covered by this certificate and marked with the CE-label conforms to the following standards:

EN 60065	Safety requirements for mains operated electronic and related
(IEC 60065)	apparatus for household and similar general use
EN 55103-1	Product family standard for audio, video, audio-visual and entertainment lighting control apparatus for professional use. Part 1: Emission.
EN 55103-2	Product family standard for audio, video, audio-visual and entertainment lighting control apparatus for professional use. Part 2: Immunity.

With reference to regulations in following directives:
 73/23/EEC, 89/336/EEC

Signed:

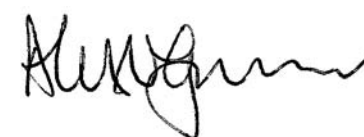

Position: Technical Director

Date: 1 March 2005

For Tannoy Ltd

Free Manuals Download Website

<http://myh66.com>

<http://usermanuals.us>

<http://www.somanuals.com>

<http://www.4manuals.cc>

<http://www.manual-lib.com>

<http://www.404manual.com>

<http://www.luxmanual.com>

<http://aubethermostatmanual.com>

Golf course search by state

<http://golfingnear.com>

Email search by domain

<http://emailbydomain.com>

Auto manuals search

<http://auto.somanuals.com>

TV manuals search

<http://tv.somanuals.com>