

Blend 6

6-channel mixer

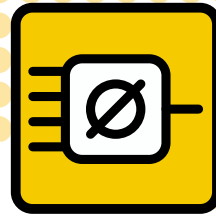

owner's manual



TAPCO[®]
by **MACKIE**[®]



The lightning flash with arrowhead symbol within an equilateral triangle is intended to alert the user to the presence of uninsulated "dangerous voltage" within the product's enclosure that may be of sufficient magnitude to constitute a risk of electric shock to persons.

Le symbole éclair avec point de flèche à l'intérieur d'un triangle équilatéral est utilisé pour alerter l'utilisateur de la présence à l'intérieur du coffret de "voltage dangereux" non isolé d'ampleur suffisante pour constituer un risque d'électrocution.



The exclamation point within an equilateral triangle is intended to alert the user of the presence of important operating and maintenance (servicing) instructions in the literature accompanying the appliance.

Le point d'exclamation à l'intérieur d'un triangle équilatéral est employé pour alerter les utilisateurs de la présence d'instructions importantes pour le fonctionnement et l'entretien (service) dans le livret d'instruction accompagnant l'appareil.

SAFETY INSTRUCTIONS

1. Read Instructions — All the safety and operation instructions should be read before this product is operated.
2. Retain Instructions — The safety and operating instructions should be kept for future reference.
3. Heed Warnings — All warnings on this product and in these operating instructions should be followed.
4. Follow Instructions — All operating and other instructions should be followed.
5. Water and Moisture — This product should not be used near water – for example, near a bathtub, washbowl, kitchen sink, laundry tub, in a wet basement, near a swimming pool, etc.
6. Cleaning — Clean only with a dry cloth.
7. Ventilation — This product should be situated so that its location or position does not interfere with its proper ventilation. For example, the Component should not be situated on a bed, sofa, rug, or similar surface that may block any ventilation openings, or placed in a built-in installation such as a bookcase or cabinet that may impede the flow of air through ventilation openings.
8. Heat — This product should be situated away from heat sources such as radiators, or other devices which produce heat.
9. Power Sources — This product should be connected to a power supply only of the type described in these operation instructions or as marked on this product.
10. Power Cord Protection — Power supply cords should be routed so that they are not likely to be walked upon or pinched by items placed upon or against them, paying particular attention to cords at plugs, convenience receptacles, and the point where they exit this product.
11. Object and Liquid Entry — Care should be taken so that objects do not fall on, and liquids are not spilled into, this product.

12. Damage Requiring Service — This product should be serviced only by qualified service personnel when:
 - A. The power-supply cord or the plug has been damaged; or
 - B. Objects have fallen, or liquid has spilled into this product; or
 - C. This product has been exposed to rain; or
 - D. This product does not appear to operate normally or exhibits a marked change in performance; or
 - E. This product has been dropped, or its chassis damaged.
 13. Servicing — The user should not attempt to service this product beyond those means described in this operating manual. All other servicing should be referred to the Tapco Service Department.
 14. To prevent electric shock, do not use this polarized plug with an extension cord, receptacle or other outlet unless the blades can be fully inserted to prevent blade exposure.
- Pour prévenir les chocs électriques ne pas utiliser cette fiche polarisée avec un prolongateur, une prise de courant ou une autre sortie de courant, sauf si les lames peuvent être insérées à fond sans laisser aucune partie à découvert.
15. Grounding or Polarization — Precautions should be taken so that the grounding or polarization means of this product is not defeated.
 16. Power Precaution — Unplug this product during lightning storms or when unused for long periods of time.
 17. This apparatus does not exceed the Class A/Class B (whichever is applicable) limits for radio noise emissions from digital apparatus as set out in the radio interference regulations of the Canadian Department of Communications.

ATTENTION —Le présent appareil numérique n'émet pas de bruits radioélectriques dépassant les limites applicables aux appareils numériques de class A/de class B (selon le cas) prescrites dans le règlement sur le brouillage radioélectrique édicté par le ministère des communications du Canada.

18. Exposure to extremely high noise levels may cause permanent hearing loss. Individuals vary considerably in susceptibility to noise-induced hearing loss, but nearly everyone will lose some hearing if exposed to sufficiently intense noise for a period of time. The U.S. Government's Occupational Safety and Health Administration (OSHA) has specified the permissible noise level exposures shown in the following chart.

According to OSHA, any exposure in excess of these permissible limits could result in some hearing loss. To ensure against potentially dangerous exposure to high sound pressure levels, it is recommended that all persons exposed to equipment capable of producing high sound pressure levels use hearing protectors while the equipment is in operation. Ear plugs or protectors in the ear canals or over the ears must be worn when operating the equipment in order to prevent permanent hearing loss if exposure is in excess of the limits set forth here.

Duration Per Day In Hours	Sound Level dBA, Slow Response	Typical Example
8	90	Packed garage concert
6	92	
4	95	VW Bus Peace Train
3	97	
2	100	Cranked psychedelic tunes
1.5	102	
1	105	High speed chase on C.H.I.P.s
0.5	110	
0.25 or less	115	Loudest parts at a Heavy Metal concert

WARNING — To reduce the risk of fire or electric shock, do not expose this appliance to rain or moisture.

Contents

Safety Instructions.....	2
Getting Started.....	4
Introduction	6
Hookup Diagrams	7
Blend 6 Features	8
Channel Inputs.....	8
Channel Controls.....	9
Equalization	9
Auxiliaries	9
Master Section	11
Output Connections	12
Rear Panel Features	12
Appendix A: Service Information	13
Appendix B: Connections	14
Appendix C: Blend 6 Specifications.....	15
Gain Structure Diagram.....	16
Block Diagram	17
Track Sheets.....	18
TAPCO Limited Warranty	19

Don't forget to visit our website at www.tapcogear.com for more information about this and other TAPCO products.

What me, read a manual?

Before you begin, please make sure you read the Safety Instructions on page 2 and Getting Started on page 4.

Your new TAPCO® Blend 6 mixer is designed to set up quickly and operate easily. We know it's often seen as a sign of weakness to read a manual, along with asking for directions when lost, but maybe you can read the rest when nobody is looking.

It is important to keep your receipt in a safe place, and not a bad idea to write your product information here for future reference (i.e., insurance claims, tech support, return authorization, etc.).

Product Serial #:

Purchased at:

Date of purchase:



Getting Started

The following steps will help you set up your mixer, and get the levels and adjustments just right.

ZERO THE CONSOLE:

1. Turn everything off, including the mixer's POWER switch and PHANTOM POWER switch.
2. Turn down the channel strip GAIN, AUX 1, AUX 2, and LEVEL controls.
3. Center the channel strip EQ and PAN controls.
4. Turn down the AUX RETURNS, CONTROL ROOM, and PHONES controls.
5. Turn down the MAIN MIX control.

CONNECTIONS:

1. Connect your speakers to your amplifier's outputs (unless, of course, you have powered speakers).
2. Plug all the sound system components into suitable AC outlets, properly grounded and capable of delivering adequate current.
3. Using TRS cables, make connections from your mixer's MAIN OUT to your amplification system's line inputs.
4. Connect your microphones and instruments to the mixer: Connect microphones to the mono channel MIC jacks. (For condenser microphones, engage the PHANTOM POWER switch.) Connect high-impedance line-level instruments (electric guitar, bass guitar) to the mono channel INST IN, or other line-level signal source to the stereo channel LINE IN jacks.

Note: Normally, you would plug in only one microphone or one instrument into each mono channel.

5. Zero the console, as shown above.
6. Turn all the power switches on, leaving the amplifier's switch for last.
7. Turn up the MAIN MIX control to the 9 o'clock position, for now. We'll crank it up later on.
8. Now you are ready to set the levels.

SET THE LEVELS (Channels 1 and 2):

1. Choose one of the microphones or instruments you connected to the mono MIC or INST input. Make some noise. If it's a microphone, sing at your normal singing volume. If it's an instrument, play it at its normal output level.
2. While making noise, turn up that channel's GAIN until the adjacent LEVEL SET LED starts blinking.
3. Raise that channel's LEVEL to unity gain (**U** label). You should be hearing your noise now.

4. If necessary, apply channel EQ changes. (You may need to compensate for level changes afterward with the channel LEVEL control.)
5. Repeat steps 1 through 4 for the other Mic/Line channel.
6. Stop making noise. Everyone: start making music.
7. Now turn up the MAIN MIX control to a comfortable listening level.

SET THE LEVELS (Channels 3/4 and 5/6):

1. Make some noise with the mono or stereo instrument connected to the LINE IN jacks on Channels 3/4. Play it at its normal output level.
2. Raise that channel's LEVEL control until it is approximately equal in volume to the microphones or instruments connected to channels 1 and 2.
3. If necessary, apply channel EQ changes. (You may need to compensate for level changes afterward with the channel LEVEL control.)
4. Repeat steps 1 through 3 for Channels 5/6.

TWEAK THE MIX:

1. If you are using an external processor connected between the AUX SEND 2 and the AUX RETURN jacks, use each channel's AUX 2 FX control to send signal to the processor, and add the processor's signal to the mix using the AUX RETURN TO MAIN MIX control.
2. Now that you have a rough mix going, you may need to readjust the MAIN MIX control to a comfortable listening level. The LED VU meters should indicate by lighting most of the green LEDs when music is playing, and occasionally light the yellow LEDs.
3. Depending on how much time you have, keep tweaking. Walk the room to see how it sounds away from your mixer. Keep tweaking.

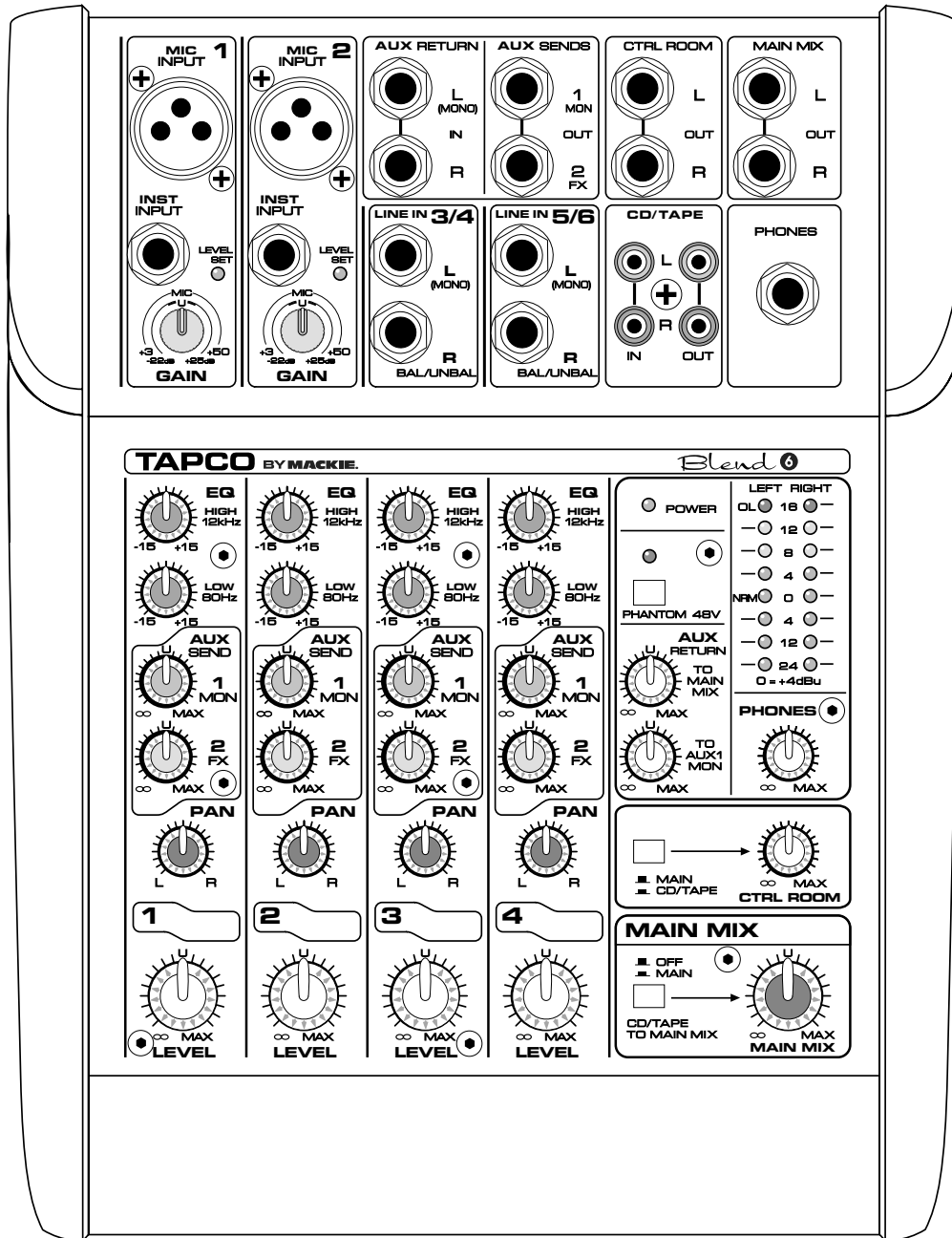

A FEW PRECAUTIONS:

- Never listen to loud music for prolonged periods. Please see the Safety Instructions on page 2 for information on hearing protection.
- Never plug amplifier speaker-level outputs into anything except speakers.
- Never use guitar cables to connect amplifiers to speakers.
- Before making connections to an external amplifier, or reconfiguring an amp's routing, turn the amp's level (gain) controls down, turn the power off, make the changes, turn the power back on, and then turn the level controls back up.
- When you shut down your equipment, turn off any external amplifiers first. When powering up, turn on the amplifiers last.
- Save the shipping box and packing material! The box can also be turned into a unique hat, lunch box, or handbag to accessorize your mixer.

Introduction

Thank you for choosing a TAPCO Blend 6 mixer by Mackie. The TAPCO family of mixers hails back to the days of TAPCO Corporation, Greg Mackie's first company. TAPCO revolutionized the audio industry back in 1969 with the very first 6-channel mixer specifically designed for keyboards and rock 'N' roll PA.

The first TAPCO mixer, although primitive by today's standards, was truly innovative for its time. It had the headroom to handle screaming singers, was priced for the pocketbook of starving psychedelic musical neophytes, and durable enough to withstand mammoth levels of wear and tear on the road, and at now-legendary concerts.



TAPCO version of Greg

In essence, TAPCO re-defined the price performance ratio and made high-quality professional audio mixers accessible to virtually anyone. Today, TAPCO is reborn with the same ideals and is backed by the world-class engineering and manufacturing horsepower of Mackie.

This compact mixer is perfect for small to medium-sized live sound reinforcement applications, keyboards and synths, video, and small-project studio applications.

Here's a quick glance at all the features packed into this mixer:

2 mono mic/line channels, with:

- Variable input trim (+3 to +50 dB for microphones, and -22 to +25 dB for line-level inputs)
- Phantom power (globally switched)
- Level Set indicator LED
- XLR microphone input jack
- 1/4" TRS instrument line input jack
- Pre-fader aux (monitor) send
- Post-fader aux (effects) send
- 2-band EQ
- Pan control
- Rotary level control

2 stereo line channels, with:

- Left and right 1/4" TRS line input jacks
- Pre-fader aux (monitor) send
- Post-fader aux (effects) send
- 2-band EQ
- Pan control
- Rotary level control

Master section, with:

- Rotary stereo Main Mix control
- Balanced 1/4" TRS stereo main outputs
- 8-segment stereo LED VU metering
- 1/4" TRS Aux 1/Monitor send
- 1/4" TRS Aux 2/Effects send
- Two rotary stereo aux return controls (To Mains and To Monitors)
- RCA tape out
- RCA tape in
- Master +48V phantom power switch with LED indicator
- Left and Right 1/4" TRS Control Room outputs with Level control
- Stereo 1/4" TRS Headphone output with Level control
- Power LED indicator
- Inter-Planetary Space Drive control
- OK, we made that last one up, but we can pencil it in for next time



TAPCO van (a.k.a. micro bus)

Hookup Diagrams

Small Club Gig

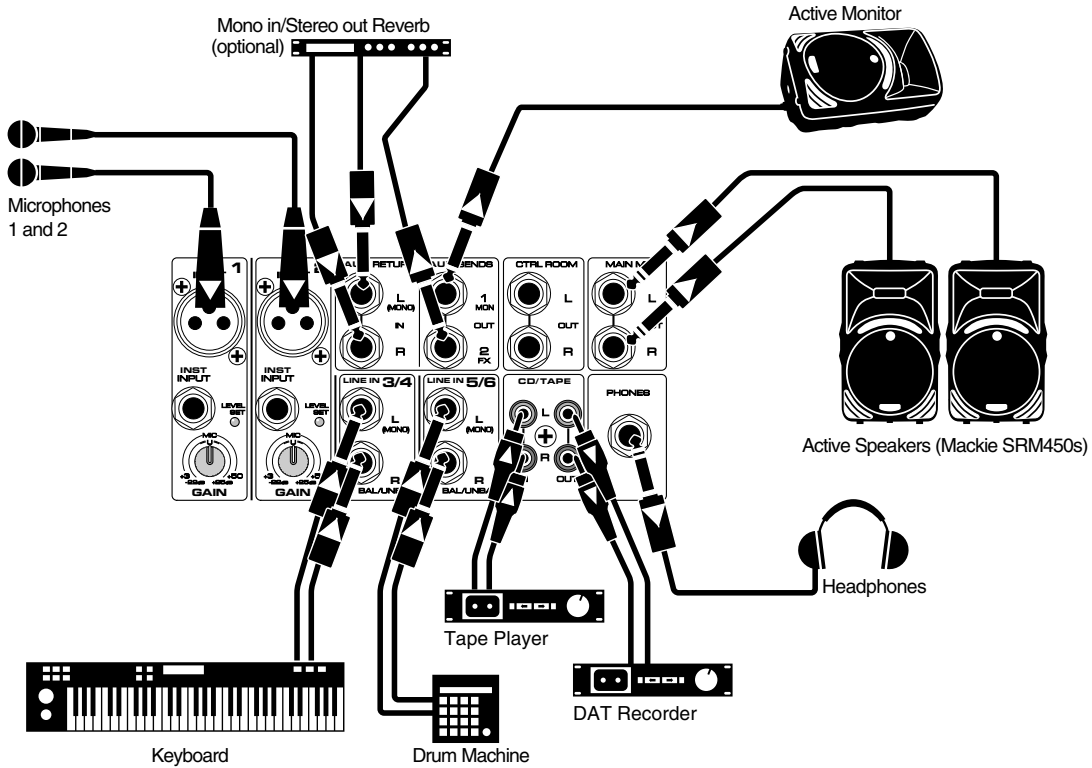

Computer set-up

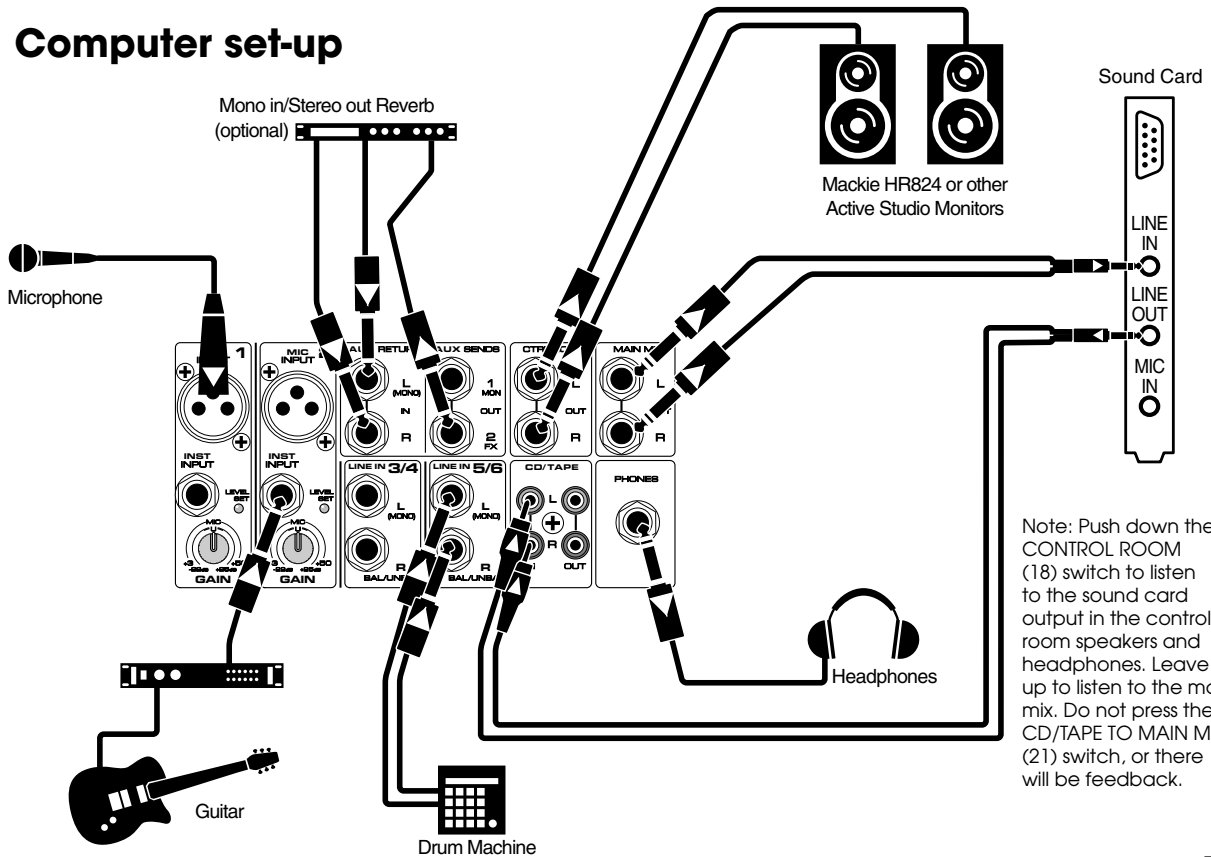

Blend 6 Features

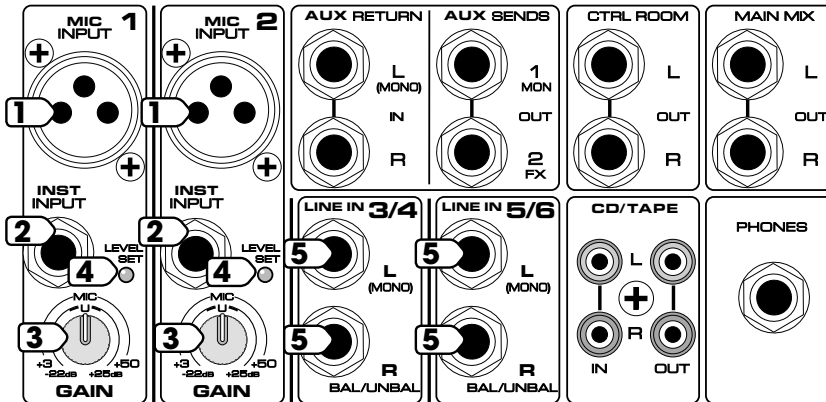

CHANNEL INPUTS

1. MIC (MICROPHONE) INPUTS

The Blend 6 is equipped with two rugged, low-noise, phantom-powered microphone preamplifiers, providing up to 50 dB of crystal-clear amplification. Their balanced circuitry rejects all manner of extraneous interference. Professional condenser, dynamic, and ribbon mics all sound excellent through these XLR inputs.

You can plug in almost any kind of balanced mic that has a standard XLR-type male mic connector. See Appendix B for more information on XLR connectors.

The TAPCO Blend 6 provides +48 VDC phantom powering on pins 2 and 3 of the mono channels' XLR MIC inputs. This can be turned on and off using the PHANTOM POWER (17) switch.



CAUTION: DO NOT connect a line-level device to a MIC input with the phantom power switched on. This could damage the device. Use the INST IN (2) or LINE IN (5) jacks instead. Do not use phantom power with tube or ribbon microphones, as this may cause damage.

2. INST (INSTRUMENT) INPUTS

These inputs can accept 1/4" TRS balanced and TS unbalanced plugs from any line-level instrument, effects device, or tape player. They can be driven by virtually any line-level signal, from -45 dBu up to +18 dBu.

These inputs are specially designed to accept signals from high-impedance pickups on guitars. Normally, you must use a direct box between a guitar and a mixer's input, which serves to convert the impedance of the guitar from high to low. The INST inputs on Channels 1 and 2 make the need for a direct box unnecessary.

3. GAIN CONTROL

If you haven't already, please read "SET THE LEVELS" on page 4.

The GAIN control adjusts the input sensitivity of the MIC and INST inputs. This allows signals from the outside world to be adjusted to optimal internal operating levels.

Through the mono channels' MIC (XLR) inputs, there is 50 dB of gain with the knob fully up.

Through a mono channels' INST IN (TRS) inputs, there is 22 dB of attenuation fully down and 25 dB of gain fully up, with a **U** (unity gain) mark halfway up.

Having 22 dB of line-level attenuation can be very handy when you are injecting a signal that is very hot, or when you want to add a lot of EQ boost, or both. Without this "pad," it would be very difficult to control the line signal and might lead to channel clipping.

4. INPUT LEVEL SET LED

This handy LED (Light Emitting Diode) lets you know that the signals going into the mixer are adjusted to the correct level, not too strong to cause distortion and not too weak to be lost in noise.

After you connect a microphone or line-level component to the mixer, do a sound test and adjust the GAIN control until this handy LED flickers just occasionally. If it is glowing constantly, turn the GAIN down. If the LED is doing almost nothing, turn it up.

5. LEFT (MONO) and RIGHT LINE IN

These inputs can accept 1/4" TRS balanced and TS unbalanced plugs from any line-level instrument, effects device, or tape player.

When connecting a stereo device (two cords), use both the left (mono) input and the right input.

When connecting a mono device (just one cord), always use the left (mono) input and plug nothing into the right input. A trick called "jack normaling" causes the signal to appear on both sides.

CHANNEL CONTROLS

Channel strips 1 and 2 allow adjustment of EQ, Pan and Level for mono signals. Channel strips 3/4, and 5/6 allow adjustment of stereo or mono signals. The output from each strip passes onto the left and right main mixes. Auxiliary signals can be tapped off and sent to monitors or processors. The block diagram on page 17 shows how the signal flows through the mixer.



UNITY GAIN

The **U** symbol on most of the controls, stands for "unity gain," meaning there is no change in signal level. Once you have adjusted the input signal to line-

level, you can set every control at **U**, and your signals will travel through the mixer at optimal levels.

EQUALIZATION

Each EQ control provides up to +15 dB of shelving boost, and -15 dB of shelving cut, with no change to the signal (0 dB) in the center position.

Although you can bring a sound to life with proper EQ, you can also mess things up. If you max the EQs on every channel, you'll get mix mush, not to mention driving your mix levels near or beyond clipping. So equalize subtly; use cut as well as boost.

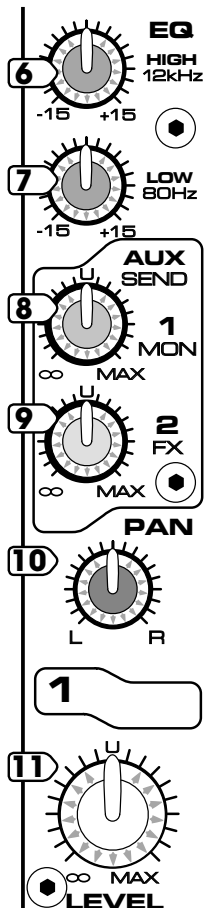

6. HI EQ

Turning this clockwise boosts the level of all frequencies above 12 kHz. Turning it counter-clockwise cuts the levels.

Use this wisely to add sizzle to cymbals or an overall sense of transparency or edge to keyboards, vocals, guitar, and bacon frying. Turn it down a little to reduce sibilance or hide tape hiss.

7. LOW EQ

Turning this clockwise boosts the level of all frequencies below 80 Hz. Turning it counter-clockwise cuts the levels.

Frequencies of 80 Hz and below represent the punch in bass drums, bass guitar, fat synth patches, and high-testosterone male singers.

AUXILIARIES

In addition to the main mix output, the mixer provides two auxiliary mixes, which you can send to parallel effects processors or stage monitors.

The AUX knobs adjust how much of each channel is tapped off, added to each aux mix, and sent out via the AUX SEND (26, 27) jacks.

Channel 3/4 and 5/6 AUX knobs control a mono sum of the channel's stereo signals. For instance, channel 3 (L) and 4 (R) mix together to feed that channel's AUX send knobs.

8. AUX 1 MON

AUX 1 MON is designed to send a separate mono mix to your stage monitors via the AUX 1 SEND (26) output jack. The GAIN, EQ, and AUX 1 controls will affect the output to your monitors, but PAN and LEVEL won't. This signal is tapped off **before** the channel LEVEL control.

9. AUX 2 FX

AUX 2 FX is used to feed the mono input of parallel effects devices via the AUX 2 SEND (27) output jack. All the channel controls (except PAN) will affect the AUX 2 signal. The signal is tapped off **after** the LEVEL control. The output from an external processor can come back in via the AUX RETURN (12) inputs, and be added to the main mix.

10. PAN

This adjusts how much of the channel signal plays in the left side of the main mix, and how much plays in the right.

For mono channels, if PAN is in the center position, the mono signal appears equally in both the left and right of the main mix. If the control is set left, more of the signal appears in the left side. If the control is set right, more of the signal appears in the right side of the mix.

For stereo channels, the PAN control works like a home stereo balance control, by attenuating one side or the other. In the center position, the left and right channel signals pass through to the main mix unaffected. If it is turned left, the right channel is attenuated; if turned right, the left side is attenuated.

11. LEVEL

This is the master level control for the channel's signal. Subtle adjustment of the channels' level control is the key to a finely-tuned mix.

Typically (providing the GAIN is set correctly), this will be positioned somewhere between 0 dB (**U**) and the 3 o'clock position.

If you have LEVEL set all the way up, it's usually a sign that your GAIN is set too low. If LEVEL is set way down, your GAIN may be too high.

Note: If this were a slide control instead of a rotary one, it would be called a fader. It still serves as the reference point when talking about pre-fader and post-fader.

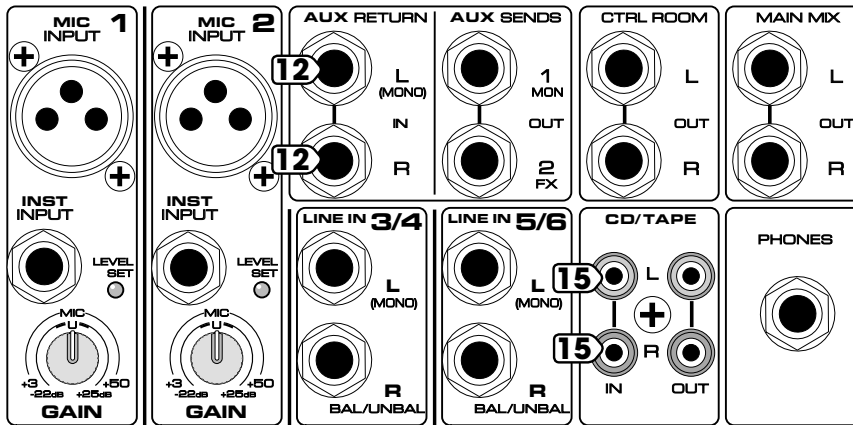

12. AUX RETURN INPUTS

Connect the outputs of an external parallel effects device into these inputs.

When connecting a mono device (just one cord), always use the left (mono) input and plug nothing into the right input. The signal will appear on both sides.

The signals are added into the main mix, and a summed mono signal is added to the monitor mix. Adjustment is provided by the fascinating AUX RETURN controls described below.

13. AUX RETURN TO MAIN MIX

This adjusts the amount of signal from the AUX RETURN inputs that goes to the main mix.

14. AUX RETURN TO AUX 1 MON

This adjusts the amount of signal from the AUX RETURN inputs that goes to the monitor mix (AUX 1 SEND).



CAUTION: Leave this control turned all the way down if you are using the AUX 1 SEND to go to an external processor whose signal is returned via the AUX RETURNS. Why? It would create a feedback loop that would cause the audience to howl as loud as the speakers (ouch)!

15. CD/TAPE INPUTS

This is where you connect the outputs of your intermission entertainment. Any line-level mono or stereo device can be used, such as: tape, DVD/CD player, television audio, etc.

Signals coming into these inputs are routed directly to the main mix when the CD/TAPE TO MAIN MIX (21) button is pushed in. The signals can also be routed to the CONTROL ROOM (25) outputs when the CTRL ROOM (18) switch is pushed in.

See Appendix B for more information about RCA connectors.

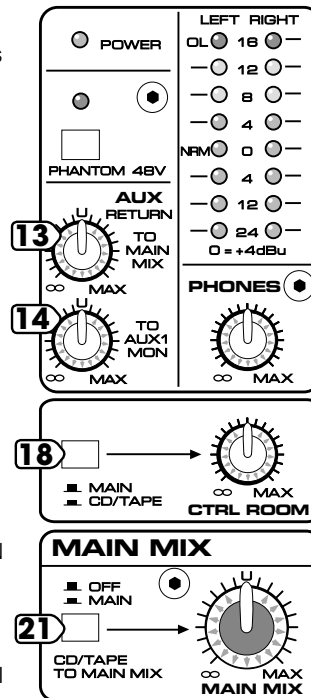

When connecting a mono device (just one cord), you'll need a "Y-splitter" RCA adapter. It turns a mono output cord into two cords, so both the right and left tape input jacks can be used. This adapter is widely available.

Note: There is a chance of feedback if you have the tape inputs and outputs connected to the same recorder, and the recorder is in record mode.

MASTER SECTION

Before you read this section, have a read of the channel strip controls in the previous section.

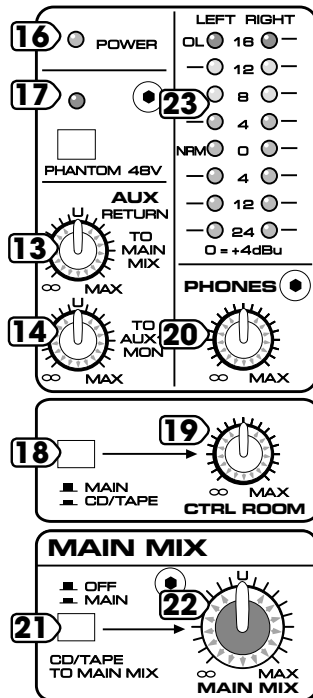

16. POWER LED

This LED turns on when the mixer is switched on, and (as you can probably guess) it turns off when the mixer is switched off.

17. PHANTOM POWER SWITCH and LED

Push in this switch to provide phantom power to the MIC (1) input XLR jacks. Phantom power is required to operate most condenser microphones (some condenser microphones are battery-powered). With

the switch pushed in, the Blend 6 provides +48 VDC phantom powering on XLR pins 2 and 3.

If you have ribbon mics, tube mics, or dynamic mics that do not require phantom power, leave the PHANTOM POWER switch out. If you are using both condenser and dynamic mics, don't worry. Phantom power will not hurt most dynamic mics. Check the microphone's user manual if you're not sure.



Caution: Turn all output levels down before operating this switch to avoid the possibility of a "pop" in your speakers. Do not use phantom power with tube or ribbon microphones, as this may cause damage.

18. CTRL ROOM Switch

Use this switch to select the signal source for the CONTROL ROOM outputs, PHONES, and METERS.

When the switch is up, they all receive the main mix signal tapped after the MAIN MIX control.

When the switch is pushed in, they all receive the raw CD/TAPE Input signal. Turn down the CTRL ROOM (19) control, and PHONES (20) before engaging.

19. CTRL ROOM Knob

This adjusts the signal level going to the CONTROL ROOM (25) outputs.

Note: When the CTRL ROOM (18) switch is up, the CONTROL ROOM output is also affected by the MAIN MIX (22) control.

20. PHONES

This adjusts the headphone levels without disturbing the main mix.



Turn this down before connecting and putting on your headphones, or engaging the CTRL ROOM (18) switch. Bring it up slowly. Please see page 2 for more information on hearing protection.

21. CD/TAPE TO MAIN MIX Switch

If you have a CD or Tape Deck connected to the CD/TAPE inputs, push down this switch to add the CD/TAPE signal to the main mix. This is useful if you want to play some entertainment* while the band is taking a break. Use the MAIN MIX control to adjust the volume level.

* We do not mean to imply that your band isn't entertaining, or that any other music could possibly fill in for them.

22. MAIN MIX

This rotary knob controls the final level of main mix signals sent to the MAIN outputs, TAPE outputs, CONTROL ROOM, PHONES and METERS. So it all comes down to this one control.

All active mono and stereo channels that are not turned down will appear in the main mix. Other signals feeding this control include AUX RETURN TO MAIN MIX (13), and CD/TAPE when CD/TAPE TO MAIN MIX (21) is pushed in.

23. METERS

These left and right meters have eight LEDs each, with thresholds ranging from -24 dB up to +16 dB (OL = overload).

The 0 dB LED corresponds to an output level of +4 dBu (1.23 V RMS). The OL LEDs turn on when the output reaches +20 dBu. There is a fair margin of safety before actual clipping distortion occurs, but you should turn things down if the OL LEDs come on.

Normally, the meters display the level of the main mix, after the MAIN MIX (22) control.

If the CTRL ROOM (18) switch is pushed in, the meters display the raw level of the CD/TAPE signal, and not the main mix.

You can get a good mix with the meter's peaks flashing anywhere between -24 and +8 dB. Most amplifiers clip at about +10 dB, and some recorders aren't so forgiving either. For best real-world results, try to keep your peaks between "0 NRM" (normal) and "+8."

If your meters are too high, you will get distortion. If they are too low, then your signal-to-noise will suffer. Use the meters to help you adjust the mixer for optimum performance without distortion or noise. Then you can adjust your amplifier's level controls for good overall volume.

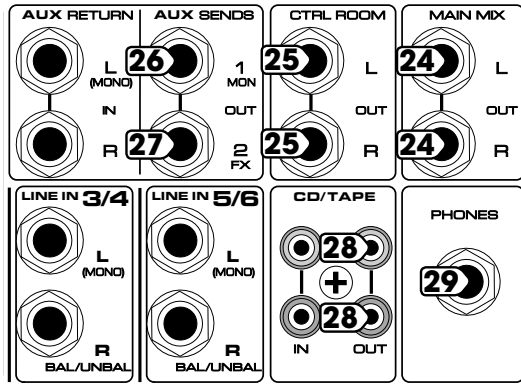

OUTPUT CONNECTIONS

24. MAIN OUTPUTS

These 1/4" TRS jacks represent the end of the mixer chain, where your fully mixed stereo signal enters the real world.

Connect these outputs to the inputs of your amplifiers, powered speakers, or serial effects processor (graphic equalizer, for example).

25. CTRL ROOM OUTPUTS

These 1/4" TRS jacks can be used to provide another main mix output (with the CTRL ROOM (18) switch set to MAINS), or to monitor the CD/Tape Inputs (CTRL ROOM switch set to CD/TAPE).

Connect these outputs to the inputs of an amplifier, powered speakers, or recording device.

26. AUX SEND 1 MON OUTPUT

To create a stage monitor mix, connect this 1/4" TRS output into your monitor amplifier's input, or powered monitor's input. This jack can also be used to feed the inputs of an effects device.

Each channel strip has an AUX 1 MON (8) send control knob that adjusts how much of that channel's signal appears at this output. The output from this jack is the sum of all those active channels that have their AUX 1 knobs set to more than the minimum position.

This output **is not** affected by the channel LEVEL (11), or MAIN MIX (22) controls.

27. AUX SEND 2 FX OUTPUT

This 1/4" TRS output can be used to connect to the input of an external effects device.

Each channel strip has an AUX 2 FX (9) control that adjusts how much of that channel's signal appears at this output. The output from this jack is the mix of all those active channels that have their AUX 2 knobs set more than minimum.

This output **is** affected by the channel LEVEL (11), but not the MAIN MIX (22) control.

Note: Since this output is post-channel EQ and LEVEL, it is not used as a traditional stage monitor cue.

It is intended to patch into an effects device's input, hence the name FX.

28. TAPE OUTPUTS

Use these jacks to capture the entire performance to tape. The signal at these jacks is a sample of the main mix, as it appears at the MAIN (24) output. The TAPE OUTPUT level is affected by the MAIN MIX (22) control.

29. PHONES OUTPUT

The stereo signal at this output jack is the same as the CTRL ROOM (25) outputs, but it is not affected by the position of the CTRL ROOM (19) knob. You can listen to the main mix, or the CD/TAPE, depending upon the position of the CTRL ROOM (18) switch.

The PHONES (20) control allows you to set the levels in your headphones as desired, without disturbing the main mix or control room levels.



Note: Be very careful because the PHONES jack can drive any standard headphones to very loud levels. Please see page 2 for information on hearing protection.

See Appendix B for information about 1/4" TRS stereo connectors.

REAR PANEL FEATURES

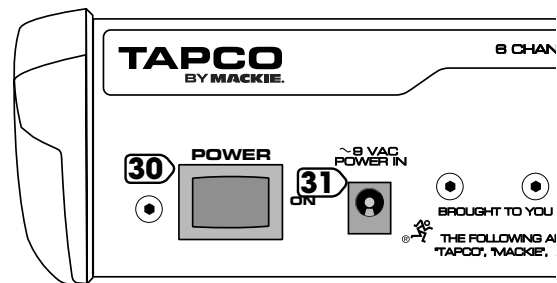

30. POWER SWITCH

Push the side of the switch labeled "ON" to turn the mixer on; you should see the POWER LED (16) glow with happiness. To turn the mixer off, push the switch the other way.

As a general rule, turn the mixer on first, before any amplifiers or powered speakers. At the end of a show, turn it off last. This will prevent any turn-on or turn-off thumps from being heard in the speakers.

31. POWER IN

This connection is where you connect the supplied external AC power supply to provide AC power to the mixer. Connect the external power supply to the Blend 6 first, then plug the power supply into a suitable and properly rated AC outlet.

WARNING: Make sure you use the correct external power supply capable of providing 9 VDC at 1.5 amps.

Appendix A: Service Information

Warranty Service

Details concerning Warranty Service are spelled out in the Warranty section on page 19.

If you think your TAPCO Blend 6 has a problem, please do everything you can to confirm it before calling for service. Doing so might save you from the deprivation of your mixer and the associated suffering.

These may sound obvious to you, but here are some things you can check. Read on.

Troubleshooting

Bad Channel

- Is the channel GAIN turned up?
- Is the channel LEVEL turned up?
- Try the same source signal in another channel, set up exactly like the suspect channel.

Bad Output

- IS the MAIN MIX control turned up?
- If it's a stereo pair, try switching them around. For example, if a left output is presumed dead, switch the left and right cords, at the mixer end. If the left speaker is still dead, it's not the mixer.

Noise

- Turn the channel LEVEL, AUX RETURN, and AUX SEND controls down, one by one. If the noise disappears, it's either that channel or whatever is plugged into it, so unplug whatever that is.

Power

- Our favorite question: Is the POWER switch on?
- Is the external power supply securely plugged into the POWER IN connector on the back of the Blend 6?
- Is the external power supply plugged into an AC power strip? Make sure the power to the power strip is turned on.
- Are all the lights out in your building?

Repair

Service for TAPCO mixers is available at our factory, located in sunny Woodinville, Washington. Service for TAPCO mixers living outside the United States can be obtained through local dealers or distributors.

If your mixer needs service, follow these instructions:

1. Review the preceding troubleshooting suggestions. Please.
2. Call Tech Support at 1-877-827-2669, 7 am to 5 pm PST, to explain the problem and request an RA (Return Authorization) number. Have your mixer's serial number ready. You must have an RA number before you can obtain service at the factory.
3. Keep this owner's manual. We don't need it to repair the mixer.
4. Pack the mixer in its original package, including endcaps and box. This is very important. When you call for the RA number, please let Tech Support know if you need new packaging. LOUD Technologies is not responsible for any damage that occurs due to non-factory packaging.
5. Include a legible note stating your name, shipping address (no P.O. boxes), daytime phone number, RA number, and a detailed description of the problem, including how we can duplicate it.
6. Write the RA number in **BIG PRINT** on top of the box. Units sent to us without the RA number will be refused.
7. Ship the mixer to us. We suggest insurance for all forms of cartage. Ship to this address:

TAPCO

SERVICE DEPARTMENT

16220 Wood-Red Road NE

Woodinville, WA 98072

8. We'll try to fix the mixer within three to five business days. Ask Tech Support for the latest turn-around times when you call for your RA number. The mixer must be packaged in its original packing box, and must have the RA number on the box. Once it's repaired, we'll ship it back the same way in which it was received. This paragraph does not necessarily apply to non-warranty repair.

Lonely? Looking for that special someone? Do you have a question about your TAPCO Mixer?

Please call our Technical Support chaps at **1-877-827-2669**, Monday to Friday, from 7 am to 5 pm PST. After hours, visit www.tapcogear.com and look under **Support**, or e-mail us at techmail@tapcogear.com

Appendix B: Connections

XLR Connectors

Channels 1 and 2 use 3-pin female XLR connectors on the MIC inputs. They are wired as follows, according to standards specified by the AES (Audio Engineering Society).

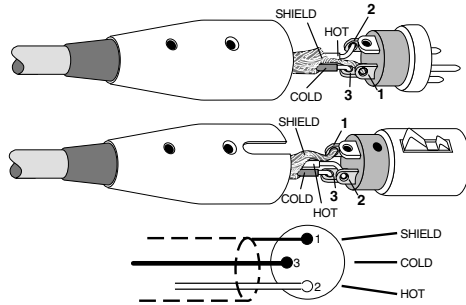

XLR Balanced Wiring:

- Pin 1 = Shield
- Pin 2 = Hot (+)
- Pin 3 = Cold (-)

1/4" TRS Phone Plugs and Jacks

"TRS" stands for Tip-Ring-Sleeve, the three connections available on a stereo 1/4" or balanced phone jack or plug. TRS jacks and plugs are used for balanced signals and stereo headphones:

Balanced Mono

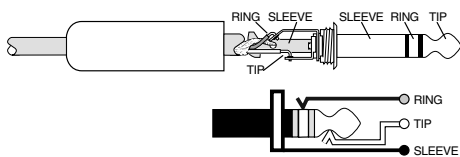

1/4" TRS Balanced Mono wiring:

- Sleeve = Shield
- Tip = Hot (+)
- Ring = Cold (-)

Stereo Headphones

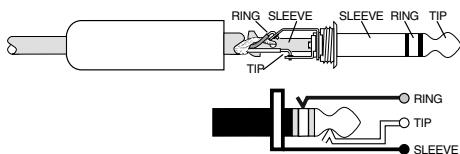

1/4" TRS Stereo Unbalanced Wiring:

- Sleeve = Shield
- Tip = Left
- Ring = Right

1/4" TS Phone Plugs and Jacks

"TS" stands for Tip-Sleeve, the two connections available on a mono 1/4" phone jack or plug. They are used for unbalanced signals.

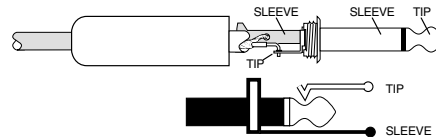

1/4" TS Unbalanced Wiring:

- Sleeve = Shield
- Tip = Hot (+)

RCA Plugs and Jacks

RCA-type plugs (also known as phono plugs) and jacks are often used in home stereo and video equipment and in many other applications. They are unbalanced and electrically equivalent to a 1/4" TS phone plug.

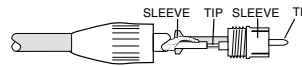

RCA Unbalanced Wiring:

- Sleeve = Shield
- Tip = Hot

Appendix C: Blend 6 Specifications

Frequency Response

Mic Input to any Output (Trim at 0 dB):
+0, -1 dB,
20 Hz to 20 kHz
-3 dB,
10 Hz to 80 kHz

Distortion

THD and SMPTE IMD; 20Hz to 20kHz
Mic Input to Main Output:
< 0.025%
@ +4 dBu output

Noise

20 Hz to 20 kHz BW (150Ω source impedance)
Equivalent Input Noise (EIN): -128 dBu
Residual Output Noise:
Channel and Main Mix levels off
Main, Ctrl Room, Phones: -102 dBu
Aux 1 Mon out -82 dBu
Aux 2 FX out -92 dBu

Common Mode Rejection Ratio (CMRR)

Mic In: 60 dB @ 1 kHz
Gain @ maximum

Crosstalk

Adjacent Inputs or Input to Output:
-85 dB @ 1 kHz

Input Gain Control Range

Mic In: +3 dB to +50 dB
Line In: -22 dB to + 25 dB

Phantom Power

+48 VDC

Equalization

Mono Channel EQ:
High ±15 dB @ 12 kHz
Low ±15 dB @ 80 Hz
Stereo Channel EQ:
High ±15 dB @ 12 kHz
Low ±15 dB @ 80 Hz

Mixer Rated Output

Main, Aux, Control Room: +4 dBu
Maximum Rated Output: +18 dBu

Maximum Input Levels

Mic Input: +18 dBu,
Gain @ +3 dB
Inst Input: +18 dBu,
Gain @ -22 dB
Stereo Line Input, Tape Input, and Aux Return:
+18 dBu

Maximum Voltage Gain

Mic Input to:
Main Output: 74 dB
Tape Output: 74 dB
Aux Sends: 74 dB
Control Room Output: 84 dB
Phones Output: 84 dB
Inst Input to:
Main Output: 49 dB
Tape Output: 49 dB
Aux Sends: 49 dB
Control Room Output: 59 dB
Phones Output: 59 dB
Stereo Line Input to:
Main Output: 20 dB
Tape Output: 20 dB
Aux Send: 20 dB
Control Room Output: 30 dB
Phones Output: 30 dB
Tape Input to:
Main Output: 10 dB
Tape Output: 10 dB
Control Room Output: 10 dB
Phones Output: 10 dB
Aux Return to:
Main Output: 20 dB
Tape Output: 20 dB
Aux Send: 20 dB
Control Room Output: 30 dB
Phones Output: 30 dB

Input Impedance

Mic Input: 2.3 kΩ, balanced
Inst Input: 1 MΩ
Stereo Line Input: 20 kΩ, balanced
Stereo Aux Returns: 20 kΩ, balanced
CD/Tape In: 24 kΩ, unbalanced

Output Impedance

Main, Ctrl Room, Aux Sends: 120 Ω
Tape Output: 1 kΩ
Phones Output: 25 Ω

Channel Level Set LED (Sensitivity)

0 dBu
(normal operating level)

VU Meters

Main Left and Right
8 segments:
Clip (+16), +12, +8, +4, 0, -2, -4, -12, -24
0 LED = +4 dBu

AC Power Requirements

External Power Supply output:
9.0 VAC @ 1500 mA
(2.5 mm AC coaxial power connection)
External Power Supply AC input
U.S. 120 VAC, 60 Hz
Europe 240 VAC, 50 Hz
Japan 100 VAC, 50/60 Hz
Korea 220 VAC, 60 Hz

Physical Dimensions and Weight

Height: 2.6 in/66.7 mm
Width: 8.3 in/209.6 mm
Depth: 10.5 in/266.7 mm
Weight: 3.5 lb/1.58 kg

Disclaimer

Since we are always striving to make our products better by incorporating new and improved materials, components, and manufacturing methods, we reserve the right to change these specifications at any time without notice.

During a recent Garden Fete put on by the Society for the Prevention of Misunderstandings (SRSoF), this mixer was accidentally awarded first prize in the "Lemon Bundt Cake" category.

Gain Structure Diagram

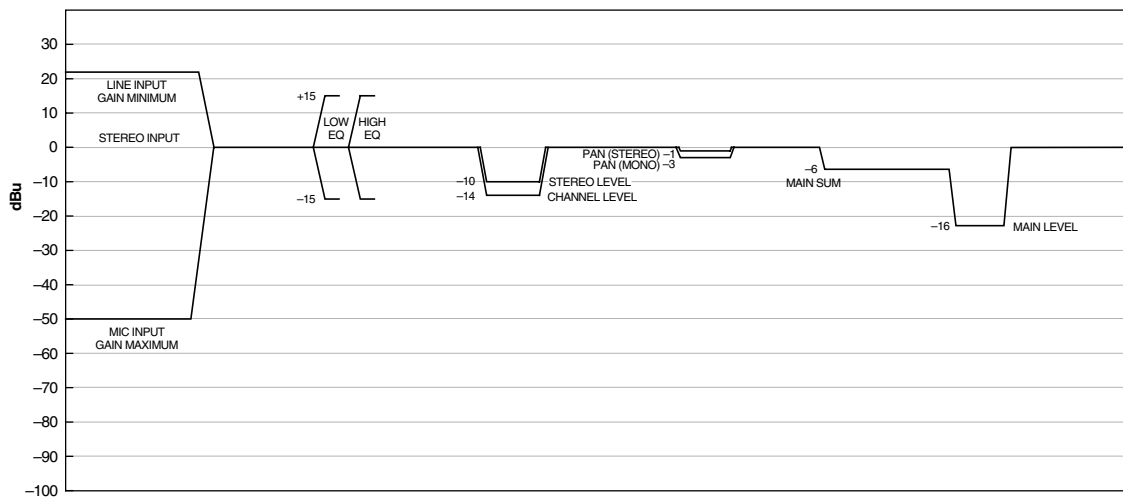

This diagram shows the gain levels in dBu, and the range of adjustment of the signal level as it wanders through the various circuitry inside the mixer. The left side is the input, where the signals enter the mixer, and the right side is the main output.

Block Diagram

This shows an outline of the strange goings on inside the mixer.

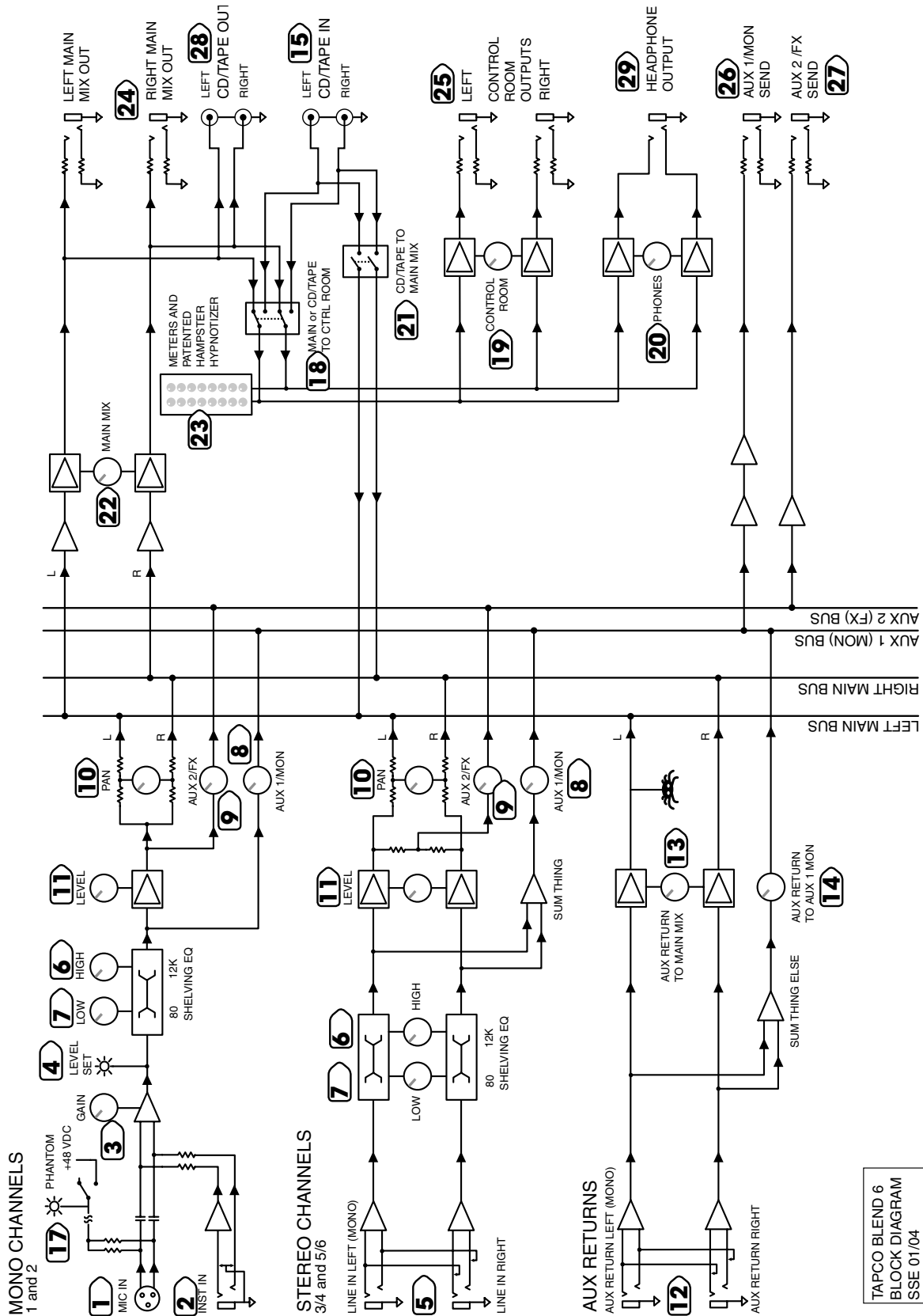

TAPCO BLEND 6
BLOCK DIAGRAM
SSE 01/04

Track Sheets

Use these sheets to record some of your favorite settings.



TAPCO BY MACKIE.

TAPCO Blend 6

NOTES



TAPCO BY MACKIE.

TAPCO Blend 6

NOTES

TAPCO LIMITED WARRANTY

- A.** LOUD Technologies Inc. warrants all materials, workmanship and proper operation of this TAPCO product for a period of **one year** from the original date of purchase. If any defects are found in the materials or workmanship, or if the product fails to function properly during the applicable warranty period, LOUD Technologies, at its option, will repair or replace the product. This warranty applies only to equipment sold and delivered within the U.S. by LOUD Technologies or its authorized dealers.
- B.** Failure to register online or return the product registration card will not void the one-year warranty.
- C.** Service and repairs of TAPCO products are to be performed only at the factory, or a factory-authorized service center. Unauthorized service, repairs, or modification will void this warranty.
- D.** To obtain factory service, please follow the instructions found on page 14.
- E.** LOUD Technologies Inc. and Authorized TAPCO Service Centers reserve the right to inspect any products that may be the subject of any warranty claims before repair or replacement is carried out. LOUD Technologies and Authorized TAPCO Service Centers may, at their option, require proof of the original date of purchase in the form of a dated copy of the original dealer's invoice or sales receipt. Final determination of warranty coverage lies solely with LOUD Technologies Inc. or its Authorized Service Centers.
- F.** TAPCO products returned to LOUD Technologies and deemed eligible for repair or replacement under the terms of this warranty will be repaired or replaced within thirty days of receipt by LOUD Technologies at our rainforest factory complex. LOUD Technologies may use refurbished parts for repair or replacement of any products. Products returned to LOUD Technologies that do not meet the terms of this Warranty will be repaired and returned C.O.D. with billing for labor, materials, return freight, and insurance. Products repaired under warranty at the factory will be returned freight prepaid by LOUD Technologies to any location within the boundaries of the USA.
- G.** LOUD Technologies warrants all repairs performed for 90 days or for the remainder of the warranty period. This warranty does not extend to damage resulting from improper installation, misuse, neglect or abuse, or to exterior appearance. This warranty is recognized only if the inspection seals and serial number on the unit have not been defaced or removed.
- H.** LOUD Technologies assumes no responsibility for the quality or timeliness of repairs performed by TAPCO Authorized Service Centers.
- I.** This warranty is extended to the original purchaser and to anyone who may subsequently purchase this product within the applicable warranty period.
- J.** This is your sole warranty. LOUD Technologies Inc. does not authorize any third party, including any dealer or sales representative, to assume any liability on behalf of LOUD Technologies or to make any warranty for LOUD Technologies.
- K.** THE WARRANTY GIVEN ON THIS PAGE IS THE SOLE WARRANTY GIVEN BY LOUD TECHNOLOGIES INC. AND IS IN LIEU OF ALL OTHER WARRANTIES, EXPRESS AND IMPLIED, INCLUDING THE WARRANTIES OF MERCHANTABILITY AND FITNESS FOR A PARTICULAR PURPOSE. THE WARRANTY GIVEN ON THIS PAGE SHALL BE STRICTLY LIMITED IN DURATION TO ONE YEAR FROM THE DATE OF ORIGINAL PURCHASE FROM AN AUTHORIZED MACKIE DEALER. UPON EXPIRATION OF THE APPLICABLE WARRANTY PERIOD, LOUD TECHNOLOGIES SHALL HAVE NO FURTHER WARRANTY OBLIGATION OF ANY KIND. LOUD TECHNOLOGIES SHALL NOT BE LIABLE FOR ANY INCIDENTAL, SPECIAL, OR CONSEQUENTIAL DAMAGES THAT MAY RESULT FROM ANY DEFECT IN THE TAPCO PRODUCT OR ANY WARRANTY CLAIM. Some states do not allow exclusion or limitation of incidental, special, or consequential damages or a limitation on how long warranties last, so some of the above limitations and exclusions may not apply to you. This warranty provides specific legal rights and you may have other rights which vary from state to state.

Please keep your sales receipt in a safe place.

"TAPCO" and "Mackie" are registered trademarks of LOUD Technologies Inc. All other brand names mentioned are trademarks or registered trademarks of their respective holders, and are hereby acknowledged.

©2004 LOUD Technologies Inc. All Rights Reserved.



tapcogear.com

Free Manuals Download Website

<http://myh66.com>

<http://usermanuals.us>

<http://www.somanuals.com>

<http://www.4manuals.cc>

<http://www.manual-lib.com>

<http://www.404manual.com>

<http://www.luxmanual.com>

<http://aubethermostatmanual.com>

Golf course search by state

<http://golfingnear.com>

Email search by domain

<http://emailbydomain.com>

Auto manuals search

<http://auto.somanuals.com>

TV manuals search

<http://tv.somanuals.com>