

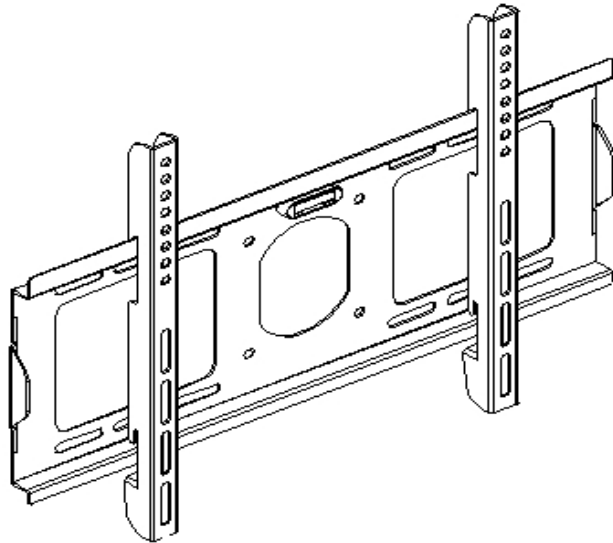

Low Profile Universal TV Mount - 32" to 60"

Installation Instructions











Fixed LCD / TFT TV Wall Mount
Material: 2.0mm Cold Rolled Steel Plate
TV Size: 32" - 60"
Max load capacity: 165 lbs / 75 kgs
Wall distance: 30mm / 1.2"
Bubble level system included
Universal Mounting Pattern

IMPORTANT: If you don't understand the installation instructions, please consult an installation specialist













04-0528C

INSTALLATION AND OPERATING INSTRUCTIONS

Caution

	Prior to the installation of this product, the installation instructions should be read and completely understood. The installation instructions must be read to prevent personal injury and property damage. Keep these installation instructions in an easily accessible location for future reference.
	CAUTION: The maximum load capacity is 165 lbs. Use with products exceeding the maximum load capacity may cause serious injury. See apparatus instructions.
	Recommended mounting surfaces: wood stud and solid-flat concrete. If the mount is to be installed on any surface other than wood studs, use suitable hardware (not included but commercially available).
	Do not install on a structure that is prone to vibration, movement or chance of impact. Failure to do so could result in damage to the display and/or damage to the mounting surface.
	Do not install near heater, fireplace, air conditioning, in direct sunlight, or any other heat producing source. Failure to do so may result in damage to the display and could increase the risk of fire.
	The wall structure must be capable of supporting at least the maximum load capacity as indicated. If not, the wall must be reinforced. Proper installation procedure by yourself or a qualified service technician, as outlined in the installation instructions, must be adhered to. Failure to do so could result in serious personal injury.
	When mounting to a wall that contains wood studs, confirm dead center of the wood stud prior to installation, it is recommended that the wood studs be a minimum of 16" apart.
	It is recommended that two people perform the installation. Injury and/or damage can result from dropping or mishandling the display.

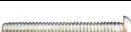
Hardware kit:

A	(×4) M4×12 screw		G	(×4) M6×35 screw	
B	(×4) M4×16 screw		H	(×4) M8×35 screw	
C	(×4) M5×16 screw		I	(×4) M8/M6/M5 Washer	
D	(×4) M6×16 screw		J	(×6) M8x80 Bolt	
E	(×4) M8×16 screw		K	(×6) M8 concrete anchor	
F	(×4) M4×35 screw		L	(×6) M8 Washer	
			M	(×4) M8 Spacer	

Tools Required:

- 1 Phillips head screw driver
- 2 Stud finder for drywall installation
- 3 5/16" Socket and Wrench
- 4 Electric drill and 5/16" (8mm) masonry bit for concrete/brick installation

Note: Please ensure that the bubble level is properly mounted on the wall plate prior to mounting the wall plate.

Step1: Wall Plate Installation

a) Wood Stud Installation

NOTE: When mounting to wood studs, the two wood studs must be a minimum of 16" apart.

- 1 Use a high-quality electronic stud finder (commercially available) to locate dead center of two studs and mark their locations with a pencil (figure 1-a).
- 2 With the help of an assistant, and using the bubble level to ensure the wall plate is level, position the wall plate against the wall in the desired mounting location.
- 3 Mark the right (upper and lower) and the left (upper and lower) positions of the small horizontal slots that are in alignment with the studs (figure 1-b).
- 4 You should mark four positions total.
- 5 Next, pre-drill a 1/4" hole to a depth of 2" in the wall stud at each marked location.
- 6 Place the wall plate against the wall and line up the mounting slots with the drilled holes. Check the bubble level to verify that the wall plate is level.
- 7 For each location, insert a lag bolt (J) and washer (L) into the wall
- 8 Tighten the bolt with an open ended socket wrench by turning clockwise until tight.

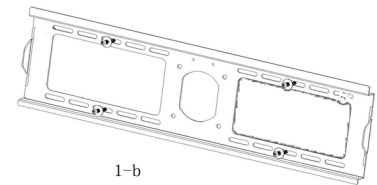
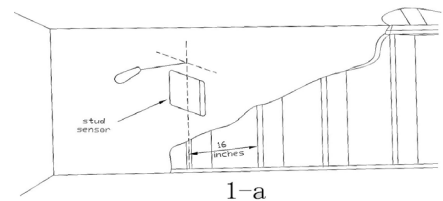

CAUTION: Do not over-tighten bolts-doing so many cause unnecessary damage to the wall. Avoid excessive torque.

CAUTION: Do not release the wall plate until it is properly mounted and secured to the wall.

b) Concrete/Brick Installation

NOTE: The concrete anchors must be used for concrete installation.

- 1 Begin by placing the wall plate into position against the wall, using the bubble level to keep it level.
- 2 Mark four holes to be used for securing the mount and place the wall plate aside.
- 3 Next, drill holes using an electric drill and 5/16" masonry bit to a depth of 2".
- 4 Insert a concrete anchor into each hole.
- 5 If necessary, a hammer can be used to lightly tap each anchor into place so that they are flush with the wall.
- 6 Once all of the anchors are in place, move the wall plate back into position
- 7 Insert bolt (J) with washer (L) into each concrete anchor in the wall.
- 8 Do not tighten until all screws are in place.

Step 2 Display Bracket Installation

- 1 To ensure optimal installation, this kit includes various screws of different diameters and lengths.
- 2 Place your TV screen down on a soft, flat surface, and locate the threaded mounting points that are located on the back of the display.
- 3 Determine which screw (A/B/C/D/E/F/G/H) is of the correct length by carefully inserting a straw, or toothpick, and mark how deep the mounting point is.
- 4 If your display has a curved back or a recessed thread mounting point, a spacer (M) must be used. Then choose screw (F/G/H) to match.
- 5 Place the spacer (M) between the mounting bracket and display.
- 6 According to the size of display's hole, choose the corresponding screw and hole on the rectangle washer, then thread them in line as shown (figure 2-a)

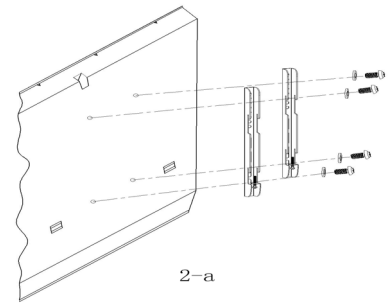

Step 3 Final Installation & Adjustment

- 1 Hook the TV Rails over the top of the wall plate (figure 3-a).
- 2 Then rotate the long screw at the bottom of the display rail to tighten.

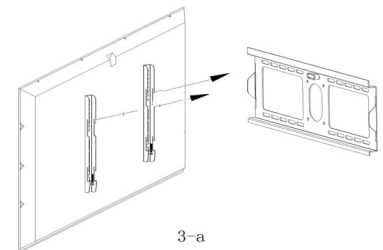

Maintenance

Check the mounting screws every two months for tightness.

Blank Page

Blank Page

Technical Support and Warranty

QUESTIONS? SIIG's Online Support has answers! Simply visit our web site at www.siig.com and click Support. Our online support database is updated daily with new drivers and solutions. Answers to your questions could be just a few clicks away. You can also submit questions online and a technical support analysts will promptly respond.

SIIG offers a 5-year manufacturer warranty with this product. This warranty covers the original purchaser and guarantees the product to be free of any defects in materials or workmanship for five (5) years from the date of purchase of the product.

SIIG will, at our discretion, repair or replace (with an identical product or product having similar features and functionality) the product if defective in materials or workmanship. This warranty gives you specific legal rights, and you may also have other rights which vary from state to state. Please see our web site for more warranty details.

If you encounter any problems with this product, please follow the procedures below.

- A) If it is within the store's return policy period, please return the product to the store where you purchased from.
- B) If your purchase has passed the store's return policy period, please follow these steps to have the product repaired or replaced.

Step 1: Submit your RMA request.

Go to www.siig.com, click Support, then click RMA to submit a request to SIIG RMA or fax a request to 510-657-5962. If the product is determined to be defective, an RMA number will be issued.

Step 2: After obtaining an RMA number, ship the product.

- Properly pack the product for shipping. All software, cable(s) and any other accessories that came with the original package must be included.
- Clearly write your RMA number on the top of the returned package. SIIG will refuse to accept any shipping package, and will not be responsible for a product returned without an RMA number posted on the outside of the shipping carton.
- You are responsible for the cost of shipping to SIIG. Ship the product to the following address:
SIIG, Inc.
6078 Stewart Avenue
Fremont, CA 94538-3152, USA
RMA #: _____
- SIIG will ship the repaired or replaced product via Ground in the U.S. and International Economy outside of the U.S. at no cost to the customer.

About SIIG, Inc.

Founded in 1985, SIIG, Inc. is a leading manufacturer of IT connectivity solutions (including Serial ATA and Ultra ATA Controllers, FireWire, USB, and legacy I/O adapters) that bridge the connection between Desktop/Notebook systems and external peripherals. SIIG continues to grow by adding A/V and Digital Signage connectivity solutions to our extensive portfolio. All centered around the distribution and switching of A/V signals over CAT5/6, these products include matrix switches, distribution amplifiers, extenders, converters, splitters, cabling, and more.

SIIG is the premier one-stop source of upgrades and is committed to providing high quality products while keeping economical and competitive prices. High-quality control standards are evident by one of the lowest defective return rates in the industry. Our products offer comprehensive user manuals, user-friendly features, and most products are backed by a lifetime warranty.

SIIG products can be found in many computer retail stores, mail order catalogs, and e-commerce sites in the Americas, as well as through major distributors, system integrators, and VARs.

PRODUCT NAME

Low Profile Universal TV Mount - 32" to 60"

Low Profile Universal TV Mount - 32" to 64" is a trademark of SIIG, Inc. SIIG and the SIIG logo are registered trademarks of SIIG, Inc. Other names used in this publication are for identification only and may be trademarks of their respective owners.

September, 2010

Copyright © 2010 by SIIG, Inc. All rights reserved.

Free Manuals Download Website

<http://myh66.com>

<http://usermanuals.us>

<http://www.somanuals.com>

<http://www.4manuals.cc>

<http://www.manual-lib.com>

<http://www.404manual.com>

<http://www.luxmanual.com>

<http://aubethermostatmanual.com>

Golf course search by state

<http://golfingnear.com>

Email search by domain

<http://emailbydomain.com>

Auto manuals search

<http://auto.somanuals.com>

TV manuals search

<http://tv.somanuals.com>