

# SHARP®

## LASER PRINTER (Multi-function printer)

### Operation Manual

—— for printer operation and general information on multi functions ——

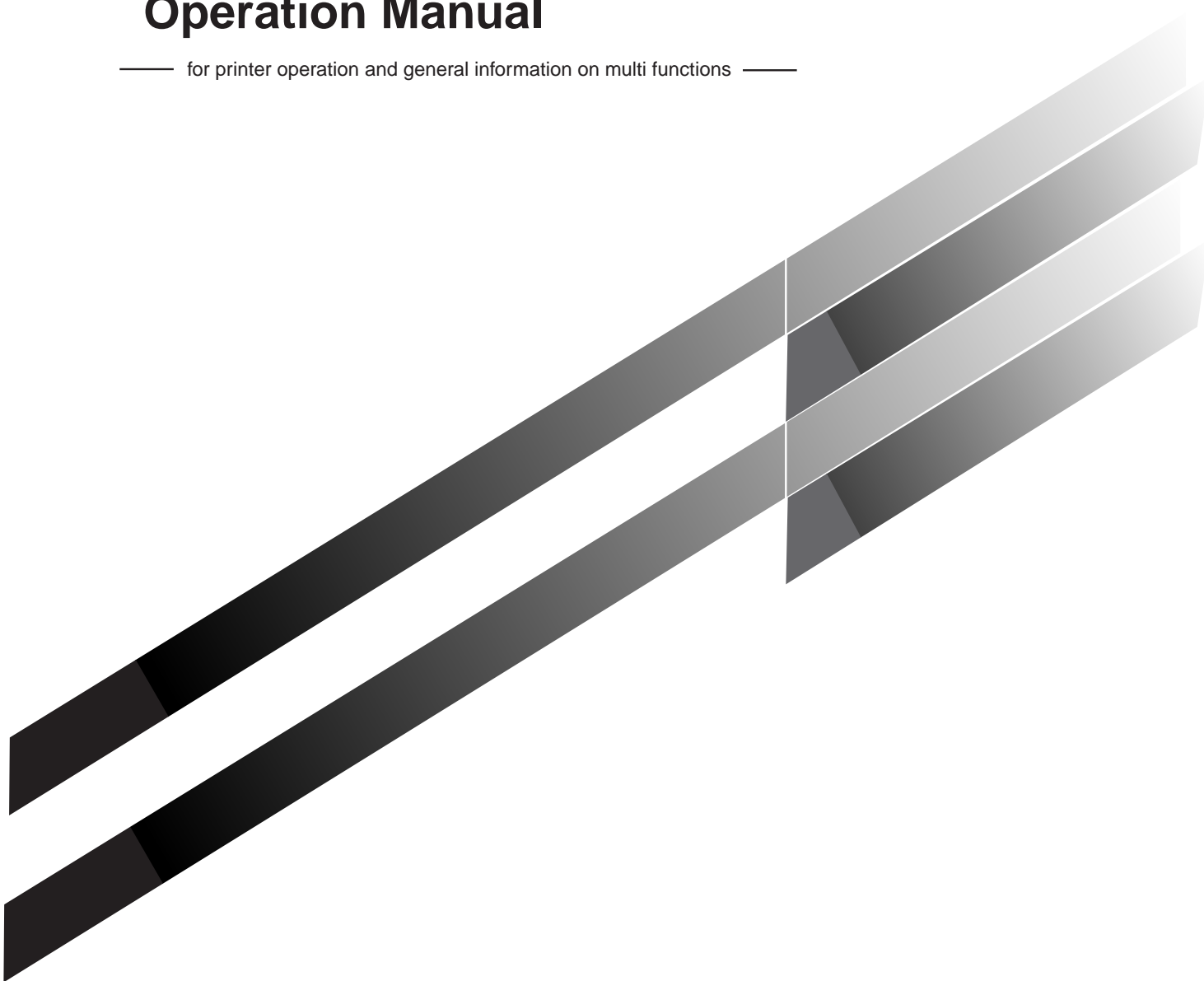



# INSTALLATION REQUIREMENTS

Improper installation may damage this product. Please note the following during initial installation and whenever the machine is moved.

1. The machine should be installed near an accessible power outlet for easy connection.

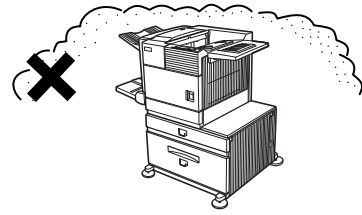

2. Be sure to connect the power cord only to a power outlet that meets the specified voltage and current requirements. Also make certain the outlet is properly grounded.
  - For the power supply requirements, see the name plate of the main unit.

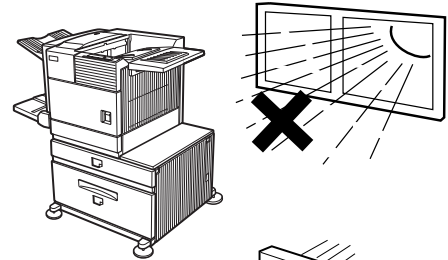

3. Do not install your machine in areas that are:
  - damp, humid, or very dusty
  - exposed to direct sunlight
  - poorly ventilated
  - subject to extreme temperature or humidity changes, e.g., near an air conditioner or heater.

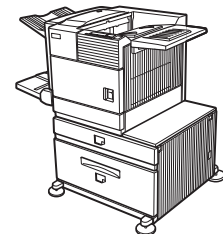
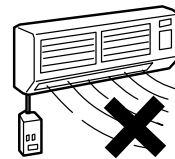
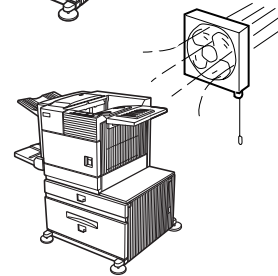

4. Be sure to allow the required space around the machine for servicing and proper ventilation.

A small amount of ozone is produced within the copier

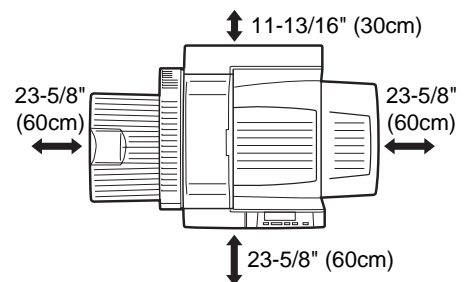

during operation. The emission level is insufficient to cause any health hazard.

**NOTE:**

The present recommended long term exposure limit for ozone is 0.1 ppm (0.2 mg/m<sup>3</sup>) calculated as an 8 hr. time-weighted average concentration. However, since the small amount that is emitted may have an objectionable odor, it is advisable to place the copier in a ventilated area.

# CAUTIONS

1. Do not touch the photoconductive drum. Scratches or smudges on the drum will cause dirty printouts.
2. The fusing unit is extremely hot. Exercise care in this area.
3. Do not look directly at the light source of a scanner module. Doing so may damage your eyes.
4. Five installation adjusters are provided on a stand/paper drawer which is provided as a peripheral unit. When moving the machine with a stand/paper drawer, be sure to raise the installation adjusters. After moving the machine, lower the five installation adjusters until they reach the floor.
5. Do not make modifications to this machine. Doing so may cause a fire or an electric shock.
6. When moving this machine, be sure to use two to four persons. Since this machine is heavy, moving it by yourself may cause an injury.
7. When connecting this machine to a computer, be sure turn off this machine and the computer in advance.
8. When opening or closing the covers or paper trays for misfeed removal or loading paper, take care not to get your fingers caught in the covers or trays.
9. Do not print anything which is prohibited from printing by law. The following items are normally prohibited from printing by national law. Other items may be prohibited by local law.
  - Money ● Stamps ● Bonds ● Stocks
  - Bank drafts ● Checks ● Passports
  - Driver's licenses

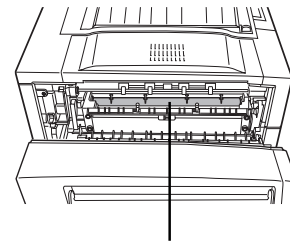

Fusing unit

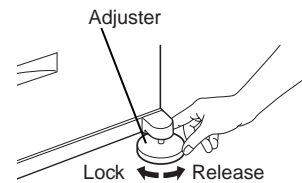
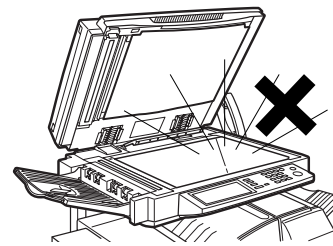

## "BATTERY DISPOSAL"

CONTAINS MANGANESE DIOXIDE LITHIUM BATTERY. MUST BE DISPOSED OF PROPERLY. CONTACT YOUR SHARP DEALER OR SERVICER FOR INSTRUCTIONS.

This product utilizes tin-lead solder, and fluorescent lamp containing a small amount of mercury. Disposal of these materials may be regulated due to environmental considerations. For disposal or recycling information, please contact your local authorities or the Electronics Industries Alliance: [www.eiae.org](http://www.eiae.org)

**Cautions on laser**

Wave length	785 nm $\pm$ 15 nm
Pulse times	North America: (4.0 $\mu$ s $\pm$ 4 ns)/7 mm Europe: (5.4 $\mu$ s $\pm$ 5.4 ns)/7 mm
Output power	0.25 mW - 0.50 mW

At the production line, the output power of the scanner unit is adjusted to 0.6 MILLIWATT PLUS 8 PCTS and is maintained constant by the operation of the Automatic Power Control (APC).

**Caution**

This product contains a low power laser device. To ensure continued safety do not remove any cover or attempt to gain access to the inside of the product. Refer all servicing to qualified personnel.

For North America:

**SAFETY PRECAUTIONS**

This Digital Equipment is rated Class 1 and complies with 21 CFR 1040.10 and 1040.11 of the CDRH standards. This means that the equipment does not produce hazardous laser radiation. For your safety, observe the precautions below.

- Do not remove the cabinet, operation panel or any other covers.
- The equipment's exterior covers contain several safety interlock switches. Do not bypass any safety interlock by inserting wedges or other items into switch slots.

**Caution**

Use of controls or adjustments or performance of procedures other than those specified herein may result in hazardous radiation exposure.

**CAUTIONS**

For Europe:

CLASS 1 LASER PRODUCT

LASER KLASSE 1

LUOKAN 1 LASERLAITE

KLASS 1 LASERAPPARAT

**CAUTION**  
INVISIBLE LASER RADIATION  
WHEN OPEN INTERLOCKS  
DEFEATED. AVOID EXPOSURE  
TO BEAM.

**VORSICHT**  
UNSICHTBARE  
LASERSTRAHLUNG WENN  
ABDECKUNG GEÖFFNET UND  
SICHERHEITSVERRIEGELUNG  
ÜBERBRÜCKT. NICHT DEM  
STRAHL AUSSETZEN.

**ADVARSEL**  
USYNLIG LASERSTRÅLNING  
VED ÅBNING, NÅR  
SIKKERHEDSBRYDERE ER  
UDE AF FUNKTION. UNDGÅ  
UDSAETTELSE FOR  
STRÅLNING.

**VAROITUS!**  
LAITTEEN KÄYTTÄMINEN  
MUULLA KUIN TÄSSÄ  
KÄYTTÖOHJEESSA  
MAINITULLA TAVALLA SAATTAA  
ALTISTAA KÄYTTÄJÄN  
TURVALLISUUSLUOKAN 1  
YLITTÄVÄLLE  
NÄKYMÄTTÖMÄLLE  
LASERSÄTEILYLLE.

**VARNING**  
OM APPARATEN ANVÄNDS PÅ  
ANNAT SÄTT ÄN I DENNA  
BRUKSANVISNING  
SPECIFICERATS, KAN  
ANVÄNDAREN UTSÄTTAS FÖR  
OSYNLIG LASERSTRÅLNING,  
SOM ÖVERSKRIDER GRÄNSEN  
FÖR LASERKLASS 1.



**CAUTION** INVISIBLE LASER RADIATION WHEN OPEN AND INTERLOCKS DEFEATED. AVOID EXPOSURE TO BEAM.  
**VORSICHT** UNSICHTBARE LASERSTRAHLUNG WENN ABDECKUNG GEÖFFNET UND SICHERHEITSVERRIEGELUNG ÜBERBRÜCKT. NICHT DEM STRAHL AUSSETZEN.  
**ADVARSEL** USYNLIG LASERSTRÅLNING VED ÅBNING, NÅR SIKKERHEDSBRYDERE ER UDE AF FUNKTION. UNDGÅ UDSAETTELSE FOR STRÅLNING.  
**ADVERSEL** USYNLIG LASERSTRÅLNING NÅR DEKSEL ÅPNES OG SICKERHEDSLÅS BRYTES. UNDGÅ EKSPONERING FOR STRÅLEN.  
**VARNING** OSYNLIG LASERSTRÅLNING NÅR DENNA DEL ÄR ÖPPNAD OCH SPRÄRRAR ÄR URKOPPLADE. STRÅLEN ÄR FÄRLIG. BETRAKTA EJ STRÅLEN.  
**VARO!** AVATTAESSA JA SUOJALUKITUS OHITETTAESSA OLET ALLTINA NÄKYMÄTÖNTÄ LASERSÄTEILYLLE. ÄLÄ KATSO SÄTEESEEN.

**注意 (サービスマン用)**  
 カバーを開けてかつインターロックを無効にした場合にはレーザー光にさらされないようにしてください。

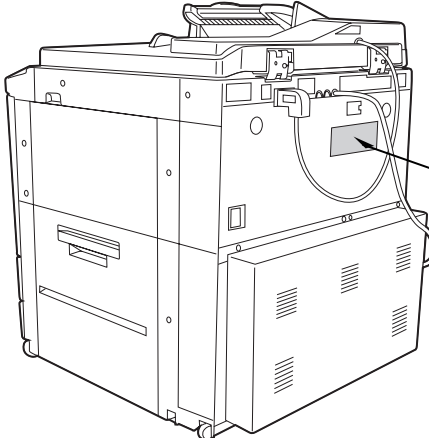
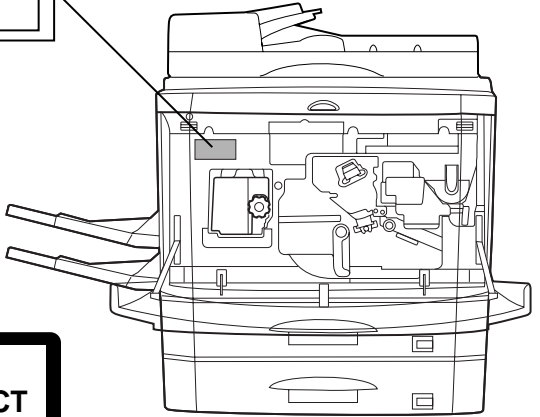
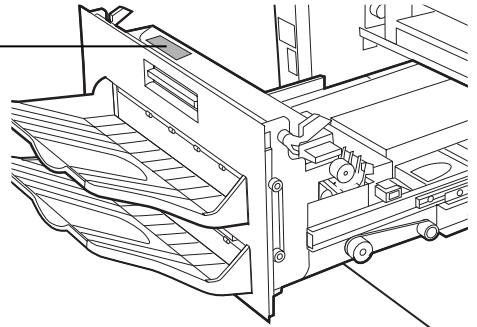

**CLASS 1  
LASER PRODUCT**

**LASER KLASSE 1**

# FACSIMILE FEATURE

When using this product as a facsimile by installing a facsimile expansion kit as a peripheral unit, refer to the following items for proper use.

For the description of use of the facsimile feature, see the facsimile operation manual supplied with the facsimile expansion kit.

## ■ Line connection

For connection between this product and telephone line, be sure to use the supplied connection cable. Connect the connecting cable so that the terminal near the core is inserted to the line connector of the facsimile expansion kit. Insert the other terminal (not the core side) to the socket of the telephone line.

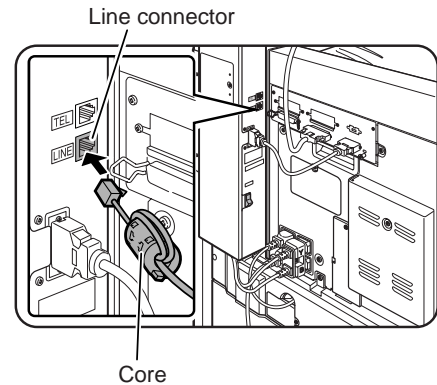

## ■ Fax power switch

When using this product as a facsimile, keep always the fax power switch on that is located on the facsimile expansion kit at the rear side of this product. (Do not turn it off.) If the fax power switch is off, the facsimile feature cannot be used.

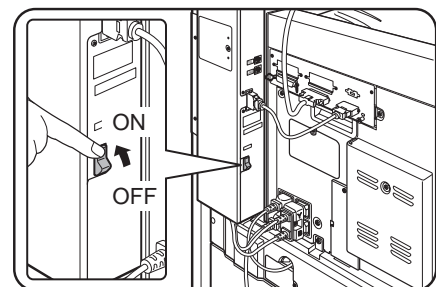

# CONTENTS

INSTALLATION REQUIREMENTS .....	Page 0-1
CAUTIONS .....	0-2
CONTENTS .....	0-5

## CHAPTER 1 BEFORE USING THE PRODUCT

INTRODUCTION .....	
MAIN FEATURES .....	
PART NAMES AND FUNCTIONS .....	
● Exterior* Interior .....	
● Part names and functions of peripheral units .....	
● Operation panel .....	
● Touch panel .....	
ADDING TONER .....	
LOADING PAPER .....	
● Loading paper in paper tray 1 .....	
● Changing the paper size in paper tray 1 .....	
● Paper available in paper trays .....	
● Paper available in the bypass tray/multi purpose drawer .....	
● Method of setting paper size and type .....	
● Setting from the operation panel of a scanner module .....	
● Loading paper in the multi purpose drawer .....	
● Changing paper size in the multi purpose drawer .....	
● Setting special paper in the multi purpose drawer .....	
● Specifications .....	
● Loading paper in the stand/3 x 500 sheet paper drawer .....	
● Changing paper size in the stand/3 x 500 sheet paper drawer .....	
● Specifications .....	
● Loading paper in the stand/MPD & 2000 sheet paper drawer .....	
● Specifications .....	

## CHAPTER 2 PRINTING FROM A COMPUTER

CONNECTING TO A COMPUTER .....	
SOFTWARE FOR WINDOWS .....	
INSTALLING PRINTER DRIVERS AND PRINTER UTILITIES .....	
REMOVING PRINTER DRIVERS AND PRINTER UTILITIES .....	

INSTALLING PRINTER DRIVERS USING THE PLUG & PLAY FUNCTION OR ADD PRINTER WIZARD .....	
---	--

- Before installation
- |                                  |  |
|----------------------------------|--|
| SETTING THE PRINTER DRIVER ..... |  |
|----------------------------------|--|
- Setting print conditions under Windows (selecting and setting print conditions) .....

REMOTE OPERATION THROUGH NETWORK .....	
--	--

- Environment required for accessing Web screen .....
- Accessing Web screen and displaying help .....
- Items and outline of menu frame of Web screen .....

PRINT FUNCTIONS WHICH REQUIRING PRINT START OPERATION FROM THE OPERATION PANEL AND THEIR OPERATION METHOD .....	
---	--

- Print functions selectable in the "JOB CONTROL" dialog box and their operation .....
- Printing method of hold job list .....
- Setting from the operation panel of a scanner module .....
- Printer account control

## CHAPTER 3 PRINTER BASIC SETTINGS

MAKING PRINTER CONFIGURATION SETTING .....	
--	--

- Operation procedure common to all printer configuration settings (items that can be set from the operation panel) .....
- Initial settings .....
- PCL settings .....
- PS settings .....

CUSTOM SETTINGS .....	
-----------------------	--

- Operation procedure common to all custom settings (items that can be set from the operation panel) .....
- Setting items .....



**CHAPTER 4****TROUBLESHOOTING AND MAINTENANCE**

MISFEED REMOVAL .....	
MACHINE TROUBLE? .....	
USER MAINTENANCE .....	
• Cleaning the cabinet of the main unit .....	
• Cleaning the paper feed section .....	
• Cleaning the document glass and document cover .....	

**CHAPTER 5****PERIPHERAL UNITS**

DUPLEX MODULE .....	
• Part names and functions .....	
• Specification .....	
• Loading paper in the bypass tray .....	
• Setting the printer driver for your purpose .....	
• Setting the copier for your purpose .....	
• Troubleshooting? .....	
MAIL-BIN STACKER .....	
• Part names and functions .....	
• Specification .....	
• Outline of mail-bin stacker .....	
• Using the mail-bin stacker .....	
• Misfeed removal in the mail-bin stacker .....	
FINISHER .....	
• Part names and functions .....	
• Specification .....	
• Outline of the finisher .....	
• Quick reference table for stapling .....	
• Using the finisher functions .....	
• Staple jam removal and staple cartridge replacement .....	
• Misfeed removal in the finisher .....	
• Troubleshooting? .....	
SADDLE STITCH FINISHER .....	
• Part names and functions .....	
• Specification .....	
• Outline of the finisher .....	
• Quick reference table for stapling .....	
• Printed image and saddle stitch .....	
• Using the finisher functions .....	
• Staple jam removal and staple cartridge replacement .....	
• Misfeed removal in the finisher .....	
• Troubleshooting? .....	

**CHAPTER 6****KEY OPERATOR PROGRAMS**

KEY OPERATOR PROGRAMS .....	
• Key operator program list .....	
• Using the key operator programs .....	
• Details of classification of setting items (hierarchical structure) and supplementary explanation of key operation .....	
• Description of programs .....	

**CHAPTER 7****APPENDIX**

PRINTER SPECIFICATIONS .....	
INTERFACE SPECIFICATIONS .....	
LIST OF COMBINATION OF PERIPHERAL UNITS .....	
PRINT AREA .....	





# CHAPTER 1

---

## BEFORE USING THE PRODUCT

---

This chapter describes basic information that should be read before using this product. Be sure to read this chapter before using this product.

	Page
INTRODUCTION .....	1-2
MAIN FEATURES .....	1-5
PART NAMES AND FUNCTIONS .....	1-6
● Exterior .....	1-6
● Interior .....	1-7
● Part names and functions of peripheral units .....	1-8
● Operation panel .....	1-11
● Touch panel .....	1-15
LOADING PAPER .....	1-18
● Loading paper in paper tray 1 .....	1-18
● Changing the paper size in paper tray 1 .....	1-18
● Paper available in paper trays .....	1-19
● Paper available in the bypass tray/multi purpose drawer .....	1-19
● Method of setting paper size and type .....	1-20
● Loading paper in the multi purpose drawer .....	1-22
● Specifications .....	1-22
● Loading paper in the stand/3 x 500 sheet paper drawer .....	1-23
● Specifications .....	1-23
● Loading paper in the stand/MPD & 2000 sheet paper drawer .....	1-24
● Specifications .....	1-24
ADDING TONER .....	1-25
STORAGE OF SUPPLIES .....	1-25

# INTRODUCTION

Read this operation manual carefully to use this product properly. Be sure to read "INSTALLATION REQUIREMENTS" and "CAUTIONS" before using this product.

Be sure to keep this operation manual handy to refer to it any time.

This product is a multi-function printer that can be used as a local printer and a network printer as well as a copier, network scanner, and a facsimile by installing various types of peripheral units (optional).

This operation manual describes the basic use of the product as a printer and also describes operation items common to the printer and other features such as loading paper, misfeed removal, and user maintenance.

If you extend this product to use the copier feature, network scanner feature, facsimile feature or network printer feature, relevant operation manuals are supplied. Read the respective manuals for using the features.

The following table shows the model names of the main units to which this operation manual applies and their product configuration.

(As of end of April 2001)

Model name	Product configuration
AR-P350	35 pages/minute printer
AR-P450	45 pages/minute printer
AR-M350	35 pages/minute printer (with a multi-function controller board)*1
AR-M450	45 pages/minute printer (with a multi-function controller board)*1
DM-3500	35 pages/minute printer
DM-3501	35 pages/minute network printer (with a print server card)*2
DM-3551	35 pages/minute network printer (with a multi-function controller board and a print server card)*3
DM-4500	45 pages/minute printer
DM-4501	45 pages/minute network printer (with a print server card)*2
DM-4551	45 pages/minute network printer (with a multi-function controller board and a print server card)*3

Although the peripheral units are basically optional, some units may be provided as standard components depending on the model.

\*1 A multi-function controller board required to extend the product to a multi-function printer that can be used as a copier, facsimile, and a network scanner is provided as a standard component.

\*2 A print server card required to extend the product to a network printer is provided as a standard component.

\*3 A multi-function controller board and a print server card are provided as standard components.

### Abbreviated names of peripheral units

The following unit is written with an abbreviated name without some exceptions to simplify the description in this manual.

#### “B/W scanner module/DSPF”

The unit is written as “scanner module”.

1

#### NOTES

- The scanner unit is a unit for scanning originals (automatic document feeder) when using the copier feature and facsimile feature. In the touch panel messages in the scanner module, the “scanner module” is displayed as “document feeder”.
- To use a scanned image as image data on a computer, a network scanner expansion kit (peripheral unit) is needed in addition to the network printer environment.

#### “Duplex module”

This is a unit that allows printing onto two sides of paper. A single “duplex module” and a “duplex module/bypass tray” are supplied. In this manual, both units are written as “duplex module” with some exception and description is made mainly for the “duplex module/bypass tray”. The description for the bypass tray, therefore, is made only for the “duplex module/bypass tray”. In the pages of “duplex module”, illustrations with an output tray are used. This output tray is optional for both the duplex modules. (not included in the duplex modules)

# INTRODUCTION

The following table shows the relation between the various functions described in this manual, copier operation manual, facsimile operation manual, and network scanner operation manual and the required peripheral units. In each operation manual, the optional peripheral units that are required for using each function is not particularly described. Refer to this table as needed.

○ = Must be installed ○\*1 = Any of the units must be installed. ○\*2 = Must be installed together with ○ or ○\*1. ○\*3 = Any of these units must be installed together with ○ or ○\*1. ○\*4 = Required when a stand/3 x 500 sheet paper drawer or a stand/MPD & 2000 sheet paper drawer is installed. ○\*5 = Any of these units must be installed together with ○ or ○\*1 but the multi purpose drawer is excluded when a saddle stitch finisher is installed. ○\*6 = Any of these units must be installed in addition to the peripheral units required at the minimum for using the copier feature. ○\*7 = Must be installed in addition to the peripheral units required at the minimum for using the facsimile feature.

	B/W scanner module/DSPF	Scanner rack	Multi purpose drawer	Stand/3 x 500 sheet paper drawer	Stand/MPD & 2000 sheet paper drawer	Duplex module/bypass tray	Duplex module	Saddle stitch finisher	Finisher	Mail-bin stacker	Exit tray	Upper exit tray extension	Punch module	Multi-function controller board	Print server card	PS3 expansion kit	Network scanner expansion kit	Facsimile expansion kit	Additional fax memory (8 MB)	Power supply unit	Hard disk drive
Common to all features																					
Manual paper feeding			○*3			○															○*4
Print onto special paper				○*1																	○*4
Two-sided print			○*3			○*1															○*4
Touch panel operation	○*1	○*2		○*3										○*2							○*2
Offset stack of printed sheets				○*5			○*1														○*2
Stapling of printed sheets				○*5			○*1														○*2
Center stapling of printed sheets				○*3			○*2	○					○								○*2
Punching of printed sheets				○*3			○*2	○													○*2
Mail bin stack of printed sheets				○*5						○											○*2
Printer feature																					
Network printer															○						
Job retention function																					○
Pamphlet print				○*3		○*1															○*2
PostScript3 compatibility																○					
Copier feature																					
Peripheral units required at the minimum for using the copier feature	○*1			○*1										○							○
Pamphlet copy								○*6													
Facsimile feature																					
Peripheral units required at the minimum for using the facsimile feature	○*1	○		○*1										○				○			○
Memory for original images of xx sheets or more																					○*7
Telephone call																					
Network scanner feature																					
Peripheral units required at the minimum for using the network scanner feature	○*1	○		○*1										○	○			○			○

# MAIN FEATURES

## Multi-function printer allowing extension of functions based on the purpose

This product is a multi-function printer that can be used as a local printer and a network printer as well as a copier, a network scanner, and a facsimile by combining peripheral units. Various optional units for improving productivity such as duplex modules for two-sided printing, additional paper feed units for large capacity paper stock, and paper output units for sorting printed sheets are provided as peripheral units.

1

## 600 dpi high resolution printing

High definition and high quality printing with 600 dpi resolution can be performed. Also high image quality equivalent to 1200 dpi can be output by using the soothing function.

## Monochrome high-speed printing

High-speed printing of 35 pages/minute or 45 pages/minute can be performed for 8-1/2" x 11" or A4 size.

## PostScript compatible

Installation of a PS3 expansion kit gives PostScript compatibility (PostScript level 3).

## ENERGY STAR

As an ENERGY STAR® Partner, SHARP has determined that this product meets the ENERGY STAR® guidelines for energy efficiency.

### Energy saving feature

This product has the following two power save modes that conform the Energy Star guidelines to conserve natural resources and to help reduce environmental pollution.



#### Preheat mode

The machine will enter the preheat mode once the time set with a key operator program has elapsed without any operation. In this mode, the fuser is maintained at a lower heat level thereby saving power.

#### Auto power shut-off mode

The machine will enter the auto power shut-off mode once the time set with a key operator program has elapsed without any operation. In this mode, power to the display and the fuser is turned off and only the lowest power is consumed. In this mode, power can be saved more than the preheat mode but more time is needed to return to the operating state. This mode can be disabled using a key operator program.

If this product is used as a printer, when print data is received in the preheat mode or the auto power shut-off mode, the mode will be automatically canceled and printing will start after the fuser temperature is restored to the normal operating level.

If this product is used as a multi-function machine, the mode will be automatically canceled when print data or facsimile data is received or when any key operation on the operation panel or original setting operation for copying or facsimile transmission is performed.

# PART NAMES AND FUNCTIONS

## Exterior

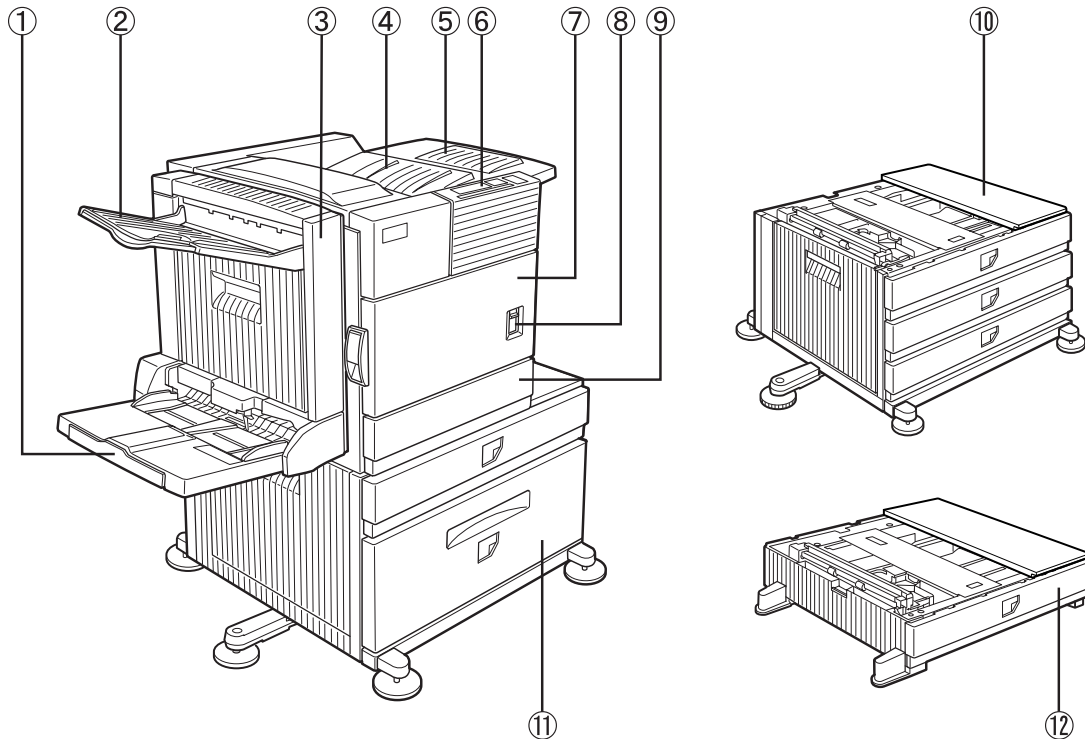

① Bypass tray (part of duplex module/bypass tray)\*1

② Exit tray\*1

③ Duplex module\*1  
Module for two-sided printing

④ Upper paper output area  
Finished sheets are deposited here.

⑤ Upper exit tray extension\*1  
Extension table for preventing dropping of large paper such as 11" x 17" and 8-1/2" x 14" (A3 and A4).

⑥ Operation panel (See page xxxx.)

⑦ Front cover  
Open to add toner and remove misfeeds.

⑧ Main switch (See page xxxx.)  
Press to turn power on and off.

⑨ Paper tray 1

⑩ Stand/3 x 500 sheet paper drawer\*1 (See page xxxx.)

⑪ Stand/MPD & 2000 sheet paper drawer\*1  
(See page xxxx.)

⑫ Multi purpose drawer\*1 (See page xxxx.)

\*1 ①, ②, ③, ⑤, ⑩, ⑪, and ⑫ are peripheral units. For description of these units, see page xx. The configuration of peripheral units varies with the main unit model.



## Interior

1

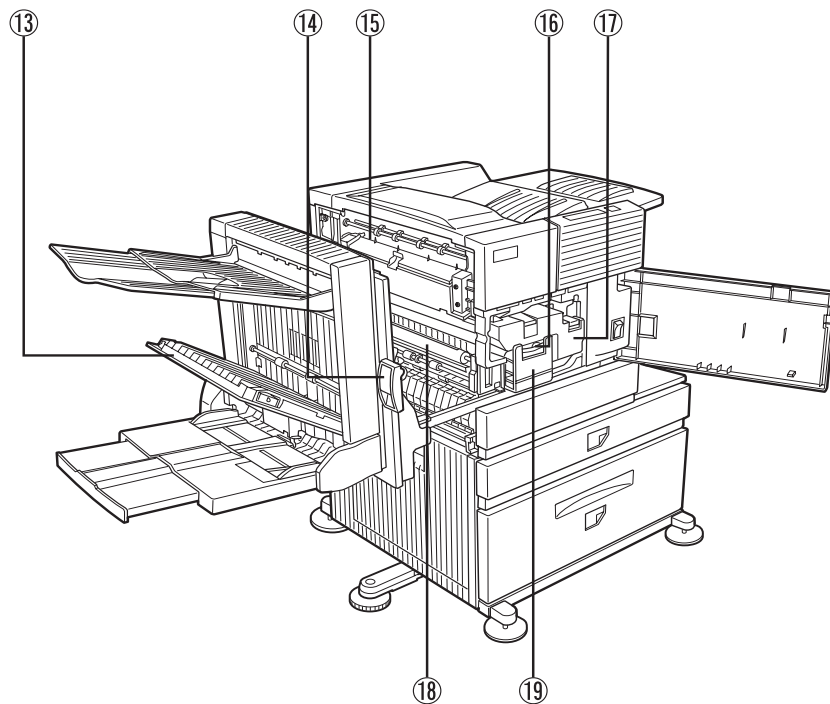
**13 Duplex module side cover**

Open when a misfeed has occurred in the duplex module.

**14 Side cover open knob**

Push up to open the side cover when a misfeed has occurred in the fusing unit.

**15 Fusing unit**

Image that has been transferred on paper is fixed by heating it in the fusing unit.

**CAUTION**

The fusing unit is hot. Take care in removing misfed paper.

**16 Developer cartridge\* (See page xxxx.)**

Container that contains developer. The cartridge must be removed and replaced with a new one at the time of replacement.

**17 Toner cartridge\* (See page xxxx.)**

Container that contains toner. When toner is exhausted, the cartridge must be removed and replaced with a new one.

**18 Photoconductive drum**

A photoconductor is applied to the surface of the photoconductive drum. Images are formed on the photoconductive drum.

**NOTE**

Do not touch or damage the photoconductive drum.

**19 Cartridge lock lever**

When replacing the drum, toner or developer cartridge, turn down this lever and pull it out.

\*2 For replacement and installation of each cartridge, see the separate manual "Supply Replacement Method."

# PART NAMES AND FUNCTIONS

## Part names and functions of peripheral units

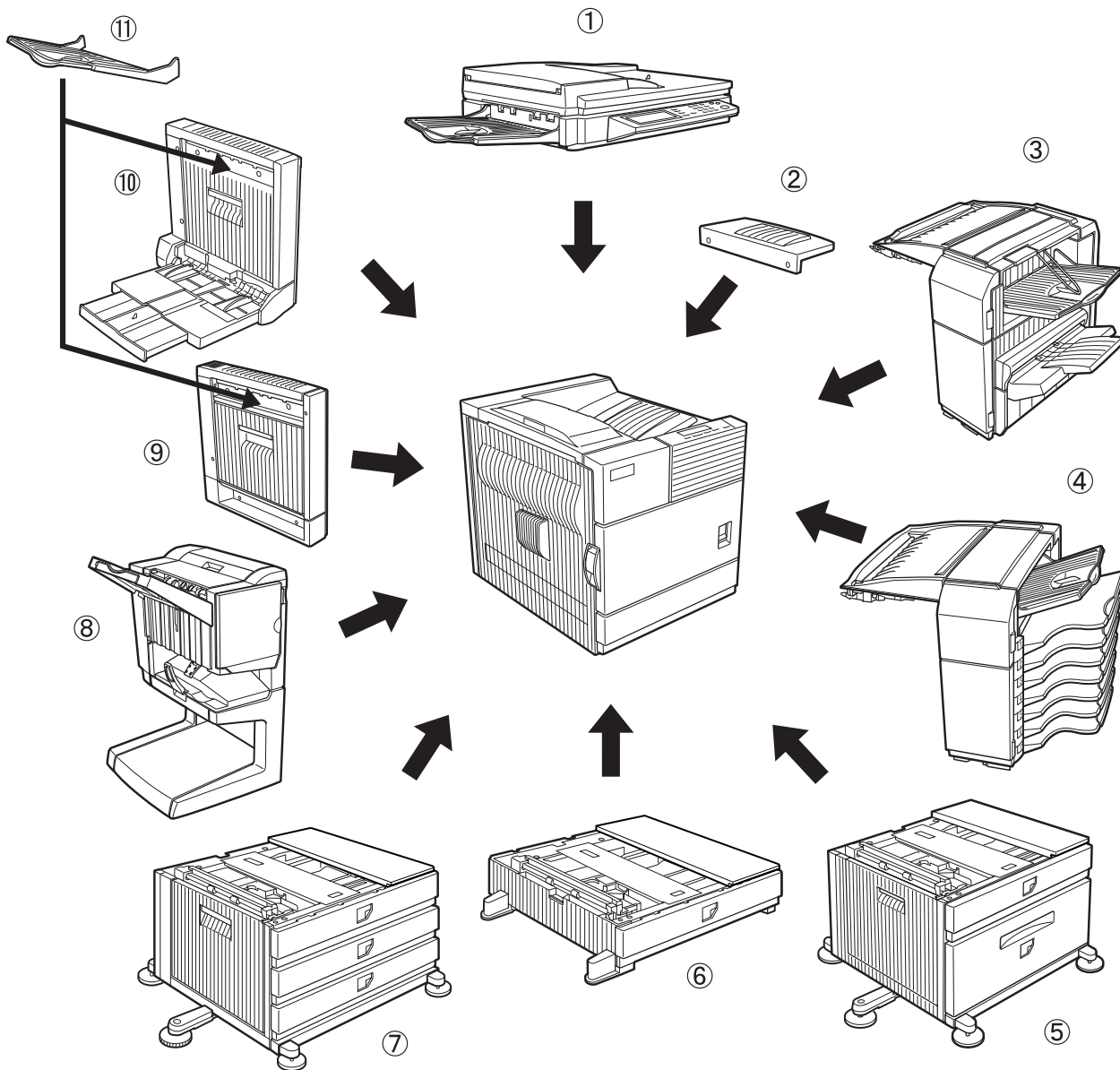

① **B/W scanner module/DSPF**

This unit is a monochrome scanner that allows automatic feeding of sheet originals and continuous scanning. The B/W scanner module/DSPF (Dual Single Pass Feeder) can scan two-sided sheet originals and can scan both sides at a time. Also a flat bed type document glass is provided in this unit for scanning an original that cannot be fed such as a book and thick original.

② **Upper exit tray extension**

Mount this unit to the upper paper exit tray. This unit is needed for output of 11" x 17" (A3) paper.

③ **Finisher**

Sorted output sheets or grouped output sheets by page are offset stacked so that each set can be taken out easily.

Also sorted output sheets can be stapled.

④ **Mail-bin stacker**

This unit is an output sheet sorting unit that contains seven bins. When printed sheets are output in the printer mode, a bin to which printed sheets are to be deposited can be specified in the printer driver. The bins can be classified by persons or by sections depending on users so that the users deliver their printed sheets to their specified bin. Sorted output separated from the other users, therefore, can be performed.

Output sheets in the copy and fax modes are deposited in the top tray other than these seven bins.

⑤ **Stand/MPD & 2000 sheet paper drawer**

This is a paper feed unit that contains two paper trays. The upper tray is equivalent to the multi purpose drawer. The lower tray holds approximately 2000 sheets of 20 lbs. (80 g/m<sup>2</sup>) paper.

⑥ **Multi purpose drawer**

Holds paper. Up to 500 sheets of 20 lbs. (80 g/m<sup>2</sup>) paper can be loaded. Also special papers such as envelopes (standard sizes only) and Japanese postcard can be set.

⑦ **Stand/3 x 500 sheet paper drawer**

This is a paper feed unit that contains three paper trays. The upper tray is equivalent to the multi purpose drawer. Each of the lower two trays holds up to 500 sheets of 20 lbs. (80 g/m<sup>2</sup>) paper.

⑧ **Saddle stitch finisher**

Sorted output sheets or grouped output sheets by page are offset stacked so that each set can be taken out easily. Also sorted output sheets can be stapled at the edge or at the center for center-stapled binding.

In addition, if a punch module is installed as a peripheral unit, punch holes can be made in the output sheets for filing.

⑨ **Duplex module**

Unit for automatic two-sided printing.

⑩ **Duplex module/bypass tray**

This module is equipped with a unit for automatic two-sided printing and a bypass tray manual paper feeding.

⑪ **Exit tray**

Mounted to the paper output port of a duplex module or a duplex module/bypass tray.

For installation of a peripheral unit, installation of some other peripheral units may be needed together and installation of some peripheral units may not be possible together. See page xx, "COMBINATION OF PERIPHERAL UNITS." Peripheral units are basically optional but some units may be provided as standard units depending on the main unit model.

## PART NAMES AND FUNCTIONS

---

### ■ Other peripheral units

- **Scanner rack**  
Rack required for installing a scanner module. The height is fixed.
- **Power supply unit**  
For installation of some peripheral units, this unit is required for supplying power to each unit.
- **Print server card**  
NIC (network interface card) for using the printer as a network printer.
- **Multi-function controller board**  
Printer controller required for using the copier, facsimile, and network scanner features.
- **PS3 expansion kit**  
Kit required for using the printer as a PostScript compatible printer. (for PostScript level 3)
- **Hard disk drive**  
Extends the image storing capacity for the printer and copier features (not for the facsimile feature). Also this unit is required for using the job retention function (see page xxxx) with which print data received for the printer feature is held temporarily instead of immediate output.
- **Facsimile expansion kit**  
Kit required for using the facsimile feature.
- **Additional fax memory (8 MB)**
- **Network scanner expansion kit**  
Kit required for using the network scanner feature.

For installation of a peripheral unit, installation of some other peripheral units may be needed together and installation of some peripheral units may not be possible together. See page xx, "COMBINATION OF PERIPHERAL UNITS." Peripheral units are basically optional but some units may be provided as standard units depending on the main unit model.

## Operation panel

The display and indicators in the operation panel located on the front of the machine indicate the current status of the printer. Also the keys on the operation panel allow settings required for printing.

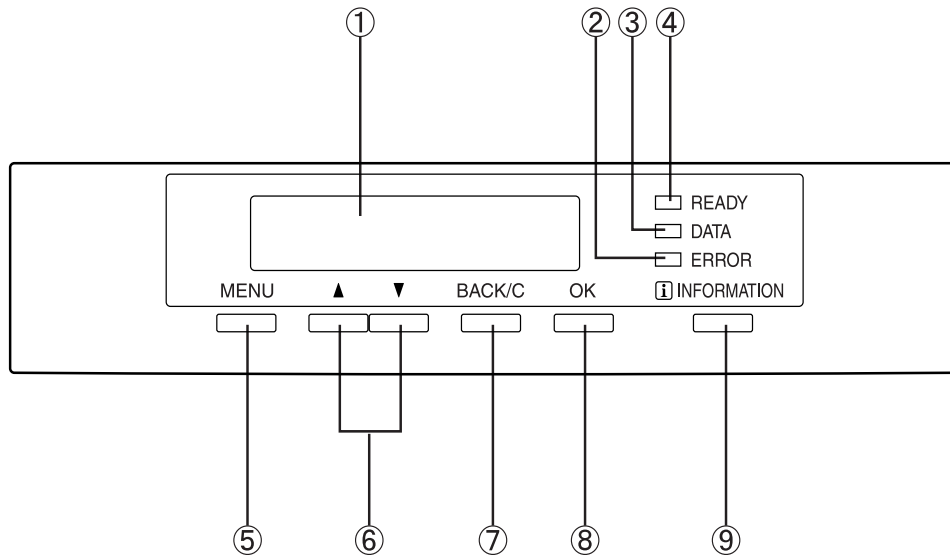

### ① Message display

Displays the printer current state. [i] displayed in messages indicates the [INFORMATIONS] key.

### ② [ERROR] indicator

Lights up when paper or toner must be added or when a misfeed has occurred. Blinks when an abnormal condition has occurred in this machine.

### ③ [DATA] indicator

Lights up or blinks when print data is being received. Also lights up when printing is being performed.

### ④ [READY] indicator

Printing can be executed when this indicator is lit.

### ⑤ [MENU] key

Press to select a menu group such as printer configuration menu (page xxx), custom settings, and execution of printing held by the retention function (page xxx). Press also to return to the menu screen from the setting screen of each menu group.

### ⑥ [▲/▼] keys

Press to select each menu or function or to set a number.

### ⑦ [BACK/C] key

Use this key to return to the previous screen in each menu selection, to cancel and delete the current job or to delete a reserved job that has been selected.

### ⑧ [OK] key

Press to register the selected menu or function.

### ⑨ [INFORMATION] key

When [ i ] is displayed with a message indicating a paper misfeed, requesting toner addition, etc., the relevant operation procedure can be displayed by pressing the [INFORMATION] key. If the [INFORMATION] key or the [BACK/C] key is pressed while the operation procedure is displayed, the information mode will be canceled. If you press and hold down this key while printing is being performed or in the standby, the total number of printed pages and quantity of toner remaining (as a percent) will be displayed.

# PART NAMES AND FUNCTIONS

## Menu group list and supplementary explanation of key operation (when using the operation panel on the main unit)

The menu groups are classified into the following five groups as shown below. These menu groups are selected by pressing the [MENU] key. If the [OK] key is pressed when the desired menu screen is displayed, a message indicating required operation will appear.

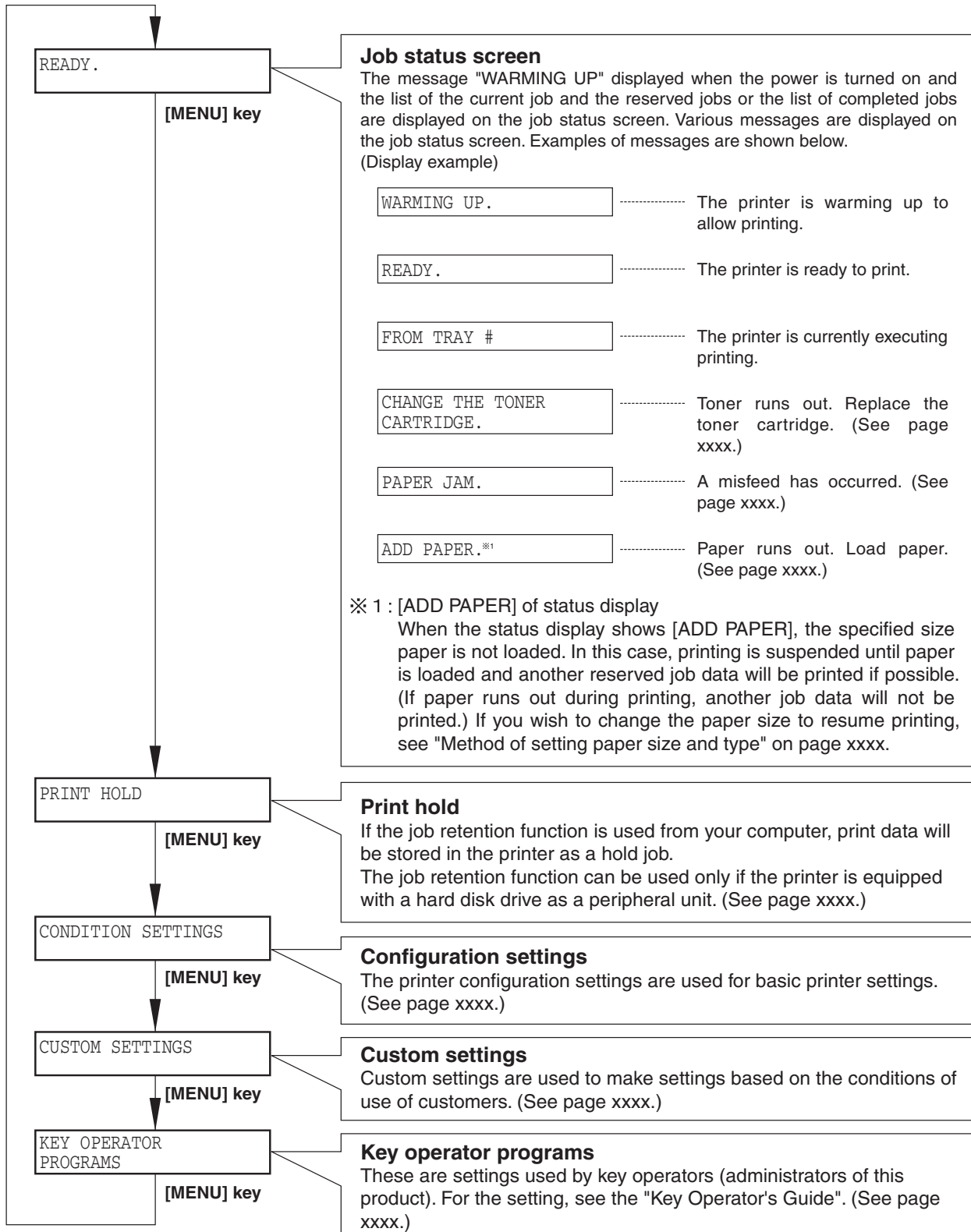

---

## Canceling the current print job and deleting the print data on the printer

- **To cancel the current print job and delete the print data:**

If you press the [BACK/C] key during printing, printing will be canceled and a confirmation message for deletion of data will appear. To delete the data, press the [OK] key.

To cancel deletion, press the [BACK/C] key. Printing will resume.

- **To delete print data of a reserved job (that waits for printing):**

Print data transmitted from computers will be stored in this printer (up to 99 jobs) and will be output sequentially. To delete print data of a reserved job before starting printing, press the [▲] or [▼] key to display the desired data in the message display. If you press the [BACK/C] key at this time, a confirmation message for deletion will appear. To delete the data, press the [OK] key.

To cancel deletion, press the [BACK/C] key. Printing will resume.

1

## PART NAMES AND FUNCTIONS

When the printer is equipped with a scanner module as a peripheral unit, use the operation panel with a touch panel on the scanner module.

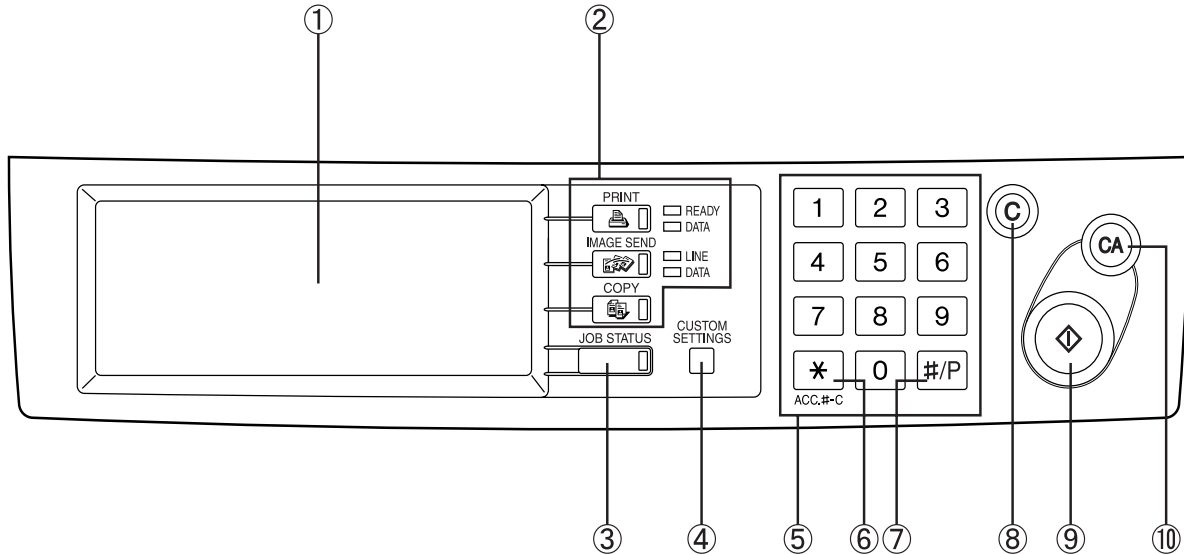

① **[Touch panel]**

Messages and keys are displayed here. Operation can be performed by touching keys displayed here. The display is switched depending on each function in the print, copy, network scan, and fax modes. For details, see page xxxx.

② **[Mode select] keys and indicators**

Use to switch the display mode of the touch panel.

 **[PRINT] key/READY indicator/DATA indicator**

Press to switch the display to the print mode. (See next page.)

● **READY indicator**

Printing can be performed when this indicator is lit.

● **DATA indicator**

Lights up or blinks when print data is being received. Also lights up when printing is being performed.

 **[IMAGE SEND] key/LINE indicator/DATA indicator**

Press to switch the display to the network scan/fax mode. (See page xxxx of the facsimile operation manual.)

 **[COPY] key**

Press to switch the display to the copy mode. (See page xxxx.)

③ **[JOB STATUS] key**

Press to display the current job status. (See page xxxx.)

④ **[CUSTOM SETTINGS] key**

Use to adjust the contrast of the touch panel or to set key operator programs.

⑤ **[Numeric] keys**

Use to enter a number in various settings.

⑥ **[\*] key ([ACC.#-C] key) (See page xxxx.)**

Use when using the copier feature and the facsimile feature.

⑦ **[#/P] key (See page xxxx.)**

Use when using the copier feature and the facsimile feature.

⑧ **[C] key**

Use when using the copier feature and the facsimile feature.

⑨ **[Start] key (See page xxxx.)**

Use when using the copier feature and the facsimile feature.

⑩ **[CA] key**

Use when using the copier feature and the facsimile feature.



## Touch panel

### Print mode screen

This screen is displayed when the print mode is selected.

(The display varies with the mode. For the display in other modes, see respective operation manuals.)

1

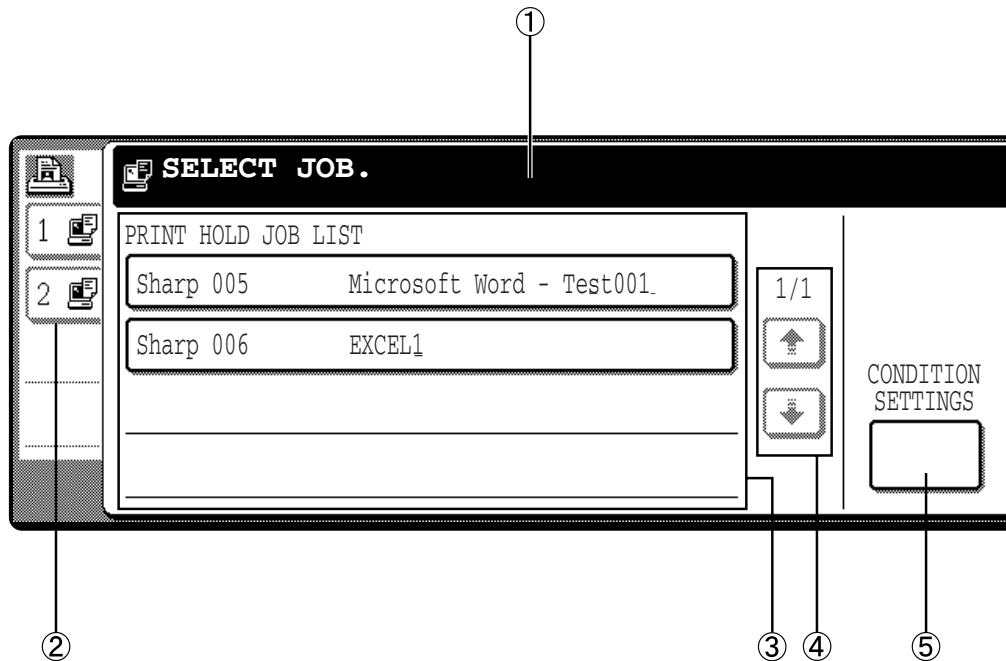

① **Message display**

Messages are displayed here.

② **Job status screen (See next page.)**

③ **Print hold job list**

If the job retention function (see page xxxx) is used, the list of stored print data is displayed here (up to 100 jobs). The job retention function can be used only if the printer is equipped with a hard disk drive as a peripheral unit.

④ **[Display switching] keys**

Use to switch the page of the print hold job list. If the list is not contained in a page, succeeding pages are prepared. Use these keys to switch the display.

⑤ **[CUSTOM SETTINGS] key**

Use to switch the display to the printer configuration menu (see page xxxx).

## PART NAMES AND FUNCTIONS

### Job status screen (common to print, copy, network scan, and fax modes)

This screen is displayed when the [JOB STATUS] key on the operation panel is pressed.

A job list which indicates the current job and reserved jobs or a job list which indicates completed jobs is displayed. You can check the contents of the jobs, give a reserved job the highest print priority in the print queue, and delete a job that you wish to cancel. (The following screen indicates a job list which indicates the current job and reserved jobs.)

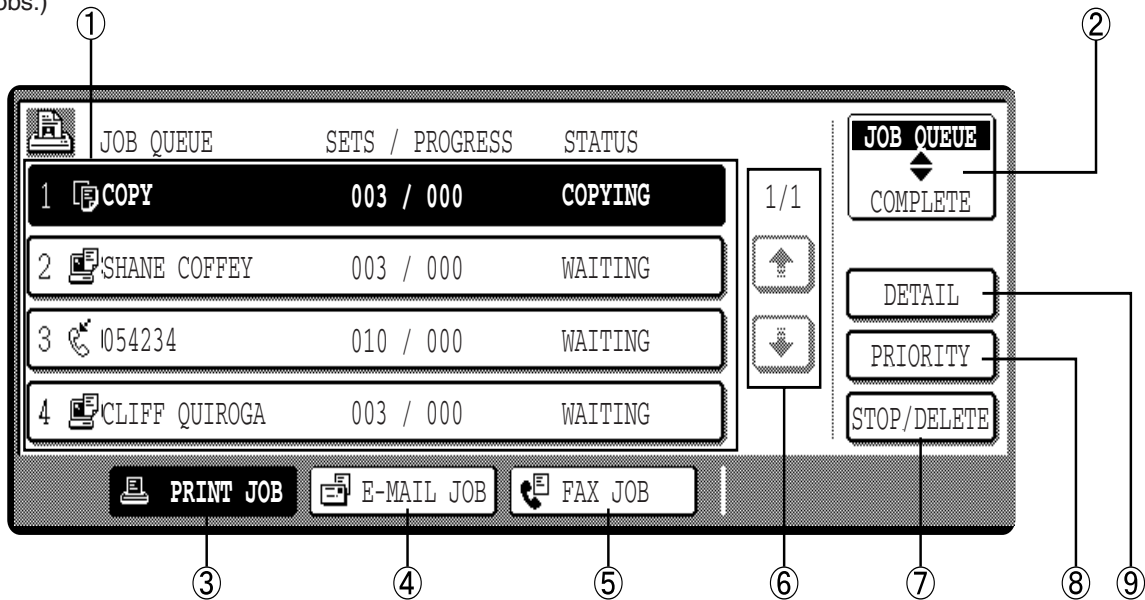

#### ① Job list

A job list which indicates the current job and reserved jobs or a job list which indicates completed jobs is displayed. The icons at the top of each job indicate the mode of each job.

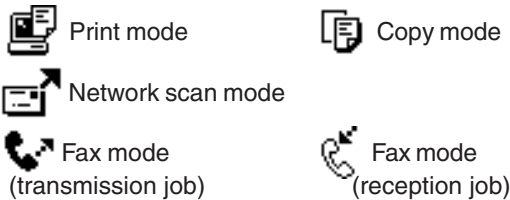

When a job list which indicates the current job and reserved jobs is displayed, the displayed jobs themselves are operation keys. To cancel printing or to give a job the highest print priority, touch the relevant job key to select the job and execute the desired operation using the keys described in 7, 8, and 9.

#### \*1: "PAPER EMPTY" in the job status display

When the job status display indicates "PAPER EMPTY", specified size paper is not loaded in any tray. In this case, printing is suspended until paper is loaded and another reserved job data will be printed if possible. (If paper runs out during printing, another job data will not be printed.) If you wish to change the paper size because you cannot prepare the specified size paper immediately, you can change the size by touching the current job key to select it and touch the [DETAIL] key described in ⑨.

#### ② [Mode switching] key

Use to switch the job list between "JOB QUEUE" and "COMPLETE".

"JOB QUEUE": Displays the list of the current job and the reserved jobs.

"COMPLETE": Displays the list of completed jobs.

#### ③ [PRINT JOB] key

Use to display the print job list for all modes (print, copy, network scan, and fax).

#### ④ [E-MAIL JOB] key

Use to display the list of jobs that use the network scanner feature.

#### ⑤ [FAX JOB] key

Use to display the fax communication status and the reserved transmission job status.

#### ⑥ [Display switching] keys

Use to switch the page of the displayed job list.

#### ⑦ [STOP/DELETE] key

Use to cancel or delete the current job or delete the selected reserved job. Reserved fax jobs, however, cannot be deleted.

#### ⑧ [PRIORITY] key

If you select a job among the reserved jobs in the "JOB QUEUE" job list to which you wish to give the highest priority and touch this key, the job will move to the highest priority reserved job.

#### ⑨ [DETAIL] key

Use to display the detailed information of the selected job. The paper size for printing can be changed from the specified size.

Using the touch panel

■ How to use the touch panel

[Example 1]

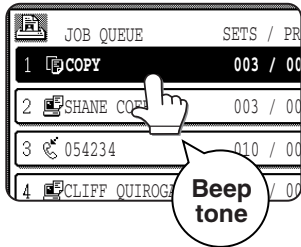

You can easily set or cancel a function by touching a key on the display with a finger. The touch panel operation can be confirmed with a beep tone and highlighted display.

[Example 2]

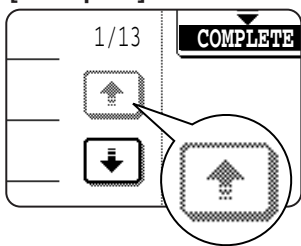

If any key is disabled on each screen, the key is displayed gray. If you press the key, two short beeps will be sounded.

The beep tone of key touch can be disabled by a key operator program. (See page xxxx of the Key Operator's guide.)

The touch panel (display) illustrated in this operation panel is a conceptual illustration.

■ Selection of function

[Example 1]

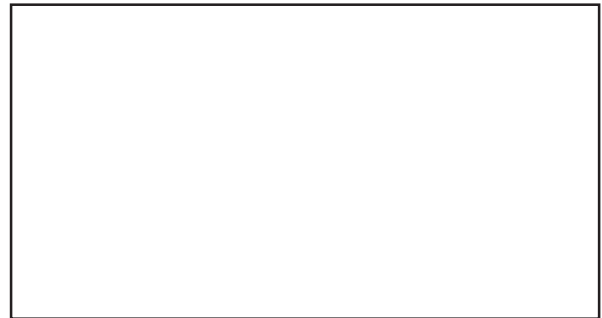

1

If any key is highlighted in the initial setting of each setting screen, the function will be registered when you touch the [OK] key without additional operation.

[Example 2]

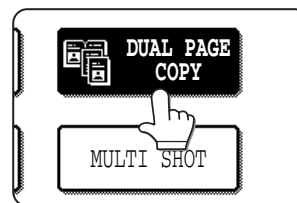

When using the copier feature or the facsimile feature, the functions shown below which can be set by only touching the relevant key in the special feature screen can be canceled by touching the key again (canceling highlighted display).

Copier feature	Facsimile feature
<ul style="list-style-type: none"> <li>• Dual page copy</li> <li>• B/W reverse</li> <li>• Rotation copying in two-sided copying</li> <li>• Centering</li> </ul>	<ul style="list-style-type: none"> <li>• Polling</li> <li>• Own number print</li> <li>• Page cutoff</li> </ul>

[Example 3]

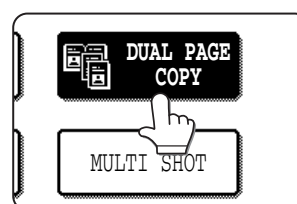
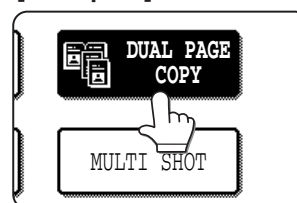

When using the copier feature or the facsimile feature, if a special function is set, the corresponding function icon will appear. If this icon is touched, the setting screen of the function (or a menu screen) will appear, allowing the settings to be checked or adjusted and the function to be canceled easily.

# LOADING PAPER

When paper runs out during printing, a message indicating that paper runs out will appear.

Follow the procedure below to load paper.

## NOTES

- Do not use curled or folded paper. Doing so may cause a misfeed.
- Use SHARP standard paper for paper tray 1. (See page xxxx.)
- When you change the paper type in paper tray 1, set the paper type referring to "Method of setting paper size and type" (page xxxx).
- Do not place a heavy object or press down hard on a tray when the tray is pulled out.

## Loading paper in paper tray 1

### 1 Pull out paper tray 1.

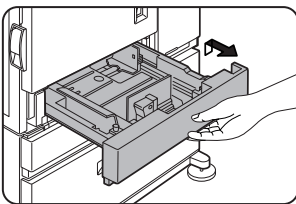

Gently pull the tray out until it stops.

### 2 Load paper into the tray.

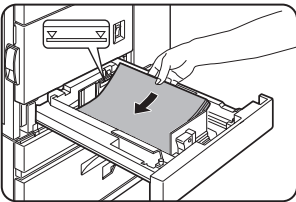

Do not load paper above the maximum height line (approximately 500 sheets of 20 lbs. (80 g/m<sup>2</sup>) paper).

### 3 Gently push paper tray 1.

Push the tray firmly all the way into the machine.

### 4 Set the paper type.

If you change the paper type, be sure to set the paper type referring to "Method of setting paper size and type" (page xxxx).

### 5 Loading of paper in paper tray 1 is now complete.

## Changing the paper size in paper tray 1

For paper tray 1, 8-1/2" x 11", A4 or B5 size paper can be set. Use the following procedure to change the size as needed.

### 1 Pull out paper tray 1.

If paper remains in the tray, remove it.

### 2 Adjust the guide plates A and B in the tray to the length and width of the paper.

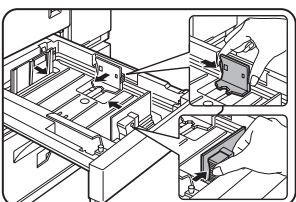

The guide plates A and B are slidable. Adjust them to the paper size to be loaded while squeezing their lock levers.

### 4 Gently push paper tray 1.

Push the tray firmly all the way into the machine.

### 5 Set the paper size.

Be sure to set the paper size and paper type referring to "Method of setting paper size and type" (page xxxx).

If this operation is not performed after the paper size has been changed, printing will be made to paper of a size other than the specified size and a paper misfeed may occur.

### 3 Load paper into the tray.

### 6 Changing of paper size in paper tray 1 is now complete.

### Paper available in paper trays

Paper that can be used varies with the paper trays. Use SHARP standard paper in the following paper trays.

- Paper tray 1
- Stand/MPD & 2000 sheet paper drawer
- Stand/3 x 500 sheet paper drawer

#### ■ Paper that can be used

- SHARP standard paper (See page xx.)
- Use SHARP standard paper ranging from 5-1/2" x 8-1/2" (A5) to 11" x 17" (A3).

### Paper available in the bypass tray/multi purpose drawer

Since the paper feeding method in the bypass tray and the multi purpose drawer varies with the paper type, be sure to feed paper using the method adequate to the paper type. If the paper feeding method is not proper, a paper misfeed or oblique feeding may occur.

#### ■ Paper that can be used

- SHARP standard paper
- Ordinary paper other than SHARP standard paper

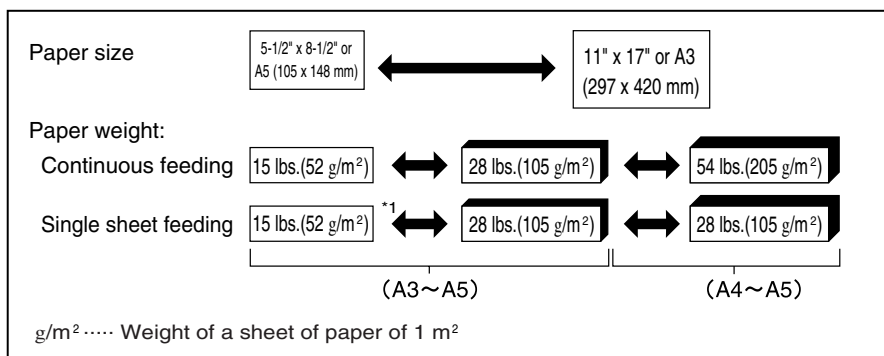

#### NOTES

- Do not use paper that is not included in the range described above. Improper fusing (fusing strength of toner to paper is weak and toner comes off if rubbed) and misfeeds may occur.
- Envelope
  - Standard envelope sizes are only the following four: Monarch (MON), Commercial-10 (C10), DL, and C5.
- Postcard
  - Double postcards can be used unless they have a fold. (Folded postcards cannot be used.)
  - Do not use unofficial postcards or picture postcards. They may cause misfeeds or smudges on printouts.
- Special paper
  - For transparency film, letterhead paper, recycled paper, pre-printed paper, pre-punched paper, colored paper, heavy paper, labels, and postcards, use SHARP recommended paper. Using paper that is not recommended by SHARP may cause misfeeds and smudges on printouts.
- Notebook paper
  - Do not use paper that has been cut manually. Paper misfeeds may occur.

#### NOTE

There are various types of special paper on the market and some of them cannot be used in this product. When using such paper, contact your SHARP dealer.

# LOADING PAPER

## Method of setting paper size and type

When the paper size or type is changed in a paper tray, set them referring to the following procedure.

### When using the operation panel on the main unit:

※ For setting paper size and type from the operation panel with touch panel, see the next page.

- 1 Press the [MENU] key repeatedly until "CUSTOM SETTINGS" will appear in the message display.

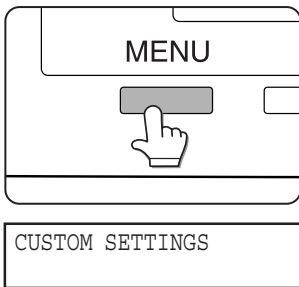

- 2 Press the [OK] key.

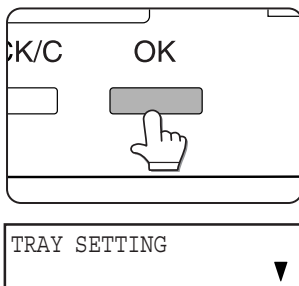

When the [OK] key is pressed, "TRAY SETTING" will appear in the message display.

- 3 Press the [OK] key.



When the [OK] key is pressed, "TRAY SETTING TRAY1" will appear in the message display.

- 4 Select the desired paper tray.

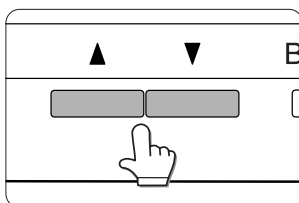

Press the ▲ or ▼ key on the operation panel repeatedly until the desired paper tray appears.

- 5 Press the [OK] key.

- 6 Ensure that the desired paper type for printing is selected.



- If TRAY 1 is selected, the message shown to the left will appear in the initial condition.

If the desired paper type for printing is not selected, press the ▲ or ▼ key on the operation panel. When you wish to print onto special paper, however, the paper tray must be TRAY 2 or BYPASS.

- 7 Press the [OK] key.

- 8 Ensure that the desired paper size for printing is selected.

If the desired paper size for printing is not selected, press the ▲ or ▼ key on the operation panel after checking the paper type.



- If TRAY 1 has been selected, the message shown to the left will appear.

- 9 Press the [OK] key to terminate the setting.

#### NOTE

Special paper such as transparency film, labels, and postcards can be set for tray 2 and the bypass tray. Envelopes can be set only for tray 2.

When using the operation panel with touch panel:

**1** Press the [CUSTOM SETTINGS] key.

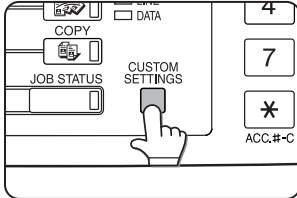

The custom setting menu screen will appear.

**5** Touch the [OK] key to complete the setting.

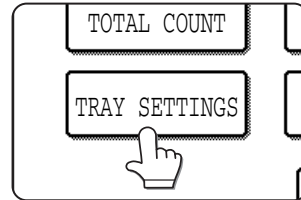

1

**2** Press the [TRAY SETTINGS] key.

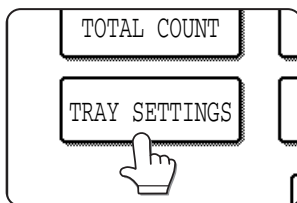

The paper tray selection screen will appear.

**3** Select the paper tray for which setting is to be made.

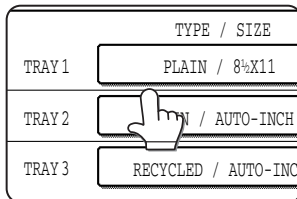

If the desired tray is not displayed, touch the [↑] or [↓] key to switch the screen.

**4** Select the paper type and the paper size.

• If TRAY 1 has been selected in step 3:

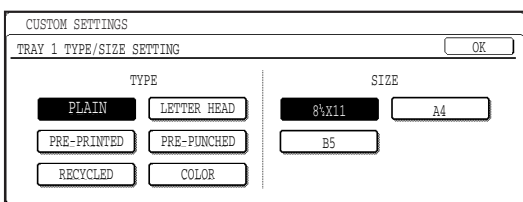

The paper type and paper size with highlighted display are selected. If the desired paper type and paper size are not selected, select the desired type and size by touching the relevant keys. Special papers such as transparency film and labels can be set for tray 2 and the bypass tray. Envelopes can be set only for tray 2.

# LOADING PAPER

## Loading paper in the multi purpose drawer

The method of loading paper for the multi purpose drawer is the same for paper tray 1 in the main unit. Load paper referring to steps 1 to 5 on page xxxx.

The following items, however, are different from paper tray 1.

- Ordinary paper of standard sizes from 11" x 17" to 5-1/2" x 8-1/2"R (A3 to A5R) can be set.
- Also certain types of special paper can be set.

For special papers that can be set, see "Paper available in the bypass tray/multi purpose drawer" on page xxxx. When setting envelopes or postcards in the multi purpose drawer, read thoroughly the description of "Setting envelopes or postcards" below.

### ■ How to change the paper size

If the paper size or paper type is changed when paper is set in the tray, the tray settings in the custom settings must be changed. Be sure to change the setting referring to "Method of setting paper size and type" on page xxxx.

### ■ Setting envelopes or postcards

When setting envelopes or postcards in the multi purpose drawer, set them in the orientation shown below.

#### Notes common to setting of envelopes and postcards

- Do not print onto two sides. A paper misfeed or improper printing may occur.
- Be sure to write addresses after printing. Do not use envelopes or postcards on which printing has been performed with a thermal transfer printer or an ink jet printer. Paper on which printing has been performed with a thermal transfer printer with a ribbon cassette, particularly, may cause printed characters to come off or may cause smudges on printouts.

#### [Example of setting postcards]

Be sure to set the postcards face down and the upper part located in the left.

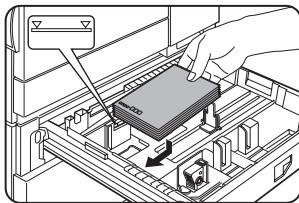

#### Note on setting postcards

- Smooth out curled postcards before printing. Crumpling, misfeeds or improper printing may occur.

#### [Example of setting envelopes]

For envelopes, only the address side can be printed on. Be sure to set envelopes with the address side down and the upper part located in the left.

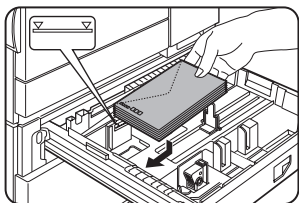

#### Notes on setting of envelopes

- For envelope sizes that can be used, see "Paper available in the bypass tray/multi purpose drawer" on page xxxx.
- Do not use envelopes that have metal clasps, plastic snappers, string closures, windows, linings, self-adhesive patches or synthetic materials. A paper misfeed, improper fixing or failure may occur.

## Specifications

Name	Multi purpose drawer
Paper size	Max. 11" x 17" (A3), min. 5-1/2" x 8-1/2"R (A5R)
Paper capacity	500 sheets (20 lbs. (80 g/m <sup>2</sup> )) of paper, 100 envelopes, 100 postcards, 100 sheets of transparency film
Dimensions	23-1/32" (W) x 20-7/8" (D) x 4-1/2" (H) (585 mm (W) x 530 mm (D) x 114 mm (H))
Weight	Approximately xxxx kg

Specifications are subject to change for improvement without notice.



## Loading paper in the stand/3 x 500 sheet paper drawer

### Upper paper tray:

The upper paper tray is equivalent to the multi purpose drawer. The method of loading paper and the paper that can be used are the same as for the multi purpose drawer. Read the description of the multi purpose drawer (see page xxxx).

### Middle and lower paper trays:

Up to 500 sheets of 11" x 17", 8-1/2" x 14", 8-1/2" x 11", 8-1/2" x 11"R, 7-1/4" x 10-1/2", A3, B4, A4, A4R, B5, and B5R paper (20 lbs. (80 g/m<sup>2</sup>)) can be loaded in these trays. The method of loading paper is the same as for paper tray 1 in the main unit. See the description (page xxxx).

1

#### NOTE

If the paper size or paper type is changed when paper is set in a tray of the stand/3 x 500 sheet paper drawer, the tray settings in the custom settings must be changed. Be sure to change the setting referring to "Method of setting paper size and type" on page xxxx.

## Specifications

Name	Stand/3 x 500 sheet paper drawer
Paper size	Upper tray: Max. 11" x 17" (A3), min. 5-1/2" x 8-1/2"R (A5R), Middle/lower trays: Max. 11" x 17" (A3), min. 7-1/4" x 10-1/2"R (B5R)
Paper weight	15 lbs. - 28 lbs. (56 - 105 g/m <sup>2</sup> )
Paper capacity (ordinary paper)	500 sheets (20 lbs. (80 g/m <sup>2</sup> )) each
Dimensions	23-1/32" (W) x 20-7/8" (D) x 15-29/32" (H) (585 mm (W) x 530 mm (D) x 404 mm (H))
Weight	Approximately xxxx kg

# LOADING PAPER

## Loading paper in the stand/MPD & 2000 sheet paper drawer

### Upper paper tray:

The upper paper tray is equivalent to the multi purpose drawer. The method of loading paper and the paper that can be used are the same as for the multi purpose drawer. Read the description of the multi purpose drawer (see page xxxx).

### Lower paper tray:

The lower paper tray is a large capacity tray that holds 2,000 sheets of 8-1/2" x 11" or A4 paper (20 lbs. (80 g/m<sup>2</sup>)). Use the following procedure to load paper in the large capacity tray.

#### NOTE

If the paper size or paper type is changed when paper is set in the upper paper tray of the stand/MPD & 2000 sheet paper drawer, the tray settings in the custom settings must be changed. (If the paper type is changed in the large capacity tray, the tray settings must also be changed.) Be sure to change the setting referring to "Method of setting paper size and type" on page xxxx.

### 1 Pull out the large capacity tray.

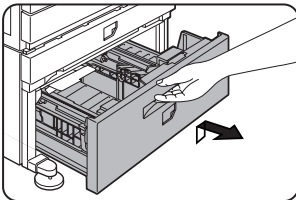

Gently pull the tray out until it stops.

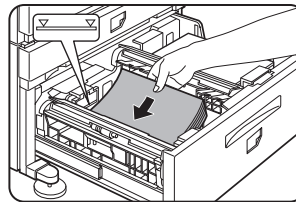

• Load paper onto the left paper feed table.

### 2 Press down the right and left paper feed tables until they stop.

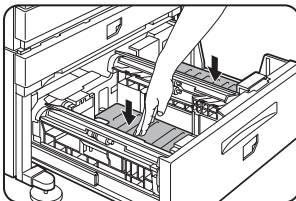

### 4 Gently push the large capacity paper tray into the printer.

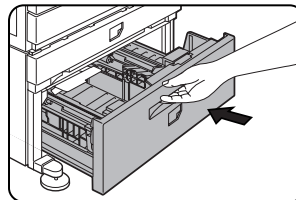

Push the tray firmly all the way into the printer.

### 3 Load paper onto the right and left paper feed tables.

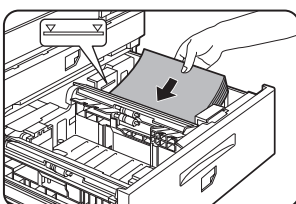

• Load paper onto the right paper feed table.

### 5 Set the paper type.

If you change the paper type in the tray, be sure to set the paper type referring to "Method of setting paper size and type" (page xx).

### 6 Loading of paper in the stand/MPD & 2000 sheet paper drawer is now complete.

## Specifications

Name	Stand/MPD & 2000 sheet paper drawer
Paper sizes	Upper tray: Max. 11" x 17" (A3), Min. 5-1/2" x 8-1/2" (A5R), Lower tray: 8-1/2" x 11" (A4)
Paper weight	15 lbs. - 28 lbs. (56 - 105 g/m <sup>2</sup> )
Paper capacity (ordinary paper)	Upper tray: 500 sheets (20 lbs. (80 g/m <sup>2</sup> )), Lower tray: 2,000 sheets (20 lbs. (80 g/m <sup>2</sup> ))
Dimensions	23-1/32" (W) x 20-7/8" (D) x 15-29/32" (H) (585 mm (W) x 530 mm (D) x 404 mm (H))
Weight	Approximately xxxx kg

# ADDING TONER

When toner runs out, a message indicating need to replace the toner cartridge will appear. Also depending on the model, a message indicating need to replace the developer cartridge may appear.

For the procedure of replacement of these cartridges, see the separate manual "Supply Replacement Method."

1

## STORAGE OF SUPPLIES

Standard supplies for this product that are to be replaced by the user are paper, toner cartridge, and staple cartridge for the finisher.

**SHARP**

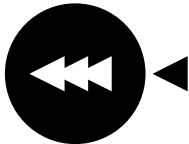

For best copying results, be sure to use only Sharp Genuine Supplies which are designed, engineered, and tested to maximize the life and performance of Sharp copiers. Look for the Genuine Supplies label on the toner package.

**GENUINE SUPPLIES**

### ■ Proper storage

- 1 Store the supplies in a location that is:
  - clean and dry,
  - at a stable temperature,
  - not exposed to direct sunlight.
- 2 Store paper in the wrapper and lying flat.
  - Paper stored in packages standing up or out of the wrapper may curl or become damp, resulting in paper misfeeds.





# CHAPTER 2

---

## PRINTING FROM A COMPUTER

---

This chapter describes how to install and how to use the printer drivers and printer utilities on a computer. This chapter also describes the job retention function that allows print start operation from the operation panel of the printer.

	Page
CONNECTING TO A COMPUTER .....	2-2
SOFTWARE FOR WINDOWS .....	2-2
INSTALLING PRINTER DRIVERS AND PRINTER UTILITIES .....	2-3
REMOVING PRINTER DRIVERS AND PRINTER UTILITIES .....	2-3
INSTALLING PRINTER DRIVERS USING THE PLUG & PLAY FEATURE OR ADD PRINTER WIZARD .....	2-4
● Before installation .....	2-4
SETTING THE PRINTER DRIVER .....	2-5
● Setting print conditions under Windows (selecting and setting print conditions) .....	2-5
REMOTE OPERATION THROUGH NETWORK .....	2-6
● Environment required for accessing Web pages .....	2-6
● Accessing Web pages and displaying help .....	2-6
● Items and outline of menu frame of Web pages .....	2-7
JOB RETENTION FUNCTION WHICH ALLOWS PRINT START OPERATION FROM THE OPERATION PANEL .....	2-9
● Print functions selectable in the “JOB CONTROL” dialog box and their operation .....	2-9
● Printing method of hold job list .....	2-10
● Printer account control .....	2-12

# CONNECTING TO A COMPUTER

## 1. Using this machine as a local printer

When using this machine as a local printer, connect your computer to the parallel interface connector of this product as shown in the illustration.

For a connection cable, prepare a Centronics cable on the market that conforms to the following specifications.

The parallel interface of this machine conforms to IEEE-STD-1284-1993.

Connector type on this printer: 36-pin DDK 57LE-40360-730B (D29) female connector or equivalent connector

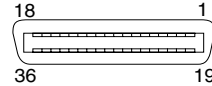

For the specifications of the parallel interface connector on the computer, see the computer manual.

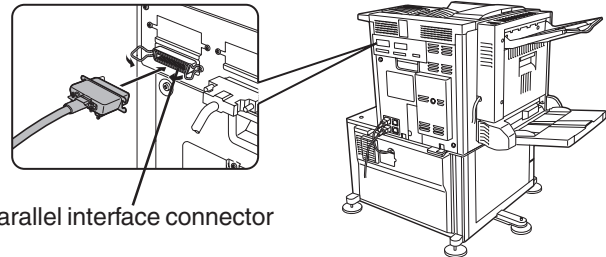

Parallel interface connector

## 2. Using this machine as a network printer

For using this machine as a network printer, a print server card is needed.

See the operation manual supplied with the print server card.

# SOFTWARE FOR WINDOWS

When using this product in Windows environment, you must install a printer driver in your computer system. Use the supplied CD-ROM for installation. For using this product, either connection through a parallel interface connector (see page xxxx) between the computer and this machine (local printer) or network connection that uses a print server card (network interface card) as a peripheral unit can be performed.

The print server card may be installed as a standard component or optional depending on the model. Contact your SHARP dealer.

The following software for Windows is contained in the CD-ROM.

- Printer drivers
- Printer utilities
- Installer

These are software for installing the printer drivers and printer utilities. If you use the Plug and Play feature or the Add Printer wizard to install the driver without using the installer, specify directly the folder name referring to the directory information of the PRINTER UTILITIES CD-ROM on page xxxx.

### ■ Printer drivers

- PCL printer drivers (PCL5e and PCL6)
- Optional PostScript printer driver (compatible to PostScript level 3) and SHARP AR-xxxx PPD file (PostScript Printer Description file)

### ■ Printer utilities

- Printer Administration Utility
- Printer Status Monitor
- Display Font

### 1. Printer drivers

A printer driver is software designed to convert print data from any application into data understandable by the printer so that the printer can print out the data. This product, therefore, can be used as a printer only after a printer driver has been installed. If a printer driver is installed once, it is built into your computer system. You need not install the driver each time you execute printing.

### 2. Printer utilities

Printer Administration Utility that allows setting and monitoring of printers on a computer and Printer Status Monitor that allows monitoring of printer status and display and notification on a computer are provided for network environment. (only in the Windows environment)

For use of Printer Administration Utility and Printer Status Monitor, see the help file. The details of use are written in each help file.

※ Printer Administration Utility is software for system administrators.

# INSTALLING PRINTER DRIVERS AND PRINTER UTILITIES

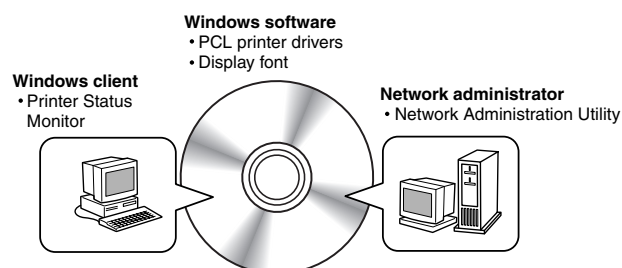

The following software can be installed from the installer supplied in the CD-ROM :

- PCL printer drivers (PCL5e and PCL6)
- Display font
- Printer Administration Utility
- Printer Status Monitor

## NOTE

If you wish to install a printer driver or a printer utility from a floppy disk, see the README file of the CD-ROM. The method of copying printer drivers and printer utilities from the CD-ROM to a floppy disk and the method of use are described.

2

Execute installation from the CD-ROM using the following procedure.

- 1 Start Windows.**
- 2 Insert the supplied CD-ROM into a CD-ROM drive of your computer.**

If your computer is configured for auto start on the CD-ROM, the software license agreement described in step 5 will appear. (Steps 3 and 4 are not needed.)
- 3 On the [Start] menu, click "Run."**
- 4 Enter the CD-ROM drive and setup command. Then click the [OK] button.**

Example: If the CD-ROM drive is designated as drive R, enter "R:\SETUP.EXE".
- 5 Read the software license agreement and click the [Next] button if you accept the agreement.**
- 6 The printer drivers and printer utilities that can be installed from the CD-ROM will be listed. Select the check boxes of the desired drivers and utilities and click the [Next] button.**

If you click the [README display] button, the information of the specified software will be displayed. When installing the Printer Administration Utility and the Printer Status Monitor, read the README display and check to see if the computer system requirements are satisfied.

## NOTE

The Printer Administration Utility and the Printer Status Monitor can be used only if this product is used as a network printer.

- 7 Click the [Start] button.**

The installation screen of the file selected with a check box will appear. Follow the instructions on your screen to install the selected printer drivers and utilities.
- 8 When installation is complete, the message "Setup has finished installing your selected package(s)." will appear. Click the [Close] button.**

## NOTE

Restart of your computer may be needed depending on the system. Click [Yes] to restart the computer.

# UNINSTALLING PRINTER UTILITIES

When uninstalling a printer driver that has been installed, right-click the printer to be deleted from "Printers" of "Control Panel" and select [Delete]. When uninstalling the Printer Administration Utility or the Printer Status Monitor, use "Add/Remove Programs" of "Control Panel". Use the Windows standard operation for each case.

2-3

# INSTALLING PRINTER DRIVERS USING THE PLUG & PLAY FEATURE OR ADD PRINTER WIZARD

## Before installation

Before installing the printer drivers, check the following items.

- Ensure that your computer system meets the following requirements.

### Computer type:

IBM PC/AT or compatible computer  
Hardware requirements of the operating system must be satisfied.

### Operating system:

Windows 95  
Windows 98  
Windows 2000  
Windows NT 4.0  
Windows Me

When using the Plug and Play feature in the Windows 95/98 environment or using the Add Printer wizard to install printer drivers, enter the directory name indicated below as a source directory.

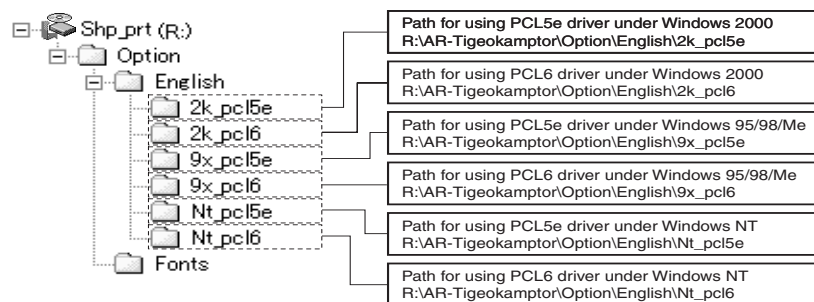

## ■ Example of installation of a printer driver using the Add Printer wizard under Windows 98

The installation method of a printer driver under Windows 98 is shown below.

The installation example is described assuming that the printer is connected as a local printer (see “Using this machine as a local printer” on page 2-2) and that the CD-ROM drive is designated as drive R. The procedure may differ depending on the system environment.

- 1 Start Windows 98.**
- 2 Insert the supplied CD-ROM into the CD-ROM drive.**  
If your computer is configured for auto start on the CD-ROM, the software license agreement will appear. Click [Cancel] to close the screen.
- 3 On the [Start] menu, select [Settings] and then [Printers].**  
The Printer window will appear.
- 4 Double-click the [Add Printer] icon.**
- 5 Click the [Next] button.**
- 6 Check the [Local Printer] radio button and then click the [Next] button.**
- 7 Click the [Have Disk] button.**  
The “Install From Disk” dialog box will appear.  
Enter the file path as follows:  
R:\Option\English\9x\_pcl5e or  
R:\Option\English\9x\_pcl6
- 8 Click the [OK] button.**
- 9 Select the printer model to be used and click the [Next] button.**  
Follow the instructions displayed by the Add Printer wizard.

## ■ Installing display fonts

The display fonts are the fonts displayed on your computer screen. The CD-ROM supplied with this product contains the display fonts that correspond to the resident fonts (page xxx) of this product. These display fonts can be installed to your computer (Windows 95/98/Me/NT/2000) from the installer. Installation of the display fonts can be specified in step 6 of “INSTALLING PRINTER DRIVERS AND PRINTER UTILITIES” on page 2-3.

To install the display fonts by Windows basic operation without using the installer, specify the following path.

R:\Option\Fonts

The CD-ROM drive is designated as drive R as an example.



# SETTING THE PRINTER DRIVER

This section describes the method of changing the printer driver settings for using this product properly from your computer.

If no printer driver has been installed, use the supplied CD-ROM to install it referring to "INSTALLING PRINTER DRIVERS AND PRINTER UTILITIES" on page 2-3.

## Setting print conditions under Windows (selecting and setting print conditions)

Change the settings using the properties of the printer.

### ■ Windows 95 / 98 / Me

Screens under Windows 98 are used in the description below.

#### 1 On the [Start] menu, select [Settings] and then [Printers].

The Printer window will appear.

#### 2 Right-click the installed printer driver and select [Properties].

This example is the screen displayed by selecting AR-P350PCL5e.

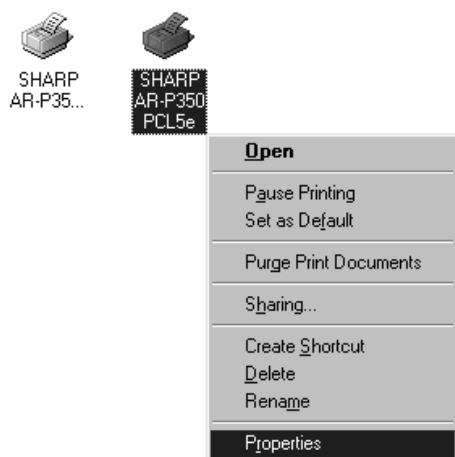

#### 3 Set each item.



For setting items, see the printer driver help.

#### 4 Click the [OK] button.

### ■ Windows NT 4.0 / 2000

Screens under Windows NT 4.0 are used in the description below.

#### 1 On the [Start] menu, select [Settings] and then [Printers].

The Printer window will appear.

#### 2 Right-click the installed printer driver and select [Document Defaults].

This example is the screen displayed by selecting AR-P350PCL5e.

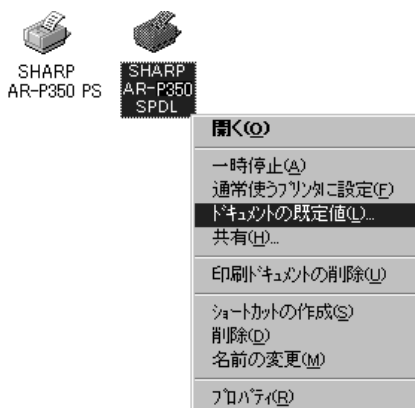

#### 3 Set each item.



For setting items, see the printer driver help.

#### 4 Click the [OK] button.

### NOTE

For the setting concerning peripheral units such as the duplex module, finisher, and stand/3 x 500 sheet paper drawer, right-click the installed printer, select [Properties], and then open the [Configuration] tab. If you use this product as a network printer and you have installed the Printer Status Monitor, the configuration of peripheral units will be automatically set by clicking "Auto Configuration". If you click the [Get Tray Status] button in the Detail dialog box of the Paper tab, the current tray information (paper size, paper type, and quantity of paper remaining) will be displayed.

# REMOTE OPERATION THROUGH NETWORK

If you access the Web pages of this product from your computer using a WWW browser such as Netscape Navigator and Internet Explorer, various settings can be adjusted through the network.

## Environment required for accessing Web pages

The following products and computer system requirements are needed for accessing the Web pages of this product.

- Optional print server card (network interface card)
- Recommended Web browser  
Microsoft Internet Explorer 4.0 or later or equivalent  
Netscape Navigator 4.0 or later or equivalent

### NOTE

The following characters cannot be input in the Web pages when setting the Web pages in the Web server located in this product. Input characters are case-sensitive.

- Characters that cannot be input: < > & " #
- Examples of improper input: <abc> <abc "abc" "abc abc &lt; &gt; &#16l

## Accessing Web pages and displaying help

Use the following procedure to access the Web pages. If the help button under the menu frame is clicked, the help screen for description of various function settings that can be operated remotely from the Web pages for this product through the network will appear. For the setting of each function, see this detailed description.

**1** Open the Web browser on your computer.

**2** Input the IP Address previously specified for this product to the ADDRESS field of the browser.



Input the IP address previously specified in this product. (See page xx.)



When the connection is completed, the Web page information of this product will be displayed.

**3** Click the [Help] button under the menu frame.



For details of each function setting, see the help under the menu frame. The method of setting is described in detail.

**4** Close the help.



Click the  button. The display will return to the Web page information of this product.

## Items and outline of menu frame of Web pages

### Destination Management

The basic screen on which you can register, change, and delete the destination for image data scanned by the network scanner and the recipient information for facsimile and Internet facsimile (destination address, facsimile number, etc.) is described below.

#### ■ Setting of E-mail Destination Control

Sets the destination information for E-mail delivery scan of network scanner.

Destination E-mail addresses and file types as well as information for destination control (destination name, index, name for front panel display, etc.) are set.

#### NOTE

When performing E-mail destination setting, be sure to read the description on page xxxx in advance.

2

#### ■ Setting of FTP Destination Control

Sets the storage location information for file server storage scan of network scanner. File server information (such as host name) and file types as well as information for destination control (destination name, index, name for front panel display, etc.) are set.

#### ■ Setting of Desktop Destination Control

Sets the destination information for desktop delivery scan of network scanner. Destination computer information (such as host name) in which the network scanner tool/Sharpdesk has been installed and file types as well as the information for destination control (destination name, index, name for front panel display, etc.) are set.

#### ■ Setting of Fax Destination Control

Sets the fax destination. Fax numbers of recipients and communication mode as well as information for destination control (destination name, index, name for front panel display, etc.) are set.

#### ■ Setting of i-Fax transmission Destination Control

Sets the Internet fax destination information. E-mail addresses of destination and file types as well as information for destination control (destination name, index, name for front panel display, etc.) are set.

#### ■ Setting of Group Destination Control

Sets destination groups for transmitting data at a time by collecting destinations that have been set as E-mail destination, fax destination and i-fax destination.

#### ■ Delete Destination

Screen for checking to see if deletion may be executed after selecting a destination to be deleted from the destination list on the destination management screen and clicking the Delete button.

### Fax Memory Box Management

Basic screen for setting memory area (memory box) for fax images in this product. The memory box has the following three functions.

- Polled memory box control
- Confidential memory box control
- Memory box relay broadcast control

#### ■ Polled Memory Box Control

Original data that has been stored in this machine can be transmitted to another facsimile when the facsimile requests transmission.

#### ■ Confidential receiving

Data to be printed is sent to this machine and printing can be operated from the operation panel of this machine.

#### ■ Relay broadcasting

Memory box information for transmitting received data can be set.

### Set up

Setting of restriction on access to Web pages and basic settings for using the network scanner and the status/alert E-mail function are described below.

#### ■ Network Card Setup

A link to the network card Web page for setting the print server card (network interface card) is provided.

#### ■ Password Setup

A password for accessing the Web pages is set. Two types of password (user level and administrator level) are set.

#### ■ Network Scanning Setup

Basic setting screen for network scanner. E-mail subject for scanner delivery, file name, etc. are set. To use the network scanner, you must set up E-mail & DNS Setup. This screen displays the settings of E-mail & DNS Setup and provides a link to the screen.

#### ■ Status & Alert E-mail Setup

Basic setting screen for the status/alert E-mail system. Machine name, machine code, and machine installation location are set. To use the network scanner, you must set up E-mail & DNS Setup. This screen displays the settings of E-mail & DNS Setup and provides a link to the screen.

#### ■ E-mail & DNS Setup

Basic setting screen for transmitting E-mail. E-mail server, system administrator address, DNS server, etc. are set.

#### ■ Sender of E-mail Setup

Sender of E-mail transmission of the network scanner is set. This item will be set as the "From" item of E-mail header. Up to eight senders can be registered and a sender can be selected among them from the operation panel.

#### ■ Custom Directory Setup

Group index names in the list display on the operation panel are set.

#### ■ Status Message Parameters Setup

Used when the current counter information of this machine such as print count, copy count, and total output is delivered in accordance with the specified schedule.

#### ■ Alerts Message Parameters Setup

Alert information is transmitted immediately to the specified addresses when a problem of supplies such as paper and toner, failure, and an error such as a paper misfeed occur in this machine.

# JOB RETENTION FUNCTION WHICH ALLOWS PRINT START OPERATION FROM THE OPERATION PANEL

This section describes the operation procedure required for starting printing from the operation panel of the printer and the outline of the function concerning the print functions that can be selected in the "JOB CONTROL" dialog box using the printer drivers of this product. For selection of the print function, select "Properties" on the printer driver screen, open the "Main" tab, and click "Job control." The job retention function can be used only if this printer is equipped with a hard disk drive as a peripheral unit.

## Print functions selectable in the "JOB CONTROL" dialog box and their operation

### 1 Normal print

(For "Normal print", print start operation from the operation panel of the printer is not needed.)

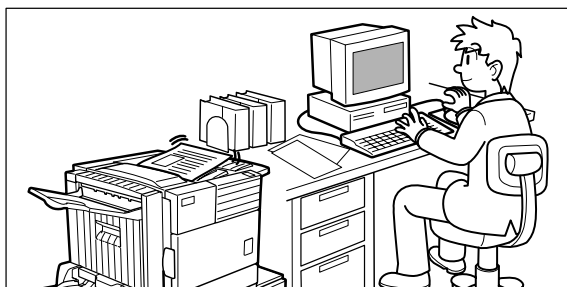

The print setting in this mode is the basic print operation. If no problem such as a paper misfeed and empty toner occurs in the printer, the print start operation is completed on the computer and printing will be executed on the printer.

### 2 Hold after print



In this mode, print data will be held in the hold job list even after printing is complete. Printing can be executed again from the operation panel of the printer if needed. Also the data can be deleted from the operation panel if it is not necessary.

### 3 Hold before print

This print mode can reduce the possibility of missing printout. If print start operation is made in this mode from the computer, print data will not be output immediately and will be stored in the printer as a hold job.

Print start operation can be made on the operation panel of the printer as needed. Also you can delete the data without executing printing. (See step 8 on page xx.)

### 4 Proof print



This mode can prevent a high-volume misprint when a lot of sets must be printed. If print start operation is executed in this mode, only one set will be printed and the remaining sets will be held as a hold job. After checking the finished printout including print position on paper and stapling position, you can start printing of the remaining sets from the operation panel of the printer. Also you can delete the data without executing printing. (See step 8 on page xx.)

### 5 Password

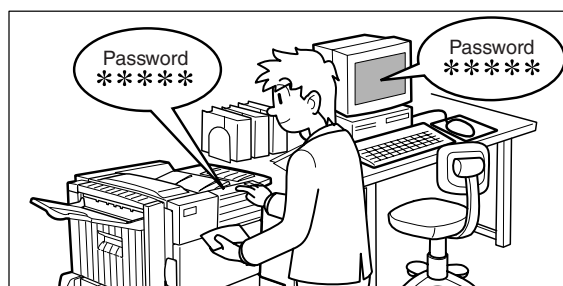

If a password is set in the printer driver setting, password entry is needed to start printing of a hold job. This mode can increase the security of hold jobs.

- **Password in the Hold After Print mode:** Password entry on the operation panel of the printer is needed for additional printing.
- **Password in the Hold Before Print mode:** Password entry on the operation panel of the printer is needed for starting printing.
- **Password in the Proof Print mode:** Password entry on the operation panel of the printer is needed for printing remaining sets after printing one set.

2

**Printing method of hold job list**

If “Print after hold”, “Print before hold” or “Proof print” operation is performed on the computer, print data will be held as a hold job. (Up to 100 jobs can be held.)

If the number of jobs exceeds 100, the job is processed as follows.

● **If Hold After Print is executed:**

Printing will be executed but the job will not be held. (A notice page will be printed. See page xx.)

● **If Hold Before Print is executed:**

Printing will not be executed and the job will not be held. (A notice page will be printed. See page xx.)

● **If Proof Print is executed:**

Printing of one set will be executed but the job will not be held. (A notice page will be printed. See page xx.)

**When using the operation panel on the main unit:**

- For operation from the operation panel with touch panel, see the next page.

**1 Press the [MENU] key.**

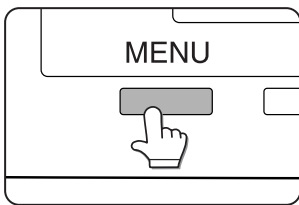

“PRINT HOLD” will appear in the message display.

**2 Press the [OK] key.**

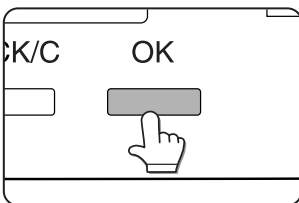

When the [OK] key is pressed, a user name and a file name of print data stored in the printer as a hold job will appear.

**3 Select the desired data.**

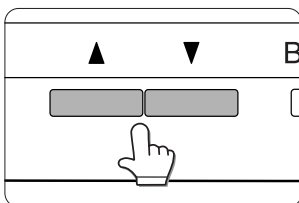

Press the ▲ or ▼ key on the operation panel repeatedly until the desired print data is displayed.

**4 Press the [OK] key.**

**5 Enter the fifth digit of the password and press the [OK] key.**

(needed only if a password has been set)

Be sure to enter the number that has been entered on the computer. If no password has been set, operation of steps 5 and 6 is not needed. (Proceed to step 7.)

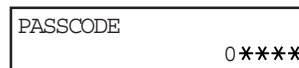

If you press the [OK] key to register the fifth digit after entering it using the ▲ or ▼ key on the operation panel, “0” will appear at the fourth digit. If you press the [BACK/C] key, you can correct the entered number.

**6 Use the same procedure as step 5 to enter the password from the fourth digit to the first digit and then press the [OK] key.**

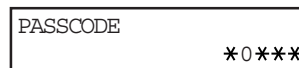

Use the same procedure as above (fifth digit) to enter the fourth digit to the first digit.

**7 Select execution of printing, cancellation of printing or data retention after printing, and then press the [OK] key.**

Deletion or retention of data after printing can be selected. Alternatively deletion of data without printing can be selected. Press the ▲ or ▼ key until the desired choice appears



- Data will be deleted after printing.

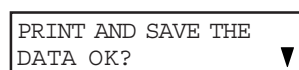

- Data will be held after printing.



- Data will be deleted. If this item is selected, the operation will be complete. Steps 8 and 9 are not needed.

**8 Ensure that the desired number of copies is set.**



The number of copies can be changed by using the ▲ or ▼ key on the operation panel.

**9 Press the [OK] key.**

- Printing will start. If printing of another job is being executed, however, your job will be registered as a print job. Printing of the job will start after preceding jobs are completed.

**10 Operation is now complete.**

To continue operation, repeat steps 1 to 9.

When using the operation panel with touch panel:

**1 Press the [PRINT] key to display the printer basic screen.**

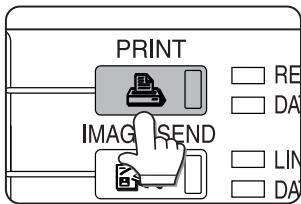

**4 Select execution of printing, cancellation of printing or data retention after printing.**

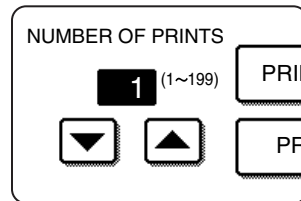

Deletion or retention of data after printing can be selected. Alternatively deletion of data without printing can be selected. Touch the desired key.

**2 Select the desired data.**

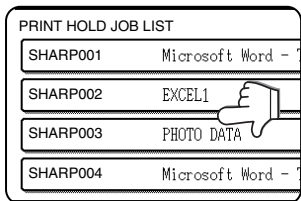

To switch the screen, touch the ▲ or ▼ key.

The number of copies has been set. The number of copies can be changed by using the ▲ or ▼ key.

- Printing will start. If printing of another job is being executed, however, your job will be registered as a print job. Printing of the job will start after preceding jobs are completed.

**3 Enter the password.**  
(needed only if a password has been set)

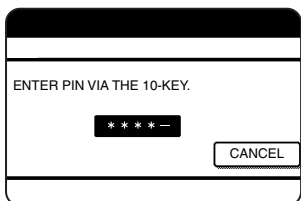

Be sure to enter the password that has been entered on the computer. If no password has been set, operation of step 4 is not needed.

Each time a number is entered, “-” will change to “\*”.

**5 Operation is now complete.**

### Printer account control

If the key operator program "Auditing mode" is set, the number of printed pages can be accumulated for each account. The accounts for auditing are the accounts that have been set for counting the number of pages for the printer with a key operator program. For registration of account numbers, see the key operator programs (page xxxx).

When executing print operation from the computer, you must enter an account number on the setting screen of the printer driver. The account number entry screen will be displayed by clicking "Job control" in the "Main" tab of the printer driver.

When an invalid account number is entered or no account number is entered, if key operator program "Cancel jobs of invalid accounts" has been set, printing will not be performed. To perform printing in any case, disable program "Cancel jobs of invalid accounts". In this case, the number of printed pages will be accumulated to "OTHERS".

The job control screen will always appear when print operation is executed from the printer driver if the "Auto Job Control review" check box in the "Main" tab of the printer driver is set.





# CHAPTER 3

---

## PRINTER BASIC SETTINGS

---

This chapter describes the following items.

1. Printer configuration settings
2. Custom settings based on the customer's operating conditions.

	Page
MAKING CONFIGURATION SETTING .....	3-2
● Operation procedure common to all printer configuration settings (items that can be set from the operation panel) .....	3-2
● Main program settings .....	3-4
● PCL settings .....	3-4
● PostScript settings .....	3-4
CUSTOM SETTINGS .....	3-5
● Operation procedure common to all custom settings (items that can be set from the operation panel) .....	3-5
● Setting items .....	3-7

# MAKING CONFIGURATION SETTING

The printer configuration setting allows basic printer settings to be made. The items set with the printer configuration settings are shown below.

- Main program settings ..... Basic settings used in printing (See page xxxx.)
- PCL settings ..... Sets a PCL symbol set. (See page xxxx.)
- PostScript settings\*1 ..... Sets whether a PostScript error page is printed or not when a PostScript error has occurred. (See page xxxx.)

\*1 An optional PS3 expansion kit is needed.

## Operation procedure common to all printer configuration settings (items that can be set from the operation panel)

When using the operation panel on the main unit:

- 1** Press the [MENU] key to display the configuration setting menu screen.

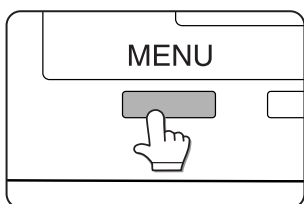

Press the [MENU] key repeatedly until "CONDITION SETTING" appears. Any print jobs held in the printer and any job currently transmitted to the printer will be printed in the former print conditions.

- 2** Press the [OK] key.

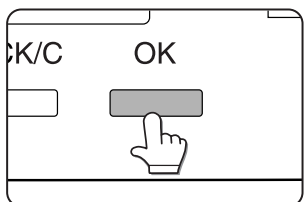

- 3** Press the ▲ or ▼ key to display the desired setting item.

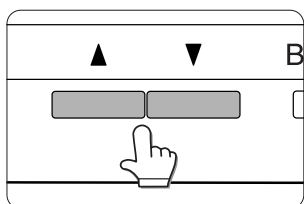

- 4** Press the [OK] key.

- 5** Press the ▲ or ▼ key to display the desired setting.

For the details of each setting item, see the description on and after page xxxx.

- 6** Press the [OK] key.

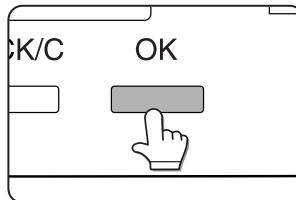

● will be displayed to the right of the selected item and setting will be registered. To set another item, press the [BACK/C] key to return to step 3 and repeat the procedure to step 6.

- 7** When setting is complete, press the [MENU] key to return to the basic screen.

### NOTE

If the [BACK/C] key is pressed after each setting is complete, the display that has called the setting will appear again. If selection of a number is mistaken during setting operation, press the [BACK/C] key to correct the selected number.

When using the operation panel with touch panel:

- 1 Touch the [CONDITION SETTINGS] key on the printer screen to display the configuration setting menu screen.**

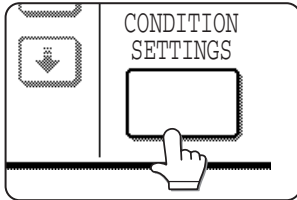

Any print jobs held in the printer and any job currently transmitted to the printer will be printed in the former print conditions.

- 2 Touch the key of the desired item to display its setting screen.**

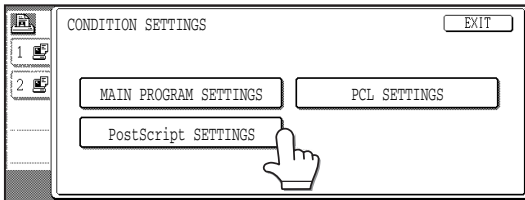

For details of each setting item, see the description on and after the next page.

Depending on the setting item, additional item setting keys may be displayed or page switching keys may be displayed.

If a check box is displayed for an item, the item can be set by touching the key to display a check mark (☑) in the box.

- 3 Touch the desired setting on the setting screen of the desired item and touch the [OK] key.**

To set another item, repeat steps 2 and 3.

- 4 To finish the setting operation, touch the [EXIT] key.**

# MAKING CONFIGURATION SETTING

## Main program settings

The main program settings allow detailed print conditions to be set for printing without any printer driver (for example, printing from MS-DOS and printing from a computer without any printer driver installed). The setting items are shown below.

### NOTE

When some items can be set both in the printer driver and on the operation panel, the values set in the printer driver override those set on the operation panel. For items that can be set in the printer driver, perform setting in the printer driver.

#### ■ Smoothing

SMOOTHING reduces jaggies seen at roundish curved portions of characters and images to be printed and improves pseudo resolution.

Default setting: On

Smoothing on or off can be selected.

#### ■ Copies

COPIES is set when the number of copies to be printed is set.

Default setting: 1

The number of copies can be set from 1 to 999.

#### ■ Orientation

ORIENTATION allows portrait orientation or landscape orientation to be selected for printing.

Default setting: PORTRAIT

PORTRAIT or LANDSCAPE can be set.

#### ■ Standard paper size

The paper size to be used for printing in the normal conditions is set.

Printing will be performed onto the specified size paper unless otherwise specified.

Default setting: 8-1/2 x 11 or A4

11 x 17, 8-1/2 x 14, 8-1/2 x 13, 8-1/2 x 11, 7-1/4 x 10-1/2, 5-1/2 x 8-1/2, A3, B4, A4, B5 or A5 can be set.

(If the operation panel on the main unit is used, the sizes are displayed as follows in the display: LEDGER, LEGAL, FOOLSCAP, LETTER, EXECUTIVE, INVOICE, A3, B4, A4, B5, and A5.)

#### ■ Standard paper type

The paper type to be used for printing in the normal conditions is set.

Printing will be performed onto the specified type paper unless otherwise specified.

Default setting: PLAIN

Plain paper, pre-printed paper, recycled paper, letter head paper, pre-punched paper or color paper can be set.

#### ■ Standard output tray

The output tray to be used for printing in the normal conditions is set. Printed sheets will be output to the specified tray unless otherwise specified by application software.

Default setting: Depends on installation of peripheral unit.

The trays that can be selected depend on installation of peripheral units. This item itself may not be selected.

## PCL settings

PCL SETTINGS is used to assign a part of character codes to characters of a country in the PCL symbol set. (Used when different symbols are used depending on the country.)

Default setting: "1" (Roman-8)

For setting items of the symbol set, see page xxxx.

The list of the numbers to be set and their corresponding symbol sets can be printed using "PCL symbol set list printing" (see page xxxx).

When using the operation panel on the main unit, select the desired symbol set item and register it. When using the operation panel with touch panel, select the number that corresponds to the desired symbol set and register it.

## PostScript settings

This setting specifies whether the cause of an error is printed or not when a PostScript error has occurred.

Default setting: Not print

Print or not print can be selected concerning the cause of a PS (PostScript) error.

## 3-4

# CUSTOM SETTINGS

Custom settings are used for various settings based on the customer operating conditions. The items that can be set with the custom settings are shown below.

- Total count ..... The number of printed pages and the like are displayed. (See page xxxx.)
- Display contrast\*1 ..... The display contrast of the operation panel is adjusted. (See page xxxx.)
- List print ..... Used to print a list of settings that have been made or a font list. (See page xxxx.)
- Clock ..... The date and time of the built-in clock of the printer are set.
- Tray settings\*4 ..... The paper type and paper size for each tray are set.
- Auto tray switching ..... Used to switch automatically the paper tray of the same paper size when paper runs out in continuous printing.

For the items below, detailed setting procedure is described on the respective pages of the functions.

- Address control\*3 ..... Used to register destination E-mail addresses, fax numbers, and Internet fax addresses. Also group entry, memory box entry, custom index entry, and scanner sender entry can be set.
- Receive mode\*2 ..... The fax receive mode (automatic or manual) is set.
- Fax data forward\*2 ..... Received fax data in memory can be forwarded to another destination.

- Key operator programs ..... RSetting programs are provided for key operators (administrators of this machine). If this product is equipped with a scanner module as a peripheral unit, this key will appear in the CUSTOM SETTINGS menu screen. For settings, see Key Operator's Guide. (See page xxxx.)

※1 Can be set if this product is equipped with a scanner module as a peripheral unit.

※2 Can be set if this product is equipped with a scanner module as a peripheral unit and the facsimile feature can be used.

※3 Can be set if this product is equipped with a scanner module as a peripheral unit and the facsimile feature or the network scanner feature can be used.

※4 Can be set with this item if this product is not equipped with a scanner module as a peripheral unit.

## Operation procedure common to all custom settings (items that can be set from the operation panel)

When using the operation panel on the main unit:

**1** Press the [MENU] key to display the custom settings menu screen.

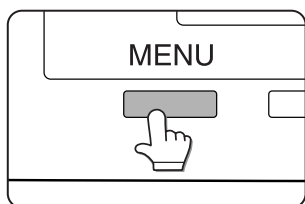

Press the [MENU] key repeatedly until the message "CUSTOM SETTINGS" appears. Any print jobs held in the printer and any job currently transmitted to the printer will be printed in the former custom setting conditions.

**3** Press the ▲ or ▼ key to select the desired setting item.

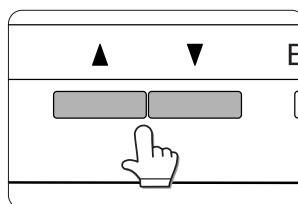

**2** Press the [OK] key.

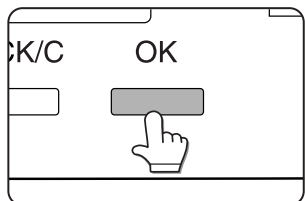

**4** Press the [OK] key.

**5** Press the ▲ or ▼ key to select the desired setting.

For details of each setting item, see the description on and after page xxxx.

# CUSTOM SETTINGS

## 6 Press the [OK] key.

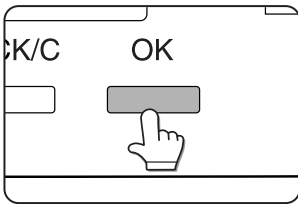

“✳” will be displayed to the right of selected item, and the setting will be registered. Depending on the setting item, additional item selection and registration operation may be needed. In this case, use the ▲ or ▼ key to select an item and press the [OK] key to register it. To set another item, press the [BACK/C] key and repeat steps 5 and 6.

## 7 When setting is complete, press the [MENU] key to return to the basic screen.

### NOTE

If the [BACK/C] key is pressed after each setting is complete, the display that has called the setting will appear again. If selection of a number is mistaken during setting operation, press the [BACK/C] key to correct the selected number.

When using the operation panel with touch panel:

## 1 Press the [CUSTOM SETTINGS] key when the printer screen is displayed to display the custom settings menu screen.

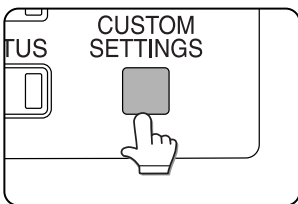

Any print jobs held in the printer and any job currently transmitted to the printer will be printed in the former custom setting conditions.

## 2 Touch the key of the desired item to display its setting screen.

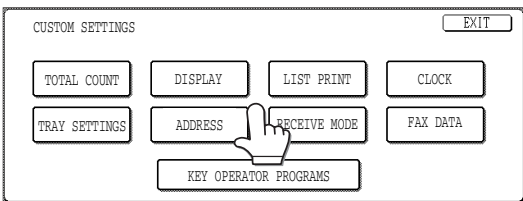

For details of each setting item, see the description on and after the next page.

## 3 Touch the desired setting on the setting screen of the desired item and touch the [OK] key.

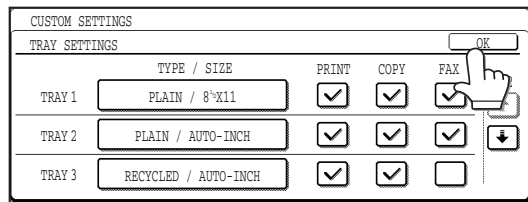

To set another item, repeat steps 2 and 3.

## 4 To finish the setting operation, touch the [EXIT] key.

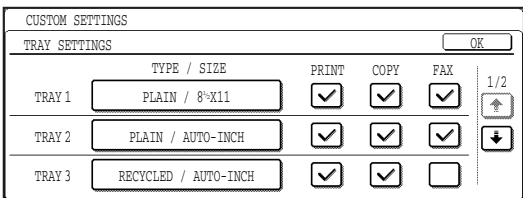

Depending on the setting item, additional item setting keys may be displayed and page switching keys may be displayed.

If a check box is displayed for an item, the item can be set by touching the key to display a check mark (☑) in the box.

## 3-6

## Setting items

### ■ Total count

The number of total printed pages in this product can be displayed and printed.

The displayed or printed items vary with installation of peripheral units.

### ■ Display contrast

Can be set if this product is equipped with a scanner module as a peripheral unit.

This item is used to adjust the contrast of the touch panel display.

### ■ List print

Test pages such as a list of setting items configured in this product and a list of the resident fonts for checking can be printed.

The types of test pages are shown below.

- Setting list print  
The settings in the printer feature are printed.
- Printer test page
  - Demonstration page printing: Demonstration pages contained in this product are printed.
  - PCL font list printing: A list of fonts that can be used with the PCL printer drivers is printed.
  - PCL symbol set printing: A PCL symbol set list is printed.
  - NIC page printing: A list of settings used by the NIC (Network Interface Card), namely the print server card (peripheral unit), is printed.
  - PostScript font list printing: A list of fonts that can be used with the PostScript printer driver is printed.

#### NOTE

If test page printing is disabled with key operator program "DISABLE TEST PAGE PRINTING" (page xx), the printer test pages cannot be printed.

### ■ Clock

The date and time of the built-in clock of this product are set.

This setting is needed for date and time information in E-mail delivery of information of this product (see page xxxx), date print function in the copy mode (see page xxxx), timer operations in the fax mode (see page xxxx), and date and time information recording of fax transmission and reception (see page xxxx).

### ■ Tray settings

Paper type, paper size, operation mode, and use of automatic tray switching are set for each tray.

The operation mode can be set when this product is equipped with a scanner module as a peripheral unit. If the product is not equipped with a scanner module, use the item "Auto tray switching" described below for setting the automatic tray switching function.

### ■ Auto tray switching

This item can be set if this product is not equipped with a scanner module as a peripheral unit.

If the auto tray switching function is set and more than one tray of the same paper size is installed in this product, printing can be continued by switching automatically the paper tray when paper of a tray runs out. This item is used to enable the auto tray switching function. If the product is equipped with a scanner module as a peripheral unit, use the item "Tray settings" to set this function.







# CHAPTER 4

---

## TROUBLESHOOTING AND MAINTENANCE

---

This chapter describes misfeed removal, user maintenance, etc.

	Page
<b>MISFEED REMOVAL</b> .....	4-2
● General misfeed removal procedure .....	4-2
● Misfeed removal guidance .....	4-3
● Misfeed in the paper feed area .....	4-4
● Misfeed in the transport area, fusing area, and exit area .....	4-6
● Misfeed in the duplex module .....	4-7
<b>TROUBLESHOOTING</b> .....	4-8
<b>USER MAINTENANCE</b> .....	4-12
● Cleaning the scanner module .....	4-12

# MISFEED REMOVAL

## When using the operation panel on the main unit:

\* For operation from the operation panel with touch panel, see the next page.

When a misfeed has occurred, the message shown below will appear and printing will stop. Follow the procedure below to remove misfed paper.

PAPER JAM.

### NOTES

- Do not damage or touch the photoconductive drum. (See page 1-6.)
- Be careful not to tear the misfed paper during removal.
- If paper is accidentally torn during removal, be sure to remove all pieces.

### CAUTION

The fusing unit is hot. Take care in removing paper.

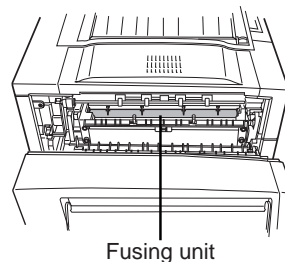

Fusing unit

## General misfeed removal procedure

If the INFORMATION key is pressed when a misfeed has occurred, the approximate misfeed locations will be displayed. Use the following procedure to check the misfeed locations and refer to the corresponding misfeed removal procedure.

### 1 Press the INFORMATION key.

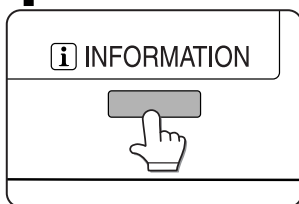

### 2 Press the ▲ or ▼ key on the operation panel.

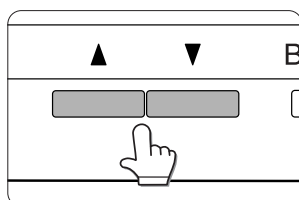

Each time the ▼ key is pressed, the misfeed removal procedure will be displayed sequentially.

The messages in the table below show approximate misfeed locations. For misfeed removal procedure, see the pages indicated in the table.

Message	Page
SLIDE THE FINISHER FROM MACHINE.	
PULL OUT TRAY * AND CHECK THE PAPER.	
PULL OUT PAPER FROM BYPASS TRAY.	
OPEN THE LOWER LEFT COVER.	
OPEN THE DUPLEX COVER.	
OPEN THE LEFT COVER.	
OPEN THE UPPER PATH.	
OPEN THE MAIL-BIN COVER.	
OPEN THE FINISHER TOP COVER.	

### 3 Press the INFORMATION key to close the misfeed removal guidance.

**When using the operation panel with touch panel:**

When a misfeed has occurred during printing, the message "A MISFEED HAS OCCURRED." will appear in the touch panel display of the operation panel and printing including copying and facsimile output will stop. The approximate locations are indicated with "▼" shown in the illustration below. Refer to the description for the indicated locations to remove the misfed paper.

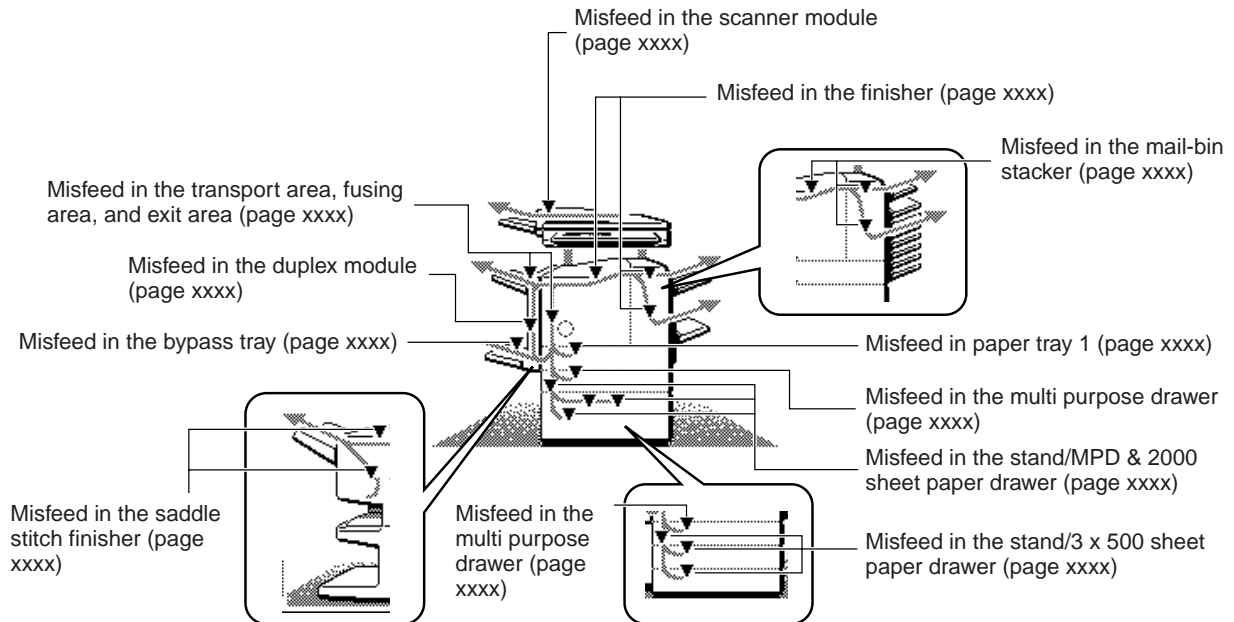

**NOTE**

- Facsimile reception data is always stored in the memory temporarily. When a misfeed has occurred, the received data will not be printed. After misfed paper is removed, received data will be automatically printed.
- When removing misfed paper, take care not to apply vibration to the machine. Vibration during scanning originals may disturb scanning, resulting in partially improper copies or images for facsimile or scanner transmission.

**NOTES**

- Do not damage or touch the photoconductive drum. (See page 1-6.)
- Be careful not to tear the misfed paper during removal.
- If paper is accidentally torn during removal, be sure to remove all pieces.

**CAUTION**

The fusing unit is hot. Take care in removing paper.

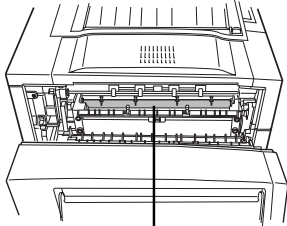

Fusing unit

**Misfeed removal guidance**

Misfeed removal guidance can be displayed by touching the INFORMATION key on the touch panel when a misfeed has occurred.

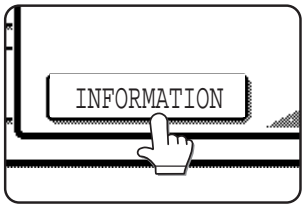

## Misfeed in the paper feed area

**NOTE**

Do not pull out the paper tray first. Paper may be misfed between the paper tray and the paper feed area in the printer. Before pulling out the paper tray, be sure to open the left side cover and check to see if paper is misfed (steps 1 and 2). If you pull out the paper tray without checking, paper may be torn and it may be difficult to remove it.

### ■ Misfeed in paper tray 1

#### 1 Pull out the duplex module.

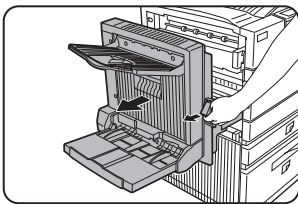

Hold the knob and gently open the module. If the machine is not equipped with the duplex module, open the side cover similarly.

#### 5 Gently close the duplex module.

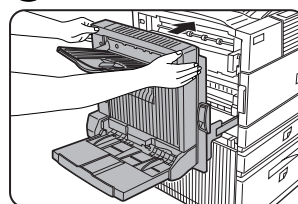

If the machine is not equipped with the duplex module, close the side cover similarly. After closing the duplex module, confirm that the misfeed message is cleared and that the normal display appears.

#### 2 Remove the misfed paper.

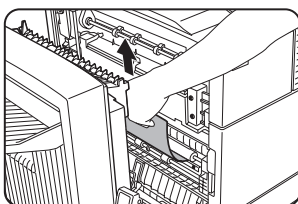

Be careful not to tear the misfed paper during removal.

**NOTE**

If paper drops beyond the rear side of the paper tray that has been pulled out, remove the paper tray and then remove the paper. (For removal of the paper tray, see the illustration below.)

**NOTE**

Since paper may be misfed in the inner part, check carefully and remove it.

#### 3 If misfed paper is not found in step 2, pull out paper tray 1 and remove the misfed paper.

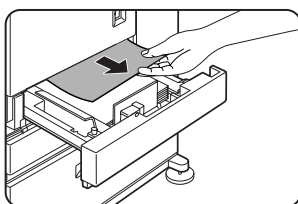

Be careful not to tear the misfed paper during removal.

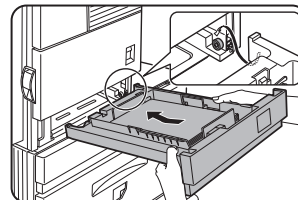

After pulling out the paper tray until it stops, gently lift and pull the tray to remove it. To reattach the removed paper tray, insert it at an angle and then push it back horizontally in the reverse procedure of removal.

#### 4 Gently close the paper tray.

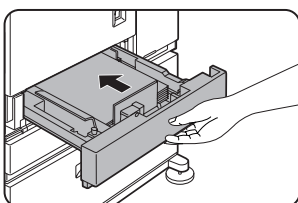

Push back the paper tray all the way into the machine.

■ Misfeed in the multi purpose drawer

**1** If the machine is equipped with a stand/paper drawer, open the side cover of the stand/paper drawer.

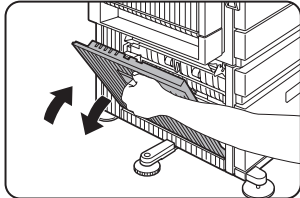

Hold the knob and gently open the cover. If the machine is not equipped with a stand/paper drawer, proceed to step 4.

**2** Remove the misfed paper.

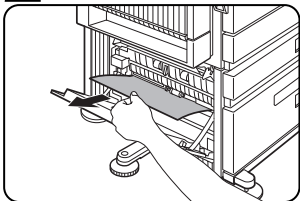

Be careful not to tear the misfed paper during removal.

**NOTE**

Since paper may be misfed in the inner part, check carefully and remove it.

**3** Close the side cover of the stand/paper drawer.

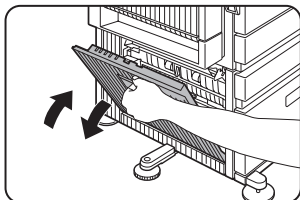

**4** If misfed paper is not found in step 2, refer to “Misfeed in paper tray 1” (steps 1 to 5 on page xxxx) to remove the misfed paper.

■ Misfeed in the stand/3 x 500 sheet paper drawer

For misfeed removal in the upper tray and middle and lower trays, follow step 1 to 4 of the description of “Misfeed in the multi purpose drawer” above to remove the misfed paper.

■ Misfeed in the stand/MPD & 2000 sheet paper drawer

For misfeed removal in the upper tray, follow the procedure of “Misfeed in the multi purpose drawer” shown to the left to remove the misfed paper. For misfeed removal in the lower large capacity tray, follow the procedure below.

**1** Follow steps 1 to 3 of “Misfeed in the multi purpose drawer” shown to the left.

**2** If misfed paper is not found in step 1, refer to “Misfeed in paper tray 1” (steps 1 and 2 on page xxxx) to remove the misfed paper.

**3** If misfed paper is not found in steps 1 and 2, pull out the large capacity tray (lower tray) and remove the misfed paper.

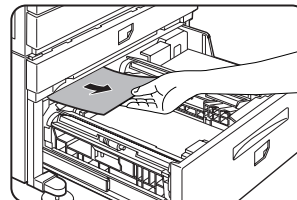

• If paper is misfed on the right paper feed table:

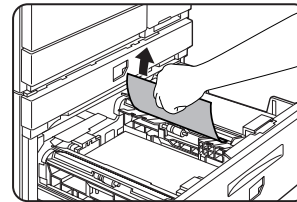

• If paper is misfed on the left paper feed table:

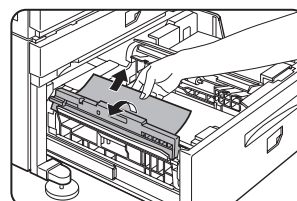

Raise the paper guide and remove the misfed paper.

**4** Gently close the large capacity tray.

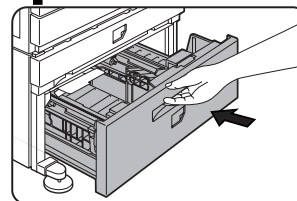

Push back the paper tray all the way into the machine.

**5** Gently close the duplex module.

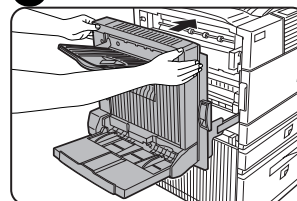

If the machine is not equipped with the duplex module, close the side cover similarly. After closing the duplex module, confirm that the misfeed message is cleared and that the normal display appears.

# Misfeed in the transport area, fusing area, and exit area

**CAUTION**  
The fusing unit is hot. Take care in removing paper.  
(Do not touch the metal portion.)

## 1 Pull out the duplex module.

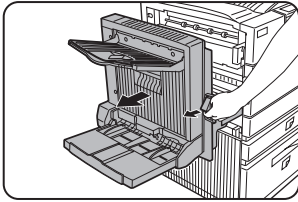

Hold the knob and gently open the module.  
If the machine is not equipped with the duplex module, open the side cover similarly.

- If paper is misfed in the exit area:

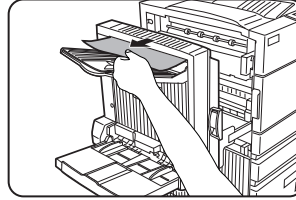

Remove the misfed paper taking care not to tear the paper.

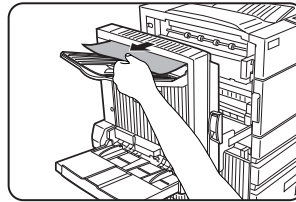

If the duplex module is equipped with an exit tray and paper is misfed in the exit area, remove the misfed paper as shown in the illustration.

## 2 Remove the misfed paper.

- If paper is misfed in the transport area:

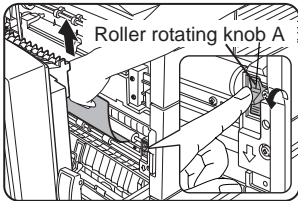

Turn roller rotating knob A in the direction of the arrow to remove the misfed paper.

- If paper is misfed in the fusing area:

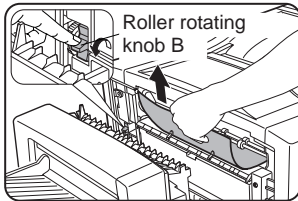

Turn roller rotating knob B in the direction of the arrow to remove the misfed paper.

## 3 Gently close the duplex module.

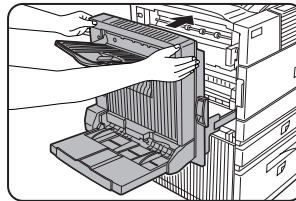

After closing the duplex module, confirm that the misfeed message is cleared and that the normal display appears.

**CAUTION**  
The fusing unit is hot. Take care in removing paper.  
(Do not touch the metal portion.)

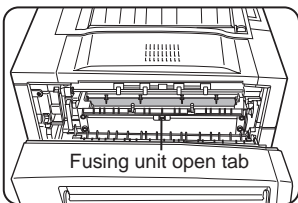

If the misfed paper is inside the fusing area, turn down the fusing unit open tab to your side to open the fusing unit and remove the misfed paper.

## Misfeed in the duplex module

### 1 Pull out the duplex module.

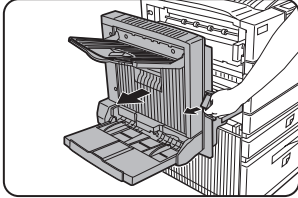

Hold the knob and gently open the module.

### 5 Gently close the duplex module.

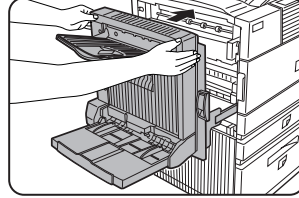

After closing the duplex module, confirm that the misfeed message is cleared and that the normal display appears.

### 2 Raise the exit tray and open the cover of the duplex module.

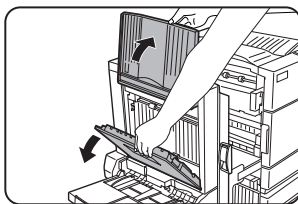

If the duplex module is not equipped with an exit tray, the operation concerning the exit tray is not needed (steps 2 to 4).

### 3 While holding the exit tray up, remove the misfed paper.

- If paper is misfed at the upper part of the duplex module:

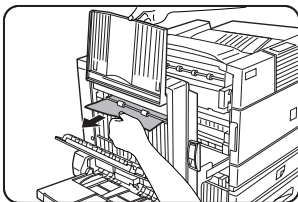

Gently remove the misfed paper taking care not to tear the paper.

- If paper is misfed at the lower part of the duplex module:

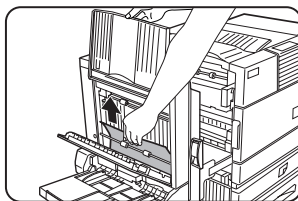

Gently remove the misfed paper taking care not to tear the paper.

### 4 Close the cover of the duplex module and return the exit tray.

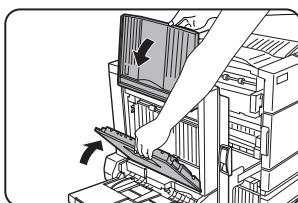

### ■ Misfeed in the bypass tray

#### 1 Remove the misfed from the bypass tray.

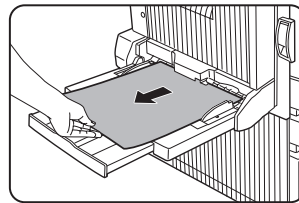

Be careful not to tear the misfed paper during removal.

4

#### 2 Open and close the duplex module to clear the misfeed message.

# TROUBLESHOOTING

Always check the message display whenever the printer stops or operation is not possible. The messages will give you easy-to-follow directions. If the messages do not give specific instructions, check the list below.

This section describes only troubleshooting concerning the printer feature and problems common to all features of this product. For troubleshooting of the copier, facsimile, and network scanner features, see the respective manuals. Also for problems in peripheral units, see their respective descriptions.

Problem	Solution	
Printer does not operate.	● Printer plugged in?	Plug the printer into a grounded outlet.
	● Main power switch on?	Turn on the main power switch.
	● READY indicator on?	The printer is warming up. (Warm-up time is approximately 95 seconds.) Wait until the READY indicator lights up.
	● Message indicating need to load paper displayed? (ERROR indicator lit at the same time on the operation panel of the main unit?)	Load paper. (page xxxx)
	● Message indicating need to replace the toner cartridge displayed? (ERROR indicator lit at the same time on the operation panel of the main unit?)	Toner runs out. Replace the toner cartridge immediately. (page xxxx)
	● Message indicating a paper misfeed displayed? (ERROR indicator lit at the same time on the operation panel of the main unit?)	Remove misfed paper. (page xxxx)
Printer is on but data is not received.	● Is the correct interface cable properly connected between the printer and your computer?	Ensure that the correct interface cable is connected between the printer and your computer.
	● Is the correct printer driver installed?	Install the appropriate printer driver. (page xxxx)
	● Is the printer not selected properly or not registered on the network (when used as a network printer)?	Ensure that this printer is selected on the application software or use an appropriate utility to check that the printer is registered on the network.
Data is received but not printed. (DATA indicator blinks.)	● Has an error occurred?	Check to see if an error message is displayed in the message display.
	● Is the specified size paper loaded in the printer?	Load paper, select another paper size or cancel printing.
Printer cannot be selected from computer.	● Is the printer driver installed correctly?	Install the printer driver correctly. (page xxxx)
Incorrect orientation	● Is the orientation setting in the printer driver correct?	Correct the orientation in the printer driver.
Paper image is clipped or off the edge of paper.	● Zoom printing?	Use the proper magnification ratio for printing.



Problem	Solution	
Black pages	● Is color image data printed?	Color image may be printed in black.
	● Are the black and white areas reversed?	Cancel negative image printing feature in the printer driver.
Image loss along the edges	● Is the image loss outside the print area?	Change the print area (page xxxx) or reduce the print image.
Printer prints in reverse order.	● Is the reverse order selected in the application software?	Cancel the reverse order printing in the application software.
Printer stops in the middle of a print job.	● Too much paper in the exit tray? (page xxxx)	Remove the paper from the exit tray.
	● Has the paper runs out?	Load paper.
Paper specified from application is not used.	● Is paper selection of driver "Auto"?	Ensure that the desired paper is set in a paper tray of the printer and select "Auto" in the paper selection of the printer driver.
Printer resident font cannot be selected from application software (when the PPD file of an optional PS3 expansion kit is used in Windows (not NT) environment).	● Has the resident font information installed?	Install (or reinstall) the resident font information. If installed resident font information may be damaged, reinstall it. (page xxxx)
Printer write error occurs when using the printer as a local printer.	● Is the timeout time short?	Set a longer time in the timeout setting.
Only one set has been output when more than one set has been specified. (A notice page has been output.)	● Is the number of pages large?	The print data amount exceeds the limit of storage of this printer. (page xxxx) Repeat one set printing. If a hard disk is not installed, installation of it may enable printing of more than one set depending on the number of pages.
Not printed or only a notice page is printed.	● Two-sided printing of a large number of pages is specified?	Print a smaller number of pages at a time. If a hard disk is not installed, installation of it may enable printing depending on the number of pages.
Printed image is too light or too dark.	● Is the exposure control set properly?	The printer exposure level can be adjusted by using a key operator program. Contact your key operator. (page xxxx)

<b>Problem</b>	<b>Solution</b>	
Smudges on printed sheets	<ul style="list-style-type: none"> <li>● Is a message indicating a need of maintenance displayed?</li> </ul>	Maintenance is required.
Specified paper is not selected.	<ul style="list-style-type: none"> <li>● Has the paper size been set when the paper size in a tray was changed?</li> </ul>	Be sure to set the paper size referring to "Method of setting paper size and type" when you change the paper size in a tray. (page xxxx)
Paper misfeeds frequently.	<ul style="list-style-type: none"> <li>● Paper curled or damp?</li> </ul>	Do not use curled or crimped paper. If you do not use paper for a long time, store paper in the wrapper in a dry location.
	<ul style="list-style-type: none"> <li>● Paper curled and misfed in the duplex module or finisher?</li> </ul>	Paper may be curled when output depending on the paper type and quality. Remove paper from the paper tray or the bypass tray, turn it upside down, and load it again.
Printed image rubbed off or paper crimped.	<ul style="list-style-type: none"> <li>● Is paper size or weight out of the allowable range?</li> </ul>	Use paper in the allowable range.
	<ul style="list-style-type: none"> <li>● Paper damp?</li> </ul>	Be sure to store paper in the wrapper in a dry location and do not store paper in a location that is <ul style="list-style-type: none"> <li>● humid</li> <li>● at a high temperature or an extremely low temperature</li> <li>● exposed to direct sunlight</li> <li>● dusty location.</li> </ul>
Touch panel is too dark or too light. (in case of operation panel with touch panel)	<ul style="list-style-type: none"> <li>● Is LCD contrast properly adjusted?</li> </ul>	Adjust the contrast using "DISPLAY CONTRAST" of custom settings. (page xxxx)
A job is not held in the job retention function. (A notice page is printed.)	<ul style="list-style-type: none"> <li>● Does the number of jobs reach 100?</li> </ul>	Delete unnecessary hold jobs.
Password entry is requested.	<ul style="list-style-type: none"> <li>● Password set in the retention function?</li> </ul>	Password is needed when executing printing. If the password is not known, printing cannot be executed.

## Supplementary explanation for printing

1. When printing multiple sets, this printer always prints each set sequentially. (This printer does not print all copies of one page at a time.)
2. If you try to start printing through the parallel interface immediately after the printer is turned on (READY indicator not lit), printing may not be performed properly. Be sure to start printing through the parallel interface after ensuring that the printer becomes online.
3. To print onto A4R, B5R or 8-1/2" x 11"R paper, specify the tray in which the desired paper has been loaded.
4. If paper must be added when paper has run out in the middle of a print job, be sure to set the paper in the same orientation. If the orientation is changed in the middle of a print job, part of images may not be printed. Image rotation will not occur in the middle of a print job.
5. When setting A5 or 5-1/2" x 8-1/2" (invoice) size paper in a paper tray or in the bypass tray, be sure to set the paper longer side into the feed slot. If not, part of images may not be printed.
6. When setting postcards, 10-1/2" x 7-1/4" (executive) paper or custom size paper in a paper tray or in the bypass tray, be sure to set the paper shorter side into the feed slot. If not, part of images may not be printed.
7. If the tray to be used is open when a print job is sent to the printer, part of images may not be printed. Be sure to start printing after ensuring that all the trays are closed.
8. If the setting "collate" exists in the print dialog box or application's print settings, do not select this setting. This setting is not necessary because this printer always performs collated printing. If this setting is selected, two-sided printing or stapling in printing of multiple sets may not be performed properly.
9. With the PPD driver for Windows NT 4.0, the printer resident fonts cannot be specified. Font downloading, therefore, is performed each time printing is executed.
10. Depending on print data, "VM error" or "Memory Full" error message may be printed on a page or improper printing (some images or characters are missing) may occur. This error occurs because of insufficient memory when printing a lot of data or complicated data. This error may be avoided by adding an additional memory to the printer. If this error occurs frequently, contact your dealer.

# USER MAINTENANCE

To use this product for a long time, keep the cabinet of the main unit and the like clean.

## NOTE

When cleaning, do not use thinner, benzene, or similar volatile cleaning agents.

## Cleaning the scanner module

If the document glass, cover or original scanning portion of the scanner module is dirty, scanned image may be soiled or black stripes may appear on image. Keep them always clean.

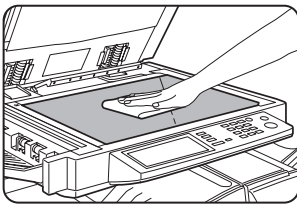

Wipe them with a soft, clean cloth.  
If necessary, dampen the cloth with water or a small amount of neutral detergent. After wiping them with it, wipe them with a clean, dry cloth.

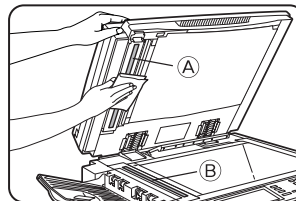
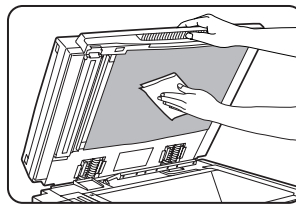

If black stripes appear on images obtained by scanning sheet originals that have been fed from the feeder, wipe the scanning portion (long and narrow glass shown in the illustration). Wipe both (A) and (B).



# CHAPTER 5

---

## PERIPHERAL UNITS

---

This chapter describes operating instructions for the Mail-Bin Stacker, Finisher, Saddle Stitch Finisher, etc.

	Page
DUPLEX MODULE .....	5-2
● Part names .....	5-2
● Specifications .....	5-2
● Loading paper in the bypass tray (duplex module/bypass tray only) .....	5-3
● Setting the printer driver in accordance with your purpose .....	5-4
● Setting copy functions in accordance with your purpose .....	5-4
● Troubleshooting (concerning the duplex module) .....	5-5
MAIL-BIN STACKER .....	5-6
● Part names .....	5-6
● Specifications .....	5-6
● Delivering output paper into a specified mail bin from the printer feature .....	5-7
● Setting in the printer driver .....	5-7
● Misfeed in the mail-bin stacker .....	5-8
FINISHER .....	5-9
● Part names .....	5-9
● Specifications .....	5-9
● Finisher functions .....	5-10
● Using the finisher functions .....	5-11
● Staple cartridge replacement and staple jam removal .....	5-12
● Misfeed in the finisher .....	5-14
● Troubleshooting (concerning the finisher) .....	5-15
● Stapling quick reference list .....	5-16
SADDLE STITCH FINISHER .....	5-17
● Part names .....	5-17
● Specifications .....	5-17
● Saddle stitch finisher functions .....	5-18
● Using the saddle stitch finisher functions .....	5-20
● Staple cartridge replacement and staple jam removal .....	5-21
● Misfeed in the saddle stitch finisher .....	5-24
● Troubleshooting (concerning the saddle stitch finisher) .....	5-26
● Stapling position quick reference list .....	5-27
● Relation between print image and saddle stitch .....	5-28

# DUPLEX MODULE

If a duplex module is installed, printing onto two sides of paper can be performed.

Two types of duplex modules are provided: duplex module/bypass tray and duplex module. Both duplex modules are equipped with an exit port to which an optional exit tray can be mounted. This section describes supposing that an optional exit tray is mounted to a duplex module/bypass tray. For misfeed removal of the duplex module, see page xxx.

## Part names

### Exit tray

The tray is extendable. To print onto large paper (8-1/2" x 14", 11" x 17", B4 or A3), extend the tray.

### Duplex module

Automatic two-sided printing can be made. (See page xx.)

### Bypass tray

This tray can be used to print onto special papers including transparency film as well as plain paper. (See page xx.)

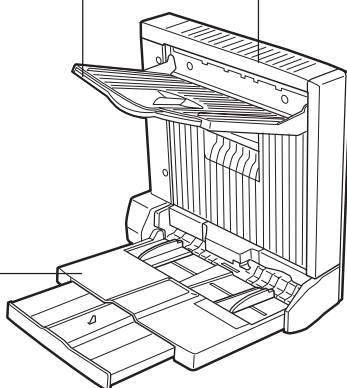

## NOTES

- Do not put pressure on the bypass tray or the exit tray.
- Some other peripheral units may be needed for installation of the duplex module and some peripheral units cannot be installed together with the duplex module. For combination of the peripheral units, see the list of combination of peripheral units on page xxxx.

## Specifications

Name	Duplex module and Duplex module/bypass tray
Paper capacity	1 (trayless system)
Paper size	Max. 11" x 17" or A3, Min. 5-1/2" x 8-1/2"R or A5R
Paper weight	15 to 28 lbs. or 56 to 105 g/m <sup>2</sup>
Reference paper position	Center
Bypass tray paper capacity*1	100 sheets (8-1/2" x 11" or A4 size, 20 lbs. or 80 g/m <sup>2</sup> )
Dimensions	Duplex module: xx-x/x" (W) x xx-x/x" (D) x xx-x/x" (H) (xxx mm (W) x xxx mm (D) x xxx mm (H)) Duplex module/bypass tray: xx-x/x" (W) x xx-x/x" (D) x xx-x/x" (H) (xxx mm (W) x xxx mm (D) x xxx mm (H))
Weight	Duplex module: Approx. xxx lbs. (xx kg) Duplex module/bypass tray: Approx. xxx lbs. (xx kg)
※1 Duplex module/bypass tray only. For use of the bypass tray, see "Paper available in the bypass tray/multi purpose drawer" on page xxxx.	
Name	Exit tray
Exit system	Print face down
Paper capacity	100 sheets (8-1/2" x 11" or A4 size, 20 lbs. or 80 g/m <sup>2</sup> )
Paper size	Max. 11" x 17" or A3, Min. 5-1/2" x 8-1/2"R or A5R

Specifications are subject to change for improvement without notice.

## Loading paper in the bypass tray (duplex module/bypass tray only)

If you use the bypass tray, you can print onto plain paper other than SHARP recommended paper and special papers including labels. Up to 100 sheets of SHARP recommended paper (up to xx sheets of postcards) can be set, allowing continuous printing in a similar way to paper trays.

**NOTE**

When setting paper in the bypass tray, be sure to set the paper type (step 4 on the next page).

### 1 Open the bypass tray.

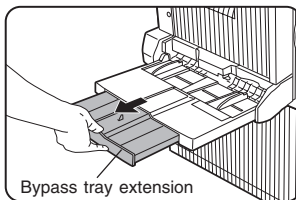
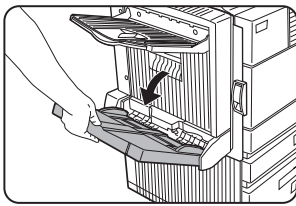

When setting 11"x 17", 8-1/2" x 14", 8-1/2" x 11"R, A3, B4 or A4R paper, be sure to open the bypass tray extension.

### 2 Set the bypass tray paper guides to the width of the paper to be used.

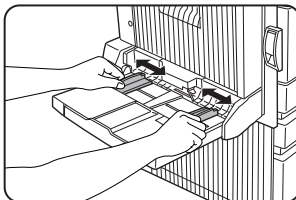

### 3 Insert the paper all the way into the bypass tray.

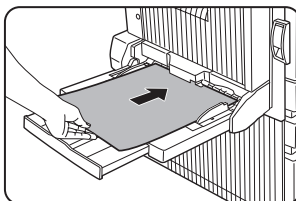

Set the paper face down. If there is a clearance between the paper and the paper guides, adjust the guides again properly. If there is a clearance, paper may be fed obliquely or may be curled.

**NOTES**

- When using 5-1/2" x 8-1/2"R paper, A5R paper or postcards, be sure to set them shorter edge into the feed slot as shown in the illustration.

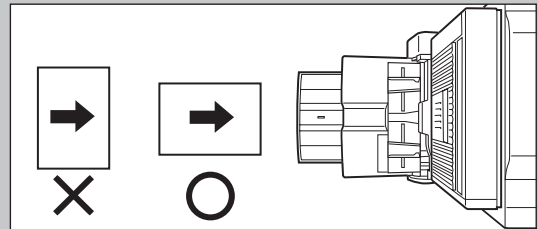

- When using plain paper other than SHARP recommended paper or special paper other than postcards and SHARP recommended transparency film, be sure to feed it one sheet at a time. If you set more than one sheet, a paper misfeed may occur.
- When adding paper, first remove remaining paper, combine it with the paper to be added, and then reload as a single stack. Adding paper directly may cause a paper misfeed.
- For transparency film, use SHARP recommended film. Set transparency film in the bypass tray with the label surface up. Printing onto the label surface may cause smudges on printouts.
- Do not print onto paper that has been printed by a facsimile for plain paper or by another printer. Doing so may cause smudges on printouts.
- When printing onto transparency film, be sure to remove it from the exit tray each time it is delivered. If the film is stacked in the exit tray, it may be curled.

### 4 Set the type of the loaded paper.

For paper types, see "Selecting paper type" of the main unit (page xxxx).

### 5 Loading paper in the bypass tray is now complete.

## DUPLEX MODULE

### Setting the printer driver in accordance with your purpose

When using the duplex module (including the bypass tray and the exit tray) for printing, set as follows based on your purpose after selecting “Properties” on the printer driver setting screen.

The screens used in the following descriptions are for a PCL driver in the Windows 98 environment.

#### ■ Two-sided printing

Open the “Main” tab and check the radio button of the desired two-sided printing mode.

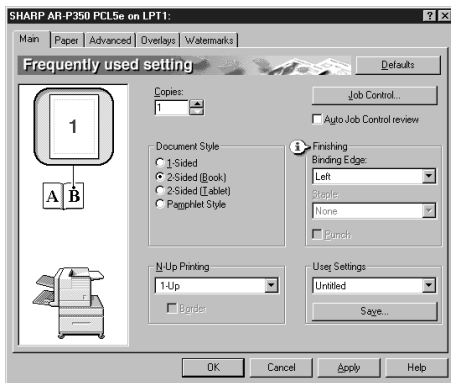

#### ■ Using the bypass tray

Open the “Paper” tab shown in the illustration below and select “Bypass Tray” at “Paper Selection”.

#### ■ Using the exit tray mounted to the duplex module

Open the “Paper” tab shown in the illustration below and select “Left Side Tray” at “Output”.

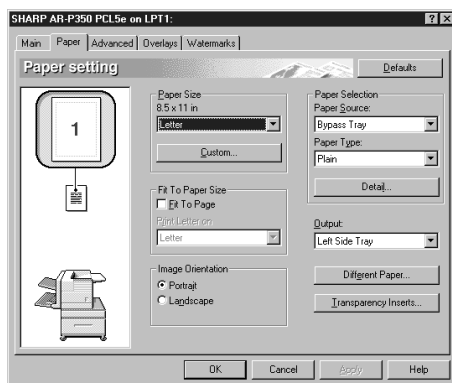

#### NOTES

- For the settings above, installation of peripheral units must have been set properly in the properties of the printer driver (see NOTE on page 2-5).
- Depending on the combination of paper selection and functions, the desired setting may not be possible. For details of setting items, see the printer driver help. The details of the functions are described.

### Setting copy functions in accordance with your purpose

When using the duplex module (including the bypass tray and the exit tray) in the copy mode, set as follows based on your purpose by touching a key displayed on the copy mode basic screen.

#### ■ Using the duplex module (for automatic duplex copying)

If you touch the [2-SIDED COPY] key on the copy mode basic screen, a selection screen for two-sided copying will appear.

#### ■ Using the bypass tray

If you touch the [PAPER SELECT] key on the copy mode basic screen, a selection screen for paper source will appear. Select the bypass tray on this screen.

#### ■ Using the exit tray

If you touch the [OUTPUT] key on the copy mode basic screen, a selection screen for output will appear. Select the exit tray mounted to the duplex module on this screen.



### Troubleshooting (concerning the duplex module)

Check the list below before contacting the SHARP Service Center.

Problem	Solution	
The printer does not print.	Message indicating the paper type cannot be used for two-sided printing displayed?	Use a paper type adequate for two-sided printing. (See page xx.)
	Message indicating the paper size cannot be used for two-sided printing displayed?	Use a paper size adequate for two-sided printing. (See page xx.)
	Two-sided printing cannot be set in printing?	Open the Configuration tab in the printer driver setting and check the check box of Duplex Module. (See NOTE on page 2-5.)
Printed images onto paper from the bypass tray are inclined.	Does the number of sheets exceed the limit?	Set paper within the allowable range.
	Paper guides properly set?	Set the paper guides properly to the paper size.
A paper misfeed occurs in the bypass tray.	Paper size and type set properly?	When using non-standard size paper or special paper, be sure to set the paper size and type. (See page xx.)
	Does the number of sheets exceed the limit?	Set paper within the allowable range.
	Paper guides properly set?	Set the paper guides properly to the paper size.

# MAIL-BIN STACKER

The mail-bin stacker is an output unit of which a mail bin can be specified arbitrarily for printer output among multiple exit trays (mail bins).

Output paper in the copy mode and the fax mode can be delivered to the top tray other than mail bins. (Output paper from the printer feature can also be delivered to the top tray.)

## Part names

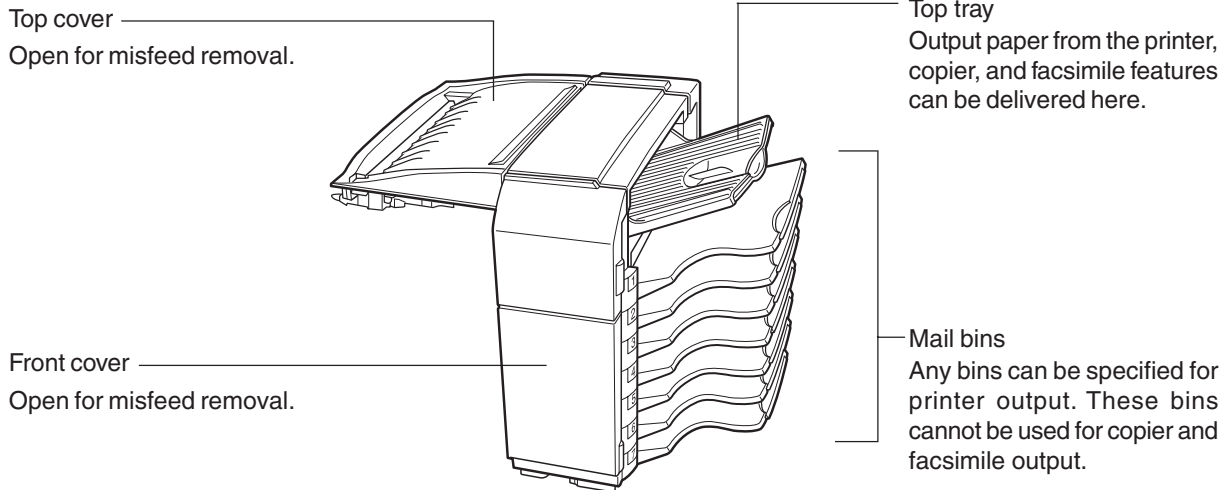

### NOTES

- Do not put pressure on the mail-bin stacker (particularly top tray and mail bins).
- The top tray and each mail bin are extendable. To print onto large paper (8-1/2" x 14", 11" x 17", B4 or A3), extend the tray.
- Some other peripheral units may be needed for installation of the mail-bin stacker and some peripheral units cannot be installed together with the mail-bin stacker. For combination of the peripheral units, see the list of combination of peripheral units on page xx.

## Specifications

Name	Mail-bin stacker
Number of trays	8 (Top tray and seven mail bins)
Exit system	Print face down
Tray type	Top tray: normal tray, Mail bins: mail bin tray
Paper capacity	Top tray: 250 sheets (8-1/2" x 11" or A4 size, 20 lbs. or 80 g/m <sup>2</sup> ) Mail bins: 125 sheets each (8-1/2" x 11" or A4 size, 20 lbs. or 80 g/m <sup>2</sup> )
Paper size	Top tray: max. 11" x 17" or A3, min. 5-1/2" x 8-1/2"R or A5R Mail bins: max. 11" x 17" or A3, min. 8-1/2" x 11" or B5R
Paper weight	Top tray: 14 to 54 lbs. or 56 to 205 g/m <sup>2</sup> Mail bins: 15 to 34 lbs. or 56 to 105 g/m <sup>2</sup>
Paper type	Top tray: same as the specifications of paper for feeding in the main unit Mail bins:
Paper limit detection	Provided in both the top tray and the mail bins
Reference paper position	Center
Power supply	Drawn from the power supply unit (peripheral unit) (See page xx.)
Dimensions	xx-x/x" (W) x xx-x/x" (D) x xx-x/x" (H) (xxx mm (W) x xxx mm (D) x xxx mm (H))
Weight	Approx. xxx lbs. (xx kg)

Specifications are subject to change for improvement without notice.

## Delivering output paper into a specified mail bin from the printer feature

When delivering paper from the printer feature, any mail bin for delivery can be specified.

If users are assigned to mail bins by person or by department and if the users specify their assigned mail bin for delivery, their output paper can be clearly classified. Also the mail bins can be used as mail boxes by delivering document data to a mail bin to which a certain person or department has been assigned.

For delivery that does not require classification, the top tray can be specified.

### ■ Using the mail-bin stacker

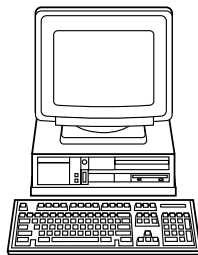
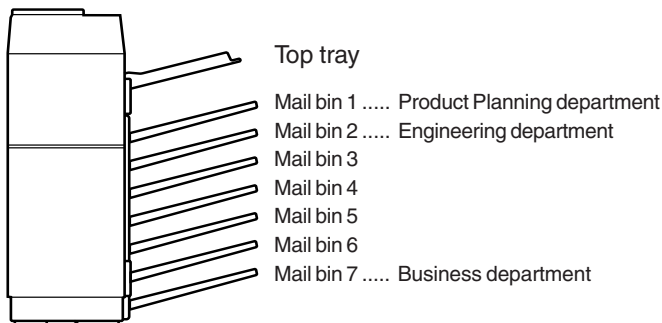

## 1 Assign users to mail bins.

It is recommended that the administrator of this product specify assignment of each bin (for example, the Product Planning department is assigned to mail bin 1 and the Engineering department is assigned to mail bin 2) and explain the using method of the mail-bin stacker to the users.

## 2 Specify a mail bin for delivery in the printer driver setting screen when printing.

For the setting in the printer driver, see the description below.

5

## Setting in the printer driver

When printing, to specify a mail bin, select "Properties" in the printer driver setting screen and set as follows.

### ■ Specifying a mail bin

Open the "Paper" tab and select a mail bin for delivery at "Output". (The top tray can be selected.)

The illustration below shows the screen for a PCL printer driver in the Windows 98 environment.

#### NOTES

- For the settings above, installation of peripheral units must have been set properly in the properties of the printer driver (see NOTE on page 2-5).
- Depending on the combination of paper selection and functions, the desired setting may not be possible. For details of setting items, see the printer driver help. The details of the functions are described.



# MAIL-BIN STACKER

## Misfed in the mail-bin stacker

When a misfeed has occurred in the mail-bin stacker during printing, remove the misfed paper following the procedure below.

### 1 Open the top cover.

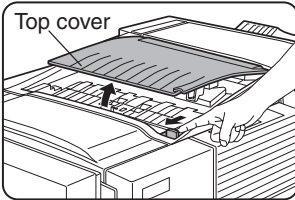

Slide the tab in the direction of the arrow in the illustration to open the cover.

### 6 Remove the misfed paper.

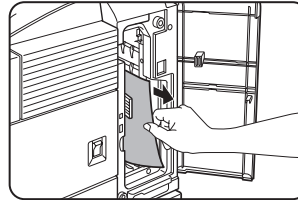

Be careful not to tear the misfed paper during removal.

### 2 Remove the misfed paper.

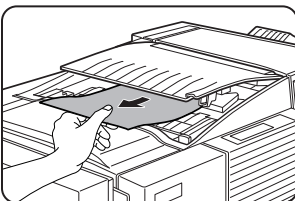

Be careful not to tear the misfed paper during removal. After removing the paper, press down on the top cover to close it.

### 7 Close the paper guide.

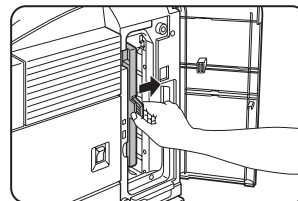

Close the paper guide securely to its original position.

### 3 If the misfed paper is not found in step 2, open the front cover.

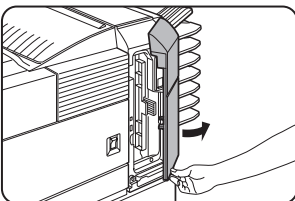

### 4 Turn the roller rotating knob in the direction of the arrow to remove the misfed paper.

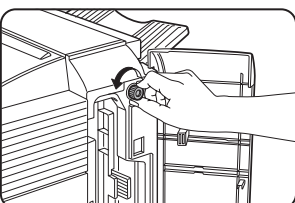

### 5 Open the paper guide.

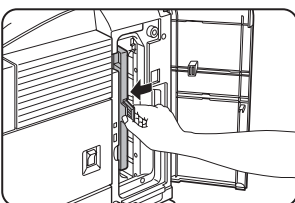

Hold the knob to unlock the paper guide and open it in the direction of the arrow.

### 8 Close the front cover.

# FINISHER

If the finisher is installed, the offset function can be used. Each set of printed sheets is stacked offset from the previous set so that it can be easily taken out. Also each set of sorted sheets can be stapled.

## Part names

Knob

Hold this knob to open the finisher for misfeed removal.

Top cover

Open for misfeed removal.

Staple unit

Pull out to replace the staple cartridge or to remove jammed staples.

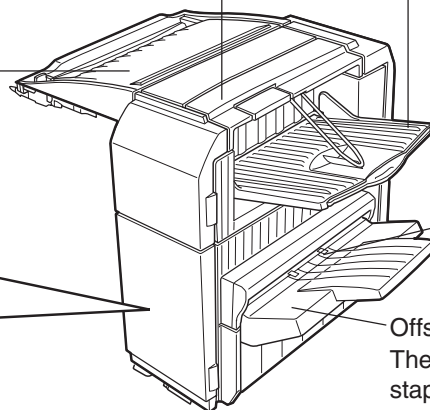
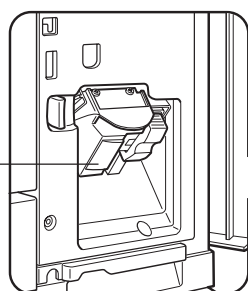

Top tray

Paper output from the printer, copier, and fax features can be delivered here.

The tray is extendable. To print onto large paper (8-1/2" x 14", 11" x 17", B4 or A3), extend the tray.

Stapler compiler

Paper to be stapled is stacked temporarily.

Offset tray

The offset function and the stapling function can be used only in this tray.

## NOTES

- Do not put pressure on the finisher (particularly each tray).
- Be careful about the offset tray during printing because the tray moves up and down.
- Some other peripheral units may be needed for installation of the finisher and some peripheral units cannot be installed together with the finisher. For combination of the peripheral units, see the list of combination of peripheral units on page xxxx.

## Specifications

Name	Finisher
Number of trays	2
Exit system	Print face down
Tray type	Top tray: normal tray, Lower tray: offset tray
Paper capacity	Top tray: 500 sheets (8-1/2" x 11" or A4 size, 20 lbs. or 80 g/m <sup>2</sup> ) Lower tray: 750 sheets (8-1/2" x 11" or A4 size, 20 lbs. or 80 g/m <sup>2</sup> )
Paper size	Top tray: Max. 11" x 17" or A3, Min. 5-1/2" x 8-1/2"R or A5R Lower tray: 8-1/2" x 11", A4 or B5R
Paper weight	Top tray: 15 to 54 lbs. or 56 to 205 g/m <sup>2</sup> Lower tray: 15 to 34 lbs. or 56 to 128 g/m <sup>2</sup>
Paper type	Top tray: same as the specifications of paper for feeding in the main unit Lower tray:
Paper limit detection	Provided in both the top tray and the lower tray
Offset function	Provided in the lower tray only, offset amount: 1.2 inch (30 mm)
Paper size for stapling	8-1/2" x 11", A4, and B5
Stapling capacity	30 sheets (20 lbs. or 80 g/m <sup>2</sup> )
Stapling position	Three types (one at rear, one at front, two at center)
Reference paper position	Center
Power supply	Drawn from the power supply unit (peripheral unit)(See page xx.)
Dimensions	xx-x/x" (W) x xx-x/x" (D) x xx-x/x" (H) (xxx mm (W) x xxx mm (D) x xxx mm (H))
Weight	Approx. xxx lbs. (xx kg)

Specifications are subject to change for improvement without notice.

## Supplies

For the finisher, the following staple cartridge is needed as supplies.

- Staple cartridge (Approximately 3,000 staples x 3)

xxxx

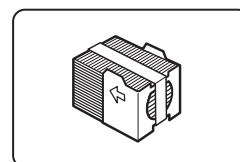

## Finisher functions

### ■ Sort mode

Each set will be sequentially printed and delivered.

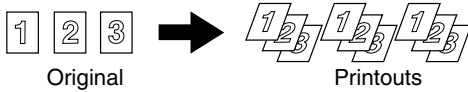

### ■ Group mode

All copies of the same page will be grouped.

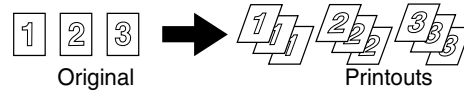

### ■ Offset mode

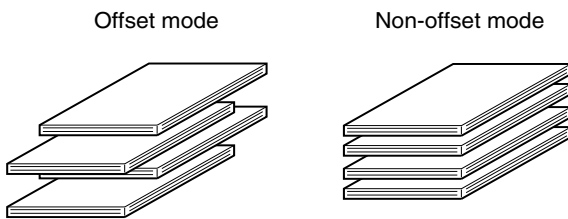

The offset tray moves from side to side so that each set is offset from the previous set and each set can be easily taken out. (The offset function operates only in the offset tray.)

When the staple sort function is selected, the offset function will not operate.

### ■ Staple sort mode

Collated sets of printouts are stapled and delivered to the offset tray. The stapling positions, orientation, paper size for stapling, and stapling capacity are shown below.

Stapling positions	Portrait orientation		Landscape orientation	
Rear corner of printouts		Available paper sizes: 8-1/2" x 11", A4 and B5 Stapling capacity: Up to 30 sheets for any available sizes		Available paper sizes: 8-1/2" x 11", A4 and B5 Stapling capacity: Up to 30 sheets for any available sizes
Center left two positions of printouts		Same as above		Two-position stapling cannot be made for landscape orientation.
Front corner of printouts		Same as above		Available paper sizes: 8-1/2" x 11", A4 and B5 Stapling capacity: Up to 30 sheets for any available sizes

## Using the finisher functions

### ■ Using the stapling function from the printer feature

When using the stapling function, select "Properties" on the printer driver setting screen, open the "Main" tab shown in the right illustration, and then select "Left", "Right" or "Top" at "Binding Edge" and "1 Staple" or "2 Staples" at "Staple".

The illustration below shows the screen for a PCL printer driver in the Windows 98 environment.

#### NOTES

- For the settings above, installation of peripheral units must have been set properly in the properties of the printer driver (see NOTE on page 2-5).
- Depending on the combination of paper selection and functions, the desired setting may not be possible. For details of setting items, see the printer driver help. The details of the functions are described.

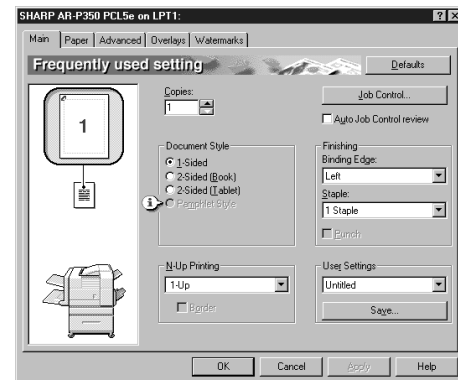

### ■ Using the finisher functions in the copy mode

If you touch the [OUTPUT] key on the copy mode basic screen, a screen for selecting the sort/group/staple functions and selecting an exit tray will appear.

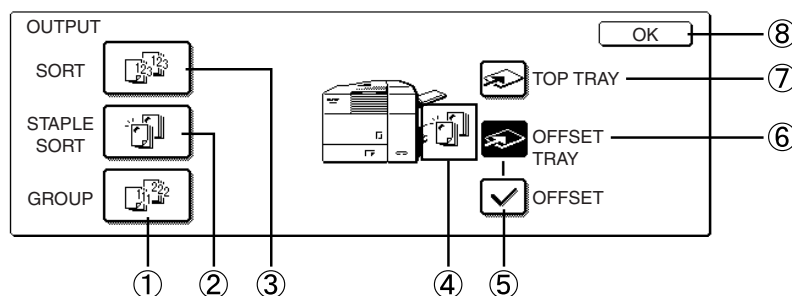

- ① **[GROUP] key (See page xx.)**  
If this function is selected, all copies of the same original will be grouped.
  - ② **[STAPLE SORT] key (See page xx.)**  
If this function is selected, sorted copies will be stapled and delivered to the offset tray. (not offset stacked)
  - ③ **[SORT] key (See page xx.)**  
If this function is selected, each set of copies will be sequentially delivered.
  - ④ **Icon display**  
The icon of the selected function (sort, staple sort or group) is displayed.
  - ⑤ **[OFFSET] key (See page xx.)**  
If this function is selected (checked), the offset function will be enabled. If the check mark is cleared, the offset function will be disabled. (If the staple sort function is selected, the check mark of the offset function will be automatically cleared.)
  - ⑥ **[OFFSET TRAY] key (See page xx.)**  
If the offset tray is selected, printed sheets will be delivered to the offset tray. (If the staple sort function is selected, the offset tray will be automatically selected.)
  - ⑦ **[TOP TRAY] key**  
If the top tray is selected, printed sheets will be delivered to the top tray.
  - ⑧ **[OK] key**  
Press to close this screen and to return to the basic screen.
- If a function is selected, the corresponding key will be highlighted.

## Staple cartridge replacement and staple jam removal

When the staple cartridge is empty or staples become jammed, a message will appear in the message display of the operation panel.

Follow the procedure below to replace the staple cartridge or remove jammed staples.

### 1 Open the front cover.

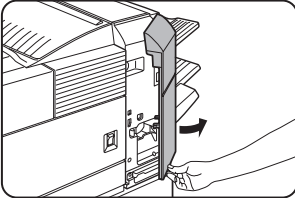

### 2 Turn the staple unit to face up.

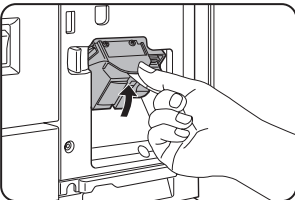

### 3 Hold the release lever to remove the staple box.

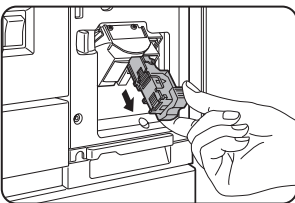

Check the remaining staples in the staple box.

- ① If no staple remains, replace the staple cartridge (steps 4 to 9).
- ② If sufficient staples remain, remove the jammed staples (steps 10 to 14).

### 4 Remove the empty staple cartridge.

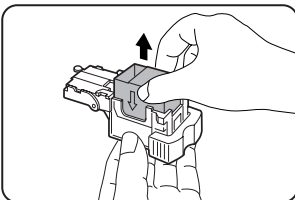

### 5 Insert a new staple cartridge into the staple box aligning the arrow of the staple cartridge with that of the staple box.

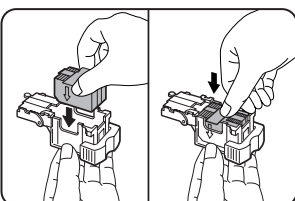

#### NOTES

- Do not remove the fixing tape before inserting the staple cartridge.
- Ensure that the staples are securely fixed. Push the cartridge until it clicks in place.

### 6 Remove the tape that fixes the staples by pulling it straight.

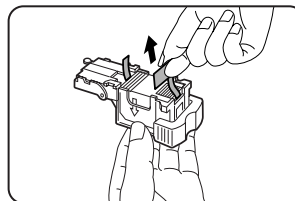

### 7 Insert the staple box.

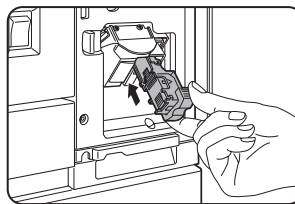

Push the staple box until it clicks into place.

### 8 Unlock the staple unit lever and return the staple unit to face down.

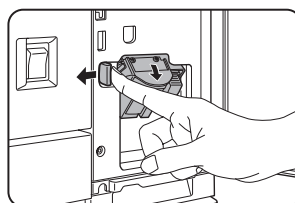

### 9 Close the front cover.

#### NOTE

Execute test printing in the staple sort mode to ensure that stapling is performed properly.

Staple cartridge replacement is now complete. Following steps 10 to 14 are the procedure for staple jam removal. These steps are not needed for staple cartridge replacement.



- 10** Remove the paper from the stapler compiler.

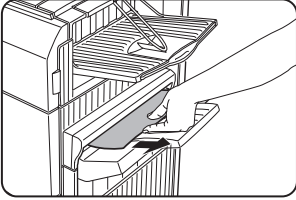

- 11** Raise the lever at the end of the staple box.

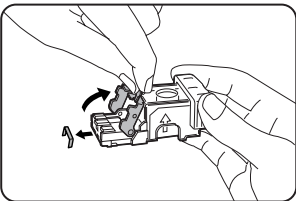

If the top staple is bent, be sure to cut it out. If bent staples remain, a staple jam may occur.

- 12** Return the lever to its original position.

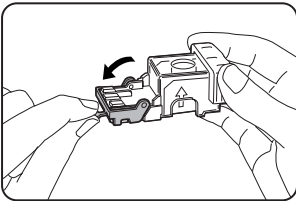

- 13** Insert the staple box.

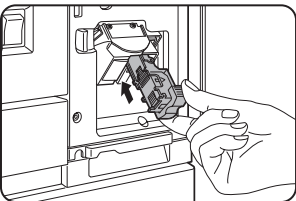

Push the staple box until it clicks into place.

- 14** Unlock the staple unit lever and return the staple unit to face down.

- 15** Close the front cover.

**NOTE**

Execute test printing in the staple sort mode to ensure that stapling is performed properly.

## Misfed in the finisher

When a misfeed has occurred in the finisher during printing, remove the misfed paper following the procedure below.

- 1** Remove the misfed paper from the stapler compiler.

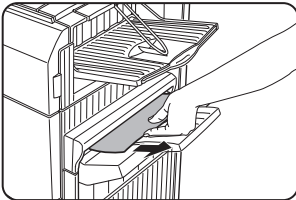

Be careful not to tear the misfed paper during removal.

- 6** Open the paper guide and remove the misfed paper.

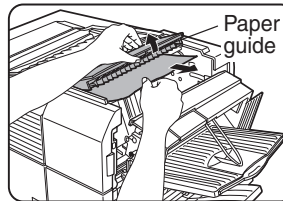

Be careful not to tear the misfed paper during removal.

- 2** Open the top cover.

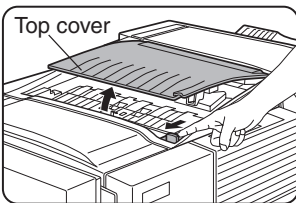

Move the tab in the direction of the arrow as shown in the illustration to open the top cover.

- 7** Close the finisher.

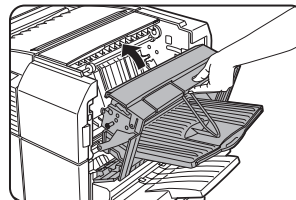

- 3** Remove the misfed paper.

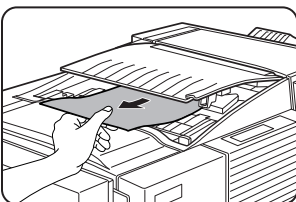

Be careful not to tear the misfed paper during removal. After removing the paper, press down on the top cover to close it.

- 4** Open the finisher.

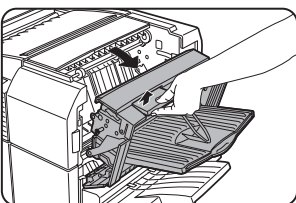

Hold the knob and open the finisher.

- 5** Remove the misfed paper.

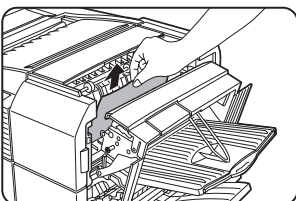

Be careful not to tear the misfed paper during removal.

## Troubleshooting (concerning the finisher)

Check the list below before contacting the SHARP Service Center.

Problem	Solution	
Stapling position is not correct.	Stapling position not set properly in the stapling setting?	Check the stapling position setting. (See page xx.)
The finisher does not operate.	The finisher is open or the top cover, front cover or paper guide of the finisher open?	Close all covers. (See pages xx and xx.)
	Message indicating need to remove paper from the stapler compiler displayed?	Remove all paper from the stapler compiler following the procedure described in step 1 on page xx.
Stapling cannot be performed.	Message requesting check for the staple unit displayed?	Remove jammed staples. (See page xx.)
	Message requesting adding staples displayed?	Replace the staple cartridge. (See page xx.)
	Different size paper included?	Stapling cannot be performed onto different size paper.
	Paper heavily curled?	Paper may be curled heavily depending on the paper type and quality. Remove paper from the paper tray or the bypass tray, turn it upside down, and load it again.

**Stapling position quick reference list**

When stapling is performed, the orientation of image data or original is related to the stapling position, binding position and orientation of paper complicatedly. The table below shows the relation.

		Image data or original			Result	
		First page (front side)	Second page (reverse side)	Two sides	One-position stapling	Two-position stapling
Portrait orientation printing	Left binding					
	Top binding					Two-position stapling with top binding cannot be made.
	Right binding					
Landscape orientation printing	Left binding					Two-position stapling with left binding cannot be made.
	Top binding					
	Right binding					Two-position stapling with right binding cannot be made.

■ ■ ■ indicates stapling positions.

**NOTES**

- When using the stapling function, select the offset tray as an exit tray. If another tray is selected, the stapling function cannot be used.
- Select only one paper size. If different sizes are included, stapling cannot be performed.

**NOTE**

The following types of paper cannot be stapled.  
Pre-punched paper, transparency film, heavy paper, label, envelope, postcard

# SADDLE STITCH FINISHER

If the saddle stitch finisher is installed, the offset function that stacks each set offset and the saddle stitch function that staples automatically at the center of paper and folds paper in two can be used. Also punching can be performed on printed paper if a punch unit is installed as a peripheral unit.

## Part names

### Stapler compiler

Paper to be stapled is stacked temporarily.

### Offset tray

The offset function and the stapling function can be used only in this tray. Facsimile output is delivered to this tray.

### Saddle stitch book tray

Paper on which saddle stitch has been made is output here.

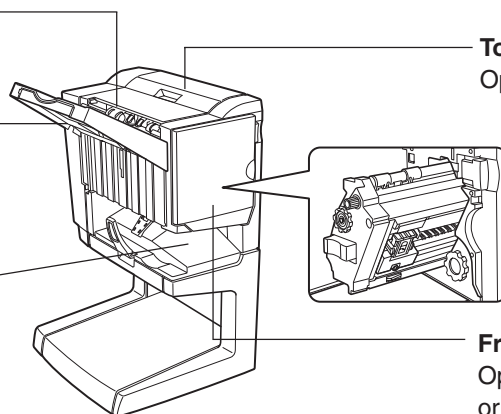

### Top cover

Open for misfeed removal.

### Stapler section

Open the front cover and pull out this section to replace the staple cartridge or to remove jammed staples.

### Front cover

Open to replace the staple cartridge or to remove jammed staples.

## NOTES

- Do not put pressure on the saddle stitch finisher (particularly each tray).
- Be careful about the offset tray during printing because the tray moves up and down.
- Some other peripheral units may be needed for installation of the saddle stitch finisher and some peripheral units cannot be installed together with the saddle stitch finisher. For combination of the peripheral units, see the list of combination of peripheral units on page xxxx.

## Specifications

Name	Saddle stitch finisher
Number of trays	2
Exit system	Print face down
Tray type	Upper tray: offset tray, Lower tray: saddle stitch book tray
Paper capacity	Upper tray: 1,000 sheets (8-1/2" x 11" or A4 size, 20 lbs. or 80 g/m <sup>2</sup> ) or 500 sheets (8-1/2" x 14" or B4 size or larger, 20 lbs. or 80 g/m <sup>2</sup> ), Lower tray:
Paper size	Upper tray: max. 11" x 17" or A3, min. 5-1/2" x 8-1/2"R or A5R Lower tray: max. 11" x 17" or A3, min. 8-1/2" x 11"R or A4R
Paper weight	Upper tray: 15 to 54 lbs. or 56 to 205 g/m <sup>2</sup> Lower tray: 17 to 34 lbs. or 64 to 128 g/m <sup>2</sup>
Paper type	Upper tray: same as the specifications of paper for feeding in the main unit Lower tray:
Paper limit detection	Provided in the upper tray only
Offset function	Provided in the upper tray only, offset amount: xx inch (xx mm)
Paper size for stapling	Upper tray: 11" x 17", 8-1/2" x 14", 8-1/2" x 13", 8-1/2" x 11", 8-1/2" x 11"R, A3, B4, A4, A4R, B5, and B5R Lower tray: 11" x 17", 8-1/2" x 11"R, A3, B4, and A4R
Stapling capacity	8-1/2" x 11" or A4 or smaller size: 50 sheets*(20 lbs. or 80 g/m <sup>2</sup> ) 8-1/2" x 14" or B4 or larger size: 25 sheets*(20 lbs. or 80 g/m <sup>2</sup> ) *Up to two sheets of 34 lbs. or 128 g/m <sup>2</sup> paper can be included as covers.

# SADDLE STITCH FINISHER

Name	Saddle stitch finisher
Stapling position	Upper tray: two types (one at rear, one at front) Lower tray: 4-47/64" (120 mm) pitch from the center of paper
Reference paper position	Center
Power supply	Drawn from the power supply unit (peripheral unit)(See page xx.)
Dimensions	xx-x/x" (W) x xx-x/x" (D) x xx-x/x" (H) (xxx mm (W) x xxx mm (D) x xxx mm (H))
Weight	Approx. xxx lbs. (xx kg)
Name	Punch module
Number of punch holes/ hole diameter	2 holes/x-x/x" or xx mm
Hole pitch	x-x/x" or xx mm
Punching capacity	xx sheets

Specifications are subject to change for improvement without notice.

## Supplies

For the saddle stitch finisher, the following staple cartridge is needed as supplies.

- Staple cartridge (Approximately 2,000 staples x x)  
xxxx

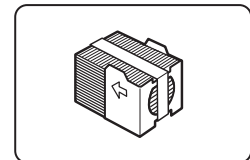

## Saddle stitch finisher functions

### ■ Sort mode

Each set will be sequentially printed and delivered.

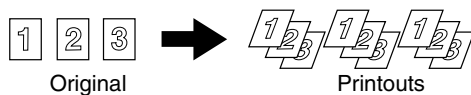

### ■ Group mode

All copies of the same page will be grouped.

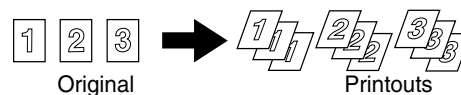

### ■ Offset mode

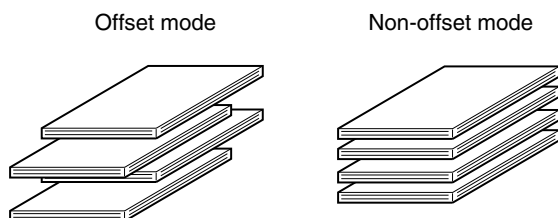









The offset tray moves from side to side so that each set is offset from the previous set and each set can be easily taken out. (The offset function operates only in the offset tray.)

When the staple sort function is selected, the offset function will not operate.

## ■ Staple sort mode

Collated sets of printouts are stapled and delivered to the offset tray. Alternatively, printed paper is stapled at the center and delivered to the lower tray. The relation among stapling positions, orientation, paper size for stapling, and stapling capacity is shown below.

Stapling positions	Portrait orientation		Landscape orientation	
Rear corner of printouts		Available paper sizes: 8-1/2" x 11", A4 and B5 Stapling capacity: Up to 50 sheets for any sizes		Available paper sizes: 11" x 17", 8-1/2" x 14", 8-1/2" x 13", 8-1/2" x 11", A3, B4, A4, A4R, and B5 Stapling capacity: Up to 50 sheets for 8-1/2" x 11", A4 and B5, and up to 25 sheets for other sizes
Center left two positions of printouts		Same as above		Same as above
Front corner of printouts		Same as above		Same as above
Saddle stitch		N/A		Available paper sizes: 11" x 17", 8-1/2" x 11"R, A3, B4, and A4R Stapling capacity: Up to xx sheets for any sizes

5

## ■ Saddle stitch function

Printed paper is stapled at two positions at the center and is folded in two with the center down before delivery.

<Example>

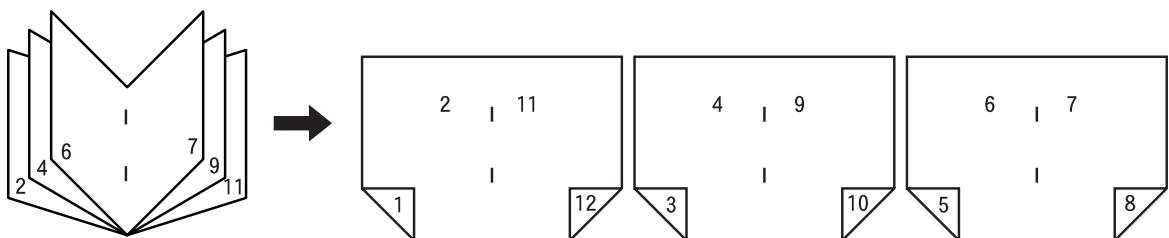

## ■ Punch function (only if a punch module is installed)

If the saddle stitch finisher is equipped with a punch module as a peripheral unit, printed paper can be punched (two holes) and delivered to the offset tray. The saddle stitch function and the punch function cannot be used together.

<Example>

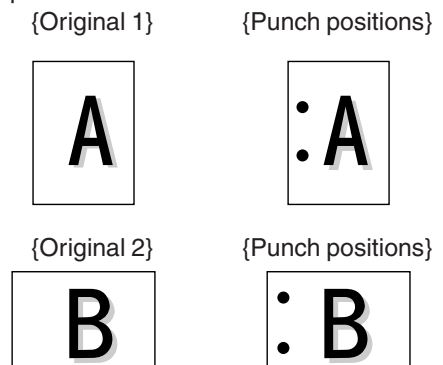

## Using the saddle stitch finisher functions

### ■ Using the stapling function or saddle stitch function from the printer feature

When using the stapling function, select "Properties" on the printer driver setting screen, open the "Main" tab shown in the right illustration, and then select "Left", "Right" or "Top" at Binding Edge and "1 Staple" or "2 Staples" at "Staple".

When using the saddle stitch function, check the radio button of "Pamphlet Style" at Document Style and select "2 Staples" at "Staple" of "Finishing".

### ■ Using the punch function with a punch module installed as a peripheral unit

Open the "Main" tab and check "Punch" at "Finishing".

The illustration below shows the screen for a PCL printer driver in the Windows 98 environment.

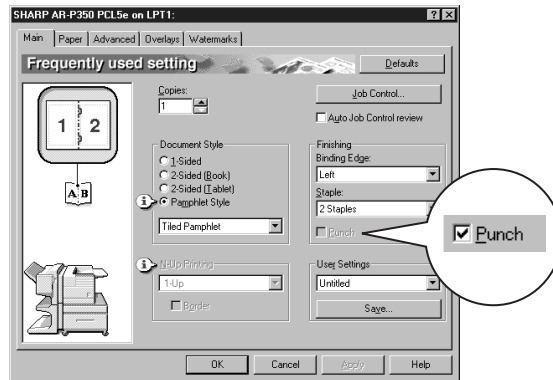

#### NOTES

- For the settings above, installation of peripheral units must have been set properly in the properties of the printer driver (see NOTE on page 2-5).
- Depending on the combination of paper selection and functions, the desired setting may not be possible. For details of setting items, see the printer driver help. The details of the functions are described.

### ■ Using the finisher functions in the copy mode

If you touch the [OUTPUT] key on the copy mode basic screen, a screen for selecting the sort/group/staple functions and selecting an exit tray will appear.

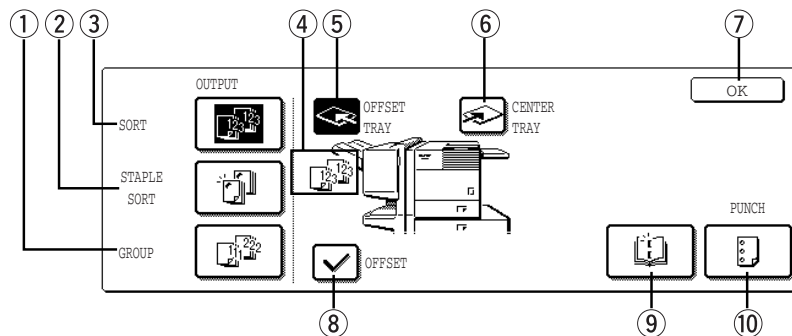

- ① [GROUP] key (See page xx.)  
If this function is selected, all copies of the same original will be grouped.
- ② [STAPLE SORT] key (See page xx.)  
If this function is selected, sorted copies will be stapled and delivered to the offset tray. (not offset stacked)
- ③ [SORT] key (See page xx.)  
If this function is selected, each set of copies will be sequentially delivered.
- ④ Icon display  
The icon of the selected function (sort, staple sort, group, saddle stitch or punch(only if the punch module is installed)) is displayed.
- ⑤ [OFFSET TRAY] key (See page xx.)  
If the offset tray is selected, printed sheets will be delivered to the offset tray. (If the staple sort function is selected, the offset tray will be automatically selected.)
- ⑥ [CENTER TRAY] key  
If the center tray is selected, printed paper will be delivered to the exit tray located at the upper part of the main unit.



- ⑦ [OK] key  
Press to close this screen and to return to the basic screen.
- ⑧ [OFFSET] key (See page xx.)  
If this function is selected (checked), the offset function will be enabled. If the check mark is cleared, the offset function will be disabled. (If the staple sort function is selected, the check mark of the offset function will be automatically cleared.)

- ⑨ [SADDLE STITCH] key (See page xx.)  
Printed paper will be stapled at the center and folded in two with the center down. If this function is selected, the pamphlet copy function (see page xx of the copier operation manual) will be automatically set.
  - ⑩ [PUNCH] key (See page xx.)  
If a punch module is installed, printed paper can be punched.
- \* If a function is selected, the corresponding key will be highlighted.

## Staple cartridge replacement and staple jam removal

When the staple cartridge is empty or staples become jammed, a message will appear in the message display of the operation panel.

Follow the procedure below to replace the staple cartridge or remove jammed staples.

### ■ Staple cartridge replacement

#### 1 Open the front cover.

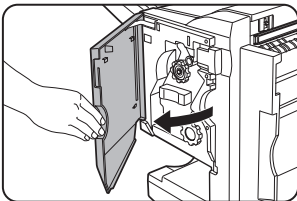

#### 2 Pull out the stapler section.

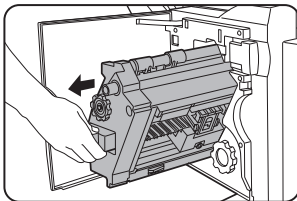

#### 3 Turn roller rotating knob A in the direction of the arrow to move the staple unit to your side.

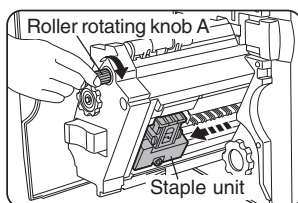

#### 4 Remove the empty staple box.

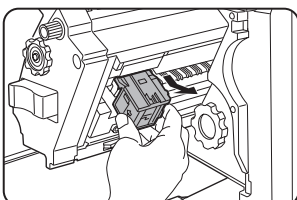

#### 5 Remove the empty staple cartridge.

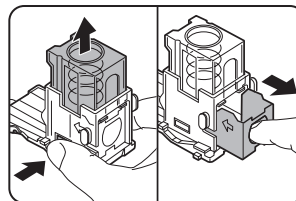

Press the lock button to unlock the staple box cover and remove the staple cartridge.

5

#### NOTE

If staples remain, the staple cartridge cannot be removed.

#### 6 Insert a new staple cartridge into the staple box.

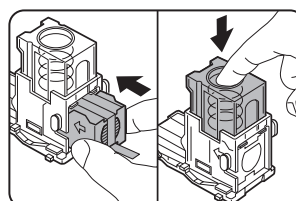

After inserting the staple cartridge, press down on the staple box cover to lock the cartridge.

#### NOTES

- Do not remove the fixing tape before inserting the cartridge.
- Ensure that the staples are securely fixed. Push the cartridge until it clicks in place.

#### 7 Remove the tape that fixes the staples by pulling it straight.

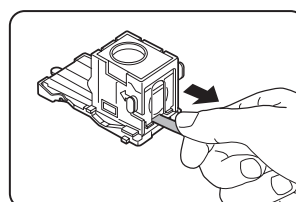

# SADDLE STITCH FINISHER

## 8 Insert the staple box.

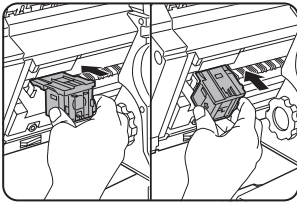

Push the staple box until it clicks into place.

## 9 Push back the stapler section.

### ■ Staple jam removal

## 1 Open the front cover.

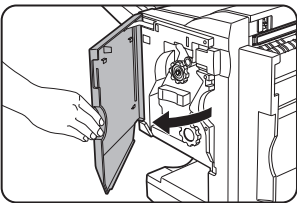

## 2 Turn roller rotating knob C as shown in the illustration until a blue indication is seen.

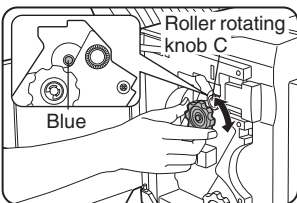

## 3 Remove the paper from the stapler compiler.

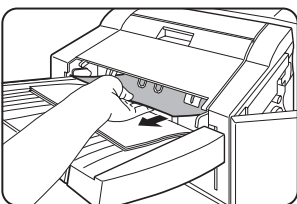

## 4 Open the saddle stitch section cover (when the saddle stitch function is used).

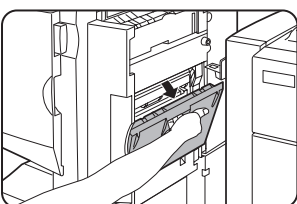

## 10 Close the front cover.

### NOTE

Execute test printing in the staple sort mode to ensure that stapling is performed properly.

## 5 Remove the misfed paper.

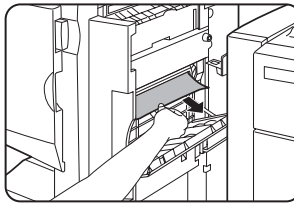

## 6 Close the saddle stitch section cover.

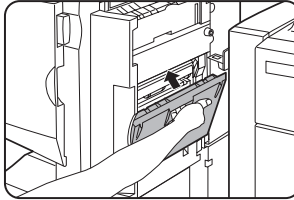

## 7 Open the saddle stitch section cover (when the saddle stitch function is used).

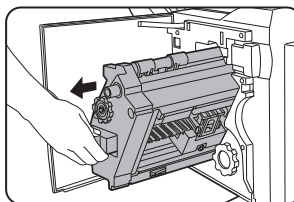

## 8 Turn roller rotating knob A in the direction of the arrow to move the staple unit to your side.

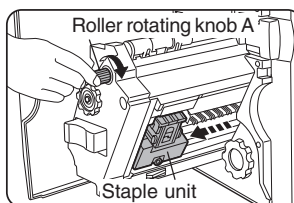

## 9 Remove the staple box.

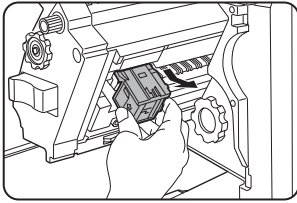

## 10 Raise the lever at the end of the staple box.

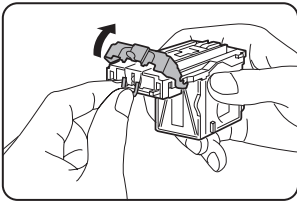

If the top staple is bent, be sure to cut it out. If bent staples remain, a staple jam may occur.

## 11 Return the lever to its original position.

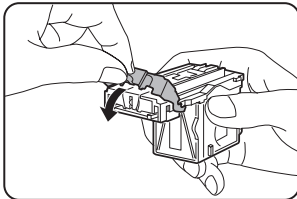

### ■ Punch scrap disposal

## 1 Pull the knob and slide the saddle stitch finisher away from the main unit.

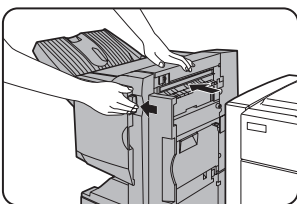

## 2 Pull out the punch scrap collecting container and remove the punch scraps.

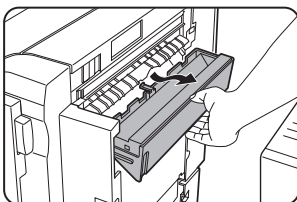

Be careful not to scatter punch scraps. Put them in a plastic bag or the like for disposal.

## 12 Insert the staple box.

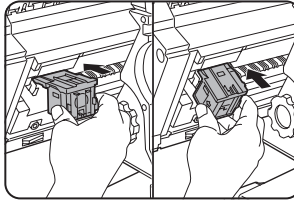

Push the staple box until it clicks into place.

## 13 Push back the stapler section.

## 14 Close the front cover.

### NOTE

Execute test printing in the staple sort mode to ensure that stapling is performed properly.

## 3 Return the punch scrap collecting container to its original position.

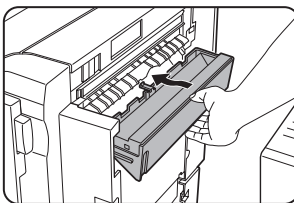

## 4 Push the saddle stitch finisher to the main unit.

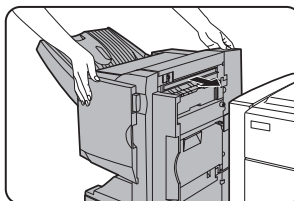

## Misfeed in the saddle stitch finisher

If a misfeed has occurred in the saddle stitch finisher during printing, remove the misfed paper following the procedure below.

- 1** Pull the knob and slide the saddle stitch finisher away from the main unit.

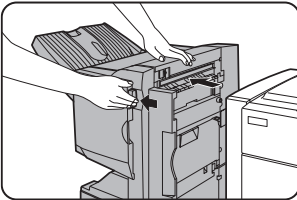

- 2** Remove the misfed paper from the main unit.

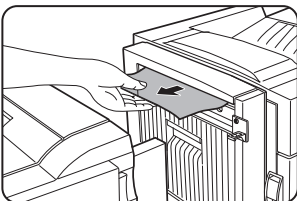

- 3** If misfed paper is not found in step 1, open the top cover.

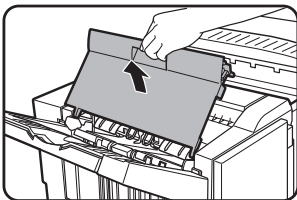

- 4** Turn roller rotating knob B until the triangle mark reaches the position indicated in the illustration (only if a punch module is installed as a peripheral unit).

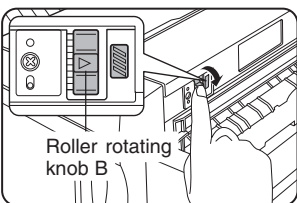

- 5** Remove the misfed paper.

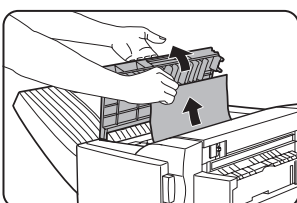

Be careful not to tear the misfed paper during removal.

- 6** Close the top cover.

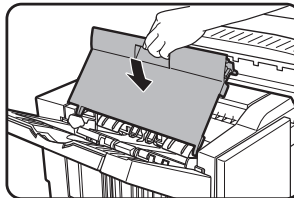

- 7** Open the front cover.

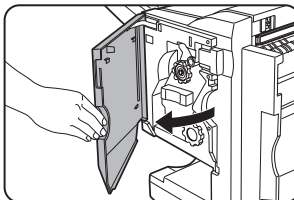

- 8** Turn roller rotating knob C until a blue indication is seen (when the stapling function has been used).

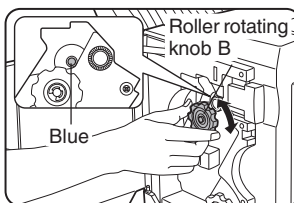

- 9** Remove the misfed paper from the stapler compiler (when the stapling function has been used).

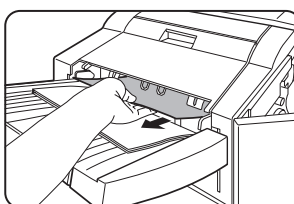

Be careful not to tear the misfed paper during removal.

- 10** Open the saddle stitch section cover (when the saddle stitch function has been used).

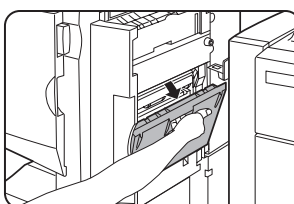

## 11 Remove the misfed paper.

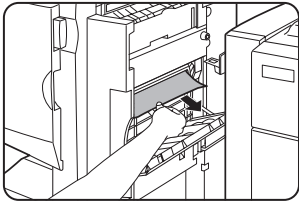

Be careful not to tear the misfed paper during removal.

## 12 Turn roller rotating knob D in the direction of the arrow.

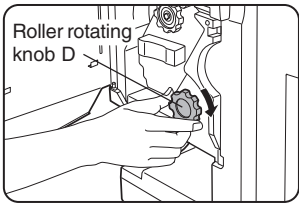

## 13 Turn roller rotating knob D in the direction of the arrow.

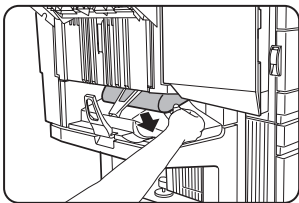

Be careful not to tear the misfed paper during removal.

## 14 Close the saddle stitch section cover.

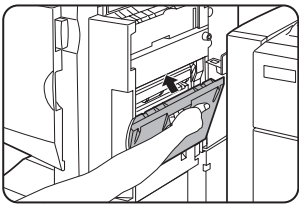

## 15 Push the saddle stitch finisher to the main unit.

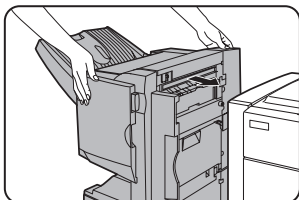

## Troubleshooting (concerning the saddle stitch finisher)

Check the list below before contacting the SHARP Service Center.

Problem	Solution	
Stapling position is not correct (including saddle stitch).	●Stapling position not set properly in the stapling setting?	Check the stapling position setting. (See page xx.)
The saddle stitch finisher does not operate.	●The top cover or the front cover of the saddle stitch finisher open?	Close all covers. (See pages xx and xx.)
	●Message indicating need to remove paper from the stapler compiler displayed?	Remove all remaining paper from the stapler compiler referring to step 3 on page xx.
Stapling cannot be performed (including saddle stitch).	●Message requesting check for the staple unit displayed?	Remove jammed staples. (See page xx.)
	●Message requesting adding staples displayed?	Replace the staple cartridge. (See page xx.)
	●Different size paper included?	Stapling cannot be performed onto different size paper.
	●Paper heavily curled?	Paper may be curled heavily depending on the paper type and quality. Remove paper from the paper tray or the bypass tray, turn it upside down, and load it again.
Punch position is not proper.*1	●Punch function set properly in accordance with the punch position?	Check the punch position and set it again. (See page xxxx.)
Cannot be punched.*1	●Message requesting check for punch module displayed?	Dispose of punch scraps. (See page xxxx.)
	●Different size paper included?	Punching cannot be performed onto different size paper.
	●Paper heavily curled?	Paper may be curled heavily depending on the paper type and quality. Remove paper from the paper tray or the bypass tray, turn it upside down, and load it again.
Not properly arranged if the saddle stitch function is used in the copy mode.	●Pamphlet copy set?	Set the pamphlet copy function and then perform saddle stitch.

\*1 When a punch unit is installed as a peripheral unit

## Stapling position quick reference list











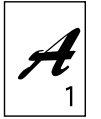

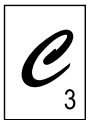

When stapling is performed, the orientation of image data or original is related to the stapling position, binding position, and orientation of paper complicatedly. The table below shows the relation.

		Image data or original			Result	
		First page (front side)	Second page (reverse side)	Two sides		
Portrait orientation printing	Left binding				One-position stapling 	Two-position stapling 
	Top binding				One-position stapling 	Two-position stapling  Two-position stapling along the shorter edge cannot be made.
	Right binding				One-position stapling 	Two-position stapling  Two-position stapling along the shorter edge cannot be made.
Landscape orientation printing	Left binding				One-position stapling 	Two-position stapling  Left binding with two-position stapling cannot be made.
	Top binding				One-position stapling 	Two-position stapling  Two-position stapling along the shorter edge cannot be made.
	Right binding				One-position stapling 	Two-position stapling  Right binding with two-position stapling cannot be made.

■ ■ ■ indicates stapling positions.

## Relation between print image and saddle stitch

When saddle stitch is performed, the orientation of image data or original is related to the orientation of paper complicatedly. The table below shows the requirements of the image and the saddle stitch.

		Image data or original			Result
Portrait orientation printing	Left binding	First page (front side) 	Second page (reverse side) 	Two sides 	
		Third page (front side) 	Fourth page (reverse side) 	Two sides 	
	Right binding	Same as above			
Landscape orientation printing		First page (front side) 	Second page (reverse side) 	Two sides 	
		Third page (front side) 	Fourth page (reverse side) 	Two sides 	

### NOTES

- Required settings for the illustration above are shown below.
  - \* Available paper sizes are 11" x 17", 8-1/2" x 14", 8-1/2" x 13", 8-1/2" x 11", A3, B4, A4, and B5 (stapling capacity is up to 50 sheets for 8-1/2" x 11", A4 and B5, and up to 25 sheets for other sizes).
  - \* Portrait orientation or landscape orientation must be selected.
- Select only one paper size. If different sizes are included, stapling cannot be performed.

### NOTE

Stapling cannot be performed onto the following types of paper.  
 Pre-punched paper, transparency film, heavy paper, label, envelope, Japanese postcard





# CHAPTER 6

---

## KEY OPERATOR PROGRAMS

---

This chapter describes operation of the key operator programs for use by the key operator. Please read this chapter thoroughly for proper use of these programs.

	Page
KEY OPERATOR PROGRAMS .....	6-2
● Key operator program list .....	6-2
● Using the key operator programs .....	6-3
● Description of setting programs .....	6-7

# KEY OPERATOR PROGRAMS

This chapter describes the operation method of the key operator programs concerning the printer feature and the programs common to all features including the copier feature and the facsimile feature. These programs are provided for use by the key operator of this product. For key operator programs specific to the copier feature, facsimile feature, and network scanner feature, see the respective operation manuals. The key operator programs can only be accessed after a key operator code number has been entered.

The titles displayed on the touch panel are shown with { }.

## NOTE

Depending on the main unit model and installation of peripheral units, some key operator programs cannot be used.

## Key operator program list

Program name	Page		
<b>Auditor settings</b>		<b>System settings</b>	
Auditing mode	xxxx	Default settings	
Print per account {Total pages per account}	xxxx	Print density level	xxxx
Reset account {Resetting account}	xxxx	Disable notice page printing	xxxx
Account number control	xxxx	Disable test page printing	xxxx
No print if account # invalid	xxxx	A4/letter auto select	xxxx
<b>Energy save</b>		<b>Interface settings</b>	
Auto power shut-off timer	xxxx	Hexadecimal dump mode	xxxx
Preheat mode	xxxx	PDL for parallel port	
Toner save		{Parallel port emulation switching}	xxxx
{Toner save in printer mode}	xxxx	PDL for network port	
Auto power shut-off	xxxx	{Network port emulation switching}	xxxx
<b>Operation panel settings</b>		I/O timeout	xxxx
Auto clear setting	xxxx	Port switching	xxxx
Message display time	xxxx	<b>Network settings</b>	
Language setting	xxxx	IP address setting	xxxx
{Beep setting}	xxxx	IP subnet mask	xxxx
{Disabling of job priority operation}	xxxx	IP gateway	xxxx
<b>Device settings</b>		Enable TCP/IP	xxxx
Disable duplex unit	xxxx	Enable NetWare	xxxx
Disable stapler unit	xxxx	Enable EtherTalk	xxxx
Disable paper desk drawers	xxxx	Enable NetBEUI	xxxx
Disable finisher	xxxx	Reset the NIC	xxxx
Disable mail-bin stacker	xxxx	<b>Initialize/store settings</b>	
Saddle stitch adjust	xxxx	Restore factory defaults	xxxx
Print key operator program list	xxxx	Store current configuration	xxxx
Key operator code change	xxxx	Restore configuration	xxxx
		Product key	xxxx

## Using the key operator programs

Use the following procedure to use the key operator programs.

**NOTE**

When using the key operator programs for the first time, register a key operator code number (password required for using the key operator programs). (See steps 3 and 5 below or see steps 3 and 5 on page 7-5.)

\* When using the operation panel with touch panel, see page xxxx.

### When using the operation panel on the main unit:

**1** Press the [MENU] key.

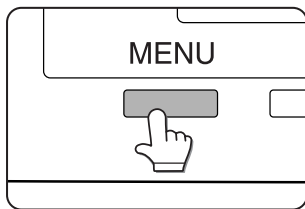

Press the [MENU] key repeatedly until the message "KEY OPERATOR PROGRAMS" appears.

KEY OPERATOR PROGRAMS

**2** Press the [OK] key.

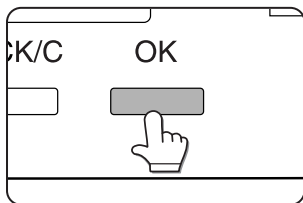

KEY OPERATOR CODE  
○\*\*\*\*

If the [OK] key is pressed, the message shown to the left will appear.

**3** Enter the fifth digit of the password and press the [OK] key.

KEY OPERATOR CODE  
○\*\*\*\*

For the factory default setting of the key operator code number (password), see page xxxx.

If you press the [OK] key to register the fifth digit after entering it using the ▲ or ▼ key on the operation panel, "0" will appear at the fourth digit. If you press the [BACK/C] key, you can correct the entered number.

**4** Use the same procedure as step 3 to enter the password from the fourth digit to the first digit and then press the [OK] key.

KEY OPERATOR CODE  
\*○\*\*\*

Use the same procedure as above (fifth digit) to enter the fourth digit to the first digit.

**5** Press the [▲] or [▼] key to select the desired program and press the [OK] key.

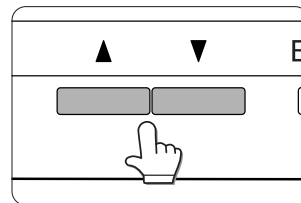

<Example>

For registration of a key operator code number, select "KEY OPERATOR CODE CHANGE" and press the [OK] key.

**6** Press the [▲] or [▼] key to select the desired item.

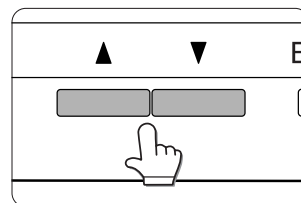

For settings of each program, see the details of classification of setting items (hierarchical structure) and supplementary explanation of key operation on and after page xxxx.

**7** To exit the program, press the [MENU] key.

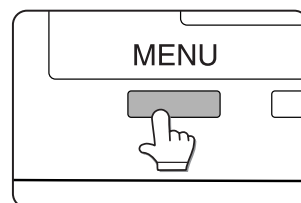

## Details of classification of setting items (hierarchical structure) and supplementary explanation of key operation (when using the operation panel on the main unit)

The setting operation of key operator programs are classified (hierarchical structure) as shown below. If you complete a program or if you press the [BACK/C] key to cancel a program, the display one level higher will appear. [C] displayed in messages indicates the [BACK/C] key.

If you press the [▲] or [▼] key, the display will move to another item on the same level. If a mistake is made in selection of a number, press the [BACK/C] key to correct it. If you press the [OK] key to complete program setting, "\*" will be added to the message.

The display in ( ) shows the factory default setting.

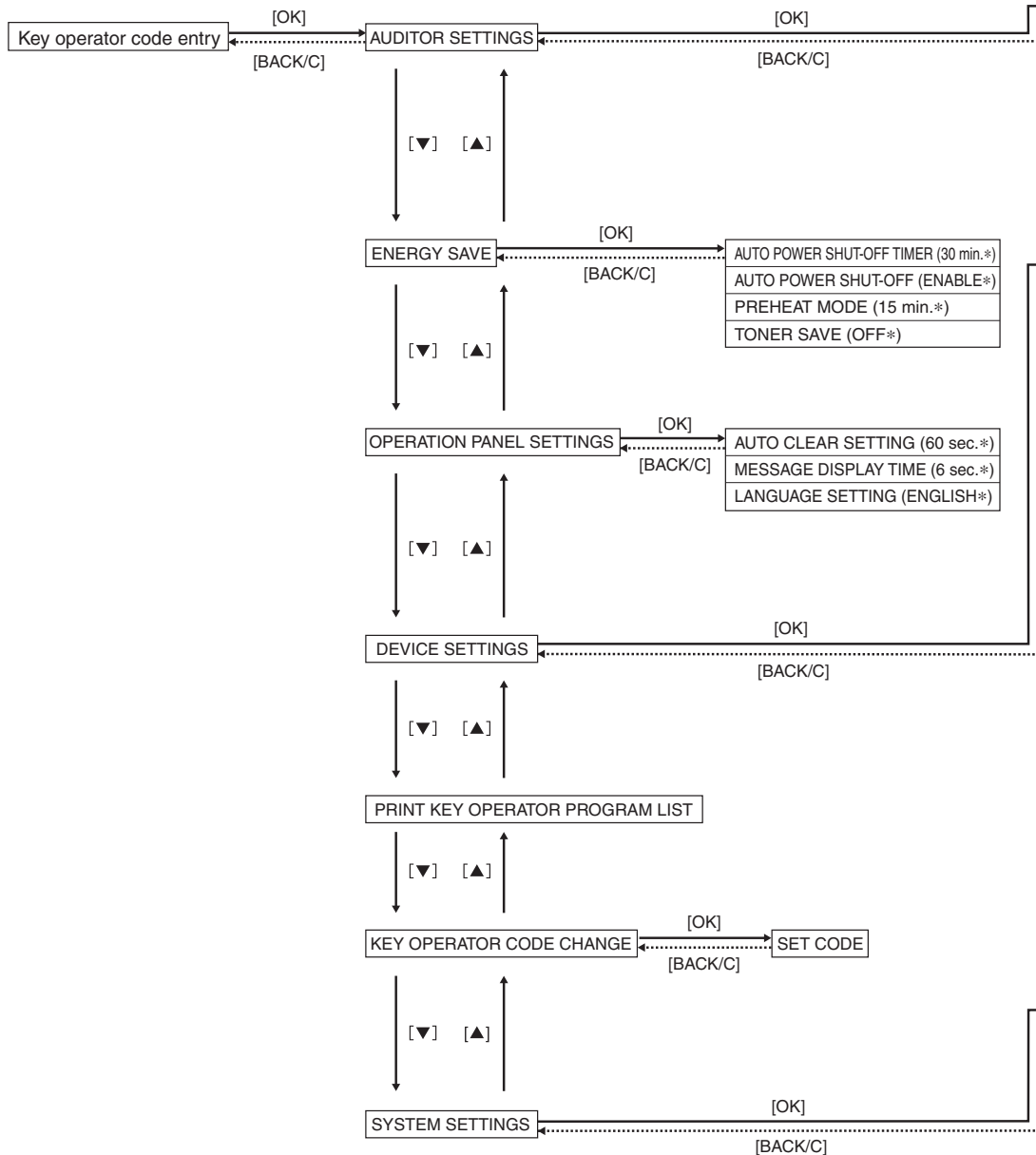

### NOTE

To exit the key operator program, press the [MENU] key on the operation panel.

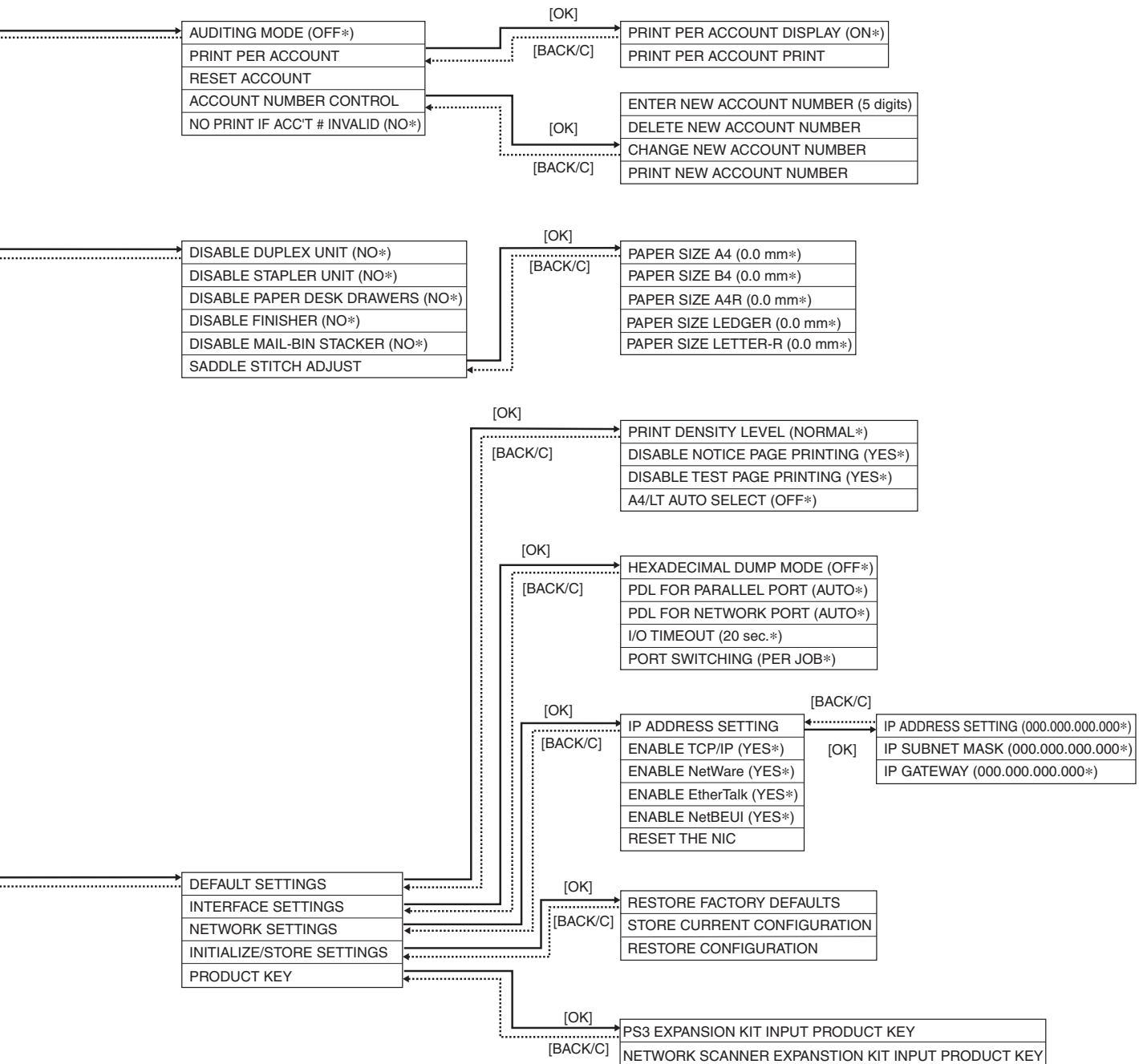

# KEY OPERATOR PROGRAMS

When using the operation panel with touch panel:

**1** Press the [CUSTOM SETTINGS] key.

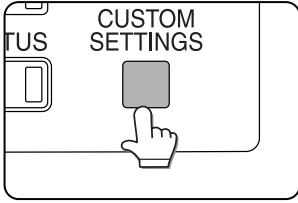

**2** Touch the KEY OPERATOR PROGRAMS key.

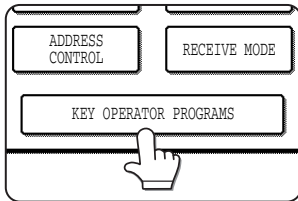

**3** Use the numeric keys to enter the five-digit password.



Each time a number is entered, the dashes (-) in the display will change to asterisks (\*). For the factory default setting of the key operator code number (password), see page xxxx.



**4** Touch the key of the desired category of the key operator programs.

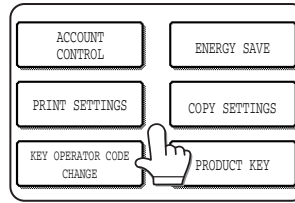

<Example>

For registration of the key operator code number, touch "KEY OPERATOR CODE CHANGE".

**5** Press the [CUSTOM SETTINGS] key.

For details of each program, see the description on and after the next page.

**6** Press the [CUSTOM SETTINGS] key.

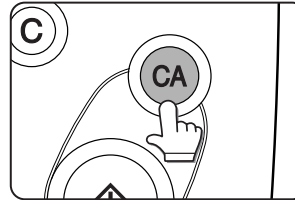

## Supplementary explanation of key operation for key operator programs

(when using the operation panel with touch panel)

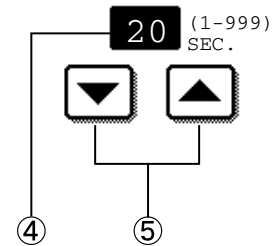
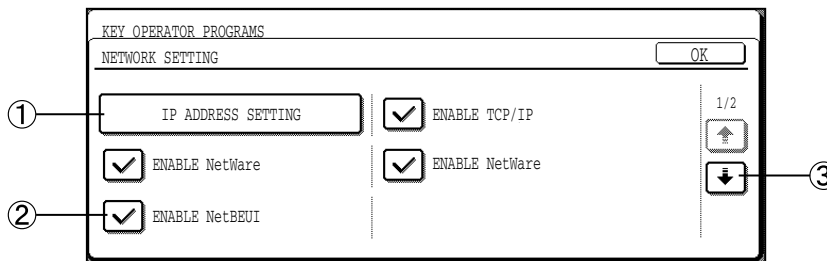

- ① If  is displayed as an item, the setting screen will be displayed by touching the key.
- ② If  is displayed to the left of an item, a check mark (✓) will be displayed by touching  and the program will be set. If you touch  when a check mark (✓) has been already displayed, the check mark will be cleared and the setting will be canceled.
- ③ If the setting items are displayed on multiple screens, the screen can be switched by touching the [↑] or [↓] key. If you touch the [EXIT] key, the previous screen will appear again.
- ④ The number that has been set is displayed.
- ⑤ Numbers can be set by touching the [▲] or [▼] key.

## Description of setting programs

This section describes the setting programs concerning the printer feature and the programs common to all features including the copier feature and facsimile feature. The following description is made assuming that the operation panel on the main unit is used. The difference of the title display and supplementary explanation for the operation panel with touch panel are indicated with {}.

For programs specific to the copier feature, facsimile feature, and network scanner feature, and additional programs, see their respective manuals.

### Auditor settings

In the "Auditor settings", the following items can be set.

- Auditing mode
- Print per account [Total pages per account]
- Reset account {Resetting account}
- Account number control
- No print if account # invalid {Cancel jobs of invalid accounts}

### Auditing mode

If the auditing mode is set, the number of prints, etc. can be counted for up to 100 accounts, and the count can be displayed as needed. If the auditing mode has been set, An account number (five-digit password) that has been registered must be entered before printing.

#### [When using the operation panel with touch panel:]

An account number must be entered for scanning originals when using the copier feature, facsimile feature, and network scanner feature.

The following functions cannot be used unless the auditing mode is set and account numbers are registered.

- Print per account {Total pages per account}
- Reset account {Resetting account}

### Print per account {Total pages per account}

This program is used to display or print the total number of prints against each account number. Misfed paper is not counted.

#### [When using the operation panel with touch panel:]

When using the facsimile feature and network scanner feature, the original transmission count can be displayed or printed.

### \*1 Reset account {Resetting account}

This program is used to reset audit accounts.

#### [When using the operation panel with touch panel:]

When using the facsimile feature and the network scanner feature, this program can be used to reset the original transmission count.

### \*1 Account number control

This program is used to register, delete or change account numbers for the printer and to print the list of the account numbers. Up to 100 account numbers can be registered.

- The number of digits of account numbers is five. When registration of one account is complete, another account number can be registered continuously.
- For deletion, a single account can be selectively deleted or all accounts can be deleted at a time.
- To change an account number, enter the account number to be changed and then enter a new account number. When operation for one account is complete, another account number change can be performed continuously. If an account number that has not been registered is entered as an old account number, new account number entry cannot be performed.

### No print if account # invalid {Cancel jobs of invalid accounts}

If the auditing mode is set and this program is set, when an invalid account number is entered or no account number is entered on the computer, printing will not be executed. If this program is not set, printing will be executed and the number of prints in such case will be accumulated as item "OTHERS".

#### NOTE

For programs marked with \*1, a confirmation message for execution will appear at the end of operation procedure. When the operation panel on the main unit is used, execution of the program can be canceled by pressing the [BACK/C] key.

When the operation panel with touch panel is used, execution of the program can be canceled by touching the [CANCEL] or [NO] key.

### Energy save

#### Auto power shut-off timer

When a programmed length of time has elapsed without any operation after printing is complete, the printer enters the auto power shut-off mode to save power consumption at the maximum. This function lowers the user's electricity bill, reduces waste of natural resources, and cuts down on environmental pollution.

#### [When using the operation panel on the main unit:]

The time until auto power shut-off occurs can be set to 15 minutes, 30 minutes, 60 minutes, 120 minutes or 240 minutes.

#### [When using the operation panel with touch panel:]

The time until auto power shut-off occurs can be set in 1 minute increments up to 240 minutes.

#### NOTES

- We suggest you set the most appropriate time according to your usage pattern.
- If you use the program "Auto power shut-off" (described below) to disable the auto power shut-off mode, the time set with this program will be ignored.

#### Auto power shut-off

When a programmed length of time has elapsed without any operation after printing is complete, the printer enters the auto power shut-off mode to save power consumption at the maximum. This program is used to disable this function. If the auto power shut-off mode is disabled, the auto power shut-off time setting (described above) will be ignored. If you wish to disable the auto power shut-off mode for some reasons, use this program.

#### NOTE

Since we would like you to fully understand the purpose of this mode, we suggest that you enable this mode and set the most appropriate time using program "Auto power shut-off timer".

### Preheat mode

Preheat mode functions when a programmed length of time has elapsed without any operation after printing is complete. This function lowers the user's electricity bill, reduces waste of natural resources, and cuts down on environmental pollution.

We suggest you set the most appropriate time according to your usage pattern.

The time until the printer enters the preheat mode can be set in 1 minute increments up to 240 minutes.

### Toner save {Toner save in printer mode}

The toner save print will reduce toner consumption. If the toner save print is set, black solid areas will be printed in a halftone.

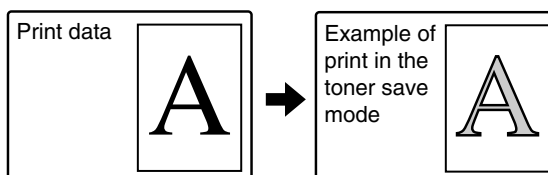

#### [When using the operation panel with touch panel:]

If you use the facsimile feature or copy feature, the toner save mode can be set for each feature. Toner consumption can be reduced by approximately 10%.



## Operation panel settings

### Auto clear setting

#### [When using the operation panel on the main unit:]

The machine will activate the auto clear function and return to the standby mode or the job status mode when a programmed length has elapsed without any operation on a setting screen. (When the printer is in the mode of the condition settings, custom setting or key operator programs, the auto clear function will not operate.)

The auto clear time can be set to 15 seconds, 30 seconds, 60 seconds or off.

#### [When using the operation panel with touch panel:]

When a programmed length has elapsed without any operation after a copy job is complete or while detailed information concerning the current job and reserved jobs or completed jobs is displayed, the machine will activate the auto clear function and return to the copy basic screen or the job status screen. The auto clear time can be set in 10 second increments up to 240 seconds. The auto clear function can be disabled. (Even if this function is disabled, however, the setting will not be applied to the fax mode.)

### Message display time

This program is used to adjust the time that messages are displayed (for messages that automatically disappear).

#### [When using the operation panel on the main unit:]

The time can be set to 3 seconds, 6 seconds, 9 seconds or 12 seconds.

#### [When using the operation panel with touch panel:]

The time can be set in 1 second increments up to 12 seconds.

### Language setting

This program is used to switch the language of messages displayed on the operation panel. The following languages can be selected.

English, French, and Spanish

### {Beep setting}

This program can be used only if the operation panel with touch panel is used.

Use this program to enable or disable the alarm beeps in the following cases. The alarm beeps are enabled in the default setting.

Key touch, completion of original scanning, facsimile reception, and communication error

Two levels of volume can be set.

### {Disabling of job priority operation}

This program can be used only if the operation panel with touch panel is used.

Use to disable priority job reservation to execute a job after the current job (print, copy or facsimile reception job).

## Device settings

These programs are used to disable use of a peripheral unit when it malfunctions or to prohibit use of it temporarily. Also these programs can be used for setting again the functions of peripheral units based on the usage patterns.

In "Device Settings", the following programs can be set.

- Disable duplex unit
- Disable stapler unit
- Disable paper desk drawers
- Disable finisher
- Disable mail-bin stacker
- Saddle stitch adjust

### Disable duplex unit

This program is used to disable duplex printing when the duplex module malfunctions. If this program is set, only one-sided printing can be performed.

### Disable stapler unit

This program is used to disable stapling when the stapler unit of the finisher or saddle stitch finisher malfunctions.

### Disable paper desk drawers

This program is used to disable use of the stand/3 x 500 sheet paper drawer or stand/MPD & 2000 sheet paper drawer when it malfunctions.

### Disable finisher

This program is used to disable use of the saddle stitch finisher or finisher when it malfunctions.

### Disable mail-bin stacker

This program is used to disable use of the mail-bin stacker when it malfunctions.

### Saddle stitch adjust

This program is used to adjust the stapling position (folding position) when using the saddle stitch function by installing a saddle stitch finisher.

The value can be adjusted in 0.1 mm increments within  $\pm 3.0$  mm from the reference position for each paper size.

{Max. +3 mm}	{Min. -3 mm}
{Position adjusted to the plus direction}	
{Position adjusted to the minus direction}	
{Reference position}	

## Print key operator program list

This program is used to print out the list of the key operator programs.

### [When using the operation panel with touch panel:]

Key operator programs of the copier feature, facsimile feature, and network scanner feature can be printed.

## Key operator code change

This program is used to change the key operator code number (password) from the factory default setting or from the number that has been set.

The key operator must register the key operator code number (password). The key operator code number must be entered to access the key operator programs. Only one key operator code number (password) can be input. For the factory default key operator code number (password), see page xxxx.

The key operator must detach the page and store it. Also be sure to remember the registered key operator code number (password).

## System settings (default settings)

These programs are used to adjust the settings of various printer functions from the factory default settings or to cancel the settings.

In "Default Settings", the following programs can be set.

- Print density level
- Disable notice page printing
- Disable test page printing
- A4/letter auto select

## Print density level

This program is used to adjust the lightness or darkness of documents in the print mode. The density level is adjusted in five levels.

### [When using the operation panel on the main unit:]

The print density level can be selected from the following items.

NORMAL, LIGHTEST, LIGHTER, DARKER, DARKEST

### [When using the operation panel with touch panel:]

Among the displayed numbers, a smaller value indicates lighter density and a larger value indicates a darker density.

## Disable notice page printing

This program is used to disable notice page printing. For notice page printing, see "Notice page printing" (appendix).

## Disable test page printing

This program is used to disable test page printing. If this program is set, printer test page printing in custom settings (page xxxx) cannot be executed.

## A4/letter auto select

If this program is set, when printing onto 8-1/2" x 11" size paper is instructed to the printer without 8-1/2" x 11" size paper installed, A4 size paper will be automatically selected in place of 8-1/2" x 11" paper. \* 8-1/2" x 11" paper cannot be automatically selected in place of A4.

### NOTE

When 8-1/2" x 11" size is specified in a document attached to an E-mail that has been transmitted from a foreign country and A4 size paper is not installed in the printer, printing cannot be executed immediately. If this program is set, printing will be executed without additional operation.



## System settings (network settings)

These programs are set when this product is used as a network printer.

In "Network Settings", the following programs can be set. After each program is set, exit the key operator program, turn off the main switch, and then turn on the main switch again after a while. The program that has been set will be effective at this time.

- IP address setting
- Enable TCP/IP
- Enable NetWare
- Enable EtherTalk
- Enable NetBEUI
- Reset the NIC

### NOTE

For setting and modification of "Network settings", be sure to consult with the network administrator.

## \*1 Reset the NIC

This program is used to reset all setting items of NIC (Network Interface Card, namely Print Server Card) of this product to the factory default settings.

### NOTE

For programs marked with \*1, a confirmation message for execution will appear at the end of the programs.

When the operation panel on the main unit is used, execution of the program can be canceled by pressing the [BACK/C] key.

When the operation panel with touch panel is used, execution of the program can be canceled by touching the [CANCEL] or [NO] key.

## IP address setting

When using this product in a network that uses the TCP/IP protocol, use this program to set the IP address (IP address, IP subnet mask, and IP gateway) of this product. When using this product in a network that uses the TCP/IP protocol, set also the program "Enable TCP/IP" below.

## Enable TCP/IP

When using this product in a network that uses the TCP/IP protocol, set this program. Also set the IP address using the program "IP address setting" above.

## Enable NetWare

When using this product in a network that uses the NetWare protocol, set this program.

## Enable EtherTalk

When using this product in a network that uses the EtherTalk protocol, set this program.

## Enable NetBEUI

When using this product in a network that uses the NetBEUI protocol, set this program.

## System settings (initialize/store settings)

The settings of the configuration settings (page xx) and the system settings of the key operator programs (pages xx to xx) can be reset to the factory default settings. Also the current settings can be stored to the memory and the stored settings can be recalled from the memory after the settings have been changed.

In "Initialize/Store Settings", the following programs can be set.

- Restore factory defaults
- Store current configuration
- Restore configuration

### \*1 Restore factory defaults

This program is used to reset the settings of the configuration settings (page xx) and the system settings (default settings/interface settings) of the key operator programs (pages xx to xx) to the factory default settings. If you wish to record the settings before resetting, use "List Print" of custom settings to print the settings before using this program.

#### NOTE

After this program is set, exit the key operator program, turn off the main switch, and then turn on the main switch again after a while. The program will be effective at this time.

### \*1 Store current configuration

Use this program to store the current settings of the configuration settings (page xx) and the system settings (default settings/interface settings) of the key operator programs (pages xx to xx) in the printer's nonvolatile memory. To recall the stored settings, use the program "Restore configuration" below.

### \*1 Restore configuration

Use this program to recall the configuration settings that have been stored in the printer's nonvolatile memory using the program "Store current configuration" above.

#### NOTE

If this program is executed when the setting of "Enable TCP/IP", "Enable NetWare", "Enable EtherTalk" or "Enable NetBEUI" has been changed, exit the key operator program, turn off the main switch, and then turn on the main switch again after a while. The program will be effective at this time.

#### NOTE

For programs marked with \*1, a confirmation message for execution will appear at the end of operation procedure. When the operation panel on the main unit is used, execution of the program can be canceled by pressing the [BACK/C] key.

When the operation panel with touch panel is used, execution of the program can be canceled by touching the [CANCEL] or [NO] key.

## System settings (product key)

Use these programs to perform product key (password) input operation in the following cases.

- To use this product as a PostScript compatible printer  
The password to be entered is described in the operation manual supplied with the optional PS3 expansion kit.
- To use the network scanner feature (only if the operation panel with touch panel is used)  
The password to be entered is described in the operation manual supplied with the network scanner expansion kit (peripheral unit).



# CHAPTER 7

---

## APPENDIX

---

This chapter describes detailed information of this product such as specifications.

	<b>Page</b>
<b>PRINTER SPECIFICATIONS</b> .....	7-2
● Specifications .....	7-2
● List of principal printer functions .....	7-3
<b>LIST OF COMBINATION OF PERIPHERAL UNITS</b> .....	7-4
<b>PRINT AREA</b> .....	7-6

# PRINTER SPECIFICATIONS

## Specifications

Model name	AR-P350/AR-P450
Type	Desktop
Print system	Electrophotographic system
Exposure system	Semiconductor laser diode system
Developer system	Magnetic brush development
Paper feed system	Paper trays
Fusing system	Heat roller
CPU	64 bit RISC, 167 MHz
Memory capacity (standard)	32 MB
DIMM slots for additional memory	One (64 MB to 256 MB memory can be mounted.)
Page description language	PCL6, PCL5e
Resident font	Outline font: 45 Stroke font: 1 Line printer font: 1
Parallel interface	IEEE-1284 compatible parallel interface (P1284B connector)
Network interface	10 Base T/100 Base TX (To extend this product for the network feature, Print Server Card is needed as a peripheral unit.)
Warm up time	95 seconds or less
Continuous print speed	AR-P350: 35 pages/min., AR-P450: 45 pages/min.
First print time	Max. 6 seconds
Resolution	600 x 600 dpi
Print color	Black
Orientation	Portrait/landscape
Power supply	Local voltage $\pm$ 10% (For power supply requirements, see the name plate of the main unit.)
Operating conditions	Temperature: xx°F to xx°F (xx°C to xx°C), Humidity: xx% to xx%
Dimensions	16-55/64" (W) x 22-1/61" (D) x 18-15/32" (H) (428 mm (W) x 559 mm (D) x 469 mm (H))
Overall dimensions	xx-x/x" (W) x xx-x/x" (D) (xxx mm (W) x xxx mm (D)) (peripheral units not included)
Weight	Approx. xxx lbs. (xx kg) (including supplies)



## List of principal printer functions

			When an optional PS3 expansion kit is installed		
Function		PCL5e/PCL6	PS	PPD (Windows)	PPD (Macintosh)
General	Copies	1 - 999	1 - 999	1 - 999	1 - 999
	Orientation	Yes	Yes	Yes	Yes
	Duplex print	Yes	Yes	Yes	Yes
	Saddle stitch*3	Yes	Yes	Yes	N/A
	Binding edge	Left/top/right	Left/top/right	Long/short	Long/short
	N-up	2/4/6/8	2/4/6/8	2/4*4*5	2/4/6/8
	N-up direction	Z	Z	Z/reverse	Z
N-up border line	Yes	Yes	Yes (always)	Yes	
Paper input	Paper size	Yes	Yes	Yes	Yes
	Custom paper size	1 size	1 size	3 sizes*4*6	N/A
	Source selection	Yes	Yes	Yes	Yes
	Different first page	Yes	Yes	N/A	Yes
	Transparency inserts	Yes	Yes	N/A	Yes
Paper output	Output tray selection	Yes	Yes	Yes	Yes
	Mail bin	Yes	Yes	Yes	Yes
	Staple	Yes	Yes	Yes	Yes
	Offset	Yes	Yes	Yes	Yes
Graphic	Resolution	600/300 dpi	600 dpi	600 dpi	600 dpi
	Halftone	N/A	Yes	Yes	N/A
	Graphic mode	Yes	N/A	N/A	N/A
	Smoothing	Yes	Yes	Yes	Yes
	Toner save	Yes	Yes	Yes	Yes
	Photo enhancement	Yes	Yes	N/A	N/A
	Negative image	N/A	Yes	Yes	Yes
	Mirror image	N/A	Horizontal/vertical	Horizontal	Yes
	Zoom	N/A	N/A	Yes	Yes
Fit to page	Yes	Yes	N/A	N/A	
Font	Resident font	45 fonts	136 fonts	136 fonts*7	35 fonts
	Download font	Bitmap TrueType, Graphic	Bitmap Type1 TrueType	Bitmap Type1 TrueType	N/A
Others	Watermark*8	Yes	Yes	Yes	Yes
	Overlay	Yes	Yes	N/A	N/A
	Job retention*1	Yes	Yes	N/A	Yes
	Account control	Yes	Yes	N/A	N/A
	Custom settings	Yes	Yes	N/A	N/A
	Automatic configuration*2	Yes	Yes	N/A	N/A
Job end notification	Yes	Yes	N/A	N/A	

\*1 . . . In the models without a hard disk drive, a hard disk drive must be installed as a peripheral unit.

\*2 . . . Functions when peripheral units are installed.

\*3 . . . For the PPD driver (Windows), this function is supported only in the Windows 2000 environment.

\*4 . . . Not supported in the Windows NT 4.0 environment.

\*5 . . . 2/4/8/9/16 is supported in the Windows 2000 environment.

\*6 . . . Only one size is supported in the Windows 2000 environment.

\*7 . . . Only 35 fonts are supported in the Windows NT 4.0 environment.

\*8 . . . This function is limited for PPD (Windows).

# LIST OF COMBINATION OF PERIPHERAL UNITS

As shown in the table below, some other peripheral units may be needed for installation of a peripheral unit, and some peripheral units cannot be installed together.

	B/W scanner module/DSPF	Scanner rack	Multi purpose drawer	Stand/3 x 500 sheet paper drawer	Stand/MPD & 2000 sheet	Duplex module/bypass tray	Duplex module	Saddle stitch finisher	Finisher	Mail-bin stacker	Exit tray	Upper exit tray extension	Punch unit	Multi-function controller board	Print server card	PS3 expansion kit	Network scanner expansion kit	Facsimile expansion kit	Fax memory (8 MB)	Power supply unit	Hard disk drive
Related to scanner feature																					
B/W scanner module/DSPF	○	○	×	○ <sup>*1</sup>										○						○	
Scanner rack	○ <sup>*1</sup>	—	×	○ <sup>*1</sup>										○						○	
Related to paper feed unit																					
Multi purpose drawer	×	×	—	×	×			×					×				×	×	×		
Stand/3 x 500 sheet paper drawer			×	—	×															○	
Stand/MPD & 2000 sheet paper drawer			×	×	—															○	
Duplex module/bypass tray				○ <sup>*1</sup>		—		×					×							○ <sup>*2</sup>	
Duplex module				○ <sup>*1</sup>			—													○ <sup>*2</sup>	
Output units																					
Saddle stitch finisher			×	○ <sup>*1</sup>	×	○	—	×		×										○	
Finisher				○ <sup>*1</sup>				×	—	×			×							○	
Mail-bin stacker				○ <sup>*1</sup>				×	—											○	
Exit tray						○ <sup>*1</sup>	×				—	×									
Upper exit tray extension								×	×		—										
Punch unit		×	○ <sup>*1</sup>	×	○	○	×	×	×			—								○	
Related to extension of functions and others																					
Multi-function controller board	○ <sup>*1</sup>													—							
Print server card															—						
PS3 expansion kit																—					
Network scanner expansion kit	○ <sup>*1</sup>	○	×	○ <sup>*1</sup>										○	○		—				
Facsimile expansion kit	○ <sup>*1</sup>	○		○ <sup>*1</sup>										○				—			
Fax memory (8 MB)	○ <sup>*1</sup>	○		○ <sup>*1</sup>										○				○	—	○	
Power supply unit																				—	
Hard disk drive																					—

○ = Must be installed together. ○<sup>\*1</sup> = Any of the units must be installed together.

○<sup>\*2</sup> = Must be installed for installation of the stand/3 x 500 sheet paper drawer or the stand/MPD & 2000 sheet paper drawer.

×

---

## Notice page printing

A notice page will be printed when printing cannot be executed as specified due to restriction of functions and the problem cannot be indicated in the message display. The notice page indicates the cause of the problem. (When a notice page is printed, read thoroughly the text of the notice page and then solve the problem.)

A notice page is printed in the following cases.

- Print data of a job is too large to be stored in the memory. (Even if the data is not too large, a notice page may be printed when the memory is occupied with a copy job, fax jobs, and other jobs.)
- The number of print hold jobs is 100 and an additional print hold job is instructed.
- Different size paper is included in a print job and a size that cannot be delivered to the specified exit tray is included. (Printed paper is delivered partly to the specified exit tray and partly to a non-specified exit tray.)
- Some functions that have been disabled with key operator programs are specified. (Duplex module is disabled, stapler is disabled, punch is disabled, specified exit tray is disabled, etc.)
- An invalid account number is entered when the auditing mode has been set.

## Disabling notice page and separator sheet printing

Notice page and separator sheet printing can be disabled using a key operator program. See 'NOTICE PAGE PRINTING' on page xx.

# PRINT AREA

The print area of this product is shown below.

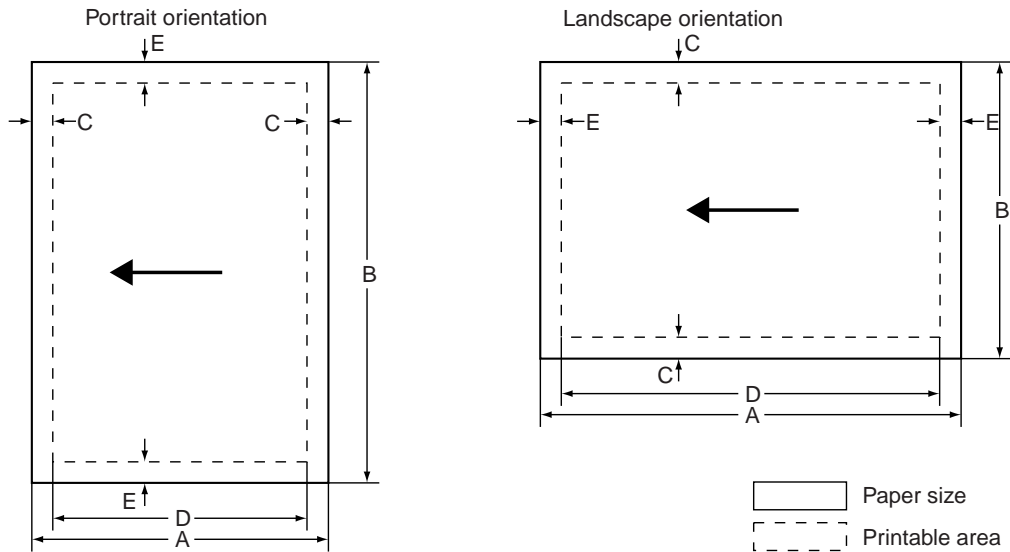

## In case of portrait orientation (in mm)

Paper size	A	B	C	D	E
A3	297	420	4	289	3.5
B4	257	364	4	242	3.5
A4	210	297	4	202	3.5
B5	182	257	4	168	3.5
A5	148	210	4	140	3.5
Japanese postcard	100	148	4	92	3.5
Ledger	279	432	4	271	3.5
Legal	216	356	4	208	3.5
Foolscap	216	330	4	208	3.5
Letter	216	279	4	208	3.5
Executive	184	267	4	183	3.5
Invoice	140	216	4	132	3.5
Com-10 (envelope)	105	241	4	97	3.5
C5 (envelope)	162	229	4	154	3.5
Monarch (envelope)	98	191	4	90	3.5
DL (envelope)	110	220	4	102	3.5
ISO B5 (envelope)	176	250	4	168	3.5

## In case of landscape orientation (in mm)

Paper size	A	B	C	D	E
A3	420	297	4	412	3.5
B4	364	257	4	345	3.5
A4	297	210	4	289	3.5
B5	257	182	4	242	3.5
A5	210	148	4	202	3.5
Japanese postcard	148	100	4	140	3.5
Ledger	432	279	4	424	3.5
Legal	356	216	4	348	3.5
Foolscap	330	216	4	322	3.5
Letter	279	216	4	271	3.5
Executive	267	184	4	259	3.5
Invoice	216	140	4	208	3.5
Com-10 (envelope)	241	105	4	233	3.5
C5 (envelope)	229	162	4	221	3.5
Monarch (envelope)	191	98	4	183	3.5
DL (envelope)	220	110	4	212	3.5
ISO B5 (envelope)	250	176	4	242	3.5





## Free Manuals Download Website

<http://myh66.com>

<http://usermanuals.us>

<http://www.somanuals.com>

<http://www.4manuals.cc>

<http://www.manual-lib.com>

<http://www.404manual.com>

<http://www.luxmanual.com>

<http://aubethermostatmanual.com>

Golf course search by state

<http://golfingnear.com>

Email search by domain

<http://emailbydomain.com>

Auto manuals search

<http://auto.somanuals.com>

TV manuals search

<http://tv.somanuals.com>