

SHARP

ELECTRIC REFRIGERATOR OPERATION MANUAL

Thank you very much for buying this SHARP product.
Before using your SHARP refrigerator, please read this operation
manual to ensure that you gain the maximum benefit from it.

SJ-P600M SJ-600M
SJ-P560M SJ-560M
SJ-P520M SJ-520M

DESCRIPTION

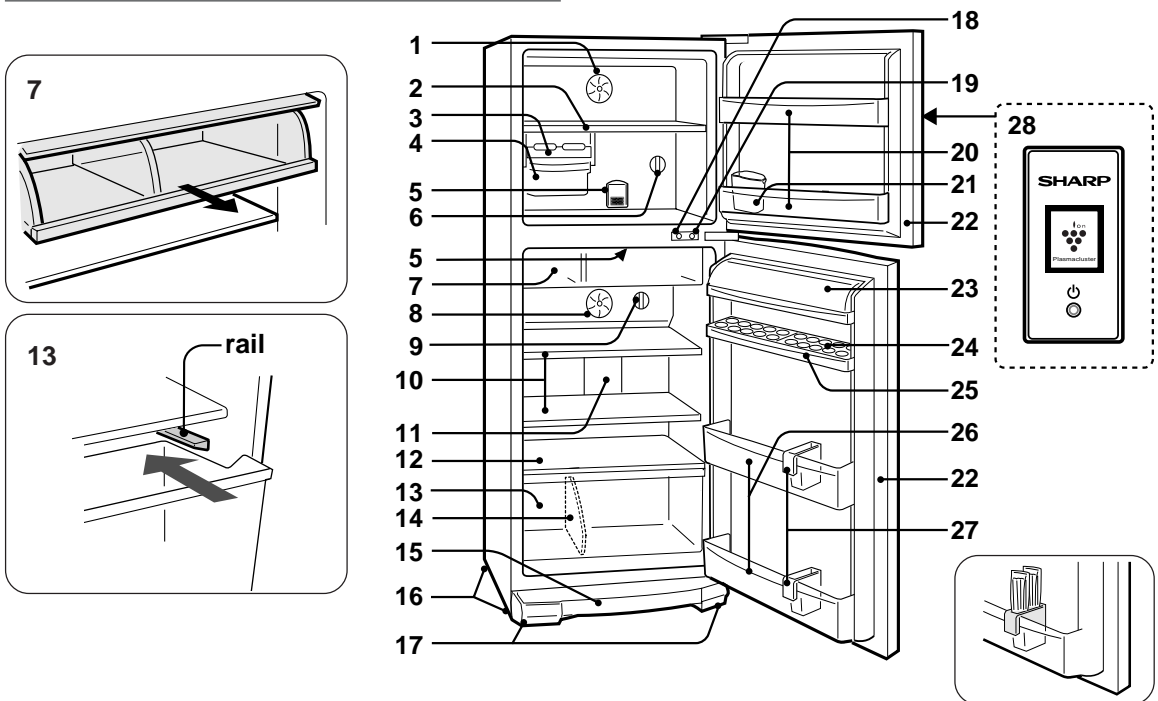

1. Freezer fan
2. Freezer shelf
3. Ice cube maker
4. Ice cube box
5. Deodorizing unit
6. Freezer temp. control knob
7. Fresh case
The cover of Fresh case opens as the case is pulled.
8. Refrigerator fan
Refrigerator compartment is equipped with a special fan, that quickly and evenly cools the inside of the cabinet should the inside temperature increase when opening the door or for other reasons.
9. Refrigerator temp. control knob
10. Refrigerator shelf
(600 type 3 shelves, 560/520 type 2 shelves)
11. Light
12. Shelf
13. Vegetable crisper
Put in the Vegetable crisper under the rail.
14. Separator plate
15. Evaporating pan & cover
16. Casters
17. Adjustable feet
18. Fan switch for freezer
19. Fan & light switch for refrigerator
20. Freezer pocket
21. Water supply cup
22. Magnetic door seal
23. Utility case
24. Egg holder
25. Free pocket
(600 type 2 pockets, 560/520 type 1 pocket)
26. Bottle pocket
27. Bottle guard
Prevents bottles, etc. from falling. Stick-type food products can also be stored inside.
28. Plasmacluster panel
(Only for SJ-P600M, SJ-P560M, SJ-P520M)

INSTALLATION

1. To ensure adequate ventilation for your refrigerator, it is recommended to provide space of 6cm on both sides and at the back, and space of 9cm above the refrigerator. Insufficient spacing will decrease the cooling efficiency, resulting in unnecessary consumption of electricity.

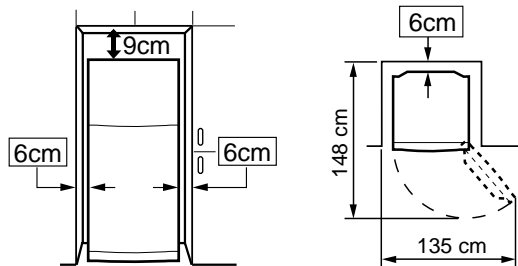

2. Using the two front Adjustable feet, ensure that the refrigerator is positioned firmly and level on the floor.
3. Clip Evaporating pan cover (supplied inside the refrigerator compartment) in position in front of the two Adjustable feet.

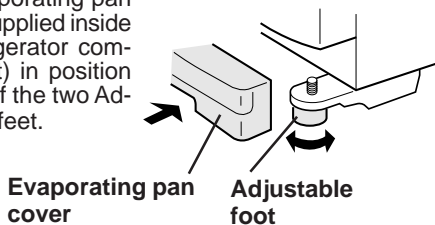

4. Connect the power plug to a 230/240 volt, 10 amp. power point.

NOTE:

- Position your refrigerator so that the plug is accessible.
- Keep your refrigerator out of direct sunlight.
- Do not place next to heat generating appliance.
- Do not place directly on the ground. Provide a clean, level, firm floor surface such as concrete or timber.

When transporting

Carry the refrigerator by holding the handles located on the rear and bottom.

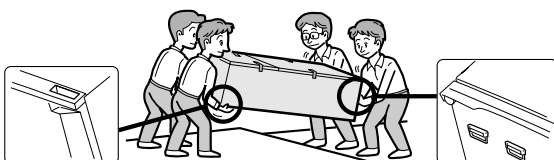

Before using your refrigerator

Clean the inside parts with a cloth soaked in warm water. If soapy water is used, wipe it off thoroughly.

OPERATION

CONTROLLING TEMPERATURES

The refrigerator controls its temperature automatically. However, if needed, adjust the temperature as follows.

Freezer compartment

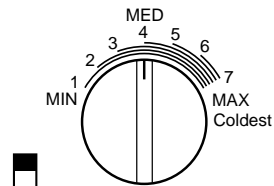

FREEZER TEMP. CONTROL

7(MAX)

For making ice rapidly or fast freezing.

4(MED)

For normal freezing.

1(MIN)

When frozen food or ice cream is not stored.

- If the refrigerator is operated for a long time with FREEZER TEMP. CONTROL set at 7(MAX), foods stored in the refrigerator compartment may also freeze.

Refrigerator compartment

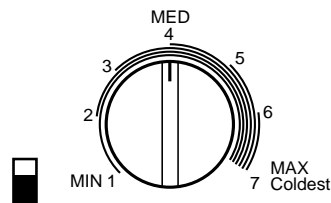

REFRIGERATOR TEMP. CONTROL

7(MAX)

For keeping foods fresher tasting. When the refrigerator does not provide sufficient cooling.

4(MED)

For normal operation.

1(MIN)

When the refrigerator provides excessive cooling.

- If the refrigerator is operated for a long time with REFRIGERATOR TEMP. CONTROL set at 7 (MAX), foods stored in the refrigerator compartment may also freeze.
- Low ambient temperature may cause placed foods to freeze even if REFRIGERATOR TEMP. CONTROL is set to 1 (MIN).

HINTS WHEN MAKING ICE

1. The included Water supply cup can be used to measure the amount of water to pour into Ice cube trays. Pouring too much water into the tray will result in the ice cubes connecting to each other when frozen.
2. When the ice cubes are made, turn the lever clockwise to empty the ice into Ice cube box.

NOTE:

To prevent damage to the Ice cube box, do not make ice in the Ice cube box or pour oil into it.

Amount for both Ice cube trays

Amount for one Ice cube tray

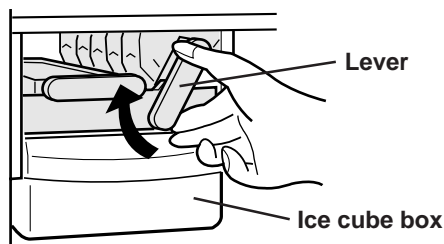

PLASMACLUSTER (Only for SJ-P600M, SJ-P560M, SJ-P520M)

The plasmacluster automatically starts operating when the refrigerator is powered on.

1. Press "PLASMACLUSTER(ON/OFF) button", and the PLASMACLUSTER lamp goes out and the plasmacluster turns off.
2. Press "PLASMACLUSTER(ON/OFF) button" again, and the PLASMACLUSTER lamp lights up. The plasmacluster turns on.

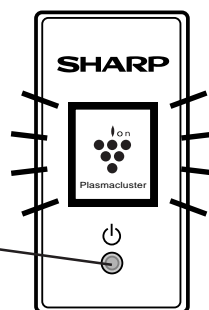

PLASMACLUSTER(ON/OFF) button

Notes about PLASMACLUSTER operation

The ionizer inside your refrigerator releases clusters of ions, which are collective masses of positive and negative ions, into the freezer and refrigerator compartment. These ion clusters reduce airborne mold fungus.

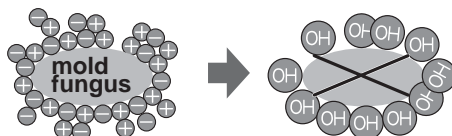

- There may be a slight odors in the refrigerator. This is the smell of ozone generated by the ionizer. The amount of ozone is minimal, and quickly decomposes in the refrigerator.

DEODORIZING UNIT

A built-in unit which requires no manual operation because it automatically starts operating when the refrigerator is powered on.

DEFROSTING

Defrosting is fully automatic due to a unique energy saving system. Whereby the defrost cycle start time is proportional to the running time of your refrigerator compressor, i. e., the less time the refrigerator compressor operates (during the winter season or you're away on holidays), the longer the time between each defrost cycle.

CARE AND CLEANING

Some household cleaning chemicals may affect the internal food liner and plastic shelves resulting in splitting or cracks occurring.

When cleaning all plastic parts inside this refrigerator, only use diluted dishwashing liquid (soapy water). Make sure that all plastic parts are thoroughly rinsed with water after cleaning.

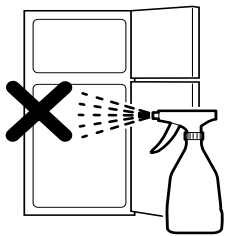

1. Remove the shelves and pockets from the cabinet and door. Wash them in warm soapy water; rinse in clean water and dry.
2. Clean the inside with a cloth soaked in warm soapy water. Then, use cold water to wipe off soapy water.
3. Wipe the exterior with a soft cloth each time it is soiled.
4. Clean Magnetic door seal with a toothbrush and warm soapy water.
5. Evaporating pan should be removed and cleaned once a year.

Replacing the lamp bulb

Replace lamp bulb with same type : base E12, MAX 15W, T-20.

Make sure that the rated voltage and wattage of the lamp bulb are correct when replacing. (Check the label near the bulb.)

When replacing the lamp bulb, unplug the refrigerator to prevent electric shock.

Evaporating pan & cover; How to remove

1. Hold both sides of Evaporating pan cover and angling upward.
2. Pull Evaporating pan out.

How to set

1. Put Evaporating pan on Radiator plate, then slide it in completely.
2. Fit the pawls of Evaporating pan cover into the holes of the cabinet, then push the cover to attach.

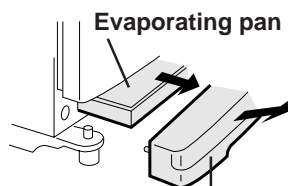

Evaporating pan cover

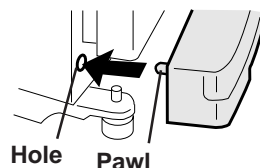

NOTE:

- Do not use polishing powder, benzine, hot water etc.
- If undiluted detergent is used or soapy water is not wiped off thoroughly, cracking of plastic parts can result.
- Wipe any food oils adhered to plastic components as they can cause cracking of the plastic surface.
- The glass shelves weighs approximately 3kg each. Hold firmly when removing from the cabinet or carrying.

Switching off your refrigerator

If you switch your refrigerator off when you are going away for an extended period, remove all food, clean the interior thoroughly. Remove the power cord plug from the power socket and leave all doors open.

WHAT TO DO BEFORE YOU CALL FOR SERVICE

Before you call for service, check the following point .

WHEN YOUR REFRIGERATOR DOES NOT WORK

- Check that the power is switched on and that the plug is correctly connected.
- Check with another appliance or lamp to see if the outlet has electric current. The fuse be blown or a circuit breaker tripped.

WHEN THERE IS A NOISE DURING OPERATION

- Cabinet not level.
- Weak or uneven floor.
- The back of the cabinet touching the wall.

IT IS NORMAL for the refrigerator to produce the following sounds.

- Loud noise produced by the compressor when operation starts --- Sound becomes quieter after a while.
- Loud noise produced once a day by the compressor --- Operating sound produced immediately after automatic defrost operation.
- Sound of flowing fluid (gurgling sound, fizzing sound) --- Sound of refrigerant flowing in pipes (sound may become louder from time to time).
- Cracking or crunching sound --- Sound produced by expansion and contraction of inner walls and internal parts during cooling.
- Squeaking sound --- Sound produced by expansion and contraction of internal parts.

IT IS NORMAL that the outside of a cabinet may be hot when touched. The hot pipe is in the cabinet in order to prevent dew generation.

IF YOU STILL REQUIRE SERVICE

Refer to your nearest service agent approved by SHARP.

STORING FOOD

Refrigeration reduces the rate of food spoilage. To maximize the shelf life of perishable food products, ensure that the food is of the freshest possible quality. The following is a general guide to help promote longer food storage.

Fruit / Vegetables

To minimize moisture loss, fruit and vegetables should be loosely enclosed in a plastic material e.g. wrap, bags (do not seal) and place in Vegetable crisper. Those fruits and vegetables with thick skins e.g. oranges do not require wrapping.



Dairy Products & Eggs

- Most dairy products have a use by date on the outer packaging which informs the recommended temperature and shelf life of the product.
- Eggs should be stored in the Egg holder.

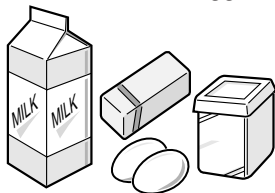

Meats / Fish / Poultry

- Place on a plate or dish and cover with paper or plastic wrap.
- For larger cuts of meat, fish, or poultry, place to the rear of the shelves.
- Ensure all cooked food is wrapped securely or placed in an airtight container.

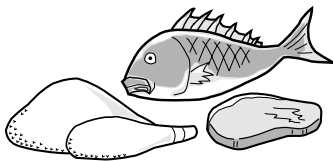

NOTE:

- Evenly place the food on the shelves to allow the cooling air to circulate efficiently.
- Hot foods should be cooled before storing. Storing hot foods increases the temperature in the unit and increases the risk of food spoilage.
- Do not block the outlet and inlet of the cool air circulating circuit with foods or containers; otherwise the foods will not be evenly cooled throughout the refrigerator.

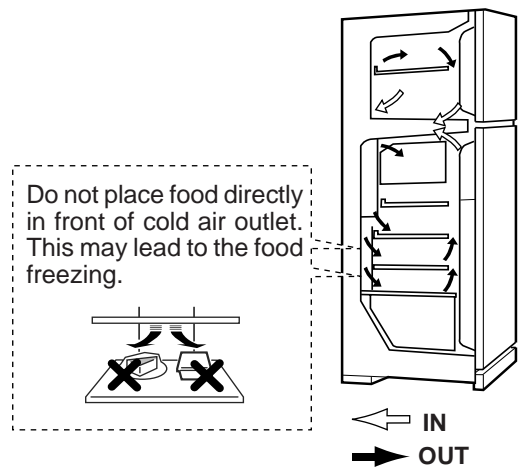

FOR BEST FREEZING

- Quality of foods should be fresh.
- Freeze small quantities of food at a time to freeze them quickly.
- Food should be properly stored or covered and the air should be removed to seal tightly.
- Evenly place the food in the freezer.
- Label bags or containers to keep an inventory of freezing food.

SPECIFICATION

	SJ-P600M, 600M	SJ-P560M, 560M	SJ-P520M, 520M
Rated voltage (V~)	230 - 240		
Rated frequency (Hz)	50		
Rated current (A)	1.4 - 1.5		
Rated input of heating systems (W)	157 - 170		
Defrosting input (W)	157 - 170		
Internal lamp input (W)	15 max.		
Climate class	T		
Refrigerant	HFC - 134a		
Charge (g)	130	125	120
Insulation blowing gas	Cyclo pentane		
Rated storage volume (L)	577	535	492
Rated gross volume (L)	606	566	526
Group (AS / NZS 4474.1)	5T		

WARNING

1. This refrigerator is airtight. TO PREVENT FATAL ACCIDENTS TO CHILDREN, please completely remove the door prior to discarding the refrigerator.
2. Highly volatile and inflammable materials such as ether, petrol, propane gas, adhesive agents and pure alcohol etc. are liable to explode. Do not store these materials in the refrigerator.
3. To prevent damage to the outer cabinet, avoid contact with lacquer, and paint, etc.
4. When cleaning your refrigerator, do not splash water directly on the outer cabinet or the interior. This may lead to rusting and deterioration of the electrical insulation.
5. When cleaning any areas adjacent to electrical components or replacing the lamp bulb, unplug the refrigerator first to prevent electric shock.
6. Should electrical components be accidentally immersed in water, unplug the refrigerator, dry the parts and contact your nearest service agent approved by SHARP.
7. When disconnecting the power plug, do not touch the pins of plug. This may cause electric shock.
8. This refrigerator is designed solely for the purpose of storing foodstuff for domestic use in accordance with the instructions given in this manual. Using the refrigerator for other purposes might be harmful to persons or property.
9. This refrigerator is not suitable for the storage of materials requiring precise temperatures. Deterioration of these materials will be dangerous.
10. Dust deposited on the power plug may cause fire. Wipe it off carefully.
11. Do not attempt to change or modify this refrigerator. This may result in fire, electric shock or injury.
12. **Information regarding disposal of the appliance**
Flammable insulation blowing gases should be disposed appropriately. Take the cabinet and doors to a recycling plant for flammable insulation blowing gases.

CAUTION

1. Do not touch the compressor unit, as it can become extremely hot during operation.
2. If the power supply is accidentally disconnected, please wait for at least 5 minutes before re-connecting the power, as back pressure in the compressor may trip the overload relay.
3. Avoid removing food from the freezer with your bare hands. Directly touching products stored at sub-zero temperatures can result in frost-bite.
4. To prevent accidental power disconnection, plug the refrigerator directly to the source. Do not use a double adaptor as loss of power could lead to the spoiling of the stored food.
5. Do not place bottles in the freezer as they may crack when frozen.
6. Keep the door securely closed. If the door is left ajar, the controlled inner temperature will rise, resulting in food spoilage and increase in electricity costs.
7. Do not install the refrigerator in a damp or wet location as this may cause damage to the insulation and a leak. Condensation may also build on the outer cabinet and cause rust.
8. When installing or moving the refrigerator, make sure that you do not nip or kink the power cord. Damage of the power cord may cause electric shock or fire.
9. Do not use this refrigerator when the power cord or plug is damaged, or the outlet attachment is loose, as they may cause electric shock or fire.
10. Disconnect from the mains electricity supply by removing the mains plug from the electricity supply socket. Do not remove by pulling the mains lead. This may cause electric shock or fire.
11. Make sure that you leave adequate ventilation space around the refrigerator to prevent the compressor from overheating and stopping. Please follow the instructions given for installation.
12. The refrigeration system behind and inside the refrigerator contains refrigerant. If this system is punctured it could result in serious damage to your refrigerator, therefore do not allow any sharp objects to come into contact with the refrigeration system.
13. Should the flexible supply cord be damaged, it must be replaced by service agent approved by SHARP as a special cord is required.
14. In case of gas leak, ventilate the area by opening a window, etc. Do not touch the refrigerator or the power outlet.
15. Do not place heavy or easily broken objects on top of the refrigerator. Objects may fall when opening or closing the refrigerator, causing injury.
16. Do not place objects containing liquid on top of the refrigerator. Spillage may cause electric shock or fire.
17. Do not drop objects inside the refrigerator or strike the inner wall. This may cause the inner surface to crack.
18. This refrigerator is not intended for use by young children or infirm persons without supervision. Young children should be supervised to ensure that they do not play with the refrigerator.

SHARP CORPORATION Osaka, Japan
SHARP CORPORATION OF AUSTRALIA PTY.LTD.

A. C. N. 003 039 405

1 HUNTINGWOOD DRIVE, HUNTINGWOOD, BLACKTOWN. N.S.W. 2148
P.O.BOX 827, BLACKTOWN. N.S.W.2148

Free Manuals Download Website

<http://myh66.com>

<http://usermanuals.us>

<http://www.somanuals.com>

<http://www.4manuals.cc>

<http://www.manual-lib.com>

<http://www.404manual.com>

<http://www.luxmanual.com>

<http://aubethermostatmanual.com>

Golf course search by state

<http://golfingnear.com>

Email search by domain

<http://emailbydomain.com>

Auto manuals search

<http://auto.somanuals.com>

TV manuals search

<http://tv.somanuals.com>