

# SHARP

**1** BIT  
TECHNOLOGY

## 1-BIT DIGITAL AUDIO SYSTEM

MODEL

# SD-EX200

OPERATION MANUAL

**1bit**  
Technology

COMPACT  
**disc**  
DIGITAL AUDIO

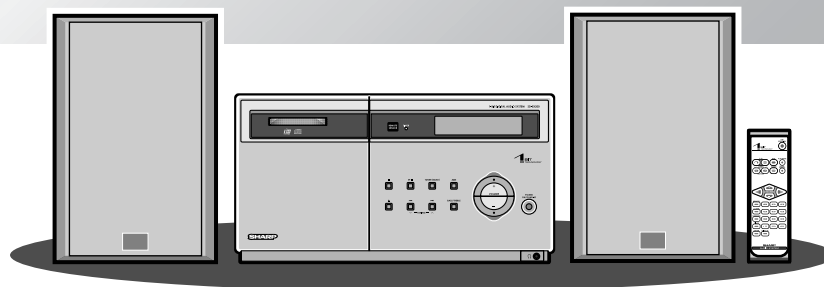

# SPECIAL NOTES

Important Instruction  
- Special Notes -



**CAUTION**  
RISK OF ELECTRIC SHOCK  
DO NOT OPEN



**CAUTION: TO REDUCE THE RISK OF ELECTRIC SHOCK, DO NOT REMOVE COVER (OR BACK). NO USER-SERVICEABLE PARTS INSIDE. REFER SERVICING TO QUALIFIED SERVICE PERSONNEL.**

**Explanation of Graphical Symbols:**



The lightning flash with arrowhead symbol, within an equilateral triangle, is intended to alert the user to the presence of uninsulated "dangerous voltage" within the product's enclosure that may be of sufficient magnitude to constitute a risk of electric shock to persons.



The exclamation point within an equilateral triangle is intended to alert the user to the presence of important operating and maintenance (servicing) instructions in the literature accompanying the appliance.

**WARNING: TO REDUCE THE RISK OF FIRE OR ELECTRIC SHOCK, DO NOT EXPOSE THIS APPLIANCE TO RAIN OR MOISTURE.**

**Caution - use of controls or adjustments or performance of procedures other than those specified herein may result in hazardous radiation exposure.**

**NOTE**

This equipment has been tested and found to comply with the limits for a Class B digital device, pursuant to Part 15 of the FCC Rules. These limits are designed to provide reasonable protection against harmful interference in a residential installation. This equipment generates, uses, and can radiate radio frequency energy and, if not installed and used in accordance with the instructions, may cause harmful interference to radio communications. However, there is no guarantee that interference will not occur in a particular installation. If this equipment does cause harmful interference to radio or television reception, which can be determined by turning the equipment off and on, the user is encouraged to try to correct the interference by one or more of the following measures:

- Reorient or relocate the receiving antenna.
- Increase the separation between the equipment and receiver.
- Connect the equipment into an outlet on a circuit different from that to which the receiver is connected.
- Consult the dealer or an experienced radio/TV technician for help.

**WARNING**

FCC Regulations state that any unauthorized changes or modifications to this equipment not expressly approved by the manufacturer could void the user's authority to operate this equipment.

**Note to CATV system installer:**

This reminder is provided to call the CATV system installer's attention to Article 820-40 of the National Electrical Code that provides guidelines for proper grounding and, in particular, specifies that the cable ground shall be connected to the grounding system of the building, as close to the point of cable entry as practical.

**FOR YOUR RECORDS**

For your assistance in reporting this unit in case of loss or theft, please record below the model number and serial number which are located on the rear of the unit.

Please retain this information.

**Model number** .....

**Serial number** .....

**Date of purchase** .....

**Place of purchase** .....

# IMPORTANT SAFETY INSTRUCTIONS

- 1 Read Instructions** - All the safety and operating instructions should be read before the product is operated.
- 2 Retain Instructions** - The safety and operating instructions should be retained for future reference.
- 3 Heed Warnings** - All warnings on the product and in the operating instructions should be adhered to.
- 4 Follow Instructions** - All operating and use instructions should be followed.
- 5 Cleaning** - Unplug this product from the wall outlet before cleaning. Do not use liquid cleaners or aerosol cleaners. Use a damp cloth for cleaning.
- 6 Attachments** - Do not use attachments not recommended by the product manufacturer as they may cause hazards.
- 7 Water and Moisture** - Do not use this product near water - for example, near a bath tub, wash bowl, kitchen sink, or laundry tub; in a wet basement; or near a swimming pool; and the like.
- 8 Accessories** - Do not place this product on an unstable cart, stand, tripod, bracket, or table. The product may fall, causing serious injury to a child or adult, and serious damage to the product. Use only with a cart, stand, tripod, bracket, or table recommended by the manufacturer, or sold with the product. Any mounting of the product should follow the manufacturer's instructions, and should use a mounting accessory recommended by the manufacturer.
- 9** A product and cart combination should be moved with care. Quick stops, excessive force, and uneven surfaces may cause the product and cart combination to overturn.



- 10 Ventilation** - Slots and openings in the cabinet are provided for ventilation and to ensure reliable operation of the product and to protect it from overheating, and these openings must not be blocked or covered. The openings should never be blocked by placing the product on a bed, sofa, rug, or other similar surface. This product should not be placed in a built-in installation such as a bookcase or rack unless proper ventilation is provided or the manufacturer's instructions have been adhered to.
- 11 Power Sources** - This product should be operated only from the type of power source indicated on the marking label. If you are not sure of the type of power supply to your home, consult your product dealer or local power company. For products intended to operate from battery power, or other sources, refer to the operating instructions.
- 12 Grounding or Polarization** - This product may be equipped with a polarized alternating-current line plug (a plug having one blade wider than the other). This plug will fit into the power outlet only one way. This is a safety feature. If you are unable to insert the plug fully into the outlet, try reversing the plug. If the plug should still fail to fit, contact your electrician to replace your obsolete outlet. Do not defeat the safety purpose of the polarized plug.  
**Alternate Warnings** - This product is equipped with a three-wire grounding-type plug, a plug having a third (grounding) pin. This plug will only fit into a grounding-type power outlet. This is a safety feature. If you are unable to insert the plug into the outlet, contact your electrician to replace your obsolete outlet. Do not defeat the safety purpose of the grounding-type plug.
- 13 Power-Cord Protection** - Power-supply cords should be routed so that they are not likely to be walked on or pinched by items placed upon or against them, paying particular attention to cords at plugs, convenience receptacles, and the point where they exit from the product.
- 14 Protective Attachment Plug** - The product is equipped with an attachment plug having overload protection. This is a safety feature. See Instruction Manual for replacement or resetting of protective device. If replacement of the plug is required, be sure the service technician has used a replacement plug specified by the manufacturer that has the same overload protection as the original plug.

# IMPORTANT SAFETY INSTRUCTIONS (continued)

- 15 Outdoor Antenna Grounding** - If an outside antenna or cable system is connected to the product, be sure the antenna or cable system is grounded so as to provide some protection against voltage surges and built-up static charges. Article 810 of the National Electrical Code, ANSI/NFPA 70, provides information with regard to proper grounding of the mast and supporting structure, grounding of the lead-in wire to an antenna discharge unit, size of grounding conductors, location of antenna-discharge unit, connection to grounding electrodes, and requirements for the grounding electrode.

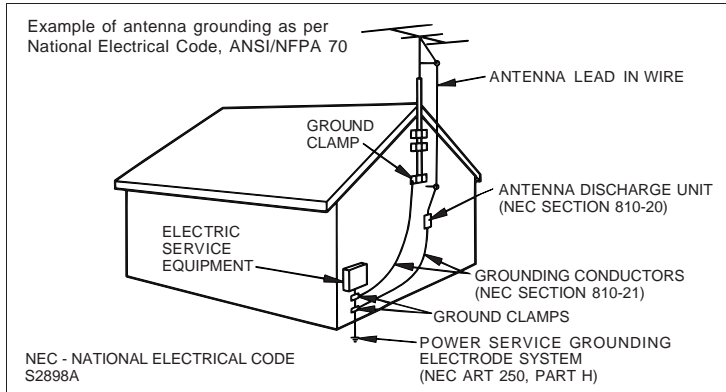

- 16 Lightning** - For added protection for this product during a lightning storm, or when it is left unattended and unused for long periods of time, unplug it from the wall outlet and disconnect the antenna or cable system. This will prevent damage to the product due to lightning and power-line surges.
- 17 Power Lines** - An outside antenna system should not be located in the vicinity of overhead power lines or other electric light or power circuits, or where it can fall into such power lines or circuits. When installing an outside antenna system, extreme care should be taken to keep from touching such power lines or circuits as contact with them might be fatal.
- 18 Overloading** - Do not overload wall outlets, extension cords, or integral convenience receptacles as this can result in a risk of fire or electric shock.

- 19 Object and Liquid Entry** - Never push objects of any kind into this product through openings as they may touch dangerous voltage points or short-out parts that could result in a fire or electric shock. Never spill liquid of any kind on the product.

- 20 Servicing** - Do not attempt to service this product yourself as opening or removing covers may expose you to dangerous voltage or other hazards. Refer all servicing to qualified service personnel.

- 21 Damage Requiring Service** - Unplug this product from the wall outlet and refer servicing to qualified service personnel under the following conditions:

- a) When the power-supply cord or plug is damaged,
- b) If liquid has been spilled, or objects have fallen into the product,
- c) If the product has been exposed to rain or water,
- d) If the product does not operate normally by following the operating instructions. Adjust only those controls that are covered by the operating instructions as an improper adjustment of other controls may result in damage and will often require extensive work by a qualified technician to restore the product to its normal operation,
- e) If the product has been dropped or damaged in any way, and
- f) When the product exhibits a distinct change in performance - this indicates a need for service.

- 22 Replacement Parts** - When replacement parts are required, be sure the service technician has used replacement parts specified by the manufacturer or have the same characteristics as the original part. Unauthorized substitutions may result in fire, electric shock, or other hazards.

- 23 Safety Check** - Upon completion of any service or repairs to this product, ask the service technician to perform safety checks to determine that the product is in proper operating condition.

- 24 Wall or Ceiling Mounting** - The product should be mounted to a wall or ceiling only as recommended by the manufacturer.

- 25 Heat** - The product should be situated away from heat sources such as radiators, heat registers, stoves, or other products (including amplifiers) that produce heat.

## ENERGY STAR® Program Information

As an ENERGY STAR® Partner, SHARP has determined that this product meets the ENERGY STAR® guidelines for energy efficiency.

ENERGY STAR® is a U.S. registered mark.

### WHY PURCHASE ENERGY STAR® LABELED PRODUCTS?

Many Electrical/Electronic Products use energy both when they are on and when they are off. Americans spend more than \$3 billion a year on energy consumed by home electronic products when they are not in use. The new ENERGY STAR® labeled models will reduce that energy "leakage" by up to 75 percent. Ultimately, this will mean more than \$1 billion a year in energy savings for consumers.

The energy savings will help reduce the burning of fossil fuels and the related carbon dioxide pollution that contributes to global warming. If every American family replaced their electronic equipment with ENERGY STAR® labeled models, it would reduce air pollution equivalent to eliminating more than two million cars.



By using ENERGY STAR® labeled products, you will save money on your electric bills and use less energy.

That makes good economic sense and it's good for our environment.

---

ENERGY STAR® is a U.S. registered mark.

Page

## ■ General Information

Introduction .....	6
Accessories .....	6
Precautions .....	7
Controls and indicators .....	8 - 10

## ■ Preparation for Use

Remote control .....	11
System connections .....	12 - 13
General control .....	14
Setting the clock .....	15

## ■ CD Playback

Listening to a CD .....	16 - 17
Advanced CD Playback .....	17 - 19

## ■ Radio

Listening to the radio .....	20 - 21
------------------------------	---------

## ■ Advanced Features

Timer and sleep operation .....	22 - 24
Enhancing your system .....	25

## ■ References

Troubleshooting chart .....	26 - 27
Maintenance .....	28
Error messages .....	28
Specifications .....	29

CONSUMER LIMITED WARRANTY .....	Back cover
---------------------------------	------------

# Introduction

Thank you for purchasing this SHARP product. To obtain the best performance from this product, please read this manual carefully. It will guide you in operating your SHARP product.

- SD-EX200 1-Bit Digital Audio System consisting of SD-EX200 (main unit) and CP-EX200 (speaker system).

## Accessories

Please confirm that the following accessories are included.

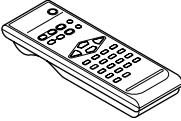
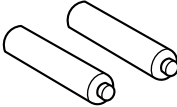
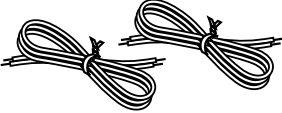
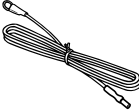
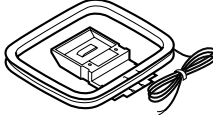
 <p><b>Remote control × 1</b> RRMCG0375AWSA</p>	 <p><b>"AA" size battery (UM/SUM-3, R6, HP-7 or similar) × 2</b> UBATU0001AWZZ</p>	
 <p><b>Speaker wire × 2</b> QCNWH0009AWZZ</p>	 <p><b>FM antenna × 1</b> 92LFANT1535A</p>	 <p><b>AM loop antenna × 1</b> QANTL0014AWZZ</p>

**Note:**

Only the above accessories are included.

## ■ General

- Please ensure that the equipment is positioned in a well-ventilated area and ensure that there is at least 4" (10 cm) of free space along the top and sides of the equipment.

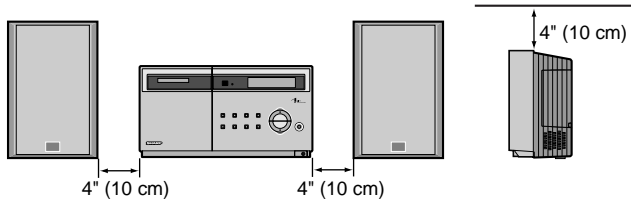

- Use the unit on a firm, level surface free from vibration.

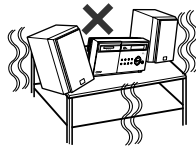

- Keep the unit away from direct sunlight, strong magnetic fields, excessive dust, humidity and electronic/ electrical equipment (home computers, facsimiles, etc.) which generates electrical noise.

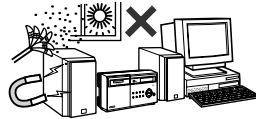

- Do not place anything on top of the unit.
- Do not expose the unit to moisture, to temperatures higher than 140°F (60°C) or to extremely low temperatures.
- If your system does not work properly, disconnect the AC power cord from the AC outlet. Plug the AC power cord back in, and then turn on your system.
- In case of an electrical storm, unplug the unit for safety.

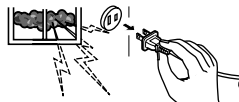

- Hold the AC power plug by the head when removing it from the AC outlet, as pulling the cord can damage internal wires.

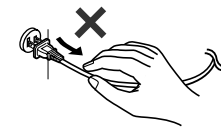

- Do not remove the outer cover, as this may result in electric shock. Refer internal service to your local SHARP service facility.

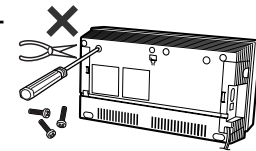

- This unit should only be used within the range of 41°F - 95°F (5°C - 35°C).

### Warning:

- The voltage used must be the same as that specified on this unit. Using this product with a higher voltage other than that which is specified is dangerous and may result in a fire or other type of accident causing damage. SHARP will not be held responsible for any damage resulting from use of this unit with a voltage other than that which is specified.
- CD players use a laser pickup which can damage the eyes if viewed directly. Do not look at the pickup, and do not touch the pickup directly.

## ■ Volume control

The sound level at a given volume setting depends on speaker efficiency, location and various other factors. It is advisable to avoid exposure to high volume levels, which occurs while turning the unit on with the volume control setting up high, or while continually listening at high volumes.

# Controls and indicators

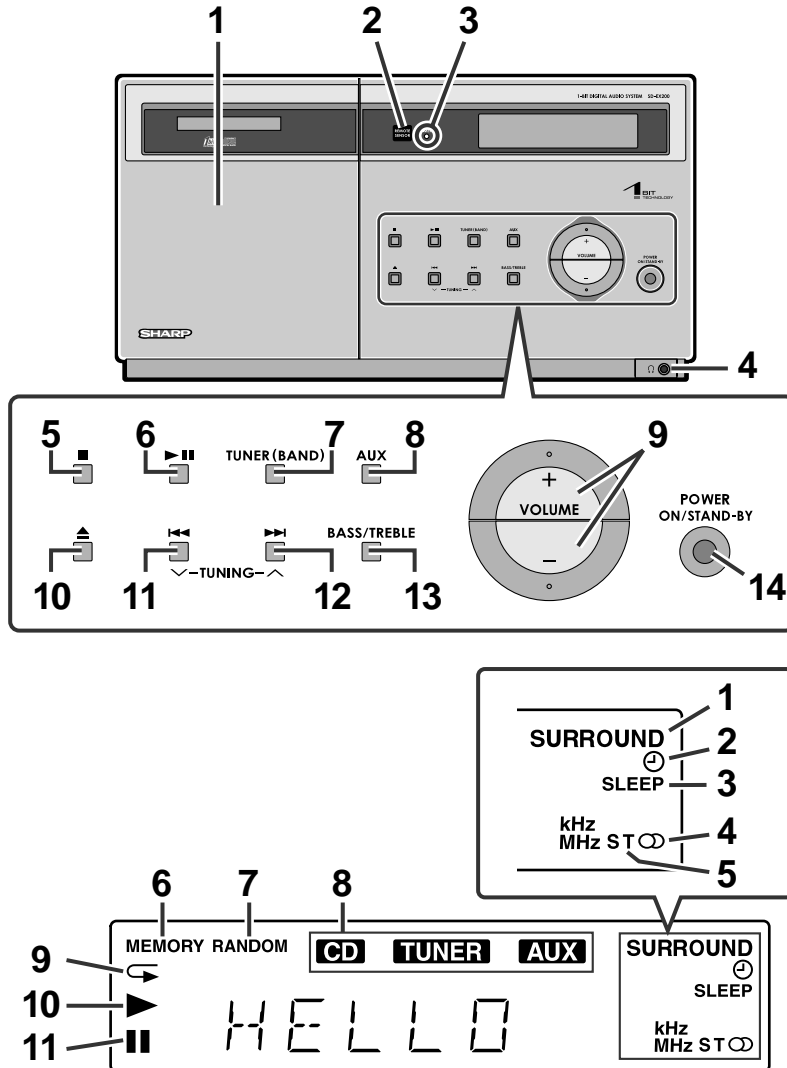

## ■ Front panel

	Reference page
1. CD Cover .....	16
2. Remote Sensor .....	11
3. Timer Set Indicator .....	23
4. Headphone Jack .....	25
5. CD Stop Button .....	16
6. CD Play/Pause Button .....	16
7. Tuner (Band) Button .....	20
8. Auxiliary Button .....	25
9. Volume Up and Down Buttons .....	14
10. CD Cover Open/Close Button .....	16, 17
11. CD Track Down or Fast Reverse/Tuning Down Button .....	17, 20
12. CD Track Up or Fast Forward/Tuning Up Button .....	17, 20
13. Bass/Treble Button .....	14
14. Power On/Stand-by Button .....	14

## ■ Display

1. Surround Indicator
2. Timer Play Indicator
3. Sleep Indicator
4. FM Stereo Receiving Indicator
5. FM Stereo Mode Indicator
6. CD Memory Indicator
7. Random Play Indicator
8. Function Indicators
9. CD Repeat Play Indicator
10. CD Play Indicator
11. CD Pause Indicator



Left side

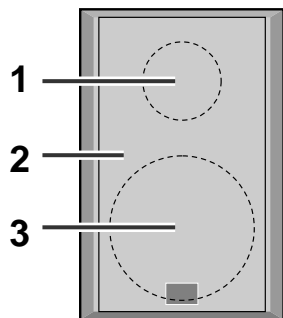
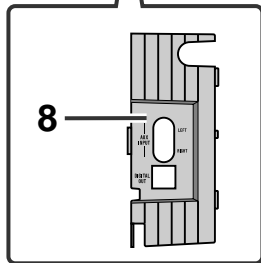
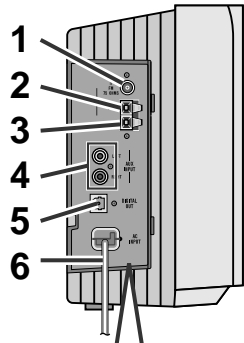

Right side

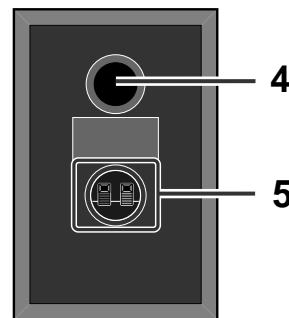
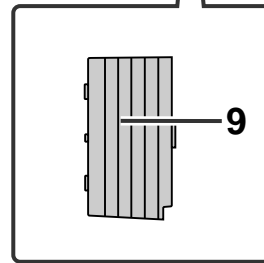
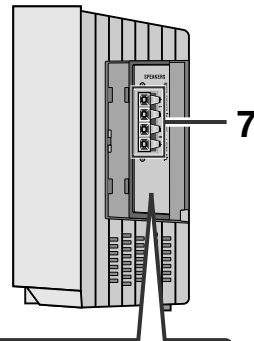

## ■ Side panel

	Reference page
1. FM 75 Ohms Antenna Jack .....	12, 13
2. AM Antenna Ground Terminal .....	12, 13
3. AM Antenna Terminal .....	12, 13
4. Auxiliary Input Jacks .....	25
5. Digital Output Jack .....	25
6. AC Power Cord .....	13
7. Speaker Terminals .....	12
8. Left Side Cover .....	12, 13
9. Right Side Cover .....	12, 13

### Note:

For details on opening side covers, see page 12.

## ■ Speaker system

	Reference page
1. Tweeter .....	
2. Speaker Grille .....	
3. Woofer .....	
4. Bass Reflex Duct .....	
5. Speaker Terminals .....	12

### Speaker grilles are removable:

Make sure nothing comes into contact with the speaker diaphragms when you remove the speaker grilles.

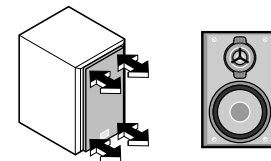

# Controls and indicators (continued)

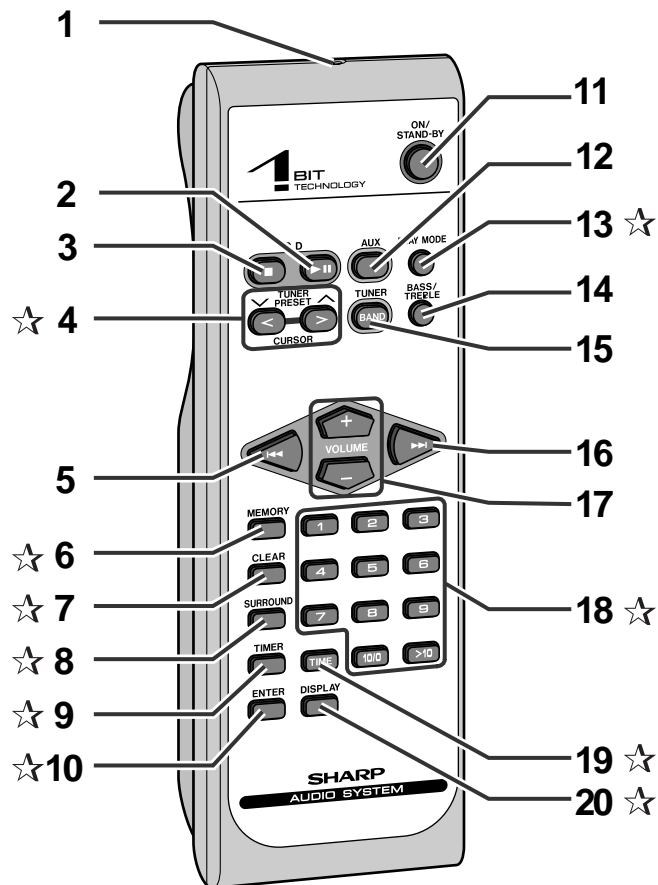

## Remote control

	Reference page
1. Remote Control Transmitter	.11
2. CD Play/Pause Button	.16
3. CD Stop Button	.16
4. <b>Cursor/Tuner Preset Buttons</b>	<b>.15, 21</b>
5. CD Track Down or Fast Reverse/Tuning Down Button	.17, 20
6. <b>CD Memory Button</b>	<b>.19</b>
7. <b>Program Clear Button</b>	<b>.19</b>
8. <b>Surround Button</b>	<b>.14</b>
9. <b>Timer Button</b>	<b>.15, 22</b>
10. <b>Enter Button</b>	<b>.15, 22</b>
11. Power On/Stand-by Button	.14
12. Auxiliary Button	.25
13. <b>CD Play Mode Select Button</b>	<b>.18</b>
14. Bass/Treble Button	.14
15. Tuner (Band) Button	.20
16. CD Track Up or Fast Forward/Tuning Up Button	.17, 20
17. Volume Up and Down Buttons	.14
18. <b>CD/Tuner Direct Buttons</b>	<b>.18, 21</b>
19. <b>CD Time Display Button</b>	<b>.18</b>
20. <b>Clock Display/Dimmer Button</b>	<b>.14, 15</b>

Buttons with "★" mark in the illustration or highlighted in bold on the list can be operated on the remote control only.

## ■ Battery installation

- 1 Remove the battery cover.
- 2 Insert the supplied batteries according to the direction indicated in the battery compartment.  
When inserting or removing the batteries, push them toward the ⊖ battery terminals.
- 3 Replace the cover.

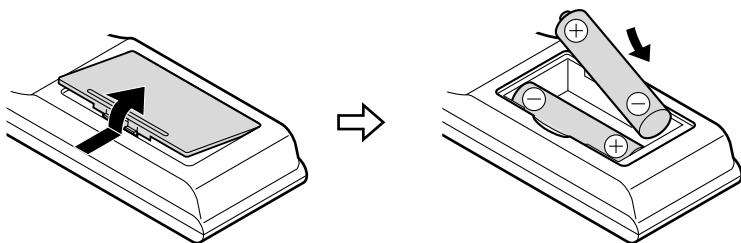

### Precautions for battery use:

- Replace all old batteries with new ones at the same time.
- Do not mix old and new batteries.
- Remove the batteries if the unit will not be used for long periods of time. This will prevent potential damage due to battery leakage.

### Caution:

- Do not use rechargeable batteries (nickel-cadmium battery, etc.).
- Installing the batteries incorrectly may cause the unit to malfunction.

### Notes concerning use:

- Replace the batteries if the operating distance is reduced or if the operation becomes erratic. Purchase 2 "AA" size batteries (UM/SUM-3, R6, HP-7 or similar).
- Periodically clean the transmitter on the remote control and the sensor on the unit with a soft cloth.
- Exposing the sensor on the unit to strong light may interfere with operation. Change the lighting or the direction of the unit.
- Keep the remote control away from moisture, heat, shock, and vibrations.

## ■ Test of the remote control

Check the remote control after verifying all the connections (see pages 12 - 13). Point the remote control directly at the remote sensor on the unit.

**The remote control can be used within the range shown below:**

Press the ON/STAND-BY button. Does the power turn on? Now, you can enjoy the music.

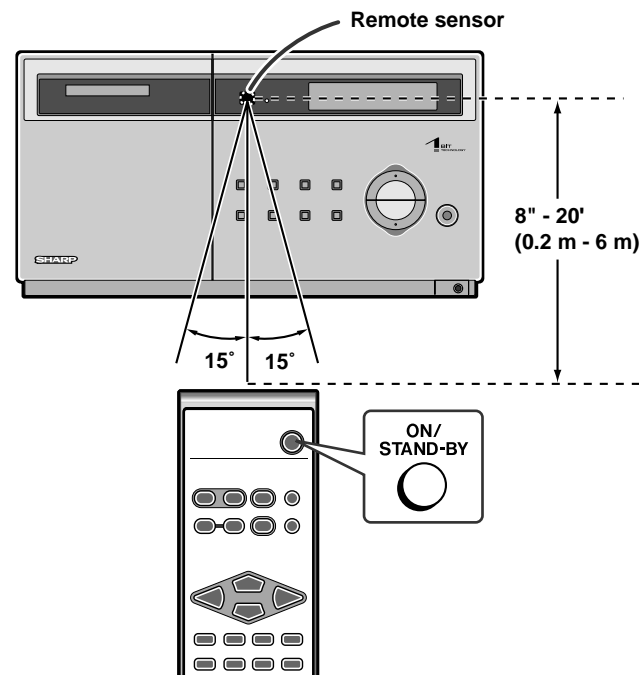

# System connections

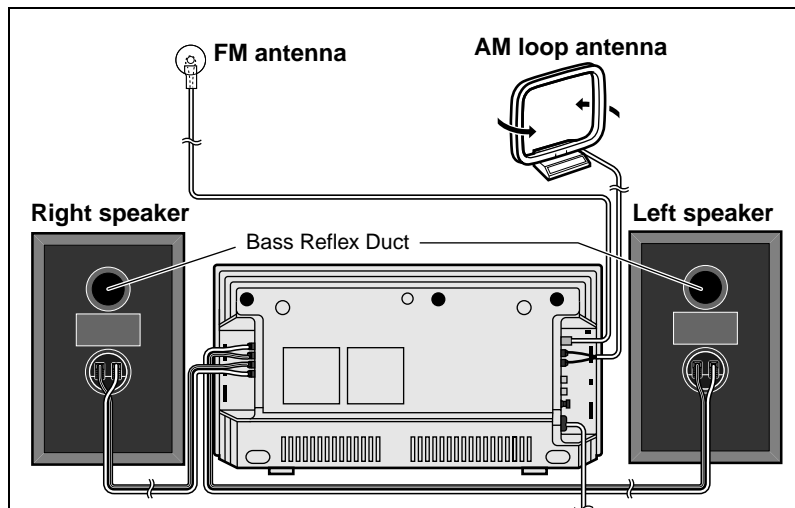

## How to open side covers

Open the right and left side covers to connect the system.

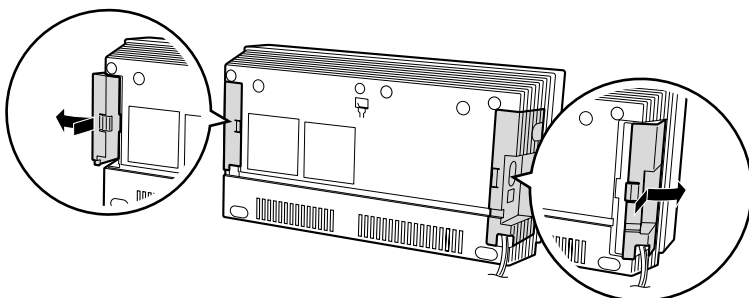

## ■ Speaker connection

- Make sure to unplug the AC power cord before connecting the speaker wires.
- Connect the speaker wires to the speakers first, then to the unit. This prevents short circuit between  $\oplus$  and  $\ominus$  terminals.

Connect the wire with the black line to the (-) and the transparent one to the (+).

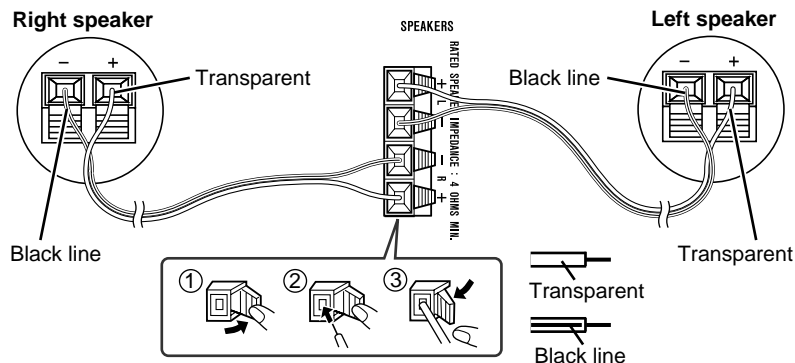

## Caution:

- Use speakers with an impedance of 4 ohms or more, as lower impedance speakers can damage the unit.
- Do not mistake  $\oplus$  and  $\ominus$ , and right and left terminals of the speaker wires. (The right speaker is placed on the right when you face the unit.)
- **Do not let the bare speaker wires touch each other.**
- **Do not short-circuit the speaker wires. If the power is turned on, malfunction may occur.**
- Do not allow any objects to fall into or to be placed in the bass reflex ducts.
- Do not stand or sit on the speakers. You may be injured.

Incorrect

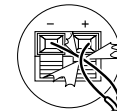

Incorrect



## Note:

There is no physical distinction between the right and the left speakers.

Left speaker

Right speaker



## ■ Antenna connection

### Supplied FM antenna:

Connect the FM antenna wire to the FM 75 OHMS jack and position the FM antenna wire in the direction where the strongest signal can be received.

### Supplied AM loop antenna:

Connect the AM loop antenna wire to the AM and GND terminals. Position the AM loop antenna for optimum reception. Place the AM loop antenna on a shelf, etc., or attach it to a stand or a wall with screws (not supplied).

#### Note:

Placing the antenna on the unit or near the AC power cord may cause noise pickup. Place the antenna away from the unit for better reception.

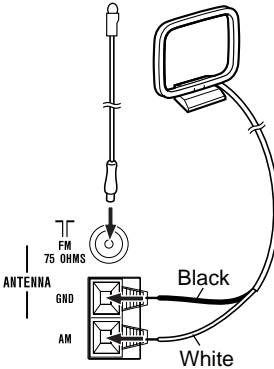

### Installing the AM loop antenna:

< Assembling >

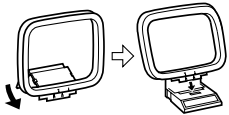

< Attaching to the wall >

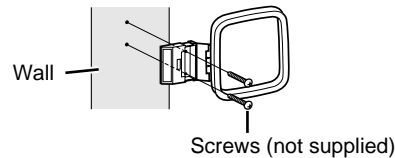

### Outdoor FM or AM antenna:

Use an outdoor FM or AM antenna if you require better reception. Consult your dealer.

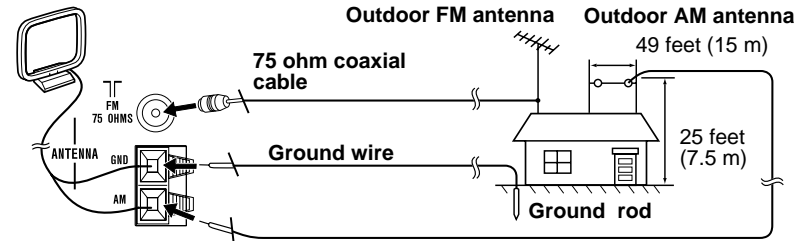

#### Note:

When using an outdoor AM antenna, be sure to keep the wire of the AM loop antenna connected.

## ■ How to close side covers

When completing the connection, close the side covers (be careful not to trap the wires).

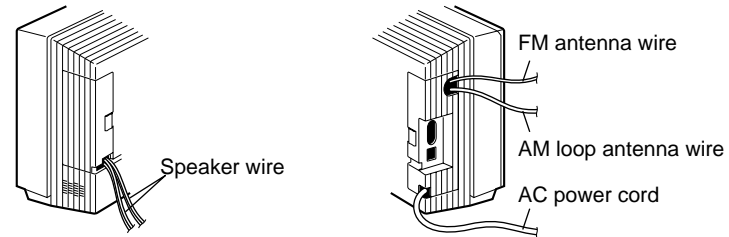

## ■ Connecting the AC power cord

After checking all the connections have been made correctly, plug the AC power cord of this unit into the AC outlet.

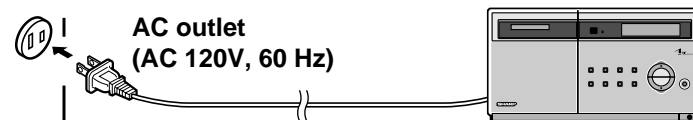

#### Note:

Unplug the AC power cord from the AC outlet if the unit will not be in use for a prolonged period of time.

# General control

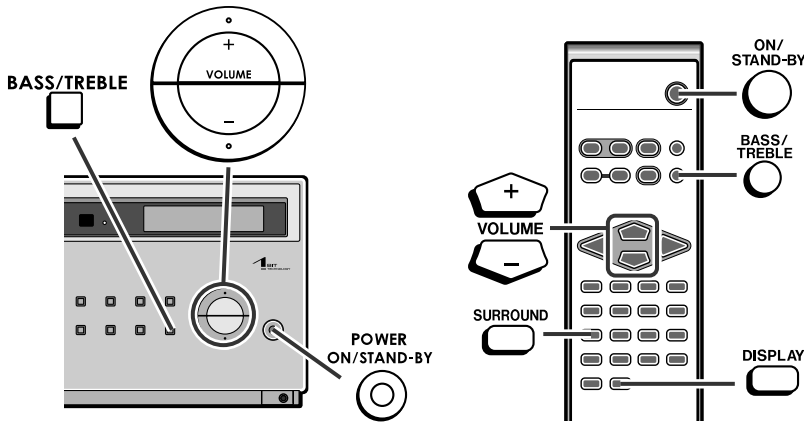

## ■ To turn the power on

Press the ON/STAND-BY button to turn the power on.

If the power does not turn on, check the AC power cord is plugged in properly.

### After use:

Press the ON/STAND-BY button to enter the power stand-by mode.

### Note:

When turning on the power right after it is set to the stand-by mode, wait a few seconds.

## ■ To change the display brightness (2 levels)

When the power is on, you can switch the display brightness by pressing the DISPLAY button on the remote control.

For example, CD function

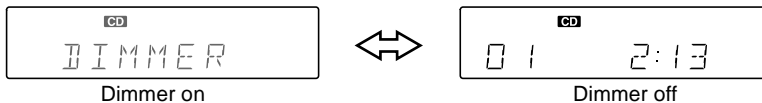

## ■ Volume control

Press the VOLUME (+ or -) button to increase or decrease the volume.

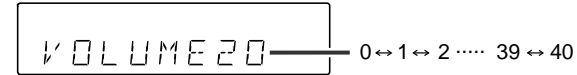

## ■ Bass control

- 1 Press the BASS/TREBLE button to select "BASS".
- 2 Within 3 seconds, press the VOLUME (+ or -) button to adjust the bass.

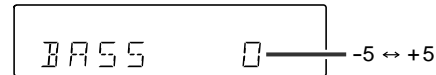

## ■ Treble control

- 1 Press the BASS/TREBLE button to select "TREBLE".
- 2 Within 3 seconds, press the VOLUME (+ or -) button to adjust the treble.

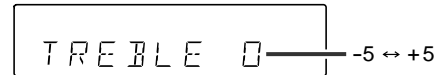

## ■ Surround

Press the SURROUND button to enjoy music that seems to surround you. "SURROUND" will appear.

To cancel the surround mode, press the SURROUND button again.

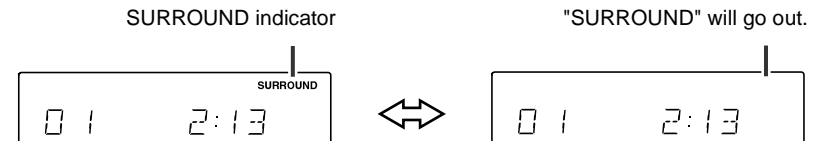

# Setting the clock

By setting the unit to the correct time, you can use it not only as a clock but also for timer playback.

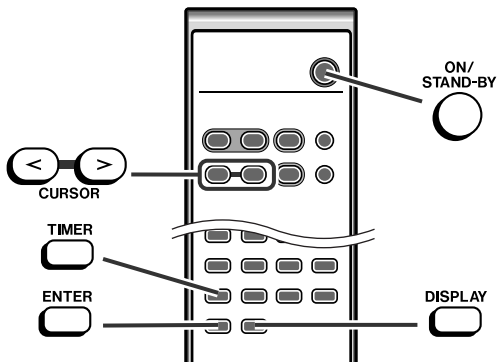

In this example, the clock is set for the 12-hour (AM 12:00) display.

**1** Press the ON/STAND-BY button to turn the power on.

**2** Press the TIMER button.

**3** Within 10 seconds, press the CURSOR (< or >) button to select "CLOCK", and press the ENTER button.

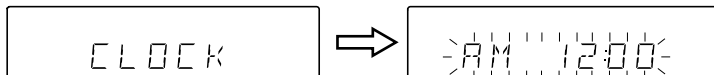

**4** Press the CURSOR (< or >) button to select 12-hour or 24-hour display and then press the ENTER button.

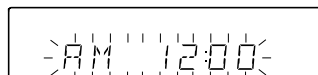

"AM 12:00" → The 12-hour display will appear. (AM 12:00 - PM 11:59)

"AM 0:00" → The 12-hour display will appear. (AM 0:00 - PM 11:59)

"0:00" → The 24-hour display will appear. (0:00 - 23:59)

Note that this can only be set when the unit is first installed or it has been reset.  
[ Refer to "Clearing all the memory (reset)" on page 27 for details.]

**5** Press the CURSOR (< or >) button to adjust the hour and then press the ENTER button.



- Press the CURSOR (< or >) button once to advance the time by 1 hour. Hold it down to advance continuously.
- When the 12-hour display is selected, "AM" will change automatically to "PM".

**6** Press the CURSOR (< or >) button to adjust the minutes and then press the ENTER button.

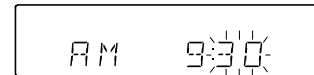

- Press the CURSOR (< or >) button once to advance the time by 1 minute. Hold it down to advance by 5 minutes.
- The hour will not advance even if minutes advance from "59" to "00".
- The clock begins counting from "0" seconds. (Seconds are not displayed.) The time display will disappear after a few seconds.

**To confirm the time display:**

[ When the unit is in the stand-by mode]  
Press the DISPLAY button on the remote control.  
The time display will appear for about 5 seconds.

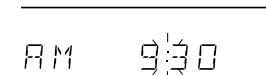

[ When the power is on]  
Press the TIMER button.  
Within 10 seconds, press the CURSOR (< or >) button to display the time.  
The time display will appear for about 10 seconds.

**Note:**

The "CLOCK" will appear at the push of the DISPLAY button when the AC power supply is restored after a power failure or unplugging the unit.  
Readjust the clock as follows.

**To readjust the clock:**

Perform "Setting the clock" from the beginning.

**To change the 12-hour or 24-hour display:**

1. Clear all the programmed contents. [ Refer to "Clearing all the memory (reset)" on page 27 for details.]
2. Perform "Setting the clock" from the beginning.

# Listening to a CD

This system can also play audio CD-R and CD-RW discs, but cannot record. Some audio CD-R and CD-RW discs may not be playable due to the state of disc or the device that was used for recording.

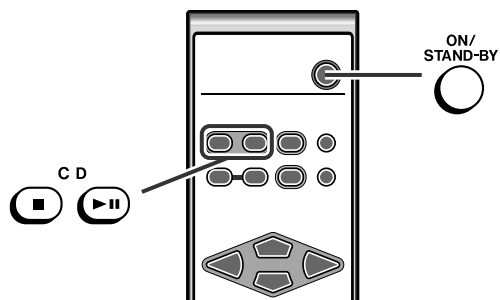
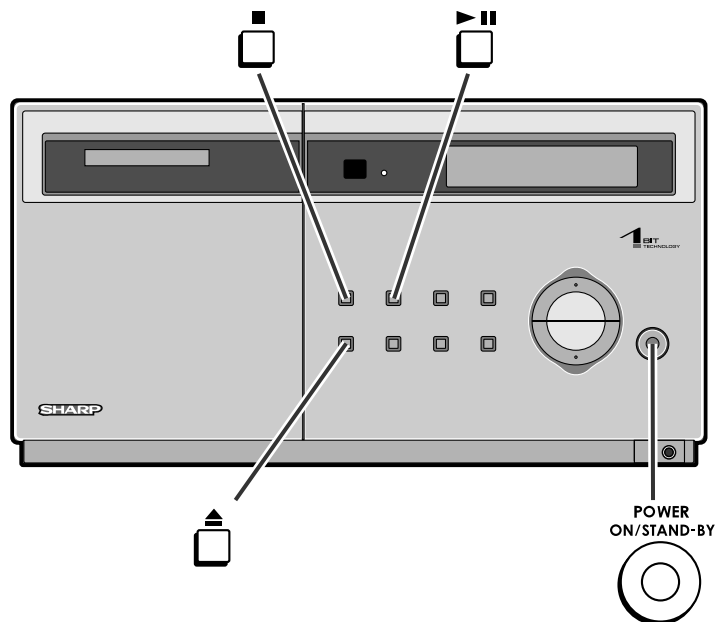

**1 Press the ON/STAND-BY button to turn the power on.**

**2 Press the ■ button.**

**3 Press the ▲ button to open the CD cover.**

**4 Place a CD on the spindle.**

- Face the label side toward you.
- Place a CD on the spindle properly to avoid scratches.

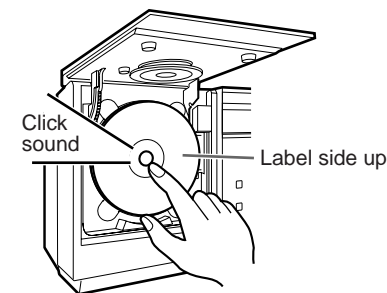

**5 Press the ▲ button to close the CD cover.**

**6 Press the ►|| button to start playback.**

When the last track on the disc has finished playing, the CD player will automatically stop.

## To interrupt playback:

Press the ►|| button.

To resume playback from the same point, press the ►|| button again.

## To stop playback:

Press the ■ button.

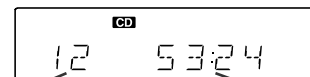

Total number of tracks

Total playing time

## After use:

Press the ON/STAND-BY button to enter the power stand-by mode.



# Advanced CD Playback

## ■ To remove the CD

- 1 While in the stop mode, press the ▲ button.
- 2 Press the CD eject button and remove the CD.
- 3 Press the ▲ button to close the CD cover.

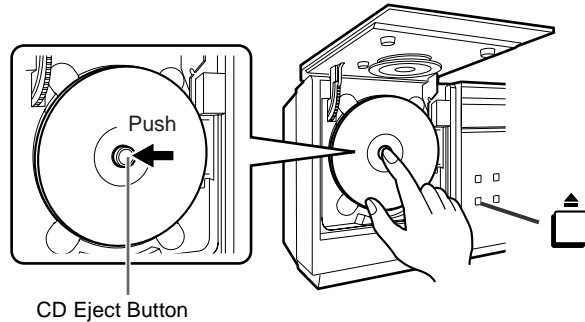

### Caution:

- Do not open or close the CD cover manually. It may cause malfunctions to the unit.
- Be careful not to jam your fingers in the CD cover.
- Do not play discs with special shapes (heart- or octagon-shaped). It may cause malfunctions.
- If the power fails while the CD cover is open, wait until the power is restored.
- Keep foreign objects out of the CD compartment.
- When the unit is not being used, be sure to close the CD cover. If it is left open, the lens may be covered with dust and the unit may not operate properly.
- When the unit enters the stand-by mode, the opened CD cover will be close automatically.

### Notes:

- Subjecting the unit to shock or vibration may cause mistracking.
- **Playing certain CD at a high volume may cause mistracking. In this case, listen at a lower volume.**
- If the recorded side of the CD is touched or becomes dirty, refer to "Care of compact discs" (page 28) and clean it.
- If a disc is damaged or dirty, the sound may skip.
- If an error message is displayed during CD operation, see "Error messages" on page 28.
- If TV or radio interference occurs during CD operation, move the unit away from the TV or radio.

## ■ To locate the beginning of a track

### To move to the beginning of the next track:

Press the ►► button during playback.

- You can skip to any track by pressing the ►► button repeatedly until the desired track number appears.

### To restart the track being played:

Press the ◀◀ button during playback.

- You can skip to any track by pressing the ◀◀ button repeatedly until the desired track number appears.

## ■ To locate the desired portion

### For audible fast forward:

Press and hold down the ►► button during playback.

### For audible fast reverse:

Press and hold down the ◀◀ button during playback.

### Notes:

- Normal playback will resume when the ◀◀ or ►► button is released.
- When the end of the last track is reached during fast forward, "END" will appear on the display and CD operation will be paused. When the beginning of the first track is reached during fast reverse, the unit will enter the playback mode.

### To search very quickly:

When fast forward or fast reverse is used while in the pause mode, the playback point will move more quickly than when using audible fast forward or audible fast reverse playback.

- In this mode, no sound is heard. Therefore, you should refer to the time display.
- When you lift your finger, the unit will re-enter the pause mode.

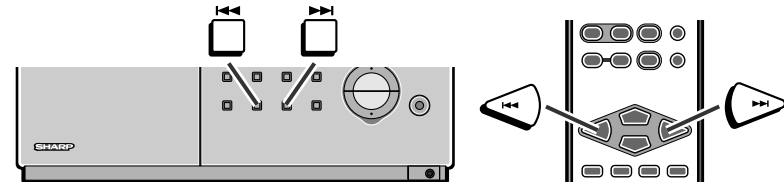

# Advanced CD Playback (continued)

## ■ Direct play

By using the direct buttons, the desired tracks can be played.

### Press the direct buttons to select the desired track.

The direct buttons will allow you to select and play any track from 1 to 10 automatically.

### To select a track between 11 and 99:

Press the "> 10" button followed by the two digits of the track number.

### For example, to choose 28

- 1 Press the "> 10" button.
- 2 Press the "2" button.
- 3 Press the "8" button.

### Notes:

- After pressing the "> 10" button, the two digits must be entered within 5 seconds of each other.
- It is not possible to enter a track number higher than the total tracks of the CD.
- You cannot select a track with the direct buttons while in random or program play.

## ■ Switching the time display

Each time the TIME button on the remote control is pressed during playback, the display will change.

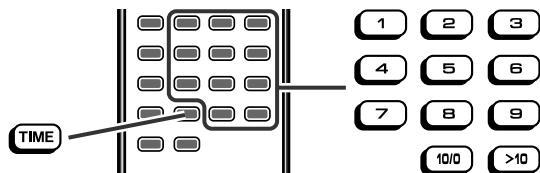
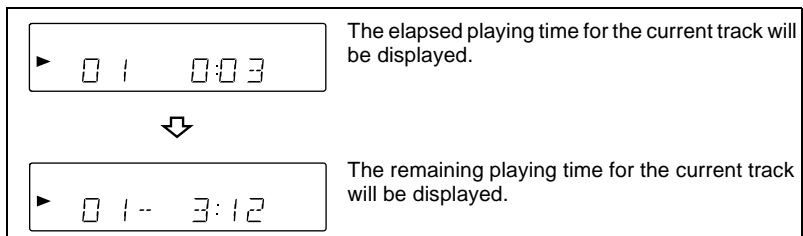

## ■ Repeat or random play

You can select one of the CD playback mode; "Repeat play", "Random play" and "Normal play".

- 1 When in the CD mode, press the PLAY MODE button repeatedly to select the playback mode.

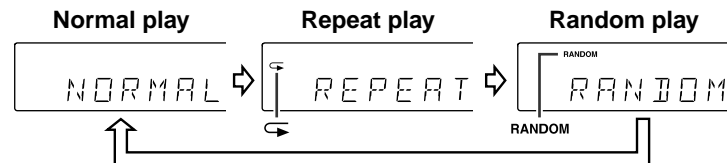

- 2 Press the ►|| button to start playback.

### To repeat a programmed sequence:

Perform steps 1 - 5 in the "Programmed Play" section and then select the repeat playback.

### Notes:

- During program operation, the random mode cannot be selected by the PLAY MODE button.
- After using repeat play, be sure to press the ■ button. Otherwise, the disc will play continuously.
- The random play will stop automatically when all tracks are played once. (The same track will not be played back twice.)
- In random play, the CD player will select and play tracks automatically. (You cannot select the order of the tracks.)

### To cancel repeat or random play:

Press the PLAY MODE button repeatedly to select the normal play mode.

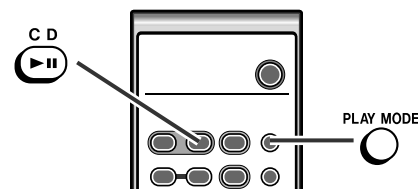

## ■ Programmed play

You can choose up to 20 selections for playback in the order you like.

**1** Press the **■** button.

**2** Press the **MEMORY** button to enter the programming save mode.



**3** Press the direct buttons to select the desired track.

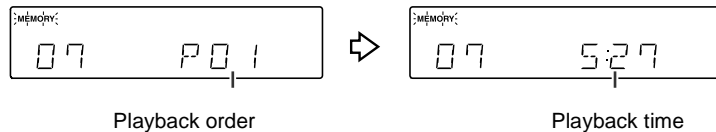

You can program the track by pressing the MEMORY button after selecting it with the **◀◀** or **▶▶** button.

**4** Repeat step 3 for any other track. Up to 20 tracks can be programmed.

**5** Press the **■** button.

**6** Press the **▶||** button to start playback.

### To clear the programmed selections:

Press the CLEAR button while the "MEMORY" indicator is flashing. Each time the button is pressed, one track will be cleared, beginning with the last track programmed.

### To cancel the programmed play mode:

While in the stop mode and the "MEMORY" indicator is lit, press the CLEAR button on the remote control. The "MEMORY" indicator will disappear and all the programmed contents will be cleared.

### Adding tracks to the program:

If a program has been previously stored, the "MEMORY" indicator will be displayed. Then follow steps 1 - 5 to add tracks. The new tracks will be stored after the last track of the original program.

### To check which tracks are programmed:

While the unit is stopped in the programmed play mode, press the **◀◀** or **▶▶** button. Each time the button is pressed, track numbers will be displayed in order.

### Notes:

- Ejecting a CD automatically cancels the programmed sequence.
- Even if you press the ON/STAND-BY button to enter the stand-by mode or the function is changed from CD to some other, the programmed selections will not be cleared.
- During program operation, random play is not possible.
- Programmed tracks will be erased if the unit is unplugged or a power failure occurs.

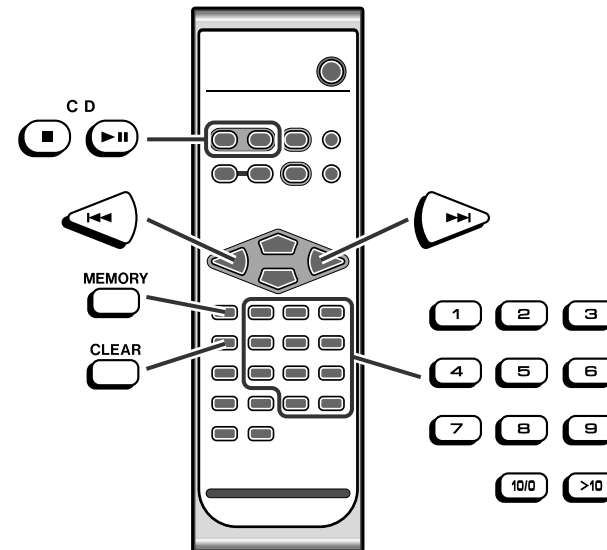

# Listening to the radio

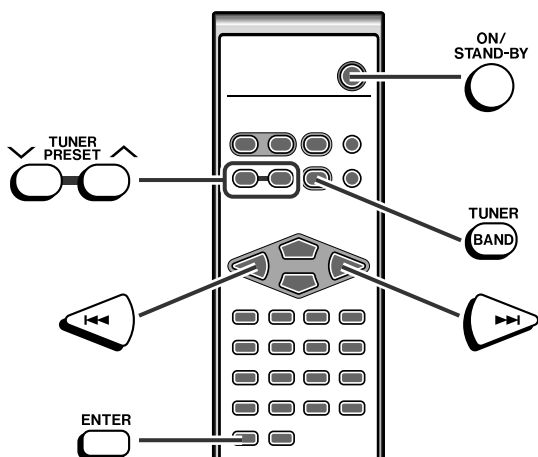
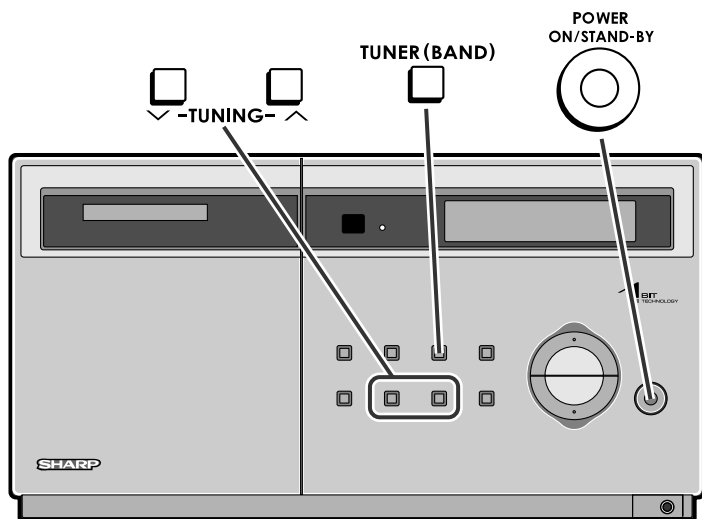

## Manual or Auto tuning

- 1 Press the ON/STAND-BY button to turn the power on.
- 2 Press the TUNER (BAND) button repeatedly to select the desired frequency band.

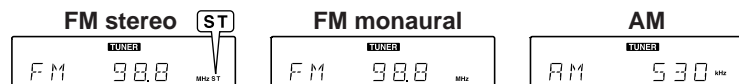

- 3 Press the TUNING ( $\vee$  or  $\wedge$ ) button to tune in to the desired station.

You can tune in to the desired station by pressing the  $\lll$  or  $\ggg$  button on the remote control.

### Manual tuning:

Press the TUNING button as many times as required to tune in to the desired station.

### Auto tuning:

When the TUNING button is pressed for 0.5 seconds or more, scanning will start automatically and the tuner will stop at the first receivable broadcast station.

### Notes:

- When radio interference occurs, auto scan tuning may stop automatically at that point.
- Auto scan tuning will skip weak signal stations.
- To stop the auto tuning, press the TUNING button again.

### To receive an FM stereo transmission:

Press the TUNER (BAND) button to display the "ST" indicator.

- "∞" will appear when an FM broadcast is in stereo.



- If the FM reception is weak, press the TUNER (BAND) button to extinguish the "ST" indicator. The reception changes to monaural, and the sound becomes clearer.

### After use:

Press the ON/STAND-BY button to enter the power stand-by mode.

## ■ Memorizing a station

You can store 40 AM and FM stations in memory and recall them at the push of a button. (Preset tuning)

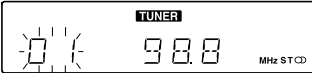
- 1 Perform steps 1 - 3 in "Manual or Auto tuning" on page 20.**
- 2 Press the ENTER button to enter the preset tuning saving mode.**
- 3 Within 5 seconds, press the TUNER PRESET (∨ or ∧) button to select the preset channel number.**

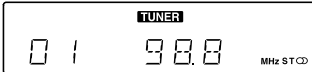
Store the stations in memory, in order, starting with preset channel 1.
- 4 Within 5 seconds, press the ENTER button to store that station in memory.**

If the preset number indicator goes out before the station is memorized, repeat the operation from step 2.
- 5 Repeat steps 1 - 4 to set other stations, or to change a preset station.**

When a new station is stored in memory, the station previously memorized will be erased.

### Note:

The backup function protects the memorized stations for a few hours should there be a power failure or if the AC power cord is disconnected.

## ■ To recall a memorized station

This may be operated only with the remote control.

### To select a preset station with the TUNER PRESET buttons:

Press the TUNER PRESET (∨ or ∧) button to select the desired station.

### To select a preset station with the direct buttons:

**Station 1 - 10:** press the corresponding number ("1" - "10/0").

**Station 11 - 40:** press the "> 10" button followed by the two-digit number.

### For example, to choose 28

- 1 Press the "> 10" button.
- 2 Press the "2" button.
- 3 Press the "8" button.

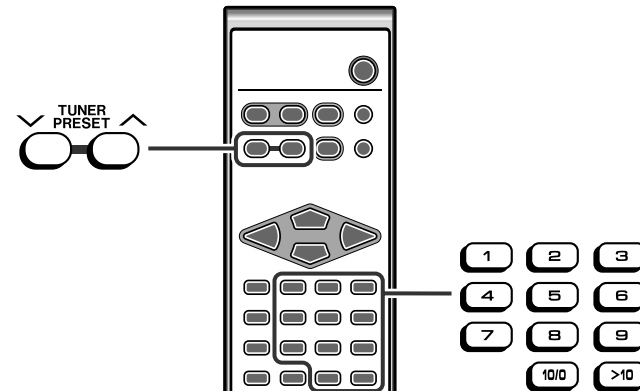

# Timer and sleep operation

This may be operated only with the remote control.

## Timer playback:

The unit turns on and plays the desired source (CD, tuner) at the preset time.

## Sleep operation:

The radio and compact disc player can be turned off automatically.

### Before setting timer:

- 1 Set the unit to the correct time (page 15).  
If it is not set, you cannot use the timer function.
- 2 Prepare the sound source for playback.
- 3 Store radio stations (page 21).

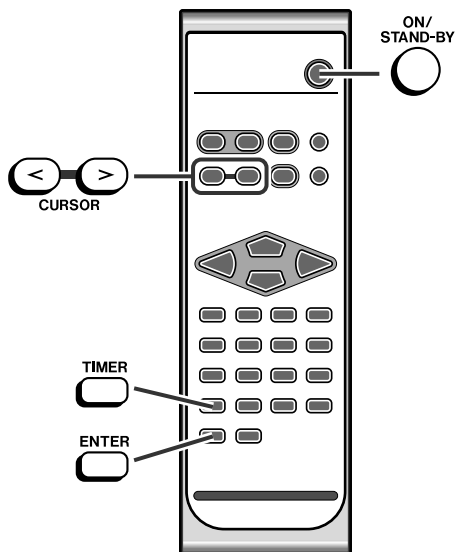

## ■ Timer playback

<b>1</b> Press the ON/STAND-BY button to turn the power on.	
<b>2</b> Press the TIMER button.	
<b>3</b> Within 10 seconds, press the CURSOR (< or >) button to select "TIMER".	
<b>4</b> Within 10 seconds, press the ENTER button.	
<b>5</b> Press the CURSOR (< or >) button to specify the hour to start, and press the ENTER button.	
<b>6</b> Press the CURSOR (< or >) button to specify the minutes, and press the ENTER button. Unless the timer setting is changed, the ending time will automatically be set for one hour after the starting time.	
<b>7</b> Press the CURSOR (< or >) button to specify the hour to stop, and press the ENTER button.	
<b>8</b> Press the CURSOR (< or >) button to specify the minutes, and press the ENTER button.	

**9** Press the **CURSOR (< or >)** button to select the desired function (CD, TUNER or AUX).

**10** Press the **ENTER** button.

When you select the tuner, select a station by pressing the **CURSOR (< or >)** button, and then press the **ENTER** button.

If a station has not been programmed, "NO P-SET" will appear.

**11** Press the **CURSOR (< or >)** button to adjust the volume.

Be careful not to turn the volume up too high.

**12** Press the **ENTER** button.

Settings are displayed in order and the unit will enter the timer stand-by mode.

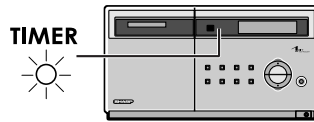

#### To check the timer setting:

- 1 While in the timer playback stand-by mode, press the **TIMER** button.
- 2 Within 10 seconds, press the **CURSOR (< or >)** button to select "CALL", and press the **ENTER** button.

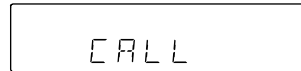

The unit returns to the timer playback stand-by mode after the setting contents are displayed in order.

#### When the start time is reached:

Playback starts automatically and the volume increases gradually.

The timer playback indicator flashes.



Timer Play Indicator

#### When the finish time is reached:

The unit is set to the power stand-by mode automatically.

#### Reusing the memorized timer setting:

The timer setting will be memorized once it is entered. To reuse the same setting, perform the following operations.

- 1 Turn the power on and press the **TIMER** button.  
Set the unit to the correct time if "STANDBY" does not appear.
- 2 Within 10 seconds, press the **ENTER** button.  
After the setting contents are displayed in order, the unit is set to the timer playback stand-by mode.

#### Changing the timer setting:

Turn the power on, and repeat the operation from step 2 in "Timer playback" (see pages 22 - 23).

#### Canceling the timer playback:

Timer playback is canceled by turning the power on while in the timer playback stand-by mode. The same operation can be performed in the following procedure without turning the power on.

- 1 Press the **TIMER** button.  
"CANCEL" will appear.



- 2 Within 10 seconds, press the **ENTER** button.  
Timer playback will be canceled (the contents of the setting will not be canceled).

#### Caution:

The contents of the setting will be erased if the unit is unplugged or a power failure occurs. In such cases, set the timer again.

#### Notes:

- The timer playback is possible with a CD even if the repeat, random, or programmed playback is set.
- When performing timer playback using another unit connected to the AUX IN jacks, select "AUX" in step 9. At this time, only this unit will be turned on or enter the power stand-by mode automatically. (Another unit will not be turned on or off.)

# Timer and sleep operation (continued)

## ■ Sleep operation

The radio and CD can be turned off automatically.

<b>1</b> Play back the desired sound source.	
<b>2</b> Press the <b>TIMER</b> button.	
<b>3</b> Within 10 seconds, press the <b>CURSOR</b> (< or >) button to select "SLEEP".	
<b>4</b> Within 10 seconds, press the <b>ENTER</b> button.	
<b>5</b> Press the <b>CURSOR</b> (< or >) button to specify the sleep time.	 (Maximum: 2 hours - Minimum: 1 minute)
<b>6</b> Press the <b>ENTER</b> button.	
<b>7</b> Your system will enter the power stand-by mode automatically after the preset time has elapsed. The volume will be turned down 1 minute before the sleep operation finishes.	

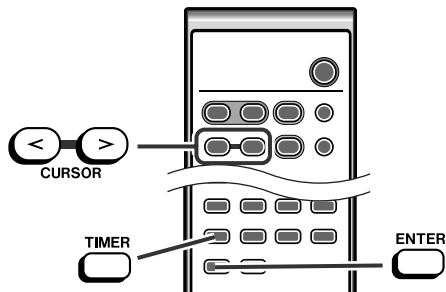

### To confirm the remaining sleep time:

- 1 Press the **TIMER** button while the sleep timer is set.
- 2 Within 10 seconds, press the **CURSOR** (< or >) button to select "SLEEP".

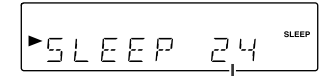

Remaining sleep time

- The remaining sleep time is displayed for about 10 seconds.
- You can change the remaining sleep time while it is displayed by pressing the **ENTER** button (steps 5 - 6).

### To cancel the sleep operation:

The sleep timer is canceled when the unit enters the power stand-by mode. To cancel only the sleep timer without setting the unit to the power stand-by mode, proceed as follows.

- 1 Press the **TIMER** button while the sleep timer is set.
- 2 Within 10 seconds, press the **CURSOR** (< or >) button to select "SLEEPOFF".
- 3 Within 10 seconds, press the **ENTER** button.

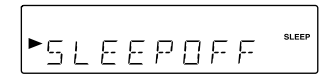

## ■ To use timer and sleep operation together

Example: You can fall asleep to the radio and wake up with the sound from a CD.

- 1 Set the sleep time (steps 1 - 6, page 24).

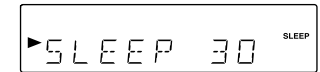

- 2 Set the timer playback (steps 1 - 12, pages 22 - 23).

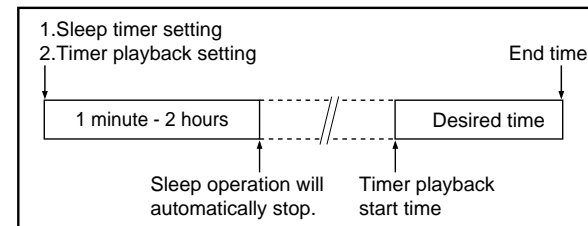



# Enhancing your system

- The connection cord is not included. Purchase a commercially available cord as shown below.
- Before connecting external units, set this unit to the power stand-by mode and turn off the power to the external units.

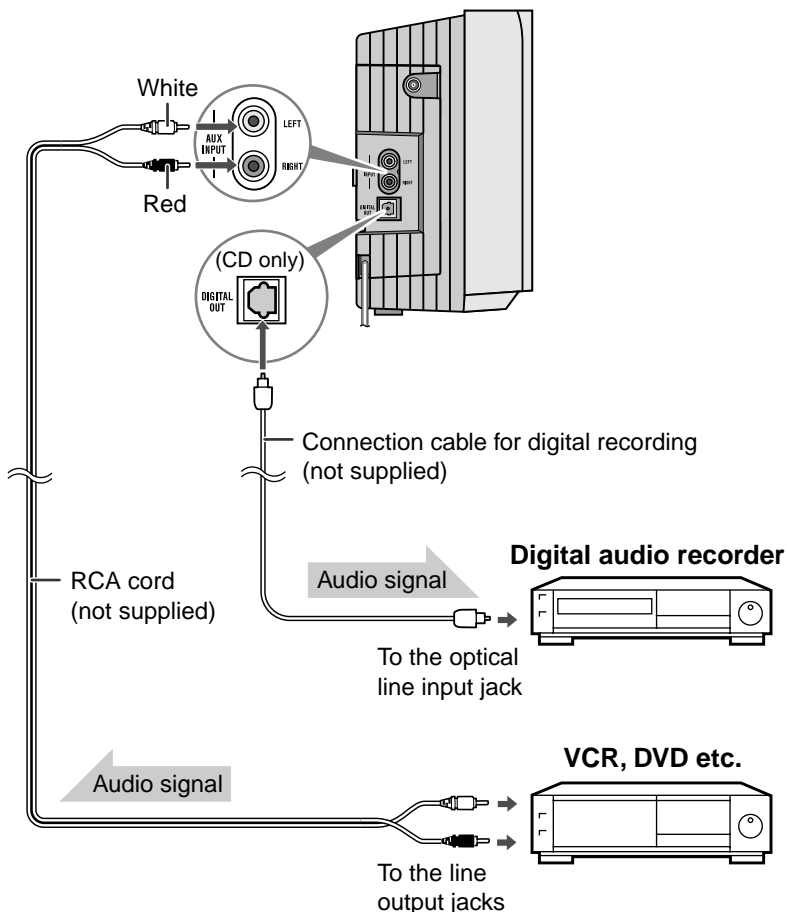

## ■ Listening to the playback sounds from VCR, DVD, etc.

- 1 Use a connection cord to connect the VCR, DVD, etc. to the AUX INPUT jacks. When using video equipment, connect the audio output to this unit and the video output to a television.
- 2 Press the ON/STAND-BY button to turn the power on.
- 3 Press the AUX button.
- 4 Play the VCR, DVD, etc.

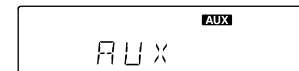

### Note:

To prevent hum interference, place this unit away from a television.

## ■ To record CD signals on external digital audio recorders

The digital signal from this unit can be recorded by digital audio recorders, MiniDisc recorders and other devices equipped with an optical digital audio input.

- 1 Open the left side cover and then remove the DIGITAL OUT jack cover.
- 2 Close the left side cover (see page 13).
- 3 Use an optical connection cable for digital recording to connect the unit to the OPTICAL IN jack of digital audio recorders, etc.
- 4 Press the ON/STAND-BY button to turn the power on.
- 5 Put the MiniDisc recorder, etc. in the recording mode.
- 6 Play a CD on this unit.

### Notes:

- When using the optical digital jack, remove the cap first. After using the jack, replace the cap.
- Only CD signals can be output.

## ■ Headphones

- Before plugging in or unplugging the headphones, reduce the volume.
- Be sure your headphones have a 1/8" (3.5 mm) diameter plug and are between 16 ohms and 50 ohms impedance. The recommended impedance is 32 ohms.
- Plugging in the headphones disconnects the speakers automatically. Adjust the volume using the VOLUME buttons.

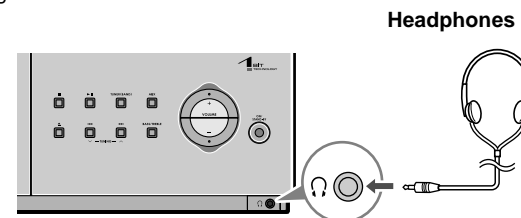

# Troubleshooting chart

Many potential problems can be resolved by the owner without calling a service technician.

If something is wrong with this product, check the following before calling your authorized SHARP dealer or service center.

## ■ General

Symptom	Possible cause
<ul style="list-style-type: none"> <li>● "CLOCK" appears when the clock time is checked.</li> </ul>	<ul style="list-style-type: none"> <li>● Did a power failure occur? Reset the clock. (Refer to page 15.)</li> </ul>
<ul style="list-style-type: none"> <li>● When a button is pressed, the unit does not respond.</li> </ul>	<ul style="list-style-type: none"> <li>● Set this unit to the power stand-by mode and then turn it back on.</li> <li>● If the unit still malfunctions, reset it. (Refer to page 27.)</li> </ul>
<ul style="list-style-type: none"> <li>● No sound is heard.</li> </ul>	<ul style="list-style-type: none"> <li>● Is the volume level set to "0"?</li> <li>● Are the headphones connected?</li> <li>● Are the speaker wires disconnected?</li> </ul>
<ul style="list-style-type: none"> <li>● The picture on the TV screen is distorted.</li> </ul>	<ul style="list-style-type: none"> <li>● When a radio or TV which uses an indoor antenna is placed near the unit, the picture on the TV screen may be distorted or the radio may not function properly.</li> <li>● It is recommended that you use an outdoor antenna.</li> </ul>

## ■ Tuner

Symptom	Possible cause
<ul style="list-style-type: none"> <li>● The radio makes unusual noises continuously.</li> </ul>	<ul style="list-style-type: none"> <li>● Is the unit placed near the TV or computer?</li> <li>● Is the FM/AM loop antenna placed properly? Move the antenna away from the AC power cord if located near.</li> </ul>
<ul style="list-style-type: none"> <li>● The preset channel cannot be recalled.</li> </ul>	<ul style="list-style-type: none"> <li>● Did a power failure occur? Preset the channel again.</li> </ul>

## ■ CD player

Symptom	Possible cause
<ul style="list-style-type: none"> <li>● Even though a disc has been loaded, "NO DISC" is displayed.</li> </ul>	<ul style="list-style-type: none"> <li>● Is the disc very dirty?</li> <li>● Is the unit located near excessive vibrations?</li> <li>● Has condensation formed inside the unit?</li> </ul>
<ul style="list-style-type: none"> <li>● Playback does not start.</li> </ul>	<ul style="list-style-type: none"> <li>● Is the disc loaded with the label side toward you?</li> </ul>
<ul style="list-style-type: none"> <li>● Playback stops in the middle or is not performed properly.</li> </ul>	<ul style="list-style-type: none"> <li>● Does the disc satisfy the standards?</li> <li>● Is the disc distorted or scratched?</li> </ul>
<ul style="list-style-type: none"> <li>● Playback sounds are skipped, or stopped in the middle of a track.</li> </ul>	<ul style="list-style-type: none"> <li>● Is the unit located near excessive vibrations?</li> <li>● Is the disc very dirty?</li> <li>● Has condensation formed inside the unit?</li> </ul>

## ■ Remote control

Symptom	Possible cause
<ul style="list-style-type: none"> <li>● The remote control does not operate.</li> </ul>	<ul style="list-style-type: none"> <li>● Is the AC power cord of the unit plugged in?</li> <li>● Is the battery polarity correct?</li> <li>● Are the batteries dead?</li> <li>● Is the distance or angle incorrect?</li> <li>● Does the remote control sensor receive strong light?</li> </ul>

## ■ If trouble occurs

When this product is subjected to strong external interference (mechanical shock, excessive static electricity, abnormal supply voltage due to lightning, etc.) or if it is operated incorrectly, it may malfunction.

### If such a problem occurs, do the following:

- 1 Set the unit to the power stand-by mode and turn the power on again.
- 2 If the unit is not restored in the previous operation, unplug and plug in the unit, and then turn the power on.

#### Note:

If neither operation above restores the unit, clear all the memory by resetting it.

## ■ Clearing all the memory (reset)

- 1 Press the ON/STAND-BY button to enter the power stand-by mode.
- 2 While pressing down the ►| button and the VOLUME (-) button, press the ON/STAND-BY button until "RESET" appears.

#### Caution:

This operation will erase all data stored in memory including clock, timer settings, tuner preset, and CD program.

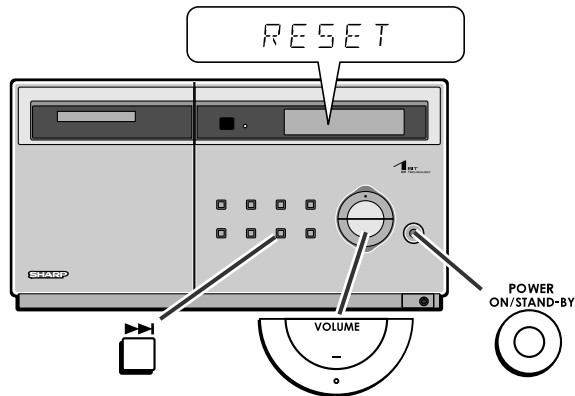

## ■ Before transporting the unit

Carrying the unit with a CD inside can cause damage to the unit or the CD. Please open the CD cover to check the CD compartment is empty before transportation. (Refer to page 17.)

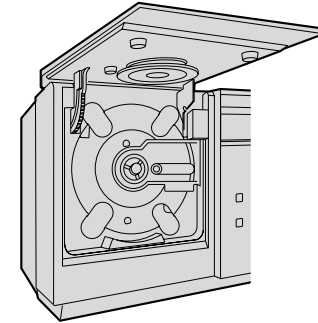

## ■ Condensation

Sudden temperature changes, storage or operation in an extremely humid environment may cause condensation inside the cabinet (CD pickup, etc.) or on the transmitter on the remote control.

Condensation can cause the unit to malfunction. If this happens, leave the power on with no disc in the unit until normal playback is possible (about 1 hour). Wipe off any condensation on the transmitter with a soft cloth before operating the unit.

# Maintenance

## ■ Cleaning the CD pickup lens

Poor performance during CD playback (skipping or jumping) can be caused by a dirty or contaminated CD laser pickup lens, in this case cleaning may be required. Clean the lens gently with a dry cotton swab taking care not to touch the lens with your fingers.

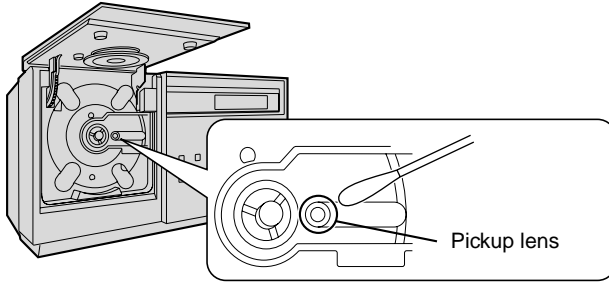

## ■ Cleaning the cabinet

Periodically wipe the cabinet with a soft cloth and a diluted soap solution, then with a dry cloth.

### Caution:

- Do not use chemicals for cleaning (gasoline, paint thinner, etc.). It may damage the cabinet finish.
- Do not apply oil to the inside of the unit. It may cause malfunctions.

## ■ Care of compact discs

Compact discs are fairly resistant to damage, however mistracking can occur due to an accumulation of dirt on the disc surface. Follow the guidelines below for maximum enjoyment from your CD collection and player.

- Do not write on either side of the disc, particularly the non-label side from which signals are read. Do not mark this surface.
- Keep your discs away from direct sunlight, heat, and excessive moisture.
- Always hold the CDs by the edges. Fingerprints, dirt, or water on the CDs can cause noise or mistracking. If a CD is dirty or does not play properly, clean it with a soft, dry cloth, wiping straight out from the center, along the radius.

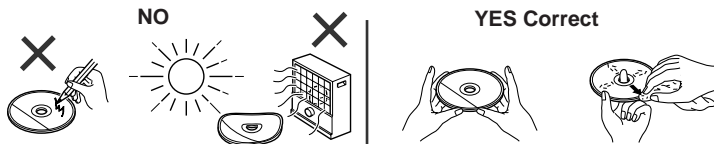

# Error messages

Error messages	Meaning	Remedy
<b>NO DISC</b>	<ul style="list-style-type: none"> <li>● The disc is damaged.</li> <li>● A CD has not been loaded.</li> <li>● The CD data cannot be read.</li> </ul>	<ul style="list-style-type: none"> <li>● Replace it with another disc.</li> <li>● Ensure that the CD is correctly inserted with the label side toward you.</li> <li>● Load a CD.</li> <li>● Reload the CD.</li> </ul>
<b>FAN LOCK</b>	<ul style="list-style-type: none"> <li>● The cooling fan inside the unit does not run due to foreign objects around the fan.</li> </ul>	<ul style="list-style-type: none"> <li>● Set this unit to the stand-by mode and remove the foreign objects around the fan.</li> </ul>

# Specifications

As part of our policy of continuous improvement, SHARP reserves the right to make design and specification changes for product improvement without prior notice. The performance specification figures indicated are nominal values of production units. There may be some deviations from these values in individual units.

## ■ General

<b>Power source</b>	AC 120 V, 60 Hz
<b>Power consumption</b>	76 W
<b>Dimensions</b>	Width: 15"(380 mm) Height: 7-7/8"(200 mm) Depth: 4-3/4"(120 mm)
<b>Weight</b>	7.5 lbs. (3.4 kg)
<b>Output terminals</b>	Speakers: 4 ohms Headphones: 16 - 50 ohms (recommended: 32 ohms) Digital output (optical)
<b>Input terminals</b>	Auxiliary input: 500 mV/47 k ohms

## ■ Amplifier

<b>Amplification system</b>	64fs 1-bit switching (Remarks: fs = 44.1 kHz)
<b>Power output</b>	100 watts minimum RMS per channel into 4 ohms from 40 Hz to 20 kHz, 2 % total harmonic distortion
<b>A/D noise shaping</b>	7th-order $\Delta\Sigma$ (delta - sigma) modulation

## ■ CD player

<b>Type</b>	1-disc vertical type compact disc player
<b>Signal readout</b>	Non-contact, 3-beam semiconductor laser pickup
<b>D/A converter</b>	24-bit/96 k D/A converter
<b>Frequency response</b>	20 - 20,000 Hz
<b>Dynamic range</b>	101 dB (1 kHz)

## ■ Tuner

<b>Frequency range</b>	FM: 87.5 - 108 MHz AM: 530 - 1.720 kHz
------------------------	---

## ■ Speaker

<b>Type</b>	2-way type speaker system 2" (5 cm) Tweeter 5-7/8" (15 cm) Woofer
<b>Maximum input power</b>	200 W
<b>Rated input power</b>	100 W
<b>Impedance</b>	4 ohms
<b>Dimensions</b>	Width: 7-1/2" (190 mm) Height: 11-7/16" (290 mm) Depth: 9-5/16" (235 mm)
<b>Weight</b>	8.4 lbs. (3.8 kg)/each

## CONSUMER LIMITED WARRANTY

SHARP ELECTRONICS CORPORATION warrants to the first consumer purchaser that this Sharp brand product (the "Product"), when shipped in its original container, will be free from defective workmanship and materials, and agrees that it will, at its option, either repair the defect or replace the defective Product or part thereof with a new or remanufactured equivalent at no charge to the purchaser for parts or labor for the period(s) set forth below.

This warranty does not apply to any appearance items of the Product nor to the additional excluded item(s) set forth below nor to any Product the exterior of which has been damaged or defaced, which has been subjected to improper voltage or other misuse, abnormal service or handling, or which has been altered or modified in design or construction.

In order to enforce the rights under this limited warranty, the purchaser should follow the steps set forth below and provide proof of purchase to the servicer.

The limited warranty described herein is in addition to whatever implied warranties may be granted to purchasers by law. ALL IMPLIED WARRANTIES INCLUDING THE WARRANTIES OF MERCHANTABILITY AND FITNESS FOR USE ARE LIMITED TO THE PERIOD(S) FROM THE DATE OF PURCHASE SET FORTH BELOW. Some states do not allow limitations on how long an implied warranty lasts, so the above limitation may not apply to you.

Neither the sales personnel of the seller nor any other person is authorized to make any warranties other than those described herein, or to extend the duration of any warranties beyond the time period described herein on behalf of Sharp.

The warranties described herein shall be the sole and exclusive warranties granted by Sharp and shall be the sole and exclusive remedy available to the purchaser. Correction of defects, in the manner and for the period of time described herein, shall constitute complete fulfillment of all liabilities and responsibilities of Sharp to the purchaser with respect to the Product, and shall constitute full satisfaction of all claims, whether based on contract, negligence, strict liability or otherwise. In no event shall Sharp be liable, or in any way responsible, for any damages or defects in the Product which were caused by repairs or attempted repairs performed by anyone other than an authorized servicer. Nor shall Sharp be liable or in any way responsible for any incidental or consequential economic or property damage. Some states do not allow the exclusion of incidental or consequential damages, so the above exclusion may not apply to you. THIS WARRANTY GIVES YOU SPECIFIC LEGAL RIGHTS. YOU MAY ALSO HAVE OTHER RIGHTS WHICH VARY FROM STATE TO STATE.

### **Model Specific Section**

#### **Your Product Model Number & Description:**

**SD-EX200 1-Bit Digital Audio System**

(Be sure to have this information available when you need service for your Product.)

#### **Warranty Period for this Product:**

One (1) year parts and labor from the date of purchase.

#### **Additional Item(s) Excluded from Warranty Coverage (if any):**

Non-functional accessories, supplies, and consumable items.

#### **Where to Obtain Service:**

At a Sharp Authorized Servicer located in the United States.  
To find a location of the nearest Sharp Authorized Servicer, call Sharp toll free at 1-800-BE-SHARP.

#### **What to do to Obtain Service:**

Ship prepaid or carry in your Product to a Sharp Authorized Servicer.  
Be sure to have **Proof of Purchase** available. If you ship the Product, be sure it is insured and packaged securely.

TO OBTAIN SUPPLY, ACCESSORY OR PRODUCT INFORMATION, CALL **1-800-BE-SHARP**.

# SHARP

**SHARP ELECTRONICS CORPORATION**

Sharp Plaza, Mahwah, New Jersey 07430-2135

**SHARP CORPORATION**

## Free Manuals Download Website

<http://myh66.com>

<http://usermanuals.us>

<http://www.somanuals.com>

<http://www.4manuals.cc>

<http://www.manual-lib.com>

<http://www.404manual.com>

<http://www.luxmanual.com>

<http://aubethermostatmanual.com>

Golf course search by state

<http://golfingnear.com>

Email search by domain

<http://emailbydomain.com>

Auto manuals search

<http://auto.somanuals.com>

TV manuals search

<http://tv.somanuals.com>