



OPERATING INSTRUCTIONS



V-903

DVD Player



Introduction

READ THIS BEFORE OPERATING YOUR UNIT

	 <p>This symbol is intended to alert the user to the presence of uninsulated "dangerous voltage" within the product's enclosure that may be of sufficient magnitude to constitute a risk of electric shock to persons.</p>
<p>CAUTION : TO REDUCE THE RISK OF ELECTRIC SHOCK, DO NOT REMOVE COVER (OR BACK). NO USER-SERVICEABLE PARTS INSIDE. REFER SERVICING TO QUALIFIED SERVICE PERSONNEL.</p>	 <p>This symbol is intended to alert the user to the presence of important operating and maintenance (servicing) instructions in the literature accompanying the appliance.</p>

WARNING : TO REDUCE THE RISK OF FIRE OR ELECTRIC SHOCK, DO NOT EXPOSE THIS APPLIANCE TO RAIN OR MOISTURE.

FCC INFORMATION(FOR U.S.A.)
 This equipment has been tested and found to comply with the limits for a Class B digital device, pursuant to Part 15 of the FCC Rules. These limits are designed to provide reasonable protection against harmful interference in a residential installation. This equipment generates, uses and can radiate radio frequency energy and, if not installed and used in accordance with the instructions, may cause harmful interference to radio communications. However, there is no guarantee that interference will not occur in a particular installation. If this equipment does cause harmful interference to radio or television reception, which can be determined by turning the equipment off and on, the user is encouraged to try to correct the interference by one or more of the following measures:

- Reorient or relocate the receiving antenna.
- Increase the separation between the equipment and receiver.
- Connect the equipment into an outlet on a circuit different from that to which the receiver is connected.
- Consult the dealer or an experienced radio/TV technician for help.

CAUTION : Any changes or modifications in construction of this device which are not expressly approved by the party responsible for compliance could void the user's authority to operate the equipment.

<div style="border: 2px solid black; padding: 10px; text-align: center;"> <p>CLASS 1 LASER PRODUCT</p> </div>	<p>CAUTION Invisible laser radiation when the unit is open. Do not stare into beam.</p>
<p>CAUTION : USE OF ANY CONTROLS, ADJUSTMENTS, OR PROCEDURES OTHER THAN THOSE SPECIFIED HEREIN MAY RESULT IN HAZARDOUS RADIATION EXPOSURE.</p>	

SAFETY INSTRUCTIONS

1. **Read Instructions** - All the safety and operating instructions should be read before the product is operated.
2. **Retain instructions** - The safety and operating instructions should be retained for future reference.
3. **Heed Warnings** - All warnings on the product and in the operating instructions should be adhered to.
4. **Follow Instructions** - All operating and use instructions should be followed.
5. **Cleaning** - Unplug this product from the wall outlet before cleaning. Do not use liquid cleaners or aerosol cleaners. Use a damp cloth for cleaning.
6. **Attachments** - Do not use attachments not recommended by the product manufacturer as they may cause hazards.
7. **Water and Moisture** - Do not use this product near water - for example, near a bath tub, wash bowl, kitchen sink, or laundry tub; in a wet basement, or near a swimming pool; and the like.
8. **Accessories** - Do not place this product on an unstable cart, stand, tripod, bracket, or table. The product may fall, causing serious injury to a child or adult, and serious damage to the product. Use only with a cart, stand, tripod, bracket, or table recommended by the manufacturer, or sold with the product. Any mounting of the product should follow the manufacturer's instructions, and should use a mounting accessory recommended by the manufacturer.
9. A product and cart combination should be moved with care. Quick stops, excessive force, and uneven surfaces may cause the product and cart combination to overturn.
10. **Ventilation** - Slots and openings in the cabinet are provided for ventilation and to ensure reliable operation of the product and to protect it from overheating, and these openings must not be blocked or covered. The openings should never be blocked by placing the product on a bed, sofa, rug, or other similar surface. This product should not be placed in a built-in installation such as a bookcase or rack unless proper ventilation is provided or the manufacturer's instructions have been adhered to.
11. **Power Sources** - This product should be operated only from the type of power source indicated on the marking label. If you are not sure of the type of power supply to your home, consult your product dealer or local power company. For products intended to operate from battery power, or other sources, refer to the operating instructions.
12. **Grounding or Polarization** - This product may be equipped with a polarized alternating-current line plug (a plug having one blade wider than the other). This plug will fit into the power outlet only one way. This is a safety feature. If you are unable to insert the plug fully into the outlet, try reversing the plug. If the plug should still fail to fit, contact your electrician to replace your obsolete outlet. Do not defeat the safety purpose of the polarized plug.
Alternate Warnings - This product is equipped with a three-wire grounding-type plug, a plug having a third (grounding) pin. This plug will only fit into a grounding-type power outlet. This is a safety feature. If you are unable to insert the plug into the outlet, contact your electrician to replace your obsolete outlet. Do not defeat the safety purpose of the grounding-type plug.
13. **Power-Cord Protection** - Power-supply cords should be routed so that they are not likely to be walked on or pinched by items placed upon or against them, paying particular attention to cords at plugs, convenience receptacles, and the point where they exit from the product.
14. **Outdoor Antenna Grounding** - If an outside antenna or cable system is connected to the product, be sure the antenna or cable system is grounded so as to provide some protection against voltage surges and built-up static charges. Article 810 of the National Electrical Code, ANSI/NFPA 70, provides information with regard to proper grounding of the mast and supporting structure, grounding of the lead-in wire to an antenna discharge unit, size of grounding conductors, location of antenna-discharge unit, connection to grounding electrodes, and requirements for the grounding electrode. See Figure 1.



PORTABLE CART WARNING

Figure 1
Example of antenna grounding as per
National Electrical Code, ANSI/NFPA 70

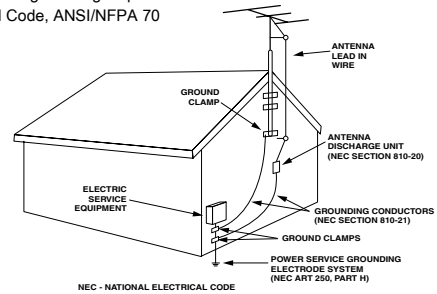

15. **Lightning** - For added protection for this product during a lightning storm, or when it is left unattended and unused for long periods of time, unplug it from the wall outlet and disconnect the antenna or cable system. This will prevent damage to the product due to lightning and power-line surges.
16. **Power Lines** - An outside antenna system should not be located in the vicinity of overhead power lines or other electric light or power circuits, or where it can fall into such power lines or circuits. When installing an outside antenna system, extreme care should be taken to keep from touching such power lines or circuits as contact with them might be fatal.
17. **Overloading** - Do not overload wall outlets, extension cords, or integral convenience receptacles as this can result in a risk of fire or electric shock.
18. **Object and Liquid Entry** - Never push objects of any kind into this product through openings as they may touch dangerous voltage points or short-out parts that could result in a fire or electric shock. Never spill liquid of any kind on the product.
19. **Servicing** - Do not attempt to service this product yourself as opening or removing covers may expose you to dangerous voltage or other hazards. Refer all servicing to qualified service personnel.
20. **Damage Requiring Service** - Unplug this product from the wall outlet and refer servicing to qualified service personnel under the following conditions:
 - a) When the power-supply cord or plug is damaged,
 - b) If liquid has been spilled, or objects have fallen into the product,
 - c) If the product has been exposed to rain or water,
 - d) If the product does not operate normally by following the operating instructions. Adjust only those controls that are covered by the operating instructions as an improper adjustment of other controls may result in damage and will often require extensive work by a qualified technician to restore the product to its normal operation.
 - e) If the product has been dropped or damaged in any way, and
 - f) When the product exhibits a distinct change in performance - this indicates a need for service.
21. **Replacement Parts** - When replacement parts are required, be sure the service technician has used replacement parts specified by the manufacturer or have the same characteristics as the original part. Unauthorized substitutions may result in fire, electric shock, or other hazards.
22. **Safety Check** - Upon completion of any service or repairs to this product, ask the service technician to perform safety checks to determine that the product is in proper operating condition.
23. **Wall or Ceiling Mounting** - The product should be mounted to a wall or ceiling only as recommended by the manufacturer.
24. **Heat** - The product should be situated away from heat sources such as radiators, heat registers, stoves, or other products (including amplifiers) that produce heat.

Notes:

1. Item 12 is not required except for grounded or polarized product.
2. Item 14 and 16 are not required except for units provided with antenna terminals.
3. Item 14 complies with UL in U.S.A.

FOR YOUR SAFETY		
U.S.A and CANADA	120 V	<p>Units shipped to the U.S.A and Canada are designed for operation on 120 V AC only.</p> <p>Safety precaution with use of a polarized AC plug. However, some products may be supplied with a nonpolarized plug.</p> <p>CAUTION : To prevent electric shock, match wide blade of plug to wide slot, fully insert.</p> <p>ATTENTION : Pour éviter chocs électriques, introduire la lame la plus large de la fiche dans la borne correspondante de la prise et pousser jusqu' au fond.</p>
CHINA, EUROPE, AUSTRALIA and other countries	220 V - 240 V	<p>The available power supply voltage differs according to country or region. However, this unit is equipped with an Automatic Voltage Selector.</p> <p>The power supply voltage of the area where the unit will be used automatically meets the required voltage within the range of AC 100 - 240 V, without any manual voltage adjustment.</p> <p>To ensure safe operation, the three-pin plug supplied must be inserted only into a standard three-pin power point which is effectively earthed through the normal household wiring. Extension cords used with the equipment must be three-core and be correctly wired to provide connection to earth.</p> <p>Improper extension cords are a major cause of fatalities. The fact that the equipment operates satisfactorily does not imply that the power point is earthed and that the installation is completely safe. For your safety, if in any doubt about the effective earthing of the power point, consult a qualified electrician.</p>

PRECAUTIONS
<ul style="list-style-type: none"> ■ Moisture condensation Moisture may form on the lens in the following conditions. <ul style="list-style-type: none"> • Immediately after a heater has been turned on. • In a steamy or very humid room. • When this unit is moved from a cold place to a warm one. If moisture forms inside this unit, it may not operate properly. In this case, turn on the power and wait about one hour for the moisture to evaporate. ■ If there is noise interference on the TV while a broadcast is being received. Depending on the reception condition of the TV, interference may appear on the TV screen while you are watching a TV broadcast and this unit is left on. This is not a malfunction of this unit or the TV. To watch a TV broadcast, turn off this unit. ■ Do not transport this unit with discs left in it. ■ Do not place on the component such as amplifier or receiver that generates heat. If so, the temperature inside this unit rises and malfunction may occur.

CONTENTS

- **Introduction**
 - READ THIS BEFORE OPERATING YOUR UNIT | 2
- **System Connections**
 - CONNECTING TO A/V AMPLIFIER OR RECEIVER | 6
 - CONNECTING TO TV WITH AUDIO AND VIDEO INS | 8
 - CONNECTING TO TV WITH SCART CONNECTOR(Regional Option) | 8
- **Front Panel & Remote Controls | 9**
 - REMOTE CONTROL OPERATION RANGE | 10
 - LOADING BATTERIES | 10
- **Preliminary Knowledge About Discs**
 - PLAYABLE DISC TYPES | 11
 - NOTES ON DVD VIDEOS | 11
 - NOTES ON COPYRIGHT | 11
 - ABOUT MP3 DISCS | 12
 - SYMBOL ABOUT INVALID OPERATION | 12
 - CARE AND HANDLING OF DISCS | 12
- **Operations**
 - BASIC PLAYBACK | 13
 - DISPLAYING DISC INFORMATION DURING PLAYBACK | 17
 - PLAYING A SPECIFIC ITEM (DVD Video only) | 19
 - REPEAT PLAYBACK | 20
 - PLAYING TRACKS/FILES IN RANDOM ORDER (CD/MP3 disc only) | 21
 - PLAYING TRACKS IN DESIRED ORDER (CD only) | 22
 - BOOKMARK PLAYBACK (DVD Video/CD only) | 23
 - CHANGING THE AUDIO LANGUAGE (DVD Video only) | 24
 - CHANGING THE SUBTITLE LANGUAGE (DVD Video only) | 24
 - CHANGING THE CAMERA ANGLE (DVD Video only) | 25
 - PLAYING A SCENE CLOSE-UP (DVD Video only) | 25
 - CHANGING THE VIDEO SIGNAL FORMAT | 26
 - CHANGING THE COMPONENT VIDEO OUTPUT SIGNAL | 26
- **Initial Settings | 27**
 - SETTING THE LANGUAGE SETUP | 29
 - SETTING THE VIDEO SETUP | 31
 - SETTING THE AUDIO SETUP | 33
 - SETTING THE RATINGS SETUP | 35
 - SETTING THE OTHERS SETUP | 38
- **Definition Of Terms | 41**
- **Troubleshooting Guide | 43**
- **Specifications | 44**
- **DVD Language Code List | 45**

System Connections

- Do not connect the AC input cord into the AC outlet when plugging and unplugging connection cords.
- Since different components often have different terminal names, carefully read the operating instructions of the component connected.
- Be sure to observe the color coding when connecting audio and video cords.

CONNECTING TO A/V AMPLIFIER OR RECEIVER

- Some TVs, etc. are equipped with COMPONENT VIDEO INs that are capable of reproducing a progressively scanned video signal. Connecting to these INs allows you to view high-density pictures with less flickers.
- When DVD Videos recorded in Dolby Digital or DTS are played, Dolby Digital or DTS bistream signals can be output from the DIGITAL OUTs of this unit. If the COAXIAL or OPTICAL DIGITAL OUT of this unit is connected to an external Dolby Digital or DTS decoder or an amplifier with built-in decoder, you can enjoy theater-quality audio in your home.
- The supplied cords are a(stereo) audio cord and a composite video cord only. Other cords are commercially-available cords.

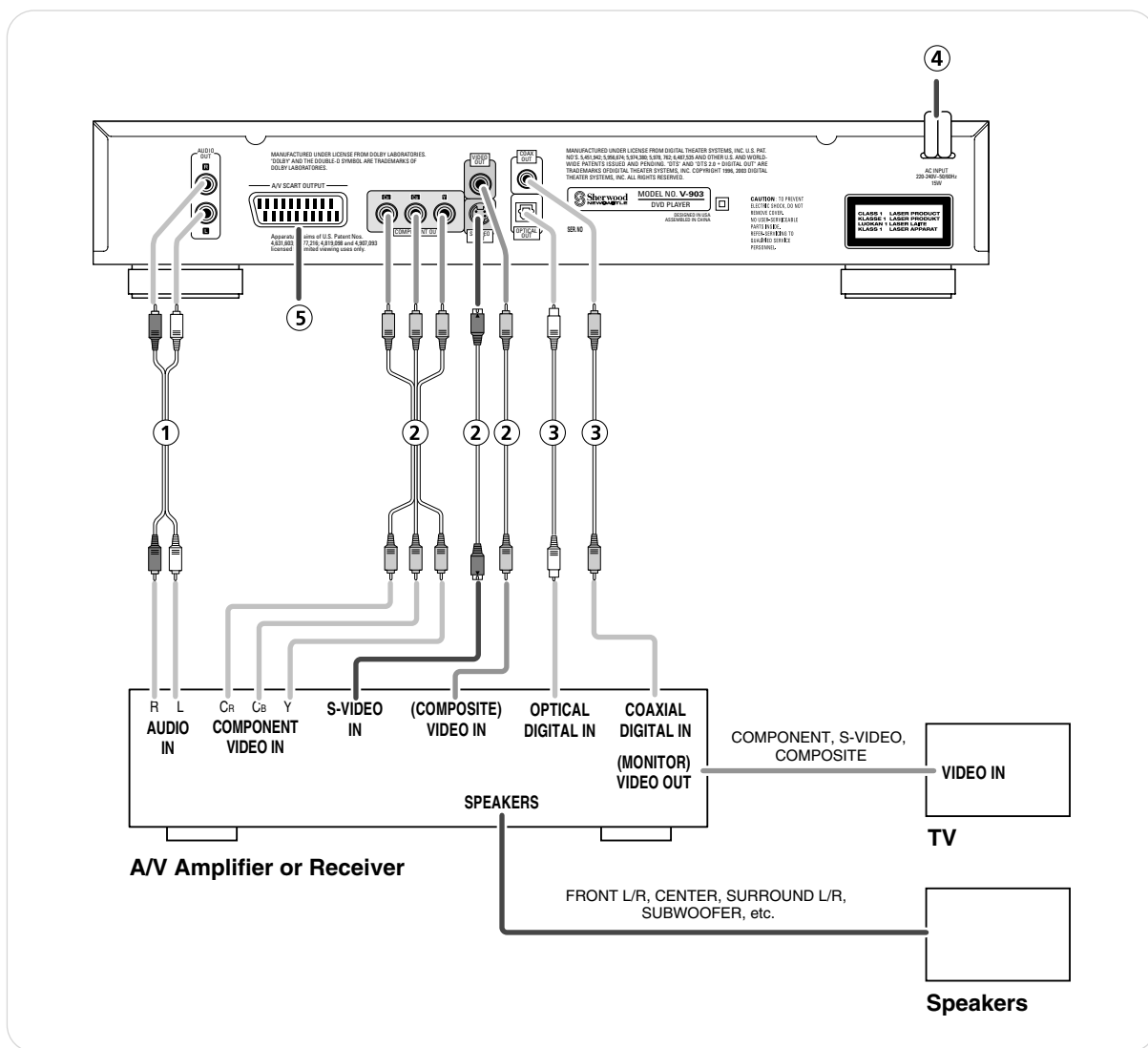

1. Connecting AUDIO OUTs

Connect these jacks to the AUDIO INs of DVD(, AUX, CD, etc.) of your amplifier or receiver.

Notes :

- To listen to analog audio signal that is outputting from the AUDIO OUTs, you should set the AUDIO OUT to "ANALOG". (In this case, the digital audio signal cannot be output from the DIGITAL OUTs of this unit.)
- Depending on whether the AUDIO OUTs are connected to a stereo amplifier/receiver/TV or a A/V amplifier/receiver with built-in surround decoder, you should set the DOWNMIX correctly. (Refer to SETTING THE AUDIO SETUP" on page 33.)

2. Connecting VIDEO OUTs

The COMPONENT VIDEO OUTs of this unit are capable of outputting either conventional interlacing video signal or progressively scanned video signal(that can reproduce high-density pictures with less flicker).

- According to VIDEO OUTs, the excellence in picture quality is as follows:
Progressive "COMPONENT" > Interlaced "COMPONENT" > "S-VIDEO" > "(composite) VIDEO"
- When making COMPONENT VIDEO connections, connect "Y" to "Y", "Cb" to "Cb", ("Pb", "B-Y"), "Cr" to "Cr", ("Pr", "R-Y").
- Depending on the type of the COMPONENT VIDEO INs of TV, be sure to set the component video output signal to the corresponding setting.(Refer to "CHANGING THE COMPONENT VIDEO OUTPUT SIGNAL" on page 26.)
- If there are both VIDEO INs and (MONITOR) VIDEO OUTs on your amplifier or receiver, connect these jacks to the corresponding VIDEO IN jacks of your amplifier or receiver and (MONITOR) VIDEO OUT jacks of that to the corresponding VIDEO IN jacks of the TV respectively.
- If there are no VIDEO jacks, connect these jacks to the TV directly. (Refer to "CONNECTING TO TV WITH AUDIO AND VIDEO INs" on the next page.)

Notes:

- When the component video output signal is set to PROGRESSIVE TV, the S-VIDEO and (composite) VIDEO OUTs can not output the normal video signals. Therefore, it causes the picture to break up and shake.
- When the progressive video signals are input into the non-progressive COMPONENT VIDEO INs of your TV, the picture may not be shown normally, too.
Therefore, when the progressive COMPONENT VIDEO INs of TV are not connected to, you should set the component video output signal to INTERLACE TV.
- Do not connect the unit to the TV through a VCR. Otherwise the picture may be disturbed due to the copy protection function.

3. Connecting DIGITAL OUTs

You can enhance the sound quality by connecting these COAXIAL and OPTICAL DIGITAL OUTs to the corresponding DIGITAL INs of an amplifier, MD recorder, etc.

The digital audio signal from a disc is directly transferred. If you connect to a DTS or Dolby Digital decoder or an amplifier with built-in decoder, you can enjoy theater-quality audio in your home.

Notes :

- To listen to digital audio signal that is outputting from the DIGITAL OUTs, you should set the AUDIO OUT to "SPDIF/BITSTREAM" or "SPDIF/PCM". (In this case, the analog audio signal cannot be output from the AUDIO OUTs of this unit.)
When the AUDIO OUT is not set correctly, loud noise or no sound may be heard from the speakers, and it may be harmful to your ears and damages the speakers.(Refer to "SETTING THE AUDIO SETUP" on page 33.)
- When you connect the MD or CD recorder with a digital input for digital recording, the AUDIO OUT should be set to SPDIF/PCM. If not, the digital recording do not perform properly. (Refer to "SETTING THE AUDIO SETUP" on page 33.)
- When making the COAXIAL DIGITAL connection, be sure to use a 75Ω COAXIAL cord, not a conventional AUDIO cord.
- All of the commercially-available optical fiber cords cannot be used for audio equipments. If there is an optical fiber cord which cannot be connected to your audio equipments, consult your dealer or nearest service organization.

■ Audio output from the unit's DIGITAL OUTs

Disc	Audio recording format	Audio output
DVD Video	Dolby Digital	Dolby Digital bitstream (2-5.1ch) or PCM(48 kHz/16bit) (2ch) (Note 1)
	DTS	DTS bitstream or PCM(48 kHz/ 16 bit) (2ch) (Note 1)
	MPEG-2	PCM(48 kHz/ 16 bit) (2ch) (Note 1)
	Linear PCM (48/96 kHz, 16/20/24bit)	Linear PCM (48 kHz/16bit) (2ch) (Note 2) or original signal
CD / MP3 disc	Linear PCM	Linear PCM (44.1 kHz)

Note 1 : The type of audio output from the DIGITAL OUTs can be selected by the AUDIO OUT settings.

Note 2 : Sound having 96 kHz sampling is converted into 48 kHz sampling when it is output from the unit's DIGITAL OUTs.(Refer to "SETTING THE AUDIO SETUP" on page 33.)

- Linear PCM is a signal recording format used in music CDs. While music CDs are recorded in 44.1 kHz/16 bit, DVD Videos are recorded in 48 kHz/16 bit to 96 kHz/24 bit.

4. AC INPUT CORD

Plug this cord into a wall AC outlet.

5. A/V SCART OUTPUT CONNECTOR (Regional Option)

Refer to "CONNECTING TO TV WITH SCART CONNECTOR(Regional Option)" on page 8.

CONNECTING TO TV WITH AUDIO AND VIDEO INS

- You can enjoy DVD Videos by simply connecting this unit to a TV. To hear improved audio sound quality, connect the AUDIO OUTs to the AUDIO INs of DVD(, AUX, CD, etc.) of your amplifier or receiver.
- To connect these jacks correctly, refer to “Connecting AUDIO OUTs” and “Connecting VIDEO OUTs” on the previous page.

Notes:

- If your TV has a monaural audio input instead of stereo, you need to use an optional audio cord which converts stereo audio output to monaural.
- Do not connect the VIDEO OUTs of the unit to the TV through a VCR. Otherwise the image may be disturbed due to the copy protection function.

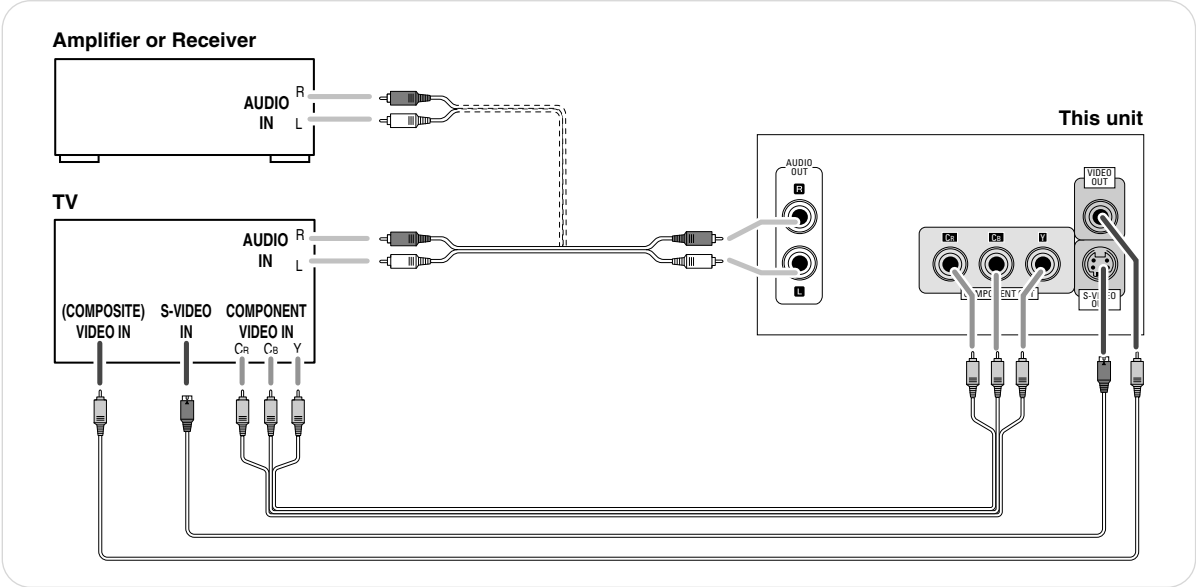

CONNECTING TO TV WITH SCART CONNECTOR(Regional Option)

- For some countries like Europe, the unit incorporates the A/V SCART OUTPUT connector.
- You can connect the unit to TV easily using the SCART connections without other cumbersome audio and video connections.
- During operation of the unit, this connector can deliver either the composite(regular) video or the S-VIDEO (Y and C) signals as well as the audio L and R signals.
- To obtain the highest picture quality, you can make the COMPONENT VIDEO connections between the unit and TV.
- Depending on the video signal(s) to be used, adjust the SCART VIDEO setting to your preference and set your TV to the corresponding one to match the selected settings of the unit.
(Refer to “When selecting the SCART VIDEO(Regional Option)” on page 31 and the operating instructions of the component(s) connected.)
- To listen to analog audio signal that is outputting from this connector, you should set the AUDIO OUT and DOWNMIX correctly.(Refer to “SETTING THE AUDIO SETUP” on page 33.)

Note:

- In this connection, do not connect the unit to the TV through a VCR. Otherwise the image may be disturbed due to the copy protection function.

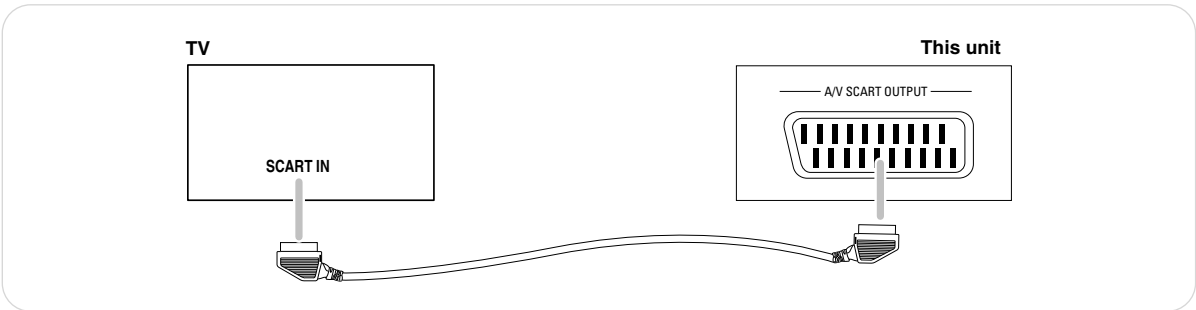

Front Panel & Remote Controls

Front Panel Controls

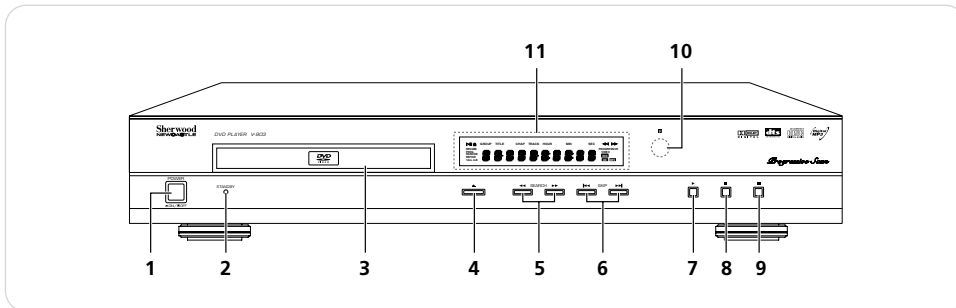

1. POWER ON/OFF switch
2. STANDBY indicator
3. DISC TRAY
4. OPEN/CLOSE(▲) button
5. FORWARD/BACKWARD SEARCH(▶▶/◀◀) buttons
6. FORWARD/BACKWARD SKIP(▶▶▶/◀◀◀) buttons
7. PLAY(▶) button
8. STOP(■) button
9. STEP/PAUSE(⏸) button
10. REMOTE SENSOR
11. FLUORESCENT DISPLAY
 - For details, see the next page.

Remote Controls

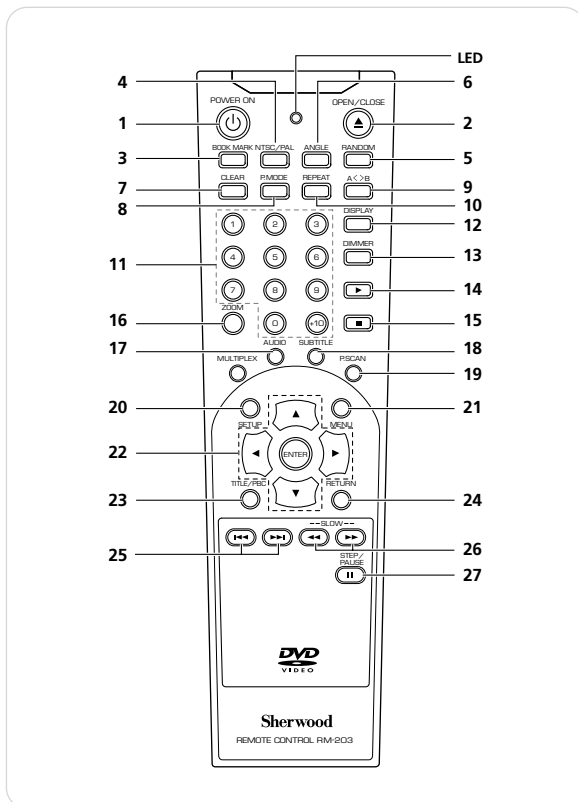

1. POWER button
2. OPEN/CLOSE(▲) button
3. BOOK MARK button
4. NTSC/PAL button
5. RANDOM PLAY button
6. ANGLE button
7. CLEAR button
8. PROGRAM MODE button
9. REPEAT A<>B button
10. REPEAT button
11. NUMERIC(0~9, +10) buttons
12. DISPLAY button
13. DIMMER button
14. PLAY(▶) button
15. STOP(■) button
16. ZOOM button
17. AUDIO button
18. SUBTITLE button
19. PROGRESSIVE SCAN button
20. SETUP button
21. MENU button
22. CURSOR CONTROL(▲/▼/◀/▶), ENTER buttons
23. TITLE button
24. RETURN button
25. FORWARD/BACKWARD SKIP(▶▶▶/◀◀◀) buttons
26. FORWARD/BACKWARD SEARCH(▶▶/◀◀) buttons
27. STEP/PAUSE(⏸) button

Note:

- On the remote control, the PBC and MULTIPLEX functions are not available for this unit.

Fluorescent Display

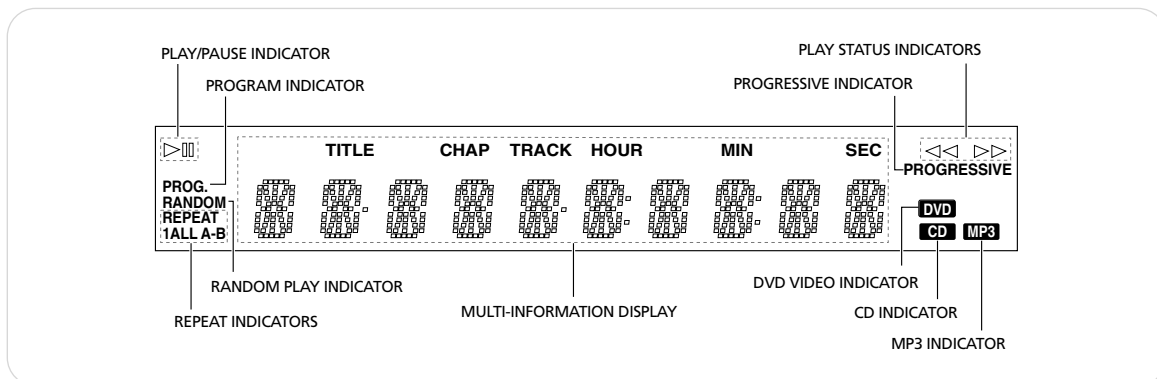

REMOTE CONTROL OPERATION RANGE

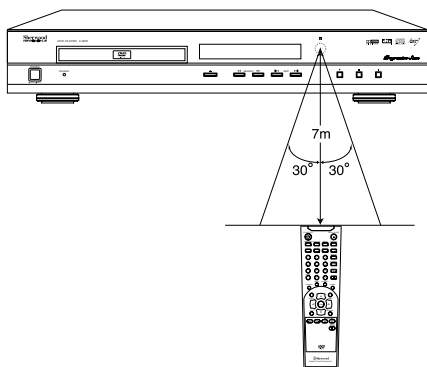

- Use the remote control unit within a range of about 7 meters (23 feet) and angles of up to 30 degrees aiming at the remote sensor.

LOADING BATTERIES

1

Remove the cover.

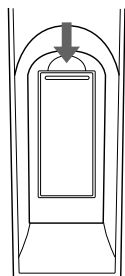

2

Load two batteries ("AAA" size, 1.5V) matching the polarity.

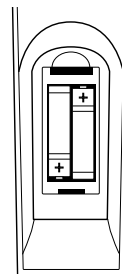

- Remove the batteries when they are not used for a long time.
- Do not use the rechargeable batteries(Ni-Cd type).

Preliminary Knowledge About Discs

PLAYABLE DISC TYPES

This unit can play only the discs bearing any of the following marks and CD-R/CD-RW discs recorded with Audio CD or MP3 format as well.

	DVD VIDEO	CD
Logo mark		
Disc size	3" (8 cm) / 5" (12 cm)	3" (8 cm) / 5" (12 cm)
Played sides	One or both	One side only
Contents	Audio + Video	Audio

“” is a trademark of DVD Format/Logo Licensing Corporation.

Notes :

- This unit cannot play discs (such as CD-ROM, DVD-RAM, etc.) other than those listed above. Playing them may generate noise and damage speakers.
- This unit cannot play CD-Rs and CD-RWs that include unavailable contents or are recorded in non-standardized condition of recording.
- Depending on the disc characteristics or recording condition, etc. some of MP3 discs may not be played back.
- Depending on the countries, this unit conforms to either the NTSC color system for U.S.A, Canada, etc. or the PAL for Europe, Australia, China, etc.

NOTES ON DVD VIDEOS

■ Region code

- DVD players and DVD Videos have their own Region Code numbers which are assigned to each country or area as shown below. DVD players are set to your Region Code number at the factory. As a result, if the region code number of this DVD player is different from that of the DVD Video, playback of the DVD Video will not be allowed by the DVD player.

Major countries or area	All regions	North America	Europe, Japan, Middle East	Southeast Asia	Oceania, South America	Russia	China
Playable Region code							

Examples of playable DVD Videos :

- In U.S.A



- In Europe



■ Markings on the DVD Videos

Mark	Description
	Indicates the region code where the disc can be played.
	Number of audio languages recorded with multiple audio languages. The number in the mark indicates the number of audio languages. (Up to 8 languages)
	Number of subtitle languages recorded with the multiple subtitle languages. The number in the mark indicates the number of subtitle languages. (Up to 32 languages)
	Number of angles recorded from the multiple camera angles. The number in the mark indicates the number of angles. (Up to 9 angles)
	Aspect ratio and TV screen type. “16:9”, “4:3”, etc. stands for aspect ratio, “LB” for letter box, “PS” for pan-scan, “WIDE” for wide screen.

NOTES ON COPYRIGHT

- Please check the copyright laws in your country to record from DVD Video, CD and MP3 disc, etc. Recording of copyrighted material may infringe copyright laws.
- DVD Video is protected by the copyguard system.
- When you connect the unit to your VCR directly, the copyguard system activates and the picture may not be played back correctly.

This product incorporates copyright protection technology that is protected by U.S. patents and other intellectual property rights. Use of this copyright protection technology must be authorized by Macrovision, and is intended for home and other limited viewing uses only unless otherwise authorized by Macrovision. Reverse engineering or disassembly is prohibited.

ABOUT MP3 DISCS

This unit can play back MP3 files on a private CD-R/CD-RW disc or commercial CD.



Notes:

- Some discs may not be played back because of the disc characteristics or recording condition, etc.
- Folder and file names are displayed up to 11 characters.
- Characters except "A~Z", "0~9", "-" are not displayed.
- The order shown in the menu may not be the same to the order shown in a PC.

Note for making a private MP3 disc using a CD-R/CD-RW disc:

- We recommend to record MP3 files in 44.1 kHz sampling frequency / 128 kbps bit rate.

SYMBOL ABOUT INVALID OPERATION

- When you press a button, if the unit does not accept its operation,  appears on the TV screen. Operations are occasionally unacceptable even if  is not displayed.

- ※ Invalid operation may occur as expected if :
 - The region code number of the unit is different from that of the DVD Video and playback will not be allowed.
 - The rating level function works.
(For details, refer to "When selecting the RATING LEVEL" on page 36.)
 - A disc is not playable, etc.

CARE AND HANDLING OF DISCS

- In handling a disc, hold it carefully with edges.



- Do not stick paper or write anything on the printed surface.



- Fingermarks and dust on the recorded surface should be carefully wiped off with a soft cloth. Wipe straight from the inside to the outside of the disc.

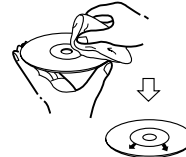

- Always keep the discs in their cases after use to protect them from dust and scratches.

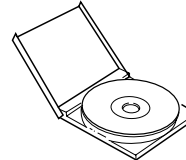

- Do not use a cracked, deformed, or repaired disc. These discs are easily broken and may cause serious personal injury and apparatus malfunction.



Notes:

- Because the temperature inside this unit is very high, in case of no further playback of disc, unload the disc to prevent the high temperature from deforming the disc.
- Do not expose discs to direct sunlight, high humidity or high temperature for a long time.
- When loading or unloading a disc in the disc tray, always place it with the printed side up.

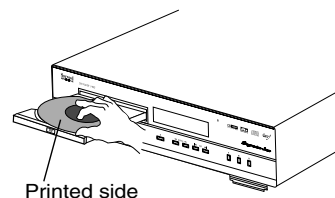

Operations

■ Before starting playback

- Set the TV screen type, the COMPONENT VIDEO OUTPUT SIGNAL and the AUDIO OUT, etc. correctly to match your TV. (Refer to “When selecting the TV ASPECT” on page 31, “CHANGING THE COMPONENT VIDEO OUTPUT SIGNAL” on page 26 and “SETTING THE AUDIO SETUP” on page 33.)
- For explanation purposes, this instructions explains the OSD(On-Screen Display) language displayed on TV in English.

BASIC PLAYBACK

■ Preparations

- Turn on the TV and select the video input source connected to the unit.
- When you want to enjoy the sound of disc from the audio system, turn on the audio system and select the input source connected to the unit.

1 Before operation, enter the standby mode.

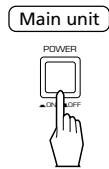

- The STANDBY indicator lights up. This means that the unit is connected to the AC mains and a small amount of current is retained to support operational readiness.
- To turn the power completely off, press the POWER ON/OFF switch again.

2 In the standby mode, turn the power on.



- Each time the POWER button on the remote control is pressed, the unit is turned on to enter the operating mode or off to enter the standby mode.

3 Open the disc tray to load a disc with the printed side up, then close it.

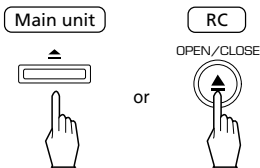

- 8 cm (3 inch) discs can be loaded on the inside circle of the tray, too.
- When a DVD that doesn't contain any menu is loaded, playback automatically starts.

■ Note :

- When you play a DVD Video that contains a menu or a MP3 disc, the menu display may appear on the TV screen. In this case, see “To start playback from the menu of DVD Video” or “To start playback from the menu of MP3 disc” on the next page.

• Example of DVD Video



• Example of MP3 disc

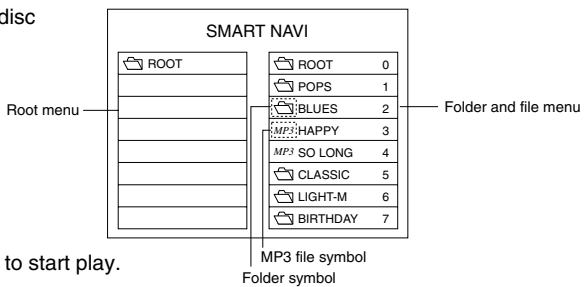

4 In case of CD, press the PLAY(▶) button to start play.

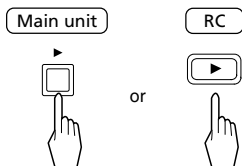

To start playback from the menu of DVD Video

- To select the preferred item, press the CURSOR ▲/▼/◀/▶ buttons and press the ENTER button (or PLAY(▶) button), or press the NUMERIC buttons.

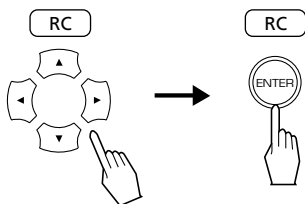

■ In case of use of the NUMERIC buttons on the remote control :

- When selecting "3" :
- When selecting "10" :
- When selecting "21" :

- Playback of the selected item starts.
- In case of selecting the item with pressing the NUMERIC buttons, depending on the discs, the PLAY(▶)(or ENTER) button should be pressed to start playback of the item.
- When the selected item contains the subitems, repeat the above step until the preferred item is selected.

■ **To stop playback and return to the menu display**

- Press the TITLE or MENU button on the remote control.(Which button is pressed differs depending on the discs.)
- Playback is suspended and the menu display appears.

To start playback from the menu of MP3 disc

1

In the stop mode, press the CURSOR ◀/▶ buttons to select the folder and file menu.

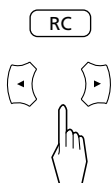

2

Press the CURSOR ▲/▼ buttons to select the preferred folder or file then press the ENTER button.

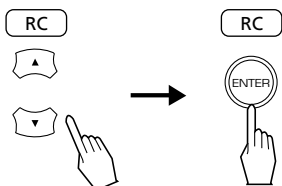

- When selecting the preferred file, playback starts from the selected file.
- When selecting the preferred folder, the file menu screen of the selected folder is displayed. In this case, repeat this step to select the preferred file in its file menu.

Notes :

- To play a MP3 disc with the various playback modes, select the desired playback mode.(For details, refer to "Repeating a file, folder(MP3 disc only)" on page 20 and "PLAYING TRACKS/FILES IN RANDOM ORDER(CD/MP3 disc only)" on page 21.)
- Depending on the MP3 disc and the condition of recording, some of MP3 discs may not be played or may be played differently.
- The DVD Videos continues to rotate while the menu display appears. When no further selections are to be played, be sure to press the STOP(■) button repeatedly to enter the stop mode and to clear the menu display.
- A TV screen may be burned out if a static picture is displayed for a long time in the stop or the pause mode, etc.. To prevent this, set the SCREEN SAVER to ON (refer to "When selecting the SCREEN SAVER" on page 38). Then, the unit automatically activates the screen saver function if a static picture, etc. is displayed for over 5 minutes. Pressing any button will cancel the screen saver function and return to the previous display.
- When you press a button, if the corresponding operation is prohibited by the unit or the disc, appears on your TV screen.

To stop playback

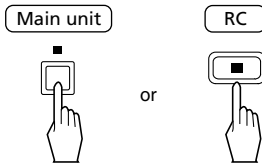

- When playback of DVD Video is stopped, the unit memorizes the point where the STOP(■) button was pressed (RESUME function: DVD Video only). ("R-STOP" is displayed on the unit's display when this function is activated.) Press the PLAY(▶) button again, and playback will resume from this point. When the STOP(■) button is pressed again, the RESUME function will be canceled and it enters stop mode. ("STOP" is displayed.)

To pause playback

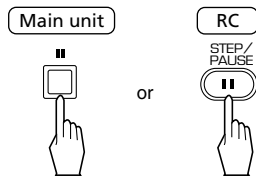

- DVD Video : The unit will be in the still picture mode.
- CD/MP3 disc : The unit will be in the pause mode.
- To return to normal playback, press the PLAY(▶) button.

Frame advance playback [DVD Video only]

- In the still picture mode,

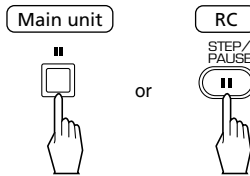

- Each time the STEP/PALUSE(||) button is pressed, the disc is advanced by one frame.
- To return to normal playback, press the PLAY(▶) button.

To skip ahead or back during playback



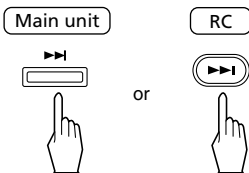

- To skip ahead

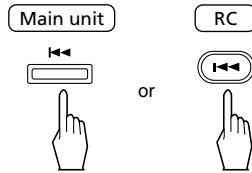

- To skip back



- Each time the button is pressed, a chapter on a DVD Video or a track/file on a CD/MP3 disc is skipped.
- When the BACKWARD SKIP button is pressed once midway through a chapter/track, playback returns to the beginning of that chapter/track. When it is pressed again, a chapter/track is skipped.
- You can select a chapter/track/file directly with pressing the NUMERIC buttons on the remote control.

Examples) For "3" : 
 For "10" :  → 
 For "21" :  →  → 

- In case of MP3 disc, you can select a file in the current folder only.

Rapid playback during playback

- You can play back discs at various speeds.

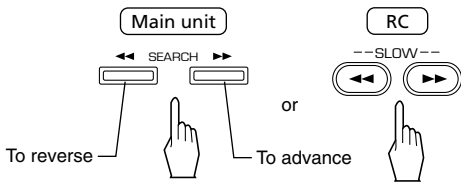

- Each time the button is pressed, the disc is advanced or reversed fast at up to 6 step speeds depending on the kinds of discs.

In case of CD/MP3 disc
 2X → 4X → 6X (→ 8X)
 (): MP3 disc only.

In case of DVD Video
 2X → 4X → 8X → 16X → 32X → 64X

- To return to normal playback, press the PLAY(▶) button.

Slow playback [DVD Video only]

- In the still picture mode, you can play back the discs at various speeds.

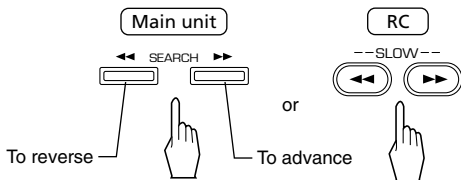

- Each time the button is pressed, the disc is advanced or reversed slowly at 3 step speed.

1/2 X → 1/4 X → 1/8 X → OFF
 (normal playback)

- To return to normal playback, press the PLAY(▶) button.

Adjusting the brightness of the fluorescent display



- Each time the DIMMER button is pressed, the brightness of the fluorescent display of this unit changes as follows:

ON → dimmer → OFF

- In the display OFF mode, pressing any button will restore the display ON mode.

DISPLAYING DISC INFORMATION DURING PLAYBACK

- The unit features the on-screen display function showing disc information.
- Press the DISPLAY button.

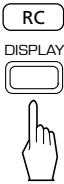

- Then the disc information is displayed on the TV screen.
- Each time this button is pressed, the disc information is changed depending on the discs as follows :

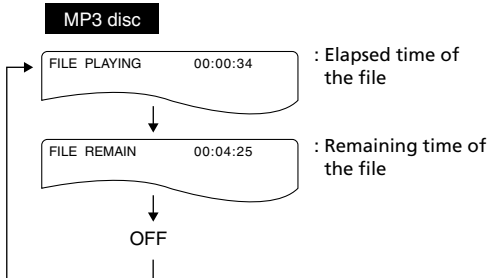
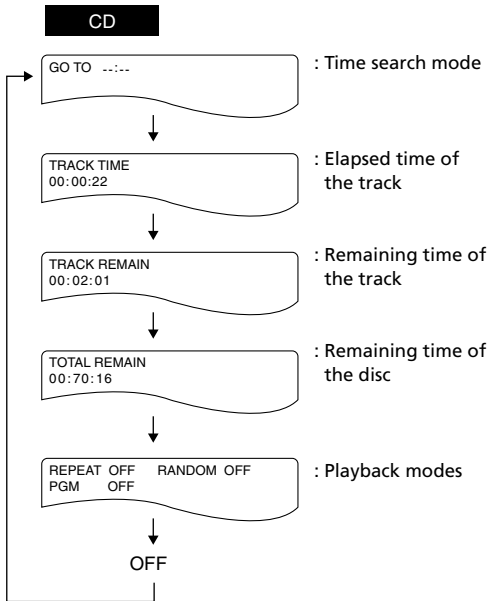
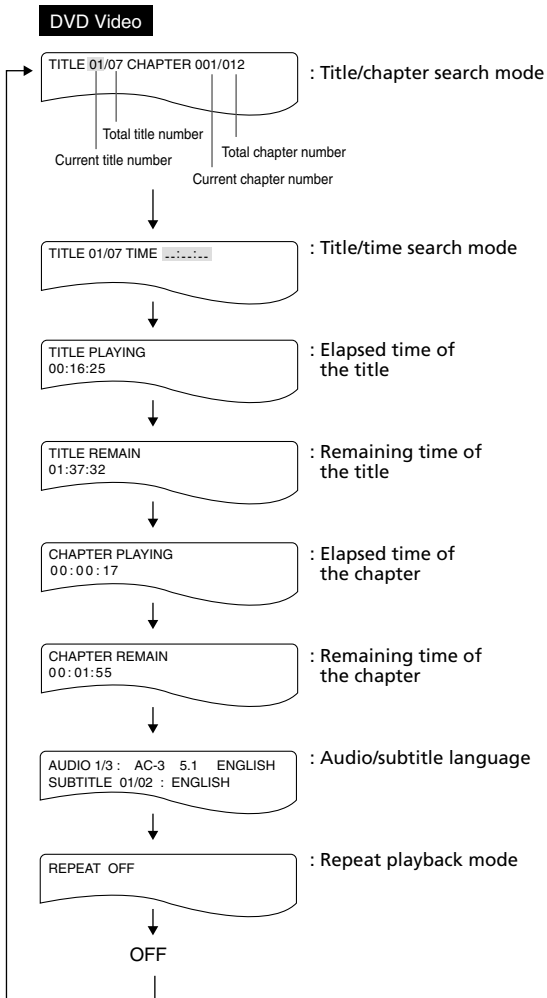

- Depending on the disc and some operation status as playback of DVD Video using a title or DVD menu, etc., the disc information may not be displayed.

Continued

When selecting a search mode(DVD Video/CD only)

- The unit can play a disc from the desired section that you specifies.
- When selecting the title search mode or the other search mode while displaying the title/chapter search mode or the title/time search mode, press the CURSOR ◀/▶ buttons to select the preferred search mode.

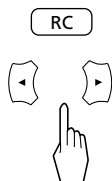

- The selected mode is highlighted.

1

Select the section to be played with pressing the NUMERIC buttons on the remote control.

■ When entering the title or chapter number

Examples) For "3" : (3)
 For "11" : (+10) → (1)

■ When clearing the numbers entered before playback

- Press the CLEAR button.



- Then the numbers are all cleared.

■ When entering the elapsed time

You can play a disc from the desired point by specifying the elapsed time from the beginning of the current title(for DVD Video) or the current track(for CD).

Examples) For "3 min. 15 sec." :

(0) → (0) → (0) → (3) → (1) → (5)

For "2 hou. 59 min. 35 sec." :

(0) → (2) → (5) → (9) → (3) → (5)

(): DVD Video only

2

In case of DVD Video, start playback from the selected section.

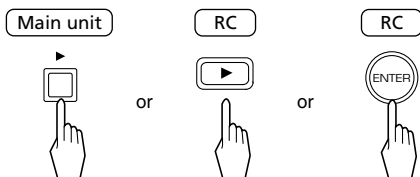

Notes :

- If the title/chapter/time you entered is not contained on the disc, search playback will not work.
- Depending on the disc, a search playback will not work or may work differently.
- In case of CD, if the elapsed time is entered, play automatically starts without pressing the PLAY(▶) or ENTER button.

PLAYING A SPECIFIC ITEM(DVD Video only)

When using a title menu

- If some DVD Videos which contain more than one title may have the menu like as a list of the titles, the TITLE button can be used to select the desired title. (The details of operation differ depending on the disc used.)

1 During playback, press the TITLE button.

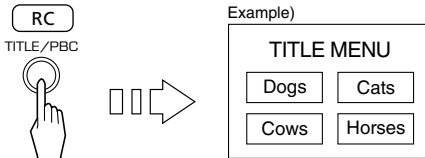

- Then a list of titles on the disc is displayed on TV screen.
- If the disc does not have the menu such as a list of titles, this function does not work.

2 Press the CURSOR ▲/▼/◀/▶ buttons to select the desired title, then press the ENTER or PLAY(▶) button.

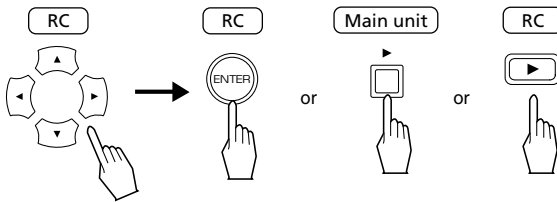

- The unit starts playback of the selected title.
- When the menu continues onto another screen, repeat this step until the desired title is selected.

When using a DVD menu

- Some DVD Videos have unique menu structures called DVD menus. For example, the discs programmed with complex contents provide guide menus, and those recorded with various languages provide menus for audio and subtitle language. Although the DVD menu's contents and operation differ from disc to disc, the following explains basic operation when this feature is used.

1 During playback, press the MENU button.

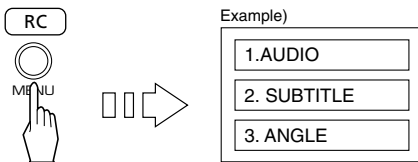

- Then the DVD menu available on the disc is displayed on TV screen.
- If the disc does not have the DVD menu, this function does not work.

2 Press the CURSOR ▲/▼/◀/▶ buttons to select the desired item, then press the ENTER or PLAY(▶) button.

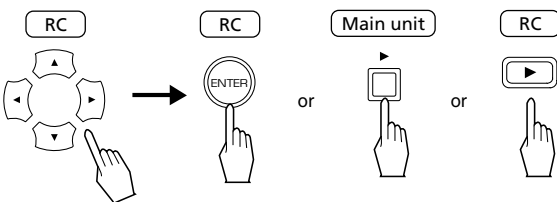

- The unit starts playback of the selected item.
- When the menu continues onto another screen, repeat this step until the desired item is selected.

REPEAT PLAYBACK

- You can play a current title, chapter, folder, track, file, disc or part repeatedly. (Title repeat, chapter repeat, folder repeat, track repeat, file repeat, disc repeat, repeat A < > B)

Note :

- The repeat playback may not work correctly on some DVD Videos and MP3 discs.

Repeating a chapter, title, track, disc(DVD Video/CD only)

- During playback of the desired chapter, title or track, press the REPEAT button.



- Then the selected repeat mode is displayed on the TV screen.

- Each time this button is pressed, the repeat mode changes depending on the disc as follows :

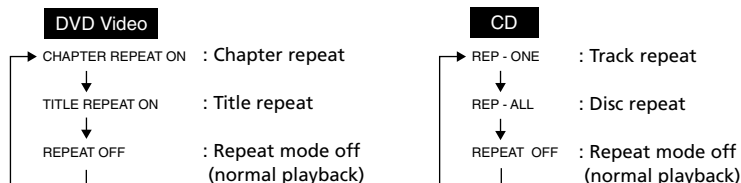

- To return to normal playback, press the REPEAT button repeatedly until the “REPEAT OFF” is displayed.

Repeating a file, folder(MP3 disc only)

1

In the stop mode, press the REPEAT button.



- Each time this button is pressed, one of the various playback modes is selected and displayed on the TV screen as follows:

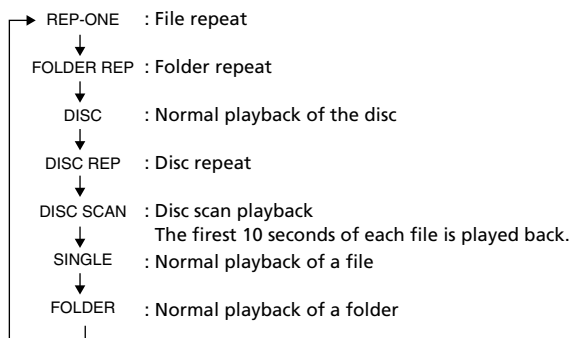

2

To select the desired file, perform the steps 1 and 2 in “To start playback from the menu of MP3 disc” on page 14.

- Playback starts from the selected file according to the selected playback mode.

Continued

Repeating the desired part [DVD Video/CD only]

1

During playback at the beginning of the part you want to repeat, press the REPEAT A < > B button.



• Then "A TO B SET A" is displayed on the TV screen.

2

At the end of the part, press the REPEAT A < > B button again.

- Then "A TO B SET B" is displayed on the TV screen, and the part between points A and B is played back repeatedly.
- To return to normal playback, press the REPEAT A < > B button repeatedly until "A TO B CANCELLED" is displayed.

Notes :

- You may not use the repeat A < > B playback of the part that includes multiple camera angles.
- Repeat A < > B playback works only within a title or a track.

PLAYING TRACKS/FILES IN RANDOM ORDER(CD/MP3 disc only)

1

In the stop mode, press the RANDOM PLAY button.



• Then the selected playback mode is displayed on the TV screen.

- Each time this button is pressed, the playback mode changes depending on the disc as follows:

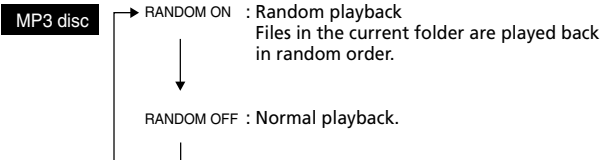
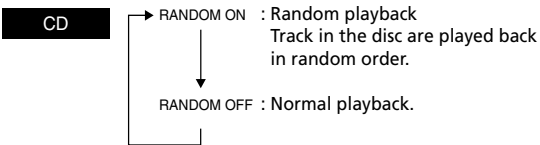

- In case of CD, random playback mode can also be selected even during normal playback.

■ In case of CD

2

To start random playback, press the PLAY(▶) button or the ENTER button.

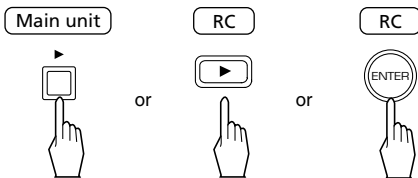

- To return to normal playback mode, press the RANDOM PLAY button during random playback or in the stop mode, then "RANDOM OFF" is displayed.

■ In case of MP3 disc

2

To select the desired file, perform the steps 1 and 2 in "To start playback from the menu of MP3 disc" on page 14.

- Playback starts from the selected file according to the selected playback mode.
- To return to normal playback mode, press the RANDOM PLAY button in the stop mode, then "RANDOM OFF" is displayed.

Note:

- Depending on the disc, random playback may not work correctly.

PLAYING TRACKS IN DESIRED ORDER (CD only)

- Up to 99 tracks can be programmed to be played in any desired order.

1 In the stop mode, press the PROGRAM MODE button.

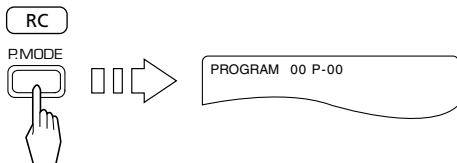

- Then the program mode is displayed on the TV screen.
- When the PROGRAM MODE button is pressed again, the program mode is canceled.

2 Select the desired track with pressing the NUMERIC buttons on the remote control. Example) When the track 5 and 12 are programmed.

- For 5 : → PROGRAM 05 P-01
 - For 12 : → → PROGRAM 12 P-02
- Programmed order
Programmed track number

3 Repeat the above step 2 until the desired tracks are programmed.

4 To start program playback, press the PLAY(▶) button or the ENTER button.

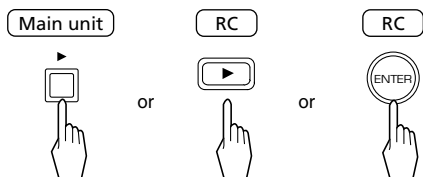

- Playback will start in the programmed order.
- After all programmed tracks have been played, it enters the stop mode without clearing the programmed tracks. (Program playback is suspended)

■ Clearing the programmed tracks

[To clear one by one]

- During programming, press the CLEAR button.



- Each time this button is pressed, the programmed tracks are cleared one by one in the opposite order.
- Once program playback is performed, you cannot clear one by one.

[To clear all programmed tracks]

- During programming or when the STOP(■) button is pressed to stop program playback, press the PROGRAM MODE button.



- Then the programmed tracks are all cleared.
- Opening the disc tray clears all programmed tracks.

BOOKMARK PLAYBACK (DVD Video/CD only)

- The bookmark function allows you to mark the desired scene/point that you can go to quickly. Up to 14 bookmarks can be stored in the memory.

Storing a bookmark in the memory

1

During playback, press the BOOK MARK button.

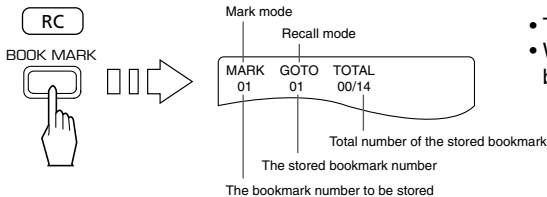

- Then the bookmark menu is displayed on the TV screen.
- When the BOOK MARK button is pressed again, the bookmark menu disappears.

2

Press the CURSOR ◀/▶ buttons to select the mark mode.

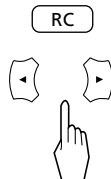

- Each time the CURSOR ▶ or ◀ button is pressed, the mark mode or the recall mode is selected.

3

Press the CURSOR ▲/▼ buttons to select the desired bookmark number.

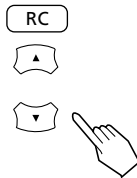

4

At the desired scene/point, press ENTER button.



- Then the bookmark is stored in the memory.
- Repeat the above steps 1-4 until the desired scenes/points are marked.
- When the ENTER button is pressed at a previously used bookmark number, the new scene/point will be marked with that bookmark.

Recalling a bookmarked scene/point

1

To select the recall mode, perform the above steps 1 and 2.

2

Press the CURSOR ▲/▼ buttons to select the bookmark number that you want to recall and press the ENTER button.

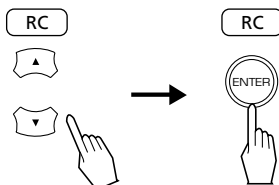

- Playback resumes from the scene/point corresponding to the selected bookmark.

Notes:

- Opening the disc tray or turning the power off clears all stored bookmarks.
- Depending on the disc, the bookmark function may not work.

CHANGING THE AUDIO LANGUAGE (DVD Video only)

- It is possible to change the audio language to a different language from the one selected at the initial settings. (For details, refer to “SETTING THE LANGUAGE SETUP” on page 29.) This operation works only with DVD Videos on which multiple audio languages are recorded.
- During playback, press the AUDIO button.



- Then the audio language menu is displayed on the TV screen for several seconds.

- Each time this button is pressed, the audio language changes as follows:

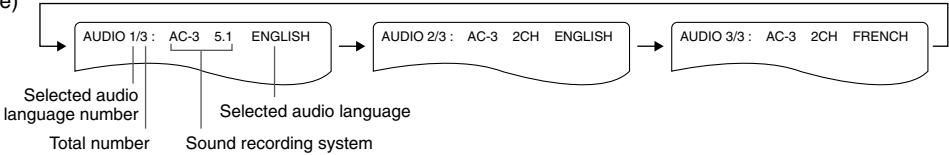

Notes:

- You cannot select the preferred audio language when the disc contains only one.
- When the power is turned off and on or the disc is changed, etc., the language heard is the one selected at the initial settings. If this is not recorded on the disc, only the available language on the disc will be heard.
- On some discs, an audio language except the selected one at the initial settings may be heard.

CHANGING THE SUBTITLE LANGUAGE (DVD Video only)

- It is possible to change the subtitle language to a different language from the selected one at the initial settings. (For details, refer to “SETTING THE LANGUAGE SETUP” on page 29.) This operation works only with discs on which multiple subtitle languages are recorded.
- During playback, press the SUBTITLE button

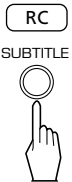

- Then the subtitle language menu is displayed on the TV screen for several seconds.

- Each time this button is pressed, the subtitle language changes as follows:

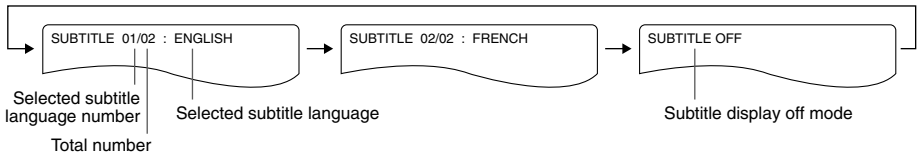

Notes :

- You cannot select the preferred subtitle language when the disc does not contain the available language.
- When the power is turned off and on or the disc is changed, etc., the displayed language is the selected one at the initial settings. If this is not recorded on the disc, the available language on the disc may be displayed.
- On some discs, a subtitle language except the selected one at the initial settings may be displayed.
- When a disc supporting the closed caption is played, the subtitle and the closed caption may overlap each other on the TV screen. In this case, turn off the display of subtitle language.

CHANGING THE CAMERA ANGLE (DVD Video only)

- Some DVD Videos contain scenes which have been shot simultaneously from multiple camera angles. For these discs, the same scene can be viewed from each of these different angles.
- The recorded angles differ depending on the disc used.
- During playback at the scene recorded from multiple camera angles, press the ANGLE button.



- During playback at the scene recorded from multiple camera angles, the angle symbol (📷) is displayed on the TV screen only when the ANGLE MARK is set to ON. (Refer to "When selecting the ANGLE MARK" on page 39.)

- Each time this button is pressed, the angle changes as follows:
Example)

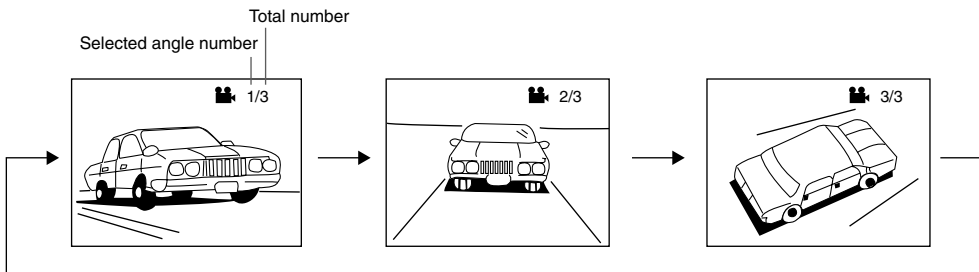

Note :

- This function works only at scenes recorded from multiple angles.

PLAYING A SCENE CLOSE-UP (DVD Video only)

- It is possible to zoom in a part of the scene. You can select and view any part of the scene close-up.

1

During playback or in the still picture mode, press the ZOOM button.



- The unit zooms in to the center part of the scene.
- Each time this button is pressed, zoom scale changes as follows:

→ ZOOM X1.5 → ZOOM X2 → ZOOM X3 → ZOOM OFF
(Zoom playback off mode)

2

Press the CURSOR ▲/▼/◀/▶ buttons to select the desired part of the scene.

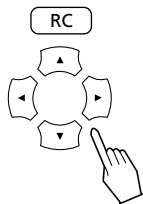

- To return to the previous operation status, press the ZOOM button repeatedly until the zoom playback is canceled.

Note:

- Depending on some operation status such as playback of DVD Video by using a title or DVD menu, etc., the zoom playback does not work.

CHANGING THE VIDEO SIGNAL FORMAT

- Depending on the countries, this DVD player conforms to either the NTSC color system for U.S.A, Canada, etc., or the PAL for Europe, Australia, China, etc.
If the color system of this DVD player is different from that of your TV monitor and the discs to be played, the screen may be somewhat hard to see or the picture quality may be poor.
Only in this case, change the video signal format to another.
(For details about the video signal format of your TV monitor or the discs, refer to the operating instruction of your TV or the disc's jacket.)
- In the stop mode, press the NTSC/PAL button.

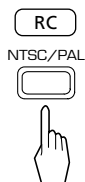

- Each time this button is pressed, the video signal format changes as follows:

→ MULTI → NTSC → PAL →

- The MULTI is compatible with both NTSC and PAL formats.

CHANGING THE COMPONENT VIDEO OUTPUT SIGNAL

- Only during playback of DVD Video on this unit, the COMPONENT VIDEO OUTs of this unit can be capable of outputting either conventional interlacing video signal or progressively scanned video signal(that can reproduce high-density pictures with less flicker).
- When the COMPONENT VIDEO OUTs of this unit are connected to the COMPONENT VIDEO INs of TV or projector, etc., depending on whether the video signal system of your TV or projector, etc. supports the conventional interlacing(simply called interlaced) video signals or the progressively scanned(simply called progressive) video signals(that can reproduce high-density pictures with less flicker), you should select the corresponding video signal.

Notes:

- When you select the PROGRESSIVE TV, the S-VIDEO and (composite) VIDEO OUTs of this unit cannot output the normal video signals. Therefore, it cause the picture to break up and shake.
- When the progressive video signals are input into the non-progressive COMPONENT VIDEO INs of your TV, etc., the picture may not be shown normally, too.
Therefore, when the progressive COMPONENT VIDEO INs of TV is not connected to, you should select INTERLACE TV.
- In the stop mode, press the PROGRESSIVE SCAN button.



- Each time this button is pressed, the component video output signal changes and "INTERLACE TV" or "PROGRESSIVE TV" is displayed on the TV screen.

Initial Settings

The initial settings of the unit at the factory can be modified as desired later. Even after the power of the unit is switched to the standby mode, the initial settings are stored in memory until it is changed the next time.

- 1 In the stop mode or when the resume function is activated, press the SETUP button to enter the setup mode.

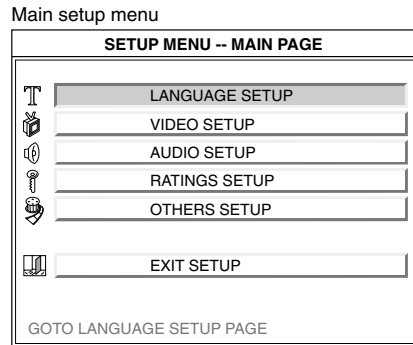

- To exit the setup mode, press the SETUP button, or press the CURSOR ▲/▼ buttons to select "EXIT SETUP" on the main setup menu and press the ENTER button.

- 2 Press the CURSOR ▲/▼ buttons to select a setting category, then press the ENTER button to confirm your selection

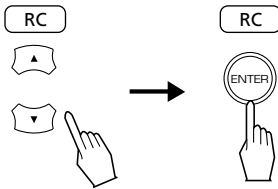

- Then the selected category will provide you the setting details using the succeeding screen.

Note:
 • In the stop mode only, LANGUAGE SETUP and RATINGS SETUP can be selected, too.

■ When selecting the LANGUAGE SETUP

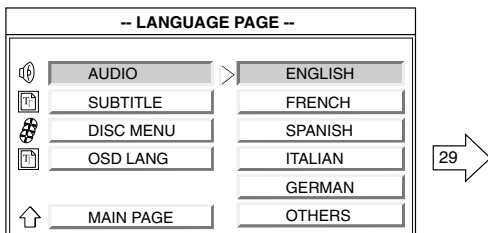

■ When selecting the VIDEO SETUP

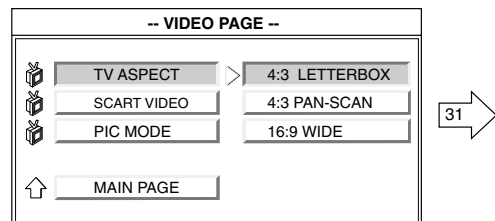

■ When selecting the AUDIO SETUP

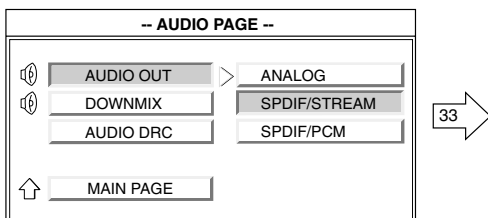

■ When selecting the RATINGS SETUP

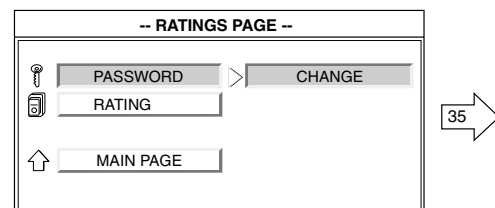

Continued

■ When selecting the OTHERS SETUP

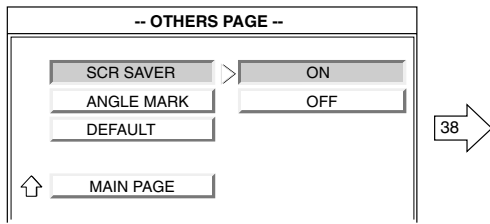

Note:

- During setting operation, only the POWER button and the buttons required for setting will function.

SETTING THE LANGUAGE SETUP

- In the stop mode only, the LANGUAGE SETUP can be selected.

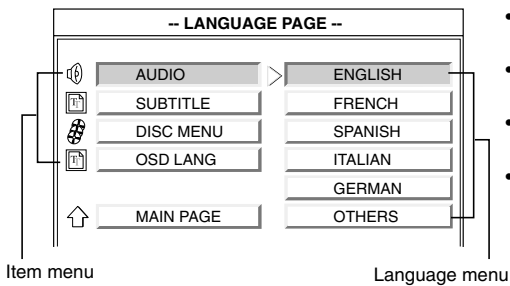

- AUDIO : When selecting a preferred audio language to be heard from those included on the DVD Video.
- SUBTITLE : When selecting a preferred subtitle language to be displayed from those included on the DVD Video.
- DISC MENU : When selecting a preferred menu language to be displayed from those included on the DVD Video.
- OSD LANGUAGE : When selecting a preferred OSD(On-Screen Display) language to be displayed.

Note :

- If the selected language is not recorded in the DVD Video, one of the recorded languages is automatically selected.

1

Press the CURSOR ▲/▼ buttons to select the preferred item.

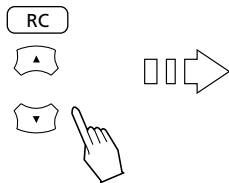

Example) When selecting the SUBTITLE

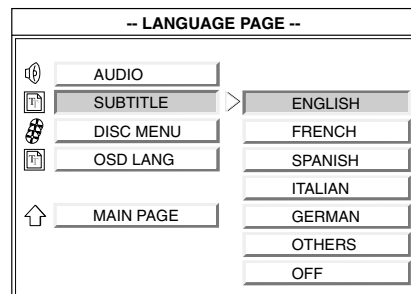

- Then the language menu of the selected item is displayed.

2

Press the CURSOR ► button to select language menu.

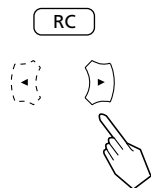

- Each time the CURSOR ◀ or ▶ button is pressed, the language menu or the item menu is selected.

3

Press the CURSOR ▲/▼ buttons to select the preferred language, then press the ENTER button.

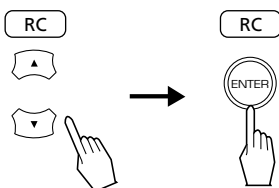

- The selected language is colored.
- You can select one of languages listed in the language menu.
- When you want to select a language other than languages listed in the language menu, select "OTHERS".
- To turn off the display of subtitle language, select "OFF" on the subtitle language menu.

Continued

■ When selecting “OTHERS”

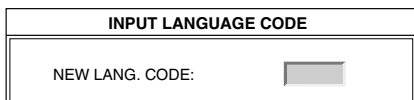

• Then 4-digit language code input screen is displayed.

- Refer to the “DVD Language Code List” on page 45 to find the 4-digit language code for the preferred language and input it with pressing the NUMERIC buttons, then press the ENTER button.
Example) When inputting “1428”

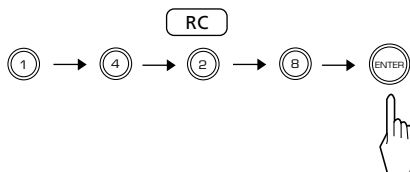

- When the 4-digit code is input correctly, the previous menu screen is displayed.
- If you input a wrong code, “INVALID LANGUAGE CODE” is displayed. In this case, input the code again.

4 Press the CURSOR ◀ button to select the item menu.

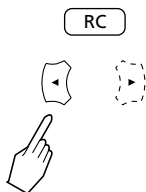

- Each time the CURSOR ◀ or ▶ button is pressed, the setting menu or the language menu is selected.

5 Set other setups to your preference.

■ To return to the main setup menu screen

- Press the CURSOR ◀ button to select the item menu, press the CURSOR ▲/▼ buttons to select “MAIN PAGE” and press the ENTER button.
Then the main setup menu screen will be displayed.
- When the RETURN button is pressed repeatedly, the main setup menu screen will be displayed, and then the setup mode is canceled.

SETTING THE VIDEO SETUP

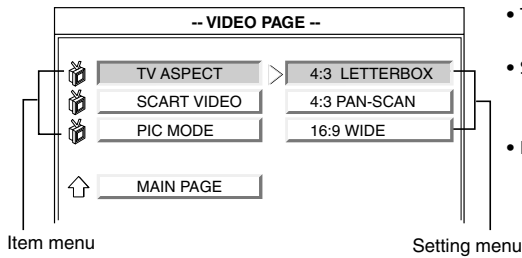

- TV ASPECT : When selecting a picture size according to the aspect ratio of your TV's screen
- SCART VIDEO : When selecting the (composite (regular)) video signal or the S-VIDEO signals to be output from the unit's A/V SCART OUTPUT connector. (Regional Option for Europe, etc. only)
- PICTURE MODE : When selecting the picture mode according to the type of content being played back.

1 Press the CURSOR ▲/▼ buttons to select the preferred item.

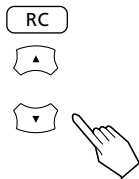

- Then the setting menu of the selected item is displayed.

■ When selecting the TV ASPECT

- When you connect a normal TV with 4:3 aspect ratio to the unit, select either "4:3 LETTERBOX" or "4:3 PAN-SCAN" and when you connect a wide TV with 16:9 aspect ratio, select "16:9 WIDE".

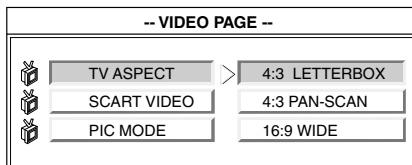

- 4:3 LETTERBOX : DVD Videos recorded with the 16:9 aspect ratio are reproduced in the letter box screen which has black bands on the top and bottom.
- 4:3 PAN-SCAN : DVD Videos recorded with the 16:9 aspect ratio and the pan-scan specification are reproduced in the pan-scan screen which automatically trims the left and right of picture.
- 16:9 WIDE : DVD Videos recorded with the 16:9 screen are reproduced by filling the TV screen.

Note: Depending on some DVD Videos, the playback picture may not conform to the TV aspect setting you select.

■ When selecting the SCART VIDEO (Regional Option)

- For some countries like Europe, this DVD player incorporates the A/V SCART OUTPUT connector which can deliver either the composite (regular) video or the S-VIDEO (Y and C) signals as well as the audio L and R signals for easy connection.
- When the SCART connections between the unit and video components are made, depending on whether you use the composite (regular) video signal from the SCART connector or the S-VIDEO signals, you can select either the composite (regular) video or the S-VIDEO.

Note :

- Be sure to set your TV and VCR to the corresponding one of the composite (regular) video and S-VIDEO modes to match the SCART VIDEO setting of the DVD player. (Refer to the operating instructions of the component(s) connected.)

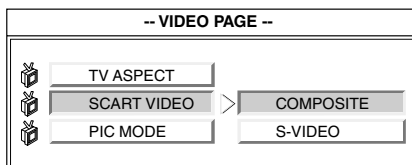

- COMPOSITE : When using the composite (regular) video signal from unit's A/V SCART OUTPUT connector.
- S-VIDEO : When using the S-VIDEO signals.

Continued

■ When selecting the PICTURE MODE

- There are two types of source content in pictures recorded in DVD Videos : film content(pictures recorded from films at 24 frames per second) and video content(video signals recorded at 30 frames per second). According to the type of content being played back, select the desired picture mode.

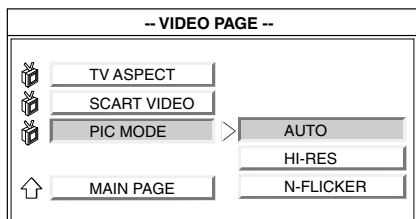

- AUTO : Select this mode normally. This unit automatically detects source content, film or video, of playback source, and perform the necessary signal process.
- HIGH RESOLUTION : To get better picture resolution, select this mode.
- NO FLICKER : To improve flicker of picture, select this mode. This mode is suitable for playback of video content pictures.

Note:
 • When there is no improvement of picture quality in the HIGH RESOLUTION mode or NO FLICKER mode, we recommend you to select the AUTO mode.

2 Press the CURSOR ► button to select the setting menu.

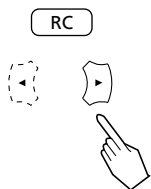

- Each time the CURSOR ► or ◀ button is pressed, the setting menu or the item menu is selected.

3 Press the CURSOR ▲/▼ buttons to select the preferred, then press the ENTER button.

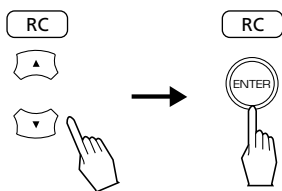

- The selected setting is colored.

4 Press the CURSOR ◀ button to select the item menu.



- Each time the CURSOR ◀ or ► button is pressed, the item menu or the setting menu is selected.

5 Set other setups to your preference.

■ To return to the main setup menu screen

- Press the CURSOR ◀ button to select the item menu, press the CURSOR ▲/▼ buttons to select "MAIN PAGE" and press the ENTER button. Then the main setup menu screen will be displayed.
- When the RETURN button is pressed repeatedly, the main setup menu screen will be displayed, and then the setup mode is canceled.

SETTING THE AUDIO SETUP

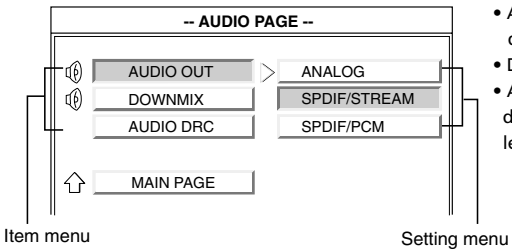

- **AUDIO OUT** : When outputting either analog audio signal or a preferred digital audio signal format.
- **DOWNMIX** : When outputting a preferred analog audio signal format.
- **AUDIO DRC**(Dynamic Range Compression) : When turning on or off the dynamic range compression that makes faint sound easier to hear at low volume levels.

1

Press the CURSOR ▲/▼ buttons to select the preferred item.

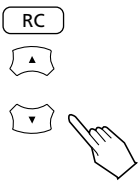

- Then the setting menu of the selected item is displayed.

■ When selecting the AUDIO OUT

Notes :

- This unit can output either analog audio signal or digital audio signal(, not both analog and digital audio signals concurrently). Therefore, you should set the AUDIO OUT to either ANALOG or coressponding digital out setting(SPDIFF/STREAM or SPDIF/PCM) according to system connections, etc.
- When the DIGITAL OUT of the unit is connected to the DIGITAL IN of an amplifier which does not contain the Dolby Digital or DTS decoder(which processes the bitstream signal), you should set the AUDIO OUT to SPDIF/PCM to convert Dolby Digital or DTS bitstream to linear PCM(2 channel) of 48 kHz/16 bit and to output it.
- If the AUDIO OUT is not set correctly, loud noise or no sound may be heard from the speakers, and it may be harmful to your ears and damage the speakers.

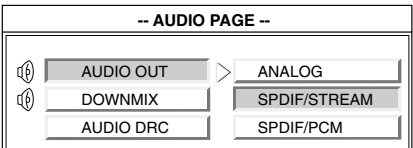

- **ANALOG** : When outputting analog audio signal.
- **SPDIF/STREAM** : When outputting the digital audio signal as it was recorded.
- **SPDIF/PCM** : When converting DTS or Dolby Digital bitstream to linear PCM(2 channel) of 48 kHz/16 bit and outputting it.

■ When selecting the DOWNMIX

- Depending on whether the AUDIO OUTs(or the A/V SCART OUTPUT connector) are connected to a stereo amplifier/receiver/TV or a A/V amplifier/receiver with built-in surround decoder, you should set the DOWNMIX correctly.

Notes :

- This setting is valid when the AUDIO OUT is set to ANALOG.
- The DOWNMIX setting affect only the output signal from the AUDIO OUT jacks(or the A/V SCART OUTPUT connector) when playing back a DVD Video disc, etc. recorded in multi-channel signal format.

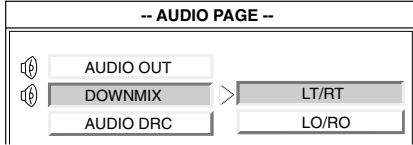

- **LT/RT** : When you enjoy multi-channel surround sound by connecting the unit's AUDIO OUTs to a A/V amplifier/receiver with built-in surround decoder.
- **LO/RO** : When you enjoy conventional 2-channel stereo sound by connecting the unit's AUDIO OUTs to a stereo amplifier/receiver/TV.

Continued

■ When selecting the AUDIO DRC

• This function can be activated, while playing the Dolby Digital program sources only.

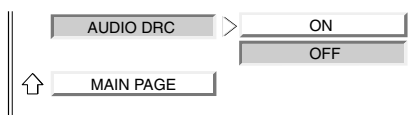

- ON : When turning it on to hear faint sound easier at low volume levels.
 - OFF : When turning off the dynamic range compression.
- Note:
- In some Dolby Digital softwares, this function cannot be available.

2 Press the CURSOR ► button to select setting menu.

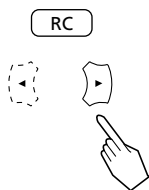

- Each time the CURSOR ► or ◀ button is pressed, the setting menu or the item menu is selected.

3 Press the CURSOR ▲/▼ buttons to select the preferred setting, then press the ENTER button.

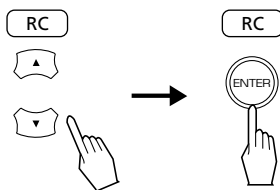

- The selected setting is colored.

4 Press the CURSOR ◀ button to select the item menu.

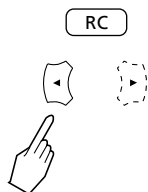

- Each time the CURSOR ◀ or ► button is pressed, the item menu or the setting menu is selected.

5 Set other setups to your preference.

■ To return to the main setup menu screen

- Press the CURSOR ◀ button to select the item menu, press the CURSOR ▲/▼ buttons to select "MAIN PAGE" and press the ENTER button.
Then the main setup menu screen will be displayed.
- When the RETURN button is pressed repeatedly, the main setup menu screen will be displayed, and then the setup mode is canceled.

SETTING THE RATINGS SETUP

In the stop mode only, the RATINGS SETUP can be selected.

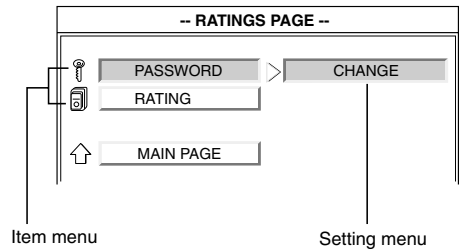

- **PASSWORD** : When changing the password for parental lock. The unit's password has been set to "3308" at the factory.
- **RATING LEVEL** : When restricting playback of DVD Video which contains violent and other scenes according to the level set by the user. For example, if a movie which includes violent scenes supports the parental lock feature, such scenes which you do not want to let children view can cut or replaced with other scenes.

When selecting the PASSWORD

1 Press the CURSOR ▲/▼ buttons to select the PASSWORD.

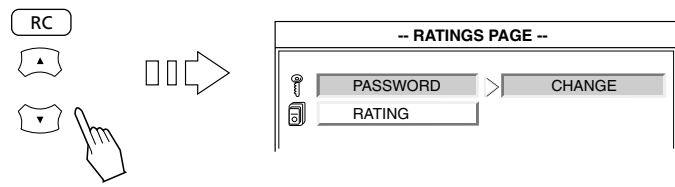

2 Press the CURSOR ► buttons to select the CHANGE, then press the ENTER button.

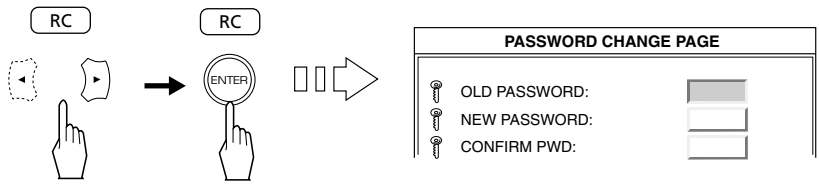

3 Input 4-digit passwords in sequence for old password, new password and confirmation, then press the ENTER button.

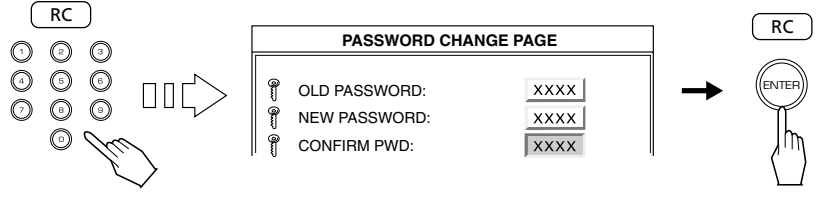

- When each password is input correctly, the previous menu screen is displayed.
- While displaying the password change page menu screen, when the SETUP button is pressed, the setup mode is canceled.

Note :

• Do not forget the password. When you input the password first time or if you forgot your password, input "3308" that has been set to at factory for the old password.

4 Press the CURSOR ◀ button to select the item menu.

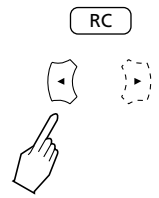

- Each time the CURSOR ◀ or ► button is pressed, the item menu or the setting menu is selected.

Continued

5 Set other setups to your preference.

■ To return to the main setup menu screen

- Press the CURSOR ◀ button to select the item menu, press the CURSOR ▲/▼ button to select “MAIN PAGE” and press the ENTER button.
Then the main setup menu screen will be displayed.
- When the RETURN button is pressed repeatedly, the main setup menu screen will be displayed, and then the setup mode is canceled.

■ When selecting the RATING LEVEL

1 Press the CURSOR ▲/▼ buttons to select the RATING LEVEL.

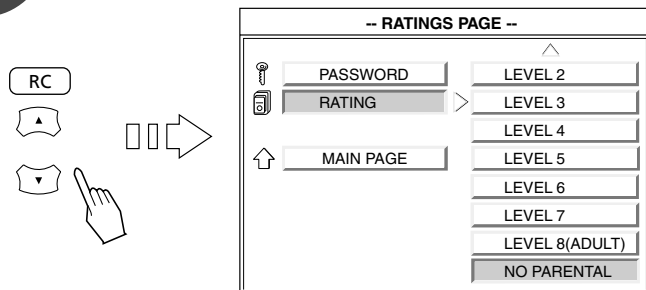

- LEVEL 1(KIDS) :
Select this to play only DVD Videos for children. Adult and general audience DVD Videos cannot be played.
- LEVEL 2~7 :
Select this to play DVD Videos for general audiences and children. Adult DVD Videos cannot be played.
- LEVEL 8(ADULT) :
Select this to play for general audiences, children and adults.
- NO PARENTAL :
Select this to play all DVD Videos.

Notes :

- When you set the rating level low, some discs may not be played at all. In this case, set the rating level higher or to “NO PARENTAL”.
- DVD Videos may or may not respond to the rating level setting. Make sure this function works with your DVD Videos.

2 Press the CURSOR ▶ button to select the level menu.

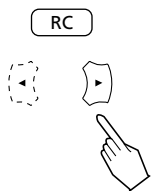

- Each time the CURSOR ▶ or ◀ button is pressed, the level menu or the item menu is selected.

3 Press the CURSOR ▲/▼ buttons to select the preferred level, then press the ENTER button.

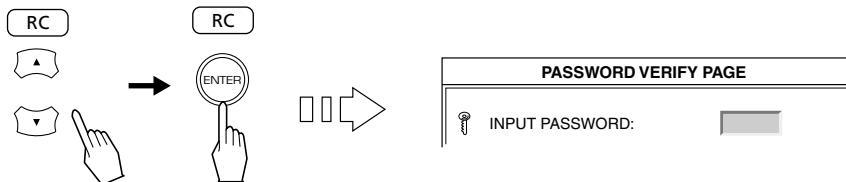

Continued

4

Input a 4-digit password with pressing the NUMERIC(0~9) buttons, then press the ENTER button.

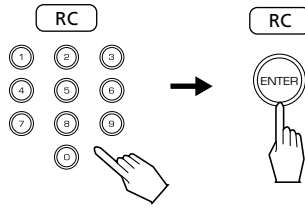

- When the password is input correctly, the rating level is set to the preferred level and the previous menu screen is displayed.
- If you input a wrong password, "PASSWORD INCORRECT" is displayed. In this case, input the password again
- While displaying the password verify page screen, when the RETURN button is pressed, the main setup menu screen will be displayed.

Note :

- If you forgot your password, input "3308" that has been set to at factory.

5

Press the CURSOR ◀ button to select the item menu.

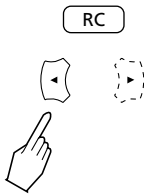

- Each time the CURSOR ◀ or ▶ button is pressed, the item menu or the level menu is selected.

6

Set other setups to your preference.

■ To return to the main setup menu screen

- Press the CURSOR ◀ button to select the item menu, press the CURSOR ▲/▼ buttons to select "MAIN PAGE" and press the ENTER button.
Then the main setup menu screen will be displayed.
- When the RETURN button is pressed repeatedly, the main setup menu screen will be displayed, and then the setup mode is canceled.

SETTING THE OTHERS SETUP

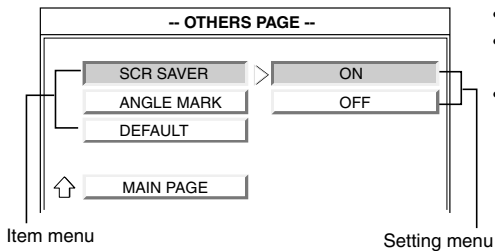

- SCREEN SAVER : When turning on or off the screen saver function.
- ANGLE MARK : When displaying the angle symbol on the TV screen during playback at the scene recorded from multiple camera angles.
- DEFAULT : When resetting all the settings made in the setup menu except the rating level and the password to the default settings.

■ When selecting the SCREEN SAVER

- A TV screen may be burned out if a static picture is displayed for a long time in the stop mode or the pause mode, etc.. To prevent this, set the SCREEN SAVER to ON. Then the unit automatically activates the screen saver function if a static picture is displayed for over 5 minutes.

Note :

- The monitor screen of a projector or projection TV is easily burned out if a static picture is displayed for a long time. Be careful not to allow the monitor screen to be burned out when the SCREEN SAVER is set to OFF.

1 Press the CURSOR ▲/▼ buttons to select the SCREEN SAVER.

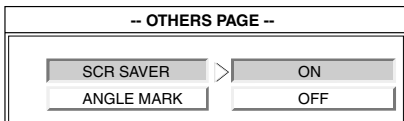
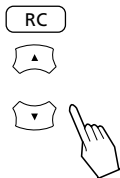

- ON : When turning on the screen saver function.
- OFF : When turning it off.

2 Press the CURSOR ► button to select the setting menu.

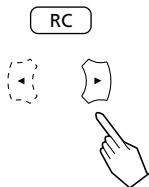

- Each time the CURSOR ► or ◀ button is pressed, the setting menu or the item menu is selected.

3 Press the CURSOR ▲/▼ buttons to select the preferred setting, then press the ENTER button.

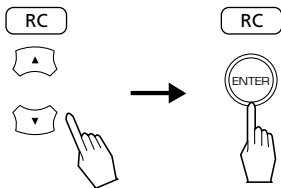

- The selected setting is colored.

4 Press the CURSOR ◀ button to select the item menu.

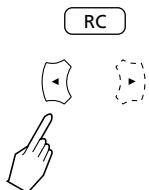

- Each time the CURSOR ◀ or ► button is pressed, the item menu or the setting menu is selected.

Continued

5 Set other setups to your preference.

■ To return to the main setup menu screen

- Press the CURSOR ◀ button to select the item menu, press the CURSOR ▲/▼ button to select "MAIN PAGE" and press the ENTER button. Then the main setup menu screen will be displayed.
- When the RETURN button is pressed repeatedly, the main setup menu screen will be displayed, and then the setup mode is canceled.

■ When selecting the ANGLE MARK

1 Press the CURSOR ▲/▼ buttons to select the ANGLE MARK.

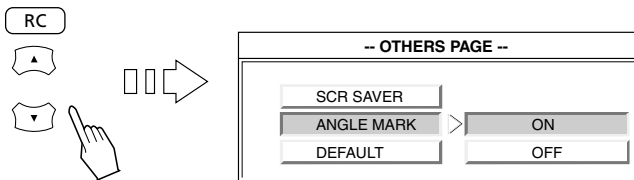

- ON : When turning on the display of the angle symbol() on the TV screen.
- OFF : When turning it off.

2 Press the CURSOR ▶ button to select the setting menu.

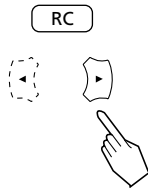

- Each time the CURSOR ▶ or ◀ button is pressed, the setting menu or the item menu is selected.

3 Press the CURSOR ▲/▼ buttons to select the preferred setting, then press the ENTER button.

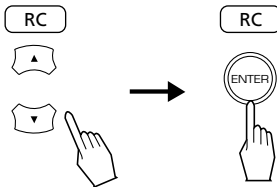

- The selected setting is colored.

4 Press the CURSOR ◀ button to select the item menu.

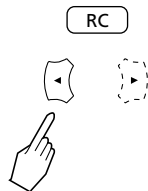

- Each time the CURSOR ◀ or ▶ button is pressed, the item menu or the setting menu is selected.

5 Set other setups to your preference.

■ To return to the main setup menu screen

- Press the CURSOR ◀ button to select the item menu, press the CURSOR ▲/▼ button to select "MAIN PAGE" and press the ENTER button. Then the main setup menu screen will be displayed.
- When the RETURN button is pressed repeatedly, the main setup menu screen will be displayed, and then the setup mode is canceled.

Continued

■ When selecting the DEFAULT

1 Press the CURSOR ▲/▼ buttons to select the DEFAULT.

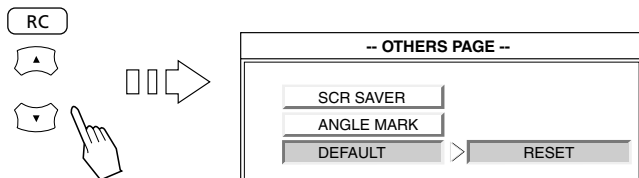

• RESET : When resetting all the settings in the setup menu except the rating level and the password to the default settings.

2 Press the CURSOR ► button to select the setting menu, then press the ENTER button.

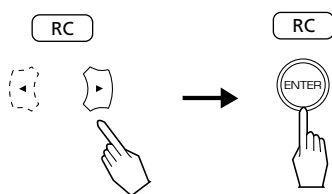

• Each time the CURSOR ► or ◀ button is pressed, the setting menu or the item menu is selected.
 • The selected setting is colored.

3 Press the CURSOR ◀ button to select the item menu.

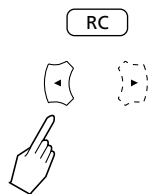

• Each time the CURSOR ◀ or ► button is pressed, the item menu or the setting menu is selected.

4 Set other setups to your preference.

■ To return to the main setup menu screen

- Press the CURSOR ◀ button to select the item menu, press the CURSOR ▲/▼ button to select "MAIN PAGE" and press the ENTER button. Then the main setup menu screen will be displayed.
- When the RETURN button is pressed repeatedly, the main setup menu screen will be displayed, and then the setup mode is canceled.

Definition Of Terms

DVD Video

This refers to a high-density optical disc on which high-quality pictures and sound have been recorded by means of digital signals. Incorporating a new video compression technology (MPEG-2) and high-density recording technology. DVD Video enables esthetically pleasing full-motion video to be recorded over long periods of time (for instance, a whole movie can be recorded).

DVD Video has a structure consisting of two 0.6 mm thin discs which are adhered to each other. Since the thinner the disc, the higher the density at which the information can be recorded, a DVD Video has a greater capacity than a single 1.2 mm thick disc. Since the two thin discs are adhered to each other, there is the potential to achieve double-sided play sometime in the future for even longer duration play.

MPEG

MPEG stands for Moving Picture Expert Group. It is regarded as an international standard for compressing and restoring digital video and audio signal. "MPEG" standards include MPEG-1, MPEG-2 and MPEG-4. Video CD and MP3 are based on MPEG-1, while DVD Video is based on MPEG-2.

MP3

MP3 is an audio data reduction format, which stands for MPEG-1 Audio Layer 3. Using MP3, you can achieve a data reduction of about 1:10.

Title, Title number (DVD Video)

The title is the largest unit of the video/audio recording in DVD Videos. Usually, the title corresponds to a movie of video software or an album (or a piece) of music software. Title numbers are sequential numbers assigned to titles.

Chapter, Chapter number (DVD Video)

Chapters are divisions, which are smaller than the titles, of the contents recorded on DVD Videos. Every title is composed of more than one chapter. Chapter numbers are the sequential numbers assigned to the chapters in a DVD Video.

Track number (CD)

Track numbers are used to designate the various sections of a disc.

Folder (MP3 disc)

Folder is the largest unit of the contents recorded on MP3 discs.

File (MP3 disc)

Each material (song) is recorded on a file.

Files may be grouped into a folder by artist, album, category, etc.

• DVD Video structure

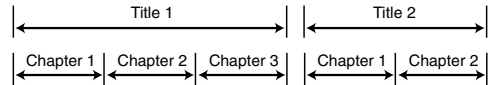

• CD structure

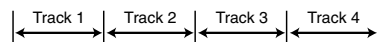

• MP3 disc structure

On an MP3 disc, a folder can be a member of another folder, creating hierarchical folder layers. If you are familiar with a personal computer, you may easily understand the hierarchical file/folder construction.

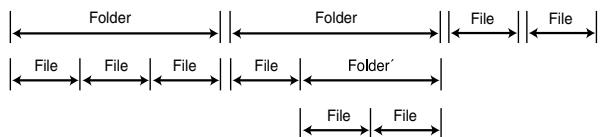

Aspect ratio (DVD Video)

The aspect ratio is the ratio between the vertical and horizontal size of the picture displayed on a TV screen. The aspect ratio of normal TV screen is 4:3 while that of the wide-screen TV and HDTV screen is 16:9.

Subtitle (DVD Video)

Some DVD Videos contain the recording of more than one subtitle languages. With these discs, this unit can select one of the subtitle languages as desired during playback.

Angle (DVD Video)

Some DVD Videos contains scenes which have shot simultaneously from multiple camera angles. With these discs, the same scene can be viewed from each of these different angles.

Interlaced scan

In the conventional video system, a picture is shown on the screen in two halves. The interlaced scanning system places lines of the second half of the picture in-between lines of the first half of the picture.

Progressive scan

Progressive scanning displays all the horizontal lines of a picture at one time, as a single frame.

Composite video

A single video signal commonly used in most consumer video products that contains all luminance, color, and synchronization information.

S-video

A video signal which improves picture quality over the standard composite video signal.

Component video

Video signals with three channels of separate information that makes up the picture. There are some types of component video, such as Y/C_B(Pb)/C_R(Pr) and R/G/B.

Bitstream

The digital signal form of multichannel audio data (e.g., 5.1 channel) before it is decoded into its various channels.

Linear PCM

PCM stands for Pulse Code Modulation. Linear PCM is the usual digital method without compression, used for audio playback of audio CDs, DVD Videos, etc.

Dolby Digital

Dolby Digital provides multichannel surround sound in cinemas from 35 mm film and in the home from laser discs, DVDs, and digital broadcast television, cable, and satellite systems. It enables the transmission and storage of up to five full-range audio channels, plus a low-frequency effects channel(LFE), thus 5.1 channels, in less space than is required for just one linear PCM-coded channel on a compact disc.

Dolby Pro Logic

Dolby Pro Logic decodes program material encoded in Dolby Surround, and is built into virtually every home theater audio system. Dolby Pro Logic reconstructs the original four channels - left, center, right, and surround - that were encoded onto the program material's stereo soundtracks.

Manufactured under license from Dolby Laboratories. "Dolby", "Pro Logic", and the double-D symbol are trademarks of Dolby Laboratories.

DTS (Digital Theater Systems)

DTS is a newly-developed surround system which can handle more amount of data than Dolby Digital, providing better audio quality. Though the number of audio channels is 5.1 which is same as Dolby Digital, discs bearing the "  " provides fat sound and better signal-to-noise ratio, thanks to the lower audio compression ratio format. It also provides wide dynamic range and better separation, resulting in magnificent sound.

"DTS" and "DTS 2.0+Digital Out" are trademarks of Digital Theater Systems, Inc.

Troubleshooting Guide

If a fault occurs, run through the table below before taking your receiver for repair.

If the fault persists, attempt to solve it by switching the unit off and on again. If this fails to resolve the situation, consult your dealer. Under no circumstances should you repair the unit yourself as this will invalidate the guarantee!

PROBLEM	POSSIBLE CAUSE	REMEDY
No power	<ul style="list-style-type: none"> The AC input cord is disconnected. Poor connection at AC wall outlet or the outlet is inactive. 	<ul style="list-style-type: none"> Connect cord securely. Check the outlet using a lamp or another appliance.
No playback	<ul style="list-style-type: none"> The disc is loaded upside down. The disc is not playable. The disc is dirty. The rating level is not set correctly. <ul style="list-style-type: none"> The symbol about invalid operation is displayed. 	<ul style="list-style-type: none"> Reload the disc with the printed side up. Use a playable disc. Clean the disc. Set the rating level setting correctly. (Refer to "When selecting the RATING LEVEL" on page 36.) Adjust the setting correctly. (Refer to "SYMBOL ABOUT INVALID OPERATION" on page 12.)
Malfunction	<ul style="list-style-type: none"> The disc is scratched or dirty badly. 	<ul style="list-style-type: none"> Press the POWER ON/OFF switch to switch the power off, press the POWER ON/OFF switch again and then unload the disc.
No picture	<ul style="list-style-type: none"> The video cords are disconnected. The incorrect selection of input source on the TV. The disc is not playable. 	<ul style="list-style-type: none"> Connect the cords correctly. Select the input source correctly. <ul style="list-style-type: none"> Use a playable disc.
Noisy or distorted picture	<ul style="list-style-type: none"> The unit is connected to a VCR directly and the copyguard function is activated. The disc is dirty. It is in rapid advance or reverse playback, or in frame advance or reverse playback. 	<ul style="list-style-type: none"> Connect the unit so that the picture signal is transferred directly to the TV. Clean the disc. Sometimes a small amount of picture distortion may appear. This is not malfunction.
Abnormal picture or no picture	<ul style="list-style-type: none"> The component video output signal is not selected correctly. 	<ul style="list-style-type: none"> Select the component video output signal correctly. (Refer to "CHANGING THE COMPONENT VIDEO OUTPUT SIGNAL" on page 26.)
Slight pause of picture	<ul style="list-style-type: none"> The layer transition occurs during playback of DVD Videos recoded in dual-layer format. 	<ul style="list-style-type: none"> Sometimes slight pause may occur. This is not malfunction.
No sound	<ul style="list-style-type: none"> The audio cords are disconnected. The speakers are disconnected to the amplifier. The incorrect selection of input source on the amplifier. The DIGITAL OUT is not set correctly. 	<ul style="list-style-type: none"> Connect the cords correctly. Connect the speakers correctly. Select the input source correctly. <ul style="list-style-type: none"> Set the DIGITAL OUT correctly. (Refer to "SETTING THE AUDIO SETUP" on page 33.)
Noisy or distorted sound	<ul style="list-style-type: none"> The disc is dirty. Poor connections. 	<ul style="list-style-type: none"> Clean the disc. Check the connections and connect all cords securely.
Remote control unit does not operate.	<ul style="list-style-type: none"> Batteries are not loaded or exhausted. The remote sensor is obstructed. 	<ul style="list-style-type: none"> Replace the batteries. Remove the obstacle.

Specifications

• TYPE

System | **DVD Video player system**

Signal read system | **Semiconductor laser, wavelength 650/790 nm**

• AUDIO SECTION

Frequency response

Sampling frequency : 44.1 kHz, CD | **4 Hz ~ 20 kHz**

Sampling frequency : 48 kHz, DVD Video | **4 Hz ~ 22 kHz**

Sampling frequency : 96 kHz, DVD Video | **4 Hz ~ 44 kHz**

Sampling frequency : 192 kHz, DVD Video | **4 Hz ~ 88 kHz**

Signal to noise ratio, IHF "A" weighted

CD | **110 dB**

Dynamic range

16 / 20 / 24 bit | **More than 99 / 108 / 108 dB**

Total harmonic distortion, 1 kHz

CD | **Less than 0.03 %**

Wow and flutter | **Unmeasurable (less than ± 0.002 %)**

Analog output level, 10 k Ω | **2.0 V**

Digital output level

Coaxial, 75 Ω | **0.5 Vp-p**

Optical, 660 nm | **- 21 ~ - 15 dBm**

• VIDEO SECTION

Video compression, DVD Video | **MPEG 2**

Horizontal resolution | **500 lines**

Signal to noise ratio | **More than 65 dB**

Output level, 75 Ω

VIDEO (regular, COMPOSITE) | **1.0 Vp-p**

S-VIDEO : Y/C | **1.0 / 0.286 Vp-p**

COMPONENT : Y / C_R / C_B | **1.0 / 0.7 / 0.7 Vp-p**

• GENERAL

Video signal format | **NTSC / PAL**

Power supply

U.S.A. and Canada | **120 V~60 Hz**

China, Europe, Australia and other countries | **220 - 240 V~50 / 60 Hz**

Power consumption | **15 W**

Dimension (W x H x D) | **435 x 73.5 x 254 mm (17-1/8 x 2-7/8 x 10 inches)**

Weight (Net) | **3.8 kg (8.4 lbs)**

Note : Design and specifications are subject to change without notice for improvements.

DVD Language Code List

Code	Language	Code	Language	Code	Language	Code	Language
1027	Afar	1186	Scots Gaelic	1350	Malayalam	1513	Siswati
1028	Abkhazian	1194	Galician	1352	Mongolian	1514	Sesotho
1032	Afrikaans	1196	Guarani	1353	Moldavian	1515	Sundanese
1039	Amharic	1203	Gujarati	1356	Marathi	1516	Swedish
1044	Arabic	1209	Hausa	1357	Malayalam	1517	Swahili
1045	Assamese	1217	Hindi	1358	Maltese	1521	Tamil
1051	Aymara	1226	Croatian	1363	Burmese	1525	Tegulu
1052	Azerbaijani	1229	Hungarian	1365	Nauru	1527	Tajik
1053	Bashkir	1233	Armenian	1369	Nepali	1528	Thai
1057	Byelorussian	1235	Interlingua	1376	Dutch	1529	Tigrinya
1059	Bulgarian	1239	Interlingue	1379	Norwegian	1531	Turkmen
1060	Bihari	1245	Inupiak	1393	Occitan	1532	Tagalog
1061	Bislama	1248	Indonesian	1403	(Afan) Oromo	1534	Setswana
1066	Bengali ; Bangla	1253	Icelandic	1408	Oriya	1535	Tonga
1067	Tibetan	1254	Italian	1417	Punjabi	1538	Turkish
1070	Breton	1257	Hebrew	1428	Polish	1539	Tsonga
1079	Catalan	1261	Japanese	1435	Pashto ; Pushto	1540	Tatar
1093	Corsican	1269	Yiddish	1436	Portuguese	1543	Twì
1097	Czech	1283	Javanese	1463	Quechua	1557	Ukrainian
1103	Welsh	1287	Georgian	1481	Rhaeto-Romance	1564	Urdu
1105	Danish	1297	Kazakh	1482	Kirundi	1572	Uzbek
1109	German	1298	Greenlandic	1483	Romanian	1581	Vietnamese
1130	Bhutani	1299	Cambodian	1489	Russian	1587	Volapük
1142	Greek	1300	Kannada	1491	Kinyarwanda	1613	Wolof
1144	English	1301	Korean	1495	Sanskrit	1632	Xhosa
1145	Esperanto	1305	Kashmiri	1498	Sindhi	1665	Yoruba
1149	Spanish	1307	Kurdish	1501	Sangro	1684	Chinese
1150	Estonian	1311	Kirghiz	1502	Serbo-Croatian	1697	Zulu
1151	Basque	1313	Latin	1503	Singhalese		
1157	Persian	1326	Lingala	1505	Slovak		
1165	Finnish	1327	Laothian	1506	Slovenian		
1166	Fiji	1332	Lithuanian	1507	Samoan		
1171	Faeroese	1334	Latvian ; Lettish	1508	Shona		
1174	French	1345	Malagasy	1509	Somali		
1181	Frisian	1347	Maori	1511	Albanian		
1183	Irish	1349	Macedonian	1512	Serbian		

V-903
DVD Player



Free Manuals Download Website

<http://myh66.com>

<http://usermanuals.us>

<http://www.somanuals.com>

<http://www.4manuals.cc>

<http://www.manual-lib.com>

<http://www.404manual.com>

<http://www.luxmanual.com>

<http://aubethermostatmanual.com>

Golf course search by state

<http://golfingnear.com>

Email search by domain

<http://emailbydomain.com>

Auto manuals search

<http://auto.somanuals.com>

TV manuals search

<http://tv.somanuals.com>