

**OPERATING INSTRUCTIONS  
BEDIENUNGSANLEITUNG**

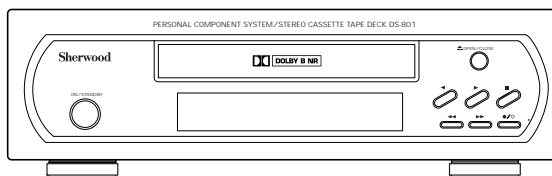

# DS-801

**Stereo Cassette Tape Deck  
Stereo Cassetten-Recorder**



# Introduction

## UNPACKING AND



ENGLISH

### ***Congratulations on Your Purchase!***

Your new high fidelity Cassette Tape Deck is designed to deliver maximum enjoyment and years of trouble free service. Please take a few moments to read this manual thoroughly. It will explain the features and operation of your unit and help ensure a trouble free installation.

Please unpack your Cassette Tape Deck carefully. We recommend that you save the carton and packing material. They will be helpful if you ever need to move your unit and may be required if you ever need to return it for service. Your Cassette Tape Deck is designed to be placed in a horizontal position and it is important to allow at least two inches of space behind your unit for adequate ventilation and cabling convenience.

To avoid damage, never place the unit near radiators, in front of heating vents, in direct sunlight, or in excessively humid or dusty locations. Connect your complementary components as illustrated in the following section.

	<b>CAUTION</b> RISK OF ELECTRIC SHOCK DO NOT OPEN	
<b>CAUTION : TO REDUCE THE RISK OF ELECTRIC SHOCK, DO NOT REMOVE COVER (OR BACK). NO USER-SERVICEABLE PARTS INSIDE. REFER SERVICING TO QUALIFIED SERVICE PERSONNEL.</b>		



This symbol is intended to alert the user to the presence of uninsulated "dangerous voltage" within the product's enclosure that may be of sufficient magnitude to constitute a risk of electric shock to persons.



This symbol is intended to alert the user to the presence of important operating and maintenance (servicing) instructions in the literature accompanying the appliance.

### **WARNING**

To reduce the risk of fire or electric shock, do not expose this appliance to rain or moisture.

### **FOR U.S.A**

#### **■ FCC INFORMATION**

This equipment has been tested and found to comply with the limits for a Class B digital device, pursuant to Part 15 of the FCC Rules. These limits are designed to provide reasonable protection against harmful interference in a residential installation. This equipment generates, uses and can radiate radio frequency energy and, if not installed and used in accordance with the instructions, may cause harmful interference to radio communications. However, there is no guarantee that interference will not occur in a particular installation. If this equipment does cause harmful interference to radio or television reception, which can be determined by turning the equipment off and on, the user is encouraged to try to correct the interference by one or more of the following measures:

- Reorient or relocate the receiving antenna.
- Increase the separation between the equipment and receiver.
- Connect the equipment into an outlet on a circuit different from that to which the receiver is connected.
- Consult the dealer or an experienced radio/TV technician for help.

**CAUTION:** Any changes or modifications in construction of this device which are not expressly approved by the party responsible for compliance could void the user's authority to operate the equipment.

**READ THIS BEFORE OPERATING****FOR U.S.A AND CANADA ..... 120 V****FOR YOUR SAFETY**

Units shipped to the U.S.A and Canada are designed for operation on 120 V AC only.

Observe all safety precautions for use of a polarized AC plug.

However, some products may be supplied with a non polarized plug.

**CAUTION :** *To prevent electric shock, match wide blade of plug to wide slot, insert fully.*

**FOR EUROPE AND AUSTRALIA ..... 230 V/240 V****FOR YOUR SAFETY**

Units shipped to Australia are designed for operation on 240 V AC only.

To ensure safe operation, the three-pin plug supplied must be inserted only into a standard three-pin power point which is effectively earthed through the normal household wiring. Extension cords used with the equipment must be three-core and be correctly wired to provide connection to earth. Improper extension cords are a major cause of fatalities.

The fact that the equipment operates satisfactorily does not imply that the power point is earthed and that the installation is completely safe. For your safety, if in any doubt about the effective earthing of the power point, consult a qualified electrician.

**PAN-EUROPEAN UNIFIED VOLTAGE**

All units are suitable for use on supplies 230-240 V AC.

**ENGLISH**

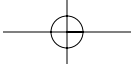

ENGLISH

# CONTENTS

**Introduction**

- UNPACKING AND INSTALLATION ..... 2
- READ THIS BEFORE OPERATING YOUR UNIT ..... 3

**Rear Panel Connections** ..... 5

**Front Panel & System Remote Controls** ..... 6

**Before Operation**

- NOTES ON CASSETTE TAPE ..... 8

**Operations**

- PLAYING BACK A TAPE ..... 9
- AMS(Automatic Music Search) PLAY ..... 10
- RECORDING ..... 11
- CD SYNCHRO RECORDING ..... 13

**Troubleshooting Guide** ..... 14

**Specifications** ..... 15

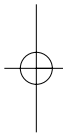
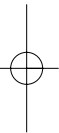

## Rear Panel Connections

- Do not plug the AC input cord into the AC outlet when plugging and unplugging connection cords.
- Be sure to connect the white plugs to the L(Left) and the red plugs to the R(Right) jacks when making connections with the supplied cords.
- Refer to the connecting diagram in the operating instructions of Sherwood system receiver RX-801R.

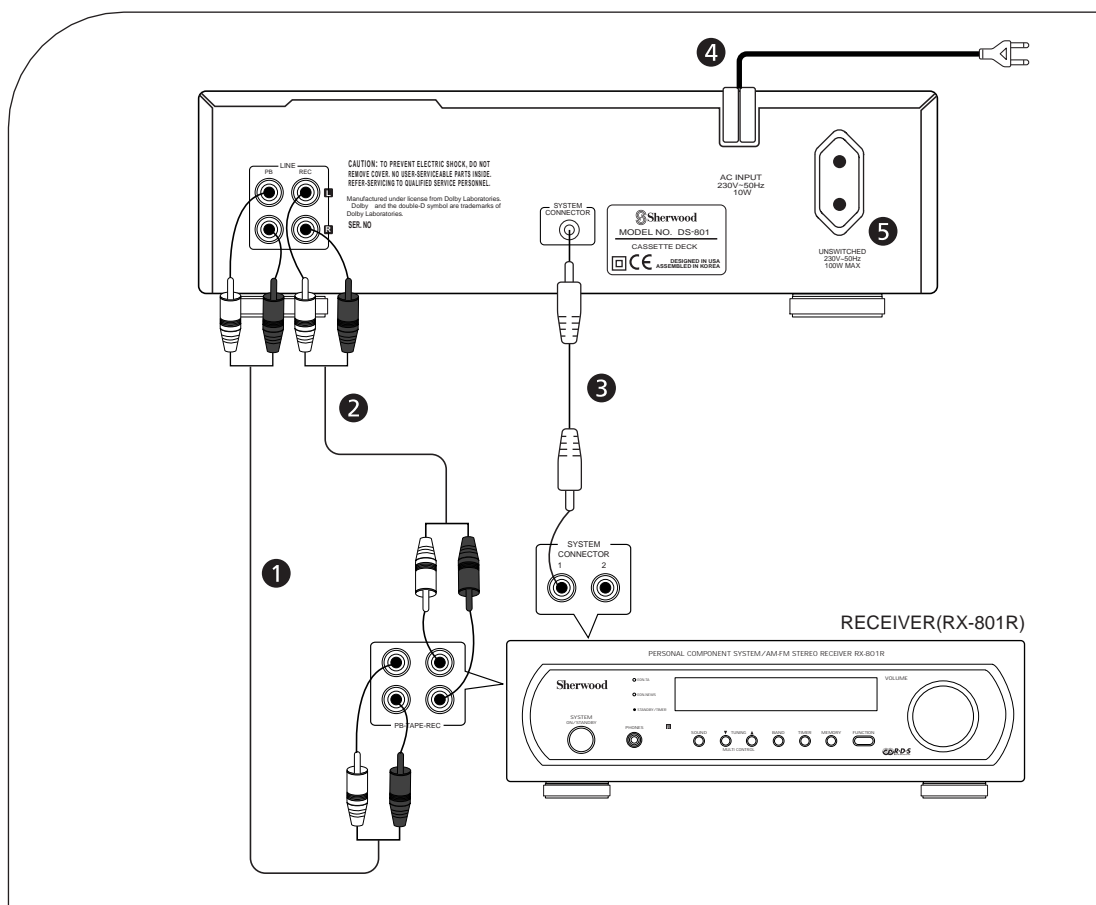

### 1, 2 LINE(REC) IN, (PLAY) OUT JACKS

Connect the LINE(PLAY) OUT jacks of this unit to the TAPE(PLAY) IN jacks of your receiver and the LINE(REC) IN jacks to the TAPE(REC) OUT jacks respectively.

### 3 SYSTEM CONNECTOR JACKS 1, 2

Connect this jack to the SYSTEM CONNECTOR jack of Sherwood system receiver RX-801R to control this unit remotely with the remote control unit of RX-801R.

(For details, refer to the operating instructions of RX-801R)

### 4 AC INPUT CORD

Plug this cord into a wall AC outlet or the switched or unswitched AC outlet of your system component.

### 5 UNSWITCHED AC OUTLET

- You can connect audio equipment like CD player.
- Power always flows to this outlet, regardless of whether this unit is switched ON or OFF if power flows through the AC input cord of this unit.

■Note : The equipment whose power consumption exceeds 100 watts should not be connected.

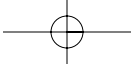

# Front Panel & System Remote Controls

ENGLISH

## Front Panel Controls

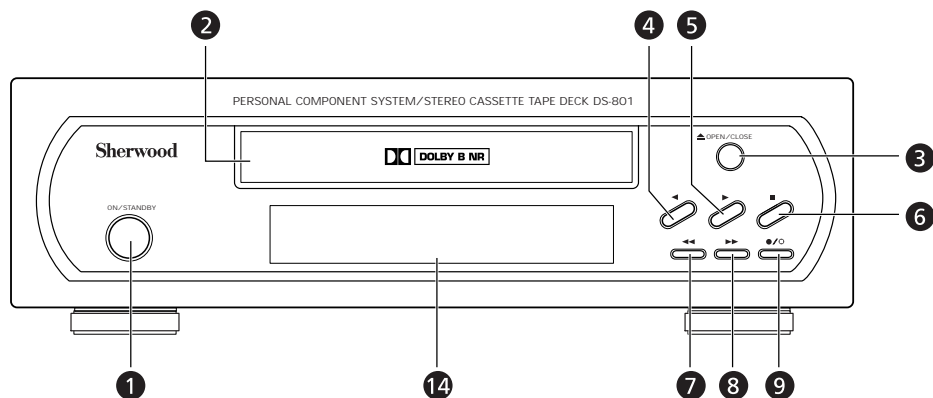

## System Remote Controls

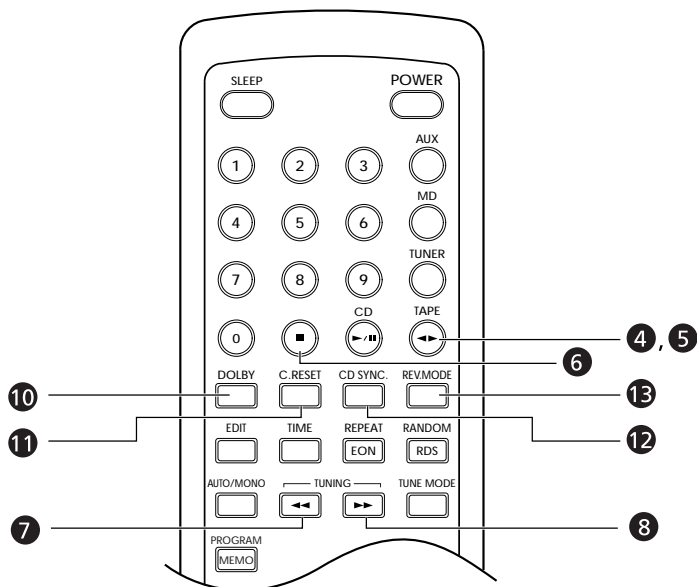

SYSTEM REMOTE CONTROL UNIT  
(only for RX-801R)

**1 POWER(ON/STANDBY) BUTTON**

- Press this button to turn the power on and press again to enter the standby mode.
- In standby mode, this unit is not disconnected from the AC mains and a small amount of current is retained for operation readiness.
- For system operation, connect this unit to Sherwood system receiver RX-801R as illustrated in the connecting diagram in the operating instructions of RX-801R, then this unit is turned on or off depending on the power operation on RX-801R.

**2 TAPE TRAY**

Load a tape with its exposed tape backwards.

**3 OPEN/CLOSE(▲) BUTTON**

Press this button to open or close the tape tray.

**4 REVERSE PLAY(◀) BUTTON**

Press this button to play back the back side of the tape.

**5 FORWARD PLAY(▶) BUTTON**

Press this button to play back the front side of the tape.

**6 STOP(■) BUTTON**

Press this button to stop the tape.

**7 REWIND(◀◀) BUTTON**

Press this button to rewind the tape rapidly during forward playback or to advance during reverse playback.

**8 FAST FORWARD(▶▶) BUTTON**

Press this button to advance the tape rapidly during forward playback or to rewind during reverse playback.

**9 RECORD/RECORD MUTE(●/○) BUTTON**

Press this button to record or to make a 4 second blank space between the programs for automatic music search, etc.

**10 DOLBY NR BUTTON**

Press this button to select the Dolby B NR system when playing back or recording.

**11 COUNTER RESET BUTTON**

Press this button to reset the counter to "0000".

**12 CD SYNCHRO RECORDING BUTTON**

Press this button to use the CD SYNCHRO RECORDING function.

**13 REVERSE MODE BUTTON**

Press this button to select the desired reverse mode.

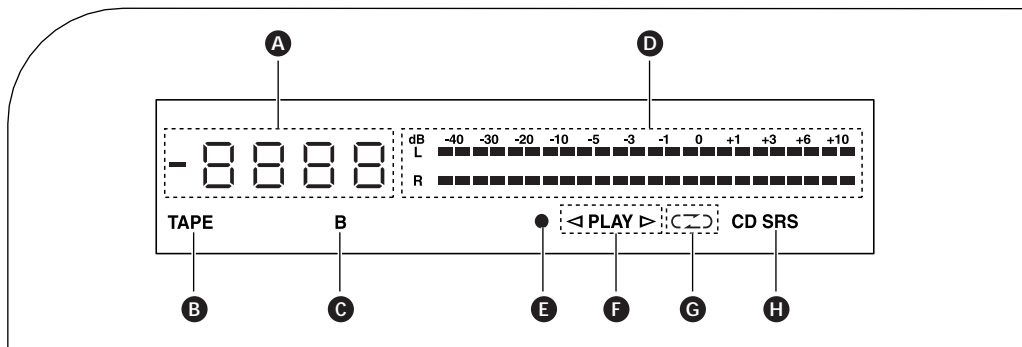
**14 FLUORESCENT DISPLAY**

- |                            |                                  |
|----------------------------|----------------------------------|
| Ⓐ TAPE COUNTER DISPLAY     | Ⓔ RECORD INDICATOR               |
| Ⓑ TAPE DETECTION INDICATOR | Ⓕ TAPE DIRECTION DISPLAY         |
| Ⓒ DOLBY B NR INDICATOR     | Ⓖ REVERSE MODE DISPLAY           |
| Ⓓ LEVEL METER DISPLAY      | Ⓗ CD SYNCHRO RECORDING INDICATOR |

**※WHEN USING THE SYSTEM REMOTE CONTROL UNIT OF RX-801R**

This unit can be remotely controlled with Sherwood system receiver RX-801R.

- To listen to a tape by using the system remote control unit of RX-801R, first connect SYSTEM CONNECTOR jack of this unit to that of Sherwood system receiver RX-801R.
- With the system remote control unit of RX-801R, you can use additional functions.

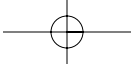

## Before Operation

### NOTES ON CASSETTE TAPE

ENGLISH

- Before loading a cassette tape, take up the slack in the tape to prevent it from becoming entangled around the capstan.

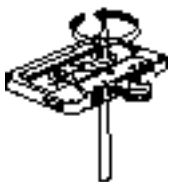

- After the recording has been finished, remove the tab to prevent the recorded contents from being erased or recorded on accidentally.

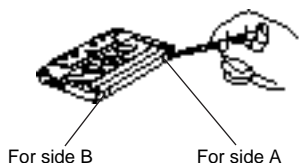

- To rerecord after tabs have been removed, cover with adhesive tape.

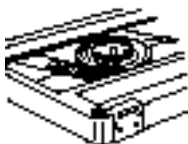

- Do not cover the tape detection holes for chrome (CrO<sub>2</sub>) tape.



- Do not store the tapes in direct sunlight or near equipment that generates heat. Keep the tapes away from any magnetic fields.
- Do not touch the tape surface and store the tapes in their cases after use. Dust can cause contamination of the heads resulting in noise.

#### ■ PRINCIPLE OF DOLBY B NR SYSTEM

The Dolby NR system functions so that it automatically increases recording levels of medium and high frequencies when the recording signal level is lower than the specified level(encoding), and automatically reduces the output level to the normal level during playback(decoding). In this way, the tape hissing noise is remarkably reduced without affecting the sound quality. The Dolby B NR system used in your Cassette Deck improves S/N ratio by about 5 dB at 1 kHz and about 10 dB at 10 kHz.

Manufactured under license from Dolby Laboratories. "Dolby" and the double-D symbol are trademarks of Dolby Laboratories.

#### ■ CLEANING THE HEAD SECTION

Clean the head section about every 10 hours of use with a commercially available head cleaning tape.

- For better recordings, you should clean the head section before every recording.
- After cleaning the head section, do not load a tape until the cleared section is completely dry.

#### ■ DEMAGNETIZING THE HEAD

When the recording/playback head is magnetized, the sound quality will be deteriorated.

In this case, demagnetize the head using a commercially available demagnetizer.

#### ■ AUTO TAPE SELECTOR

The type of tape loaded is detected automatically by the auto tape selector and recording bias and equalization are set automatically according to the characteristic of that tape such as normal or chrome(CrO<sub>2</sub>) tape.



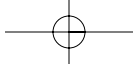

# Operations

- To use the system remote control unit of Sherwood system receiver RX-801R, first connect the SYSTEM CONNECTOR jack of this unit to that of RX-801R. (Refer to the operating instructions of the RX-801R.)

## PLAYING BACK A TAPE

ENGLISH

1

Turn the power on.

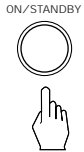

- Each time the POWER(ON/STANDBY) button is pressed, this unit is turned on or off.

2

Load a tape.



- According to the type of the tape loaded, the corresponding type(normal, chrome) is detected by the auto tape selector.
- Note:** Do not open or close the tape tray by force. Doing so may damage it.

3

In case of the tape recorded with Dolby B NR system, select the Dolby B NR mode.

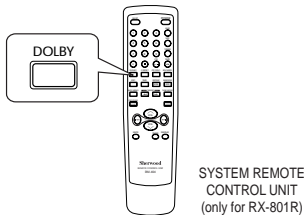

- Each time this button is pressed, the Dolby B NR mode changes as follows:  
→DOLBY B NR("B" light up) →OFF
- On the commercial tapes, if Dolby NR or "NR" appears, the tapes are recorded with the Dolby B NR.

4

Select the desired reverse mode.

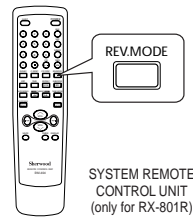

- Each time this button is pressed, the reverse mode is selected as follows:

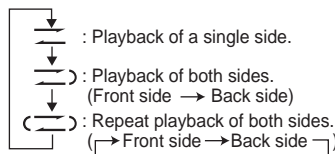

5

Start playback.

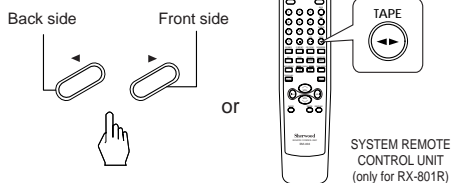

- Each time "TAPE ◀▶" button pressed, the corresponding side is played back.
- At the end of the tape, according to the reverse mode, the playback of the next side starts or the playback of the current side stops automatically.

**6** To stop playback.

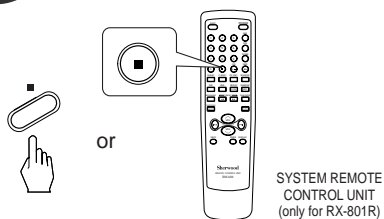

**7** To rapidly advance or rewind the tape, press the corresponding button in the stop mode.

- In case of forward playback (“▶”).

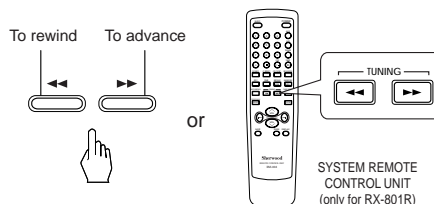

- At the desired point, press the STOP or corresponding PLAY button.

**8** In the current position, to reset the TAPE COUNTER to “0000”.

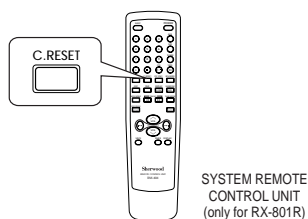

- “0000” appears in the tape counter.
- When winding or recording the tape, this function is convenient.

## AMS (Automatic Music)

- The automatic music search function automatically skips other musics, finds and starts playback from the desired music.
- Up to 99th music before or after the current music can be searched quickly on the current side.

- During playback, press the desired button.  
Example) In case of playback in direction of “▶”.

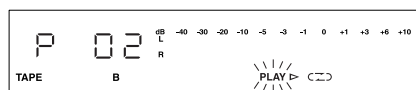
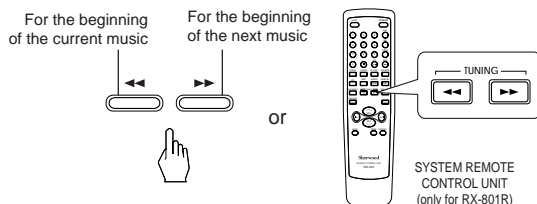

- Ex. 1) To playback the program number 4 while playing back the program number 2.  
Press “▶▶” button twice.
- Ex 2.) To playback the program number 3 again while playing back the program number 3.  
Press “◀◀” button only once.

- Automatic music search function might not operate as expected if:
  - The length of the blank space between two musics is less than 4 seconds.
  - The noise level of the blank space is very high.
  - The overall recorded volume level of a music is very low.

## RECORDING

1

Load a tape to be recorded.

▲ OPEN / CLOSE



- Be sure the erase-protection tabs on the tape are in place.
- The type of tape (normal or chrome) is automatically detected.
- The metal tapes are not recorded correctly.

## ■ Note

- When there is an erase-protection tab, to record on a single side, you should load a tape correctly or select the corresponding tape direction depending on the tape direction display (◀: Playback/recording of the back side, ▶: Playback/recording of the front side).
- For your reference, when loading a tape, the side facing up is the front side and the erase-protection tabs of the corresponding sides are as follows:

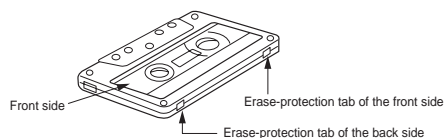

2

When recording with Dolby B NR system, select the Dolby B NR mode.

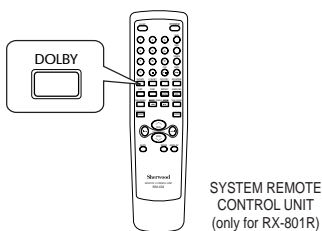

- "B" lights up.

3

Select the reverse mode.

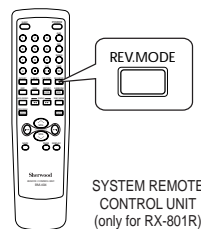

- According to the selected reverse mode, recording will be performed as follows:

— : Recording of a single side.  
 —) , (— : Recording of both sides.

- When selecting the recording of both sides and recording first on the back side, recording is made only on that side.
- Be sure the both of erase-protection tabs on the tape are in place when recording on the both sides.

4

Select the program source to be recorded. Example) When selecting the tuner.

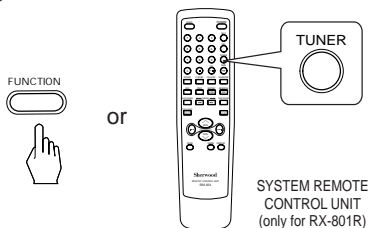

5

Press the RECORD/RECORD MUTE button to enter the recording pause mode.

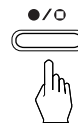

- "●" lights up and this unit enters the recording pause mode.
- In the recording pause mode, when this button is pressed, the unit will make a 4 second blank space and then enter the recording pause mode.

6

In the recording pause mode, press the corresponding PLAY button to start recording.

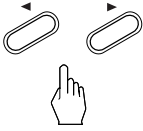

or

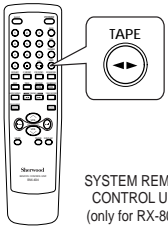

SYSTEM REMOTE  
CONTROL UNIT  
(only for RX-801R)

- “PLAY” lights up and recording starts.
- If recording is performed, start play on the desired recording source.

7

To temporarily stop recording

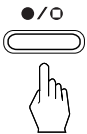

- The unit temporarily stops recording and enters the recording pause mode.
- To restart recording, press the corresponding PLAY button.

8

To stop recording



or

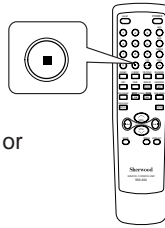

SYSTEM REMOTE  
CONTROL UNIT  
(only for RX-801R)

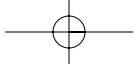

## CD SYNCHRO RECORDING

- When the SYSTEM CONNECTOR jack of this unit is connected to that of Sherwood system CD player CD-801, the CD synchro recording can be performed.

ENGLISH

1

Do the steps 1~3 in "RECORDING" procedure.

- Because CD synchro recording will start from the front side, be sure the erase-protection tab of the front side.
- Only when the both of the erase-protection tabs on the tape are in place, CD synchro recording can be performed on both sides.

2

Select the CD as recording source.

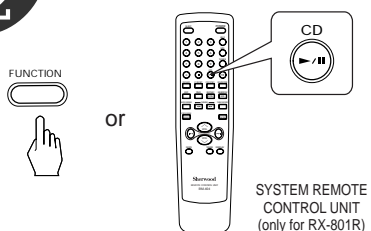

- When CD-801 is in the stop mode, the program mode (meaning "PROGRAM" lights up in the stop mode) and the edit mode, the CD synchro recording will be performed.
- In the random and repeat mode, the CD synchro recording cannot be performed.

3

Start CD synchro recording.

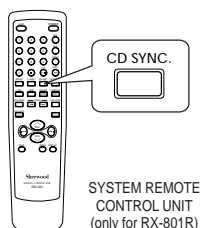

- "CD SRS", "●" indicators light up, this unit rewinds the tape rapidly automatically, makes a 8 seconds blank space from the beginning of the front side and then starts CD synchro recording.
- According to the selected reverse mode and the erase-protection tabs, recording is made on the front side or both sides.
- When selecting the recording of both sides as reverse mode, if recording on the front side has been finished, recording on the back side continues automatically and in this case, the track being recorded on the end of the front side will be recorded again on the back side.

4

To stop CD synchro recording.

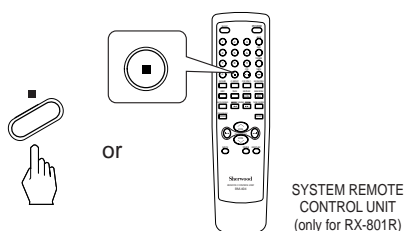

# Troubleshooting Guide

If your unit should not perform as expected, consult the table below to see if the problem can be corrected before seeking help from your dealer or our service organization.

ENGLISH

PROBLEM	POSSIBLE CAUSE	REMEDY
No power	<ul style="list-style-type: none"> <li>• The AC input cord is disconnected.</li> <li>• The POWER(ON/STANDBY) button is not pressed completely.</li> </ul>	<ul style="list-style-type: none"> <li>• Connect the cord securely.</li> <li>• Press the POWER(ON/STANDBY) button to ON.</li> </ul>
No sound	<ul style="list-style-type: none"> <li>• Unrecorded tape is loaded.</li> <li>• Incorrect connections.</li> <li>• Incorrect operation of the receiver.</li> </ul>	<ul style="list-style-type: none"> <li>• Load the recorded tape.</li> <li>• Make connections correctly.</li> <li>• Operate the receiver correctly.</li> </ul>
Distorted or abnormal sound	<ul style="list-style-type: none"> <li>• Dirty head.</li> <li>• Incorrect selection of the Dolby B NR system.</li> <li>• The tape is stretched or wrinkled.</li> </ul>	<ul style="list-style-type: none"> <li>• Clean the head.</li> <li>• Select the Dolby B NR mode or the Dolby B NR OFF mode.</li> <li>• Replace the tape.</li> </ul>
Vibrating sound	<ul style="list-style-type: none"> <li>• Dirty capstans or pinch rollers.</li> <li>• The tape is irregularly wound.</li> </ul>	<ul style="list-style-type: none"> <li>• Clean the capstans or pinch rollers.</li> <li>• Wind the tape by advancing or rewinding rapidly.</li> </ul>
Too noisy	<ul style="list-style-type: none"> <li>• Magnetized head.</li> <li>• Poor connections.</li> </ul>	<ul style="list-style-type: none"> <li>• Demagnetize the head.</li> <li>• Check the connections and connect all cords securely.</li> </ul>
No recording	<ul style="list-style-type: none"> <li>• The tabs have been removed.</li> <li>• Dirty head.</li> <li>• Too low recording level.</li> </ul>	<ul style="list-style-type: none"> <li>• Cover with the adhesive tape.</li> <li>• Clean the head.</li> <li>• Adjust the recording level properly.</li> </ul>

## Specifications

- Type ..... Stereo full logic cassette deck with Dolby B NR system
- Track system ..... 4-track, 2-channel stereo
- Recording system ..... AC bias system (bias frequency : 105 kHz)
- Erasing system ..... AC system
- Tape speed ..... 4.76 cm/sec.(1-7/8 ips)
- Heads ..... 1 erasing head and 1 recording/playback head(rotating)
- Wow and flutter, WRMS ..... 0.08 %
- Frequency response, -20 dB recording/playback, Dolby B NR OFF
  - Normal ..... 30~14,500 Hz,  $\pm 3$  dB
  - Chrome ..... 50~15,500 Hz,  $\pm 3$  dB
- Signal to noise ratio, weighted CCIR/ARM
  - Dolby B NR OFF, Normal/Chrome ..... 53/54 dB
  - Dolby B NR, Normal/Chrome ..... 63/64 dB
- Line input sensitivity/impedance ..... 400 mV/47 k $\Omega$
- Line output level/impedance ..... 500 mV/47 k $\Omega$
- Channel separation ..... 40 dB

### ■ GENERAL

- Power supply ..... AC 230 V, 50 Hz
- Power consumption ..... 10 W
- Unswitched AC outlet ..... Total 100 W max.
- Dimensions (W  $\times$  H  $\times$  D) ..... 270  $\times$  79  $\times$  255 mm
- Weight (Net) ..... 2.9 kg

Note: Design and specifications are subject to change without notice for improvements.

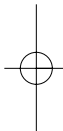
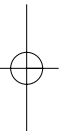
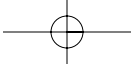

5707-21050-008-0





## Free Manuals Download Website

<http://myh66.com>

<http://usermanuals.us>

<http://www.somanuals.com>

<http://www.4manuals.cc>

<http://www.manual-lib.com>

<http://www.404manual.com>

<http://www.luxmanual.com>

<http://aubethermostatmanual.com>

Golf course search by state

<http://golfingnear.com>

Email search by domain

<http://emailbydomain.com>

Auto manuals search

<http://auto.somanuals.com>

TV manuals search

<http://tv.somanuals.com>