



# OPERATING INSTRUCTIONS





## VD-4500 Progressive Scan DVD Player



*Progressive Scan*

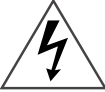

# Introduction

## READ THIS BEFORE OPERATING YOUR UNIT

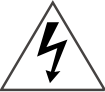
	<b>CAUTION</b> RISK OF ELECTRIC SHOCK DO NOT OPEN	
<b>CAUTION:</b> TO REDUCE THE RISK OF ELECTRIC SHOCK, DO NOT REMOVE COVER (OR BACK). NO USER-SERVICEABLE PARTS INSIDE. REFER SERVICING TO QUALIFIED SERVICE PERSONNEL.		

	This symbol is intended to alert the user to the presence of uninsulated "dangerous voltage" within the product's enclosure that may be of sufficient magnitude to constitute a risk of electric shock to persons.
	This symbol is intended to alert the user to the presence of important operating and maintenance (servicing) instructions in the literature accompanying the appliance.

**WARNING :** TO REDUCE THE RISK OF FIRE OR ELECTRIC SHOCK,  
DO NOT EXPOSE THIS APPLIANCE TO RAIN OR MOISTURE.

### FCC INFORMATION (FOR U.S.A.)

This equipment has been tested and found to comply with the limits for a Class B digital device, pursuant to Part 15 of the FCC Rules. These limits are designed to provide reasonable protection against harmful interference in a residential installation. This equipment generates, uses and can radiate radio frequency energy and, if not installed and used in accordance with the instructions, may cause harmful interference to radio communications. However, there is no guarantee that interference will not occur in a particular installation. If this equipment does cause harmful interference to radio or television reception, which can be determined by turning the equipment off and on, the user is encouraged to try to correct the interference by one or more of the following measures :

- Reorient or relocate the receiving antenna.
- Increase the separation between the equipment and receiver.
- Connect the equipment into an outlet on a circuit different from that to which the receiver is connected.
- Consult the dealer or an experienced radio/TV technician for help.

**CAUTION :** Any changes or modifications in construction of this device which are not expressly approved by the party responsible for compliance could void the user's authority to operate the equipment.

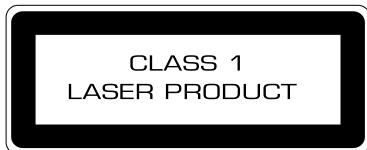

### CAUTION

Invisible laser radiation when the unit is open.  
Do not stare into beam.

**CAUTION :** USE OF ANY CONTROLS, ADJUSTMENTS, OR PROCEDURES OTHER THAN THOSE SPECIFIED HEREIN MAY RESULT IN HAZARDOUS RADIATION EXPOSURE.

# Safety Introduction

1. **Read Instructions** – All the safety and operating instructions should be read before the product is operated.
2. **Retain Instructions** – The safety and operating instructions should be retained for future reference.
3. **Heed Warnings** – All warnings on the product and in the operating instructions should be adhered to.
4. **Follow Instructions** – All operating and use instructions should be followed.
5. **Cleaning** – Unplug this product from the wall outlet before cleaning. Do not use liquid cleaners or aerosol cleaners. Use a damp cloth for cleaning.
6. **Attachments** – Do not use attachments not recommended by the product manufacturer as they may cause hazards.
7. **Water and Moisture** – Do not use this product near water – for example, near a bath tub, wash bowl, kitchen sink, or laundry tub; in a wet basement, or near a swimming pool; and the like.
8. **Accessories** – Do not place this product on an unstable cart, stand, tripod, bracket, or table. The product may fall, causing serious injury to a child or adult, and serious damage to the product. Use only with a cart, stand, tripod, bracket, or table recommended by the manufacturer, or sold with the product. Any mounting of the product should follow the manufacturer's instructions, and should use a mounting accessory recommended by the manufacturer.
9. A product and cart combination should be moved with care. Quick stops, excessive force, and uneven surfaces may cause the product and cart combination to overturn.
10. **Ventilation** – Slots and openings in the cabinet are provided for ventilation and to ensure reliable operation of the product and to protect it from overheating, and these openings must not be blocked or covered. The openings should never be blocked by placing the product on a bed, sofa, rug, or other similar surface. This product should not be placed in a built-in installation such as a bookcase or rack unless proper ventilation is provided or the manufacturer's instructions have been adhered to.
11. **Power Sources** – This product should be operated only from the type of power source indicated on the marking label. If you are not sure of the type of power supply to your home, consult your product dealer or local power company. For products intended to operate from battery power, or other sources, refer to the operating instructions.
12. **Grounding or Polarization** – This product may be equipped with a polarized alternating-current line plug (a plug having one blade wider than the other). This plug will fit into the power outlet only one way. This is a safety feature. If you are unable to insert the plug fully into the outlet, try reversing the plug. If the plug should still fail to fit, contact your electrician to replace your obsolete outlet. Do not defeat the safety purpose of the polarized plug. Alternate Warnings – This product is equipped with a three-wire grounding-type plug, a plug having a third (grounding) pin. This plug will only fit into a grounding-type power outlet. This is a safety feature. If you are unable to insert the plug into the outlet, contact your electrician to replace your obsolete outlet. Do not defeat the safety purpose of the grounding-type plug.
13. **Power – Cord Protection** – Power-supply cords should be routed so that they are not likely to be walked on or pinched by items placed upon or against them, paying particular attention to cords at plugs, convenience receptacles, and the point where they exit from the product.
14. **Outdoor Antenna Grounding** – If an outside antenna or cable system is connected to the product, be sure the antenna or cable system is grounded so as to provide some protection against voltage surges and built-up static charges. Article 810 of the National Electrical Code, ANSI/NFPA 70, provides information with regard to proper grounding of the mast and supporting structure, grounding of the lead-in wire to an antenna discharge unit, size of grounding conductors, location of antenna-discharge unit, connection to grounding electrodes, and requirements for the grounding electrode. See Figure 1.



Figure 1  
Example of antenna grounding as per  
National Electrical Code, ANSI/NFPA 70

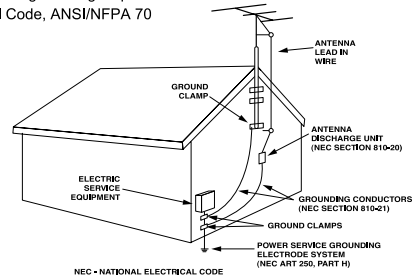

15. **Lightning** – For added protection for this product during a lightning storm, or when it is left unattended and unused for long periods of time, unplug it from the wall outlet and disconnect the antenna or cable system. This will prevent damage to the product due to lightning and power-line surges.
16. **Power Lines** – An outside antenna system should not be located in the vicinity of overhead power lines or other electric light or power circuits, or where it can fall into such power lines or circuits. When installing an outside antenna system, extreme care should be taken to keep from touching such power lines or circuits as contact with them might be fatal.
17. **Overloading** – Do not overload wall outlets, extension cords, or integral convenience receptacles as this can result in a risk of fire or electric shock.
18. **Object and Liquid Entry** – Never push objects of any kind into this product through openings as they may touch dangerous voltage points or short-out parts that could result in a fire or electric shock. Never spill liquid of any kind on the product.
19. **Servicing** – Do not attempt to service this product yourself as opening or removing covers may expose you to dangerous voltage or other hazards. Refer all servicing to qualified service personnel.
20. **Damage Requiring Service** – Unplug this product from the wall outlet and refer servicing to qualified service personnel under the following conditions :
  - a) When the power-supply cord or plug is damaged,
  - b) If liquid has been spilled, or objects have fallen into the product,
  - c) If the product has been exposed to rain or water,
  - d) If the product does not operate normally by following the operating instructions. Adjust only those controls that are covered by the operating instructions as an improper adjustment of other controls may result in damage and will often require extensive work by a qualified technician to restore the product to its normal operation.
  - e) If the product has been dropped or damaged in any way, and
  - f) When the product exhibits a distinct change in performance - this indicates a need for service.
21. **Replacement Parts** – When replacement parts are required, be sure the service technician has used replacement parts specified by the manufacturer or have the same characteristics as the original part. Unauthorized substitutions may result in fire, electric shock, or other hazards.
22. **Safety Check** – Upon completion of any service or repairs to this product, ask the service technician to perform safety checks to determine that the product is in proper operating condition.
23. **Wall or Ceiling Mounting** – The product should be mounted to a wall or ceiling only as recommended by the manufacturer.
24. **Heat** – The product should be situated away from heat sources such as radiators, heat registers, stoves, or other products (including amplifiers) that produce heat.

**Notes:**

1. Item 12 is not required except for grounded or polarized product.
2. Item 14 and 16 are not required except for units provided with antenna terminals.
3. Item 14 complies with UL in U.S.A.

# Precautions

FOR YOUR SAFETY		
<b>U.S.A and CANADA</b>	<b>120V</b>	<p>Units shipped to the U.S.A and Canada are designed for operation on 120V AC only.</p> <p>Safety precaution with use of a polarized AC plug. However, some products may be supplied with a nonpolarized plug.</p> <p><b>CAUTION</b> : To prevent electric shock, match wide blade of plug to wide slot, fully insert.</p> <p><b>ATTENTION</b> : Pour éviter chocs électriques, introduire la lame la plus large de la fiche dans la borne correspondante de la prise et pousser jusqu' au fond.</p>
<b>CHINA, EUROPE, AUSTRALIA and other countries</b>	<b>220V ~ 240V</b>	<p>The available power supply voltage differs according to country or region. However, this unit is equipped with an Automatic Voltage Selector. The power supply voltage of the area where the unit will be used automatically meets the required voltage within the range of AC 100 - 240 V, without any manual voltage adjustment.</p> <p>To ensure safe operation, the three-pin plug supplied must be inserted only into a standard three-pin power point which is effectively earthed through the normal household wiring. Extension cords used with the equipment must be three-core and be correctly wired to provide connection to earth.</p> <p>Improper extension cords are a major cause of fatalities. The fact that the equipment operates satisfactorily does not imply that the power point is earthed and that the installation is completely safe. For your safety, if in any doubt about the effective earthing of the power point, consult a qualified electrician.</p>

## PRECAUTIONS

- Moisture condensation  
Moisture may form on the lens in the following conditions.

  - Immediately after a heater has been turned on.
  - In a steamy or very humid room.
  - When this unit is moved from a cold place to a warm one.  
If moisture forms inside this unit, it may not operate properly.  
In this case, turn on the power and wait about one hour for the moisture to evaporate.
- If there is noise interference on the TV while a broadcast is being received.  
Depending on the reception condition of the TV, interference may appear on the TV screen while you are watching a TV broadcast and this unit is left on. This is not a malfunction of this unit or the TV.  
To watch a TV broadcast, turn off this unit.
- Do not transport this unit with discs left in it.
- Do not place on the component such as amplifier or receiver that generates heat.  
If so, the temperature inside this unit rises and malfunction may occur.

# Contents

Introduction / Safety Introduction / Precautions .....	2
--	---

## Getting Started

Notes on Discs .....	6
Playable Discs / Notes on DVD Videos / About Video CDs / MP3/WMA/JPEG Compatibility / Care and Handling Discs / Differences in Disc Composition / Notes on Copyright	

## Facilities and Connections

Control Position and Names .....	9
Front Panel / Rear Panel / Display / Remote Controller	
Preparing the Remote Controller .....	12
Inserting the Batteries / Using the Remote Controller	
System Connections .....	13
Before Making Any Connections / AV Cable & Sockets / Connecting to a TV / Connecting to A/V Amplifier or Receiver	

## Basic Operations

Turning on .....	16
Connecting the POWER	
Basic Playback .....	17
Starting Playback / Various Playback / Playing back MP3/WMA/JPEG / Rotating a Picture(JPEG Files Only) / Various Play Modes	

## Advanced Operations

Other Operations .....	20
Locating a Specific Title / Chapter / Track / File by Entering the Numbers / Video CD / CD Program Playback / MP3 / WMA / JPEG Program Playback / Random Play / Repeat Play / A-B Repeat Play / Viewing Information	
DVD Settings .....	26
Selecting a Playback Audio Setting / Changing the Subtitle Language / Changing the Camera Angle	

## Function Setup

Customizing the Function Settings .....	27
Progressive Setting / Setting Steps / General Setup / Audio Setup / Preferences	

## Others

Troubleshooting .....	32
Specifications .....	34
DVD Menu Language Code List .....	35

# Notes on Discs

## Playable Discs

This DVD Player can playback the following discs.

	Disc Mark
DVD Videos	
VIDEO CDs	
Audio CDs	
CD-Rs <sup>*1</sup> CD-RWs <sup>*1</sup>	 

\*1 This unit can play CD-R and CD-RW discs recorded in CD Audio or Video CD format, with MP3 audio files or with JPEG image files. However, there may be some discs that cannot be played back with this unit. The causes of this impossibility include incompleteness of disc finalization and the recording characteristics of the recorder as well as the properties, damage or stain of the disc in use and stain or condensation on the pickup lens of this unit. For details, please refer to the instruction manual of the recorder.

- You cannot playback discs other than those listed above.
- This unit can play SVCDs, but some functions will not work.
- This unit can play DVD-R, DVD+R, DVD-RW, and DVD+RW discs, but depending on the recording unit, the disc manufacturer, etc., playback sometimes may not be possible.
- This player cannot play back any of the following discs.
  - DVD AUDIO discs
  - DVD-ROM discs
  - DVD-RAM discs
  - SACD discs
  - CD-ROM discs (Except MP3 and JPEG discs [ISO 9660 level 1])
  - VSD discs
  - CDV discs (Only the audio part can be reproduced.)
  - CD-G/CD-EG / CD-EXTRA discs (Only the audio can be reproduced.)
  - Photo CD discs (Never attempt to play them.)
- This DVD receiver uses the PAL/NTSC color system, and cannot playback DVD videos recorded in any other color system (SECAM, etc.).

- Avoid using heart-shaped or octagonal discs. Playing irregularly shaped discs may damage the internal mechanism of the DVD receiver.

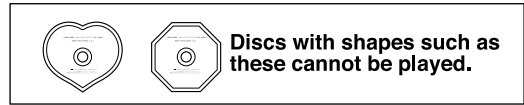

- Do not use discs that have residue from adhesive tape, rental discs that have peeling labels, or discs that have custom labels or stickers. Otherwise, you may not be able to eject the discs or the DVD receiver may become inoperative.

### About playing copy-controlled CDs

Some audio CDs feature copy protection that doesn't conform to the official CD standard. Since these are nonstandard discs, they may not play properly in the VD-4500.

## Notes on DVD Videos

### Region code

- DVD players and DVD Videos have their own Region Code numbers which are assigned to each country or area as shown below. DVD players are set to your Region Code number at the factory. As a result, if the region code number of this DVD player is different from that of the DVD Video, playback of the DVD Video will not be allowed by the DVD player.

Major countries or area	All regions	North America	Europe, Japan, Middle East	Southeast Asia	Oceania, South America	Russia	China
Playable Region code							

Examples of playerble DVD Videos :



- In U. S. A



- In Europe

# Notes on Discs

## About Video CDs

This DVD Player supports Video CDs equipped with the PBC(Version 2.0) function (PBC is the abbreviation for Playback Control).

You can enjoy two playback variations depending on the type of disc.

- **Video CD not equipped with PBC function (Version 1.1)**  
Sound and movies can be played on this DVD Player in the same way as an audio CD.
- **Video CD equipped with PBC function (Version 2.0)**  
In addition to operation of a VIDEO CD not equipped with the PBC function, you can enjoy playback with interactive software and search function using the menu displayed on the TV screen (Menu Playback). Some of the functions described in this Instruction Manual may not work with some discs.

## MP3/WMA/JPEG Compatibility

- This unit will play CD-R, and CD-RW discs containing files saved in the MPEG-1 Audio Layer 3 (MP3) or Windows Media Audio (WMA) format with a sampling rate of 32\*, 44.1 or 48 kHz, and JPEG format. Incompatible files will not play.  
Disc may be ejected automatically or "NO DISC" will be displayed.  
\* This unit will not play 32 kHz WMA files encoded at 20 kbps.
- Fixed bit rate MP3 files are recommended. Variable bit rate(VBR) MP3 files are playable, but playing times may not be shown correctly.
- This player is compatible with WMA data encoded using Windows Media Player version 8 (or less) or Windows Media Player for Windows XP.
- This player is not compatible with lossless encoding or variable bit rate (VBR) WMA files.
- WMA files encoded with DRM (Digital Rights Management) copy protection will not play. Disc may be ejected automatically or "NO DISC" will be displayed.
- WMA/MP3/JPEG discs must be ISO 9660 Level 1 or 2 compliant. CD physical format: Mode1, Mode2 XA Form1.  
Romeo and Joliet file systems are both compatible with this player.
- Use CD-R or CD-RW media for recording your files. The disc must be finalized (i.e., the session must be closed) in order to play in this unit.
- This player only plays tracks that are named with the file extension .mp3, .MP3, .wma, .WMA, .jpg or .JPG.
- When naming MP3, WMA and JPEG files, add the corresponding file name extension (.mp3, .wma or .jpg). Files are played according to the file extension.

To prevent noise and malfunctions, do not use these extensions for other kinds of files.

- Folder and track names (excluding the file extension) are displayed.
- There are many different recording bit rates available to encode MP3 files. This unit was designed to be compatible with all of them. Audio encoded at 128 Kbps should sound close to standard audio CD quality. This player will play lower bit rate files, but please note that the sound quality becomes noticeably worse at lower bit rates.
- The DV-SP302 can play Exif format pictures supporting JPEG. It is capable of playing at the maximum resolution of 5120x3840 for the baseline format, 2048x1536 for the progressive JPEG format.

## When saving files onto media

Ensure that the session is closed or finalized when data has been written on media. There are cases where media on which the session has not been closed or finalized will not be played back correctly with this equipment.

- There are cases where the folder names and file names will not be displayed correctly depending on the software used to save them.
- Do not store files or folders other than MP3, WMA or JPEG on media to be played back with this equipment.
- It is recommended that ten or less sessions are stored when recording MP3 files onto a media.
- In case of a multisession disc, some time may be required until playback begins.
- There are cases where playback is not possible when MP3/WMA/JPEG files (CD-ROM) and music CD information (CD-DA) are saved on the same media.



# Notes on Discs

## Care and Handling of Discs

- In handling a disc, hold it carefully with edges.



- Do not stick paper or write anything on the printed surface.

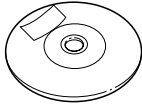

- Fingermarks and dust on the recorded surface should be carefully wiped off with a soft cloth. Wipe straight from the inside to the outside of the disc.

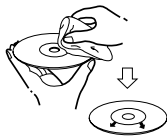

- Always keep the discs in their cases after use to protect them from dust and scratches.



- Do not use a cracked, deformed, or repaired disc. These discs are easily broken and may cause serious personal injury and apparatus malfunction.



### Notes:

- Because the temperature inside this unit is very high, in case of no further playback of disc, unload the disc to prevent the high temperature from deforming the disc.
- Do not expose discs to direct sunlight, high humidity or high temperature for a long time.
- When loading or unloading a disc in the disc tray, always place it with the printed side up.



Printed Side

## Differences in Disc Composition

### ■ DVD

All discs are divided up into smaller, more manageable sections so that you can find specific content more easily. DVDs are divided into one or more titles. Each title may be further divided into several chapters. Occasionally, a chapter may contain index points, effectively dividing the chapter up into several parts.

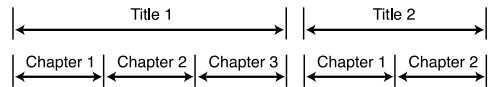

### ■ Video CD/CD

Video CDs and CDs are divided into a number of tracks. In rare cases, a track may contain a number of index points, effectively dividing the track up into several parts.

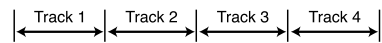

### ■ MP3/WMA/JPEG

MP3 (MPEG 1 Audio Layer 3) is a compressed audio file format.

JPEG is a format for saving image files, such as those containing digital photographs or illustrations.

Tracks within folders are automatically numbered T\_001, T\_002, etc.

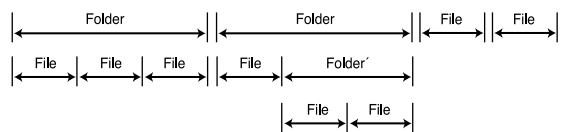

## Notes on Copyright

- Please check the copyright laws in your country to record from DVD Video, CD and MP3 disc, etc. Recording of copyrighted material may infringe copyright laws.
- DVD Video is protected by the copyguard system.
- When you connect the unit to your VCR directly, the copyguard system activates and the picture may not be played back correctly.

This product incorporates copyright protection technology that is protected by U.S. patents and other intellectual property rights. Use of this copyright protection technology must be authorized by Macrovision, and is intended for home and other limited viewing uses only unless otherwise authorized by Macrovision. Reverse engineering or disassembly is prohibited.

# Control Position and Name

## Front Panel

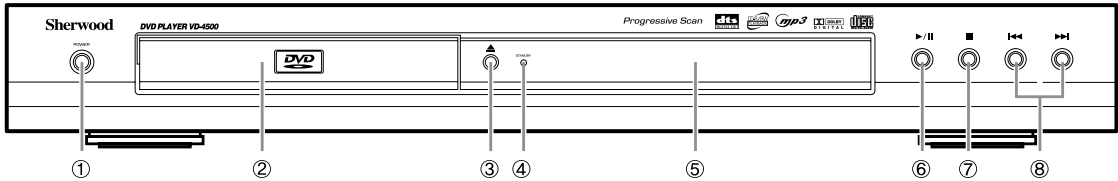

- ① **POWER button**  
Turns on the main power supply.
- ② **Disc tray**  
Toggle for standby and on.
- ③ **Open/Close ▲ button**  
Press to open or close the disc tray.
- ④ **STANDBY indicator**  
Lights in the standby mode.
- ⑤ **Display**
- ⑥ **Play/Pause ►/II button**  
Begins to play disc (close disc tray first if it is open). Temporarily stops playback when a disc is playing. Press this button again for normal playback.
- ⑦ **Stop ■ button**  
Stops playing a disc. When disc is playing, if you press **Stop ■** and **Play ►**, the disc will start resume play. When **Stop ■** is pressed again during stop mode, the resume function is canceled.
- ⑧ **Skip ◀◀/▶▶ buttons**  
Allow you to move to the previous chapter or track / the next chapter or track on a disc.

## Rear Panel

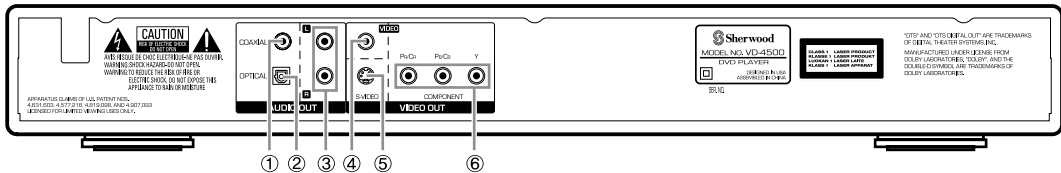

- ① **DIGITAL OUTPUT COAXIAL jack**  
Use coaxial cable to connect your DVD Player to an AV component that features digital input capability. If the component has a Dolby Digital or DTS decoder, you can enjoy theater-quality multichannel sound.
- ② **DIGITAL OUTPUT OPTICAL jack**  
Use optical cable to connect your DVD Player to an AV component that features digital input capability. If the component has a Dolby Digital or DTS decoder, you can enjoy theater-quality multichannel sound.
- ③ **ANALOG OUTPUT jacks**  
Insert audio cables (left and rights) to these jacks on your DVD Player and to the corresponding Audio Input jacks (left and right) on your TV or receiver.
- ④ **VIDEO OUTPUT VIDEO jack**  
Connect a video cable to this jack and to the Video Input jack on your TV.
- ⑤ **VIDEO OUTPUT S-VIDEO jack**  
If your TV has a S-Video jack, you can connect an S-Video cable to your TV and to your DVD Player for improved video quality. The S-Video cable only carries the video signal; remember to connect the left and right audio cables.
- ⑥ **VIDEO OUTPUT COMPONENT (Pr/Cr, Pb/Cb, Y) jacks**  
If your TV has component inputs, you can connect a component video cable to your TV and to your DVD Player for ideal video quality. The component video cable only carries the video signal; remember to connect the left and right audio cables. If you connect a TV that is compatible with a Progressive scan signal, you can enjoy both Interlaced and Progressive scan.

# Control Position and Name

## Display

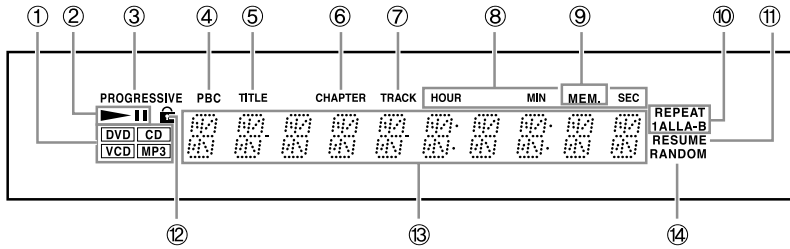

- ① **Disc indicators**  
Indicate the type of disc currently loaded.
- ② **Play/Pause indicators**  
Illuminate in play or pause mode.
- ③ **PROGRESSIVE indicator**  
Illuminates when the DVD player is set to progressive mode.
- ④ **PBC indicator**  
Illuminates when PBC is on for Video CD.
- ⑤ **TITLE indicator**  
Illuminates to indicate the current title number.
- ⑥ **CHAPTER indicator**  
Indicates display mode of the current chapter of DVD disc.
- ⑦ **TRACK indicator**  
Indicates display mode of the current track number of Video CD or CD.
- ⑧ **Time indicator**  
Indicate playing time.
- ⑨ **MEM. indicator**  
Illuminates during memory playback.
- ⑩ **REPEAT indicator**  
Illuminates during repeat playback.
- ⑪ **RESUME indicator**  
Illuminates when the player is ready for resume playback.
- ⑫ **Parental Lock indicator**  
Illuminates in parental lock mode.
- ⑬ **Multifunction indicator**  
Indicates operating status, messages, etc.
- ⑭ **RANDOM indicator**  
Illuminates during random playback.

## ■ Display Examples

### • During DVD-Video playback:

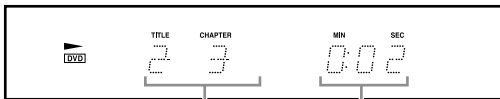

Playing chapter 3 of title 2 Time information of the current chapter

#### Notes

Some discs may not display chapter numbers.

### • During Video CD playback:

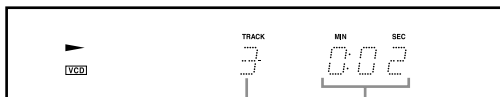

Playing track 3 Time information of the current track

#### Note

Some discs may not display track numbers or elapsed time.

### • During CD playback:

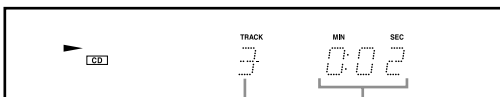

Playing track 3 Time information of the current track

### • During MP3/WMA audio playback:

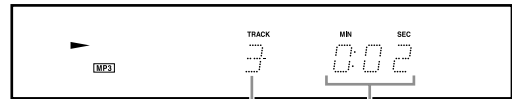

Playing track 3 Time information of the current track

#### Notes

Track number is consecutive.

### • During JPEG image playback:

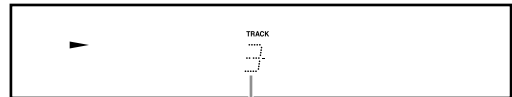

Playing 3rd image

#### Note

The disc indicator does not light up for CDs that contain JPEG images.

# Control Position and Name

## Remote Controller

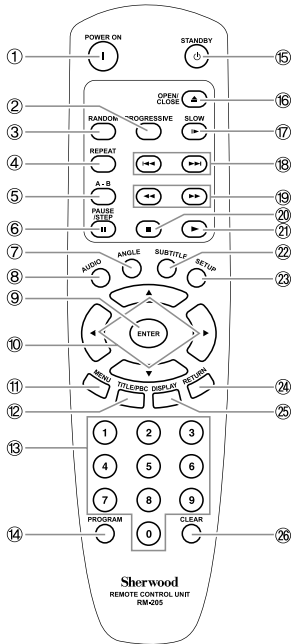

- ① **POWER ON button**  
Toggle for Standby on.
- ② **PROGRESSIVE button**  
When component video connection is used to connect this player and TV is compatible with progressive, press to enjoy the progressive video image.
- ③ **RANDOM button**  
Press to do random playback.
- ④ **REPEAT button**  
Press to repeat playback. You can repeat a title, chapter, track or entire discs.
- ⑤ **A-B button**  
Press to play section A-B repeatedly.
- ⑥ **PAUSE button**  
Temporarily stops playback when a disc is playing. Press PLAY button for normal playback.
- ⑦ **ANGLE button**  
Press to select various camera angles on a disc.
- ⑧ **AUDIO button**  
Press to select various audio languages on a disc. When playing a Video CD, press to select the audio channel.
- ⑨ **ENTER button**  
Press this button to select and execute a highlighted menu item.
- ⑩ **Cursor buttons (▲/▼/◀/▶)**  
Use the cursor buttons to select the items or settings.
- ⑪ **MENU button**  
Displays the DVD Disc Menu on the TV screen in play mode and Setup Menu in stop mode.

- ⑫ **TITLE / PBC button**  
If some DVD Videos which contain more than one title may have the menu like as a list of the titles, the TITLE button can be used to select the desired title. (The details of operation differ depending on the disc used.) When playing a Video CD equipped with PBC function, DVD Player will automatically enter the PBC on mode. Press once to turn PBC off and press again to turn on.
- ⑬ **Number buttons(0-9)**  
Select numbers by pressing these buttons.
- ⑭ **PROGRAM button**  
Press to see Program Edit Display on the screen in stop mode.
- ⑮ **STANDBY button**  
Toggle for Standby Off.
- ⑯ **OPEN/CLOSE ▲ button**  
Press to open or close the disc tray.
- ⑰ **SLOW ◀/▶ buttons**  
Allow you to play movies in slow mode. Each time you press this button, slow speed will be changed. In the case of Video CD, reverse SLOW cannot be activated.
- ⑱ **SKIP ◀◀/▶▶ buttons**  
Allow you to move to the previous chapter or track / the next chapter or track on a disc.
- ⑲ **SEARCH ◀◀/▶▶ buttons**  
Allow you to search in reverse or forward through a disc while it is in play mode. Each time you press these buttons, search speed changes.
- ⑳ **STOP ■ button**  
Stops playing a disc. When a disc is playing, if you press STOP ■ and PLAY ▶, the disc will start resume play. When STOP ■ is pressed again during stop mode, the resume function is canceled.
- ㉑ **PLAY ▶ button**  
Begins to play disc (close disc tray first if it is open).
- ㉒ **SUBTITLE button**  
Press to select various subtitle language on a disc.
- ㉓ **SETUP button**  
Press to call up the Setup menu programmed on the DVD. Depending on the DVD, the Setup menu may be identical to DVD menu or title menu.(In Stop mode only)
- ㉔ **RETURN button**  
When you're using the DVD Player's menu system, press this button to return to the preceding menu screen.
- ㉕ **DISPLAY button**  
Press this button while you're playing a disc to see contained various playback features and gives you the information about the disc you're playing.
- ㉖ **CLEAR button**  
Press to clear entered values and settings.

# Preparing the Remote Controller

## Inserting the Batteries

- 1 Remove the battery compartment cover by pressing the tab and lifting up the cover.

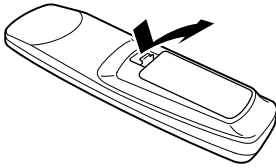

- 2 Insert the two batteries (size AAA/R3). Be sure to match the + and - ends of the batteries with the diagram inside the battery compartment.

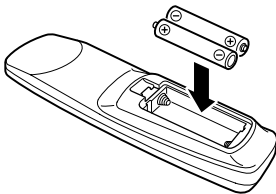

- 3 Replace the battery compartment cover.

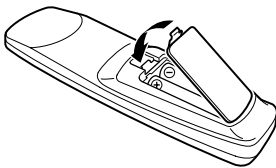

### Notes

- Do not mix new batteries with old batteries or different kinds of batteries.
- To avoid corrosion, remove the batteries if the remote controller is not to be used for a long time.
- Remove dead batteries immediately to avoid damage from corrosion. If the remote controller does not operate smoothly, replace both batteries at the same time.
- The life of the batteries supplied is about six months but this will vary depending on usage.

## Using the Remote Controller

Point the remote controller toward the remote control sensor.

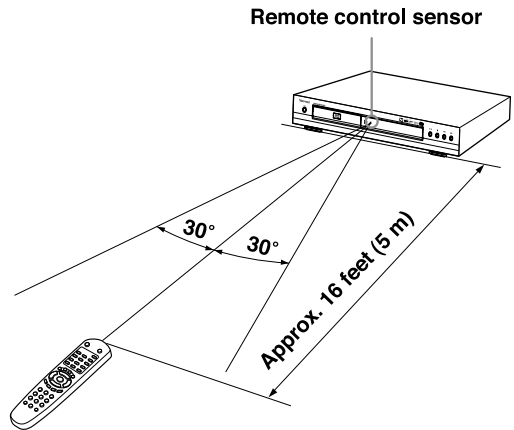

### Notes

- Place the unit away from strong light such as direct sunlight or inverted fluorescent light which can prevent proper operation of the remote controller.
- Using another remote controller of the same type in the same room or using the unit near equipment which uses infrared rays may cause operational interference.
- Do not put any object such as a book on the remote controller. The buttons of the remote controller may be pressed by mistake and drain the batteries.
- Make sure the audio rack doors do not have colored glass. Placing the unit behind such doors may prevent proper remote controller operation.
- If there is any obstacle between the remote controller and the remote control sensor, the remote controller will not operate.

# System Connections

To accommodate a wide range of home entertainment systems, this player features numerous connection types for both audio and video. Please refer to the instructions on this and the following pages to determine the best possible type of connections for your system.

## Before Making Any Connections

- Read the manuals supplied with your AV components.
- Don't connect the power cord until you've completed and double-checked all audio and video connections.

### Optical digital terminals

The optical digital terminals are provided with protection caps. Before you connect a cable to a terminal, remove the cap and keep it safely. If you disconnect the cable, put the cap back on the terminal.

### RCA AV connection color coding

RCA-type AV connections are usually color coded: red, white, and yellow.

Use red plugs to connect right-channel audio inputs and outputs (typically labeled "R"). Use white plugs to connect left-channel audio inputs and outputs (typically labeled "L"). And use yellow plugs to connect composite video inputs and outputs.

- Push plugs in all the way to make good connections (loose connections can cause noise or malfunctions).
- To prevent interference, keep audio and video cables away from power cords and speaker cables.

## AV Cables & Sockets

### Video

Cable	Socket	Description
		Component video separates the luminance (Y) and color difference signals (Pr/Cr, Pb/Cb), providing the best picture quality. (Some TV manufacturers label their component video sockets slightly differently.)
		S-Video separates the luminance and color signals and provides better picture quality than composite video.
		Composite video is commonly used on TVs, VCRs, and other video equipment. Use only dedicated composite video cables.

### Audio

Cable	Socket	Description
		Offers the best sound quality and allows you to enjoy surround sound (e.g., Dolby Digital, DTS). The audio quality is the same as for coaxial.
		Offers the best sound quality and allows you to enjoy surround sound (e.g., Dolby Digital, DTS). The audio quality is the same as for optical.
		This cable carries analog audio. It's the most common connection format for analog audio, and can be found on virtually all AV components.

# System Connections

## Connecting to a TV

This player has 3 kinds of video output jacks. Select one of the following connections.

- Video jack connection: Use the supplied audio/video Connection Cable to connect.
- S-Video jack connection: For higher quality video than video jack connection.
- Component jack connection: For higher quality video than S-video jack connection.

### Note

The DVD Player can output NTSC or PAL format video depending on the setting on page 30. Make sure your TV supports the disc's video format.

## ■ If your TV has component input connector (necessary for progressive function)

### Video connection

Using a component video cable (sold separately), connect the VIDEO OUTPUT COMPONENT jacks to the corresponding component video input jacks on the TV.

Actual labels for component video inputs may vary depending on the TV manufacturer. (e.g., Y, PB, PR or Y, CB, CR)

In some TVs or monitors, the color levels of the playback picture may be reduced slightly or the tint may change. In such a case, adjust the TV or monitor for optimum performance.

### Note

This connection is necessary to use progressive function. To view Progressive scan video, you need a TV with Progressive scan capability. Please check your TV's manual.

### Audio connection

Using the supplied audio/video cable, make audio connections from the ANALOG OUTPUT L and R jacks to the corresponding audio input jacks on the TV.

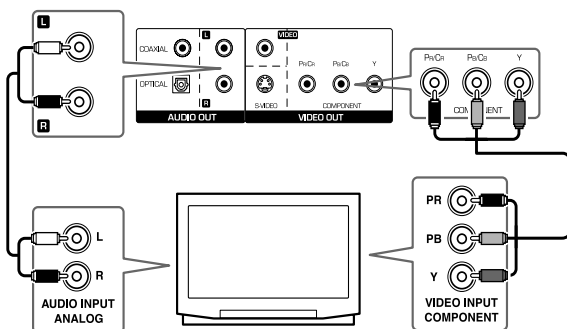

## ■ If your TV has S-Video input connector

### Video connection

Using an S-video cable (sold separately), Connect the VIDEO OUTPUT S VIDEO jack to the corresponding S-video input jack on the TV.

### Audio connection

Using the supplied audio/video cable, make audio connections from the ANALOG OUTPUT L and R jacks to the corresponding audio input jacks on the TV.

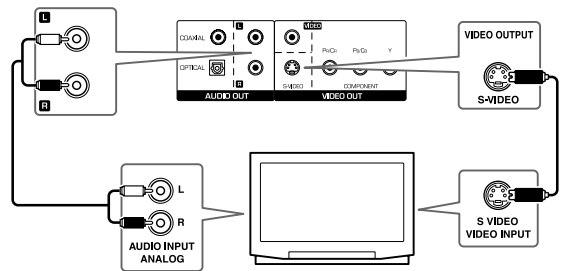

## ■ If your TV has video input connector

### Video connection

Using the supplied audio/video cable, make video connection from the VIDEO OUTPUT VIDEO jack to the corresponding video input jack on the TV.

### Audio connection

Using the supplied audio/video cable, make audio connections from the ANALOG OUTPUT L and R jacks to the corresponding audio input jacks on the TV.

### Note

Be sure to match the colors of the plugs on the cable with the corresponding jacks on the DVD Player and the TV: yellow for video, red for R (right) audio and white for L (left) audio.

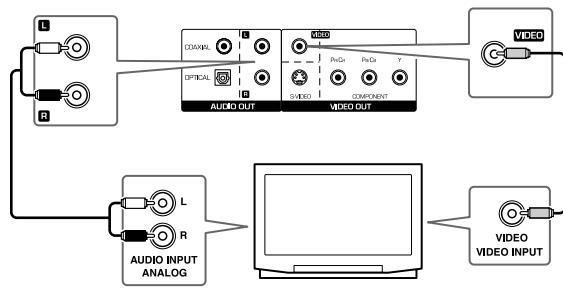

# System Connections

## Connecting to A/V Amplifier or Receiver (To enjoy the sound advantage of the DVD Player)

Although you can reproduce the DVD Player's sound from the TV speakers with the connections on pages 14, connecting with an amplifier provides you high quality dynamic sounds.

To reproduce Dolby Digital surround and DTS surround sound, you need to connect to an amplifier with a Dolby Digital and DTS decoder respectively.

### ■ Digital connection

If your amplifier has a digital input jack, be sure to connect it to either DIGITAL OUTPUT OPTICAL or COAXIAL jack on the DVD player.

#### Note

In the Digital Out setting, you can select whether the VD-4500 will output the PCM signal only or the PCM and other signals, or no digital signals at all.

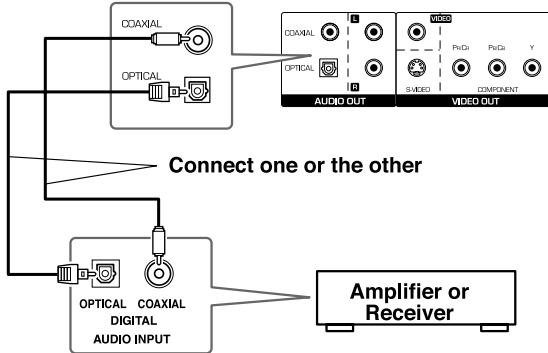

### ■ Analog connection

If your amplifier has no digital audio input, make the analog connection.

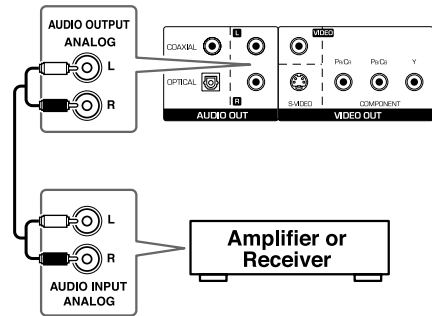



# Turning on

## Connecting the POWER

The VD-4500 is shipped with the main power (**POWER**) switch in the on position (— ON). When the power cord is plugged in for the first time, the VD-4500 will automatically enter the standby mode and the **STANDBY** indicator will light (same condition after step 2 below).

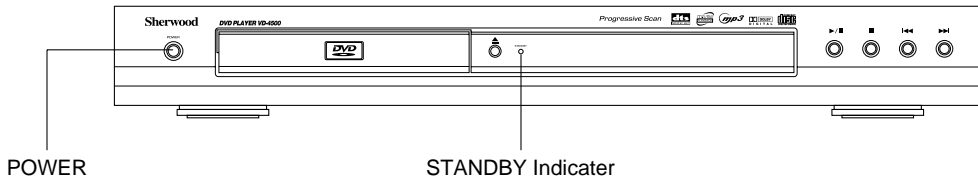

### Notes

- Make sure that all appropriate connections have been completed as described on page 13 to 15.
- Turning on the DVD Player may cause a momentary power surge, which might interfere with other electrical equipment such as computers. To prevent interference, use a wall outlet on a different circuit.

1 **Plug the power cord into the power outlet on the wall.**

2 **Press POWER to switch on the main power.**



The DVD Player enters standby mode.  
The **STANDBY** indicator lights up.

3 **Press PLAY/PAUSE ►/II on the DVD Player or Press POWER ON on the remote controller.**

The DVD Player turns on and the **STANDBY** indicator turns off. It takes several seconds to read the disc in the disc tray.

- To put the DVD Player in the standby mode, press **STANDBY**  on the remote controller.

### Notes

- You can turn on the DVD Player by pressing **OPEN/CLOSE**  or **PLAY/PAUSE** .
- Setting the **STANDBY**  button to standby does not shut off the power completely.
- While the **STANDBY** indicator lights up, the DVD Player can receive signals from the remote controller.  
However, if you press **POWER** on the DVD Player to switch off the main power, the remote controller cannot be used to turn on the DVD Player.
- To switch off the main power, press **POWER** again.

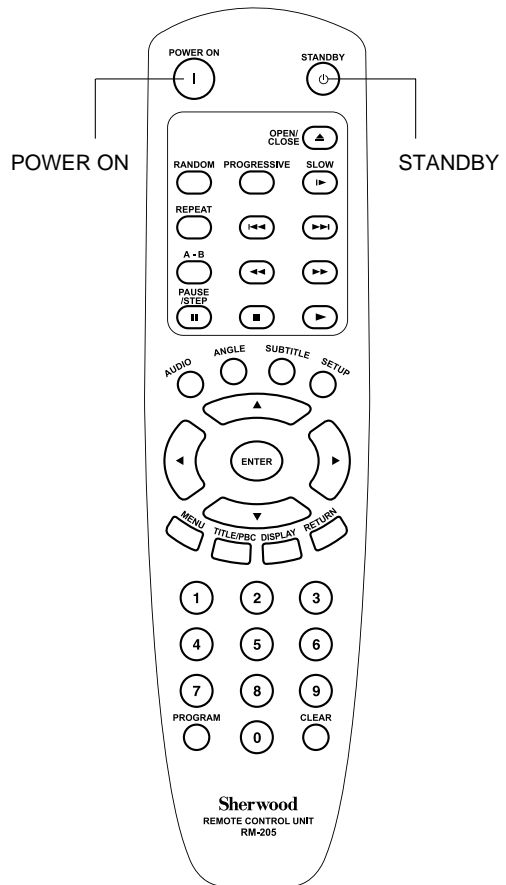



# Basic Playback

## Before playing

- Turn on the TV and set the TV to the DVD Player's input.
- Turn on the audio system and set it to the DVD Player's input, if an audio system is connected to the DVD Player.
- DVD-Video, Video CD, CD, MP3, WMA, JPEG can be played with the DVD Player (see "Notes on Discs" on page 6 and 8). Do not play anything else.

## About the marks in the pages related to disc operation

 means the function or title is related to DVD-Video operation.

 means the function or title is related to Video CD operation.

 means the function or title is related to audio CD operation.

 means the function or title is related to MP3/WMA sound operation.

Both MP3 and WMA are referred to as MP3 in the following pages.

 means the function or title is related to JPEG image operation.

## Warning

If the DVD Player is connected to the TV or amplifier through the analog audio jacks, do not play DTS-encoded discs. Excessive noise may be output from the analog stereo jacks, which may damage the connected equipment. To reproduce DTS surround sounds, digital connection to an amplifier with a DTS decoder is needed.

## Starting Playback

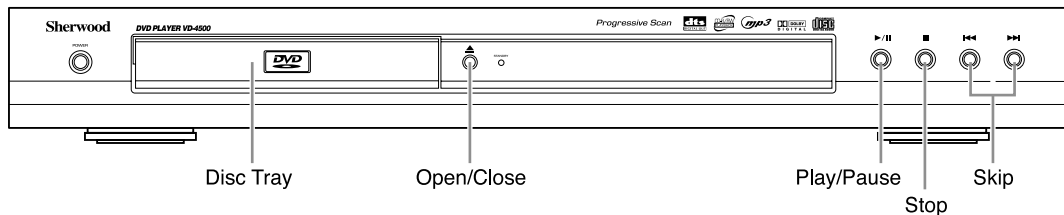

### 1 Press Open/Close ▲.

The disc tray opens. If the DVD Player is in standby mode when the **Open/Close ▲** button is pressed, the DVD Player turns on and the disc tray opens. In this case, it takes several seconds until the disc tray opens.

### 2 Place a disc on the disc tray.

Put the disc in the tray with the label side facing up. There are two different disc sizes. Place the disc in the correct guide on the disc tray.

### 3 Press Play/Pause ►/||.

The disc tray closes and playback starts. The appropriate disc indicator lights.

The disc indicator does not light up for CDs that contain JPEG images. For the other information that appears in the display, see page 10.

If the DVD Player is in standby mode when **Play/Pause ►/||** is pressed, the DVD Player turns on and playback starts. In this case, it takes several seconds until playback starts.

## Tip to obtain a higher quality picture

Occasionally, some picture noise not usually visible during a normal broadcast may appear on the TV screen while playing a DVD-Video because the high resolution pictures on these discs include a lot of information. While the amount of noise depends on the TV you use, you should generally adjust the TV to reduce sharpness when viewing DVD-Videos.

## ■ To stop playback

### Press Stop ■.

When you press **Play/Pause ►/||** to restart playback, playback starts from the location where you stopped playback because the location index is stored in memory. For MP3/WMA/JPEG playback, see page 19.

### Notes

- The location where playback resumes may vary depending on the disc or the scene where you stopped.
- Press **Stop ■** again after stopping playback to clear the location index memory, then press **Play/Pause ►/||** to start playback.

## ■ To remove the disc

### Press Open/Close ▲ to open the disc tray.

Remove the disc after the disc tray opens completely. After removing the disc, be sure to press the button again to close the tray.

### CAUTION

Keep your fingers well clear of the disc tray as it is closing. Neglecting to do so may cause serious personal injury.

# Basic Playback

## Various Playback

DVD VCD CD MP3

### ■ To play in fast reverse (◀◀) or fast forward (▶▶)

Press **SEARCH** ◀◀/▶▶ during playback.

Each press of the same button changes the playback speed.

To resume normal playback, press **PLAY** ▶.

#### Note

The DVD Player mutes sounds and omits subtitles during fast reverse and fast forward.

DVD VCD CD MP3 JPEG

### ■ To skip chapters or tracks

Press **SKIP** ◀◀/▶▶ during playback.

The chapter (track or file) in the direction of the button pressed is skipped, and the selected chapter (track or file) will be played from the beginning. When **SKIP** ◀◀ is pressed once during playback, the chapter (track or file) being played will be played from the beginning.

DVD VCD CD MP3

### ■ To pause playback (still mode)

Press **PAUSE/STEP** || during playback.

To start playback, press **PLAY** ▶.

DVD VCD

### ■ Playing frame by frame

Press **PAUSE/STEP** || repeatedly during playback.

Each time you press the button the picture advances one frame.

To resume normal playback, press **PLAY** ▶.

#### Note

Video CDs cannot be played frame by frame reverse.

DVD VCD

### ■ To play in slow-motion

Press **SLOW** |▶ during playback.

Each press of the same button changes the playback speed.

To resume normal playback, press **PLAY** ▶.

#### Note

Video CDs cannot be played in slow-motion reverse.

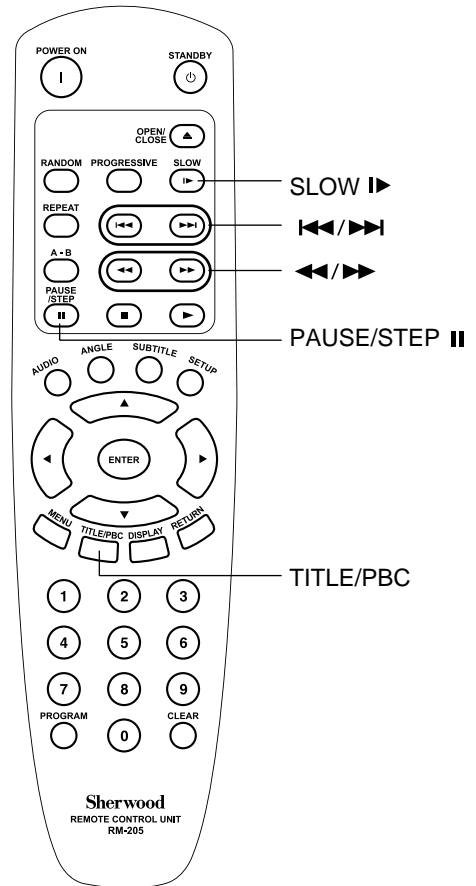

VCD

### ■ PBC function for Video CDs

When playing a Video CD equipped with PBC function, DVD Player will automatically enter the PBC on mode.

**Press the TITLE/PBC button to turn PBC off.**

Press again to turn on.

#### Notes

- The sound is muted during slow-motion, still mode, and frame by frame playback.
- The playback speed may differ depending on the disc.
- Do not move the DVD Player during playback. Doing so may damage the disc.
- Use **OPEN/CLOSE** ▲ on the DVD Player to open and close the disc tray. Do not touch the disc tray while it is moving. Doing so may cause the DVD Player to malfunction.
- Do not press down on the disc tray or put any objects other than playable discs on the disc tray. Doing so may cause the DVD Player to malfunction.

# Basic Playback

The VD-4500 can play back MP3/WMA/JPEG files recorded on CD-R or CD-RW.

## Playing Back MP3/WMA/JPEG

- A certain amount of time is required for the player to confirm the media on which MP3/WMA/JPEG files have been recorded before playback will commence.

### ■ Playback

Press **PLAY** ►

**For JPEG discs:**

Slide show starts. Press **STOP** ■ to display the NAVI screen. Thumbnails may be displayed depending on the type of disc that is set.

## Rotating a Picture (JPEG Files Only)

It is possible to rotating a picture.

During JPEG file playback, press ▲ / ▼ / ◀ / ▶ on the remote controller.

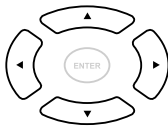

Switching as shown below is done when the cursor buttons are pressed.

- ▶ button: 90° rotation in clockwise direction
- ◀ button: 90° rotation in counterclockwise direction
- ▲ button: Vertical mirror image
- ▼ button: Horizontal mirror image

## Various Play Modes

- 1 During stop mode, press **REPEAT** on the remote controller to select the play mode.



Each press switches the play mode.

### → FOLDER

Playback the folder that is selected.

### REPEAT ONE

Repeat the file that is selected.

### FOLDER REPEAT

Repeat the folder that is selected.

### DISC

Playback all files on the disc.

### DISC REPEAT

Repeat all files on the disc.

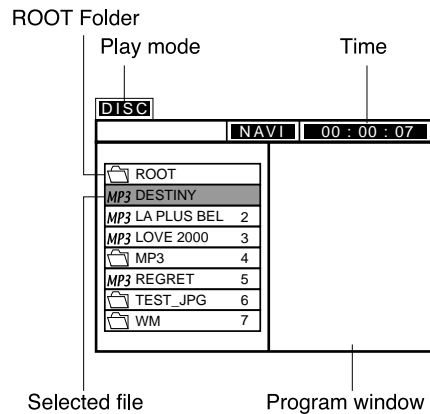

- 2 Press ▲ / ▼ on the remote controller to select the desired file or folder, then press **ENTER** to start playback.

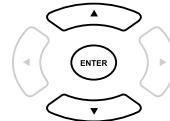

When JPEG files are displayed, the display is switched automatically from one file to the next.

The switching speed differs according to the file size.

- 3 To stop playback, press **STOP** ■.



### Note

When the play mode is FOLDER, FOLDER REPEAT, skipping to outside the folder being played by using ◀◀/▶▶ buttons is not possible.

# Other Operations

The following operations can be performed directly from the remote controller.

## Locating a Specific Title/Chapter/Track/File by Entering the Numbers

DVD VCD CD

- 1 Press the number buttons to select the desired title No. or track No.

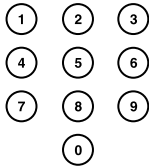

(Example) To select track No. 23: 2 3

**When playing a DVD:** Select the desired title number in advance.

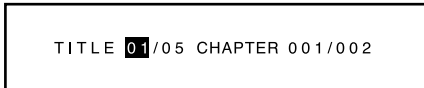

To select a chapter, press ►, then use the number buttons to select the desired chapter.

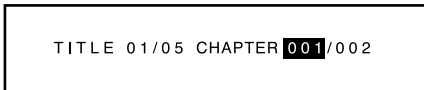

- 2 Press ENTER.



### Note

To use this function, turn PBC off by pressing TITLE/PBC first.

MP3 JPEG

Press the number buttons on the remote controller to enter the desired file number or folder number.

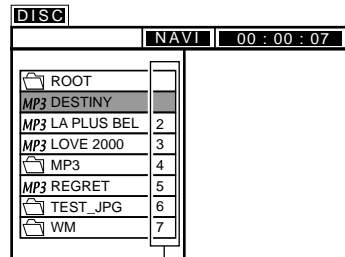
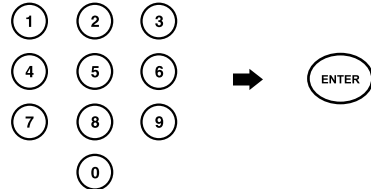

File numbers and folder numbers

(Example)

To select file No. 23: 2 3

- When a folder is selected, the contents of the selected folder will be displayed.
- When a file is selected, playback of the selected file will start.

### Note

For selection of a number, refer to the file numbers on the NAVI screen.

The file numbers shown on the display of the main unit differ from the file numbers entered directly with the number buttons, as the numbers for each folder are displayed.

# Other Operations



## Video CD/CD Program Playback

You can listen to the desired tracks of the current CD or VCD in any desired order.

### ■ Program edit

- 1 During stop mode, press **PROGRAM**.



Program edit screen appears.

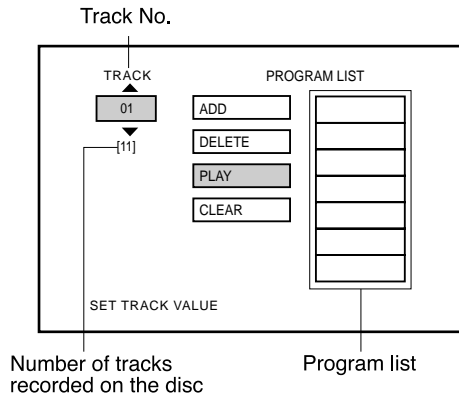

- 2 Select specific track by pressing **▲ / ▼**.

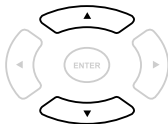

- 3 Select **“ADD”** icon on the screen to register selected value onto **PROGRAM LIST**, then press the **ENTER** button.

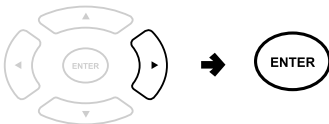

- 4 You can select maximum 21 values by repeating step 2 - 3.

- 5 Select **“PLAY”** icon on the screen. then press **ENTER** to start program play.

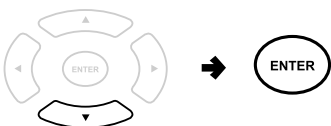

- The unit stops when the **STOP ■** button is pressed. To restart program playback, press the **PROGRAM** button, display the program screen, select the **“PLAY”** icon, and press the **ENTER** button.

### ■ Insert track

During stop mode, press the **PROGRAM** button on the remote controller.

The program edit screen appears.

- 1 Select specific track to insert by pressing **▲ / ▼**.

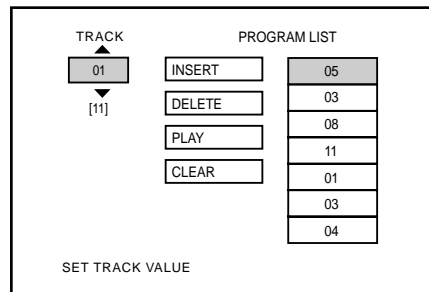
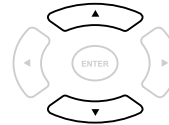

- 2 Move the cursor with **▶** to the **“PROGRAM LIST”** and select the column to be added with **▲ / ▼**. (The color of the column where the cursor is located will change.)

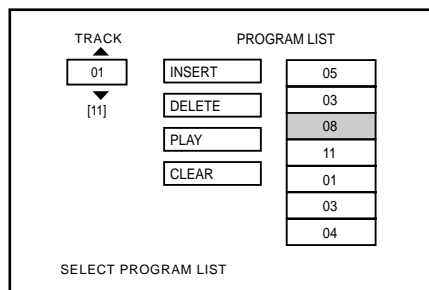
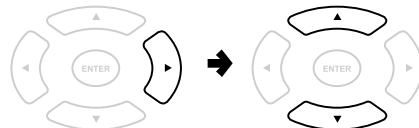

# Other Operations

- 3 Press **PLAY** ◀, use ▲ / ▼ to move the cursors to the “**INSERT**” icon, and press **ENTER**.

The new track will be inserted after (below) the selected column.

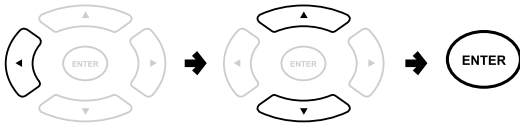

TRACK		PROGRAM LIST
01	INSERT	05
▼ [11]	DELETE	03
	PLAY	08
	CLEAR	01
		11
		01
		03

INSERT ITEM TO THE LIST

## Delete program

During stop mode, press the **PROGRAM** button on the remote controller

- 1 Move the cursor with ▶ to the “**PROGRAM LIST**” and select the column to be deleted with ▲ / ▼. (The color of the column where the cursor is located will change.)

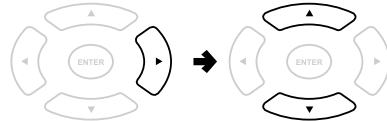

TRACK		PROGRAM LIST
01	INSERT	05
▼ [11]	DELETE	03
	PLAY	08
	CLEAR	01
		11
		01
		03

SELECT PROGRAM LIST

- 2 Press **PLAY** ◀, use ▲ / ▼ to move the cursor to the “**DELETE**” icon, and press **ENTER**.

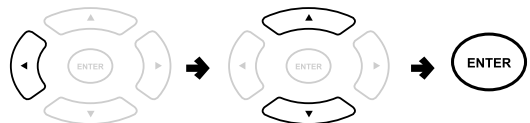

TRACK		PROGRAM LIST
01	INSERT	05
▼ [11]	DELETE	03
	PLAY	08
	CLEAR	11
		01
		03
		04

1 TRACK DELETE

The selected value is deleted.

### Note

To use this functions turn PBC off by pressing **TITLE/PBC** first.

## Clear program List

In following case, Program list would be cleared.

1. When you open and close tray.
2. When you turn power off and on.
3. Press the **CLEAR** button during display of the Program edit screen.

# Other Operations

DVD VCD

## MP3/WMA/JPEG Program Playback

You can listen to the desired files of the current MP3/WMA/JPEG disc in any desired order.

### ■ Program edit

- 1 During stop mode, press **PROGRAM**.



- 2 Press **▲ / ▼** to select the file, then press **ENTER**.

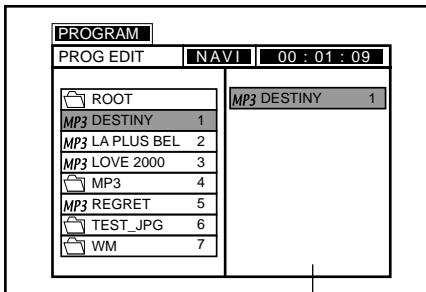
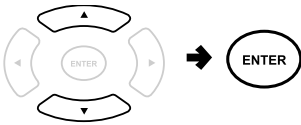

Program Window

- The selected file goes to program window.
- You can select a maximum of about 100 files by repeating step 2. However, note that the maximum number of programmable files depending on the number of files and folders in the MP3/WMA/JPEG disc and on the total number of characters used in the file and folder names.

### Delete Program

During program edit mode, press **▲ / ▼** in the program window, select the file to be deleted, and press **CLEAR**.

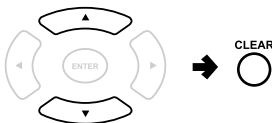

- After the **STOP** button has been pressed and the program has been confirmed, the program no longer can be changed.

- 3 Press **STOP** and confirm the program.



PROG END is displayed.

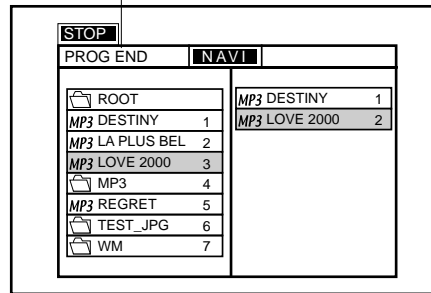

- After the **STOP** button has been pressed and the program has been confirmed, the program no longer can be changed.

- 4 Press **PLAY** to start program playback.

- Confirm that the cursor is at the position of a "file" and press the **PLAY** button. Playback is not possible when the cursor is at the position of a "folder."

### Tip

All programs can be canceled by pressing the **PROGRAM** button during stop in program mode. All programs also can be canceled by opening the disc tray.

### Note

Program repeat play is not available with MP3/WMA/JPEG discs.



# Other Operations

VCD CD MP3

## Random Play

The chapters or tracks of the disc are played in random order.

**Press RANDOM while stopped.**

RANDOM indicator lights up.

### ■ To cancel random play

Press **RANDOM** while stopped so that RANDOM indicator goes off.

Each time you press **RANDOM**, random play will be on and off.

#### Notes

- You cannot play DVDs in random order.
- When playing a PBC-compatible Video CD with PBC on, you cannot use this function. To use random play, turn PBC off by pressing **TOP MENU**, then press **RANDOM**.
- In Random play, Backward skip is not possible. You can only skip forward.

DVD VCD CD

## Repeat Play

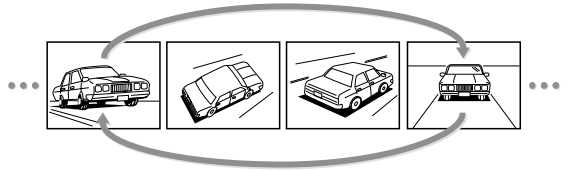

Desired disc or title can be played back repeatedly.

**Press REPEAT repeatedly.**

Each time you press **REPEAT**, the repeat option changes.

### At the time of DVD playback

CHAPTER REPEAT ON	Repeats the current chapter.
↓	
TITLE REPEAT ON	Repeats the current title.
↓	
REPEAT OFF	Resumes normal playback.

### At the time of Video CD/CD playback

REPEAT ONE	Repeats the current track.
↓	
REPEAT-ALL	Repeats the entire disc.
↓	
REPEAT OFF	Resumes normal playback.

#### Note

For DVD, the **REPEAT** button functions only for playback.

### ■ To cancel repeat play

Press **REPEAT** so that REPEAT indicator goes off.

#### Notes

- When playing a PBC-compatible Video CD with PBC on, you cannot use this function. To use repeat play, turn PBC off by pressing **TITLE/PBC** first.
- With some DVDs, repeat playback may not be possible.
- For playing MP3, WMA or JPEG files repeatedly, see page 19.

### ■ To repeat program play

During program playback, press the **REPEAT** button on the remote controller.

Each press the button switches the mode.

→	REPEAT ONE
→	REPEAT ALL
→	REPEAT OFF

# Other Operations

DVD VCD CD

## A-B Repeat Play

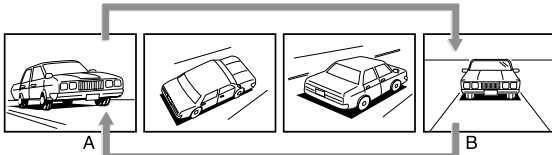

The A-B repeat function lets you mark a segment to repeat between the beginning "A" and the end "B" of the segment you want to replay.

- 1 Press A-B when you want to choose a scene(sound) as the beginning point.



- 2 Press A-B again to choose a scene (sound) as the end point.

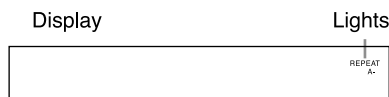

The DVD Player automatically returns to point A and starts repeat playback of the selected segment (A-B).

### ■ To cancel A-B Repeat play

Press A-B so that REPEAT and A-B indicators go off to display "A TO B CANCELLED".

#### Note

Repeat A-B will not function for segments under 3 seconds.

DVD VCD CD

## Viewing Information

You can view information about a disc on the TV screen.

Press **DISPLAY** during playback.



Each time you press **DISPLAY**, the on-screen display on the TV screen changes as follows.

#### DVDs:

- **Title number and chapter number display.**  
Example: TITLE 01/03 CHAPTER 07/20  
00:10:12 (elapsed time of the title)
- ↓
- TITLE REMAIN**  
Remaining time of the title being played.
- ↓
- CHAPTER ELAPSED**  
Elapsed time of the chapter being played.
- ↓
- CHAPTER REMAIN**  
Remaining time of the chapter being played.
- ↓
- OFF**

#### CD/VCDs:

- **SINGLE ELAPSED**  
Elapsed time of the track being played.
- ↓
- SINGLE REMAIN**  
Remaining time of the track being played.
- ↓
- TOTAL ELAPSED\***  
Elapsed time of the disc being played.
- ↓
- TOTAL REMAIN\***  
Remaining time of the disc being played.
- ↓
- OFF**

Items marked by \* are not displayed in PBC mode for VCDs.

#### Notes

- Some DVD videos may not display the chapter number or elapsed time.
- The displayed time information cannot be changed in pause mode.
- The displayed information cannot be changed while a menu or the top menu is displayed.

# DVD settings

The following operations can be performed directly from the remote controller.

- Selecting a Playback Audio Setting
- Changing the Subtitle Language
- Changing the Camera Angle

DVD

## Selecting a Playback Audio Setting

Press **AUDIO** on the remote controller repeatedly during playback to select the audio language.



### Notes

- Before changing the setting, read through the explanation on "Digital Audio Out" on page 29 and carefully select the setting.
- Depending on the disc, it may be necessary to select the audio sound track using the DVD menu. When this is the case, press MENU to open the DVD menu and select the appropriate sound track as indicated on the DVD menu screen.
- When you turn on the DVD Player or replace a disc, the DVD Player returns to the automatic setting in the setting menu (see page 30).
- Depending on the disc, pressing AUDIO may display a disc menu. For more details, refer to the instruction notes on the disc.

DVD

## Changing the Subtitle Language

Press **SUBTITLE** on the remote controller repeatedly during playback to select the subtitle language.



### Notes

- When you turn on the DVD Player or replace a disc, the DVD Player returns to the automatic setting in the setting menu (see page 30).
- During some scenes, the subtitles may not appear immediately after you change the subtitle setting.
- Some DVD-Video are set to display subtitles automatically, and you cannot turn them off even if you set the subtitle function to off.
- Depending on the disc, pressing **SUBTITLE** may display a disc menu. For more details, refer to the instruction notes on the disc.

DVD

## Changing the Camera Angle

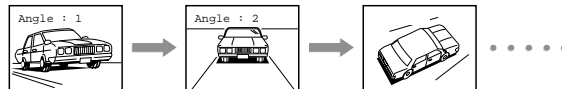

If the scene was recorded from multiple angles, you can easily change the camera angle of the scene you are watching.

Press **ANGLE** on the remote controller repeatedly during playback to select camera angle.



# Customizing the Function Settings

## Progressive Setting

When component video connection is used to connect this player and TV is compatible with progressive, you can enjoy the progressive video image.

- 1 Press **PROGRESSIVE**.



- To restore the Interlace mode, press **PROGRESSIVE**.

### Note

- The PROGRESSIVE function cannot be enabled when the disc containing MP3, WMA or JPEG format data files is inserted into the VD-4500.
- When your TV is not compatible with progressive mode, the picture may be distorted.

When you insert a DVD Video, Video CD, or audio CD, the various functions of the DVD Player will be set (reset) according to the SETUP MENU.

You can customize this setting menu according to your preference.

## Setting Steps

- 1 Press **SETUP** during stop mode.



The SETUP MENU appears.

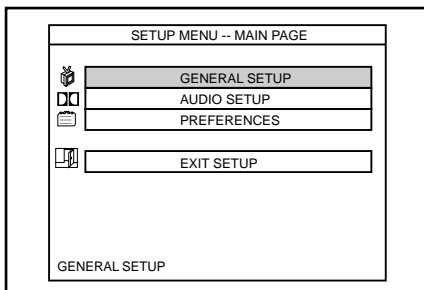

- 2 Press **▲/▼** to select a category, then press **ENTER**.

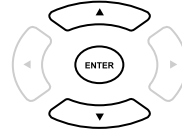

Remove the disc to customize the PREFERENCES settings.



- 3 Press **▲/▼** to select the item, then press **▶**.

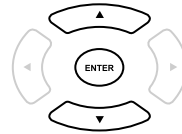

- 4 Press **▲/▼** to select the setting, then press **ENTER**.

To move the cursor to the item column, press **◀**.

- 5 Further steps may be needed depending on the item or setting. Follow the steps described in the explanation of each item starting from page 28.

# Customizing the Function Settings

## To return to the MAIN PAGE

Press ▲/▼/◀/▶ to select the main page, then press ENTER or press RETURN.

## To clear the setting menu

Press ▲/▼, then select "EXIT SETUP" or press SETUP.

## Note

When a TV screen is not displayed, the "TV type" setting may not be suitable for your TV .

## General Setup

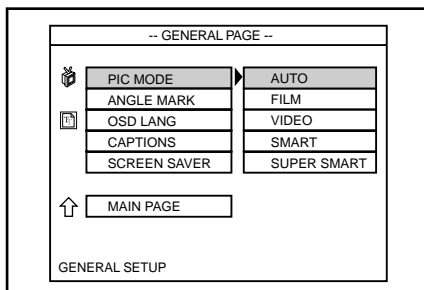

### ■ PIC MODE

This adjusts the screen quality according to the material being played back.

- **AUTO**  
The picture quality is adjusted automatically.
- **FILM**  
Choose this setting to reproduce the picture quality of film material.
- **VIDEO**  
Choose this setting to reproduce the picture quality of video material.
- **SMART**  
Choose this setting to reproduce progressive and interlaced materials with limited motion.
- **SUPERSMART**  
Choose this setting to reproduce progressive and interlaced materials with motion (motion adaptive deinterlacing).

### ■ ANGLE MARK

- **ON**  
When a picture recorded in different angles is played back, 𐄂 is displayed on the screen.
- **OFF**  
𐄂 is not displayed on the screen. ( 𐄂 is displayed when the camera angle is changed.)

### ■ OSD LANG

Select the On-Screen Display language.

#### American model:

- ENGLISH
- FRENCH
- PORTUGUESE
- SPANISH

#### Other models:

- ENGLISH
- FRENCH
- GERMAN
- ITALIAN
- PORTUGUESE
- SPANISH

### ■ CAPTIONS (NTSC only)

Some DVD videos contain special subtitles, an enhancement of closed captions for hearing impaired persons. The DVD Player automatically displays these special subtitles by setting this item to [ON].

- **ON**  
The extended subtitles are displayed automatically.
- **OFF**  
The extended subtitles are not displayed.

### ■ SCREEN SAVER (Screen Saver)

If you pause a picture for a long time, the screen saver automatically operates by setting this item to [ON].

- **ON**  
The screen saver is enabled.
- **OFF**  
The screen saver is disabled.

# Customizing the Function Settings

## Audio Setup

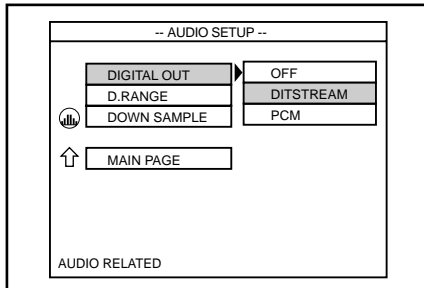

### ■ DIGITAL OUT

OFF ⇄ BITSTREAM ⇄ PCM

Selects whether the digital output of the VD-4500 will output the PCM signal only, the PCM and other signals, or no digital signals, at all.

### ■ D. RANGE

ON ⇄ OFF

When the setting is [ON], soft sounds such as dialog can be heard more clearly without making loud sounds even louder.

When the setting is set to [OFF], there is no effect on the audio source.

#### Notes

- Dynamic Range is only effective with Dolby Digital audio sources.
- The level may differ depending on the DVD.
- The effect depends on your speakers and AV amplifier settings.

### ■ DOWN SAMPLE

ON (48 k) ⇄ OFF (96 k)

If your AV amplifier (or other connected component) is compatible with high sampling rates (96 kHz), set this to [OFF(96K)], otherwise set it to [ON(48K)] (96 kHz audio is converted to a more compatible 48 kHz). Check the manual that came with the other component if you are unsure whether it is 96 kHz compatible.

#### Note

- On DVDs that contain copy protection, the 96 kHz signal may only be output from the analog audio jacks.
- The DTS 96/24kHz source will be enforced to be output in 48 kHz.

## Preferences

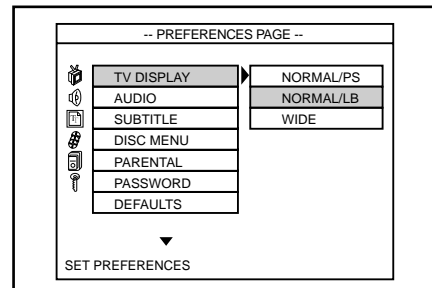

### ■ TV DISPLAY

#### • NORMAL/PS (Pan Scan)

Select when a 4:3 TV is connected. Displays pictures cropped to fill your TV screen. Either or both sides of the picture are cut off. This function is only available when using a disc that supports Pan Scan.



#### • NORMAL/LB (Letter Box)

Select when a 4:3 TV is connected. Displays wide screen images with masking bars above and below the picture.



#### • WIDE

Select when a 16:9 wide TV is connected.



#### Notes

- The displayable picture size is preset on each DVD video. Therefore, the playback picture of some DVD videos may not conform to the picture size you select.
- When you play a DVD video recorded in the 4:3 picture size only, the playback picture always appears in the 4:3 picture size regardless of the TV shape setting.
- If you select [WIDE] and you own a 4:3 TV set, the DVD playback picture will be horizontally distorted during playback. Images will appear to be horizontally compressed. Make sure the TV shape conforms to the actual TV in use.

# Customizing the Function Settings

## ■ AUDIO

Select the audio language.

### American model:

- ENGLISH
- FRENCH
- SPANISH
- CHINESE
- JAPANESE
- OTHERS

### Other models:

- ENGLISH
- FRENCH
- SPANISH
- CHINESE
- JAPANESE
- GERMAN
- ITALIAN
- OTHERS

### To select other language

1. Select [OTHERS] and press the **ENTER** button.
2. Input a 4-digit code by pressing the number buttons on the remote controller (DVD Menu Language Code List, page 35).
3. Press the **ENTER** button.

### Note

Depending on the disc, a language recorded on the disc may be given priority and selected automatically when the disc is loaded regardless of the setting.

## ■ SUBTITLE

Select the subtitle language.

### American model:

- ENGLISH
- FRENCH
- SPANISH
- CHINESE
- JAPANESE
- OTHERS
- OFF

### Other models:

- ENGLISH
- FRENCH
- SPANISH
- CHINESE
- JAPANESE
- GERMAN
- ITALIAN
- OTHERS
- OFF

To disable subtitles.

### To select other language

1. Select [OTHERS] and press the **ENTER** button.
2. Input a 4-digit code by pressing the number buttons on the remote controller (DVD Menu Language Code List, page 35).
3. Press the **ENTER** button.

### Notes

- Some DVD-Video may be set to display subtitles in a different language than you selected. A prior subtitle language may be programmed on the disc.
- Some DVD-Video allow you to change subtitle selections only via the disc menu. If this is the case, press **MENU** and choose the appropriate subtitle language from the selection on the disc menu.

## ■ DISC MENU

Select the disc menu language.

### American model:

- ENGLISH
- FRENCH
- SPANISH
- CHINESE
- JAPANESE
- OTHERS

### Other models:

- ENGLISH
- FRENCH
- SPANISH
- CHINESE
- JAPANESE
- GERMAN
- ITALIAN
- OTHERS

### To select other language

1. Select [OTHERS] and press the **ENTER** button.
2. Input a 4-digit code by pressing the number buttons on the remote controller (DVD Menu Language Code List, page 35).
3. Press the **ENTER** button.

### Note

Some DVD Video may not include your pre-selected language. In this case, the DVD player automatically displays disc menus consistent with the disc's initial language setting.

# Customizing the Function Settings

## ■ PARENTAL

DVD videos equipped with the parental lock function are rated according to their content. The content allowed by a parental lock level and the way a DVD video can be controlled may vary from disc to disc. For example, some discs allow you to edit out violent scenes unsuitable for children and replace them with more suitable scenes, or lock out playback of the disc altogether.

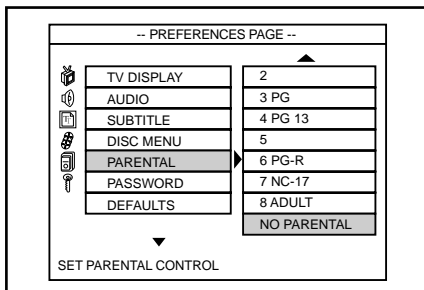

Change the Parental Level according to the settings printed on the DVD disc jacket or accompanying documentation. If you do not want to use Parental Level, select [NO PARENTAL].

### To change the parental lock level

1. Select the parental lock level, then press ENTER.
2. Press the number buttons to enter 4-digit number, then press ENTER. (When you enter a wrong password, press RETURN to return to the main page.)

### Note

DVD videos may or may not respond to the parental lock settings.

This is not a defect in the DVD player. Make sure this function works with your DVD videos.

## ■ PASSWORD

### • CHANGE

The password for PARENTAL is changed.

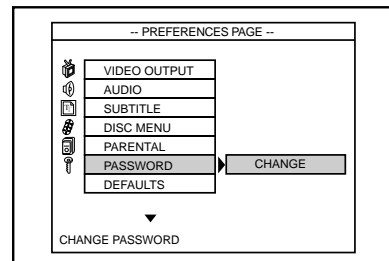

### To change the password

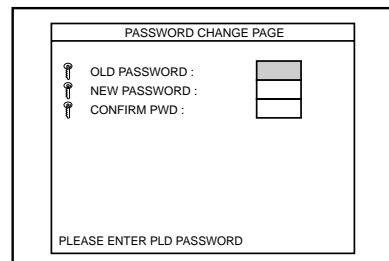

1. Press the number buttons to enter old password, then press **ENTER**.
2. Press the number buttons to create a new 4-digit password, then press **ENTER**.
3. Press the number buttons to enter the new password, then press ENTER.

### Notes

- The password is set to "0000" by initial setting.
- Be sure not to forget your password.
- You cannot change the password without the current password.

## ■ DEFAULTS

### • RESET

Resets all settings other than PASSWORD to the factory settings.



# Troubleshooting

Check the following guide for the possible cause of a problem before contacting service. Refer also to the respective instruction manuals of the connected components and TV.

## DVD Player

Symptoms	Causes	Remedies
The DVD Player doesn't switch on.	<ul style="list-style-type: none"> <li>The power cord is disconnected.</li> <li>The main power is set to OFF.</li> <li>There is external noise in the computer circuits of the DVD Player.</li> <li>The AC fuse is blown.</li> </ul>	<ul style="list-style-type: none"> <li>Check the connection of the power cord.</li> <li>Turn on the main power.</li> <li>Switch off the main power, then switch it on again. If not recovered, disconnect the power cord, then connect it again.</li> </ul>
The DVD Player doesn't start playback.	<ul style="list-style-type: none"> <li>No disc is inserted.</li> <li>The region number of the disc does not match that of the DVD Player.</li> <li>An unplayable disc is inserted.</li> <li>The disc is placed upside down.</li> <li>The disc is not placed within the disc tray guide.</li> <li>The disc is dirty.</li> <li>The parental lock function is activated.</li> </ul>	<ul style="list-style-type: none"> <li>Open the disc-tray and insert a disc.</li> <li>See Regional Restriction Codes (Region Number) on the rear panel.</li> <li>Check the playable discs.</li> <li>Place the disc with the playback side down.</li> <li>Place the disc within the proper guide on the disc tray.</li> <li>Eject the disc and clean it.</li> <li>Deactivate the parental lock function or change the parental lock level.</li> </ul>
Brightness is unstable or noise is visible on the playback picture.	<ul style="list-style-type: none"> <li>Copy protection is activated.</li> <li>The TV is not compatible with progressive scan signal.</li> </ul>	<ul style="list-style-type: none"> <li>Connect the DVD Player directly to the TV. Avoid connecting the DVD Player to the TV through a VCR.</li> <li>Reset to the initial setting.</li> </ul>
The playback picture is occasionally distorted.	<ul style="list-style-type: none"> <li>The disc is dirty.</li> <li>It is in fast forward or fast reverse playback.</li> <li>The disc does not meet the standard.</li> </ul>	<ul style="list-style-type: none"> <li>Eject the disc and clean it.</li> <li>Sometimes a small amount of picture distortion may appear. This is not a malfunction.</li> <li>See "CD-R/RW Compatibility Information."</li> </ul>
Playback doesn't follow the course of the disc's programs.	<ul style="list-style-type: none"> <li>The DVD Player is in repeat playback mode, memory playback mode, or random playback mode, etc.</li> </ul>	<ul style="list-style-type: none"> <li>Resume normal playback.</li> </ul>
The picture from the DVD Player doesn't appear on the TV screen.	<ul style="list-style-type: none"> <li>The TV is not set to receive the output signals from the DVD Player.</li> <li>The DVD Player is not properly connected.</li> <li>While in the progressive mode, the signal will not be output from the composite and S-video terminals.</li> </ul>	<ul style="list-style-type: none"> <li>Set the TV to the DVD Player's input.</li> <li>Check the connections to the DVD Player.</li> <li>Press the PROGRESSIVE button to switch to the interlace mode, or connect the TV that supports the progressive format using the COMPONENT terminals.</li> </ul>
No sound or inaccurate sound is reproduced.	<ul style="list-style-type: none"> <li>A wrong sound signal conversion method (Digital Audio Out) is selected.</li> <li>The TV is not set to receive the output signals from the DVD Player.</li> <li>The DVD Player is not properly connected.</li> <li>The system is in fast-forward, rewind or slow-motion play mode.</li> <li>The disc does not meet the standard.</li> </ul>	<ul style="list-style-type: none"> <li>Check the current sound signal conversion method, and select the right setting for "Digital Audio Out."</li> <li>Set the TV to the DVD Player's input.</li> <li>Check the connections to the DVD Player.</li> <li>Resume normal playback.</li> <li>See "CD-R/RW Compatibility Information."</li> </ul>
The buttons on the remote controller and DVD Player do not operate.	<ul style="list-style-type: none"> <li>Power supply fluctuations or other abnormalities such as static electricity may interrupt correct operation.</li> </ul>	<ul style="list-style-type: none"> <li>Switch off the main power, then switch it on again. If not recovered, disconnect the power cord, then connect it again.</li> </ul>

# Troubleshooting

## Remote Controller

Symptoms	Causes	Remedies
The buttons on the DVD Player operate but the buttons on the remote controller do not operate.	<ul style="list-style-type: none"><li>• No batteries are inserted in the remote controller.</li><li>• The batteries are worn out.</li><li>• The remote controller is not pointed at the remote sensor of the DVD Player.</li><li>• The remote controller is too far from the DVD Player.</li></ul>	<ul style="list-style-type: none"><li>• Insert new batteries.</li><li>• Replace with new batteries.</li><li>• Point the remote controller at the remote sensor of the DVD Player.</li><li>• Operate the remote controller within 5 m (16 feet).</li></ul>

Because the unit contains a microcomputer to provide advanced functions, it may malfunction due to external noise or static electricity. If this happens, press the POWER switch on the unit and then press it again after about five seconds.

# Specifications

## DVD Player

Power supply	AC 120 V, 60 Hz (North America models) AC 220-240 V, 50/60 Hz (Other models)
Power consumption	16 W
Weight	6.6 lbs, 3.0 kg
External dimensions (W×H×D)	17-1/8" x 3-3/16" 11-1/8" 435×81.5×283 mm
Signal system	NTSC / PAL
Frequency response	Digital output 4 Hz to 22 kHz (48 kHz sampling) DVD linear sound 4 Hz to 44 kHz (96 kHz sampling)
Signal-to-noise ratio (digital output)	More than 90 dB
Audio dynamic range (digital output)	More than 90 dB
Harmonic distortion (digital output)	Less than 0.008 %
Wow and flutter	Below measurable level

## Outputs

Video output	1.0 V (p-p), 75 negative sync., pin jack
S-video output	(Y) 1.0 V (p-p), 75 negative sync., (C) 0.286 V (p-p), 75 Mini DIN 4-pin PAL: (C) 0.300 V (p-p)
Component video output	(Y) 1.0 V (p-p), 75 negative sync., (P <sub>B</sub> )/(P <sub>R</sub> ) 0.7 V (p-p), 75 pin jack
Audio output	Optical digital output -22.5 dBm, optical connector Coaxial digital output 0.5 V (p-p), 75 pin jack Analog output 2.0 V (rms), 100 pin jack (L, R)

Specifications and features are subject to change without notice.

# DVD Menu Language Code List

Code No.	Language
1027	Afar
1028	Abkhazian
1032	Afrikaans
1039	Amharic
1044	Arabic
1045	Assamese
1051	Aymara
1052	Azerbaijani
1053	Bashkir
1057	Byelorussian
1059	Bulgarian
1060	Bihari
1069	Bislama
1066	Bengali; Bangla
1067	Tibetan
1070	Breton
1079	Catalan
1093	Corsican
1097	Czech
1103	Welsh
1105	Danish
1109	German
1130	Bhutani
1142	Greek
1144	English
1145	Esperanto
1149	Spanish
1150	Estonian
1151	Basque
1157	Persian
1165	Finnish
1166	Fiji
1171	Faeroese
1174	French
1181	Frisian
1183	Irish
1186	Scots Gaelic
1194	Galician
1196	Guarani
1203	Gujarati
1209	Hausa
1217	Hindi
1226	Croatian
1229	Hungarian
1233	Armenian
1235	Interlingua

Code No.	Language
1239	Interlingue
1245	Inupiak
1248	Indonesian
1253	Icelandic
1254	Italian
1257	Hebrew
1261	Japanese
1269	Yiddish
1283	Javanese
1287	Georgian
1297	Kazakh
1298	Greenlandic
1299	Cambodian
1300	Kannada
1301	Korean
1305	Kashmiri
1307	Kurdish
1311	Kirghiz
1313	Latin
1326	Lingala
1327	Laothian
1332	Lithuanian
1334	“Latvian, Lettish”
1345	Malagasy
1347	Maori
1349	Macedonian
1350	Malayalam
1352	Mongolian
1353	Moldavian
1356	Marathi
1357	Malay
1358	Maltese
1363	Burmese
1365	Nauru
1369	Nepali
1376	Dutch
1379	Norwegian
1393	Occitan
1403	(Afan) Oromo
1408	Oriya
1417	Punjabi
1428	Polish
1435	“Pashto, Pushto”
1436	Portuguese
1463	Quechua
1481	Rhaeto-Romance

Code No.	Language
1482	Kirundi
1483	Romanian
1489	Russian
1491	Kinyarwanda
1495	Sanskrit
1498	Sindhi
1501	Sangro
1502	Serbo-Croatian
1503	Shinghalese
1505	Slovak
1506	Slovenian
1507	Samoan
1508	Shona
1509	Somali
1511	Albanian
1512	Serbian
1513	Siswati
1514	Sesotho
1515	Sundanese
1516	Swedish
1517	Swahili
1521	Tamil
1525	Tegulu
1527	Tajik
1528	Thai
1529	Tigrinya
1531	Turkmen
1532	Tagalog
1534	Setswana
1535	Tonga
1538	Turkish
1539	Tsonga
1540	Tatar
1543	Twi
1557	Ukrainian
1564	Urdu
1572	Uzbek
1581	Vietnamese
1587	Volapuk
1613	Wolof
1632	Xhosa
1665	Yoruba
1684	Chinese
1697	Zulu

## Free Manuals Download Website

<http://myh66.com>

<http://usermanuals.us>

<http://www.somanuals.com>

<http://www.4manuals.cc>

<http://www.manual-lib.com>

<http://www.404manual.com>

<http://www.luxmanual.com>

<http://aubethermostatmanual.com>

Golf course search by state

<http://golfingnear.com>

Email search by domain

<http://emailbydomain.com>

Auto manuals search

<http://auto.somanuals.com>

TV manuals search

<http://tv.somanuals.com>