

# OPERATING INSTRUCTIONS

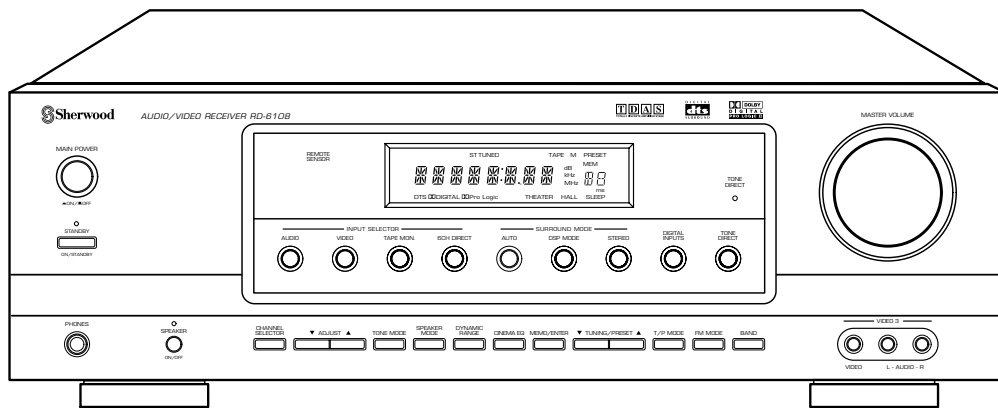

## RD-6108

### AUDIO/VIDEO RECEIVER

# Introduction

## UNPACKING AND INSTALLATION

### **Congratulations on Your Purchase!**

Your new high fidelity receiver is designed to deliver maximum enjoyment and years of trouble free service. Please take a few moments to read this manual thoroughly. It will explain the features and operation of your unit and help ensure a trouble free installation. Please unpack your unit carefully. We recommend that you save the carton and packing material. They will be helpful if you ever need to move your unit and may be required if you ever need to return it for service. Your unit is designed to be placed in a horizontal position and it is important to allow at least two inches of space behind your unit for adequate ventilation and cabling convenience.

To avoid damage, never place the unit near radiators, in front of heating vents, in direct sunlight, or in excessively humid or dusty locations. Connect your complementary components as illustrated in the following section.

### **FOR U.S.A**



■ **Note to CATV System Installer:** This reminder is provided to call the CATV system installer's attention to Article 820-40 of the NEC that provides guidelines for proper grounding and, in particular, specifies that the cable ground shall be connected to the grounding system of the building, as close to the point of cable entry as practical.

### ■ **FCC INFORMATION**

This equipment has been tested and found to comply with the limits for a Class B digital device, pursuant to Part 15 of the FCC Rules. These limits are designed to provide reasonable protection against harmful interference in a residential installation. This equipment generates, uses and can radiate radio frequency energy and, if not installed and used in accordance with the instructions, may cause harmful interference to radio communications. However, there is no guarantee that interference will not occur in a particular installation. If this equipment does cause harmful interference to radio or television reception, which can be determined by turning the equipment off and on, the user is encouraged to try to correct the interference by one or more of the following measures:

- Reorient or relocate the receiving antenna.
- Increase the separation between the equipment and receiver.
- Connect the equipment into an outlet on a circuit different from that to which the receiver is connected.
- Consult the dealer or an experienced radio/TV technician for help.

**CAUTION:** Any changes or modifications in construction of this device which are not expressly approved by the party responsible for compliance could void the user's authority to operate the equipment.

	<b>CAUTION</b> RISK OF ELECTRIC SHOCK DO NOT OPEN	
<b>CAUTION : TO REDUCE THE RISK OF ELECTRIC SHOCK, DO NOT REMOVE COVER (OR BACK). NO USER-SERVICEABLE PARTS INSIDE. REFER SERVICING TO QUALIFIED SERVICE PERSONNEL.</b>		



This symbol is intended to alert the user to the presence of uninsulated "dangerous voltage" within the product's enclosure that may be of sufficient magnitude to constitute a risk of electric shock to persons.



This symbol is intended to alert the user to the presence of important operating and maintenance (servicing) instructions in the literature accompanying the appliance.

### **WARNING**

To reduce the risk of fire or electric shock, do not expose this appliance to rain or moisture.

**Caution : Do not block ventilation openings or stack other equipment on the top.**

### **Caution regarding placement (Except for U.S.A and Canada)**

To maintain proper ventilation, be sure to leave a space around the unit (from the largest outer dimensions including projections) equal to, or greater than, shown below.



Left and right panels: 5 cm  
Rear panel: 10 cm  
Top panel: 20 cm

**READ THIS BEFORE OPERATING YOUR UNIT**

**FOR U.S.A AND CANADA .....120 V**

**FOR YOUR SAFETY**

Units shipped to the U.S.A and Canada are designed for operation on 120 V AC only.

Safety precaution with use of a polarized AC plug. However, some products may be supplied with a nonpolarized plug.

**CAUTION :** *To prevent electric shock, match wide blade of plug to wide slot, fully insert.*

**FOR EUROPE AND AUSTRALIA .....230 V/240 V**

**FOR YOUR SAFETY**

Units shipped to Australia are designed for operation on 240 V AC only.

To ensure safe operation, the three-pin plug supplied must be inserted only into a standard three-pin power point which is effectively earthed through the normal household wiring. Extension cords used with the equipment must be three-core and be correctly wired to provide connection to earth.

Improper extension cords are a major cause of fatalities. The fact that the equipment operates satisfactorily does not imply that the power point is earthed and that the installation is completely safe. For your safety, if in any doubt about the effective earthing of the power point, consult a qualified electrician.

**PAN-EUROPEAN UNIFIED VOLTAGE**

All units are suitable for use on supplies 230~240 V AC.

**FOR OTHER COUNTRIES ..... 115 V/230 V**

**FOR YOUR SAFETY**

Units shipped to countries other than the above countries are equipped with an AC voltage selector switch on the rear panel. Refer to the following paragraph for the proper setting of this switch.

**AC VOLTAGE SELECTION**

This unit operates on 115/230 V AC. The AC voltage selector switch on the rear panel is set to the voltage that prevails in the area to which the unit is shipped. Before connecting the power cord to your AC outlet, make sure that the setting position of this switch matches your line voltage. If not, it must be set to your voltage in accordance with the following direction.

AC voltage selector switch

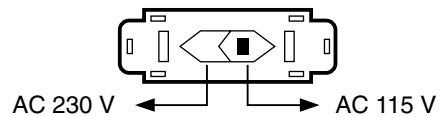

Move switch lever to match your line voltage with a small screwdriver or other pointed tool.

## CONTENTS

<b>Introduction</b>	
• UNPACKING AND INSTALLATION.....	2
• READ THIS BEFORE OPERATING YOUR UNIT.....	3
<b>System Connections.....</b>	<b>5</b>
<b>Front Panel Controls.....</b>	<b>7</b>
<b>Remote Controls.....</b>	<b>8</b>
• REMOTE CONTROL OPERATION RANGE.....	9
• LOADING BATTERIES.....	9
<b>Operations</b>	
• LISTENING TO A PROGRAM SOURCE.....	10
• SURROUND SOUND.....	13
• ENJOYING SURROUND SOUND.....	15
• LISTENING TO RADIO BROADCASTS.....	19
• RECORDING.....	21
• OTHER FUNCTIONS.....	22
<b>Troubleshooting Guide.....</b>	<b>23</b>
<b>Specifications.....</b>	<b>24</b>

# System Connections

- Do not plug the AC input cord into the wall AC outlet until all connections are completed.
- Be sure to connect the white RCA pin cord to the L(left) and the red RCA pin cord to the R(right) jacks when making audio connections.
- Change the position of the FM indoor antenna until you get the best reception of your favorite FM stations.
- A 75 Ω outdoor FM antenna may be used to further improve the reception.  
Disconnect the indoor antenna before replacing it with the outdoor one.
- Place the AM loop antenna as far as possible from the receiver, TV set, speaker cords and the AC input cord and set it to a direction for the best reception.
- If the reception is poor with the AM loop antenna, an AM outdoor antenna can be used in place of the AM loop antenna.
- Make connections firmly and correctly. If not, it can cause loss of sound, noise or damage to the receiver.
- If the electricity fails or the AC input cord is left unplugged for more than 2 weeks, the memorized contents will be cleared. Should this happen, memorize them again.

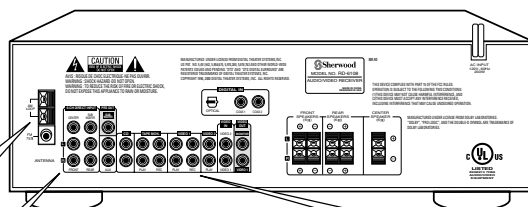
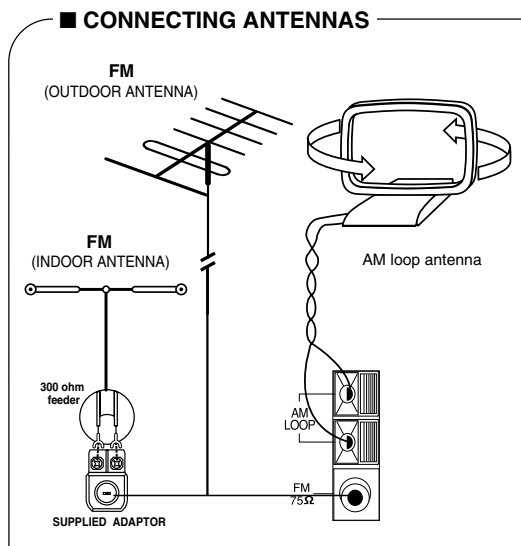

### CONNECTING AUDIO/VIDEO COMPONENTS

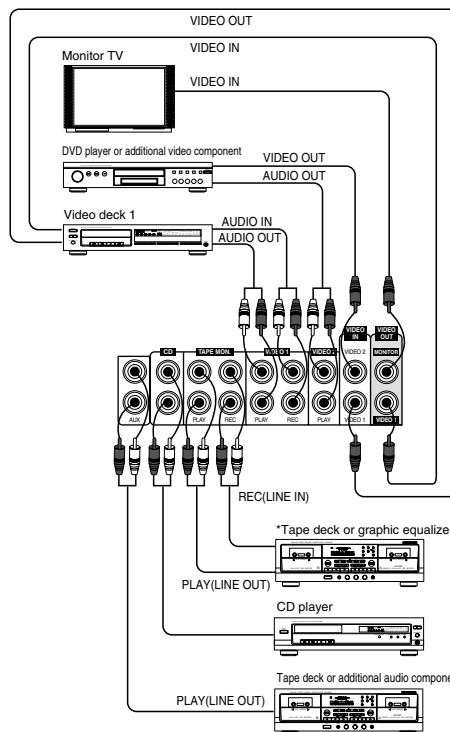

- The VIDEO 2 jacks may also be connected to an additional video component such as a cable TV tuner, a LD player or satellite system.
- The TAPE MONITOR PLAY/REC jacks may also be connected to the LINE OUT/IN jacks of an optional graphic equalizer.

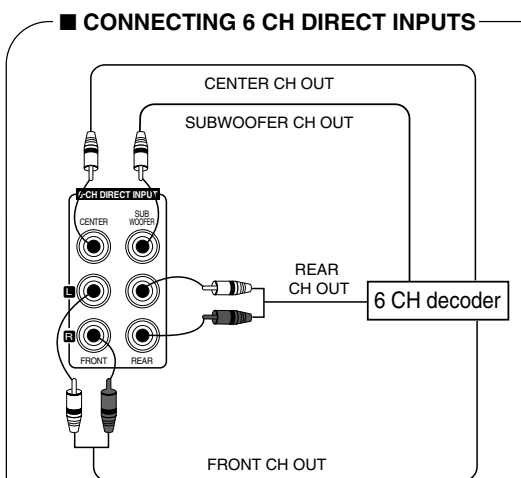

- Use these jacks to connect the corresponding analog outputs of 6 CH decoder or DVD player with 6 CH output for Dolby Digital or DTS, etc. (For details, see the operator's manual of the component to be connected.)

**■ SUBWOOFER PRE OUT connection**

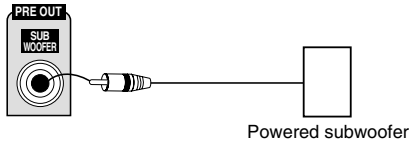

- To emphasize the deep bass sounds, connect a powered subwoofer.

**■ AC INPUT CORD**

Plug this cord into a wall AC outlet.

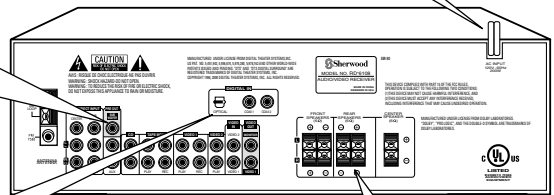

**■ CONNECTING DIGITAL INPUTS**

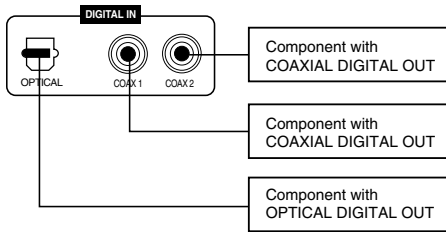

- The COAXIAL or the OPTICAL DIGITAL OUTs of the components that are connected to CD and VIDEO 1~3 of this unit can be connected to these DIGITAL INPUTS.
- A digital input should be connected to the components such as a CD player, LD player, DVD player, etc. capable of outputting DTS Digital Surround, Dolby Digital or PCM format digital signals.
- For details, refer to the operating instructions of the component connected.
- When making the COAXIAL DIGITAL connection, be sure to use a 75Ω COAXIAL cord, not a conventional AUDIO cord.
- All of the commercially available optical fiber cords cannot be used for the equipment. If there is an optical fiber cord which cannot be connected to your equipment, consult your dealer or nearest service organization.

**■ CONNECTING SPEAKERS**

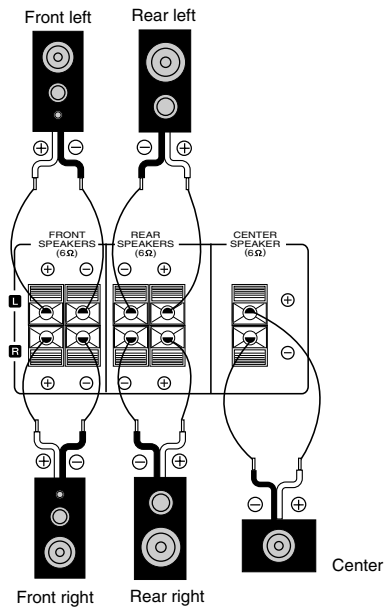

- Never short-circuit the + and - speaker cords.
- Be sure to connect speakers firmly and correctly according to the channel (left and right) and the polarity (+ and -).
- Be sure to use the speakers with the impedance of over 6Ω.
- For installing the speakers, refer to "Speaker placement" on page 14.

# Front Panel Controls

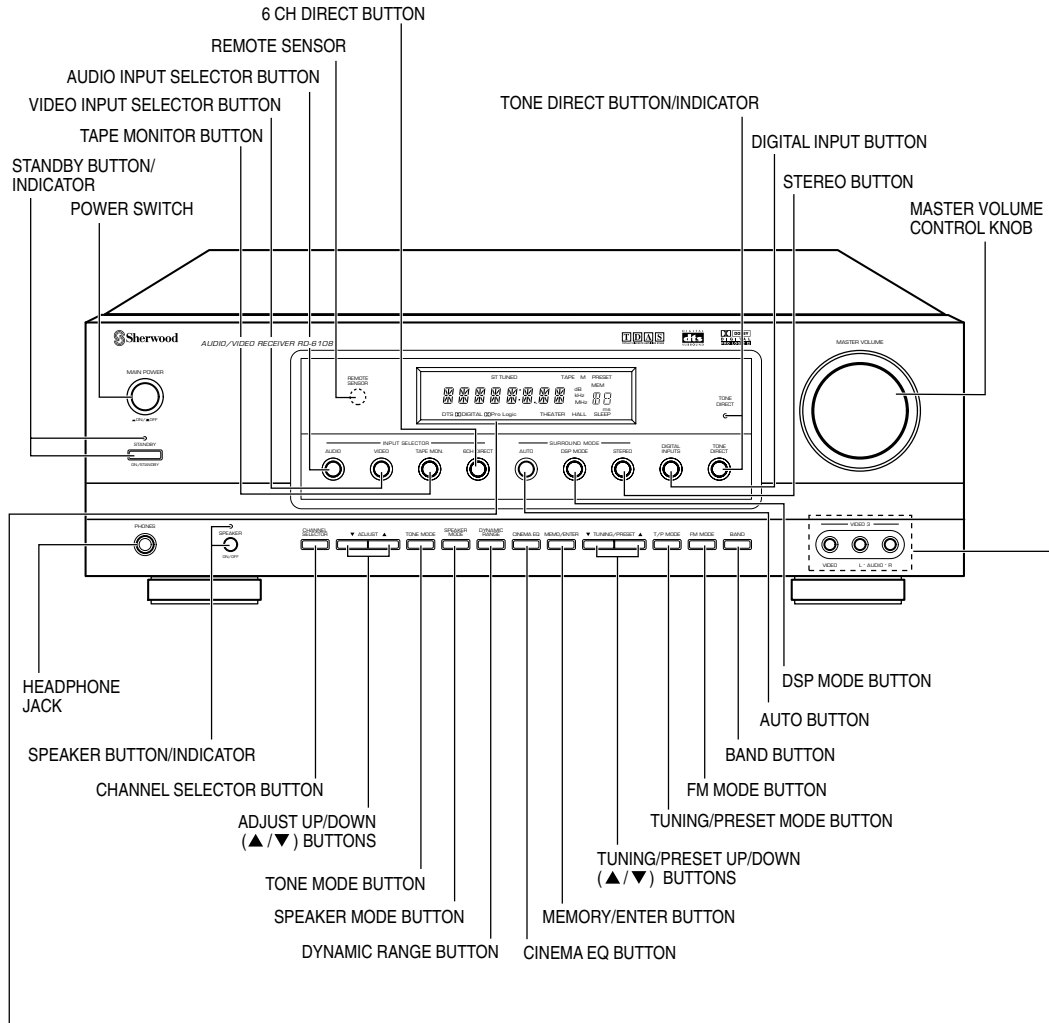

## ■ FLUORESCENT DISPLAY

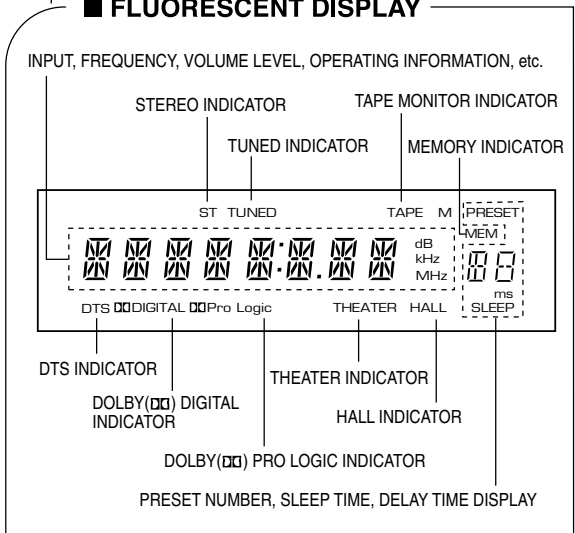

## ■ VIDEO 3 VIDEO/AUDIO INPUT JACKS

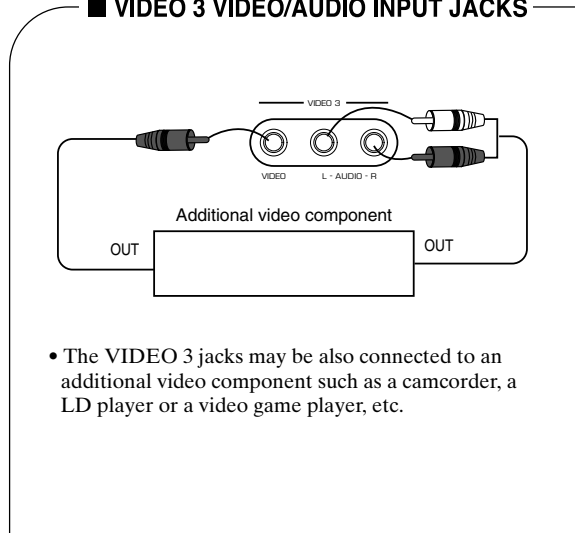

- The VIDEO 3 jacks may be also connected to an additional video component such as a camcorder, a LD player or a video game player, etc.

# Remote Controls

ENGLISH

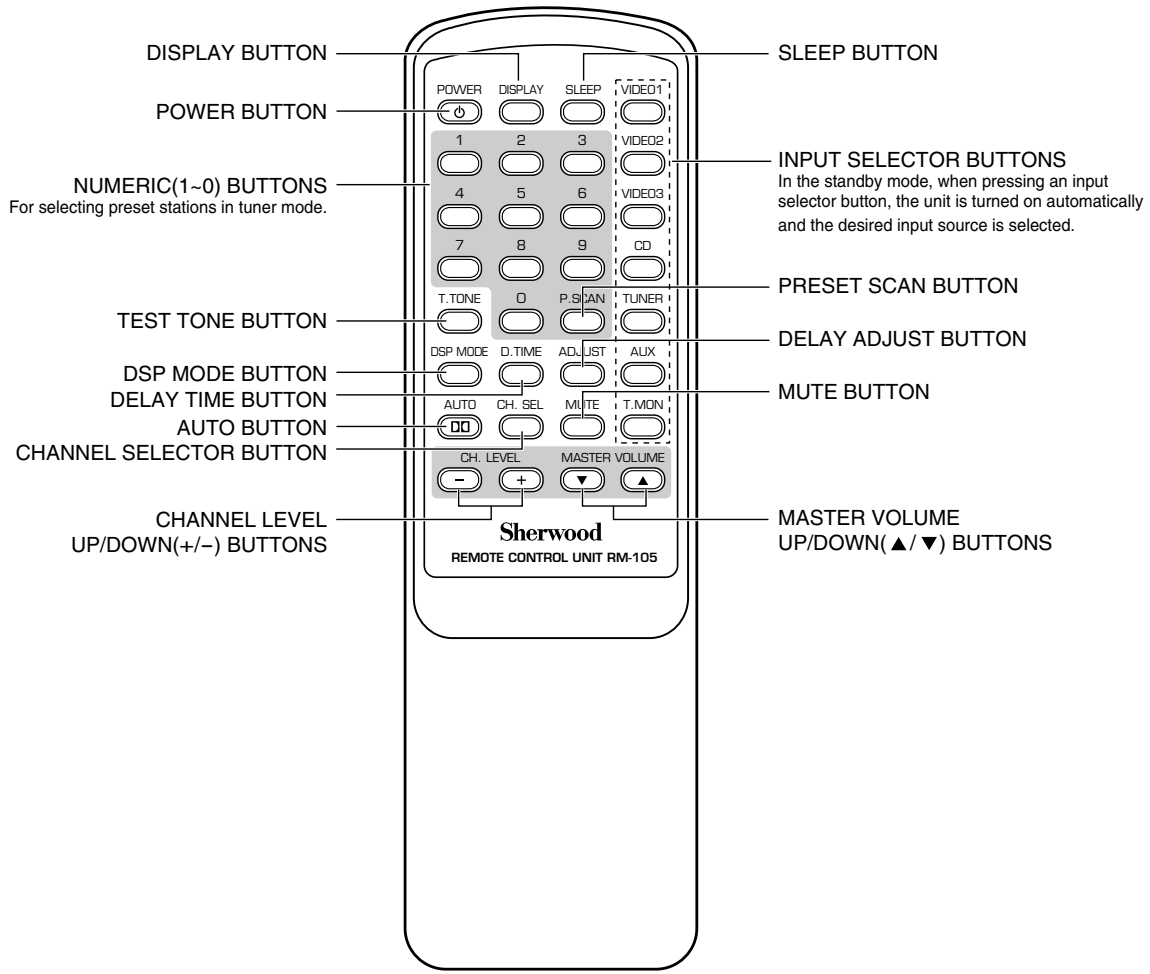



## REMOTE CONTROL OPERATION RANGE

7m  
30° 30°

- Use the remote control unit within a range of about 7 meters (23 feet) and angles of up to 30 degrees aiming at the remote sensor.

## LOADING BATTERIES

**1** Remove the cover.

**2** Load two batteries matching the polarity.

2 × 1.5V  
("AA" size)

- Remove the batteries when they are not used for a long time.
- Do not use the rechargeable batteries(Ni-Cd type).

# Operations

## LISTENING TO A PROGRAM SOURCE

### Before operation

- Enter the standby mode.



- The STANDBY indicator lights up. This means that the receiver is not disconnected from the AC mains and a small amount of current is retained to support the memorized contents and operation readiness.
- To switch the power off, push the POWER switch again.
- Then the power is cut off and the STANDBY indicator goes off.

1

In the standby mode, turn the power on.

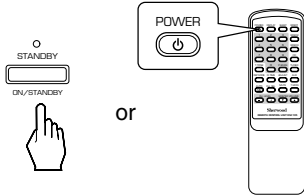

- Each time the STANDBY button on the front panel or the POWER button on the remote control is pressed, the receiver is turned on to enter the operating mode or off to enter the standby mode.
- In the standby mode, if the INPUT SELECTOR button is pressed, the receiver is turned on automatically and the desired input is selected.

2

Switch the speakers on.



- Then the SPEAKER indicator lights up and the sound can be heard from the speakers connected to the speaker terminals.
- When using the headphone for private listening, press the SPEAKER button again to switch the speakers off.

3

Select the desired input source.

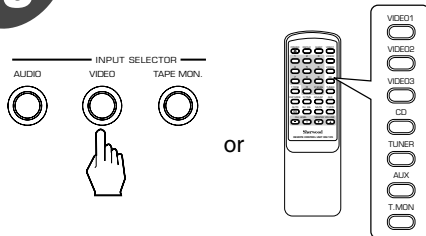

- Each time the "AUDIO" button is pressed, the input source changes as follows;  
→ TUNER → CD → AUX  
(frequency display)
- Each time the "VIDEO" button is pressed, the input source changes as follows;  
→ VIDEO 1 → VIDEO 2 → VIDEO 3
- When the TAPE MONITOR button is set to on so that "TAPE M" indicator lights up, other inputs can not be heard from the speakers. To listen to an input source other than TAPE MONITOR, be sure to set the TAPE MONITOR button to off.

### TAPE MONITOR function

You can connect either a tape deck or a graphic equalizer to the receiver's TAPE MONITOR jacks. Only when you listen to the component connected to these jacks, set the TAPE MONITOR button to on. If you connect a 3-head tape deck, you can listen to the sound being recorded during recording, not the source sound. For further details, refer to the operating instructions of the component connected.

- When selecting the 6 CH DIRECT as desired,



- "6-DIRECT" is displayed and the 6 separate analog signals from 6 CH decoder connected to this unit pass through the tone (bass, treble) and volume circuits only and directly transfer to the speakers. (In case that the TAPE MONITOR button is set to on, the TAPE MONITOR button is automatically set to off.)
- Press the 6 CH DIRECT button or select the desired input source to cancel the 6 CH direct function.
- These 6 separate analog signals can be heard only, not recorded.

**When CD, VIDEO 1~3 is selected as an input source**

**4** Select the digital or analog input connected as desired.



- Each time this button is pressed, the corresponding input is selected as follows ;

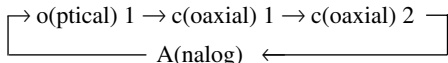

- To listen to a DTS or Dolby Digital program source in the 2-CH downmix mode, in the stereo mode, the corresponding digital input should be selected. (For details, refer to “Downmixing into 2 front channels” on page 18.)

■ Notes :

- When the selected optical or coaxial digital input is not connected, the selected digital input display is flickering, meaning no sound. (Refer to “ENJOYING SURROUND SOUND” on page 15.)
- The sound from the component connected to the selected digital input can be heard regardless of the selected input source.

**5** Operate the selected component for playback.

- When playing back the program sources with surround sound, refer to “ENJOYING SURROUND SOUND” on page 15.

**6** Adjust the (overall) volume.

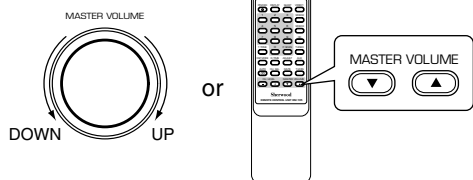

**7** To compensate for edgy or shrill movie sound tracks.



- Then “C-EQ ON” is displayed.
- Press it again to cancel, the “C-EQ OFF” is displayed.
- When the 6 CH DIRECT is selected as an input source, the cinema EQ function does not work.

**8** To mute the sound.

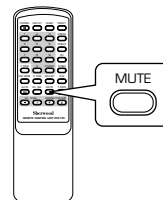

- “MUTE” will flicker.
- To resume the previous sound level, press it again.

**9** To listen with the headphones.



- Ensure that the SPEAKER button is set to off.
- When listening to a DTS or Dolby Digital program source, if the headphones are plugged in and the SPEAKER button is set to off, it enters the 2-CH downmix mode automatically. (For details, refer to “Downmixing into 2 front channels” on page 18.)

## Adjusting the tone(bass and treble)

**10** Enter the tone mode.



- Each time this button is pressed, the corresponding tone mode is selected and shown for 3 seconds as follows:

→ BASS → TRBL(treble)

- Note: When the TONE DIRECT indicator is lighting up, the tone mode cannot be entered.

**11** At the desired tone mode, adjust the tone as desired.

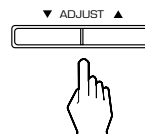

- If the tone display disappears, start from the step 10 again.
- Notes:
  - Extreme settings at high volume may damage your speakers.
  - When the digital signals from DTS or Dolby Digital program sources are input in available surround mode, the tone cannot be adjusted and the tone direct function is automatically switched to ON.

**12** To listen to a program source without the tone effect.

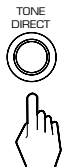

- The TONE DIRECT indicator lights up and the sound that bypasses the tone circuitry will be heard.
- To cancel the tone direct function, press this button again.

## SURROUND SOUND

- This receiver incorporates a sophisticated Digital Signal Processor that allows you to create optimum sound quality and sound atmosphere in your personal Home Theater.

### Surround modes

#### ■ DTS Digital Surround

DTS Digital Surround(also called simply DTS) is a multi-channel digital signal format which can handle more amount of data than Dolby Digital, providing better audio quality. Though the number of audio channels is 5.1(front left, front right, center, rear(surround) left, rear(surround) right and Low Frequency Effects) which is same as Dolby Digital, discs bearing the “” provides fat sound

and better signal - to - noise ratio, thanks to the lower audio compression ratio format.

It also provides wide dynamic range and better separation, resulting in magnificent sound.

“DTS” and “DTS Digital Surround” are registered trademarks of Digital Theater Systems,Inc.

#### ■ Dolby Digital

Dolby Digital is the multi-channel digital signal format developed by Dolby Laboratories. Discs bearing the “” includes the recording of up to 5. 1 channels of digital signals, which can reproduce much better sound quality, spatial expansion and dynamic range characteristics than the previous Dolby Surround effect.

#### ■ Dolby Pro Logic II surround

This mode applies conventional 2- channel signals such as digital PCM or analog stereo signals as well as Dolby Surround signals, etc. to surround processing to offer improvements over conventional Dolby Pro Logic circuits. Dolby Pro Logic II surround includes 4 modes as follows:

##### • Dolby Pro Logic II MOVIE

When enjoying movies, this mode allows you to further enhance the cinematic quality by adding processing that emphasizes the sounds of the action special effects.

##### • Dolby Pro Logic II MUSIC

When listening to music, this mode allows you to further enhance the sound quality by adding processing that emphasizes the musical effects.

##### • Dolby Pro Logic II MATRIX

When listening to poor FM broadcasts, this mode allows you to further enhance the sound quality by the ultimate cure for poor FM stereo signals.

##### • Dolby Pro Logic II CUSTOM

This mode reproduces a delayed signals from the surround channels to emphasize the sense of expansion.

- When the 6 CH DIRECT INPUTs are connected to the 6 CH decoder for a surround sound such as Dolby Digital or DTS, etc., you can enjoy the corresponding surround sound, too. (For details, see the operator’s manual of the component to be connected.)

#### ■ Dolby Pro Logic

Dolby Pro Logic is a specially encoded two channel surround format which consists of four channels (front left, center, front right and surround). Sources bearing the “” provide the theater-like surround sound.

The surround channel is monaural, but is played through two surround speakers.

#### ■ Dolby Virtual

This mode employs sophisticated digital processing to create the illusion of “phantom” speakers, this mode allows you to experience surround sound effects from the Dolby Digital, Dolby Surround or 2-channel(recorded in digital PCM or analog stereo) sources, through just a single pair of front speakers.

Manufactured under license from Dolby Laboratories. “Dolby”, “Pro Logic”, and the double-D symbol are trademarks of Dolby Laboratories.

- The following modes apply conventional 2-channel signals such as digital PCM or analog stereo signals to high performance Digital Processor to recreate sound fields artificially.

#### ■ THEATER

This mode provides the effect of being in a movie theater when watching a movie source.

#### ■ HALL

This mode provides the ambience of a concert hall for classical music sources such as orchestral, chamber music, or an instrumental solo.

#### ■ STADIUM

This mode provides the expansive sound field to achieve the true stadium effect when watching baseball or soccer games.

#### ■ CHURCH

This mode provides the ambience of a church for baroque, string orchestral or choral group music.

## Delay time

When the center speaker or the rear speakers is(are) closer to the listener than the front speakers, the sound from the center speaker or the rear speakers can arrive at the listener's ears earlier than the sound from the front speakers.

In this case, the imaging is not as sharp and stable as it could be.

For audible improvement, the sound from center speaker can be delayed with the center delay time setting so that the sound from the front and the center speakers will be heard at the same time and the sound from the rear speakers can be also delayed with the rear delay time setting so that the sound from the front and the rear speakers will be heard at the same time.

The optimum delay time will be different according to the room size and the acoustic properties. It is recommended that you try several times to obtain the best effect.

- It is adjustable in Dolby Digital, Dolby Pro Logic II, Dolby Pro Logic or Dolby Virtual modes. (For details, refer to "In Dolby Digital, Dolby Pro Logic II, Dolby Pro Logic or Dolby Virtual mode, adjusting delay times of the speakers" on page 18)

## Speaker placement

To obtain the best surround sound effect in your home, place the speakers as follows;

- Front speakers: Place each front speaker about 1m (40") from the TV set.
- Center speaker: Place the center speaker either above or below the TV set to assure good visualization of center channel program.
- Rear speakers: Place the rear speakers approximately 1m above the ear level of a seated listener on the direct left and right of them or slightly behind.
- Subwoofer: Reproduces powerful deep bass sounds. Place a powered subwoofer anywhere in the front as desired.
- The ideal surround system needs all the speakers listed above.

To obtain the best surround effects, the speakers except the subwoofer should be full range speakers.

Note: To avoid interference with the TV picture, use only magnetically shielded center and front speakers.

- For your reference, the sound from each channel can be reproduced according to the surround modes as follows:

Channels \ Modes	DTS	Dolby Digital	Dolby Pro Logic II	Dolby Pro Logic	Dolby Virtual	Other Surround	Stereo	6 CH DIRECT
Front L/R	○	○	○	○	○	○	○	○
Center	○	○	○	○	—	○	—	○
Rear L/R	○	○	○	○	—	○	—	○
Subwoofer	○	○	○	○	○	○	○	○

- Depending on the speaker settings, the sound from the corresponding channels cannot be reproduced. (For details, refer to "Adjusting the speaker settings" on page 16.)

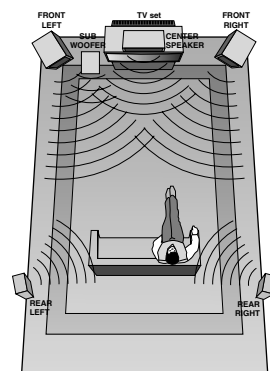

# ENJOYING SURROUND SOUND

- Surround sound effect will not work properly if the signal passes through a graphic equalizer. Please refer to your equalizer operating instructions for guidance on switching off (or defeating) the equalizer.

1

Depending on the input digital signal format, select the desired decoding mode.

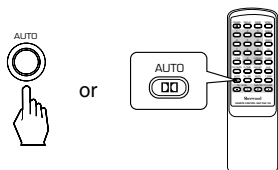

- Each time the AUTO button is pressed, the decoding mode changes as follows:

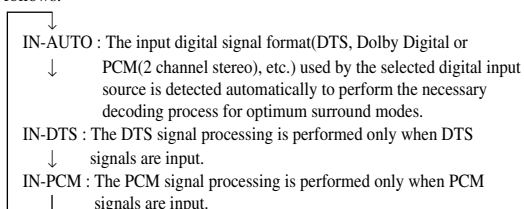

- Notes:
  - Only when the digital input is selected as signal input for the input sources except TUNER, AUX and TAPE MONITOR, the decoding mode can be selected.
  - Noise may be generated at the beginning of playback and while searching during DTS playback in the IN-AUTO mode. In this case, try playing in the IN-DTS mode.

2

Select the desired surround mode.

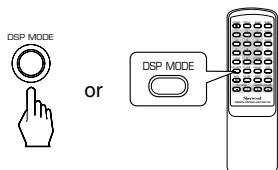

- Each time the DSP MODE button is pressed, the surround mode changes depending on the input signal format and the selected decoding mode as follows:
  - When Dolby Digital signals are input in the IN-AUTO mode, one of the following modes can be selected depending on the number of the recorded channels.
    - Dolby Digital 5.1-channel sources: DOLBY DIGITAL and DOLBY VIRTUAL.
    - Dolby Digital 2-channel sources: DOLBY PRO LOGIC II MOVIE, DOLBY PRO LOGIC, DOLBY PRO LOGIC II MUSIC, DOLBY PRO LOGIC II MATRIX, DOLBY PRO LOGIC II CUSTOM and DOLBY VIRTUAL.
  - When PCM(2 channel stereo) signals are input in the IN-PCM mode, one of the following modes can be selected:
    - DOLBY PRO LOGIC II MOVIE, DOLBY PRO LOGIC, DOLBY PRO LOGIC II MUSIC, DOLBY PRO LOGIC II MATRIX, DOLBY PRO LOGIC II CUSTOM, DOLBY VIRTUAL, CHURCH, THEATER, HALL and STADIUM.
- When the analog input is selected as signal input and analog stereo signals are input, you can select the desired of these above surround modes, too.
- However, when DTS signals are input in the IN-AUTO or IN-DTS mode, the DTS mode will be selected regardless of using the DSP MODE button.
- Notes:
  - When the selected decoding mode is not matched to the input signal format, no sound is heard. Therefore, be sure to select the required decoding mode and the available surround mode according to the input signal format.
  - When the 6 CH DIRECT is selected as an input source, the decoding and surround modes cannot be selected.

- When canceling the surround mode for stereo operation.



- Then the stereo mode is selected.
- To cancel the stereo mode, select the desired surround mode with using the DSP MODE button.

## Adjusting the Dolby Pro Logic II parameters

- When selecting the Dolby Pro Logic II Music and Custom modes, you can adjust the various surround parameters for optimum surround effect.

3

While scrolling "PL II MUSIC"(for Dolby Pro Logic II Music mode) or "PL II CUSTOM"(for Dolby Pro Logic II Custom mode), press the MEMORY/ENTER button to select the desired parameter.

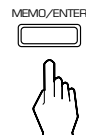

- Each time this button is pressed, the parameter changes and is displayed for 5 seconds as follows:
  - Panorama mode("PANO") : This mode extends the front stereo image to include the surround speakers for an exciting "wraparound"effect with side wall imaging. Select "OFF" or "ON".
  - Center width control("C-WID") : This control adjusts the center image so it may be heard only from the center speaker, only from the left/right speakers as a phantom image, or from all three front speakers to varying degrees. The control can be set in 8 steps from 0 to 7.
  - Dimension control("DIMEN") : This control gradually adjusts the soundfield either towards the front or towards the rear. The control can be set in 7 steps from - 4 to +2.
  - 7 kHz Low Pass Filter("LPF") : Select "OFF" or "ON" to turn off or on the pass filter on the surround channels.
  - Shelf Filter("SH - F") : Select "OFF" or "ON" to turn off or on the shelf filter on the surround channels.
  - Right Surround Channel Polarity Inversion("PO - I") : Select "OFF" or "ON" to turn off or on the polarity inversion.
  - Automatic Balancing("BAL") : Select " OFF" or "ON" to turn off or on the automatic balancing
- If the Dolby Pro Logic II Music or Custom display disappears, you cannot select the parameter. In this case, select the desired surround mode again by pressing the DSP MODE button.
- In the Dolby Pro Logic II Music mode, you cannot select the 7 kHz Low Pass Filter, Shelf Filter, Right Surround Channel Polarity Inversion and Automatic Balancing.
- For your reference, the initial settings for parameters are as follows: "PANO" : "OFF", "C-WID" : "0", "DIMEN" : "0", "LPF" : "OFF", "SH-F" : "OFF", "PO-I" : "ON", "BAL" : "OFF".

**4** At the desired parameter, adjust it as desired.

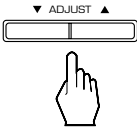

- If the parameter display disappears, start from the step 3 again.

**5** Repeat the above steps 3 and 4 to adjust other parameters.

■ Note:

- In the Dolby Pro Logic II Customer mode, you cannot set both of the 7 kHz Low Pass Filter and Shelf Filter to ON simultaneously. If so, the filter set previously is automatically changed to OFF.

**Adjusting the speaker settings**

- Adjust the settings of front, center ,rear speakers and subwoofer connected.
- If the speaker setting is adjusted to “S”, the low range bass sound of the channel(s) is redirected to the subwoofer or the front channels and if the speaker setting is adjusted to “N”, the sound of the channel(s) is redirected to other channels.

**6** Press the SPEAKER MODE button for more than 2 seconds to enter the front-center-rear speaker mode.



- The front-center-rear speaker setting is displayed.
- When the SPEAKER button is set to off or the 6 CH DIRECT is selected as an input source, the speaker mode function cannot be available.
- When it is in the stereo or Dolby Virtual mode, only the subwoofer setting can be adjusted.

**7** Select the desired speaker setting.

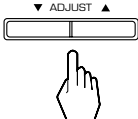

- Each time this button is pressed, one of 11 different speaker settings is selected and displayed for 8 seconds as follows;  
FL-CS-RS, FL-CL-RS, FL-CL-RL, FL-CL-RN, FL-CS-RL, FL-CN-RL, FL-CS-RN, FL-CN-RS, FS-CS-RS, FS-CS-RN and FS-CN-RS
- In the displays, F stands for Front, C for Center, R for Rear, L for Large, S for Small and N for None.
- When judging whether a speaker is Large or Small, please note that a standard large speaker can fully reproduce sounds below 80 Hz.
- The following speaker settings cannot be selected. Front :Small, Center : Large and Rear : Large(FS-CL-RL) or Center : None and Rear : None(CN-RN) setting.

**8** Memorize the desired speaker setting while it is displayed.



- The desired speaker setting is memorized and then it enters the subwoofer mode.
- If the speaker setting display disappears, start from the above step 6 again.

**9** Select the desired subwoofer setting.

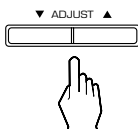

- Each time this button is pressed, the subwoofer setting changes and is displayed for 8 seconds as follows;  
SUB W(oofer) - Y(es): When using a subwoofer.  
SUB W(oofer) - N(o) : When not using a subwoofer.
- In case that the front speaker is set to “S”, the subwoofer is automatically set to “Y”.

**10** Memorize the subwoofer setting while it is displayed.



- If the subwoofer setting display disappears, start from the above step 6 again.

**Checking the speaker setting**



- Each time this button is pressed briefly, the front-center-rear speaker or subwoofer setting is displayed.



## Adjusting each channel level

**11** Select the desired channel.

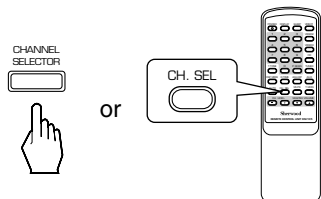

- Each time this button is pressed, the corresponding channel is selected and displayed for 3 seconds as follows;
  - Front Left → Center → Front Right → Rear Right
  - (Dolby Digital or DTS L(FE) ←) SubWoofers ← Rear Left ←
 ( ): Adjustable only when the digital signals from Dolby Digital or DTS program source that includes LFE signal are input in the available surround mode.
- When it is in the stereo or Dolby Virtual mode, or the speaker setting is "N", center, rear or subwoofer channel will not be selected.

**12** Adjust the level of the selected channel as desired.

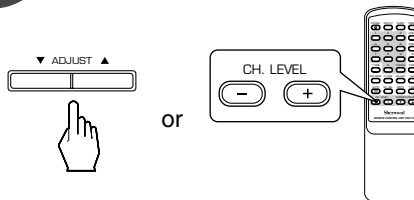

- The LFE level can be adjusted within the range of -10~0 dB and other channel levels within the range of -15~+15 dB.
- In general, we recommend the LFE level to be adjusted to 0 dB. (However, the recommend LFE level for some early DTS software is -10 dB.) If the recommended levels seems too high, lower the setting as necessary.
- If the channel display disappears, start from the above step 11 again.

**13** Repeat the above steps 11 and 12 to adjust other channel levels.

## Adjusting each channel level with test tone

- Only when it is in available surround modes except the Dolby Virtual and stereo modes, the volume level of each channel can be adjusted easily with the test tone function.
- Note:** When the 6 CH DIRECT is selected as an input source, the test tone function does not work.

**14** Enter the test tone mode.

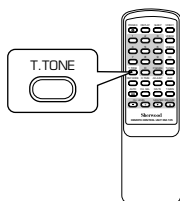

- The test tone will be heard from the speaker of each channel for 2 seconds as follows;
  - Front Left → Center → Front Right
  - SUBwoofer ← Rear Left ← Rear Right ←
- When the speaker setting is "N", the test tone of the corresponding channel is not available.
- When the selected decoding mode is not matched to the input signal format, the test tone function cannot work.

**15** At each channel, adjust the level as desired until the sound level of each speaker is heard to be equally loud.

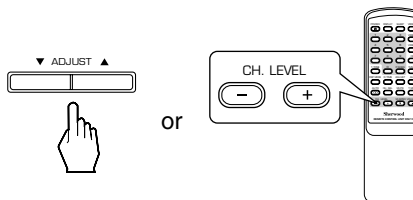

- You can select the desired channel and adjust its level with repeating the steps 11 and 12 in "Adjusting each channel level" procedure.

**16** Cancel the test tone function.

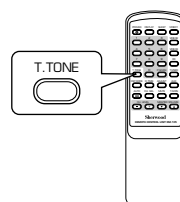

### In Dolby Digital, Dolby Pro Logic II, Dolby Pro Logic or Dolby Virtual mode, adjusting delay times of the speakers

- In case of Dolby Digital, Dolby Pro Logic II or Dolby Pro Logic mode, when the distances from the prime listening position to front left, center, front right, rear left and rear right speakers are same, the basic settings are as follows according to the surround modes;
  - In the Dolby Digital mode,  
Center delay time : 0 ms, Rear delay time : 0 ms
  - In the Dolby Pro Logic II Music, Matrix or Custom mode,  
Rear delay time : 0 ms
  - In the Dolby Pro Logic II Movie, Dolby Pro Logic mode,  
Rear delay time : 10 ms
- If the center or the rear speaker(s) is(are) not at the same distance from the prime listening position as the front speakers, increase or decrease the center delay time by 1 ms for every about 30 cm(1 foot) it is closer or farther away and increase or decrease the rear delay time by 5 ms for every about 1~1.5 m(3~5 feet) it is closer or farther away.

17

Check the delay time to be adjusted.

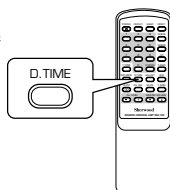

- The delay time will be displayed for 5 seconds.
- The corresponding delay time is displayed. The center delay time can be adjusted in the Dolby Digital mode only.
- In the Dolby Virtual mode, “NARROW” or “WIDE” is displayed.

18

Adjust the delay time.

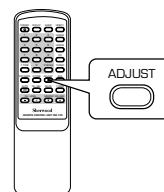

- Each time this button is pressed in the Dolby Digital, Dolby Pro Logic II or Dolby Pro Logic mode, the delay time changes in regular intervals.
- Each time this button is pressed in the Dolby Virtual mode, the delay mode changes as follows:

↓  
NARROW: Relatively long distance from the prime listening position to front speakers.  
↓  
WIDE: Relatively short distance.

- If the delay time disappears, start from the step 17 again.

19

In Dolby Digital mode, repeat the above steps 17 and 18 to adjust the rear delay time.

### Downmixing into 2 front channels

- Allows the multi-channel DTS or Dolby Digital signals to be reproduced through only two speakers or through headphones.
- When the digital signals from the DTS or Dolby Digital program sources are input in available surround mode, press the STEREO button.



- “ST” and the DTS or Dolby Digital indicators light up, meaning it enters the 2-CH downmix mode, and then the discrete multi-channels(except LFE) are mixed down into 2 front channels.

- To cancel the 2-CH downmix mode, select the desired surround mode with using the DSP MODE button.
- When the playback of the source on the player is stopped or interrupted, etc., the 2-CH downmix mode is not canceled even though “ST” and the DTS or Dolby Digital indicators go off.
- If the headphones are plugged and the SPEAKER button is set to off while the digital signals from the DTS and Dolby Digital program sources are being input, it will enter the 2-CH downmix mode automatically(but only the DTS or Dolby Digital indicator lights up still) and if the headphones are unplugged and the SPEAKER button is set to on in the 2-CH downmix mode, it will return to the previous mode.

## LISTENING TO RADIO BROADCASTS

### Auto tuning

1

Select the tuner.

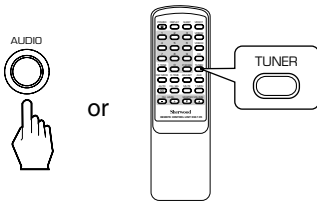

2

Select the desired band.

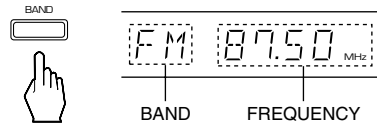

- Each time this button is pressed, the band is changed to FM or AM.
- When pressing the BAND button without selecting the TUNER, the tuner will be selected automatically.

3

Select the tuning mode.



- Each time this button is pressed, the mode changes as follows;

→ Tuning mode : “PRESET” goes off. ←  
Preset mode : “PRESET” lights up. ←

4

Press the TUNING/PRESET UP(▲) or DOWN(▼) button for more than 0.5 second.

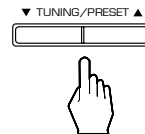

- The tuner will now search until a station of sufficient strength has been found. The display shows the tuned frequency and “TUNED”.
- If the station found is not the desired one, simply repeat this operation.
- Weak stations are skipped during auto tuning.

### Manual tuning

- Manual tuning is useful when you already know the frequency of the desired station.
- Perform the steps 1 to 3 in “Auto tuning” procedure and press the TUNING/PRESET UP(▲) or DOWN(▼) button repeatedly until the right frequency has been reached.

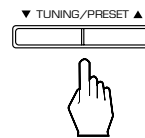

### Presetting radio stations

- You can store up to 30 preferred stations in the memory.

1

Tune in the desired station with auto or manual tuning.

2

Press the MEMORY/ENTER button.

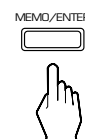

- “MEM” is flickering for 5 seconds.

**3** Select the desired preset number (1~30) and press the MEMORY/ENTER button.

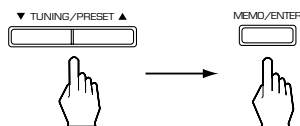

- When using the NUMERIC buttons on the remote control.
  - Examples) For “3” :
  - For “15” : within 2 seconds
  - For “30” :
- The station has now been stored in the memory.
- When using the NUMERIC buttons, the station is stored automatically without pressing the MEMORY/ENTER button.
- A stored frequency is erased from the memory by storing another frequency in its place.
- If “MEM” goes off, start again from the above step 2.

**4** Repeat the above steps 1 to 3 to memorize other stations.

**MEMORY BACKUP FUNCTION**

The following items, set before the receiver is turned off, are memorized.

- INPUT SELECTOR settings
- Surround mode settings
- Preset stations, etc.

Note : If the electricity fails or the AC input cord is disconnected for more than 2 weeks, they are all cleared. So you should memorize them again.

**Tuning to preset stations**

**1** After selecting the tuner as an input source, select the preset tuning mode.



- Then “PRESET” lights up.

**2** Select the desired preset number.

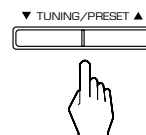

- When using the NUMERIC buttons on the remote control.

Examples) For “3” :

For “15” : within 2 seconds

For “30” : (or within 2 seconds

- When selecting the desired preset number with the NUMERIC buttons, the desired preset station will be tuned to automatically without selecting the preset tuning mode.

**Listening to FM stereo broadcasts**

- While listening to FM broadcasts.
- Each time this button is pressed, the FM mode changes as follows;
  - ↳ Stereo mode : “ST” lights up. ↪
  - ↳ Mono mode : “ST” goes off. ↶
- When FM stereo broadcasts are poor because of weak broadcast signals, select the FM mono mode to reduce the noise, then FM broadcasts are reproduced in monaural sound.



**Scanning preset stations in sequence**

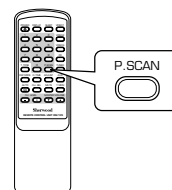

- The receiver will start scanning the stations in the preset sequence and each station is received for 5 seconds.
- At the desired station, press this button again to stop scanning.

# RECORDING

- The analog signals from the 6 CH DIRECT inputs as well as the digital signals from the coaxial or optical digital input can be heard but cannot be recorded.
- The volume and tone (bass, treble) settings have no effect on the recording signals.

## Recording with TAPE MONITOR

**1** Select the desired input as a recording source except for TAPE MONITOR.

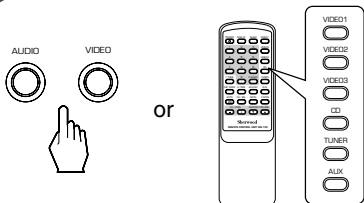

- Be sure that "TAPE M" goes off.

**2** Start recording on the TAPE MONITOR.

**3** Start play on the desired input.

- For tape monitor function, refer to "TAPE MONITOR function" on page 10.

## Dubbing from video components onto VIDEO 1

**1** Select VIDEO 2 or VIDEO 3 as a recording source.

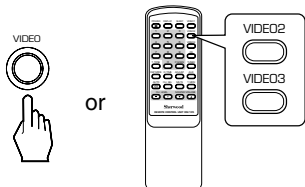

**2** Start recording on the VIDEO 1.

**3** Start play on the VIDEO 2 or the VIDEO 3.

- The audio and video signals from the VIDEO 2 or the VIDEO 3 will be dubbed onto the VIDEO 1 and you can enjoy them on the TV set and from the speakers.

## Dubbing the audio and video signals separately onto VIDEO 1

Example) When dubbing the VIDEO 2 video signal and the CD audio signal separately onto VIDEO 1.

**1** Select VIDEO 2 as a video recording source.

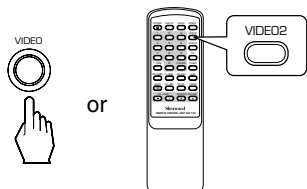

**2** Select CD as an audio recording source.

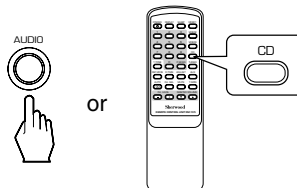

**3**

Start recording on the VIDEO 1.

**4**

Start play on the VIDEO 2 and the CD respectively.

- The audio signal from the CD and the video signal from the VIDEO 2 will be dubbed and you can enjoy them on the TV set and from the speakers.

Note : Be sure to observe the order of the above steps 1 and 2.

## OTHER FUNCTIONS

### Compressing the dynamic range (Dolby Digital sources only)

- This function compresses the dynamic range of previously specified parts of the Dolby Digital sound track (with extremely high volume) to minimize the difference in volume between the specified and non-specified parts. This makes it easier to hear all of the sound track when watching movies at night at low levels.
- When the digital signals from Dolby Digital program source are input in available surround mode.
- Each time this button is pressed, the mode changes and disappears in 3 seconds as follows:

↓  
DYNR 0.0 : Off  
↓  
DYNR 0.5 : Low compression  
↓  
DYNR 1.0 : High compression

- In some Dolby Digital software, this function may not be available.



### Operating the sleep timer

- The sleep timer allows the system to continue to operate for a specified period of time before automatically shutting off.
- To set the receiver to automatically turn off after the specified period of time.

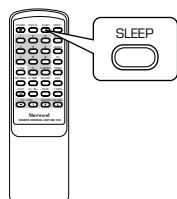

- Each time this button is pressed, the sleep time changes and disappears in 3 seconds as follows;

→ 10 → 20 → 30 → 60 → 90 → OFF  
Unit : minutes

- While operating the sleep timer, "SLEEP" lights up.

### Adjusting the brightness of the fluorescent displays

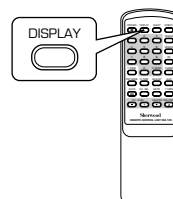

- Each time this button is pressed, the brightness of fluorescent display changes as follows;

→ ON → dim → OFF

- In the display OFF mode, pressing any button will restore the display ON mode.

# Troubleshooting Guide

If a fault occurs, run through the table below before taking your receiver for repair.

If the fault persists, attempt to solve it by switching the receiver off and on again. If this fails to resolve the situation, consult your dealer. Under no circumstances should you attempt to repair the receiver yourself. This could void the warranty.

PROBLEM	POSSIBLE CAUSE	REMEDY
No power	<ul style="list-style-type: none"> <li>The AC input cord is disconnected.</li> <li>Poor connection at AC wall outlet or the outlet is inactive.</li> </ul>	<ul style="list-style-type: none"> <li>Connect the cord securely.</li> <li>Check the outlet using a lamp or another appliance.</li> </ul>
No sound	<ul style="list-style-type: none"> <li>The speaker cords are disconnected.</li> <li>The master volume is adjusted too low.</li> <li>The MUTE button on the remote control is pressed to ON.</li> <li>Speakers are not switched on.</li> <li>Incorrect selection of the input source.</li> <li>Incorrect connections between the components.</li> </ul>	<ul style="list-style-type: none"> <li>Check the speaker connections.</li> <li>Adjust the master volume.</li> <li>Press the MUTE button to cancel the muting effect.</li> <li>Press the SPEAKER button to ON.</li> <li>Select the desired input source correctly.</li> <li>Make connections correctly.</li> </ul>
No sound from the rear speakers	<ul style="list-style-type: none"> <li>Surround mode is switched off(stereo mode).</li> <li>Master volume and rear level are too low.</li> <li>A monaural source is used.</li> <li>Rear speaker setting is "N".</li> </ul>	<ul style="list-style-type: none"> <li>Select a surround mode.</li> <li>Adjust master volume and rear level.</li> <li>Select a stereo or surround source.</li> <li>Select the desired rear speaker setting.</li> </ul>
No sound from the center speaker	<ul style="list-style-type: none"> <li>Surround mode is switched off(stereo mode).</li> <li>Center speaker setting is "N".</li> <li>Master volume and center level are too low.</li> </ul>	<ul style="list-style-type: none"> <li>Select the desired surround.</li> <li>Select the desired center speaker setting.</li> <li>Adjust master volume and center level.</li> </ul>
Stations cannot be received	<ul style="list-style-type: none"> <li>No antenna is connected.</li> <li>The desired station frequency is not tuned in.</li> <li>The antenna is in wrong position.</li> </ul>	<ul style="list-style-type: none"> <li>Connect an antenna.</li> <li>Tune in the desired station frequency.</li> <li>Move the antenna and retry tuning.</li> </ul>
Preset stations cannot be received	<ul style="list-style-type: none"> <li>An incorrect station frequency has been memorized.</li> <li>The memorized stations are cleared.</li> </ul>	<ul style="list-style-type: none"> <li>Memorize the correct station frequency.</li> <li>Memorize the stations again.</li> </ul>
Poor FM reception	<ul style="list-style-type: none"> <li>No antenna is connected.</li> <li>The antenna is not positioned for the best reception.</li> </ul>	<ul style="list-style-type: none"> <li>Connect an antenna.</li> <li>Change the position of the antenna.</li> </ul>
Continuous hissing noise during FM reception, especially when a stereo broadcast is received.	<ul style="list-style-type: none"> <li>Weak signals.</li> </ul>	<ul style="list-style-type: none"> <li>Change the position of the antenna.</li> <li>Install an outdoor antenna.</li> </ul>
Continuous or intermittent hissing noise during AM reception, especially at night.	<ul style="list-style-type: none"> <li>Noise is caused by motors, fluorescent lamps or lightning, etc.</li> </ul>	<ul style="list-style-type: none"> <li>Keep the receiver away from noise sources.</li> <li>Install an outdoor AM antenna.</li> </ul>
Remote control unit does not operate.	<ul style="list-style-type: none"> <li>Batteries are not loaded or exhausted.</li> <li>The remote sensor is obstructed.</li> </ul>	<ul style="list-style-type: none"> <li>Replace the batteries.</li> <li>Remove the obstacle.</li> </ul>

# Specifications

## ■ AMPLIFIER SECTION

- Power output, stereo mode, 6  $\Omega$ , THD 0.7%, 40 Hz~20 kHz ..... 2  $\times$  100 W
- Total harmonic distortion, 6  $\Omega$ , 100 W, 1 kHz ..... 0.09%
- Intermodulation distortion  
60 Hz : 7 kHz= 4 : 1 SMPTE, 6  $\Omega$ , 100 W ..... 0.1%
- Input sensitivity, 47 k $\Omega$   
Line (CD, TAPE, VIDEO) ..... 200 mV
- Signal to noise ratio, IHF "A" weighted  
Line (CD, TAPE, VIDEO) ..... 92 dB
- Frequency response  
Line (CD, TAPE, VIDEO), 20 Hz~50 kHz ..... +0 dB, -3 dB
- Output level  
TAPE REC, 2.2 k $\Omega$  ..... 200 mV  
PRE OUT(Front, Center, Rear, Subwoofer), 1 k $\Omega$  ..... 1.0 V
- Bass/Treble control, 100 Hz/10 kHz .....  $\pm$  10 dB
- Surround mode, only channel driven  
Front power output, 6  $\Omega$ , 1 kHz, THD 0.7 % ..... 125 W+125 W  
Center power output, 6  $\Omega$ , 1 kHz, THD 0.7 % ..... 125 W  
Rear power output, 6  $\Omega$ , 1 kHz, THD 0.7 % ..... 125 W+125 W

## ■ DIGITAL AUDIO SECTION

- Sampling frequency ..... 32, 44.1, 48, 96 kHz
- Digital input level  
Coaxial, 75  $\Omega$  ..... 0.5 Vp-p  
Optical, 660 nm ..... -15~-21 dBm

## ■ FM TUNER SECTION

- Tuning frequency range ..... 87.5~108 MHz
- Usable sensitivity, THD 3%, S/N 30 dB ..... 12.8 dBf
- 50 dB quieting sensitivity, mono/stereo ..... 20.2/45.3 dBf
- Signal to noise ratio, 65 dBf, mono/stereo ..... 70/65 dB
- Total harmonic distortion, 65 dBf, 1 kHz, mono/stereo ..... 0.5/0.8%
- Frequency response, 30 Hz~15 kHz .....  $\pm$  3 dB
- Stereo separation, 1 kHz ..... 42 dB
- Capture ratio ..... 4 dB
- IF rejection ratio ..... 80 dB

## ■ AM TUNER SECTION

- Tuning frequency range ..... 520~1710 kHz
- Usable sensitivity ..... 500  $\mu$ V/m
- Signal to noise ratio ..... 40 dB
- Selectivity ..... 25 dB

## ■ GENERAL

- Power supply ..... AC 120 V, 60 Hz
- Power consumption ..... 200 W
- Dimensions (W  $\times$  H  $\times$  D) ..... 440  $\times$  141  $\times$  330 mm(17-3/8  $\times$  5-1/2  $\times$  13 inches)
- Weight (Net) ..... 9.6 kg(21.2 lbs)

Note: Design and specifications are subject to change without notice for improvements.



# OPERATING INSTRUCTIONS



**RD-6108**  
**AUDIO/VIDEO RECEIVER**

5707-04735-008-0

## Free Manuals Download Website

<http://myh66.com>

<http://usermanuals.us>

<http://www.somanuals.com>

<http://www.4manuals.cc>

<http://www.manual-lib.com>

<http://www.404manual.com>

<http://www.luxmanual.com>

<http://aubethermostatmanual.com>

Golf course search by state

<http://golfingnear.com>

Email search by domain

<http://emailbydomain.com>

Auto manuals search

<http://auto.somanuals.com>

TV manuals search

<http://tv.somanuals.com>