

OPERATING INSTRUCTIONS

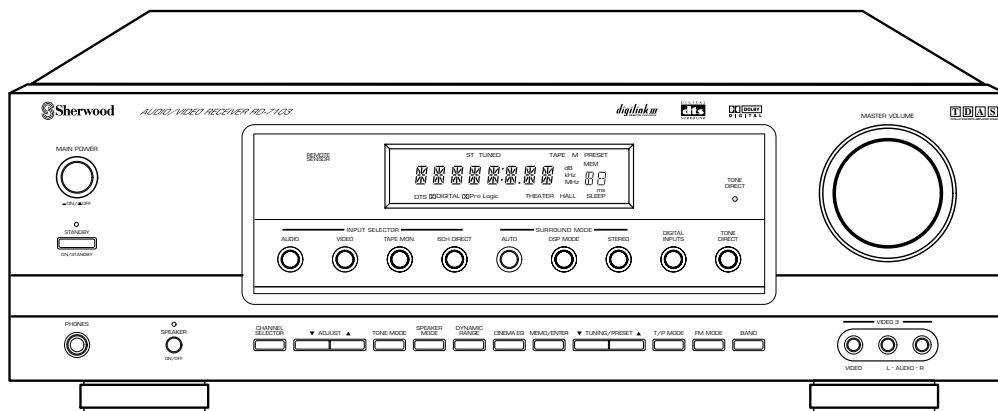

RD-7103

AUDIO/VIDEO RECEIVER

Introduction

UNPACKING AND INSTALLATION

Congratulations on Your Purchase!

Your new high fidelity receiver is designed to deliver maximum enjoyment and years of trouble free service. Please take a few moments to read this manual thoroughly. It will explain the features and operation of your unit and help ensure a trouble free installation. Please unpack your unit carefully. We recommend that you save the carton and packing material. They will be helpful if you ever need to move your unit and may be required if you ever need to return it for service. Your unit is designed to be placed in a horizontal position and it is important to allow at least two inches of space behind your unit for adequate ventilation and cabling convenience.

To avoid damage, never place the unit near radiators, in front of heating vents, in direct sunlight, or in excessively humid or dusty locations. Connect your complementary components as illustrated in the following section.

FOR U.S.A.



■ **Note to CATV System Installer:** This reminder is provided to call the CATV system installer's attention to Article 820-40 of the NEC that provides guidelines for proper grounding and, in particular, specifies that the cable ground shall be connected to the grounding system of the building, as close to the point of cable entry as practical.

■ FCC INFORMATION

This equipment has been tested and found to comply with the limits for a Class B digital device, pursuant to Part 15 of the FCC Rules. These limits are designed to provide reasonable protection against harmful interference in a residential installation. This equipment generates, uses and can radiate radio frequency energy and, if not installed and used in accordance with the instructions, may cause harmful interference to radio communications. However, there is no guarantee that interference will not occur in a particular installation. If this equipment does cause harmful interference to radio or television reception, which can be determined by turning the equipment off and on, the user is encouraged to try to correct the interference by one or more of the following measures:

- Reorient or relocate the receiving antenna.
- Increase the separation between the equipment and receiver.
- Connect the equipment into an outlet on a circuit different from that to which the receiver is connected.
- Consult the dealer or an experienced radio/TV technician for help.

CAUTION: Any changes or modifications in construction of this device which are not expressly approved by the party responsible for compliance could void the user's authority to operate the equipment.

	CAUTION RISK OF ELECTRIC SHOCK DO NOT OPEN	
CAUTION : TO REDUCE THE RISK OF ELECTRIC SHOCK, DO NOT REMOVE COVER (OR BACK). NO USER-SERVICEABLE PARTS INSIDE. REFER SERVICING TO QUALIFIED SERVICE PERSONNEL.		



This symbol is intended to alert the user to the presence of uninsulated "dangerous voltage" within the product's enclosure that may be of sufficient magnitude to constitute a risk of electric shock to persons.



This symbol is intended to alert the user to the presence of important operating and maintenance (servicing) instructions in the literature accompanying the appliance.

WARNING

To reduce the risk of fire or electric shock, do not expose this appliance to rain or moisture.

Caution : Do not block ventilation openings or stack other equipment on the top.

Caution regarding placement (Except for U.S.A. and Canada)

To maintain proper ventilation, be sure to leave a space around the unit (from the largest outer dimensions including projections) equal to, or greater than, shown below.



Left and right panels: 5 cm
Rear panel: 10 cm
Top panel: 20 cm

READ THIS BEFORE OPERATING YOUR UNIT

FOR U.S.A. AND CANADA 120 V

FOR YOUR SAFETY

Units shipped to the U.S.A. and Canada are designed for operation on 120 volts AC only.

Observe all safety precautions for use of a polarized AC plug. However, some products may be supplied with a non polarized plug.

CAUTION : To prevent electric shock, match wide blade of plug to wide slot, insert fully.

FOR EUROPE AND AUSTRALIA230 V/240 V

FOR YOUR SAFETY

Units shipped to Australia are designed for operation on 240 V AC only.

To ensure safe operation, the three-pin plug supplied must be inserted only into a standard three-pin power point which is effectively earthed through the normal household wiring. Extension cords used with the equipment must be three-core and be correctly wired to provide connection to earth.

Improper extension cords are a major cause of fatalities. The fact that the equipment operates satisfactorily does not imply that the power point is earthed and that the installation is completely safe. For your safety, if in any doubt about the effective earthing of the power point, consult a qualified electrician.

PAN-EUROPEAN UNIFIED VOLTAGE

All units are suitable for use on supplies 230-240 V AC.

FOR OTHER COUNTRIES 115 V/230 V

FOR YOUR SAFETY

Units shipped to countries other than the above countries are equipped with an AC voltage selector switch on the rear panel. Refer to the following paragraph for the proper setting of this switch.

AC VOLTAGE SELECTION

This unit operates on 115/230 V AC. The AC voltage selector switch on the rear panel is set to the voltage that prevails in the area to which the unit is shipped. Before connecting the power cord to your AC outlet, make sure that the setting position of this switch matches your line voltage. If not, it must be set to your voltage in accordance with the following direction.

AC voltage selector switch

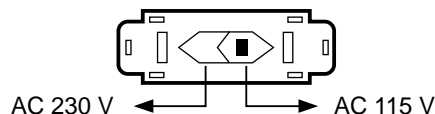

Move switch lever to match your line voltage with a small screwdriver or other pointed tool.

CONTENTS

Introduction	
• UNPACKING AND INSTALLATION.....	2
• READ THIS BEFORE OPERATING YOUR UNIT.....	3
System Connections.....	5
Front Panel Controls.....	8
DIGI LINK III System Remote Controls.....	9
• REMOTE CONTROL OPERATION RANGE.....	10
• LOADING BATTERIES.....	10
Operations	
• LISTENING TO A PROGRAM SOURCE.....	11
• SURROUND SOUND.....	14
• ENJOYING SURROUND SOUND.....	15
• LISTENING TO RADIO BROADCASTS.....	19
• RECORDING.....	21
• OTHER FUNCTIONS.....	22
Troubleshooting Guide.....	23
Specifications.....	24

System Connections

- When making system connections, please be certain the AC cord is not plugged into an AC outlet.
- When making connections between components, please be sure to connect the white RCA plugs to the L(left) and the red RCA plugs to the R(right) jacks respectively.
- Change the position of the FM indoor antenna until you get the best reception of your favorite FM stations.
- A 75 Ω outdoor FM antenna may be used to further improve the reception.
Disconnect the indoor antenna before replacing it with the outdoor one.
- Place the AM loop antenna as far as possible from the receiver, TV set, speaker cords and the AC input cord and set it to a direction for the best reception.
- If the reception is poor with the AM loop antenna, an AM outdoor antenna can be used in place of the AM loop antenna.
- Make connections firmly and correctly. If not, it can cause loss of sound, noise or damage to the receiver.
- If the electricity fails or the AC input cord is left unplugged for more than 2 weeks, the memorized contents will be cleared. Should this happen, memorize them again.

CONNECTING ANTENNAS

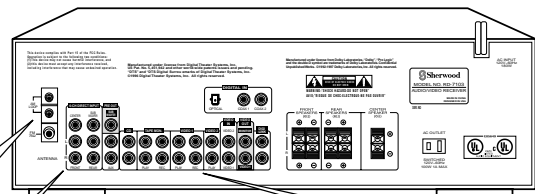
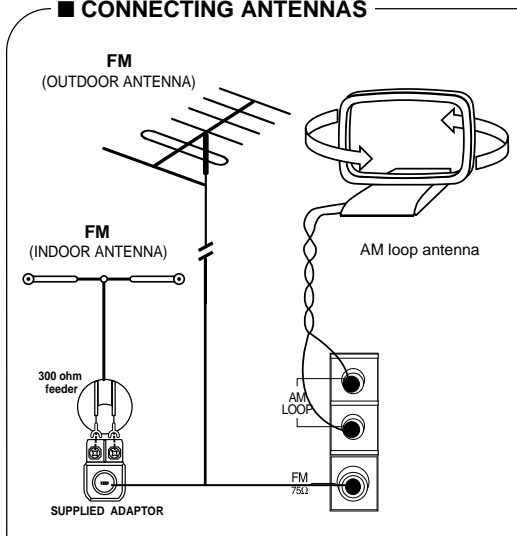

CONNECTING AUDIO/VIDEO COMPONENTS

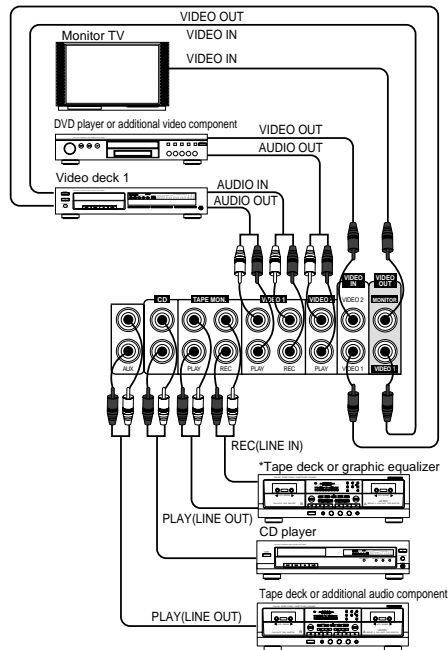

CONNECTING 6 CH DIRECT INPUTS

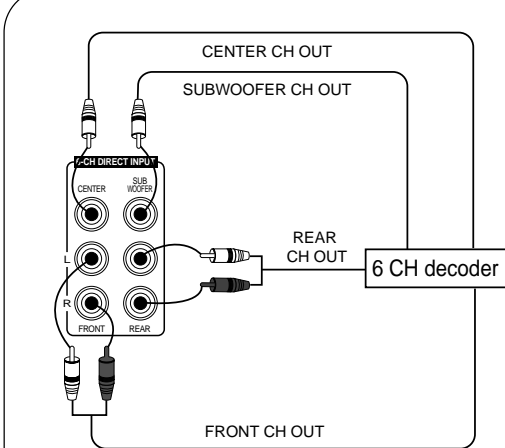

- Use these jacks to connect the corresponding analog outputs of 6 CH decoder or DVD player with 6 CH output for Dolby Digital or DTS, etc. (For details, see the operator's manual of the component to be connected.)

- The VIDEO 2 jacks may also be connected to an additional video component such as a cable TV tuner, an LD player or satellite system.
- The TAPE MONITOR PLAY/REC jacks may also be connected to the LINE OUT/IN jacks of an optional graphic equalizer.

■ Note : When Sherwood DVD player such as V-756, etc. is connected to the DIGI LINK jack for system control, you should connect the DVD player to the "VID 2" jacks of this unit. Then, when the "PLAY" function of the DVD player is engaged, the receiver will automatically select "VIDEO 2" as the input source and playback will start.

■ SUBWOOFER PRE OUT connection

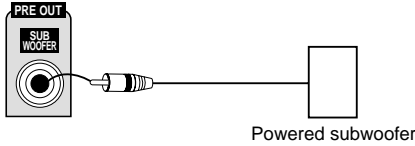

- To emphasize the deep bass sound, connect a powered subwoofer.

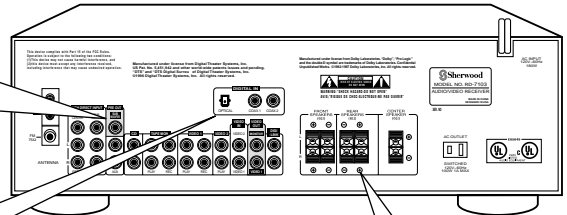

■ CONNECTING DIGITAL INPUTS

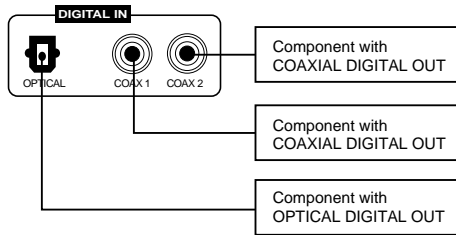

- The COAXIAL or the OPTICAL DIGITAL Out's of the components that are connected to CD, VIDEO 2 and VIDEO 3 of this unit can be connected to these DIGITAL INPUTS. □
- A digital input should be connected to the components such as a CD player, LD player, DVD player, etc. that are capable of outputting a signal in the DTS, Dolby Digital or PCM digital formats. □
- For details, please refer to the operating instructions of the component to be connected. □
- When making COAXIAL DIGITAL connections use 75 Ohm Cable. Do not use standard audio patch cords. □
- Not all of the commercially available Fiber Optic cables are suitable for use with this receiver. If you have a question as to the suitability of any cable, please check with your dealer or a qualified service organization. □
- Remove the protective cap before making nay OPTICAL connections. Reinsert the protective cap when not using the OPTICAL Jacks.

■ CONNECTING SPEAKERS

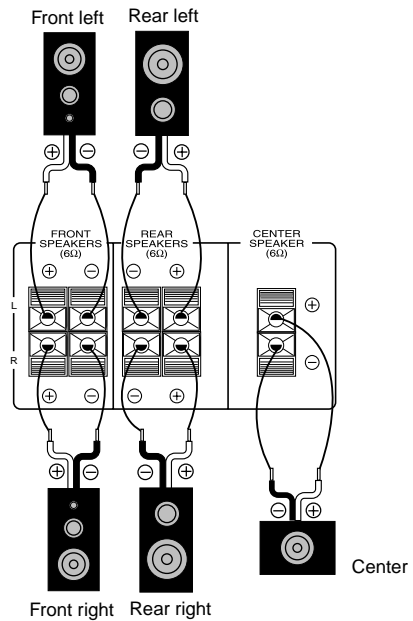

- The speaker terminals are designed to accept either bare wire or banana plugs. □
- If using bare wire, take care to not allow the + and - wires to touch or short. □
- Connect the speaker wires firmly and correctly according to the channel and position. Observe the proper polarity (+ and -). □
- This receiver is designed for use with speakers rated at 6 ohms impedance or above.

■ AC INPUT CORD

Plug this cord into an AC outlet.

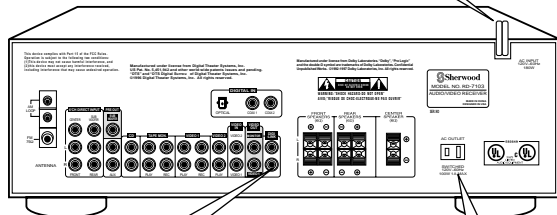

■ CONNECTING SYSTEM CONTROL

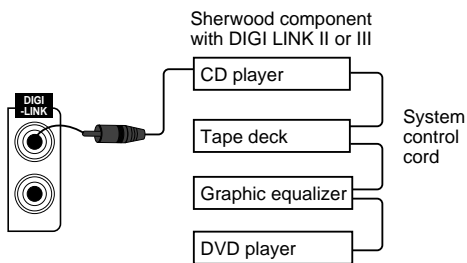

- Interconnect the GREEN system control jacks on compatible Sherwood components that use the DIGI LINK II or III system using standard RCA to RCA cables.

■ SWITCHED AC OUTLET

- This outlet is switched on(power-on mode) and off(standby mode) according to power controls as follows(Maximum total capacity is 1A, 100W): □

□ Standby mode – switched AC outlet off
 □ Power-on mode – switched AC outlet on

Front Panel Controls

ENGLISH

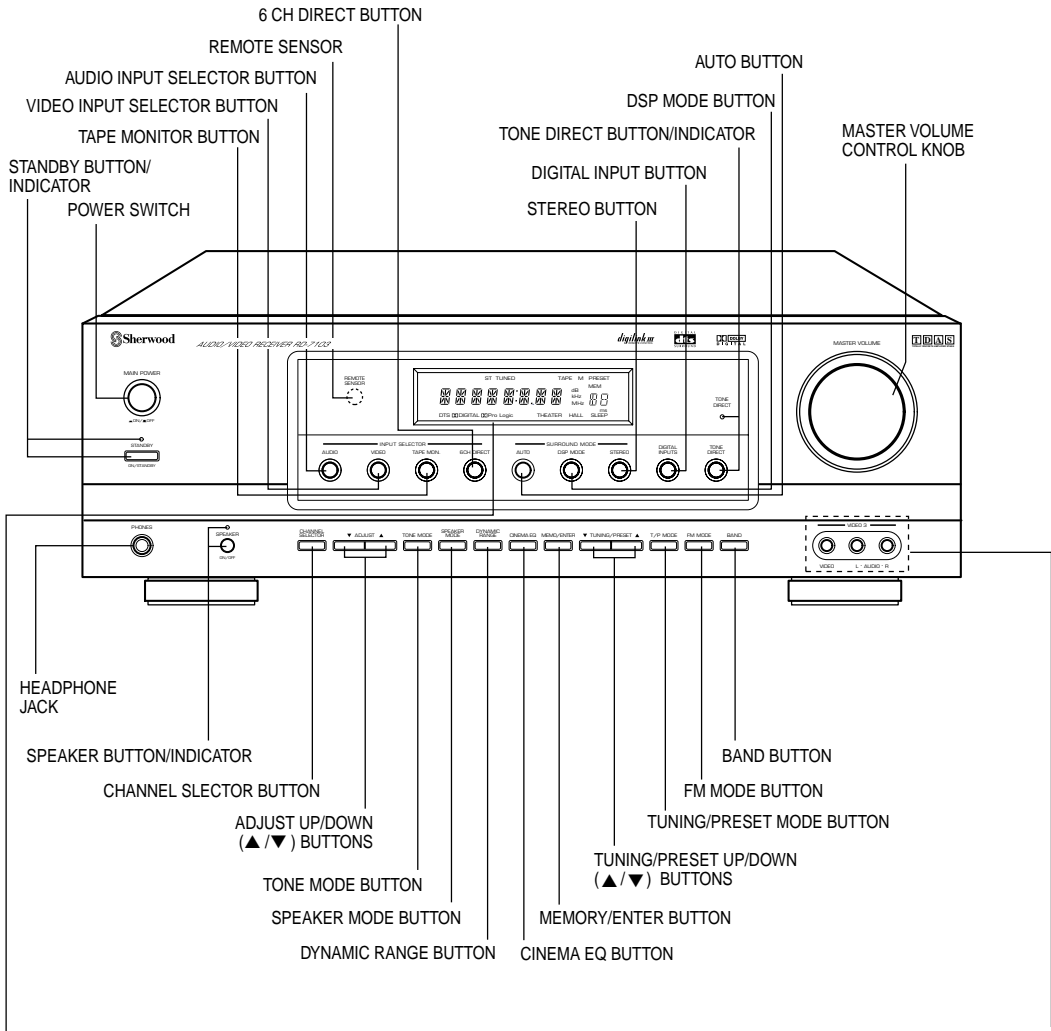

■ FLUORESCENT DISPLAY

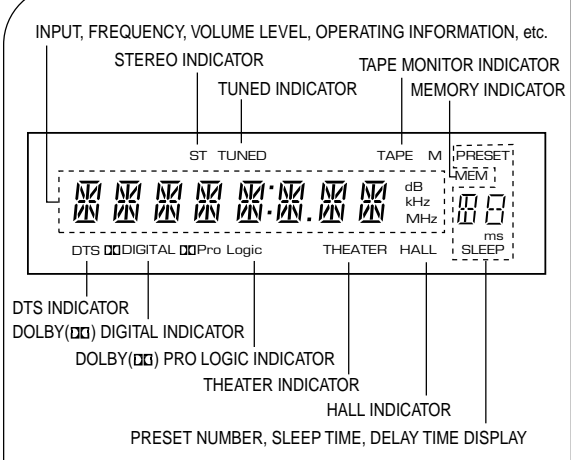

■ VIDEO 3 VIDEO/AUDIO INPUT JACKS

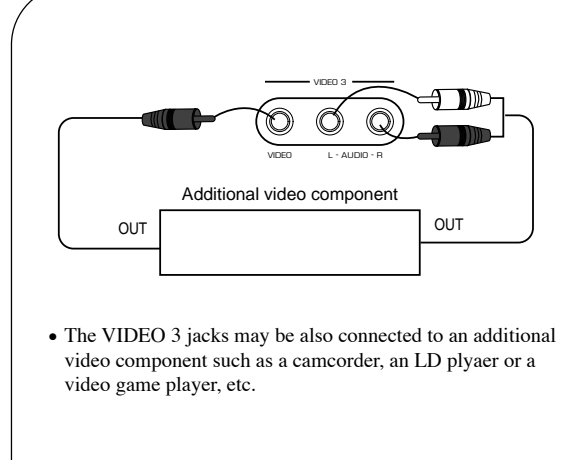

DIGI LINK III System Remote Controls

- All Sherwood components bearing the DIGI LINK (II or III) logo can be used with this remote control.
- To control associated Sherwood Digi Link components, you must first make the DIGI LINK connections between the components.
- With the Sherwood Digi Link III system, pressing a transport control key such as PLAY, on a Sherwood CD player or tape deck will automatically engage that input on the receiver and then PLAY will start.

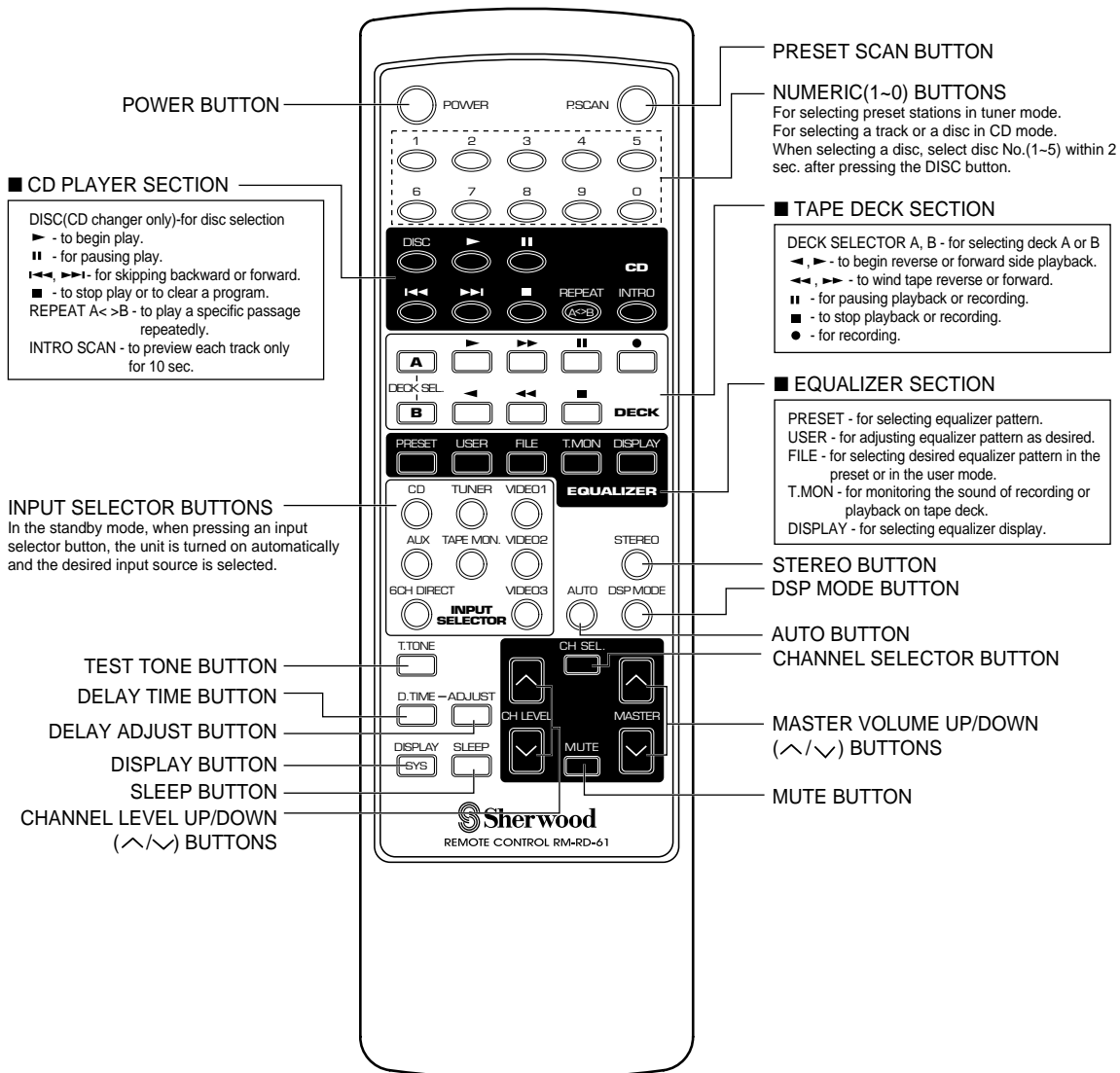

Notes:

- Some functions for a CD player, tape deck or equalizer may not be available.
- For details about functions, refer to the operating instructions of each component.

REMOTE CONTROL OPERATION RANGE

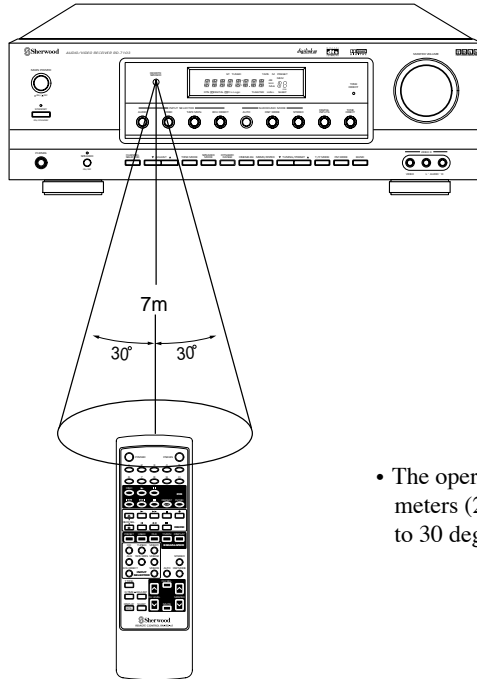

- The operating range of the remote control about 7 meters (23 feet) and it will operate at angles of up to 30 degrees. Aim at the remote sensor.

LOADING BATTERIES

1

Remove the cover.

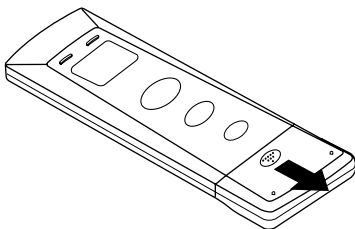

2

Load two batteries matching the polarity.

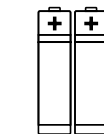

2 × 1.5V
("AAA" size)

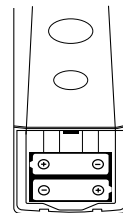

- Remove the batteries when they are not used for a long time.
- Do not use the rechargeable batteries (Ni-Cd type).

Operations

LISTENING TO A PROGRAM SOURCE

Before operation

- Enter the standby mode.



- The STANDBY indicator lights up. This means that the receiver is not disconnected from the AC mains and a small amount of current is retained to support the memorized contents and operation readiness.
- To switch the power completely off, push the POWER switch again.
- The power is cut off and the STANDBY indicator goes off.

1 In the standby mode, turn the power on.

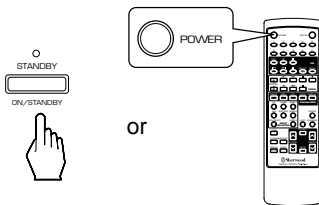

- Each time the STANDBY button on the front panel or the POWER button on the remote control is pressed, the receivers turns on to enter the operating mode or off to enter the standby mode.
- In the standby mode, if the INPUT SELECTOR button is pressed, the receiver turns on automatically and the desired input is selected.

2 Switch the speakers on.



- The SPEAKER indicator lights up and sound can be heard from the speakers connected to the speaker terminals.
- When using headphones for private listening, press the SPEAKER button again to switch the speakers off.

3 Select the desired input source.

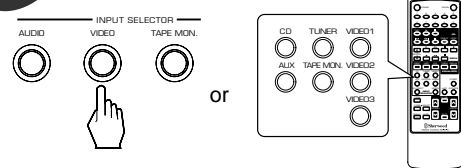

- Each time the “AUDIO” button is pressed, the input source changes as follows;
 - TUNER → CD → AUX (frequency display)
- Each time the “VIDEO” button is pressed, the input source changes as follows;
 - VIDEO 1 → VIDEO 2 → VIDEO 3
- When the TAPE MONITOR button is set to on so that “TAPE M” indicator lights up, other inputs can not be heard from the speakers. To listen to an input source other than TAPE MONITOR, be sure to set the TAPE MONITOR button to off.

TAPE MONITOR function

You can connect either a tape deck or a graphic equalizer to the receiver’s TAPE MONITOR jacks. To listen to the component connected to these jacks, set the TAPE MONITOR button to on. If you connect a 3-head tape deck, you can monitor the actual recording, not the source sound. For further details, refer to the operating instructions of the component connected.

- When selecting the 6 CH DIRECT as desired,

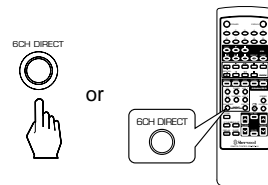

- 6-DIRECT is displayed and the 6 separate analog signals from a decoder or DVD player connected to this unit will be heard. You can use the tone controls and volume control to adjust the signal. (If the TAPE MONITOR button is set to on, it will be automatically set to off.)
- To cancel the 6 DIRECT function, press the 6 CH DIRECT button again or select another desired input source.
- These 6 separate analog signals can be heard, only. They cannot be recorded.

When CD or VIDEO1~3 is selected as an input source

4 Select the digital or analog input connected as desired.



- Each time this button is pressed, the corresponding input is selected as follows ;

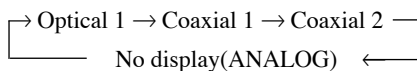

- To listen to a DTS or Dolby Digital program source in the 2-CH downmix mode(the stereo mode), the corresponding digital input must be selected. (For details, refer to “Downmixing into 2 front channels” on page 18.)

■ Notes :

- When the selected optical or coaxial digital input is not connected, the selected digital input display flickers, indicating the lack of sound. (Refer to “ENJOYING SURROUND SOUND” on page 15.)
- The sound from the component connected to the selected digital input can be heard regardless of the selected input source.

5 Operate the selected component for playback.

- To playback the program sources in surround sound, refer to “ENJOYING SURROUND SOUND” on page 15.

6 Adjust the (overall) volume.

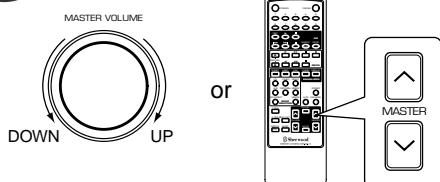

7 To compensate for edgy or shrill movie sound tracks.



- Then “CINEMA EQ ON” is displayed.
- Press it again to cancel, the “CINEMA EQ OFF” is displayed.

8 To mute the sound.

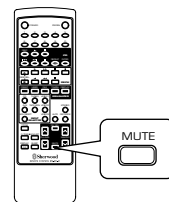

- “MUTE” will flicker.
- To resume the previous sound level, press it again.

9 To listen with the headphones.

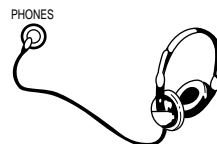

- Press the SPEAKER button to off.
- When listening to a DTS or Dolby Digital program source, if the headphones are plugged in and the SPEAKER button is set to off, the 2-CH downmix mode will be selected automatically. (For details, refer to “Downmixing into 2 front channels” on page 18.)

Adjusting the tone(bass and treble)

10 Enter the tone mode.



- Each time this button is pressed, the corresponding tone mode is selected and shown for 3 seconds as follows:

→ BASS → TRBL(treble)

- Note: When the TONE DIRECT indicator is lighting up, the tone mode cannot be entered.

11 At the desired tone mode, adjust the tone as desired.

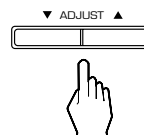

- If the tone display disappears, start from the step 10 again.
- Notes:
 - Extreme settings at high volume may damage your speakers.
 - In the DTS or Dolby Digital mode, the tone cannot be adjusted and the tone direct function is automatically switched to ON.

12 To listen to a program source without the tone effect.

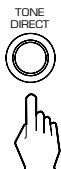

- The TONE DIRECT indicator lights up and the sound that bypasses the tone circuitry will be heard.
- To cancel the tone direct function, press this button again.

SURROUND SOUND

- This receiver incorporates a sophisticated Digital Signal Processor that allows you to create optimum sound quality and sound atmosphere in your personal Home Theater.

Surround modes

This unit has 6 different surround modes to allow you to enjoy surround sound with various program sources: DTS, DOLBY DIGITAL, DOLBY PRO LOGIC, DOLBY VIRTUAL, THEATER, HALL.

DTS (Digital Theater System) : Allows you to enjoy 5.1 (or 6) discrete channels of high quality digital audio from DTS program sources bearing the “” trademark such as laser discs, DVD,

compact discs, etc., DTS Digital Surround delivers up to 6 channels of transparent audio (which means identical to the original masters) and results in exceptional clarity throughout a true 360° sound field.

- Manufactured under license from Digital Theater Systems, Inc. US Pat. No. 5,451,942 and other world-wide patents issued and pending.
- “DTS” and “DTS Digital Surround” are trademarks of Digital Theater Systems, Inc.
- © 1996 Digital Theater Systems, Inc. All rights reserved.

Note : The DTS program sources should be played back in the DTS mode. If not, no sound or the sound like continuous noise will be heard.

DOLBY DIGITAL : Allows you to enjoy up to 5.1 channels of digital surround sound from Dolby Digital program sources bearing the “” trademark such as laser discs, DVD's, and DTV broadcasts.

Dolby Digital provides better sound quality, improved dynamic range and greater sense of direction, compared with conventional Dolby surround. Now, you are able to enjoy real Home Theater sound in your home.

DOLBY PRO LOGIC : This unit incorporates the Dolby Pro Logic Surround Decoder which performs the same functions for home playback as it does in the movie theaters. Use with Dolby Pro Logic program sources bearing the “” trademark such as video cassette tapes, laser discs or TV broadcasts.

DOLBY VIRTUAL : Dolby Virtual employs sophisticated digital processing to create the illusion of five “phantom” speakers. Therefore, this mode allows you to experience a realistic multichannel experience from any program source, through just a single pair of front speakers.

- Manufactured under license from Dolby Laboratories. “Dolby”, “Pro Logic” and the double-D symbol are trademarks of Dolby Laboratories. Confidential Unpublished Works. © 1992-1997 Dolby Laboratories. All rights reserved.

THEATER : This mode provides the effect of being in a movie theater when watching a movie source that has a stereo sound track.

HALL : This mode provides the ambience of a concert hall for classical music sources such as orchestral, chamber music or an instrumental solo.

- When the 6 CH DIRECT INPUTS are connected to a 6 CH decoder or DVD player for a surround sound such as Dolby Digital or DTS, etc., you can enjoy the corresponding surround sound, too. (For details, see the operator's manual of the component to be connected.)

Delay time

When the center speaker or the rear speakers is(are) closer to the listener than the front speakers, the sound from the center speaker or the rear speakers can arrive at the listener's ears earlier than the sound from the front speakers.

In this case, the imaging is not as sharp and stable as it could be.

For audible improvement, the sound from center speaker can be delayed with the center delay time setting to synchronize the sound from the front and the center speakers and the sound from the rear speakers can be also delayed with the rear delay time setting so that the sound from the front and the rear speakers will be heard at the same time.

The optimum delay time will be different according to the room size and the acoustic properties.

- It is adjustable in the surround modes except for the normal stereo mode. (For details, refer to “In the surround modes except for the DTS, normal stereo and Dolby Virtual modes, adjusting delay times of the speakers” on page 18)

Speaker placement

To obtain the best surround sound effect in your home, place the speakers as follows:

- Front speakers: Place each front speaker about 1m (40") from the TV set.
 - Center speaker: Place the center speaker either above or below the TV set to assure good visualization of center channel program.
 - Rear speakers: Place the rear speakers approximately 1m above the ear level of a seated listener on the direct left and right of them or slightly behind.
 - Subwoofer: Reproduces powerful deep bass sounds. Place a powered subwoofer anywhere in the front as desired.
 - The ideal surround system needs all the speakers listed above.
- For optimum reproduction of DTS encoded material, DTS suggests that all speakers, front, center and rear, should be capable of full range reproduction.
- To enjoy surround sound best, the speakers to be connected are as follows;

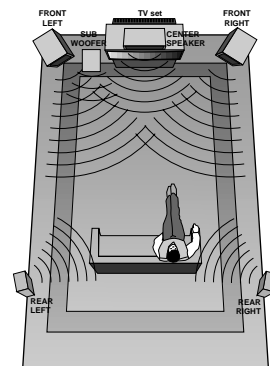

Modes	DTS	Dolby Digital	Dolby Pro Logic	Dolby Virtual	Other Surround	Stereo	6 CH DIRECT
Front	Yes	Yes	Yes	Yes	Yes	Yes	Yes
Center	Yes	Yes	Yes	-	Yes	-	Yes
Rear	Yes	Yes	Yes	-	Yes	-	Yes
Subwoofer	Yes	Yes	Optional	-	Optional	Optional	Yes

Note: To avoid interference with the TV picture, use only magnetically shielded center and front speakers.

ENJOYING SURROUND SOUND

- Surround sound effect will not work properly if the signal passes through a graphic equalizer. Please refer to your equalizer operating instructions for guidance on switching off (or defeating) the equalizer.

1

Select the desired surround mode.

- When selecting the DTS or Dolby Surround mode.

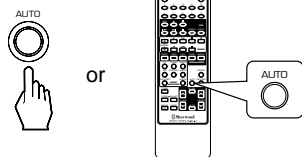

- When playing program sources bearing the “”, “” or “” trademark such as video, DVD or LD software, the DTS, Dolby Digital or Dolby Pro Logic mode is automatically selected according to the input signal.
- When playing Dolby Digital program sources encoded into the 2 channel format, the Dolby Pro Logic mode or the Dolby Digital mode is automatically selected according to the encoding process. (In case the Dolby Digital mode is automatically selected, pressing the AUTO button allows this unit to be switched to the Dolby Pro Logic mode.)
- To enjoy the DTS or Dolby Digital mode, be sure that the program source and the corresponding digital input are selected correctly. If not, no sound will be heard.

- When selecting a surround mode among THEATER, HALL and DOLBY VIRTUAL modes.

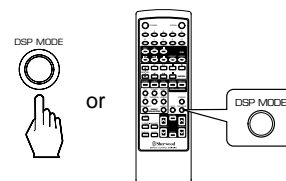

- Each time the DSP MODE button is pressed, the surround mode changes as follows;

→ THEATER → HALL → DOLBY VIRTUAL

- Playing DTS or Dolby Surround program sources (bearing the “”, “” or the “” trademark) in THEATER or HALL mode will produce better surround effects.
- When the 6 CH DIRECT is selected as an input source, the surround mode cannot be selected.

- To cancel the surround mode for normal stereo operation.

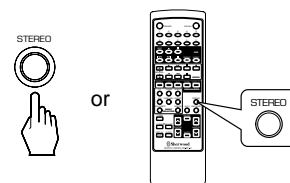

Adjusting the speaker settings

- Adjust the settings of front, center, rear speakers and subwoofer connected.
- If the speaker setting is adjusted to “S”, the low range bass sound of the channel(s) is redirected to the subwoofer or the front channels and if the speaker setting is adjusted to “N”, the sound of the channel(s) is redirected to other channels.

- 2** Press the SPEAKER MODE button for more than 2 seconds to enter the front-center-rear speaker mode.



- The front-center-rear speaker setting is displayed.
- When the SPEAKER button is set to off, the 6 CH DIRECT is selected as an input source or “ANALOG” is selected as signal input in the stereo mode, the speaker mode function cannot be available.

- 3** Select the desired speaker setting.



- Each time this button is pressed, one of 11 different speaker settings is selected and displayed for 8 seconds as follows;
FL--CS--RS, FL--CL--RS, FL--CL--RL, FL--CL--RN, FL--CS--RL, FL--CN--RL, FL--CS--RN, FL--CN--RS, FS--CS--RS, FS--CS--RN and FS--CN--RS
- In the displays, F stands for Front, C for Center, R for Rear, L for Large, S for Small and N for None.
- When judging whether a speaker is Large or Small, please note that a standard large speaker has a cone size larger than 12 cm(5 inches).
- The following speaker settings cannot be selected. Front :Small, Center : Large and Rear : Large(FS--CL--RL) or Center : None and Rear : None(CN--RN) setting.

- 4** Memorize the desired speaker setting while it is displayed.



- The desired speaker setting is memorized and the receiver enters the subwoofer mode.
- If the speaker setting display disappears, start again from step 2 above.

- 5** Select the desired subwoofer setting.



- Each time this button is pressed, the subwoofer setting changes and is displayed for 8 seconds as follows;
SUB W(oofer) -- Y(es): When using a powered subwoofer.
↓
SUB W(oofer) -- N(o) : When not using a powered subwoofer.
- If the front speaker is set to “S”, the subwoofer is automatically set to “Y”.

- 6** Memorize the subwoofer setting while it is displayed.



- If the subwoofer setting display disappears, start again from step 2 above.

Checking the speaker setting



- Each time this button is pressed briefly, the front-center-rear speaker or subwoofer setting is displayed.

Adjusting each channel level

7 Select the desired channel.

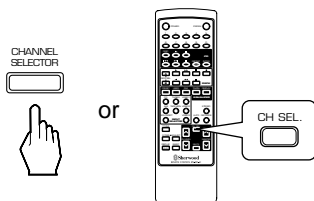

- Each time this button is pressed, the corresponding channel is selected and displayed for 3 seconds as follows;

→ Front Left → Center → Front Right
 └─ SubWoofers ← Rear Left ← Rear Right ←

- When it is in the normal stereo or Dolby Virtual mode, or the speaker setting is “N”, center, rear or subwoofer channel will not be selected.

8 Adjust the level of the selected channel as desired.

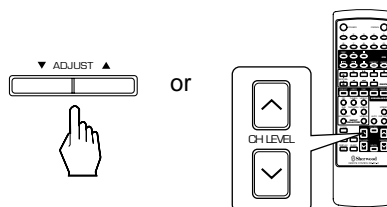

- If the channel display disappears, start from the above step 7 again.

9 Repeat the above steps 7 and 8 to adjust the other channel levels.

In Dolby Digital or Dolby Pro Logic

- In these modes, the volume level of each channel can be adjusted easily with the test tone function.

10 Enter the test tone mode.

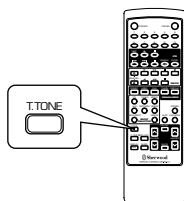

- The test tone will be heard from the speaker of each channel for 2 seconds as follows;

→ Front Left → Center → Front Right
 └─ SUBwoofer ← Rear Left ← Rear Right ←

- Speakers set to “N” are not available and will not be heard.

11 Repeat steps 7 to 9 in “Adjusting each channel level” until the sound level of each speaker is heard to be equally loud.

12 Cancel the test tone function.

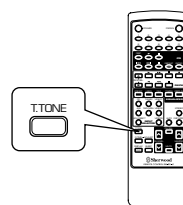

In the surround modes except for the DTS, normal stereo and Dolby Virtual modes,

- When the distances from the prime listening position to front left, center, front right, rear left and rear right speakers are same, the basic settings are as follows according to the surround modes:
-In the Dolby Digital mode
Center delay time : 0 ms, Rear delay time : 0 ms
-In the Dolby Pro Logic, Theater and Hall modes
Rear delay time : 15 ms
- If the center or the rear speaker(s) is(are) not at the same distance from the prime listening position as the front speakers, increase or decrease the center delay time by 1 ms for every about 30 cm(1 foot) it is closer or farther away and increase or decrease the rear delay time by 5 ms for every about 1~1.5 m(3~5 feet) it is closer or farther away.

13 Check the delay time to be adjusted.

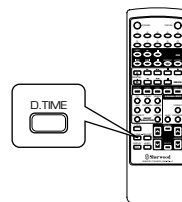

- The delay time will be displayed for 5 seconds.
- Only in the Dolby Digital mode, the center delay time can be adjusted and the corresponding delay time is displayed.
- In case of playing the Dolby Digital program sources in the Theater or Hall mode, the center delay time as well as the rear delay time can be adjusted as they are done in the Dolby Digital mode.

14 Adjust the delay time.

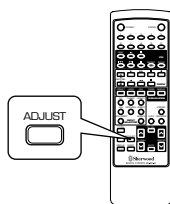

- Each time this button is pressed, the delay time changes in regular intervals.
- If the delay time disappears, start from the step 13 again.

15 In Dolby Digital mode, repeat the above steps 13 and 14 to adjust the rear delay time.

Downmixing into 2 front channels

- Allows the multi-channel DTS or Dolby Digital signal to be reproduced through only two speakers or through headphones.
- When playing the DTS or Dolby Digital program sources, press the STEREO button.

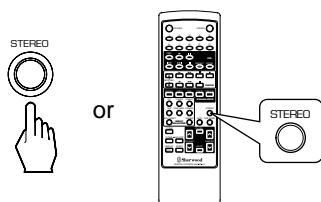

- “ST” and the DTS or Dolby Digital indicators light up, meaning it enters the 2-CH downmix mode, and then the 5 discrete channels(front L, center, front R, rear L and rear R) are mixed down into 2 front channels.

- To cancel the 2-CH downmix mode, select the desired surround mode.
- When play is stopped, interrupted, etc., the 2-CH downmix mode is not canceled even though “ST” and the DTS or Dolby Digital indicators go off.
- If the headphones are plugged and the SPEAKER button is set to off while playing the DTS and Dolby Digital program sources, it will enter the 2-CH downmix mode automatically(but only the DTS or Dolby Digital indicator lights up still) and if the headphones are unplugged and the SPEAKER button is set to on in the 2-CH downmix mode, it will return to the previous mode.

LISTENING TO RADIO BROADCASTS

Auto tuning

1

Select the tuner.

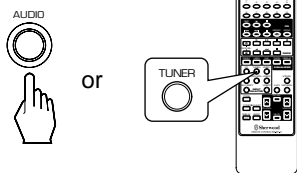

2

Select the desired band.

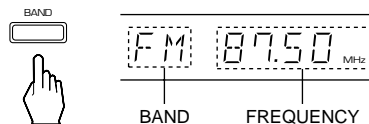

- Each time this button is pressed, the band is changed to FM or AM.
- When pressing the BAND button without first selecting the TUNER, the tuner will be selected automatically.

3

Select the tuning mode.



- Each time this button is pressed, the mode changes as follows;

Tuning mode : "PRESET" goes off.
Preset mode : "PRESET" lights up.

4

Press the TUNING/PRESET UP(▲) or DOWN(▼) button for more than 0.5 second.

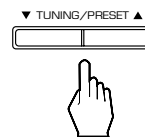

- The tuner will now search until a station of sufficient strength has been found. The display shows the tuned frequency and "TUNED".
- If the station found is not the desired one, simply repeat this operation.
- Weak stations are skipped during auto tuning.

Manual tuning

- Manual tuning is useful when you already know the frequency of the desired station.
- Perform the steps 1 to 3 in "Auto tuning" procedure and press the TUNING/PRESET UP(▲) or DOWN(▼) button repeatedly until the right frequency has been reached.

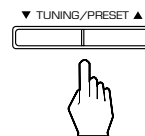

Presetting radio stations

- You can store up to 30 preferred stations in the memory.

1

Tune in the desired station with auto or manual tuning.

2

Press the MEMORY/ENTER button.

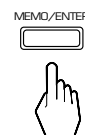

- "MEM" flickers for 5 seconds.

3 Select the desired preset number (1~30) and press the MEMORY/ENTER button.

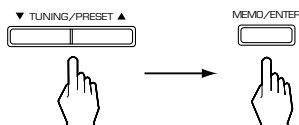

- When using the NUMERIC buttons on the remote control. Examples)

For “3” : within 2 seconds

For “15” : within 2 seconds

- The station has now been stored in the memory.
- When using the NUMERIC buttons, the station is stored automatically without pressing the MEMORY/ENTER button.
- A stored frequency is erased from the memory by storing another frequency in its place.
- If “MEM” goes off, start again from step 2 above.

4 Repeat the above steps 1 to 3 to memorize other stations.

MEMORY BACKUP FUNCTION

The following items, set before the receiver is turned off, are memorized.

- INPUT SELECTOR settings
- Surround mode settings
- Preset stations, etc.

Note : If the electricity fails or the AC input cord is disconnected for more than 2 weeks, all memorized functions will be lost. Please enter them into memory, again.

Tuning to preset stations

1 After selecting the tuner as an input source, select the preset tuning mode.



- Then “PRESET” lights up.

2 Select the desired preset number.

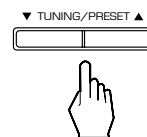

- When using the NUMERIC buttons on the remote control. Examples)

For “3” : within 2 seconds

For “15” : within 2 seconds

- When selecting the desired preset number with the NUMERIC buttons, the desired preset station will be tuned to automatically without first selecting the preset tuning mode.

Listening to FM stereo broadcasts

- While listening to FM broadcasts.



- Each time this button is pressed, the FM mode changes as follows;

↳ Stereo mode : “ST” lights up. ↳
 ↳ Mono mode : “ST” goes off. ↳

- When FM stereo broadcasts are poor because of weak broadcast signals, select the FM mono mode to reduce the noise, FM broadcasts are then reproduced in monaural sound.

Scanning preset stations in sequence

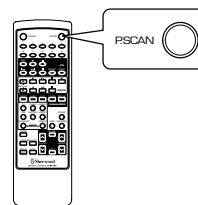

- The receiver will start scanning the stations in the preset sequence and each station is received for 5 seconds.
- At the desired station, press this button again to stop scanning.

RECORDING

- The analog signals from the 6 CH DIRECT inputs as well as the digital signals from the coaxial or optical digital input can be heard but cannot be recorded.
- The volume and tone (bass, treble) settings have no effect on the recording signals.

Recording with TAPE MONITOR

- 1 Select the desired input as a recording source except for TAPE MONITOR.

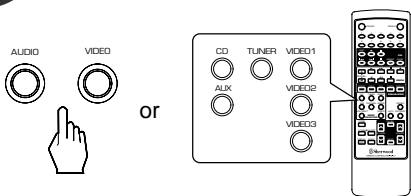

- Be sure that "TAPE M" goes off.

- 2 Start recording on component connected to the TAPE MONITOR.

- 3 Start play on the desired input.

- For tape monitor function, refer to "TAPE MONITOR function" on page 11.

Dubbing from video components onto VIDEO 1

- 1 Select VIDEO 2 or VIDEO 3 as a recording source.

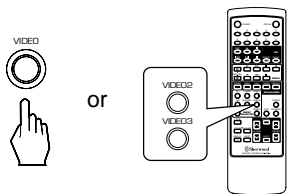

- 2 Start recording on the VIDEO 1.

- 3 Start play on the VIDEO 2 or the VIDEO 3.

- The audio and video signals from the VIDEO 2 or the VIDEO 3 will be dubbed onto the VIDEO 1 and you can enjoy them on the TV set and from the speakers.

Dubbing the audio and video signals separately onto VIDEO 1

Example) When dubbing the VIDEO 2 video signal and the CD audio signal separately onto VIDEO 1.

- 1 Select VIDEO 2 as a video recording source.

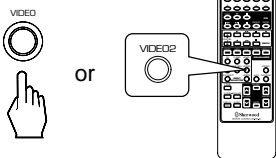

- 2 Select CD as an audio recording source.

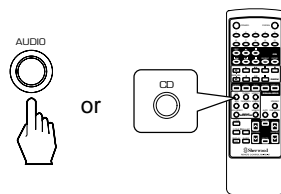

3

Start recording on the VIDEO 1.

4

Start play on the VIDEO 2 and the CD respectively.

- The audio signal from the CD and the video signal from the VIDEO 2 will be dubbed and you can enjoy them on the TV set and from the speakers.

Note : Be sure to observe the order of the above steps 1 and 2.

OTHER FUNCTIONS

Compressing the dynamic range (Dolby Digital mode only)

- This function compresses the dynamic range of previously specified parts of the Dolby Digital sound track (with extremely high volume) to minimize the difference in volume between the specified and non-specified parts. This makes it easy to hear all of the sound track when watching movies at night at low levels.



- Each time this button is pressed, the mode changes and disappears in 3 seconds as follows:

↓
DYNAMIC 0.0 : Off
↓
DYNAMIC 0.5 : Low compression
↓
DYNAMIC 1.0 : High compression

- In some Dolby Digital software, this function may not be available.

Operating the sleep timer

- The sleep timer allows the system to continue to operate for a specified period of time before automatically shutting off.
- To set the receiver to automatically turn off after the specified period of time.

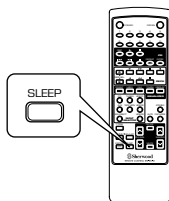

- Each time this button is pressed, the sleep time changes and disappears in 3 seconds as follows;

→ 10 → 20 → 30 → 60 → 90 → OFF
Unit : minutes

- While operating the sleep timer, "SLEEP" lights up.
- When the sleep time is selected, all display panels of Sherwood components connected by the DIGI LINK III are dimly lit.

Adjusting the brightness of the fluorescent displays

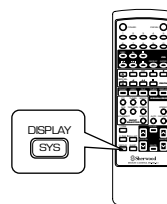

- Each time this button is pressed, the brightness of all fluorescent displays of Sherwood components connected by the DIGI LINK III changes together as follows;

→ ON → dim → OFF

- In the display OFF mode, pressing any button will restore the display ON mode.

Troubleshooting Guide

If a fault occurs, run through the table below before taking your receiver for repair.

If the fault persists, attempt to solve it by switching the receiver off and on again. If this fails to resolve the situation, consult your dealer. Under no circumstances should you attempt to repair the receiver yourself. This could void the warranty.

PROBLEM	POSSIBLE CAUSE	REMEDY
No power	<ul style="list-style-type: none"> The AC input cord is disconnected. Poor connection at AC wall outlet or the outlet is dead or off. 	<ul style="list-style-type: none"> Connect the cord securely. Check the outlet using a lamp or another appliance.
No sound	<ul style="list-style-type: none"> The speaker wires are disconnected. The master volume is adjusted too low. The MUTE button on the remote control is pressed to ON. Speakers are not switched on. Incorrect selection of the input source. Incorrect connections between the components. 	<ul style="list-style-type: none"> Check the speaker connections. Adjust the master volume. Press the MUTE button to cancel the muting effect. Press the SPEAKER button to ON. Select the desired input source correctly. Make connections correctly.
No sound from the rear speakers	<ul style="list-style-type: none"> Surround mode is switched off(normal stereo mode). Master volume and rear level are too low. A monaural source is used. Rear speaker setting is "N". 	<ul style="list-style-type: none"> Select a surround mode. Adjust master volume and rear level. Select a stereo or surround source. Select the desired rear speaker setting.
No sound from the center speaker	<ul style="list-style-type: none"> Surround mode is switched off(normal stereo mode). Center speaker setting is "N". Master volume and center level are too low. 	<ul style="list-style-type: none"> Select the desired surround. Select the desired center speaker setting. Adjust master volume and center level.
Stations cannot be received	<ul style="list-style-type: none"> No antenna is connected. The desired station frequency is not tuned in. The antenna is in wrong position. 	<ul style="list-style-type: none"> Connect an antenna. Tune in the desired station frequency. Move the antenna and retry tuning.
Preset stations cannot be received	<ul style="list-style-type: none"> An incorrect station frequency has been memorized. The memorized stations are cleared. 	<ul style="list-style-type: none"> Memorize the correct station frequency. Memorize the stations again.
Poor FM reception	<ul style="list-style-type: none"> No antenna is connected. The antenna is not positioned for the best reception. 	<ul style="list-style-type: none"> Connect an antenna. Change the position of the antenna.
Continuous hissing noise during FM reception, especially when a stereo broadcast is received.	<ul style="list-style-type: none"> Weak signals. 	<ul style="list-style-type: none"> Change the position of the antenna. Install an outdoor antenna.
Continuous or intermittent hissing noise during AM reception, especially at night.	<ul style="list-style-type: none"> Noise is caused by motors, fluorescent lamps or lightning, etc. 	<ul style="list-style-type: none"> Keep the receiver away from noise sources. Install an outdoor AM antenna.
Remote control unit does not operate.	<ul style="list-style-type: none"> Batteries are not loaded or exhausted. The remote sensor is obstructed. 	<ul style="list-style-type: none"> Replace the batteries. Remove the obstacle.
Other system components do not react to remote control commands.	<ul style="list-style-type: none"> DIGI LINK connections are not made properly. 	<ul style="list-style-type: none"> Make proper DIGI LINK connections.

Specifications

■ AMPLIFIER SECTION

- Power output, stereo mode, 6 Ω , THD 0.2%, 40 Hz~20 kHz 2 x 100
- Total harmonic distortion, 6 Ω , 95 W, 1 kHz 0.09 %
- Intermodulation distortion
60 Hz : 7 kHz= 4 : 1 SMPTE, 6 Ω , 95 W 0.1 %
- Input sensitivity, 47 k Ω
Line (CD, TAPE, VIDEO) 200 mV
- Signal to noise ratio, IHF "A" weighted
Line (CD, TAPE, VIDEO) 92 dB
- Frequency response
Line (CD, TAPE, VIDEO), 20 Hz~50 kHz +0 dB, -3 dB
- Output level
TAPE REC, 2.2 k Ω 200 mV
PRE OUT(Front, Center, Rear, Subwoofer), 1 k Ω 1.0 V
- Bass/Treble control, 100 Hz/10 kHz ± 10 dB
- Surround mode, only channel driven
Front power output, 6 Ω , 1 kHz, THD 0.7 % 125 W / 125 W
Center power output, 6 Ω , 1 kHz, THD 0.7 % 125 W
Rear power output, 6 Ω , 1 kHz, THD 0.7 % 125 W / 125 W

■ DIGITAL AUDIO SECTION

- Sampling frequency 32, 44.1, 48 kHz
- Digital input level
Coaxial, 75 Ω 0.5 Vp-p
Optical, 660 nm -15~-21 dBm

■ FM TUNER SECTION

- Tuning frequency range 87.5~108 MHz
- Usable sensitivity, THD 3%, S/N 30 dB 12.8 dBf
- 50 dB quieting sensitivity, mono/stereo 20.2/45.3 dBf
- Signal to noise ratio, 65 dBf, mono/stereo 70/65 dB
- Total harmonic distortion, 65 dBf, 1 kHz, mono/stereo 0.5/0.8 %
- Frequency response, 30 Hz~15 kHz ± 3 dB
- Stereo separation, 1 kHz 42 dB
- Capture ratio 4 dB
- IF rejection ratio 80 dB

■ AM TUNER SECTION

- Tuning frequency range 520~1710 kHz
- Usable sensitivity 500 μ V/m
- Signal to noise ratio, 80 dB/m 40 dB
- Selectivity 25 dB

■ GENERAL

- Power supply AC 120 V, 60 Hz
- Power consumption 200 W
- Switched AC outlet TOTAL 1 A, 100 W max.
- Dimensions (W \times H \times D) 440 \times 141 \times 330 mm(17-3/8 \times 5-1/2 \times 13 inches)
- Weight (Net) 9.6 kg(21.2 lbs)

Note: Design and specifications are subject to change without notice for improvements.

O P E R A T I N G I N S T R U C T I O N S



RD-7103
AUDIO/VIDEO RECEIVER

5707-04734-001-0

Free Manuals Download Website

<http://myh66.com>

<http://usermanuals.us>

<http://www.somanuals.com>

<http://www.4manuals.cc>

<http://www.manual-lib.com>

<http://www.404manual.com>

<http://www.luxmanual.com>

<http://aubethermostatmanual.com>

Golf course search by state

<http://golfingnear.com>

Email search by domain

<http://emailbydomain.com>

Auto manuals search

<http://auto.somanuals.com>

TV manuals search

<http://tv.somanuals.com>