

OPERATING INSTRUCTIONS

RD-7503
Audio/Video Receiver

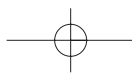
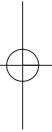

IMPORTANT SAFETY INSTRUCTIONS

1. Read these instructions.
2. Keep these instructions.
3. Heed all warnings.
4. Follow all instructions.
5. Do not use this apparatus near water.
6. Clean only with dry cloth.
7. Do not block any ventilation openings.
Install in accordance with the manufacturer's instructions.
8. Do not install near any heat sources such as radiators, heat registers, stoves, or other apparatus (including amplifiers) that produce heat.
9. Do not defeat the safety purpose of the polarized or grounding-type plug. A polarized plug has two blades with one wider than the other.
A grounding type plug has two blades and a third grounding prong. The wide blade or the third prong are provided for your safety. If the provided plug does not fit into your outlet, consult an electrician for replacement of the obsolete outlet.
10. Protect the power cord from being walked on or pinched particularly at plugs, convenience receptacles, and the point where they exit from the apparatus.
11. Only use attachments accessories specified by the manufacturer.

12. Use only with the cart, stand, tripod, bracket, or table specified by the manufacturer, or sold with the apparatus.
When a cart is used, use caution when moving the cart/apparatus combination to avoid injury from tip-over.



PORTABLE CART WARNING

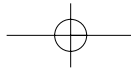

13. Unplug this apparatus during lightning storms or when unused for long periods of time.
14. Refer all servicing to qualified service personnel.
Servicing is required when the apparatus has been damaged in any way, such as power-supply cord or plug is damaged, liquid has been spilled or objects have fallen into the apparatus, the apparatus have been exposed to rain or moisture, does not operate normally, or has been dropped.



Introduction

READ THIS BEFORE OPERATING YOUR UNIT

	CAUTION <small>RISK OF ELECTRIC SHOCK DO NOT OPEN</small>	
CAUTION : TO REDUCE THE RISK OF ELECTRIC SHOCK, DO NOT REMOVE COVER (OR BACK). NO USER-SERVICEABLE PARTS INSIDE. REFER SERVICING TO QUALIFIED SERVICE PERSONNEL.		

	This symbol is intended to alert the user to the presence of uninsulated "dangerous voltage" within the product's enclosure that may be of sufficient magnitude to constitute a risk of electric shock to persons.
	This symbol is intended to alert the user to the presence of important operating and maintenance (servicing) instructions in the literature accompanying the appliance.

WARNING : TO REDUCE THE RISK OF FIRE OR ELECTRIC SHOCK,
DO NOT EXPOSE THIS APPLIANCE TO RAIN OR MOISTURE.

Caution regarding installation

Note : For heat dispersal, do not install this unit in a confined space such as a bookcase or similar enclosure.

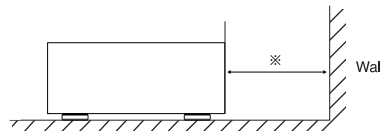
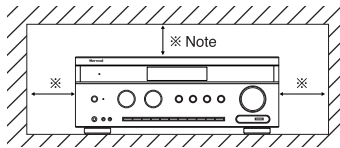

Do not block ventilation openings or stack other equipment on the top.

Note to CATV System Installer :

This reminder is provided to call the CATV system installer's attention to Article 820-40 of the NEC that provides guidelines for proper grounding and, in particular, specifies that the cable ground shall be connected to the grounding system of the building, as close to the point of cable entry as practical.

FCC INFORMATION

This equipment has been tested and found to comply with the limits for a Class B digital device, pursuant to Part 15 of the FCC Rules. These limits are designed to provide reasonable protection against harmful interference in a residential installation. This equipment generates, uses and can radiate radio frequency energy and, if not installed and used in accordance with the instructions, may cause harmful interference to radio communications. However, there is no guarantee that interference will not occur in a particular installation. If this equipment does cause harmful interference to radio or television reception, which can be determined by turning the equipment off and on, the user is encouraged to try to correct the interference by one or more of the following measures:

- Reorient or relocate the receiving antenna.
- Increase the separation between the equipment and receiver.
- Connect the equipment into an outlet on a circuit different from that to which the receiver is connected.
- Consult the dealer or an experienced radio/TV technician for help.

Caution : Any changes or modifications in construction of this device which are not expressly approved by the party responsible for compliance could void the user's authority to operate the equipment.

This Class B digital apparatus complies with Canadian ICES-003.

Cet appareil numérique de la Classe B est conforme à la norme NMB-003 du Canada.

FOR YOUR SAFETY

U.S.A
CANADA

120 V

Units shipped to the U.S.A and CANADA are designed for operation on 120 V AC only.

Safety precaution with use of a polarized AC plug.

However, some products may be supplied with a nonpolarized plug.

CAUTION : To prevent electric shock, match wide blade of plug to wide slot, fully insert.

ATTENTION : Pour éviter chocs électriques, introduire la lame la plus large de la fiche dans la borne correspondante de la prise et pousser jusqu' au fond.



ENERGY STAR® is a U.S. registered mark. As an ENERGY STAR® Partner, Sherwood has determined that this product meets the ENERGY STAR® guidelines for energy efficiency.

CAUTION

- Leave a space around the unit for sufficient ventilation.
- Avoid installation in extremely hot or cold locations, or in an area that is exposed to direct sunlight or heating equipment.
- Keep the unit free from moisture, water, and dust.
- Do not let foreign objects in the unit.
- The ventilation should not be impeded by covering the ventilation openings with items, such as newspapers, table-cloths, curtains, etc.
- No naked flame sources, such as lighted candles, should be placed on the unit.
- Please be care the environmental aspects of battery disposal.
- The unit shall not be exposed to dripping or splashing for use.
- No objects filled with liquids, such as vases, shall be placed on the unit.
- Do not let insecticides, benzene, and thinner come in contact with the set.
- Never disassemble or modify the unit in any way.
 - Notes on the AC power cord and the wall outlet.
- The unit is not disconnected from the AC power source(mains) as long as it is connected to the wall outlet, even if the unit has been turned off.
- To completely disconnect this product from the mains, disconnect the plug from the wall socket outlet.
- When setting up this product, make sure that the AC outlet you are using is easily acceptable.
- Disconnect the plug from the wall outlet when not using the unit for long periods of time.

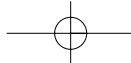

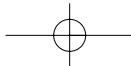

CONTENTS

ENGLISH

- **IMPORTANT SAFETY INSTRUCTIONS** 2
- **Introduction**
 - READ THIS BEFORE OPERATING YOUR UNIT 3
- **System Connections** 5
- **Front Panel Controls** 13
- **Universal Remote Controls** 15
 - OPERATING COMPONENTS WITH REMOTE CONTROL 17
 - REMOTE CONTROL OPERATION RANGE 17
 - LOADING BATTERIES 17
 - USING FUNCTIONS OF REMOTE CONTROL 18
- **Operations**
 - LISTENING TO A PROGRAM SOURCE 21
 - SURROUND SOUND 23
 - ENJOYING SURROUND SOUND 25
 - LISTENING TO RADIO BROADCASTS 29
 - LISTENING TO SIRIUS SATELLITE RADIO 31
 - (SIRIUS Satellite Radio (only for North America))
 - RECORDING 35
 - DIGITAL AUDIO RECORDING WITH MD RECORDER 36
 - OTHER FUNCTIONS 37
 - ROOM 2 SOURCE PLAYBACK 38
- **OSD Menu Settings** 39
 - SETTING THE SYSTEM SETUP 41
 - SETTING THE INPUT SETUP 45
 - SETTING THE SPEAKER / ROOM EQ SETUP 51
 - SETTING THE CH LEVEL SETUP 57
 - SETTING THE SOUND PARAMETER 59
 - SETTING THE MULTI ROOM SETUP 61
- **Troubleshooting Guide** 62
- **Specifications** 63
- **Setup Code Table** 64

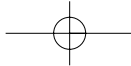

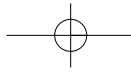

System Connections

- Please be certain that this unit is unplugged from the AC outlet before making any connections.
- Since different components often have different terminal names, carefully read the operating instructions of the component connected.
- Be sure to observe the color coding when connecting audio, video and speaker cords.
- Make connections firmly and correctly. If not, it can cause loss of sound, noise or damage to the receiver.

ENGLISH

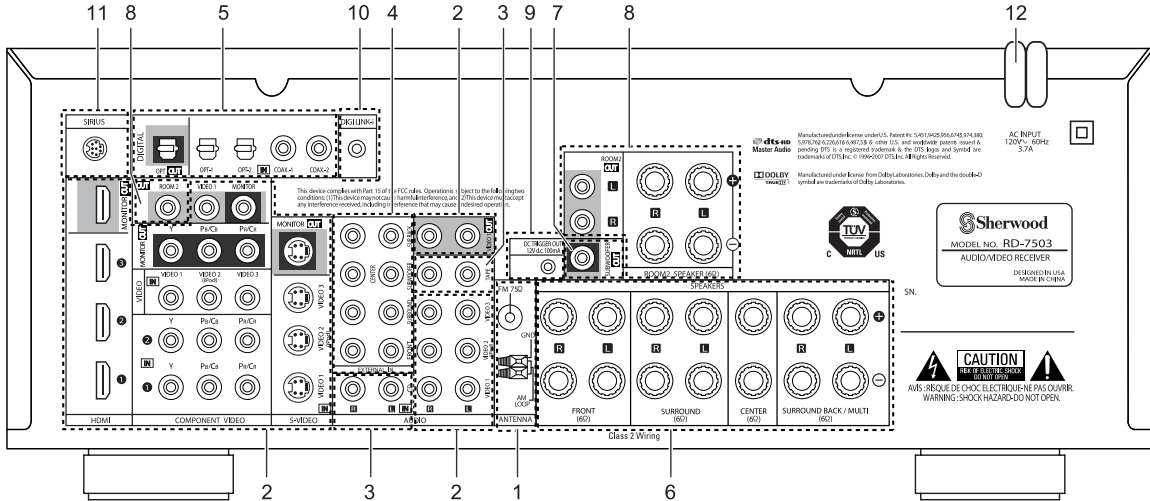

1. CONNECTING ANTENNAS

FM Indoor Antenna

FM Outdoor Antenna

- Change the position of the FM indoor antenna until you get the best reception of your favorite FM stations.
- A 75Ω outdoor FM antenna may be used to further improve the reception. Disconnect the indoor antenna before replacing it with the outdoor one.

AM Loop Antenna

AM Outdoor Antenna

- Place the AM loop antenna as far as possible from the receiver, TV set, speaker cords and the AC input cord and set it to a direction for the best reception.
- If the reception is poor with the AM loop antenna, an AM outdoor antenna can be used in place of the AM loop antenna.

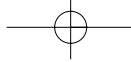

2. CONNECTING VIDEO COMPONENTS

- The jacks of VIDEO 1 may also be connected to a DVD recorder or other digital video recording component. For details, refer to the operating instructions of the component to be connected.
- The jacks of VIDEO 2/VIDEO 3 can also be connected to an additional video component such as a cable TV tuner or satellite system.
- Connect the jacks of VIDEO 3 to the video component in the same way.
- There are three types of video jacks (COMPONENT, S-VIDEO, (composite) VIDEO) for analog video connections and the HDMI connectors for digital video and audio connections.
- Connect them to the corresponding video jacks according to their capability.
- For your reference, the excellence in picture quality is as follows : "HDMI" > "COMPONENT" > "S-VIDEO" > "(composite) VIDEO" .
- When making COMPONENT VIDEO connections, connect "Y" to "Y", "Pb/Cb" to "Cb"(or "B-Y", "Pb") and "Pr/Cr" to "Cr"(or "R-Y", "Pr").
- When recording video program sources through VIDEO 1 OUT jack or viewing video program sources through MONITOR OUT or ROOM 2 OUT jack, you must use the same type of video jacks that you did connect to video playback components such as DVD player, cable TV tuner, etc.

■ Notes :

- You can connect Apple iPod to this receiver via Sherwood iPod dock. If Sherwood iPod dock is connected to DIGI LINK-i jack for system control, you should connect its video and audio jacks to the "VIDEO 2" jacks of this receiver. Because, when you control your iPod with the unit's remote control, the VIDEO 2/iPod is automatically selected as an input source and the corresponding operation is performed.
- The OSD menu and the momentary OSD can be displayed via the (composite) VIDEO MONITOR OUT only.

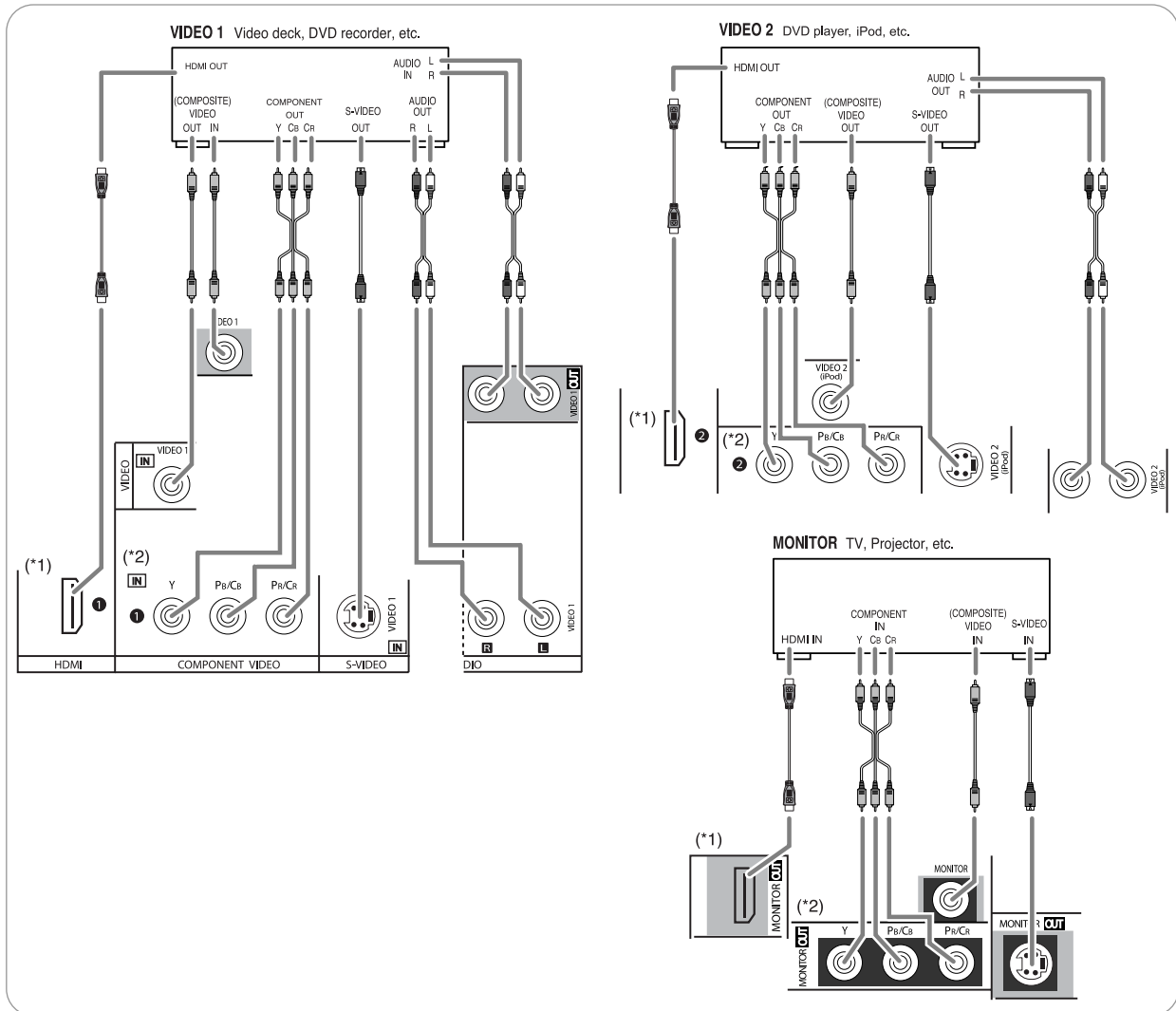

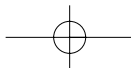

Continued

■ HDMI (High Definition Multimedia Interface) connection : (*1)

- You can connect the source component (DVD player, etc.) to the display component (TV, projector, etc.) through this receiver with using a commercially available HDMI cord.
- The HDMI connection can carry uncompressed digital video signals and digital audio signals.
- The HDMI video stream signals (video signals) are theoretically compatible with DVI-D. When connecting to a TV monitor, etc., equipped with DVI-D connector, it is possible to connect using a commercially available HDMI-DVI converter cord. Since the HDMI-to-DVI connection cannot carry any audio signals, you should make audio connections to play the audio signals on the component equipped with DVI-D connector. (For details, refer to the operating instructions of its.)
- If you connect the HDMI INs to your video components, it is easier to do so following the default settings.
- If your HDMI connection is different from the default setting, you should assign the HDMI INs you used with the "When selecting the HDMI ASSIGN" procedure on page 46.
- The default settings are as follows :
HDMI 1 : VIDEO 1, HDMI 2 : VIDEO 2/iPod, HDMI 3 : VIDEO 3

■ Copyright protection system

- This unit supports HDCP (High-bandwidth Digital Contents Protection), technology to protect copyright of digital video signals against illegal duplication. HDCP must also be supported on the components connected to this unit.
- This unit is HDMI Ver. 1.3 compatible.
- HDMI, the HDMI logo and High-Definition Multimedia Interface are trademarks or registered trademarks of HDMI licensing LLC.

■ Notes :

- For stable signal transfer, we recommend using HDMI cords that are a maximum of 5 meters in length.
- Among the components that support HDMI, some components can control other components via the HDMI connector. However, this unit cannot be controlled by another component via the HDMI connector.
- The audio signals from the HDMI connector (including the sampling frequency and bit length) may be limited by the component that is connected.
- The video signals will not be output properly if a component incompatible with HDCP is connected.
- If the resolutions of the video signals which are output from the MONITOR OUTs and your monitor TV are not matched, the picture is not clear, natural or displayed. In this case, change the setting of the resolution on the source component (DVD player, etc.) to one which the monitor TV can handle. (For details, refer to the operating instructions of the source component.)
- When you want to enjoy only the picture on your TV, not the sound, you should set the HDMI AUDIO OUT to OFF not to output the digital audio signal from the HDMI MONITOR OUT of this receiver. (For details, refer to "When selecting the HDMI AUDIO OUT" on page 42.)

■ Component video input default settings: (*2)

- If you connect the COMPONENT VIDEO INs to your video components, it is easier to do so following the default settings.
- If your component video connections are different from the default setting, you should assign the COMPONENT VIDEO INs you used with the "When selecting the VIDEO ASSIGN" procedure on page 46.
- The default settings are as follows:
COMPONENT IN 1 : VIDEO 1, COMPONENT IN 2 : VIDEO 2/iPod

3. CONNECTING AUDIO COMPONENTS

- When recording audio signals, connect the AUDIO IN/OUT jacks of "VIDEO 1" to audio recording equipment such as a tape deck, an MD recorder, etc.

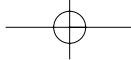
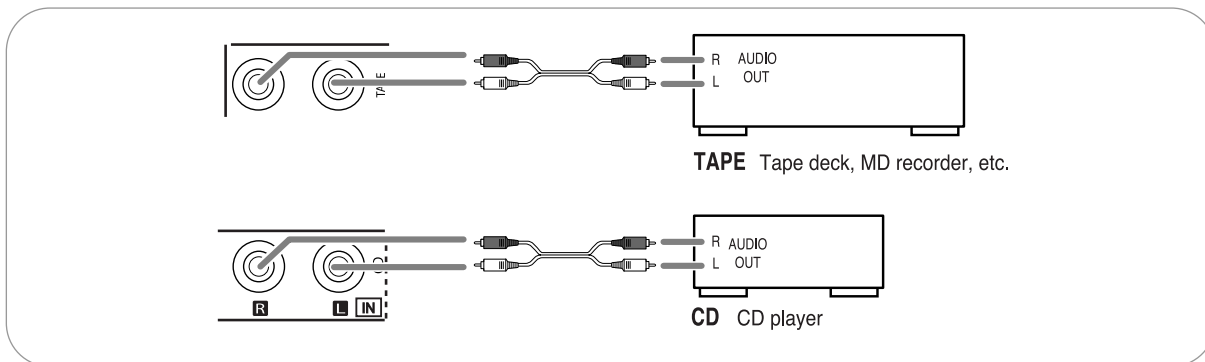

4. CONNECTING EXTERNAL INS

- Use these jacks to connect the corresponding outputs of a DVD player or external decoder, etc. that has 6, 7 or 8 channel analog audio outputs.
- In case of 6 or 7 channel outputs, do not connect both of the SURROUND BACK L and R inputs or the SURROUND BACK R input of this unit. (For details, refer to the operating instructions of the component to be connected.)

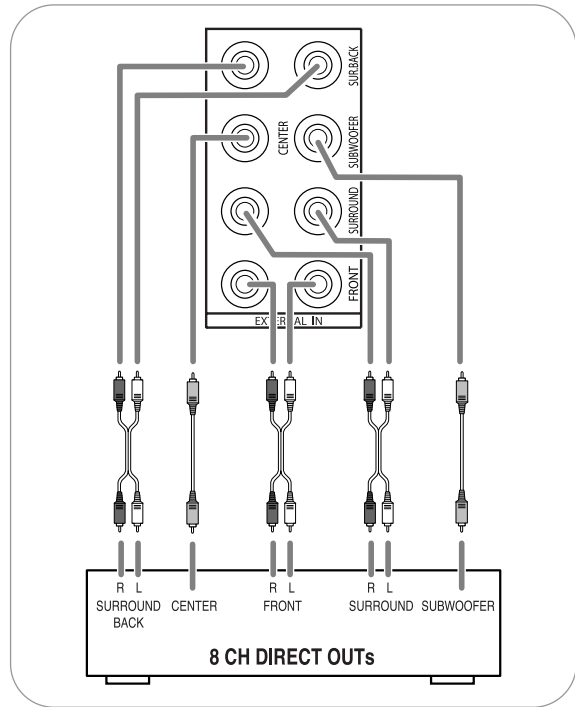

5. CONNECTING DIGITAL INS AND OUT

- The OPTICAL and the COAXIAL DIGITAL OUTs of the components that are connected to this unit can be connected to these DIGITAL INs.
- A digital input should be connected to the components such as a CD player, DVD player, etc. capable of outputting DTS Digital Surround, Dolby Digital or PCM format digital signals, etc.
- If the component with OPTICAL IN jack is connected to the OPTICAL OUT jack of this unit, you can record the high quality sound of CDs, etc. without degradation.
- For details, refer to the operating instructions of the component connected.
- When making the COAXIAL DIGITAL connection, be sure to use a 75 Ω COAXIAL cord, not a conventional AUDIO cord.
- All of the commercially available optical fiber cords cannot be used for the equipment. If there is an optical fiber cord which cannot be connected to your equipment, consult your dealer or nearest service organization.

■ Notes :

- Be sure to make either a OPTICAL or a COAXIAL DIGITAL connection on each component. (You don't need to do both.)
- Depending on the digital audio signal format input into the HDMI IN connector, some digital signals cannot be output from the OPTICAL OUT jack.

■ Digital input default settings

- If you connect the DIGITAL INs to your components, it is easier to do so following the default settings.
- If your DIGITAL connections are different from default settings, you should assign the DIGITAL INs you used with the "When selecting the AUDIO ASSIGN" procedure on page 46.
- The default settings are as follows :
OPTICAL IN 1:VIDEO 1, OPTICAL IN 2:VIDEO 2/iPod, COAXIAL IN 1 : CD, COAXIAL IN 2 : F. AUX

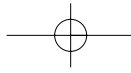

6. CONNECTING SPEAKERS

- Be sure to connect speakers firmly and correctly according to the channel(left and right) and the polarity (+ and -). If the connections are faulty, no sound will be heard from the speakers, and if the polarity of the speaker connection is incorrect, the sound will be unnatural and lack bass.
- For installing the speakers, refer to "Speaker placement" on page 10.
- After installing the speakers, first adjust the speaker settings according to your environment and speaker layout. (For details, refer to "SETTING THE SPEAKER /ROOM EQ SETUP" on page 51.)

■ Surround back speakers

- When using only one surround back speaker, you should connect it to SURROUND BACK/MULTI LEFT channel.
- Because this receiver cannot drive the surround back speakers and the ROOM 2 speakers simultaneously, you should assign their power amplifier correctly depending on how to use them. (For details, refer to "CONNECTING ROOM 2 OUTS" on page 11 and "When selecting the AMP ASSIGN" on page 41.)

■ Front Bi-Amp Connections.

- Some speakers are equipped with two sets of input terminals, for bi-amplification.
- If no other surround back speakers are used, you can connect the FRONT and the SURROUND BACK/MULTI channels to the bi-amp-capable speakers. (For details, refer to the operating instructions of your bi-amp-capable speakers.)
- To drive the bi-amp-capable speakers, you should assign the power amplifier to "BI-AMP".

■ Note :



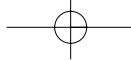
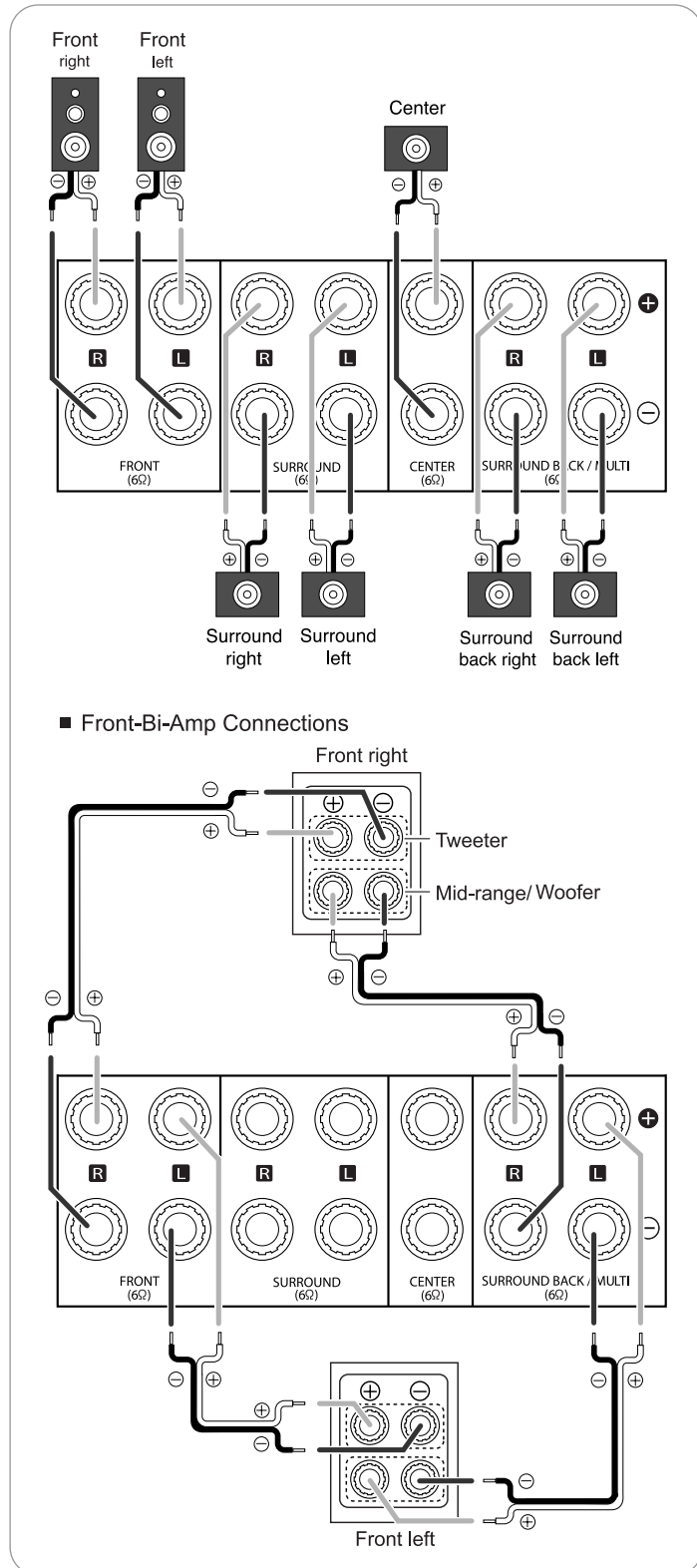

- Before making bi-amp connections, remove the short-circuiting bars from the terminals of your speakers.

Caution :

- Be sure to use the speakers with the impedance of 6 ohms or above.
- Do not let the bare speaker wires touch each other or any metal part of this unit. This could damage this unit and/or the speakers.
- Never touch the speaker terminals while the AC input cord is connected to the wall AC outlet. Doing so could result in electric shocks.



Continued**■ Connecting speaker wire**

<p>1. Strip away approx. 10 mm (3/8 inch) of wire insulation, then twist the wire ends tight.</p> 	<p>2. Loosen by turning the speaker terminal counter-clockwise.</p> 	<p>3. Insert the bare part of the wire.</p> 	<p>4. Tighten by turning it clockwise.</p> 
---	---	--	--

Speaker placement

Ideal speaker placement varies depending on the size of your room and the wall coverings, etc. The typical example of speaker placement and recommendations are as follows :

■ Front left and right speakers and center speaker

- Place the front speakers with their front surfaces as flush with TV or monitor screen as possible.
- Place the center speaker between the front left and right speakers and no further from the listening position than the front speakers.
- Place each speaker so that sound is aimed at the location of the listener's ears when at the main listening position.

■ Surround left and right speakers

- Place the surround speakers approximately 1 meter (40 inches) above the ear level of a seated listener on the direct left and right of them or slightly behind.

■ Surround back left and right speakers

- Place the surround back speakers at the back facing the front at a narrower distance than front speakers.
- When using a single surround back speaker, place it at the rear center facing the front at a slightly higher position (0 to 20 cm) than the surround speakers.
- We recommend installing the surround back speaker(s) at a slightly downward facing angle. This effectively prevents the surround back channel signals from reflecting off the TV or screen at the front center, resulting in interference and making the sense of movement from the front to the back less sharp.

■ Subwoofer

- The subwoofer reproduces powerful deep bass sounds. Place a subwoofer anywhere in the front as desired.

■ Notes :

- When using a conventional TV, to avoid interference with the TV picture, use only magnetically shielded front left and right and center speakers.
- To obtain the best surround effects, the speakers except the subwoofer should be full range speakers.

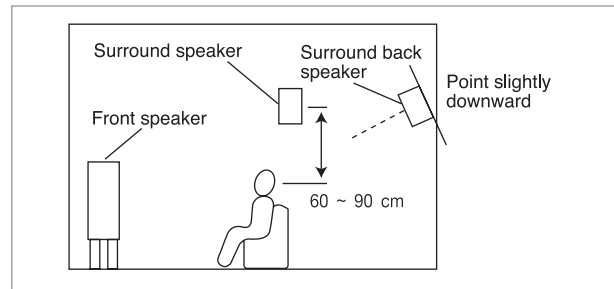
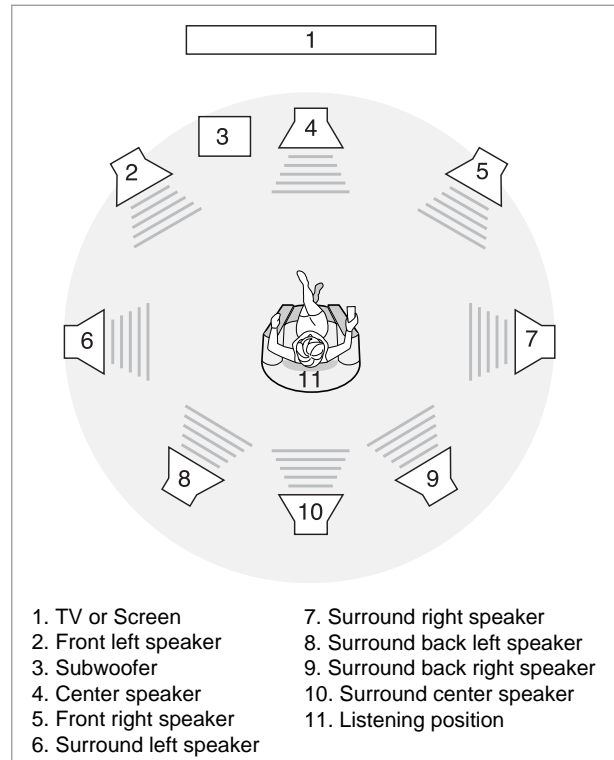
**7. CONNECTING SUBWOOFER PRE OUT**

- To emphasize the deep bass sounds, connect a powered subwoofer.

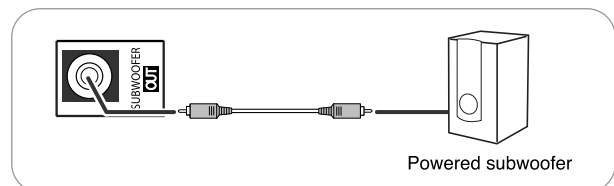

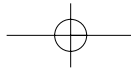

8. CONNECTING ROOM 2 OUTS

- ROOM 2 playback feature allows you to play a different program source in another room as well as one source in the main room at the same time.
- For ROOM 2 playback, connect the ROOM 2 OUT jacks to the amplifier, TV, etc. installed in another room, or connect the ROOM 2 speaker terminals to the speakers.
- Because this receiver cannot drive the surround back speakers and the ROOM 2 speakers simultaneously, you should assign their power amplifier correctly depending on how to use them. (For details, refer to "When selecting the AMP ASSIGN" on page 41.)

■ Notes :

- To minimize hum or noise, use high quality connection cords.
- You cannot use the digital audio signal for ROOM 2 playback.

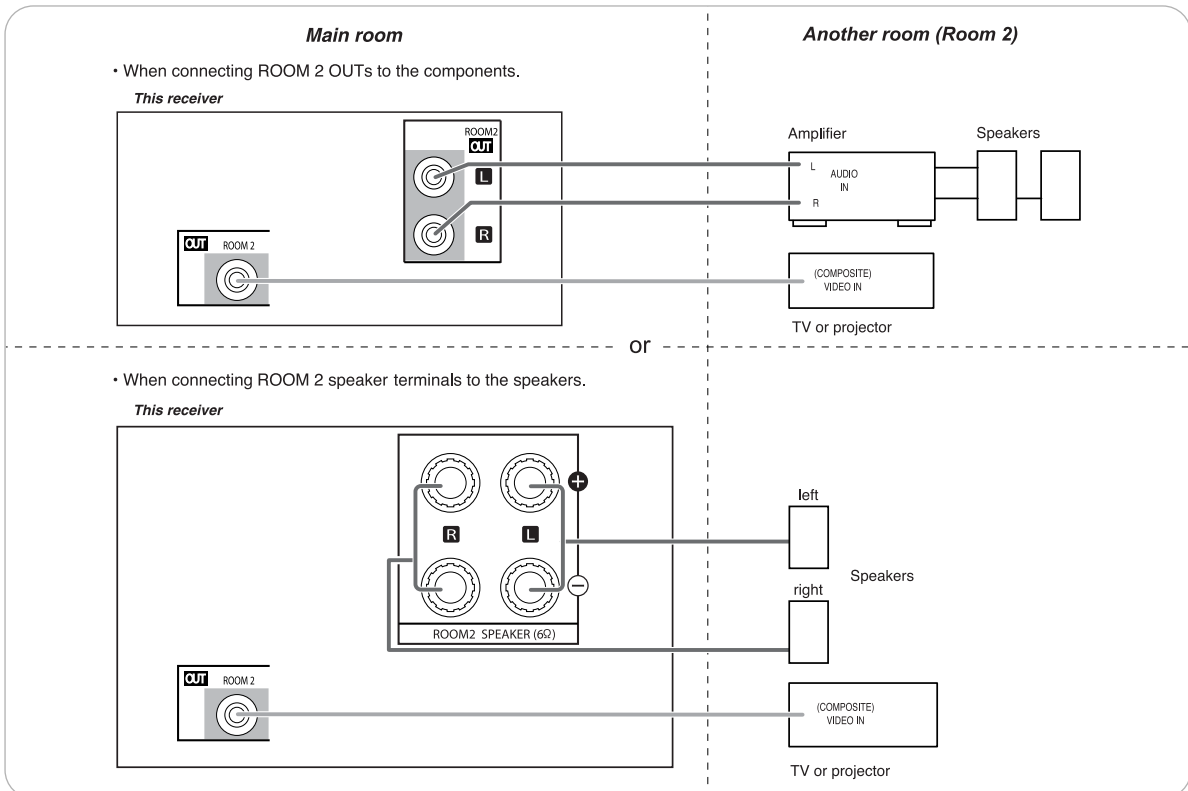

9. CONNECTING DC TRIGGER OUT

- Connect a component to DC TRIGGER OUT jack that allows DC 12V to turn on when a specific input source is selected.
- For details, refer to the operating instructions of the components to be connected.
- To link DC TRIGGER OUT with a specific input source, refer to "When selecting the DC TRIGGER" on page 47.

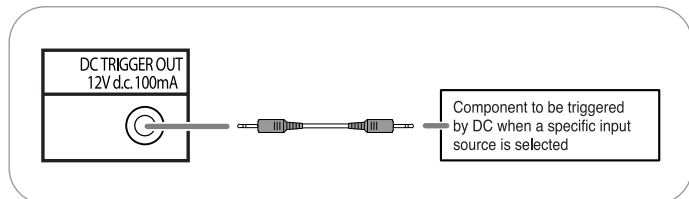

■ Notes :

- This output voltage (12V d.c., 100mA) is for (status) control only, it is not sufficient for drive capability.
- When making DC TRIGGER connection, you should use the stereo mini cord, not a mono mini cord.

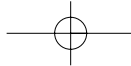

10. CONNECTING FOR SYSTEM CONTROL

- Connect this jack to the DIGI LINK-i jack of Sherwood iPod dock that allows you to control the iPod with the unit's remote control.

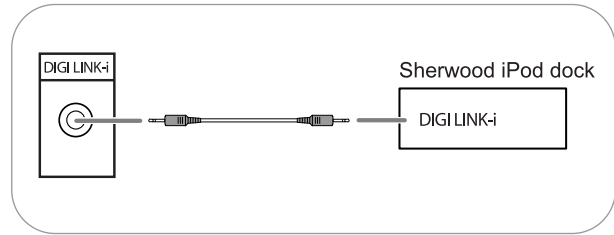

11. CONNECTING SIRIUS CONNECTOR (only for North America)

- Connect the SIRIUS connector to the Sirius Connect Home Tuner kit (sold separately).
- Position the Home Tuner antenna near a south-facing window to receive the best signal. When making connections, also refer to the operating instructions of the SiriusConnect Home Tuner.
- To listen to SIRIUS Satellite Radio, refer to "SIRIUS Satellite Radio (only for North America)" on page 31.

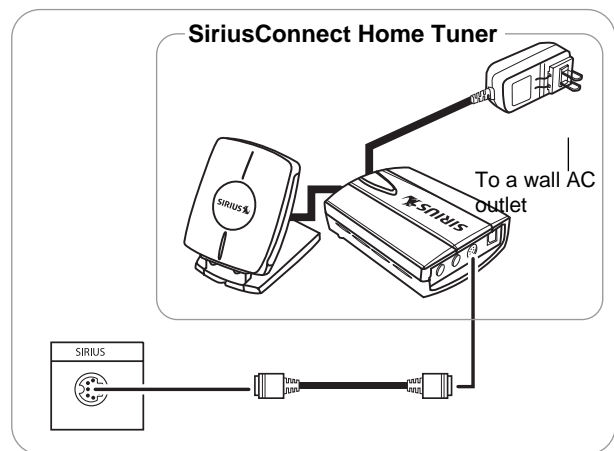

■ Positioning the antenna

- For a consistent satellite signal, the antenna must be positioned correctly. Use the following map to determine which area you are in and position the antenna accordingly.
- **Area 1** : Point the antenna toward the sky in the **east**, **northeast**, or **southeast**, either through a window or outside.
- **Area 2** : Point the antenna toward the sky in the **north** or **northeast**, either through a window or outside.
- **Area 3** : Point the antenna toward the sky in the **north** or **northwest**, either through a window or outside.
- **Area 4** : Point the antenna toward the sky in the **west**, **northwest**, or **southwest**, either through a window or outside.
- **Area 5** : Put the antenna outside and point it **straight up**. The antenna cannot be used indoors.

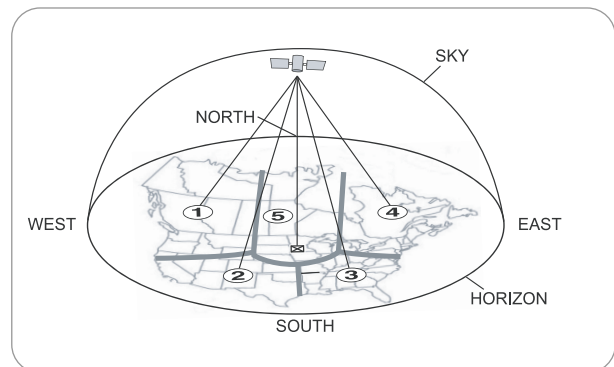

12. AC INPUT CORD

- Plug this cord into a wall AC outlet.

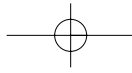

Front Panel Controls

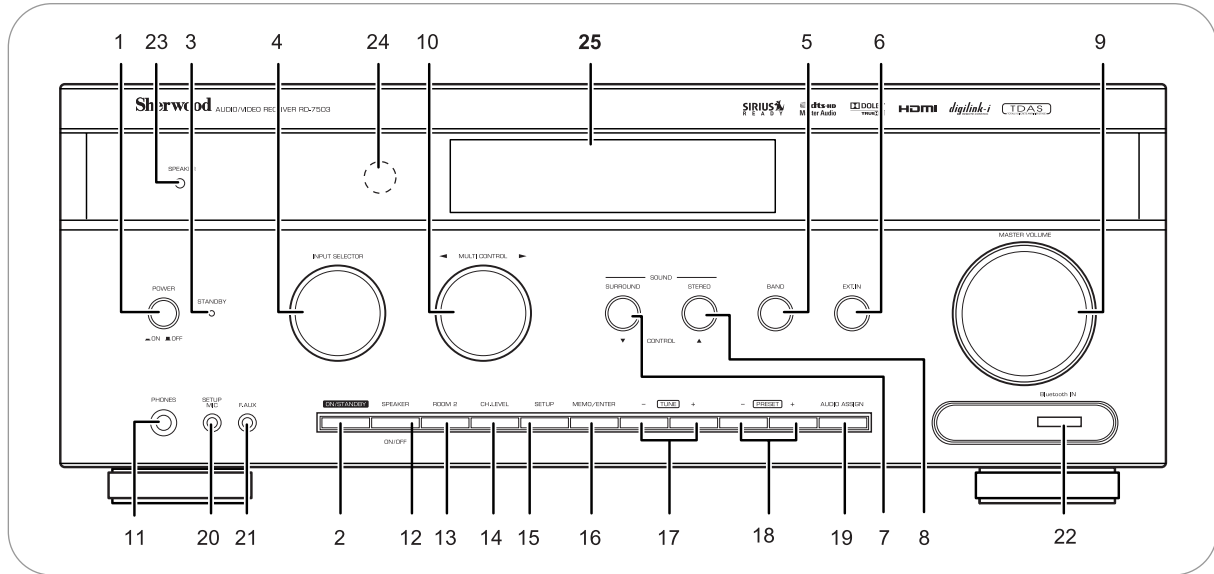

- | | |
|---|---|
| 1. POWER switch | 16. MEMORY/ENTER button |
| 2. POWER ON/STANDBY button | 17. TUNING UP(+)/DOWN(-) buttons |
| 3. STANDBY indicator | 18. PRESET UP(+)/DOWN(-) buttons |
| 4. INPUT SELECTOR knob | 19. AUDIO ASSIGN button |
| 5. BAND button | 20. SETUP MIC jack
For details, see next page. |
| 6. EXTERNAL IN button | 21. FRONT AUX IN jack
For details, see next page. |
| 7. SURROUND MODE/CONTROL DOWN(▼) button | 22. Bluetooth IN connector
For details, see next page. |
| 8. STEREO/CONTROL UP(▲) button | |
| 9. MASTER VOLUME CONTROL knob | |
| 10. MULTI CONTROL knob(◀/▶) | |
| 11. HEADPHONE jack | |
| 12. SPEAKER button | |
| 13. ROOM 2 button | |
| 14. CHANNEL LEVEL button | |
| 15. SETUP button | |

■ FLUORESCENT DISPLAY

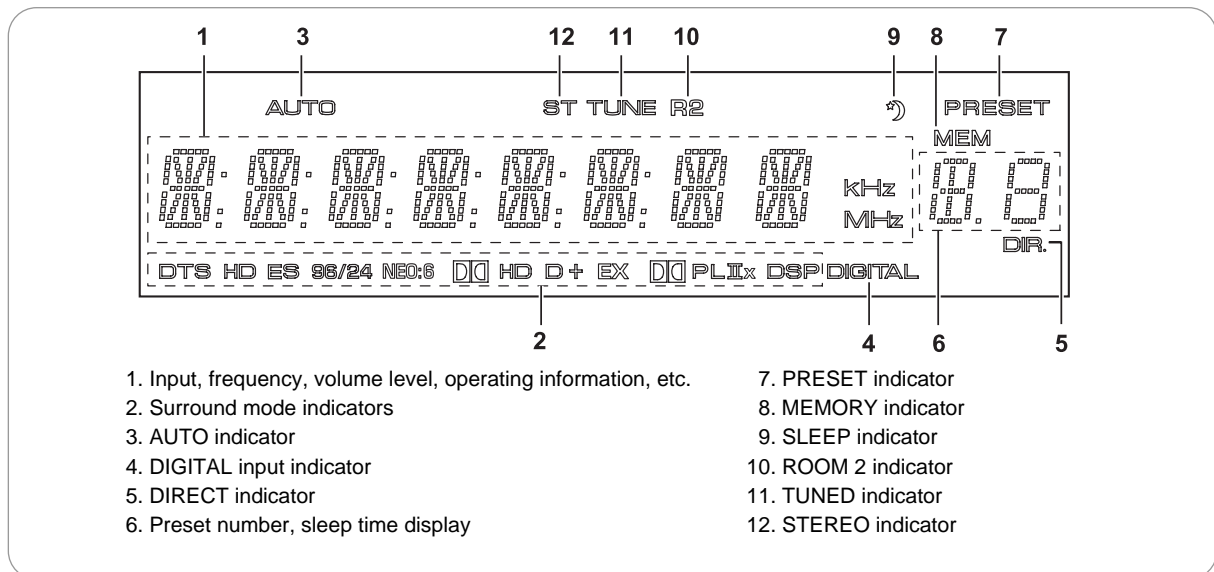

- | | |
|--|----------------------|
| 1. Input, frequency, volume level, operating information, etc. | 7. PRESET indicator |
| 2. Surround mode indicators | 8. MEMORY indicator |
| 3. AUTO indicator | 9. SLEEP indicator |
| 4. DIGITAL input indicator | 10. ROOM 2 indicator |
| 5. DIRECT indicator | 11. TUNED indicator |
| 6. Preset number, sleep time display | 12. STEREO indicator |

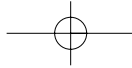

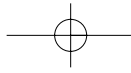

■ SETUP MIC JACK

- To use Auto Setup function, connect the supplied microphone to the SETUP MIC jack. (For details, refer to "When selecting the AUTO SETUP" on page 51.)
- **Notes:**
- Because the microphone for Auto Setup is designed for use with this receiver, do not use a microphone other than the one supplied with this receiver.
- After you have completed the auto setup procedure, disconnect the microphone.

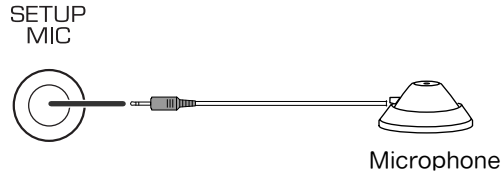

■ FRONT AUX IN JACK

- The FRONT AUX IN jack can be connected to additional audio components such as an MP3 player, etc.
- **Note :**
- When connecting this jack to an MP3 player, etc., you should use the stereo mini cord, not a mono mini cord.

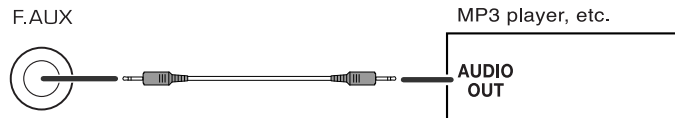

■ Bluetooth IN CONNECTOR

- If the **Bluetooth IN** connector is connected to Sherwood Audio Receiver BT-R7 (sold separately) with *Bluetooth* wireless technology, you can enjoy music wirelessly with a music player featuring *Bluetooth* wireless technology such as MP3 player, mobile phone, etc.. (For information on Sherwood Audio Receiver BT-R7, contact your dealer.)
- The *Bluetooth* word mark and logos are registered trademarks owned by Bluetooth SIG, Inc. and any use of such marks by Sherwood Corporation is under license. Other trademarks and trade names are those of their respective owners.

- **Notes:**
- For safe operation, turn the power off before connecting or disconnecting the Audio Receiver BT-R7.
- When not using the Bluetooth IN connector, cover it with the supplied cap.

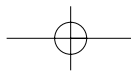
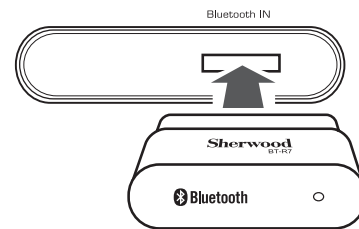

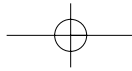

Universal Remote Controls

This universal remote control can operate not only this receiver but also most popular brands of audio and video components such as iPod docks, TVs, DVD players, satellite receivers, cable boxes, etc.

- To operate 5 components other than this receiver, you should enter the setup code for each component. (For details, refer to "USING FUNCTIONS OF REMOTE CONTROL" on page 18.)
- The numbered buttons on the remote control have different functions in different device modes. For details, refer to "FUNCTION TABLE of the NUMBERED BUTTONS" on the next page.

ENGLISH

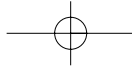
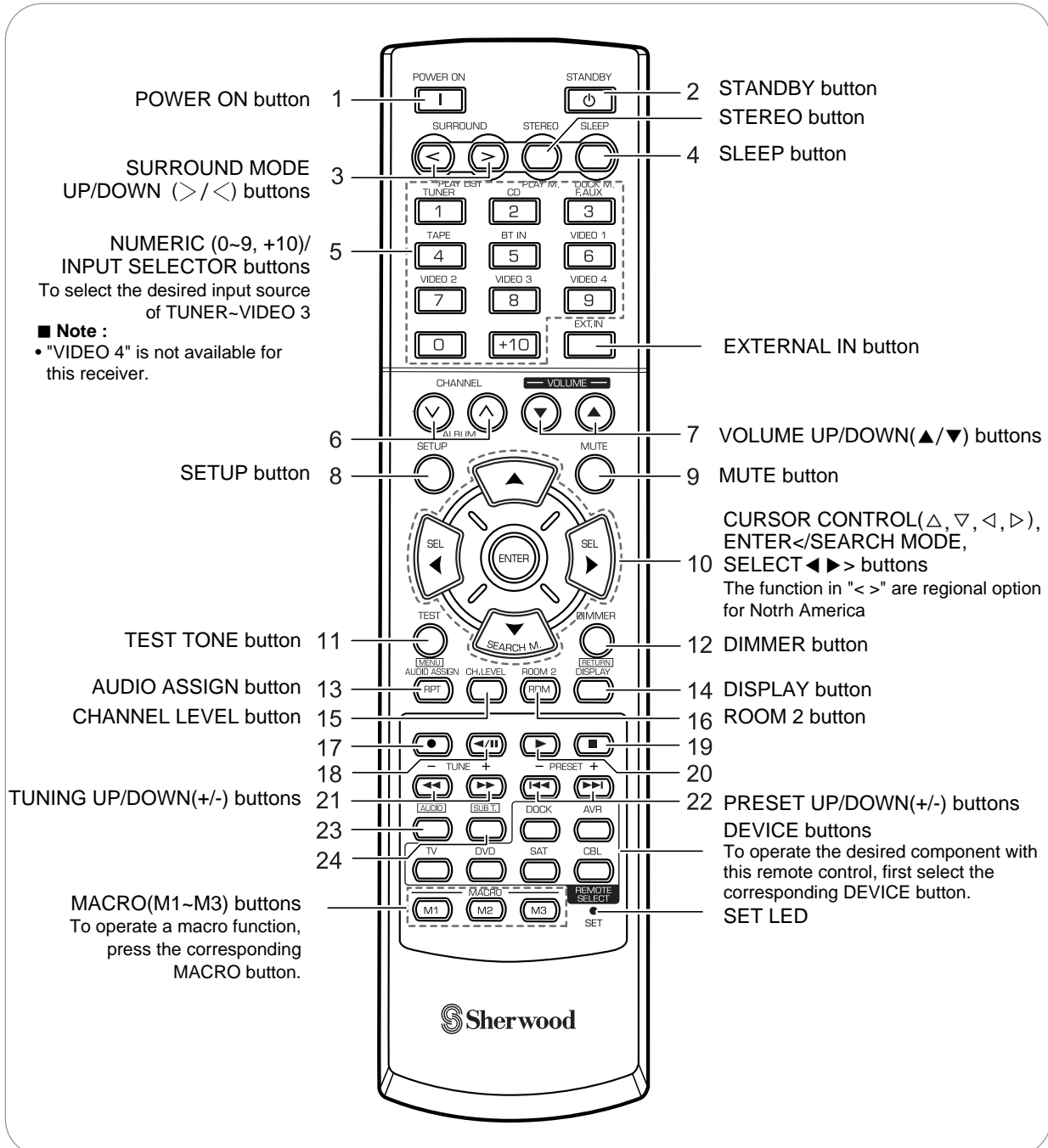

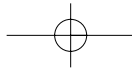

■ FUNCTION TABLE of the NUMBERED BUTTONS.

Device to be controlled Button symbol	DOCK 		TV 	DVD 	SAT 	CBL
	(for iPod Dock)	(for VCR)	(for TV)	(for DVD Player)	(for satellite receiver)	(for cable box)
1 	—	POWER ON	POWER ON	POWER ON	POWER ON	POWER ON
2 	—	STANDBY (POWER OFF)	STANDBY (POWER OFF)	STANDBY (POWER OFF)	STANDBY (POWER OFF)	STANDBY (POWER OFF)
3 	PLAY LIST UP/DOWN(</>)	—	—	—	—	—
4 	DOCK MODE	—	—	—	—	—
5 	—	NUMERIC	NUMERIC	NUMERIC	NUMERIC	NUMERIC
6 	ALBUM UP/DOWN(∇/∧)	CHANNEL UP/DOWN(∇/∧)	CHANNEL UP/DOWN(∇/∧)	—	CHANNEL UP/DOWN(∇/∧)	CHANNEL UP/DOWN(∇/∧)
7 	—	VOLUME UP/DOWN(▲/▼)	VOLUME UP/DOWN(▲/▼)	—	VOLUME UP/DOWN(▲/▼)	VOLUME UP/DOWN(▲/▼)
8 	—	—	—	SETUP	—	—
9 	—	MUTE	MUTE	—	MUTE	MUTE
10 	UP/DOWN(▲/▼)	—	—	CURSOR CONTROL	—	—
	ENTER			ENTER		
11 	MENU	—	—	MENU	—	—
12 	—	—	—	RETURN	—	—
13 	REPEAT	—	—	—	—	—
14 	—	INPUT SELECTOR	INPUT SELECTOR	—	INPUT SELECTOR	INPUT SELECTOR
15 	—	—	—	DISPLAY	—	—
16 	RANDOM	—	—	—	—	—
17 	—	RECORD	—	—	—	—
18 	—	PAUSE	—	PAUSE	—	—
19 	—	STOP	—	STOP	—	—
20 	PLAY/PAUSE	PLAY	—	PLAY	—	—
21 	—	REWIND (◀◀) / FAST FORWARD (▶▶)	—	REVERSE SEARCH(◀◀) / FORWARD SEARCH(▶▶)	—	—
22 	REVERSE SKIP (◀◀) / FORWARD SKIP (▶▶)	—	—	REVERSE SKIP (◀◀) / FORWARD SKIP (▶▶)	—	—
23 	—	—	—	AUDIO	—	—
24 	—	—	—	SUBTITLE	—	—

■ Notes :

- Some functions for each component may not be available or may work differently.
- Depending on other kinds of components that are available for each DEVICE button, some functions may not be available or may work differently, too.
- For details about functions, refer to the operating instructions of each component.

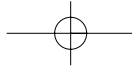

OPERATING COMPONENTS WITH REMOTE CONTROL

1. Enter the setup code for each component other than this receiver. For details, refer to "Entering a setup code" on page 18.
2. Turn on the component you want to operate.
3. Press the DEVICE button on the remote control corresponding to the component you wish to operate.
4. Aim the remote control at the REMOTE SENSOR of the component you wish to control and press the button corresponding to the operation you want.

- In such a case that some components do not have the REMOTE SENSOR which receives the remote signals, this remote control cannot operate them.

REMOTE CONTROL OPERATION RANGE

- Use the remote control within a range of about 7 meters (23 feet) and angles of up to 30 degrees aiming at the remote sensor.

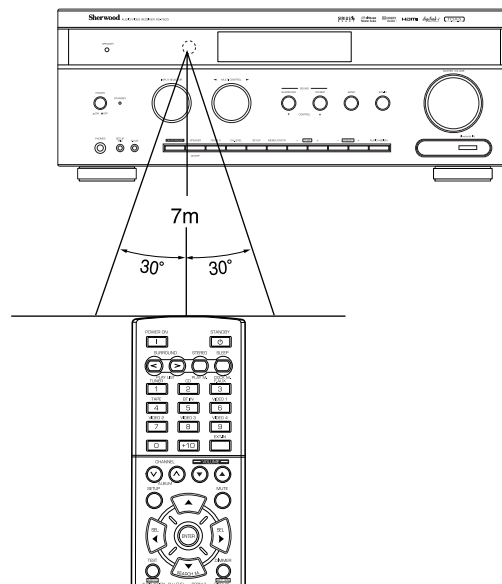

ENGLISH

LOADING BATTERIES

- When the remote control does not operate, the old batteries should be replaced. In this case, load new batteries within several minutes after removing old batteries.
- If the batteries are removed or have been exhausted for a longer period of time, memorized contents will be cleared. Should this happen, you should memorize them again.

1. Remove the cover.

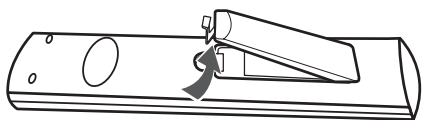

2. Load two batteries ("AAA" size, 1.5V) matching the polarity.

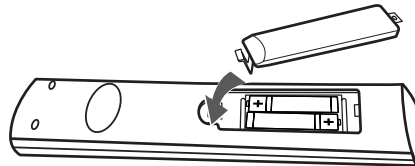

- Remove the batteries when they are not used for a long time.
- Do not use the rechargeable batteries (Ni-Cd type).
- Be sure to use alkaline batteries.

USING FUNCTIONS OF REMOTE CONTROL

- This remote control can control up to 6 different components.
- Before operating audio and video components other than this receiver with using this remote control, the setup code for each component should be entered.
- For system remote control operation, "000" was stored previously in the memory of the device button "DOCK" for Sherwood iPod dock, "DVD" for Sherwood DVD player and "TV" for Sherwood TV respectively as its factory setup code. So, you don't need to enter its code for each Sherwood component except in such a case that its code does not work.

Entering a setup code

1. Turn on the component you want to operate.
2. Find the setup codes according to the type and the brand name of your component, referring to "Setup Code Table" on page 62.
3. Press and hold down both the ENTER button and the desired one of the DEVICE buttons for more than 1 seconds.

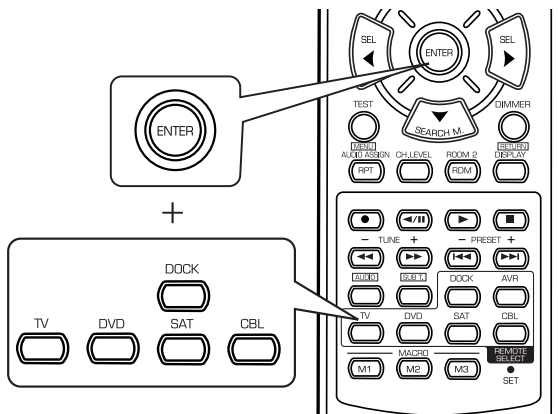

- The SET LED will flicker once.

■ Note :

- The "AVR" button is unavailable for the audio components other than this receiver.

4. Enter a 3 digit code, aiming the remote control at the remote sensor on the component.

Example: When entering "001".

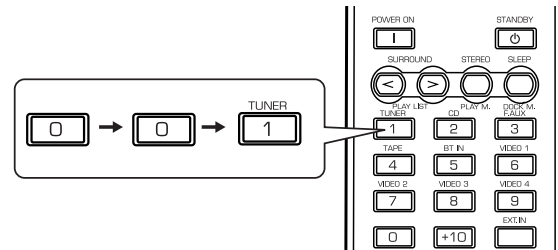

- If entering is performed successfully, the SET LED will flicker twice.
- To be sure that the setup code is correct, press the POWER ON (or STANDBY) button. If your component is turned off, the setup code is correct.
- When your component is not turned off, repeat the above steps 2 to 4, trying each code for your component until you find one that works.

■ Notes:

- If the SET LED did not flicker twice, then repeat the above steps 3 to 4 and try entering the same code again.
- Manufacturers may use different setup codes for the same product category. For that reason, it is important that you check to see if the code you have entered operates as many controls as possible. If only a few functions operate, check to see if another code will work with more buttons.

5. Repeat the above steps 1 to 4 for each of your components.

Using a punch-through function

This remote control may be programmed to operate either the AUDIO volume punch-through or the TV volume and/or TV channel punch-through in conjunction with any of the six components controlled by this remote control.

For example, since this receiver will likely be used as the sound system while watching TV, you may want to adjust this receiver's volume although this remote control is set to control the TV.

- When programming this remote control for the AUDIO volume punch-through, press and hold down both "AVR" button and "VOLUME ▲" button for more than 1 second.

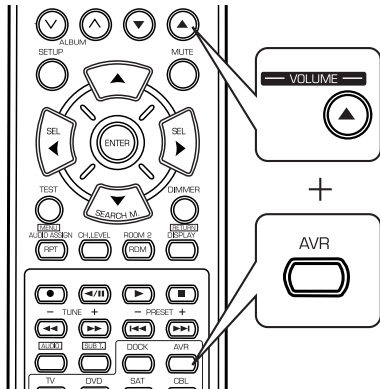

- If programming is performed successfully, the SET LED will flicker twice.
- When you want either TV volume or TV channel punch-through, press and hold down both "TV" button and either "VOLUME ▲" or "CHANNEL ▲" button for more than 1 second.

■ Note :

- If you use one of AUDIO and TV volume punch-through functions, you cannot use the other.

■ Removing a punch-through function

- When removing the AUDIO volume punch-through, press and hold down both "AVR" button and "VOLUME ▼" button for more than 1 second.

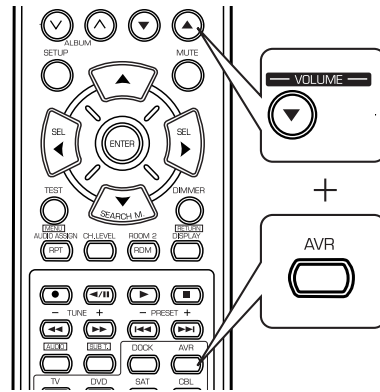

- If removing is performed successfully, the SET LED will flicker twice.
- When you want to remove either TV volume or TV channel punch-through, press and hold down both "TV" button and either "VOLUME ▼" or "CHANNEL ▼" button for more than 1 second.

■ Removing all punch-through functions

Press and hold down both "AVR" button and "AUDIO ASSIGN" button for more than 1 second.

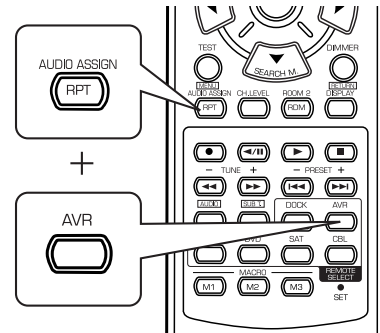

- If removing all punch-through functions is performed successfully, the LED will flicker twice.

Programming a macro function

- The macro function enables you to program a series of button operations (up to 10) on this remote control into a single button.
- You can store up to three separate macro command sequences into "M1", "M2" and "M3" buttons.

1. Press and hold down both "ENTER" button and one of three NUMERIC buttons ("1" ~ "3") corresponding to "M1" ~ "M3" buttons for more than 1 second.

Example: When programming a series of button operations into "M1" button.

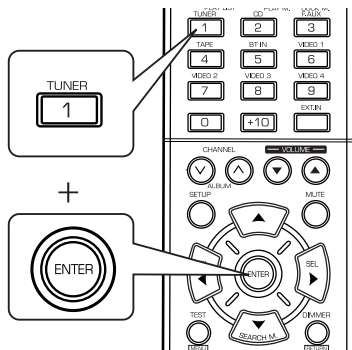

- If the macro mode is entered, the SET LED will flicker once.

2. Press the operation buttons you want to program in order.

■ Note :

You should press the corresponding DEVICE buttons before pressing each operation button.
Example: When playing a DVD on the DVD player connected to VIDEO 3 jacks of this receiver.

- ①. Press "AVR" button to control this receiver.
- ②. Press "POWER ON" button to turn this receiver on.
- ③. Press "AVR" button to control this receiver.
- ④. Press "VIDEO 3(8)" button to select the desired input source.
- ⑤. Press "DVD" button to control the DVD player.
- ⑥. Press "POWER ON" button to turn the DVD player on.
- ⑦. Press "DVD" button to control the DVD player.
- ⑧. Press "▶" button to start playback.

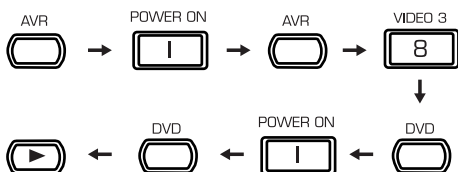

3. Press "ENTER" button.

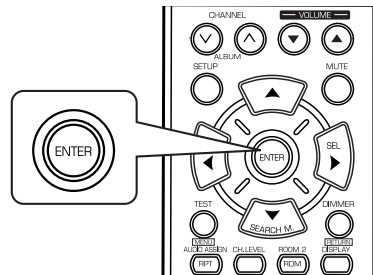

- If the programming is performed successfully, the SET LED will flicker twice.

■ To remove a macro program

- When removing a macro program, perform the above steps 1 and 3, but ignore the step 2.

■ To change a macro program

- When a new macro program is stored into a MACRO button with performing the above steps 1 to 3, the previous macro program is cleared from the memory of the MACRO button.

Operating a macro function

- Aim the remote control at the REMOTE SENSORS of the components to be controlled and press the MACRO button you want.

Example: When pressing "M1" button.

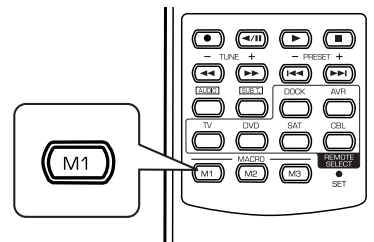

■ Notes:

- The codes programmed into a MACRO button will be transmitted at an interval of 0.5 seconds. However, some components may not be able to complete one operation in 0.5 seconds and may miss the next code. In this case, the macro function cannot control the corresponding components correctly.
- Be sure to use the remote control within the remote control operation range of the components.
- Depending on the operation status of the components, etc., the macro function cannot control the corresponding components correctly.

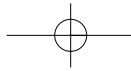

Operations

■ Notes:

- Before operating this receiver with the supplied remote control, refer to "Universal Remote Controls" on page 15 for details about operation.
- Before operating this receiver, first set this unit as desired for optimum performance, doing the OSD menu setting procedures. (For details, refer to "OSD Menu Settings" on page 39.)

LISTENING TO A PROGRAM SOURCE

Before operation

- Enter the standby mode.
- The STANDBY indicator lights up amber.
This means that the receiver is not disconnected from the AC mains and a small amount of current is retained to support the operation readiness.
- To switch the power off, push the POWER switch again.
Then the power is cut off and the STANDBY indicator goes off.



1. In the standby mode, turn the power on.

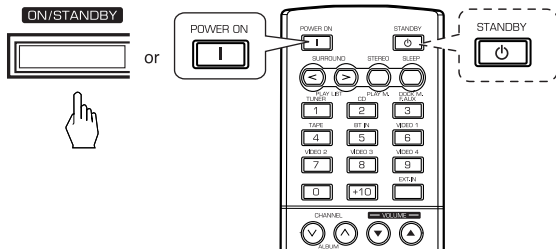

- Each time the POWER ON/STANDBY button on the front panel is pressed, the receiver is turned on to enter the operating mode (the STANDBY indicator lights up blue) or off to enter the standby mode (the STANDBY indicator lights up amber).
- On the remote control, press the POWER ON button to enter the operating mode or press the STANDBY button to enter the standby mode.
- In the standby mode, if the INPUT SELECTOR knob is rotated or the INPUT SELECTOR button is pressed, the receiver is turned on automatically and the desired input is selected.

2. Switch the speakers on.

- Then the SPEAKER indicator lights up and the sound can be heard from the speakers connected to the speaker terminals.
- When using the headphones for private listening, press the SPEAKER button again to switch the speakers off.

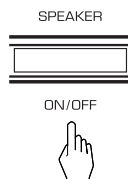

3. Select the desired input source.

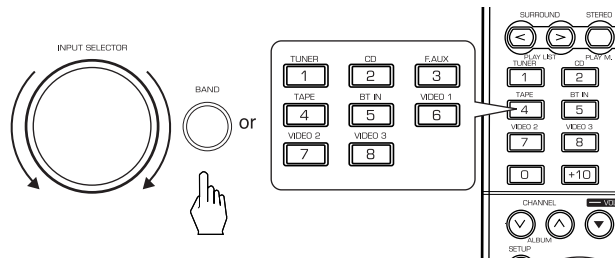

- Each time the INPUT SELECTOR knob on the front panel is rotated, the input source changes as follows:
TUNER → CD → TAPE → F.AUX → VIDEO 1
(Frequency display)
BT → VIDEO 3 → V2/IPOD
- Each time the BAND button (or the TUNER button on the remote control) is pressed, the band changes as follows:
FM ST → FM MONO → AM → SIRIUS

■ When selecting the EXTERNAL IN as desired,

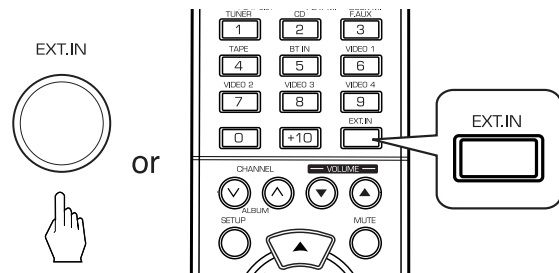

- Depending on the power amplifier setting for the surround back channels and the surround back speaker setting, "EXT. IN" is displayed and 8/(7/6) separate analog signals from the component connected to this input pass through the volume circuits only and can be heard from your speakers.
- Select the desired input source to cancel the external in function.
- These analog signals can be heard only, not recorded.

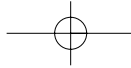

When CD, F.AUX, VIDEO 1~ 3 is selected as an input source

- If the AUDIO MODE is set to the mode other than "DIGITAL" for the corresponding input source on the INPUT SETUP menu, you cannot hear the sound from the selected digital input. (For details, refer to "SETTING THE INPUT SETUP" on page 45.)

4. Press the AUDIO ASSIGN button.

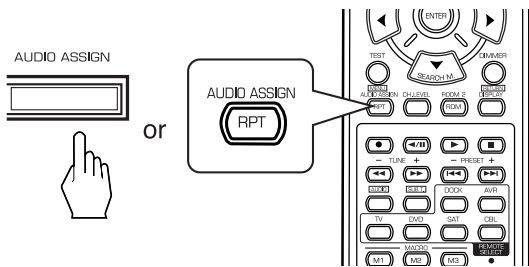

- "AUD ~ " is displayed for several seconds.
- "AUD ~ " disappears, press the AUDIO ASSIGN button again.

5. Select the desired of the digital inputs connected while displaying "AUD ~ ".

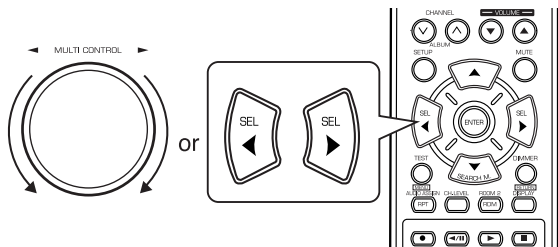

- Each time the MULTI CONTROL knob is rotated or the CURSOR LEFT(◀)/RIGHT(▶) buttons are pressed, the corresponding input is selected as follows :

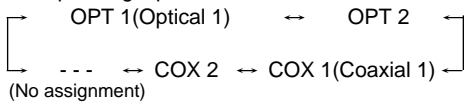

■ Notes:

- When the selected digital input is not connected, the digital input flickers and no sound will be heard.
- The selected digital input is automatically assigned to the corresponding input source on the INPUT SETUP menu. (For details, refer to "SETTING THE INPUT SETUP" on page 45.)
- The sound from the component connected to the selected digital input can be heard regardless of the selected input source.

6. Operate the selected component for playback.

- When playing back the program sources with surround sound, refer to "ENJOYING SURROUND SOUND" on page 25.

7. Adjust the (overall) volume.

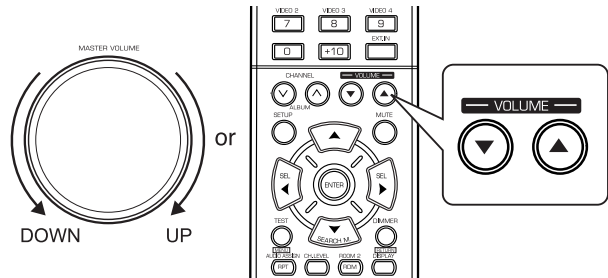

Muting the sound

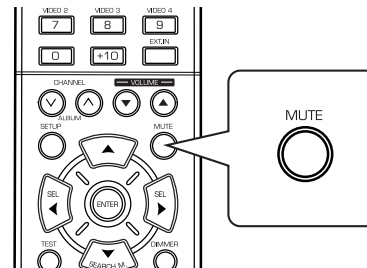

- "MUTE" flickers.
- To resume the previous sound level, press it again.

Listening with headphones

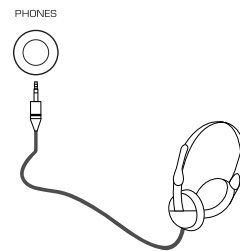

- Ensure that the SPEAKER button is set to off.
- When listening to a DTS or Dolby Digital program source, if the headphones are plugged in and the SPEAKER button is set to off, it enters the 2CH downmix mode automatically. (For details, refer to "2CH downmix mode" on page 26.)

■ Note:

- Be careful not to set the volume too high when using headphones.

SURROUND SOUND

- This receiver incorporates a sophisticated Digital Signal Processor that allows you to create optimum sound quality and sound atmosphere in your personal Home Theater.

Surround modes

■ DTS Digital Surround

DTS Digital Surround(also called simply DTS) supports up to 5.1 discrete channels and uses less compression for high fidelity reproduction. Use it with DVDs and CDs bearing the DTS logo.

■ DTS-ES™ Discrete 6.1

This is a 6.1 channel discrete digital audio format adding a surround back channel to the DTS digital surround sound. The seven totally separate audio channels provide better spatial imaging and 360 degrees sound localization, perfect for sounds that pan across the surround channels. Use it with DVDs bearing the DTS-ES logo, especially those with a DTS-ES Discrete sound track.

■ DTS - ES™ Matrix 6.1

This is a 6.1 channel discrete digital audio format inserting a surround back channel to the DTS digital surround sound through matrix encoding. Use it with DVDs bearing the DTS-ES logo.

■ DTS Neo : 6™ surround

DTS Neo : 6 is a matrix decoding technology for achieving 7.1 channel surround playback with 2 channel sources. It includes "DTS Neo : 6 Cinema" suited for playing movies and "DTS Neo : 6 Music" suited for playing music.

■ DTS 96/24

This is high resolution DTS with a 96 kHz sampling rate and 24 bit resolution, providing superior fidelity. Use it with DVDs bearing the DTS 96/24 logo.

■ DTS-HD High Resolution Audio

Developed for use with HDTV, including the new video disc formats Blu-ray and HD DVD, this is the latest multi-channel audio format from DTS. It supports up to 7.1 channels with 96 kHz/24 bit sampling rate and signal resolution.

■ DTS-HD Master Audio

Designed to take full advantage of the additional storage space offered by the new Blu-ray and HD DVD disc formats, this new DTS format offers up to 7.1 discrete channels of uncompressed digital audio with 96 kHz/24 bit sampling rate and signal resolution.

This receiver supports 7.1 channel sources up to 96 kHz.

Manufactured under license under U.S. Patent #'s: 5,451,942; 5,956,674; 5,974,380; 5,978,762; 6,226,616; 6,487,535 & other U.S. and worldwide patents issued & pending.

DTS is a registered trademark and the DTS logos, Symbol, DTS-HD and DTS-HD Master Audio are trademarks of DTS, Inc.

© 1996-2007 DTS, Inc. All Rights Reserved.

■ Dolby Digital

Dolby Digital is the multi-channel digital signal format developed by Dolby Laboratories. Discs bearing the Dolby Digital logo includes the recording of up to 5.1 channels of digital signals. This will put you right in the middle of the action, just like being in a movie theater or concert hall.

■ Dolby Digital EX

This mode expands 5.1-channel sources for 6.1/7.1 channel playback. It's especially suited to Dolby Digital EX soundtracks that include a matrix-encoded surround back channel. The additional channel adds an extra dimension and provides an enveloping surround sound experience, perfect for rotating and fly-by sound effects.

■ Dolby Digital Plus

Developed for use with HDTV, including the new video disc formats Blu-ray and HD DVD, this is the latest multichannel audio format from Dolby. It supports up to 7.1 channels with 48 kHz/24-bit sampling rate and signal resolution.

■ Dolby TrueHD

Designed to take full advantage of the additional storage space offered by the new Blu-ray and HD DVD disc formats, this new Dolby format offers up to 7.1 discrete channels of lossless audio performance with 96 kHz/24 bit sampling rate and signal resolution.

This receiver supports 7.1-channel sources up to 96 kHz.

■ Dolby Pro Logic IIx surround

This mode expands any 2-channel source for 7.1-channel playback. It provides a very natural and seamless surround sound experience that fully envelopes the listener. As well as music and movies, video games can also benefit from the dramatic spatial effects and vivid imaging. It includes "Dolby Pro Logic IIx Movie" suited for playing movies, "Dolby Pro Logic IIx Music" suited for playing music and "Dolby Pro Logic IIx Game" suited for playing games.

■ Dolby Pro Logic II surround

If you are not using any surround back speakers, Dolby Pro Logic II surround will be used instead of Dolby Pro Logic IIx surround. It includes Dolby Pro Logic II Movie, Dolby Pro Logic II Music and Dolby Pro Logic II Game like Dolby Pro Logic IIx surround.

Dolby and the double-D symbol are registered trademarks of Dolby Laboratories.

- The following modes apply conventional 2-channel signals such as digital PCM or analog stereo signals to high performance Digital Signal Processor to recreate sound fields artificially. Select one of the 7 provided surround modes according to the program source you want to play.

■ Theater

This mode provides the effect of being in a movie theater when watching a play.

■ Hall

This mode provides the ambience of a concert hall for classical music sources such as orchestral, chamber music or an instrumental solo.

■ Stadium

This mode provides the expansive sound field to achieve the true stadium effect when watching baseball or soccer games.

■ Room

This mode provides the sound field of a house with a low ceiling and hard walls for jazz music.

■ Panorama

This mode provides a dynamic and broad sound space to heighten the overall impact of the sound track.

■ Classic

This mode provides the acoustic effects of a large concert hall for classical music.

■ Multi CH Stereo

This mode is designed for playing background music. The front, surround and surround back channels create a stereo image that encompasses the entire area.

- When using the EXTERNAL INs to play back the sound from the additional multi-channel decoder for surround sound, you can enjoy the corresponding surround sound, too. (For details, refer to the operating instructions of the component to be connected.)

For your reference, the sound from each channel can be reproduced according to the surround modes as follows:

Modes	Channels	FRONT L/R	CENTER	SURROUND L/R	SURROUND BACK L/R	SUBWOOFER
DTS-HD HIGH RESOLUTION AUDIO/MASTER AUDIO		○	○	○	○/—	○
DTS, DTS 96/24		○	○	○	—	○
DTS ES DISCRETE/MATRIX		○	○	○	○	○
DTS NEO: 6 CINEMA/MUSIC		○	○	○	○	—(*)
DOLBY DIGITAL PLUS / DOLBY TRUEHD		○	○	○	○/—	○
DOLBY DIGITAL		○	○	○	—	○
DOLBY DIGITAL EX		○	○	○	○	○
DOLBY PRO LOGIC IIx MOVIE/MUSIC/GAME		○	○	○	○	○
DOLBY PRO LOGIC II MOVIE/MUSIC/GAME		○	○	○	—	○
MULTI PCM		○	○	○	○/—	○
Other Surrounds		○	○	○	○	—(*)
STEREO		○	—	—	—	—(*)
EXTERNAL IN		○	○	○	○	○

(*): Depending on the subwoofer setting, the sound from the subwoofer channel may be reproduced.

- Depending on the speaker settings and the number of the encoded channels, etc., the sound from the corresponding channels cannot be reproduced. (For details, refer to "SETTING THE SPEAKER / ROOM EQ SETUP" on page 51.)

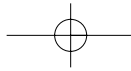

ENJOYING SURROUND SOUND

■ Notes:

- Before surround playback, first perform the speaker setup procedure, etc. on the OSD menu for optimum performance. (For details, refer to "SETTING THE SPEAKER / ROOM EQ SETUP" on page 51.)
- When playing digital signals from the Dolby Digital program source or selecting the surround mode such as Dolby Pro Logic II /Dolby Pro Logic IIx Music mode, you can adjust their parameters for optimum surround effect. (For details, refer to "SETTING THE SOUND PARAMETER" on page 59.)
- When the EXTERNAL IN is selected as an input source, the surround modes cannot be selected.

Depending on how to select a surround mode, select the auto surround mode or the manual surround mode.

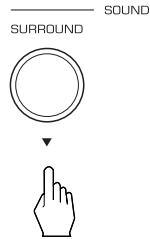

- Each time this button is pressed, the mode changes as follows :
Auto surround mode : The optimum surround mode will be automatically selected depending on the signal format being input. ("AUTO" lights up.)

- Manual surround mode : You can select the desired of different surround modes selectable for the signal being input with using the MULTI CONTROL knob or the SURROUND MODE UP/DOWN (>/<) buttons.

■ Notes :

- Even when the auto surround mode is selected and the same type of digital signal format is being input, the optimum surround mode may vary depending on whether the speaker type is set to "NO" or not.
- When the auto surround mode is selected, the surround modes other than the optimum surround mode cannot be selected.

- When selecting the manual surround mode with pressing the SURROUND MODE button on the front panel. Select the desired surround mode.

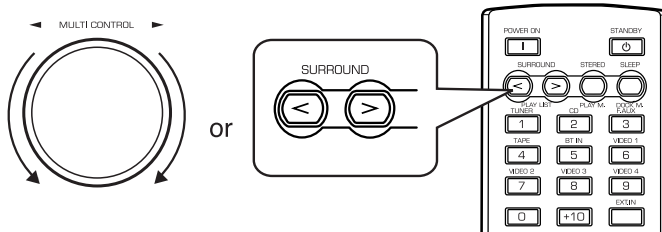

- Each time the MULTI CONTROL knob is rotated or the SURROUND MODE UP / DOWN (>/<) buttons are pressed, the surround mode changes depending on the input signal format as follows :

Signal format being input	Selectable surround mode
Dolby Digital Plus sources	DOLBY DIGITAL +
Dolby TrueHD sources	DOLBY TRUEHD
Dolby Digital EX 6.1 channel sources, Dolby Digital 5.1 channel sources	<DOLBY DIGITAL EX, DOLBY D + PLIIX MUSIC>, (DOLBY D + PLIIX MOVIE), DOLBY DIGITAL
Dolby Digital 2 channel sources	<DOLBY PLIIX MOVIE, DOLBY PLIIX MUSIC, DOLBY PLIIX GAME>, [DOLBY PLII MOVIE, DOLBY PLII MUSIC, DOLBY PLII GAME]
DTS-HD High Resolution Audio sources	DTS-HD HI RES
DTS-HD Master Audio sources	DTS-HD MSTR
DTS ES Discrete/Matrix 6.1 channel sources	<corresponding DTS ES mode, DTS + PLIIX MUSIC>, (DTS + PLIIX MOVIE), DTS,
DTS sources, DTS 96/24 sources	corresponding DTS mode, <DTS + NEO:6, DTS + PLIIX MUSIC>, (DTS + PLIIX MOVIE)
PCM (multi-channel) sources*	MULTI PCM, <DOLBY PLIIX MOVIE, DOLBY PLIIX MUSIC>
96 kHz PCM (2 channel) sources PCM (2 channel) sources, Analog stereo sources	<DOLBY PLIIX MOVIE, DOLBY PLIIX MUSIC, DOLBY PLIIX GAME>, [DOLBY PLII MOVIE, DOLBY PLII MUSIC, DOLBY PLII GAME], NEO:6 CINEMA, NEO:6 MUSIC, THEATER, HALL, STADIUM, ROOM, PANORAMA, CLASSIC, MULTI-CH STEREO

- Depending on surround back speaker setting, some surround modes can be selected or not as follows:
< > : Possible only when surround back speaker is not set to "NO".
[] : Possible only when surround back speaker is set to "NO".
() : Possible only when surround back speaker is set to "2 CH".
* : Depending on the signal format being input, the Dolby Pro Logic IIx modes may not be selected.

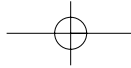

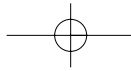

Continued

■ To cancel the surround mode for stereo operation

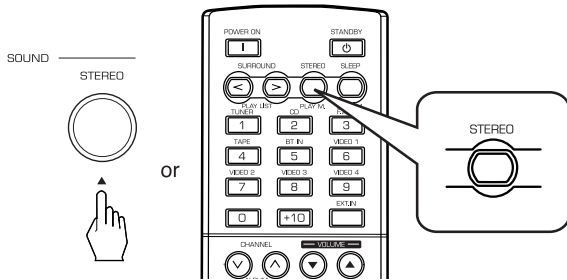

- Depending on the signal format which is being input, either the stereo mode or the 2CH downmix mode is selected.
- To cancel either the stereo mode or the 2CH downmix mode, select the surround mode with using the MULTI CONTROL knob on the front panel or the SURROUND MODE UP/DOWN (\triangleright / \triangleleft) buttons on the remote control.

■ 2CH downmix mode

- This mode allows the multi-channel signals encoded in DTS or Dolby Digital format, etc. to be mixed down into 2 front channels and to be reproduced through only two front speakers or through headphones.
- When the SPEAKER button is set to off to listen with headphones while playing the multi-channel digital signals from DTS or Dolby Digital sources, etc., it will enter the 2CH downmix mode automatically.

Adjusting each channel level with test tone

- The volume level of each channel can be adjusted easily with the test tone function.
- **Note** : When the SPEAKER button is set to off, the test tone function does not work.

1. Enter the test tone mode.

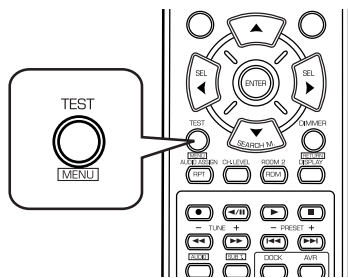

- The test tone mode is displayed and will be heard from the speaker of each channel for 2 seconds as follows:

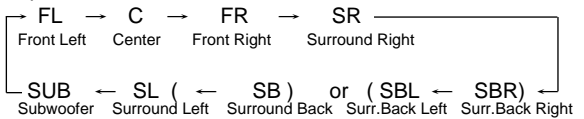

- When the speaker setting is "NO", the test tone of the corresponding channel is not available.
- () : Possible depending on whether the surround back channel is set to "2 CH" or "1 CH".

2. At each channel, adjust the level as desired until the sound level of each speaker is heard to be equally loud.

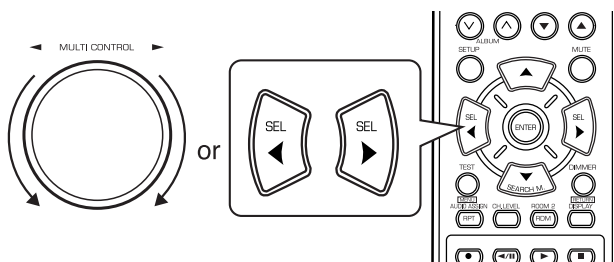

- You can select the desired channel with pressing the CONTROL UP/DOWN (\blacktriangle / \blacktriangledown) buttons or the CURSOR UP/DOWN (\blacktriangle / \blacktriangledown) buttons.

3. Cancel the test tone function.

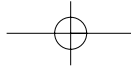
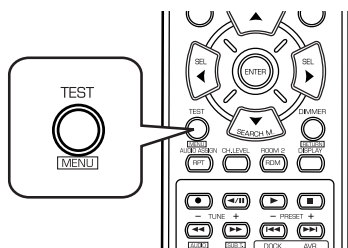

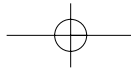

Adjusting the current channel level

- After adjusting each channel level with test tone, adjust the channel levels either according to the program sources or to suit your tastes.
- You can adjust the current channel levels as desired. These adjusted levels are just memorized into user's memory ("CAL"), not into preset memory ("REF 1", "REF 2").

1. Press the CHANNEL LEVEL button.

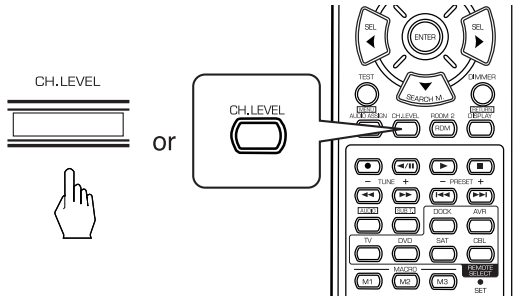

- Then the memory mode ("CAL", "REF 1", etc) is displayed for several seconds.
- When the memory mode or channel level disappears, press this button again.

2. Select the desired channel.

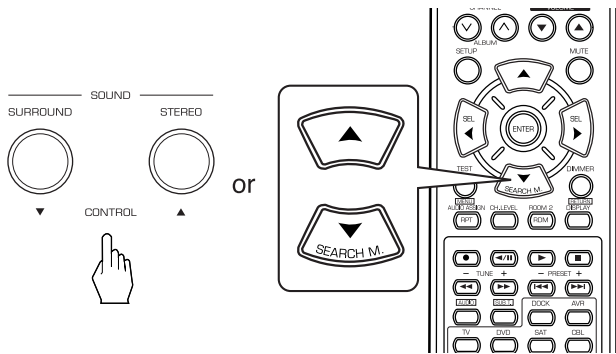

- Each time these buttons are pressed, the corresponding channel is selected as follows:

CAL (or REF 1, etc.) ↔ FL ← C ← FR ← SR
 <LFE> ↔ SUB ↔ SL(↔SB) or (↔SBL ↔ SBR)
 DTS LFE or Dolby Digital LFE

- () : Possible depending on whether the surround back channel is set to "2 CH" or "1 CH".
- < > : Possible only when the digital signals from Dolby Digital, DTS, Dolby TrueHD or DTS HD program sources that include LFE signal are input.

- Depending on the speaker settings("NO", etc.) and surround mode, etc., some channels cannot be selected.
- When the SPEAKER button is set to off, only the Front Left, Front Right(and LFE) channels can be selected.

3. Adjust the level of the selected channel as desired.

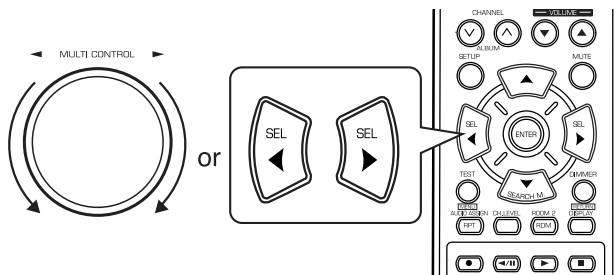

- The LFE level can be adjusted within the range of -10 ~ 0 dB and other channel levels within the range of -15 ~ +15 dB.
- In general, we recommend the LFE level to be adjusted to 0 dB.(However, the recommended LFE level for some early DTS software is -10 dB.) If the recommended levels seem too high, lower the setting as necessary.

4. Repeat the above steps 2 and 3 to adjust each channel level.

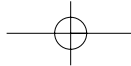

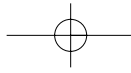

Memorizing the adjusted channel levels

- You can memorize the adjusted channel levels into preset memory("REF 1", "REF 2") and recall the memorized whenever you want.

- After performing the steps 1~4 in "Adjusting the current channel level" procedure on page 27, press the (MEMORY)/ENTER button.

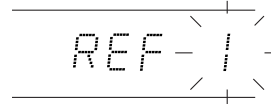
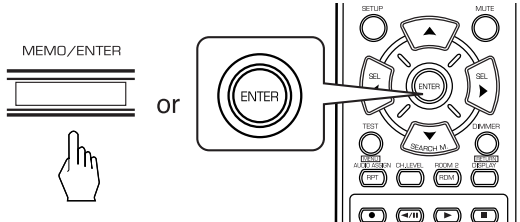

- The "1" of "REF 1" indication flickers for several seconds.

- Select the desired one of REF 1 and REF 2.

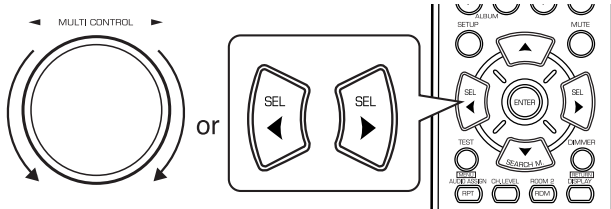

- If the preset memory disappears, perform the above step 1 again.

- Confirm your selection.

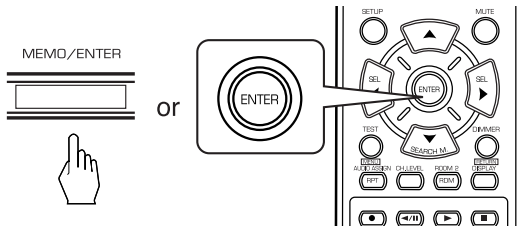

- The adjusted channel levels have now been memorized into the selected memory.

Recalling the memorized channel levels

- Press the CHANNEL LEVEL button.

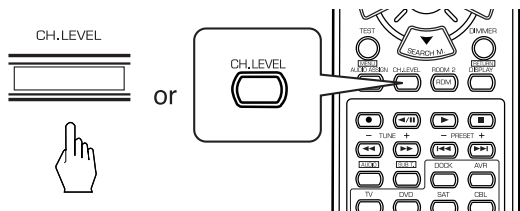

- "CAL" (or "REF 1", etc.) is displayed for several seconds.
- If the memory mode disappears, press this button again.

- Select the desired one of REF 1 and REF 2.

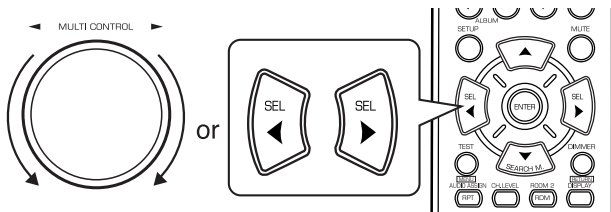

- Then the channel levels memorized into the selected preset memory are recalled.

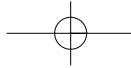

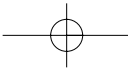

LISTENING TO RADIO BROADCASTS

Auto tuning

1. Select the desired band.

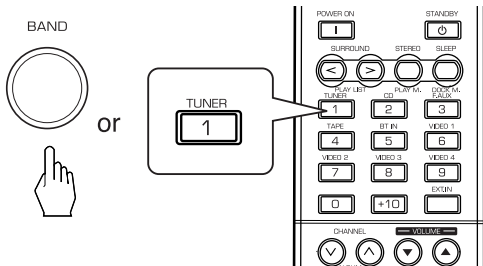

Each time this button is pressed, the band changes as follows :

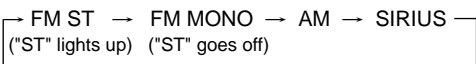

- When FM stereo broadcasts are poor because of weak broadcast signals, select the FM mono mode to reduce the noise, then FM broadcasts are reproduced in monaural sound.
- To listen to SIRIUS Satellite Radio, select SIRIUS mode. (For details, refer to "SIRIUS Satellite Radio (only for North America)" on page 31.)

2. Press the TUNING UP(+)/DOWN(-) buttons for more than 0.5 second.

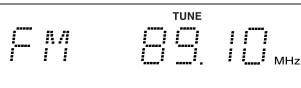
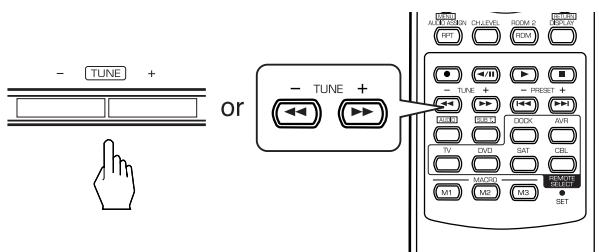

- The tuner will now search until a station of sufficient strength has been found. The display shows the tuned frequency and "TUNE".
- If the station found is not the desired one, simply repeat this operation.
- Weak stations are skipped during auto tuning.

Manual tuning

- Manual tuning is useful when you already know the frequency of the desired station.
- After selecting the desired band, press the TUNING UP(+)/DOWN(-) buttons repeatedly until the right frequency has been reached.

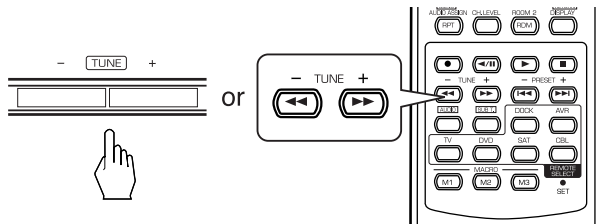

Auto presetting

- Auto presetting function automatically searches for FM stations only and store them in the memory.
- While listening to FM or AM radio broadcasts, press and hold down the (MEMORY)/ENTER button for more than 2 seconds.

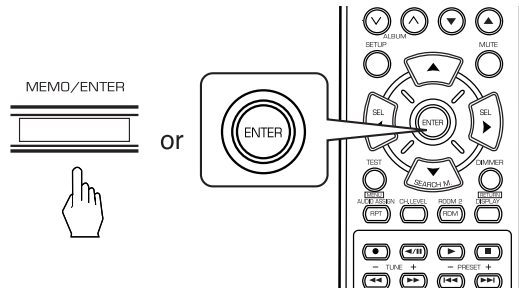

- Then "AUTO MEM" flickers and this receiver starts auto presetting.
- To stop auto presetting, press this button again.
- Up to 30 FM stations can be stored.

■ Notes:

- FM stations of weak strength cannot be memorized.
- To memorize AM stations or weak stations, perform "Manual presetting" procedure with using "Manual tuning" operation.

ENGLISH

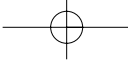

Manual presetting

- You can store up to 30 preferred stations in the memory.

1. Tune in the desired station with auto or manual tuning.

2. Press the (MEMORY)/ENTER button.

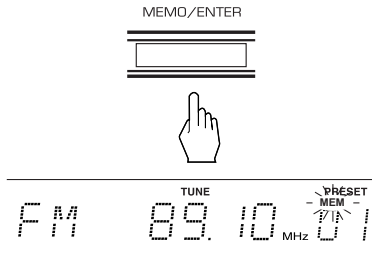

- "MEM" is flickering for several seconds.

3. Select the desired preset number (1~30) and press the (MEMORY)/ENTER button.

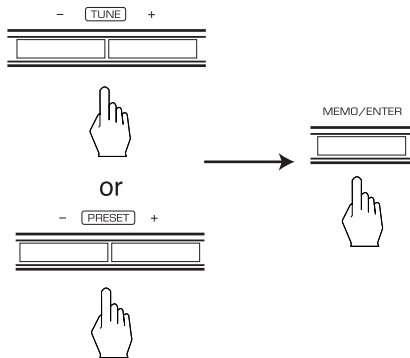

- The station has now been stored in the memory.
- A stored frequency is erased from the memory by storing another frequency in its place.
- If "MEM" goes off, start again from the above step 2.

4. Repeat the above steps 1 to 3 to memorize other stations.

■ MEMORY BACKUP FUNCTION

The following items, set before the receiver is turned off, are memorized.

- INPUT SELECTOR settings
- Surround mode settings
- Preset stations, etc.

Tuning to preset stations

- After selecting the tuner as an input source, select the desired preset number.

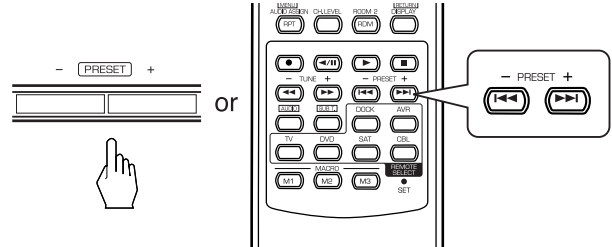

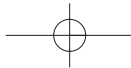

SIRIUS Satellite Radio (only for North America)

- This receiver is a SIRIUS Satellite Radio Ready® receiver. You can receive SIRIUS® Satellite Radio by connecting to the SiriusConnect Home Tuner kit (sold separately) and subscribing the SIRIUS service.

■ What SIRIUS Satellite Radio ?

Simpl The Best Radio on Radio™ with all your favorite entertainment including 100% commercial-free music, plus superior sports coverage, uncensored talk and comedy, world-class entertainment, news, weather and more for your car, home or office. For more information, visit sirius.com or siriuscanada.ca

Sirius is available in the US for subscribers with address in the continental US and is available in Canada for subscribers with a Canadian address. Required subscription plus compatible SIRIUS tuner and antenna are required and sold separately. SIRIUS Programming is subject to change. Visit sirius.com for the most complete and up-to-date channel lineup and product information.

"SIRIUS" and the SIRIUS dog logo and related marks are trademarks of Sirius Satellite Radio Inc. All rights reserved.

LISTENING TO SIRIUS SATELLITE RADIO

Signing up for SIRIUS Satellite Radio

- Before using SIRIUS Satellite Radio, you must first sign up for an account. You will need a major credit card and your SIRIUS Satellite Radio ID, which you can get from this receiver, as explained below, or from the SiriusConnect Home tuner package.

1. Press the BAND button or the TUNER button repeatedly until the SIRIUS mode is selected.

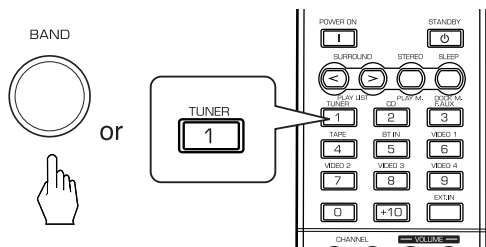

- Then SR ~ is displayed.

2. Press the TUNING UP(+)/DOWN(-) buttons repeatedly to select SR 000.

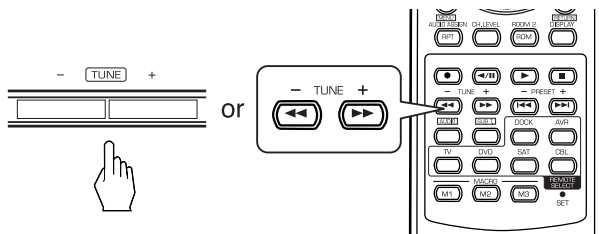

- Then your SIRIUS Satellite Radio ID is displayed. Write it below.
SIRIUS ID : _____

3. To sign up, access the website at "<http://activate.siriusradio.com>" or call "1-888-539-SIRIUS(7474)".

Channel search

- In the SIRIUS mode, press the TUNING UP(+)/DOWN(-) buttons repeatedly to select the desired channel.

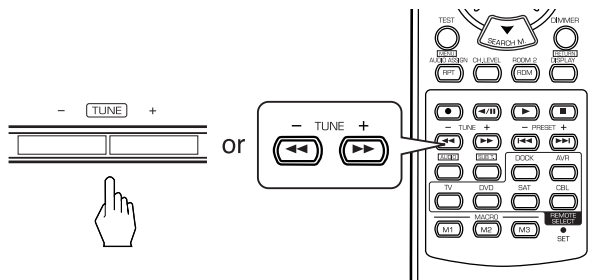

■ When some channels are skipped

- Press and hold down the AUDIO ASSIGN button on the front panel for more than 3 seconds.

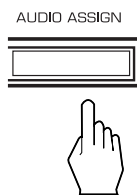

- Then the skipped channels are rest.

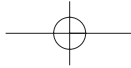

Direct search

- You can select a SIRIUS Satellite Radio channel directly by entering its number.

- In the SIRIUS mode, press the SEARCH MODE button to select the direct search mode, then press the ENTER button.

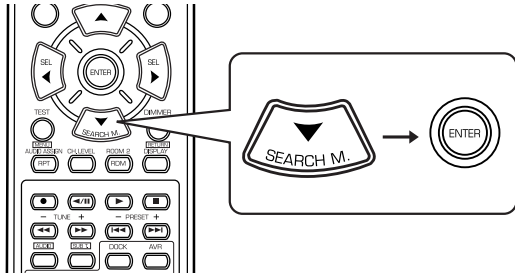

- Each time the SEARCH MODE button is pressed, the search mode changes as follows:

DIR SRCH → CAT SRCH → OFF
 (Direct search) (Category search)

- Then "SR - - -" is displayed.

- While displaying "SR - - -", select the desired channel number with pressing the NUMERIC (0~9) buttons.

Examples:

For "3" : 3

For "27" : 2 within 4 seconds → 7

For "124" : 1 within 4 seconds → 2 within 4 seconds → 4

- When "SR - - -" disappears, repeat again from the above step 1.

Category search

- Category search allows you to select the desired channel by the selected category.

- In the SIRIUS mode, press the SEARCH MODE button to select the category search mode, then press the ENTER button.

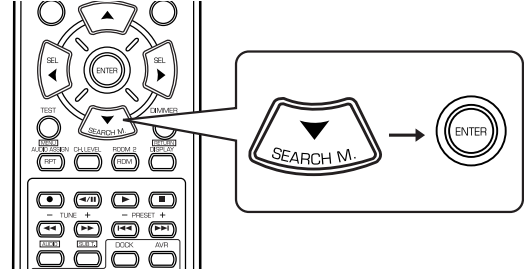

- Then a category is displayed.

- While displaying a category name, select the desired category, then press the ENTER button.

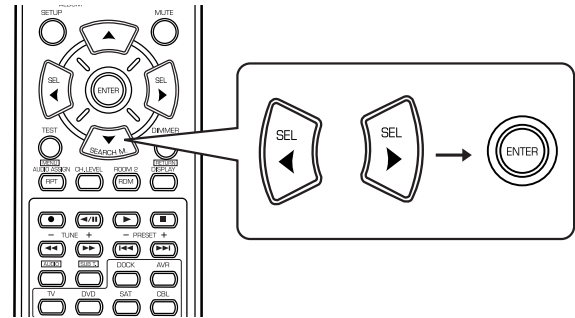

- Each time the SELECT ◀/▶ buttons are pressed, one of different categories is selected.
- When a category name disappears, repeat again from the above step 1.

- While displaying the selected category, select the desired channel.

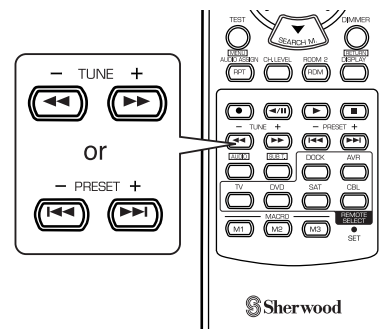

Parental lock

- You can lock the channels that you do not want to receive or unlock the previously locked channels.

1. Tune in the channel you want to lock or unlock.

■ When tuning in the previously locked channels.

- Tune in the channels to which the parental lock is applied by performing direct search or preset search only.
- Then "CODE ****" is displayed for several seconds.
- While displaying "CODE ****", input the password (4-digit number) with using the NUMERIC (0~9) buttons.

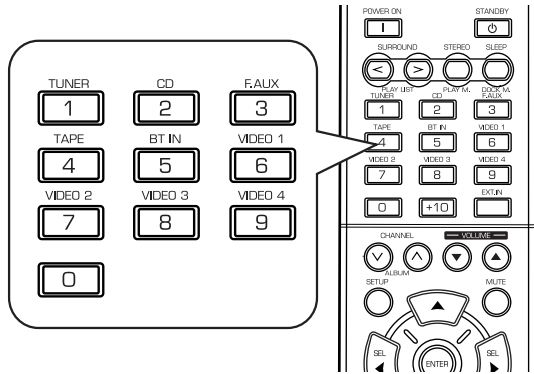

- When you input the correct code, the current channel can be heard (not be unlocked).
- If the wrong password is input, "CODE ERR(OR)" is displayed. In this case, input the password again by performing the steps ① and ②.
- When "CODE ****" disappears, repeat again from the above step ①.

2. Press and hold down the ENTER button for more than 3 seconds.

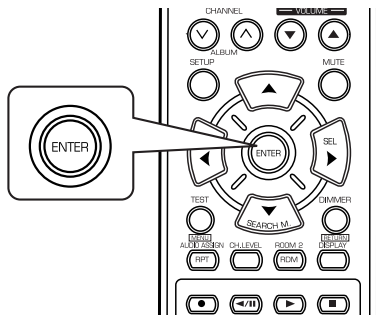

- Then "CODE ****" is displayed for several seconds.

3. While displaying "CODE ****", input the password (4-digit number) with using the NUMERIC (0~9) buttons.

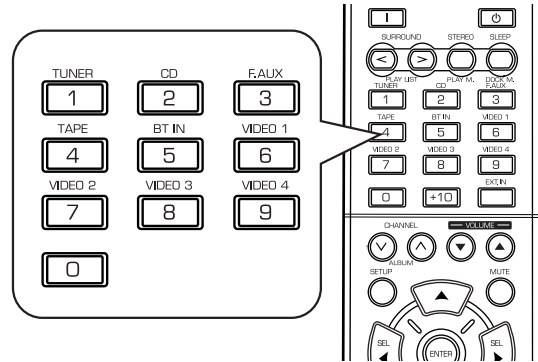

- When you input the correct code, the current channel is locked or unlocked.
- If the wrong password is input, "CODE ERR(OR)" is displayed. In this case, input the password again by performing the steps 2 and 3.
- When "CODE ****" disappears, repeat again from the above step 2.

■ Notes:

- The default password is "0000". You can change this password to new one. (For details, refer to "When selecting the EDIT LOCK CODE" on page 50.)
- You can also set the parental lock on the INPUT SETUP menu. (For details, refer to "When selecting the PARENTAL LOCK" on page 49.)
- The channels to which the parental lock is applied cannot be tuned in by performing channel search or category search.

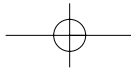

RECORDING

- The analog signals from the EXTERNAL INs as well as the digital signals from the HDMI IN, the OPTICAL or the COAXIAL DIGITAL IN can be heard but cannot be recorded.
- When recording the analog signals from CD, F.AUX, VIDEO 1~3, be sure to select "ANALOG" for the AUDIO MODE. (For details, refer to "When selecting the AUDIO MODE" on page 46.)
- The volume and tone (bass, treble) settings have no effect on the recording signals.

Dubbing from video components onto VIDEO 1

1. Select the desired of VIDEO 2(/iPod) ~ 3 as a recording source except VIDEO 1.

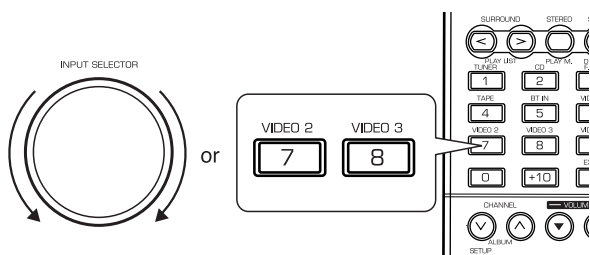

2. Start recording on the VIDEO 1.

3. Start play on the desired input.

- The audio and video signals from the desired input will be dubbed onto the VIDEO 1 and you can enjoy them on the TV set and from the speakers.

■ To record audio signals

- Connect the AUDIO IN/OUT jacks of "VIDEO 1" to audio recording equipment such as a tape deck, an MD recorder, etc. and select the desired of tuner, CD, F.AUX, TAPE, BT and VIDEO 2(/iPod)~3 as a recording source. Then you can record the audio signals from the selected input.

Dubbing the audio and video signals separately onto VIDEO 1

■ Note :

- To dub the audio and video signals separately, you should select these recording sources with pressing the INPUT SELECTOR buttons on the remote control, not the INPUT SELECTOR knob on the front panel.

Example: When dubbing the VIDEO 2(/iPod) video signal and the CD audio signal separately onto VIDEO 1.

1. Select VIDEO 2/iPod as a video recording source.

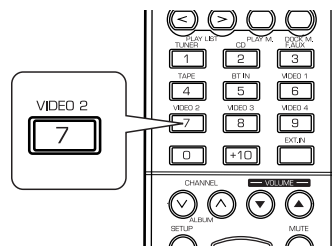

2. Select CD as an audio recording source.

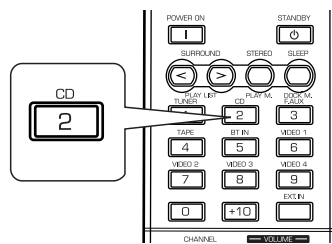

3. Start recording on the VIDEO 1.

4. Start play on the VIDEO 2/iPod and the CD respectively.

- The audio signal from the CD and the video signal from the VIDEO 2/iPod will be dubbed and you can enjoy them on the TV set and from the speakers.

■ Note :

- Be sure to observe the order of the above steps 1 and 2.

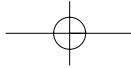

DIGITAL AUDIO RECORDING WITH MD RECORDER

- Only when the OPTICAL DIGITAL OUT of this receiver is connected to the OPTICAL DIGITAL IN of the MD recorder or CD recorder, you can enjoy high-quality sound of digital recording without converting the original signals. Refer to "CONNECTING VIDEO COMPONENTS", "CONNECTING AUDIO COMPONENTS" and "CONNECTING DIGITAL INS AND OUT" on pages 6 ~8 and the operating instructions of the MD recorder or CD recorder.

■ Notes:

- Depending on the digital audio signal format input into the HDMI IN connector, some digital signals cannot be output from the OPTICAL DIGITAL OUT jack.
- Digital recording is available for the digital audio program sources such as CDs, MDs, some DVDs, etc.
- There are some restrictions on recording digital signals. When making digital recordings, refer to the operating instructions of your digital recording equipment to know what restrictions are imposed.

1. Select the desired of CD, F.AUX, VIDEO 1~3 as a recording source.

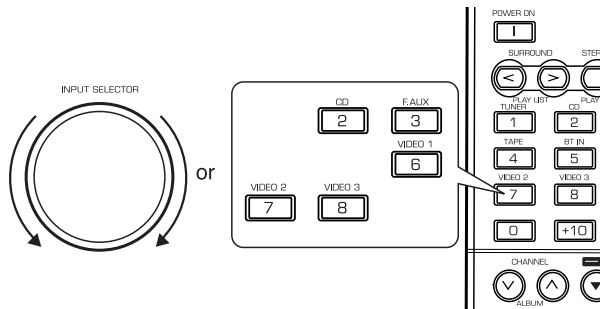

■ In case of recording the digital audio signal input into a HDMI IN connector

- Select the desired recording source to which the HDMI IN is connected and assigned and then perform the steps 3 and 4 (, but ignore the step 2).

■ Note :

- If the AUDIO MODE is set to the mode other than "HDMI" for the corresponding recording source on the INPUT SETUP menu, the digital audio signals will not be output and there will be no recording. (For details, refer to "When selecting the AUDIO MODE" on page 46.)

2. For digital recording, select the digital input as recording signal input.

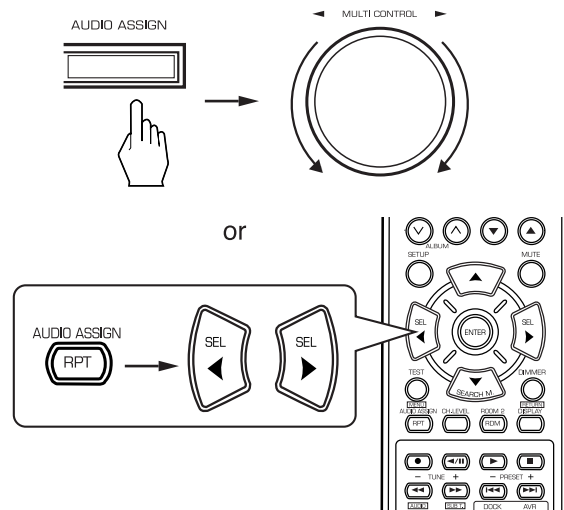

■ Note :

- If the AUDIO MODE is set to the mode other than "DIGITAL" for the corresponding recording source on the INPUT SETUP menu, the digital audio signals from the selected digital input will not be output and there will be no recording. (For details, refer to "When CD, F.AUX, VIDEO 1~3 is selected as an input source" on page 22 and "When selecting the AUDIO MODE" on page 46.)

3. Start recording on the component connected to the OPTICAL DIGITAL OUT.

4. Start play on the desired input.

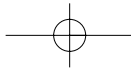

OTHER FUNCTIONS

Operating the sleep timer

- The sleep timer allows the system to continue to operate for a specified period of time before automatically shutting off.
- To set the receiver to automatically turn off after the specified period of time.

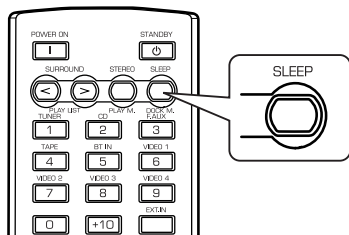

- Each time this button is pressed, the sleep time changes as follows:

10 → 20 → 30 → --- → 90 → OFF
Unit : minutes

- While operating the sleep timer, "  " lights up.
- When the sleep time is selected, the fluorescent display is dimly lit.

Adjusting the brightness of the fluorescent display

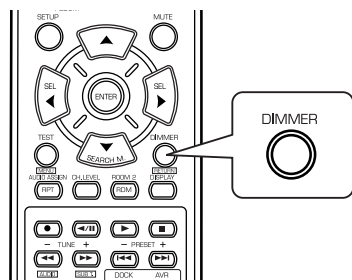

- Each time this button is pressed, the brightness of the fluorescent display changes as follows:

ON → dimmer → OFF

- In the display OFF mode, pressing any button will restore the display ON mode.

Displaying the operation status

During playback,

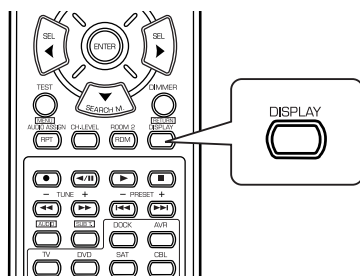

- Each time this button is pressed, the display mode changes as follows:

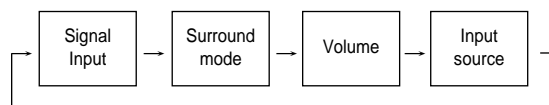

- When the EXTERNAL IN is selected as an input source, the surround mode is not displayed.
- When SIRIUS Satellite Radio function is available in your country, for details on the SIRIUS information, see "Displaying SIRIUS information" on page 33.

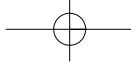

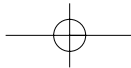

ROOM 2 SOURCE PLAYBACK

- This function allows enjoying one source in the main room and playing another in a different room at the same time.

■ Notes:

- The analog signals from the EXTERNAL INs and the digital signals cannot be output to the different room, meaning no playback in a different room.
- Only the (composite) video signals can be output to the different room.

ENGLISH

1. Press the ROOM 2 button to enter the ROOM 2 mode.

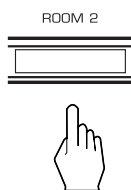

- ROOM 2 ~ is displayed for several seconds.
- When the ROOM 2 setting mode disappears, press the ROOM 2 button again.

2. Select the desired mode while displaying the ROOM 2 setting mode.

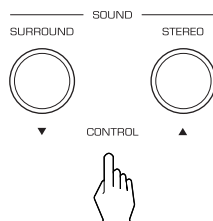

- Each time these buttons are pressed, the mode changes as follows :
 - ROOM 2 ~ : To turn on or off the ROOM 2 function. (ROOM 2 mode)
 - ↑ ↓
 - IN ~ : To select the desired ROOM 2 source. (ROOM 2 input)
 - ↑ ↓
 - VOL ~ : To adjust the volume on the power amplifier assigned to "BACK← →ROOM 2" or "ROOM 2". (ROOM 2 volume)

■ Note :

- When the ROOM 2 mode is set to OFF, the ROOM 2 input and the ROOM 2 volume cannot be selected.

■ Notes:

- When the EXTERNAL IN is selected as a main input, if the MAIN source is selected as a ROOM 2 input, no audio signal can be heard in the different room (ROOM 2).
- Even when this receiver enters the standby mode, in such a case that "R2" lights up still and the STANDBY indicator lights up blue as it does in the operating mode, meaning only the ROOM 2 circuitry operates, the ROOM 2 source can be played independently.
- When you do not use the ROOM 2 function, turn off the ROOM 2 function to save electricity.

3. Set the selected mode as desired.

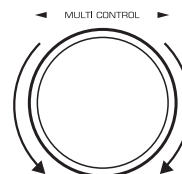

■ When selecting the ROOM 2 mode.

ON : To turn on the ROOM 2 function.

↑ ("R2" lights up.)

OFF : To turn it off. ("R2" goes off.)

- You can also set the ROOM 2 mode to ON or OFF with pressing the ROOM 2 button on the remote control.

■ When selecting the ROOM 2 input.

- You can select the desired among MAIN source, TUNER, CD, F.AUX, TAPE, BT(Bluetooth IN), VIDEO 1 ~ VIDEO 3 as a ROOM 2 source.

■ When selecting the ROOM 2 volume.

- You can adjust the volume on the power amplifier assigned to "BACK← →ROOM 2" or "ROOM 2" when the ROOM 2 speaker terminals are connected to the speakers in a different room. (For details, refer to "When selecting the AMP ASSIGN" on page 41.)

4. Start play on the component related to the ROOM 2 source.

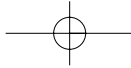

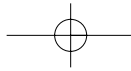

OSD Menu Settings

- The OSD (On-Screen Display) menu is a setting menu that is displayed on the monitor TV and allows you to perform the setup procedures easily. In most situations, you will only need to set this once during the installation and layout of your home theater, and it rarely needs to be changed later.

The OSD menu consists of 6 main menus ; system setup, input setup, speaker / room EQ setup, CH level setup, sound parameter and multi room setup. These menus are then divided up into various sub-menus.

■ Note:

- The OSD menu and the momentary OSD can be displayed via the (composite) VIDEO MONITOR OUT only.

■ Navigating through the OSD menu

- The explanations here assume you are using the buttons on the remote control when performing the OSD menu operation. However, you can use the buttons on the front panel as well.

The buttons on the front panel correspond to those on the remote control as shown below.

Button on the remote control				
Button on the front panel				

1. Turn the menu screen on.

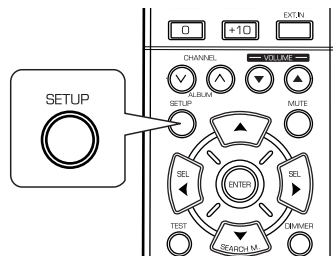

- The main menu will be shown.
- To turn the menu screen off, press this button again.

MAIN MENU	
> SYSTEM	SETUP
INPUT	SETUP
SPEAKER	
/ROOM EQ	SETUP
CH LEVEL	SETUP
SOUND	PARAMETER
MULTI ROOM	SETUP
EXIT	

2. Select the desired menu using the CURSOR UP(▲)/DOWN(▼) buttons.

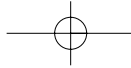
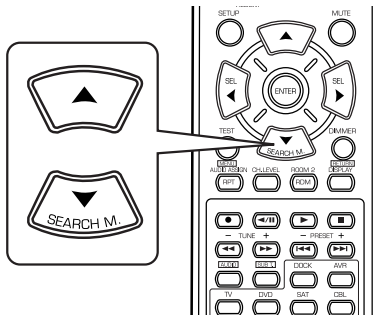

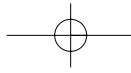

3. Confirm your selection.

ENGLISH

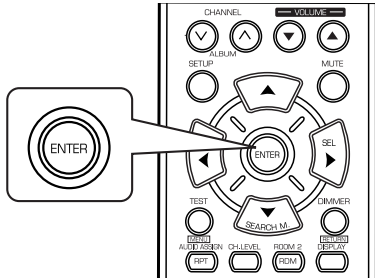

■ When selecting the SYSTEM SETUP

```

SYSTEM SETUP
>AMP ASSIGN : BACK←→ROOM2
SUB W MODE : NORMAL
HDMI AUDIO OUT : OFF
TONE CONTROL : OFF
CINEMA EQ : OFF
MOMENTARY OSD : ON
OSD POSITION ADJUST

RETURN TO MAIN MENU
  
```

41

■ When selecting the INPUT SETUP

```

INPUT SETUP
>VIDEO 1 CONFIG
V2/iPod CONFIG
VIDEO 3 CONFIG
BT CONFIG
CD CONFIG
TAPE CONFIG
F.AUX CONFIG
TUNER CONFIG
EXT . IN CONFIG

RETURN TO MAIN MENU
  
```

45

■ When selecting the SPEAKER/ROOM EQ SETUP

```

SPEAKER/R . EQ SETUP
>AUTO SETUP

SPEAKER CONFIG
SPEAKER DISTANCE
SPEAKER CROSSOVER
ROOM EQ SETUP

RETURN TO MAIN MENU
  
```

51

■ When selecting the CH LEVEL SETUP

```

CH LEVEL SETUP
>MODE : CALIBRATE
FRONT LEFT : 0dB
CENTER : 0dB
FRONT RIGHT : 0dB
SURR RIGHT : 0dB
BACK/MULTI R : 0dB
BACK/MULTI L : 0dB
SURR LEFT : 0dB
SUBWOOFER : 0dB
LFE LEVEL SETUP
RETURN TO MAIN MENU
  
```

57

■ When selecting the SOUND PARAMETER

```

SOUND PARAMETER
>NIGHT MODE
DOLBY PLII MUSIC

RETURN TO MAIN MENU
  
```

59

■ When selecting the MULTI ROOM SETUP

```

MULTI ROOM SETUP
>ROOM 2 : OFF
INPUT : MAIN
VOLUME : ---

RETURN TO MAIN MENU
  
```

61

- For the setting details, see page in ⇨.
- Adjust the setting(s) in each setting category to your preference.
- When the SETUP button is pressed on a sub-menu, the menu screen will be turned off.

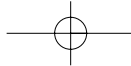

SETTING THE SYSTEM SETUP

SYSTEM SETUP

>AMP ASSIGN : BACK← → ROOM2
 SUB W MODE : NORMAL
 HDMI AUDIO OUT : OFF
 TONE CONTROL : OFF
 CINEMA EQ : OFF
 MOMENTARY OSD : ON
 OSD POSITION ADJUST

RETURN TO MAIN MENU

- AMP ASSIGN : To assign the surround back channels' power amplifier correctly depending on how to use the speakers.
- SUBWOOFER MODE : To select the desired subwoofer mode.
- HDMI AUDIO OUT : To output the digital audio signals from the HDMI MONITOR OUT connector.
- TONE CONTROL : To adjust the tone (bass and treble) as desired.
- CINEMA EQ : To select the desired cinema EQ mode.
- MOMENTARY OSD : To turn on or off the OSD that shows the status corresponding to each operation momentarily.
- OSD POSITION ADJUST : To adjust the position of the momentary OSD and the OSD menu.

ENGLISH

When selecting the items other than OSD POSITION ADJUST

1. Press the CURSOR UP(▲)/DOWN(▼) buttons to select the desired item.

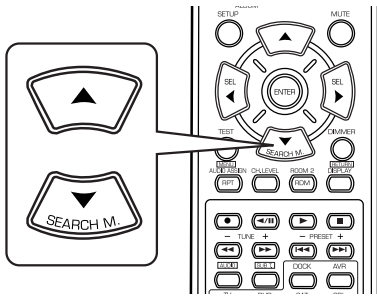

2. Press the CURSOR LEFT(◀)/RIGHT(▶) buttons to set the selected item as desired.

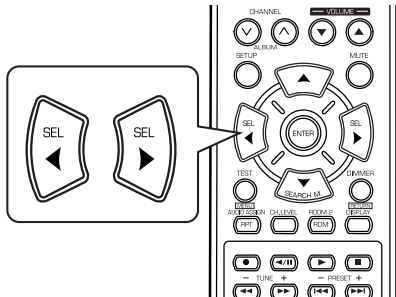

■ When selecting the AMP ASSIGN

- The surround back channels' power amplifier can drive the surround back speakers, the ROOM 2 speakers or the front bi-amp capable speakers. Depending on how to use the speakers, you should assign the power amplifier correctly. (For details, refer to "CONNECTING SPEAKERS" on page 9 and "CONNECTING ROOM 2 OUTS" on page 11.)

- BACK ← ROOM 2 : When connecting this receiver to the surround back speakers and the ROOM 2 speakers both, the power amplifier automatically drives the surround back speakers or the ROOM 2 speakers depending on whether the ROOM 2 function is turned off or on.
- BI - AMP : To drive the front bi-amp capable speakers when connecting the FRONT and the SURROUND BACK/MULTI channels to them.
- SURR BACK : To drive the surround back speakers when connecting the SURROUND BACK/MULTI channels to them.
- ROOM 2 : To drive the ROOM 2 speakers when connecting the ROOM 2 channels to them.

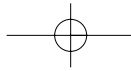

Continued

■ When selecting the SUBWOOFER MODE

- "SW PLUS +" mode is valid only when "FRONT" and "CENTER" are set to "FULL RANGE" and "SUBWOOFER" is set to "YES" on the SPEAKER/ROOM EQ SETUP menu. (For details, refer to "SETTING THE SPEAKER/ ROOM EQ SETUP" on page 51.)

NORMAL : When the low frequency signals of channels set to "FULL RANGE " are reproduced from those channels only. In this mode, the low frequency signals that are reproduced from the subwoofer channel is only the low frequency signals of LFE (from the multi-channel sources that contains LFE (Low Frequency Effects) channel, also called the ".1" channel) and the channels set to the setting value other than "FULL RANGE".

SW PLUS + : When the low frequency signals of channels set to "FULL RANGE" are reproduced simultaneously from those channels and the subwoofer channel.

In this mode, the low frequency range expands more uniformly through the room, but depending on the size and shape of the room, interference may result in a decrease of the actual volume of the low frequency range.

■ When selecting the HDMI AUDIO OUT

- The HDMI connection can carry uncompressed digital video signals and digital audio signals.

Depending on whether the digital audio signals input into the HDMI IN are output from the HDMI MONITOR OUT of this receiver or not, you should set the HDMI AUDIO OUT correctly.

OFF : Not to output the HDMI digital audio signals from the HDMI MONITOR OUT of this receiver, meaning these

↓ signals are heard from the speakers connected to this receiver.

ON : To output the HDMI digital audio signals from the HDMI MONITOR OUT, meaning these signals are heard from the speakers of your TV.

■ Note:

- When the HDMI AUDIO OUT is set to ON, no sound will be heard from the speakers connected to this receiver (except ROOM 2 speakers) even though any input source is selected.

■ When selecting the TONE CONTROL

OFF : To listen to a program source without the tone effect. ("DIR" lights up.)

↓

ON : To adjust the tone for your taste. ("DIR" goes off.)

- ◆ When the TONE CONTROL is set to ON to adjust the tone (bass and treble)

①. Press the ENTER button to enter the tone adjustment mode.

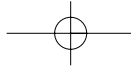
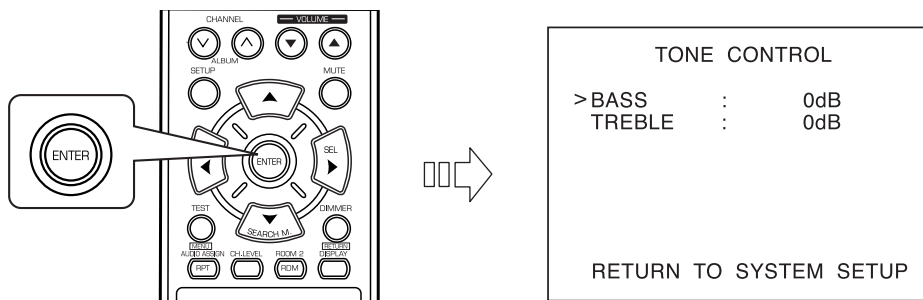

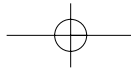

Continued

- ②. Press the CURSOR UP(▲)/DOWN(▼) buttons to select the desired tone mode.

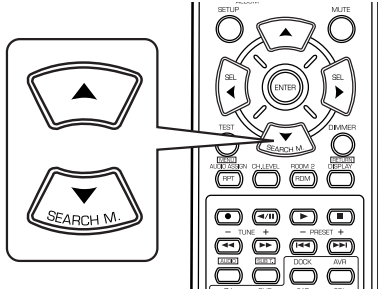

- ③. Press the CURSOR LEFT(◀)/RIGHT(▶) buttons to adjust the selected tone as desired.

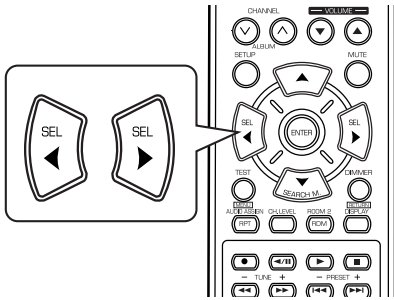

- The tone level can be adjusted within the range of -10 ~ +10 dB.
- In general, we recommend the bass and treble to be adjusted to 0 dB (flat level).
- Extreme settings at high volume may damage your speakers.
- To complete tone adjustment, repeat the above steps ② and ③.

■ When selecting the CINEMA EQ

OFF : To turn off the cinema EQ function.



ON : To compensate for edgy or shrill movie sound tracks.

■ When selecting the MOMENTARY OSD

ON : To turn on the OSD function that shows the status corresponding to each operation on this unit momentarily.



OFF : To turn it off.

■ Note :

- The OSD menu and the momentary OSD can be displayed via the (composite) VIDEO MONITOR OUT only.

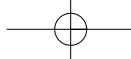

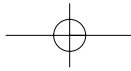

When selecting the OSD POSITION ADJUST

- You can adjust the position of the momentary OSD and the OSD menu that are displayed on the monitor TV.

ENGLISH

- Press the CURSOR UP(▲)/DOWN(▼) buttons to select the OSD POSITION ADJUST, then press the ENTER button.

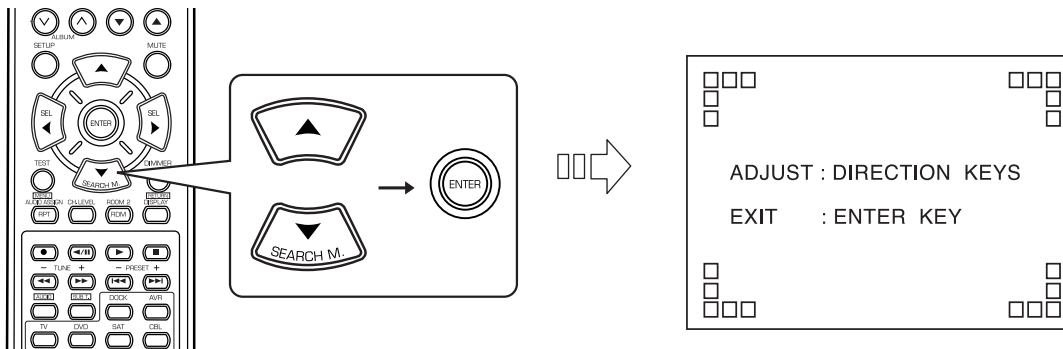

- Press the CURSOR UP(▲)/DOWN(▼)/LEFT(◀)/RIGHT(▶) buttons to adjust the position of the momentary OSD and the OSD menu as desired.

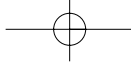
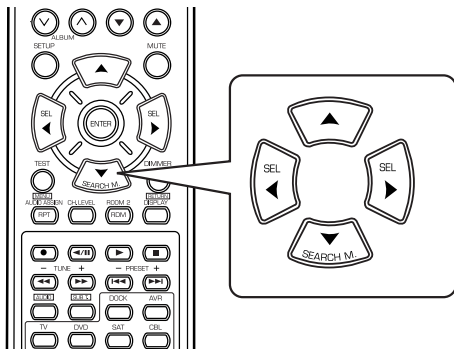

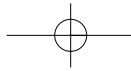

SETTING THE INPUT SETUP

INPUT SETUP	
>VIDEO 1	CONFIG
V2/iPod	CONFIG
VIDEO 3	CONFIG
BT	CONFIG
CD	CONFIG
TAPE	CONFIG
F.AUX	CONFIG
TUNER	CONFIG
EXT . IN	CONFIG
RETURN TO MAIN MENU	

- This menu allows you to make the various settings depending on how to use the input sources connected to this receiver.

ENGLISH

When selecting the items other than NAME, PARENTAL LOCK, EDIT LOCK MODE

1. Press the CURSOR UP(▲)/DOWN(▼) buttons to select the desired input source, then press the ENTER button.

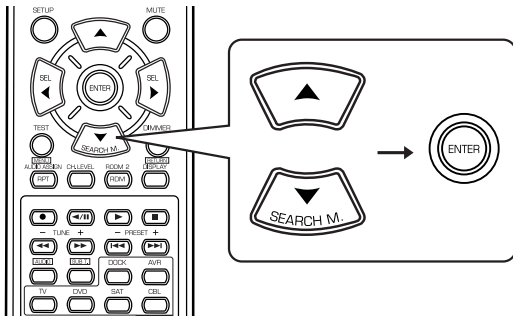

Example: When selecting the VIDEO 1

```

VIDEO 1  CONFIG
>NAME      : VIDEO 1
HDMI ASSIGN : HDMI 1
VIDEO ASSIGN : COMP 1
AUDIO ASSIGN : OPT 1
AUDIO MODE  : AUTO
  
```

Page 1



```

AUTO SURROUND : OFF
AV SYNC.       : 0 ms
DC TRIGGER     : OFF
HD AUDIO       : ON
  
```

Page 2

■ When selecting the menu of page 2 or page 1.

- Press the CURSOR UP(▲)/DOWN(▼) buttons to select "GO TO NEXT ~", then press the ENTER button.

2. Press the CURSOR UP(▲)/DOWN(▼) buttons to select the desired item.

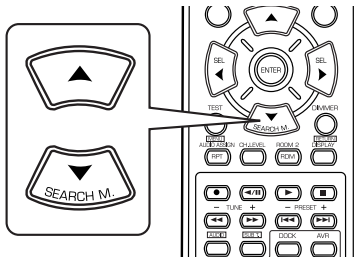

■ Note :

- Depending on the input source, some items other than DC TRIGGER cannot be selected.

3. Press the CURSOR LEFT(◀)/RIGHT(▶) buttons to set the selected item as desired.

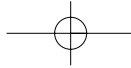
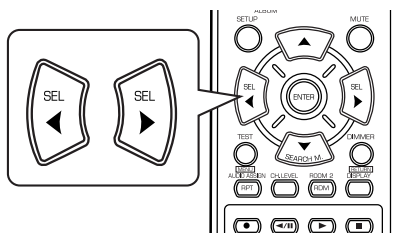

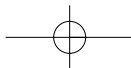

Continued

■ When selecting the HDMI ASSIGN

- You should assign the connected HDMI INs to the desired of VIDEO 1 ~ VIDEO 3.
(For details, refer to "CONNECTING VIDEO COMPONENTS" on pages 6 ~ 7.)
- You can select the desired of HDMI 1 ~ HDMI 3.

■ Note :

- In such a case that a HDMI IN is assigned to two input sources or more, when these input sources are selected, the uncompressed digital video signals (and digital audio signals when the HDMI AUDIO OUT is set to ON) input into the same HDMI IN can be output from the HDMI MONITOR OUT of this receiver.

■ When selecting the VIDEO ASSIGN

- You should assign the connected COMPONENT VIDEO INs to the desired of VIDEO 1 ~ 3.
(For details, refer to "CONNECTING VIDEO COMPONENTS" on pages 6 ~ 7.)
- You can select the desired of COMP 1 ~ 2.

■ Note :

- In such a case that a COMPONENT VIDEO IN is assigned to two input sources or more, when these input sources are selected, the component video signals can be viewed from the same COMPONENT VIDEO IN.

■ When selecting the AUDIO ASSIGN

- You should assign the connected DIGITAL INs to the desired of CD, F.AUX and VIDEO 1 ~ VIDEO 3.
(For details, refer to "CONNECTING DIGITAL INs AND OUT" on page 8.)
- You can select the desired of OPT 1 ~ 2 and COAX 1 ~ 2.

■ Note :

- In such a case that a DIGITAL IN is assigned to two input sources or more, when these input sources are selected, the digital audio signals can be heard from the same DIGITAL IN.

■ When selecting the AUDIO MODE

- You can select the desired audio input signal to be played.

■ Notes :

- Be sure to set the AUDIO MODE to the audio input which is connected and assigned to the selected input source.
- When the HDMI AUDIO OUT is set to ON, no sound will be heard from the speakers connected to this receiver (except ROOM 2 speakers).
- When the AUDIO MODE is set to HDMI, you should connect the HDMI INs and set the HDMI ASSIGN correctly. If not, the HDMI input flickers on the unit's display and no sound will be heard.
- When the AUDIO MODE is set to DIGITAL, you should connect the DIGITAL INs and set the AUDIO ASSIGN correctly. If not, the digital input flickers on the unit's display and no sound will be heard.

- AUTO : When there are multiple audio input signals, the audio input signals are detected and the audio input signal to be played is selected automatically in the priority order of them :
↓
HDMI audio > DIGITAL audio > ANALOG audio
- HDMI : The signal that is input into the HDMI IN is always played.
↓
- DIGITAL : The signal that is input into the OPTICAL or the COAXIAL DIGITAL IN is always played.
↓
- ANALOG : The signal that is input into the analog AUDIO INs is always played.

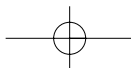

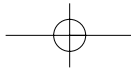

Continued

■ When selecting the AUTO SURROUND

- Depending on how to select a surround mode, you can select the auto surround mode or the manual surround mode.

ON : The optimum surround mode will be automatically selected depending on the signal
(Auto surround mode) format being input.

↓

OFF : You can select the desired of different surround modes selectable for the signal being
(Manual surround mode) input with using the MULTI CONTROL knob or the SURROUND MODE UP/DOWN (>/<) buttons. (For details, refer to "When selecting the manual surround mode with pressing the SURROUND MODE button on the front panel" on page 25.)

■ Notes :

- Even when the auto surround mode is selected and the same type of digital signal format is being input, the optimum surround mode may vary depending on whether the speaker type is set to "NO" or not.
- When the auto surround mode is selected, the surround modes other than the optimum surround mode cannot be selected.

■ When selecting the AV SYNC

- There may be a slight time delay between the video and audio signals in case that some video playback equipments may process the video signals later than the audio signals due to signal processing procedure, etc.. Should this happen, you can adjust the time delay of audio signals to synchronize the sound with the picture.
- The time delay can be adjusted within the range of 0 ~ 200 msec.

■ When selecting the DC TRIGGER

- To turn on the component connected to the DC TRIGGER OUT jack when this input source is selected, you should set the DC TRIGGER to ON for this input source.

OFF : To turn off the DC trigger function.

↓

ON: To turn it on.

- For details, refer to "CONNECTING DC TRIGGER OUT" on page 11.

■ When selecting the HD AUDIO

- When the source components that cannot support the HD audio signal format (such as Dolby Digital Plus, Dolby TrueHD, DTS-HD High Resolution Audio, DTS-HD Master Audio, etc.) are connected to the HDMI IN of this receiver, some components may not output any audio signals from its HDMI OUT.

In this case, you should set the HD AUDIO to OFF to play the audio signals other than the HD audio signals. (For details on the audio signal format, refer to the operating instructions of the source component.)

ON : To play the audio signals (including the HD audio signals).

↓

OFF : To play the audio signals other than the HD audio signals.

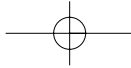

ENGLISH

When selecting the NAME

- You can give names to the input sources other than tuner.
- Up to 7 characters can be entered for each name.

1. Press the CURSOR UP(▲)/DOWN(▼) buttons to select the desired input source, then press the ENTER button.

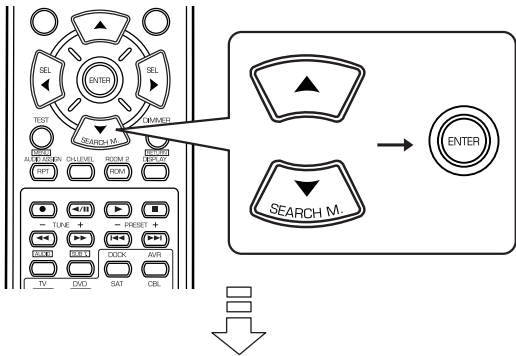

Example: When selecting the VIDEO 1

```

VIDEO 1  CONFIG
>NAME    : VIDEO 1
HDMI ASSIGN : HDMI 1
VIDEO ASSIGN : COMP 1
AUDIO ASSIGN : OPT 1
AUDIO MODE  : AUTO
    
```

2. Press the CURSOR UP(▲)/DOWN(▼) buttons to select the NAME, then press the ENTER button.

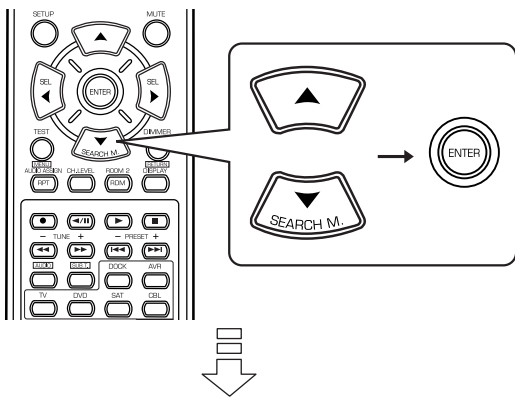

```

VIDEO 1  CONFIG
>NAME    : VIDEO 1
    
```

- The first digit flickers.

3. Press the CURSOR LEFT(◀)/RIGHT(▶) buttons to select the desired digit.

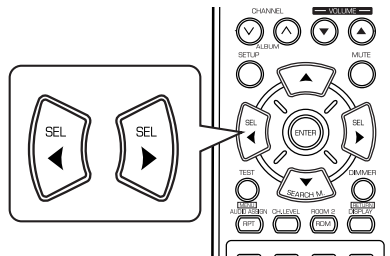

- Then the selected digit will flicker.

4. Press the CURSOR UP(▲)/DOWN(▼) buttons to enter the desired character on the flickering digit.

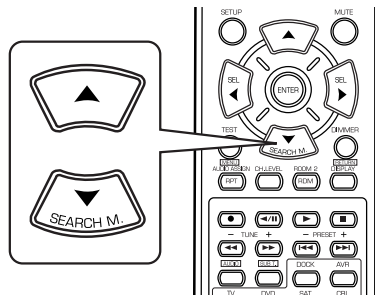

- You can enter the desired among blank, A ~ Z, a ~ z, 0 ~ 9, (,), *, +, , , - , /.

5. Repeat the above steps 3 and 4 to enter the desired characters on the rest of the digits.

6. Confirm your entry.

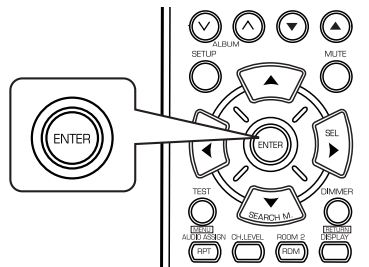

- The name is stored in the memory.

- To resume its factory input source name.
- Make a blank on each digit and press the ENTER button.

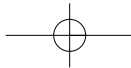

When selecting the PARENTAL LOCK

- You can select the PARENTAL LOCK on the TUNER CONFIGURATION menu only while listening to SIRIUS Satellite Radio.
- You can lock the channels that you do not want to receive or unlock the previously locked channels.

1. Press the CURSOR UP(▲)/DOWN(▼) buttons to select the PARENTAL LOCK, then press the ENTER button.

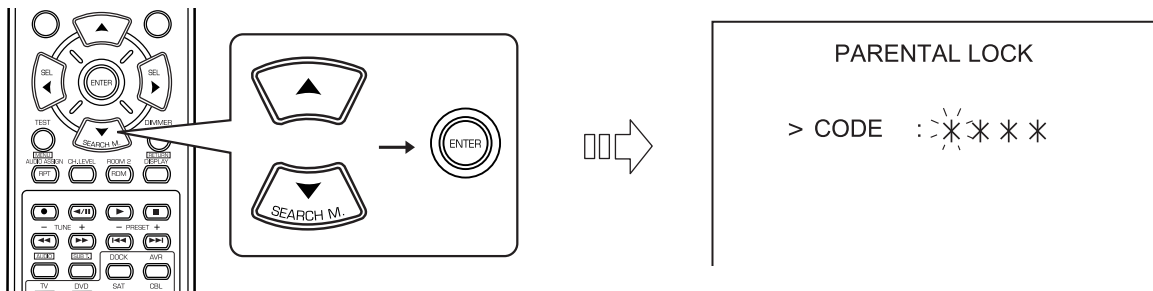

2. Input the password(4-digit number) with using the NUMERIC (0~9) buttons, then press the ENTER button.

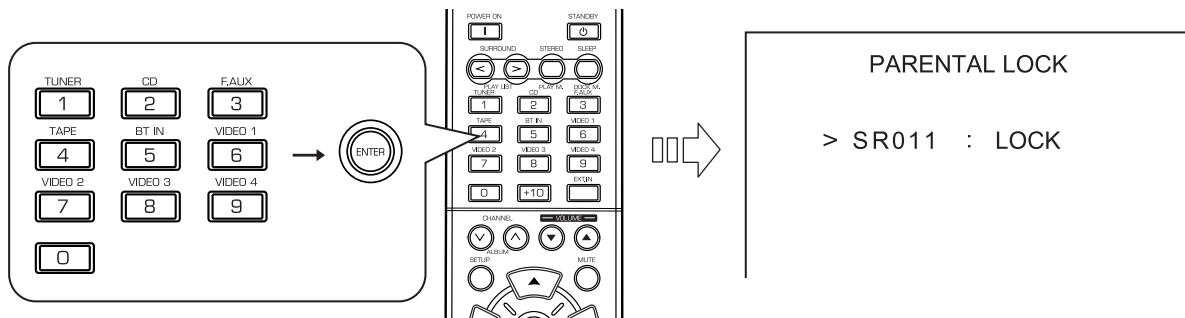

- When you input the correct code, the current channel is locked (or unlocked).
- If the wrong password is input, "INCORRECT CODE" is displayed. In this case, input the password again, performing the steps 1 and 2.

■ Note :

- The default password is "0000".
- You can change this password to new one. (For details, refer to "When selecting the EDIT LOCK CODE" on page 50.)

3. Press the TUNING UP(+)/DOWN(-) buttons to select the channel you want to lock or unlock.

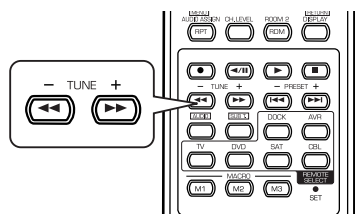

4. Press the CURSOR LEFT(◀)/ RIGHT(▶) buttons to set the selected station as desired.

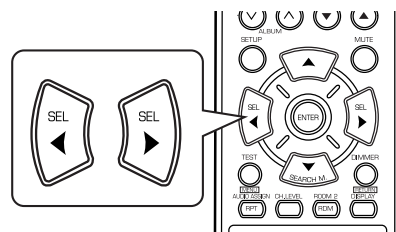

- Each time the CURSOR LEFT(◀)/ RIGHT(▶) buttons are pressed, "LOCK" or "UNLOCK" is selected.

5. Repeat the above steps 3 and 4 to set the channels as desired.

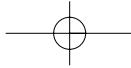

When selecting the EDIT LOCK CODE

- You can select the EDIT LOCK CODE on the TUNER CONFIGURATION menu only while listening to SIRIUS Satellite Radio.
- You can change the password to the desired.

1. Press the CURSOR UP(▲)/DOWN(▼) buttons to select the EDIT LOCK CODE, then press the ENTER button.

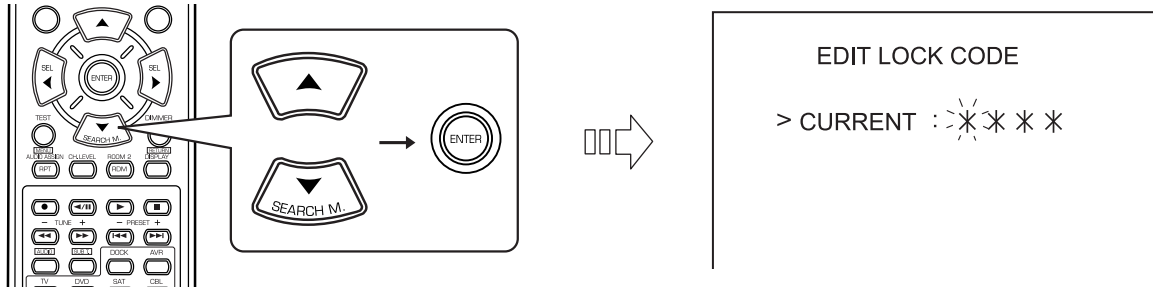

2. Input the current password(4-digit number), then press the ENTER button.

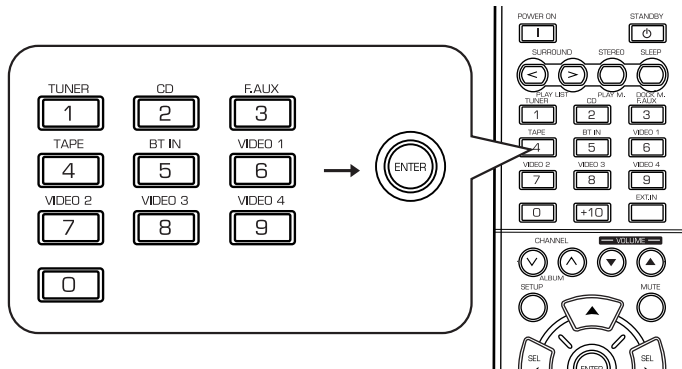

- When you input the correct code, "NEW : * * * *" is displayed.
- If the wrong password is input, "INPUT ERROR" is displayed. In this case, input the password again, performing the steps 1 and 2.

3. Input the new password(4-digit number), then press the ENTER button.

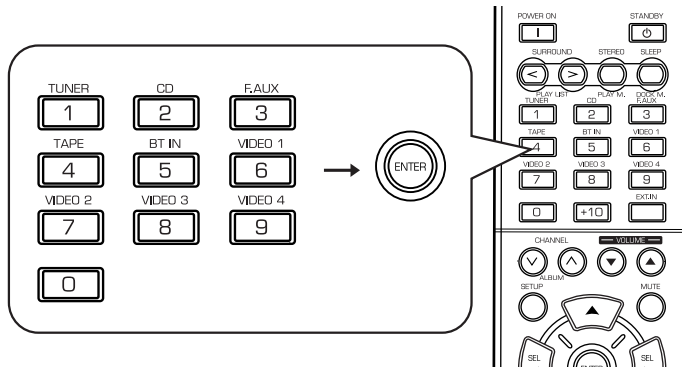

- If the correct password is input, "MODIFIED" is displayed and the new password is modified.

■ **Note :**

- Do not forget the password.
- If you forgot your password, you cannot lock or unlock the channel.

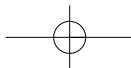

SETTING THE SPEAKER / ROOM EQ SETUP

- After you have installed this receiver and connected all the components, you should adjust the speaker settings for the optimum sound acoustics according to your environment and speaker layout.
- Even when you change speakers, speaker positions, or the layout of your listening environment, you should adjust the speaker settings, too.
- When performing the AUTO SETUP procedure, you need not perform the SPEAKER CONFIGURATION, SPEAKER DISTANCE, SPEAKER CROSSOVER and CH LEVEL SETUP procedures.

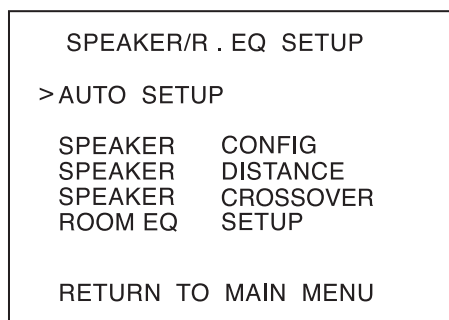

- AUTO SETUP : To set the speaker setup and channel level setup automatically.
- SPEAKER CONFIGURATION : To adjust the speakers depending on whether they are connected or not.
- SPEAKER DISTANCE: To select the distance between the listening position and each speaker to set the delay time automatically for optimum surround playback.
- SPEAKER CROSSOVER : To select the desired crossover frequency.
- ROOM EQ SETUP : To select the desired room EQ mode.

When selecting the AUTO SETUP

- Auto Setup lets you avoid troublesome listening-based speaker setup and achieve good surround sound. Auto Setup has the feature that provides the optimum listening environment at the listening position in your room, where there are often multiple listeners viewing programs together.
You should connect the supplied microphone to the SETUP MIC jack so that this receiver can analyze the information from a series of test tones emitted from speakers at main listening position and can adjust the configuration, distance, sound level, crossover frequency and frequency response of each speaker automatically.
- If you want to personalize your speaker setup and channel level setup by making the settings manually, perform the "When selecting the SPEAKER CONFIGURATION" on page 53, "When selecting the SPEAKER DISTANCE" on page 54, "When selecting the SPEAKER CROSSOVER" on page 55, "Adjusting each channel level with test tone" on page 26 and "Adjusting the current channel level" on page 27.
- After the auto setup has been completed, set the room EQ as desired. (For details, refer to "When selecting the ROOM EQ SETUP" on page 56.)

■ Preparations

- ①. Check that the speakers are securely connected to this receiver.
 - If your subwoofer has adjustable volume and crossover frequency, set the volume halfway and set the crossover frequency to the maximum or the low pass filter off.
- ②. Connect the supplied microphone to the SETUP MIC jack on the front panel. (For details, refer to "SETUP MIC JACK" on page 14.)

■ Notes :

- Because the microphone for Auto Setup is designed for use with this receiver, to use the auto setup function, do not use a microphone other than the one supplied with this receiver.
- After you have completed the auto setup procedure, disconnect the microphone.

1. Place the microphone on a flat level surface at the listening position.

- If possible, use a tripod, etc. to attach the microphone at the same height as your ears would be when you are seated in your listening position.
- Ensure there are no obstacles between the speakers and the microphone.

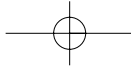

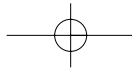

Continued

2. Press the CURSOR UP(▲)/DOWN(▼) buttons to select the AUTO SETUP, then press the ENTER button.

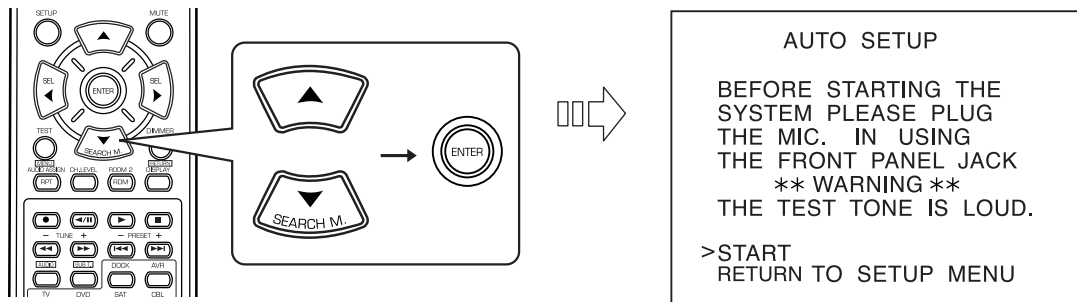

3. Press the CURSOR UP(▲)/DOWN(▼) buttons to select the START, then press the ENTER button.

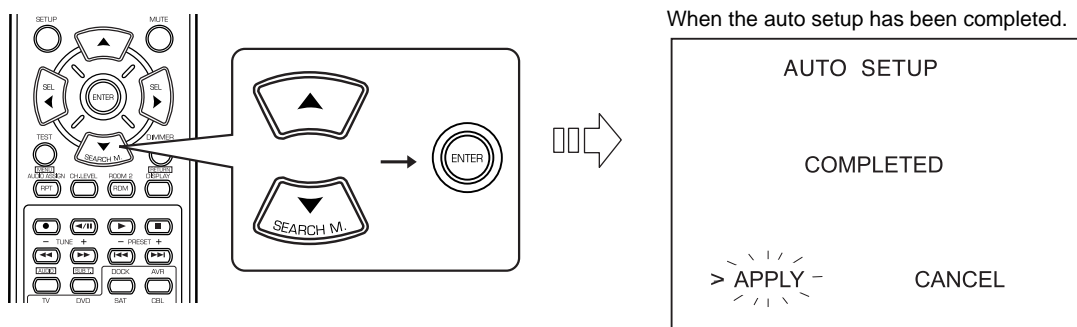

- Loud test tones are output successively and then if a series of auto setup procedure has been completed, "COMPLETED" will be displayed.
- To stop the auto setup procedure while performing it, press the ENTER button. In such a case that the auto setup procedure is stopped before "COMPLETED" is displayed, the results of each adjustment can not be memorized.
- If there may be a problem with speaker or microphone connection, error message will be displayed. In this case, turn off the power, check the connection and then retry the auto setup procedure.

■ Notes :

- Because the test tones are loud, ensure there no infants or small children in the room.
- For best results, ensure the room is as quiet as possible during the auto setup procedure. If there is too much ambient noise, the results may not be satisfactory.

4. To memorize the results, press the CURSOR LEFT(◀)/ RIGHT(▶) buttons to select the APPLY, then press the ENTER button.

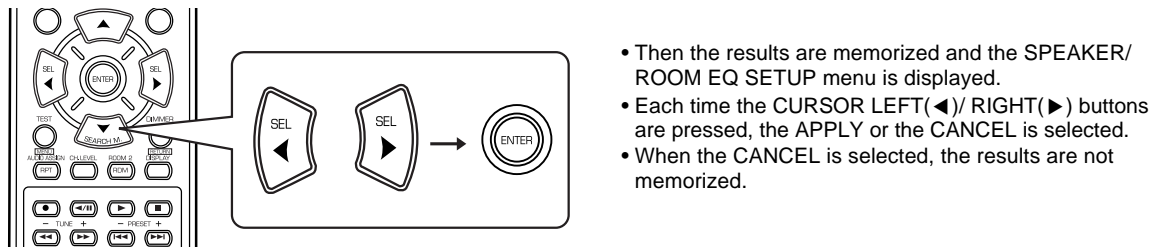

- Then the results are memorized and the SPEAKER/ ROOM EQ SETUP menu is displayed.
 - Each time the CURSOR LEFT(◀)/ RIGHT(▶) buttons are pressed, the APPLY or the CANCEL is selected.
 - When the CANCEL is selected, the results are not memorized.
- Check the results on each setup menu(SPEAKER CONFIGURATION menu on page 53, SPEAKER DISTANCE menu on page 54, SPEAKER CROSSOVER menu on page 55 and CH LEVEL SETUP menu for "CALIBRATE" mode on page 57).
 - If the results are not satisfactory, you can retry the auto setup procedure or personalize your speaker setup and channel level setup by making the settings manually. (For details, refer to "When selecting the SPEAKER CONFIGURATION" on page 53, "When selecting the SPEAKER DISTANCE" on page 54, "When selecting the SPEAKER CROSSOVER" on page 55, "Adjusting each channel level with test tone" on page 26 and "Adjusting the current channel level" on page 27.)

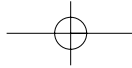

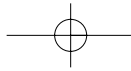

When selecting the SPEAKER DISTANCE

1. Press the CURSOR UP(▲)/DOWN(▼) buttons to select the SPEAKER DISTANCE, then press the ENTER button.

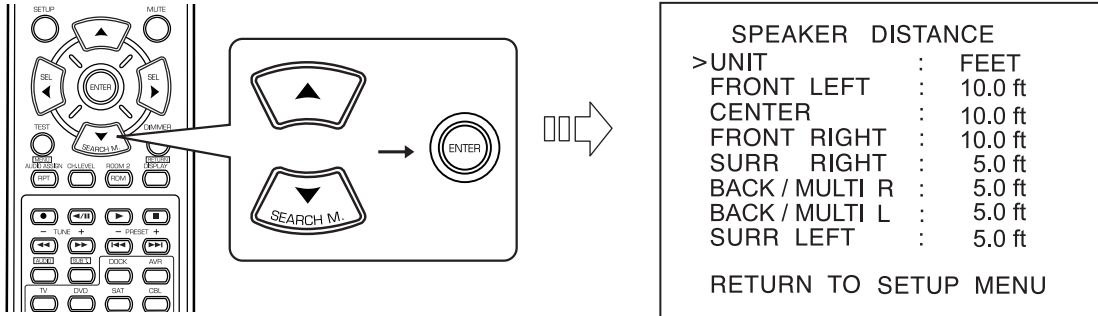

2. Press the CURSOR UP(▲)/DOWN(▼) buttons to select the desired item.

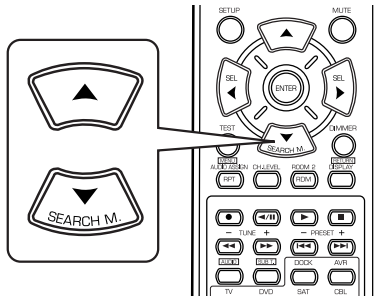

■ Note :

- You cannot select the subwoofer and the speakers set to "NO".

3. Press the CURSOR LEFT(◀)/RIGHT(▶) buttons to set the selected item as desired.

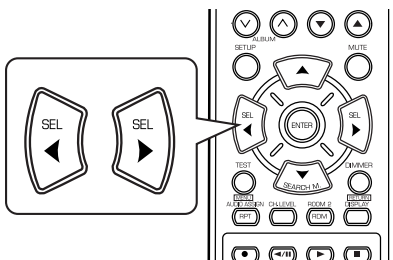

■ When selecting the desired unit

- You can select either METERS or FEET.
- Once a unit is selected, the distances are automatically changed in the selected unit.

■ When setting the distance

- You can set the distance within the range of 0.1 ~ 9.0 meters in 0.1 meter intervals (or 0.5 ~ 30 feet in 0.5 feet intervals).

4. Repeat the above steps 2 and 3 until the distances are all set as desired.

■ About the speaker distance

When enjoying multi-channel surround playback with Dolby Digital and DTS sources, etc., it is ideal that the center, surround and surround back speakers should be the same distance from the main listening position as the front speakers. By entering the distance between the listening position and each speaker, the delay times of center, surround and surround back speakers are automatically adjusted to create an ideal listening environment virtually as if the center, surround and surround back speakers were at their ideal locations respectively.

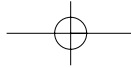

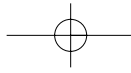

When selecting the SPEAKER CROSSOVER

- Set the crossover frequency according to the frequency characteristics of the speakers connected.
(For details on the frequency characteristics, refer to the operating instructions of the speakers.)
- If the frequency range of your speaker is 100 Hz ~ 20 kHz, the crossover frequency should be set to 100 Hz (or slightly higher).
- The low frequencies below the crossover frequency are to output from subwoofer or the speakers which are set to "FULL RANGE" (when not using a subwoofer).

1. Press the CURSOR UP(▲)/DOWN(▼) buttons to select the SPEAKER CROSSOVER, then press the ENTER button.

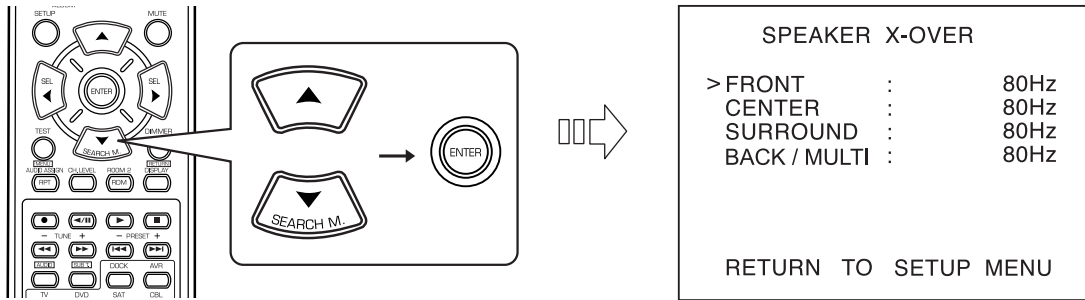

2. Press the CURSOR UP(▲)/DOWN(▼) buttons to select the desired speaker.

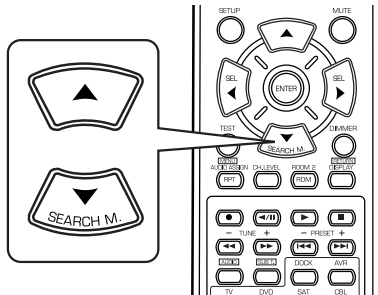

■ **Note :**

- You cannot select the subwoofer and the speakers set to "NO".

3. Press the CURSOR LEFT(◀)/RIGHT(▶) buttons to set the crossover frequency as desired.

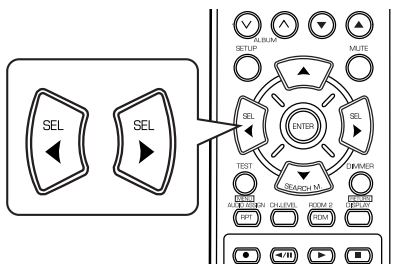

- You can adjust the crossover frequency within the range of 40 ~ 250 Hz.
- Select "FULL RANGE" when the selected speaker can fully reproduce the low frequencies below 40 Hz.

4. Repeat the above steps 2 and 3 until the crossover frequencies are all set as desired.

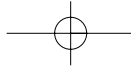

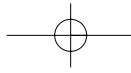

When selecting the ROOM EQ SETUP

- The room EQ is a kind of room equalizer for your speakers. According to the acoustic characteristics of your room measured by the auto setup, the room EQ automatically adjusts the frequency response of your speakers.
 - If you use different brands or sizes of speakers for some channels or have a room with unique acoustic characteristics, such as walls, furniture, and the dimensions or the shape of the room, we recommend using the room EQ.
- **Note :**
- To use the room EQ, first you should finish measuring the acoustic characteristics of your room performing the auto setup. (For details, refer to "When selecting the AUTO SETUP" on page 51.)

1. Press the CURSOR UP(▲)/DOWN(▼) buttons to select the ROOM EQ SETUP, then press the ENTER button.

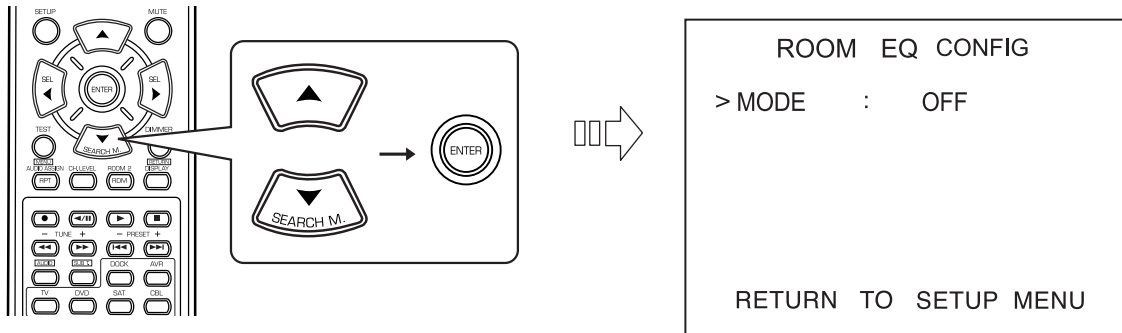

2. Press the CURSOR LEFT(◀)/RIGHT(▶) buttons to select the desired room EQ mode.

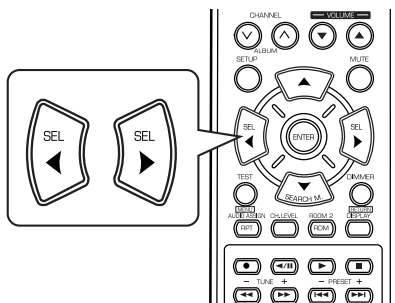

OFF : When turning off the room EQ.



ON : To adjust the frequency response of all speakers to the flattest response.

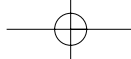

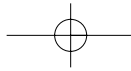

SETTING THE CH LEVEL SETUP

```

CH LEVEL SETUP
>MODE : CALIBRATE
FRONT LEFT : 0dB
CENTER : 0dB
FRONT RIGHT : 0dB
SURR RIGHT : 0dB
BACK/MULTI R : 0dB
BACK/MULTI L : 0dB
SURR LEFT : 0dB
SUBWOOFER : 0dB
LFE LEVEL SETUP
RETURN TO MAIN MENU
  
```

Memory mode

■ Note :

- Depending on the speaker settings("NO", etc.), some channels cannot be selected.

ENGLISH

Adjusting the current channel level

- You can adjust the current channel levels as desired. These adjusted levels are just memorized into user's memory ("CALIBRATE"), not into preset memory("REFERENCE 1", "REFERENCE 2").
- After adjusting each channel level with test tone, adjust the channel levels either according to the program sources or to suit your tastes.(For details, refer to "Adjusting each channel level with test tone" on page 26.)

1. Press the CURSOR UP(▲)/DOWN(▼) buttons to select the desired channel.

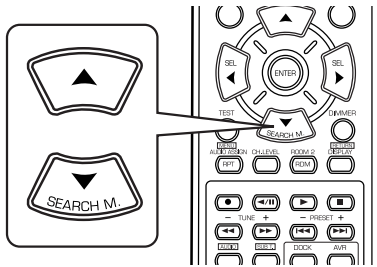

■ When adjusting the LFE LEVEL

- ①. Press the CURSOR UP(▲)/DOWN(▼) buttons to select the LFE LEVEL SETUP, then press the ENTER button.

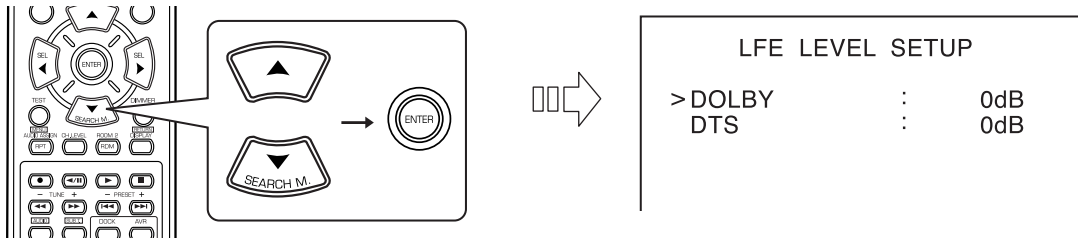

- ②. Press the CURSOR UP(▲)/DOWN(▼) buttons to select the desired program source.

2. Press the CURSOR LEFT(◀)/RIGHT(▶) buttons to adjust the level of the selected channel or program source's LFE as desired.

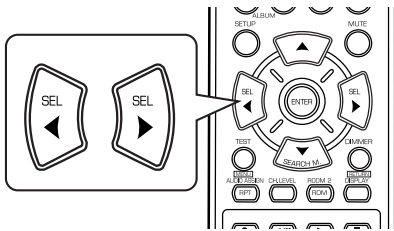

- The LFE level can be adjusted within the range of -10 ~ 0 dB and other channel levels within the range of -15 ~ +15 dB
- In general, we recommend the LFE level to be adjusted to 0 dB.(However, the recommended LFE level for some early DTS software is -10 dB.) If the recommended levels seem too high, lower setting as necessary.

3. Repeat the above steps 1 and 2 to adjust each channel level.

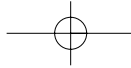

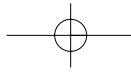

Memorizing the adjusted channel levels

- You can memorize the adjusted channel levels into preset memory("REFERENCE 1", "REFERENCE 2") and recall the memorized whenever you want.

- After performing the steps 1~3 in "Adjusting the current channel level" procedure on page 57, press the CURSOR UP(▲)/DOWN(▼) buttons to select a channel (, not the MODE (memory mode) and the LFE LEVEL SETUP), then press the ENTER button.

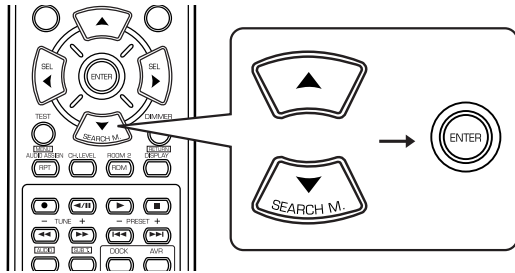

- The "REFERENCE 1" indication flickers.

- Press the CURSOR LEFT(◀)/RIGHT(▶) buttons to select the desired preset memory, then press the ENTER button.

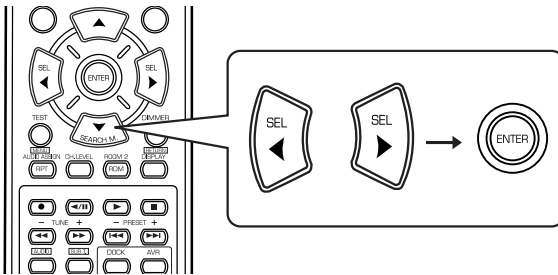

- Each time the CURSOR LEFT(◀) or RIGHT(▶) button is pressed, "REFERENCE 1" or "REFERENCE 2" is selected.
- The adjusted channel levels have now been memorized into the selected memory.

Recalling the memorized channel levels

- Press the CURSOR UP(▲)/DOWN(▼) buttons to select the MODE(memory mode).

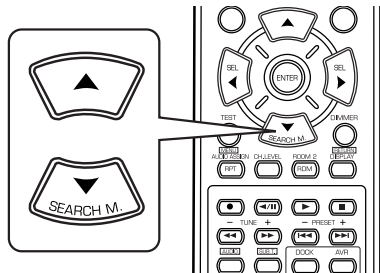

- "CALIBRATE" may be displayed instead of "REFERENCE 1" or "REFERENCE 2".

- Press the CURSOR LEFT(◀)/RIGHT(▶) buttons to select the desired one of REFERENCE 1 and REFERENCE 2.

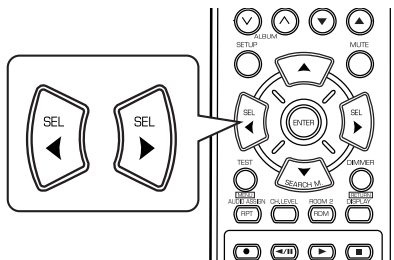

- Then the channel levels memorized into the selected preset memory are recalled.

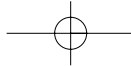

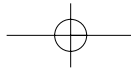

SETTING THE SOUND PARAMETER

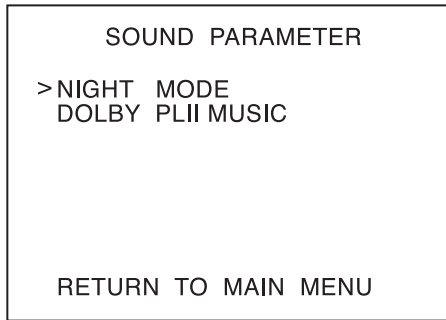

- NIGHT MODE : To adjust the dynamic range compression that makes faint sound easier to hear at low volume levels.
- DOLBY PLII MUSIC : To adjust the various surround parameters for optimum surround effect.

ENGLISH

When selecting the NIGHT MODE

- This function compresses the dynamic range of previously specified parts of the Dolby Digital sound track (with extremely high volume) to minimize the difference in volume between the specified and non-specified parts. This makes it easy to hear all of the sound track when watching movies at night at low levels.

■ Notes:

- The night mode setting is valid only when the digital signals from the Dolby Digital program source are being input.
- In some Dolby Digital softwares, the night mode setting may not be valid.

1. Press the CURSOR UP(▲)/DOWN(▼) buttons to select the NIGHT MODE, then press the ENTER button.

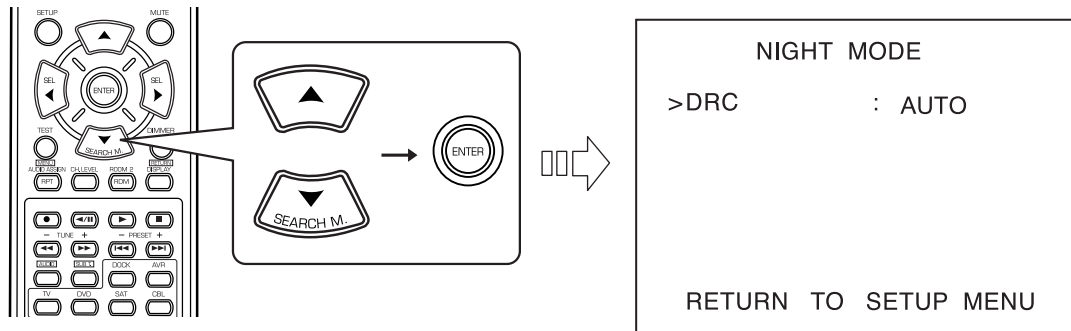

2. Press the CURSOR LEFT(◀)/RIGHT(▶) buttons to adjust the dynamic range compression as desired.

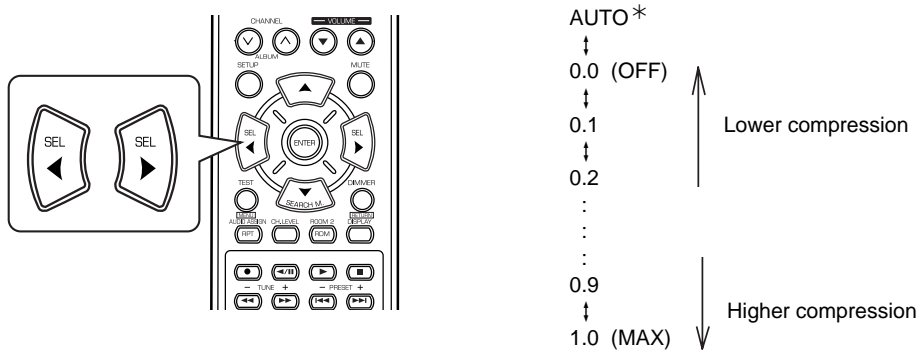

*: Valid only when the digital signals from the Dolby TrueHD program source are being input.

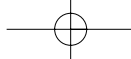

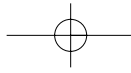

When selecting the DOLBY PLII MUSIC

- You can adjust the various surround parameters for optimum surround effect.
- **Note:**
- The parameter settings are valid only when listening in either Dolby Pro Logic II Music mode or the Dolby Pro Logic IIx Music mode.

- Press the CURSOR UP(▲)/DOWN(▼) buttons to select the DOLBY PLII MUSIC, then press the ENTER button.

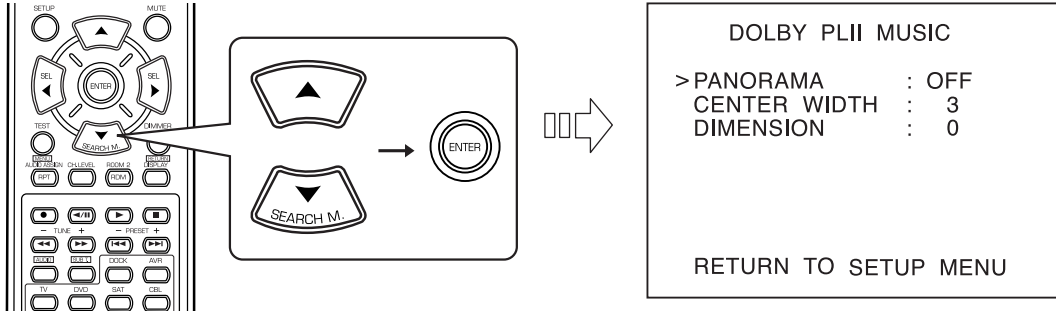

- Press the CURSOR UP(▲)/DOWN(▼) buttons to select the desired parameter.

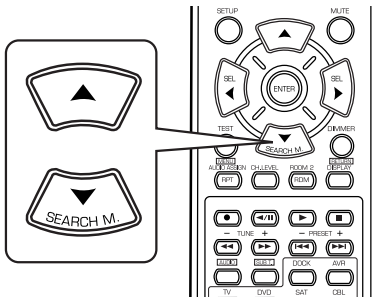

- Press the CURSOR LEFT(◀)/RIGHT(▶) buttons to adjust the selected parameter as desired.

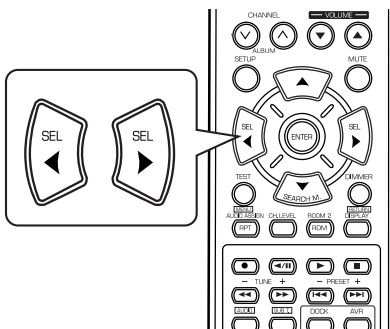

■ When selecting the PANORAMA mode

This mode extends the front stereo image to include the surround speakers for an exciting "wraparound" effect with side wall imaging. Select "OFF" or "ON"(default value:OFF).

■ When selecting the CENTER WIDTH control

This adjusts the center image so it may be heard only from the center speaker, only from the left/right speakers as a phantom image, or from all three front speakers to varying degrees. The control can be set in 8 steps from 0 to 7 (default value : 3).

■ When selecting the DIMENSION control

This gradually adjusts the soundfield either towards the front or towards the rear. The control can be set in 7 steps from -3 to +3(default value : 0).

- Repeat the above steps 2 and 3 to adjust other parameters.

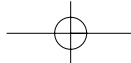

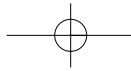

SETTING THE MULTI ROOM SETUP

- The ROOM 2 function allows enjoying one source in the main room while playing another in a different room at the same time.

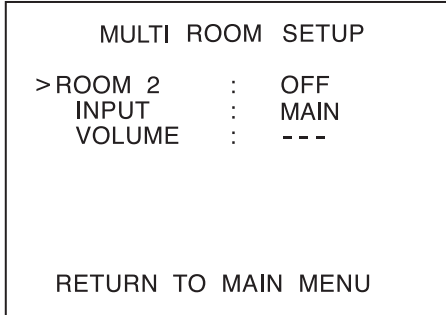

- ROOM 2 : To turn on or off the ROOM 2 function.
- INPUT : To select the desired ROOM 2 source.
- VOLUME : To adjust the volume on the power amplifier assigned to "BACK ← → ROOM 2" or "ROOM 2".

■ Notes:

- The analog signals from the EXTERNAL INs and the digital signals cannot be output to the different room, meaning no playback in a different room.
- Only the (composite) video signals can be output to the different room.

ENGLISH

- Press the CURSOR UP(▲)/DOWN(▼) buttons to select the desired item.

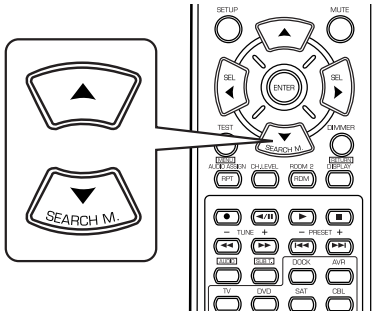

■ Note:

- The VOLUME setting is invalid when the AMP ASSIGN is assigned to "BI-AMP" or "SURR BACK". (For details, refer to "When selecting the AMP ASSIGN" on page 41.)

- Press the CURSOR LEFT(◀)/RIGHT(▶) buttons to set the selected item as desired.

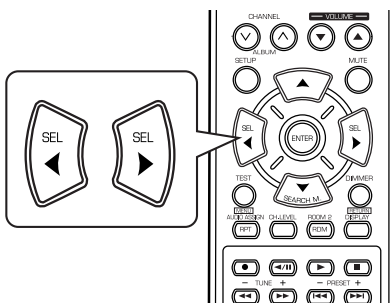

When selecting the ROOM 2

OFF : To turn off the ROOM 2 function.



ON : To turn it on.

■ Notes:

- When the ROOM 2 is set to OFF, the INPUT and the VOLUME cannot be selected.
- When you do not use the ROOM 2 function, set the ROOM 2 to OFF to save electricity.

When selecting the INPUT

- You can select the desired among MAIN source, TUNER, CD, F.AUX, TAPE, BT, VIDEO 1 ~ VIDEO 3 as a ROOM 2 source.

■ Note:

- When the EXTERNAL IN is selected as a main input, if the MAIN source is selected as a ROOM 2 input, no audio signal can be heard in the different room (ROOM 2).

When selecting the VOLUME

- You can adjust the volume on the power amplifier assigned to "BACK ← → ROOM 2" or "ROOM 2" when the ROOM 2 speaker terminals are connected to the speakers in a different room. (For details, refer to "When selecting the AMP ASSIGN" on page 41.)

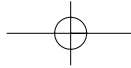

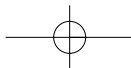

Troubleshooting Guide

If a fault occurs, run through the table below before taking your receiver for repair.

If the fault persists, attempt to solve it by switching the receiver off and on again. If this fails to resolve the situation, consult your dealer. Under no circumstances should you attempt to repair the receiver yourself. This could void the warranty.

ENGLISH

PROBLEM	POSSIBLE CAUSE	REMEDY
No power	<ul style="list-style-type: none"> The AC input cord is disconnected. Poor connection at AC wall outlet or the outlet is dead or off. 	<ul style="list-style-type: none"> Connect cord securely. Check the outlet using a lamp or another appliance.
No sound	<ul style="list-style-type: none"> The speaker wires are disconnected. The master volume is adjusted too low. The MUTE button is pressed to ON. Incorrect selection of input source. Incorrect connections between the components. The HDMI AUDIO OUT is set to ON. The settings related to audio are set incorrectly. 	<ul style="list-style-type: none"> Check the speaker connections. Adjust the master volume. Press the MUTE button to cancel the muting effect. Select the desired input source correctly. Make connections correctly. Set it to OFF. (For details, refer to "When selecting the HDMI AUDIO OUT" on page 42.) Set the settings correctly. (For details, refer to "SETTING THE INPUT SETUP" on page 45.)
No sound from the surround speakers	<ul style="list-style-type: none"> Surround mode is switched off (stereo mode). Master volume and surround level are too low. Monaural source is used. Surround speaker setting is "NO". 	<ul style="list-style-type: none"> Select a surround mode. Adjust master volume and surround level. Select a stereo or surround source. Select the desired surround speaker setting.
No sound from the center speaker	<ul style="list-style-type: none"> Dolby Virtual Speaker, stereo mode, etc is selected. Center speaker setting is "NO". Master volume and center level are too low. 	<ul style="list-style-type: none"> Select the desired surround mode. Select the desired center speaker setting. Adjust master volume and center level.
No sound from the surround back speakers	<ul style="list-style-type: none"> The input signal format or the current surround mode cannot support the 7.1 (or 6.1) surround. The surround back channels' power amplifier is assigned to "BI-AMP" or "ROOM 2". Master volume and surround back level are too low. Surround back speaker setting is "NO". 	<ul style="list-style-type: none"> Under the proper situations, perform the 7.1 (or 6.1) surround playback. (For details, refer to "ENJOYING SURROUND SOUND" on page 25.) Assign the power amplifier to the surround back channels. (For details, refer to "When selecting the AMP ASSIGN" on page 41.) Adjust master volume and surround back level. Select the desired surround back speaker setting.
No picture	<ul style="list-style-type: none"> Video connections between this unit and the monitor TV are not made correctly. Incorrect selection of input source on the monitor TV. The settings related to video are set incorrectly. 	<ul style="list-style-type: none"> Make proper video connections. Select the input source correctly. Set the settings correctly. (For details, refer to "SETTING THE INPUT SETUP" on page 45.)
No picture with an HDMI connection	<ul style="list-style-type: none"> HDMI connection between this unit and the monitor TV are not made correctly. The monitor TV or other equipments do not support HDCP. 	<ul style="list-style-type: none"> Make proper HDMI connection. This unit will not output video signal unless the connected equipments supports HDCP.
Noise or distorted picture	<ul style="list-style-type: none"> Video format of your monitor TV, DVD player, etc. is different from NTSC. 	<ul style="list-style-type: none"> Change the video format to NTSC.
Stations cannot be received	<ul style="list-style-type: none"> No antenna is connected. The desired station frequency is not tuned in. Antenna is in wrong position. 	<ul style="list-style-type: none"> Connect an antenna. Tune in the desired station frequency. Move antenna and retry tuning.
Preset stations cannot be received	<ul style="list-style-type: none"> An incorrect station frequency has been memorized. The memorized stations are cleared. 	<ul style="list-style-type: none"> Memorize the correct station frequency. Memorize the stations again.
Poor FM reception	<ul style="list-style-type: none"> No antenna is connected. The antenna is not positioned for the best reception. Weak signals. 	<ul style="list-style-type: none"> Connect an antenna. Change the position of the antenna. Install an outdoor FM antenna.
Continuous or intermittent hissing noise during AM reception, especially at night.	<ul style="list-style-type: none"> Noise is caused by motors, fluorescent lamps or lightning, etc. 	<ul style="list-style-type: none"> Keep the receiver away from noise sources. Install an outdoor AM antenna.
Remote control unit does not operate.	<ul style="list-style-type: none"> Batteries are not loaded or exhausted. The remote sensor is obstructed. 	<ul style="list-style-type: none"> Replace the batteries. Remove the obstacle.
OSD function is not available.	<ul style="list-style-type: none"> Video connections between this unit and the monitor TV are not made correctly. 	<ul style="list-style-type: none"> Make proper (composite) video connections.

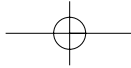

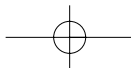

Specifications

■ AMPLIFIER SECTION

- Power output, stereo mode, 6 Ω , THD 1.0 %, 40 Hz~20 kHz | **2 × 100 W**
- Total harmonic distortion at -3 dB, 6 Ω , 1 kHz | **0.05%**
- Intermodulation distortion
60 Hz : 7 kHz = 4 : 1 SMPTE, 6 Ω , 95 W | **0.05%**
- Input sensitivity/impedance
Line (CD, TAPE, VIDEO) | **300 mV/47k Ω**
- Signal to noise ratio, IHF "A" weighted
Line (CD, TAPE, VIDEO) | **100 dB**
- Frequency response
Line (CD, TAPE, VIDEO), 10 Hz ~ 100 kHz | **+0, -3 dB**
- Output level
ROOM 2 OUT, 2.2 k Ω | **300 mV**
- Bass/Treble control, 100 Hz/10 kHz | **± 10 dB**
- Surround mode, only channel driven
Front power output, 6 Ω , 1 kHz, THD 1.0 % | **110 W / 110W**
Center power output, 6 Ω , 1 kHz, THD 1.0 % | **110 W**
Surround power output, 6 Ω , 1 kHz, THD 1.0 % | **110 W / 110W**
Surround back (/MULTI) / ROOM 2 power output, 6 Ω , 1 kHz, THD 1.0 % | **110 W / 110W**

■ DIGITAL AUDIO SECTION

- Sampling frequency | **32, 44.1, 48, 96 kHz**
- Digital input level
Coaxial, 75 Ω | **0.5 Vp-p**
Optical, 660 nm | **-15 ~ -21 dBm**

■ VIDEO SECTION

- Video format | **NTSC**
- Input sensitivity(=Output level), 75 Ω
Video (Composite(normal)) | **1 Vp-p**
S-Video (luminance signal) | **1 Vp-p**
(chrominance signal) | **0.286 Vp-p**
Component video (R-Y signal) | **0.5 Vp-p**
(B-Y signal) | **0.5 Vp-p**
(Y signal) | **1.0 Vp-p**
- HDMI connector | **19 pin**

■ FM TUNER SECTION

- Tuning frequency range | **87.5~108 MHz**
- Usable sensitivity, THD 3%, S/N 30 dB | **12.8 dBf**
- 50 dB quieting sensitivity, mono/stereo | **20.2 / 45.3 dBf**
- Signal to noise ratio, 65 dBf, mono/stereo | **70 / 65 dB**
- Total harmonic distortion, 65 dBf, 1 kHz, mono/stereo | **0.5 / 0.8 %**
- Frequency response, 30 Hz~15 kHz | **± 3 dB**
- Stereo separation, 1 kHz | **32 dB**
- Capture ratio | **4.0 dB**
- IF rejection ratio | **60 dB**

■ AM TUNER SECTION

- Tuning frequency range | **520~1710 kHz**
- Usable sensitivity | **500 μ V/m**
- Signal to noise ratio | **40 dB**
- Selectivity | **25 dB**

■ GENERAL

- Power supply | **120 V ~ 60 Hz**
- Power consumption | **3.7 A**
- Dimensions (W × H × D, including protruding parts) | **435 × 166 × 374 mm (17-3/8 × 6-1/2 × 14-3/4 inches)**
- Weight (Net) | **11.5 kg (25.4 lbs)**

Note: Design and specifications are subject to change without notice for improvements.

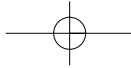

Setup Code Table

TV

ENGLISH

AOC	005	003				
Admiral	041	031				
Aiko	014					
Akai	005					
Alaron	026					
Ambassador	024					
America Action	027					
Ampro	043					
Anam	027	047	048	049		
Audiovox	030	027	014	034		
Baysonic	027					
Belcor	003					
BenQ	051					
Bell & Howell	019	001				
Bradford	027					
Brockwood	003					
Broksonic	028	031				
CXC	027					
Candle	005	011				
Carnivale	005					
Carver	010					
Celebrity	050					
Cineral	030	014				
Citizen	012	005	011	006	014	
Concerto	011					
Contec	027					
Craig	027					
Crosley	010					
Crown	027	006				
Curtis Mathes	007	010	019	008	030	041
	012	005	016	011	001	006
	022	032	038	040		
Daewoo	030	003	006	014	034	035
Daytron	003					
Denon	016					
Dumont	002	003				
Dwin	044	036				
Electroband	050					
Emerson	019	028	031	027	029	025
	003	026	006	024	034	035
Envision	005					
Fisher	019					
Fujitsu	026					
Funai	027	026	023			
Futuretech	027					
GE	007	008	030	041	029	025
	004	015	038	040		
Gibraltar	002	005	003			
Goldstar	005	025	003	011		
Gradiente	009	011				
Grunpy	027	026				
Hallmark	025					
Harley Davidson	026					
Harman/Kardon	010					
Havard	027					
Hitachi	016	011	018			
Infinity	010					
Inteq	002					
JBL	010					
JCB	050					
JVC	009	046				
KEC	027					
KTV	027	005	006			
Kenwood	005	003				
LG	011					
LXI	007	010	019	020	025	
Logik	001					
Luxman	011					
MGA	017	005	025	003		
MTC	012	005	003	011		
Magnavox	010	005	026			
Majestic	001					
Marantz	010	005				
Matsushita	042					
Magatron	025	016				
Memorex	019	042	031	017	025	011
	001					
Midland	007	002	008	006	015	
Minutz	004					
Mitsubishi	041	017	025	003		
Motorola	041					
Multitech	027					
NAD	020	025	022			
NEC	005	003	011			
NTC	014					
Nikko	005	025	014			
Onwa	027					
Optimus	019	042	022			
Optonica	041	021				
Orion	028	031	026			
Panasonic	008	042				
Penney	007	020	008	012	005	025
	004	003	011	006	015	040
Pilco	010	031	005	016	003	
Philips	010					

Pilot	005	003	006			
Pioneer	022					
Portland	003	006	014			
Prism	008					
Proscan	007					
Proton	025	032				
Pulsar	002	003				
Quasar	008	042	021			
RCA	007	008	041	003	013	015
	037	038	039	040		
Radio Shack	007	019	021	027	005	025
	003	011	006			
Realistic	019	021	027	005	025	003
	011	006				
Runco	002	005	033			
SSS	027	003				
Sampo	005	006				
Samsung	012	005	025	003	011	045
Samsux	006					
Sansei	030					
Sansui	031					
Sanyo	019					
Scimitsu	003					
Scotch	025					
Scott	028	027	025	003	026	
Sears	007	010	019	020	025	026
	011	023				
Semivox	027					
Semp	020					
Sharp	041	021	006			
Sherwood	000	001	002	052		
Shogun	003					
Signature	001					
Sony	050					
Soundesign	027	025	026			
Squareview	023					
Starlite	027					
Supreme	050					
Sylvania	010	005				
Symphonic	023					
TMK	025	011	024			
Tandy	041					
Technics	008	042				
Technoi Ace	026					
Techwood	008	011				
Teknika	010	027	017	012	003	026
	011	001	006	014		
Telefunken	011					
Toshiba	019	020	012			
Totevision	006					
Vector Research	005					
Victor	009					
Vidikron	010					

Vidtech	025	003				
Wards	010	021	005	025	004	003
	026	011	001			
White Westinghouse	031	034	035			
Yamaha	005	003				
Zenith	002	031	001	014		

DOCK-VCR

Admiral	027	021				
Adventura	050					
Aiko	025					
Aiwa	005	034				
Akai	026					
America Action	025					
America High	004					
Asha	023					
Audiovox	005					
Beaumarck	023					
Bell & Howell	017					
Brocksonic	021					
Broksonic	020	018	021	001		
CCE	015	025				
Calix	005					
Canon	004					
Carver	016					
Cineral	025					
Citizen	005	025				
Colt	015					
Craig	005	012	023	015	024	
Curtis Mathes	013	004	026	028		
Cybernex	023					
Daewoo	010	025				
Denon	008					
Dynatech	034					
Electrohome	005					
Electroponic	005					
Emerex	002					
Emerson	005	020	000	018	009	021
	001	025				
Fisher	012	017				
Fuji	004	003				
Funai	034					
GE	013	004	027	023		
Garrard	034					
GoldStar	005	006				
Gradiente	034					
HI-Q	012					
Harley Davidson	034					
Harman/Kardon	016	006				
Harwood	015					

Headquarter	011
Hitachi	034 008 026
JVC	014 026
Jensen	026
KEC	005 025
KLH	015
Kenwood	014 026 006
Kodak	004 005
LXI	005
Lloyd's	034
Logik	015
MEI	004
MGA	023 009
MGN Technology	023
MTC	023 034
Magnasonic	025
Magnavox	004 007 016 034 019
Magnin	023
Marantz	004 016
Marta	005
Matsushita	004 028 029
Memorex	004 005 027 007 012 023 017 021 011 031 032
Minolta	008
Mitsubishi	027 014 009
Motorola	004 016
Multitech	034 015
NEC	017 014 026 006
Nikko	005
Noblex	023
Olympus	004
Opimus	005 027 017 028 029 030 031 032
Orion	020 021 001
Panasonic	004 028 022 029 031
Penny	004 005 023 008 006
Pentax	008
Philco	004 021
Philips	004 016
Pilot	005
Pioneer	014
Profitronic	023
Proscan	013
Protec	015
Pulsar	007
Quarter	011
Quartz	011
Quasar	004 028 029 031
RCA	013 004 027 023 008 019
Radio Shack	034
Radix	005
Randex	005

Realistic	004 005 027 012 034 017 011
Runco	007
STS	008
Samsung	023 010 033
Sanky	027 007
Sansui	034 014 021 026 024
Sanyo	012 023 017 011
Scott	020 010 018 009
Sears	004 005 012 034 008 017 011
Semp	010
Sharp	027
Sherwood	000
Shintom	015
Shogun	023
Singer	015
Sony	004 002 034 003
Sylvania	004 016 034 009
Symphonic	034
TMK	023
Tatung	026
Teac	034 026
Technics	004 028
Teknika	004 005 034
Thomas	034
Toshiba	010 009
Totevision	005 023
Unitech	023
Vector	010
Vector Research	006
Video Concepts	010
Videosonic	023
Wards	013 004 027 012 016 023 034 008 015 019
White WestingHouse	021 025
XR-100	004 034 015
Yamaha	006
Zenith	007 034 021 003

DOCK - TV/VCR

Ameira High	004 (TV use 008)
Brocksonic	001
Colt	015
Cutis Mathes	004 (TV use 008)
Daewoo	025
Emerson	001
Funai	034
GE	004 (TV use 008) 013 (TV use 007) 027 (TV use 041) 023

Hitachi	004 (TV use 008)	034
HQ	034	
Lloyds	034	
MGA	023	
Megavox	016 (TV use 010)	004 (TV use 008)
	034	
Magnin	023	
Memorex	005	028 (TV use 042)
Mitsubishi	027 (TV use 041)	
Orion	001	
Panasonic	004 (TV use 008)	028 (TV use 042)
Penney	004 (TV use 008)	023
	028 (TV use 042)	
Quasar	004 (TV use 008)	028 (TV use 042)
RCA	013 (TV use 007)	004 (TV use 008)
	027 (TV use 041)	
Sansui	034	
Sanyo	023	
Sear	034	005
Sharp	027 (TV use 041)	
Sony	002 (TV use 050)	
Symphonic	034	
Zenith	034	

DVD

Apex	015					
Chinese Manufacturer	025					
Harman/Kardon	009					
JVC	008					
Kenwood	005					
Megavox	024					
Mitsubishi	027					
Onkyo	024					
Panasonic	013					
Philips	024	006				
Pioneer	003	014	026			
Proscan	002					
RCA	002					
Samsung	017					
Sherwood	001	023	012	011	000	016
	018	019	020	021	022	
Sony	004					
Technics	013					
Theta Digital	014					
Toshiba	024					
Yamaha	013	007				
Zenith	024	010				

CBL

ABC	002	003	009	030	006	008
Allegro	018	021				
Archer	018	026				
Bell&Howell	009					
Century	018					
Citizen	018	021				
Comtronics	014					
Contec	011					
Eastern	001					
Emerson	026					
Everquest	010	014				
Focus	022					
Garrard	018					
Gemini	010					
General Electric	084					
General Instrument	033	032	006	034		
GoldStar	017	014				
Goodmind	026					
Hamlin	012	020	004	013		
Hitachi	006					
Jasco	010	018	021			
Jerrold	002	007	033	032	009	010
	006	034				
Movie Time	015					
NSC	015					
Oak	011					
Optimus	031					
Panasonic	016	031				
Philips	018					
Pioneer	017	025				
Popular Mechanics	022					
RCA	031					
Radio Shack	010	021	026	028		
Recoton	022					
Regal	012	020				
Regency	001					
Rembrandt	006					
Samsung	017	014				
Scientific Atlanta	003	023	030	027		
Sherwood	000					
Signal	010	014				
Signature	006					
SL Marx	014					
Sprucer	031					
Starcom	002	010				
Stargate	010	014	026			
Starquest	010					
Televue	014					
Tocom	007	008				

Tusa	010
TV86	015
Unika	018
Universal	018 019
Viewstar	015
Zenith	024
Zentek	022

SAT

AlphaStar	008
Chaparral	001
Echostar	009
Expreevu	009
General Instrument	016 015 018
Hitachi	011
HTS	009
Hughes Net.Sys	007
JVC	009
Jerrold	016 015
Megavox	006 005
Memorex	006
Next Level	018
Panasonic	017
Philips	006 005
Primestar	016 015
Radio Shack	018
RCA	003 002 012
Realistic	014
Sherwood	000
Sony	004
Star Choice	018
Toshiba	010
Uniden	006 005 014
Zenith	013

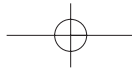

RD-7503

Audio/Video Receiver



5707-00000-172-0S

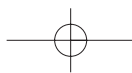

Free Manuals Download Website

<http://myh66.com>

<http://usermanuals.us>

<http://www.somanuals.com>

<http://www.4manuals.cc>

<http://www.manual-lib.com>

<http://www.404manual.com>

<http://www.luxmanual.com>

<http://aubethermostatmanual.com>

Golf course search by state

<http://golfingnear.com>

Email search by domain

<http://emailbydomain.com>

Auto manuals search

<http://auto.somanuals.com>

TV manuals search

<http://tv.somanuals.com>