

# OPERATING INSTRUCTIONS

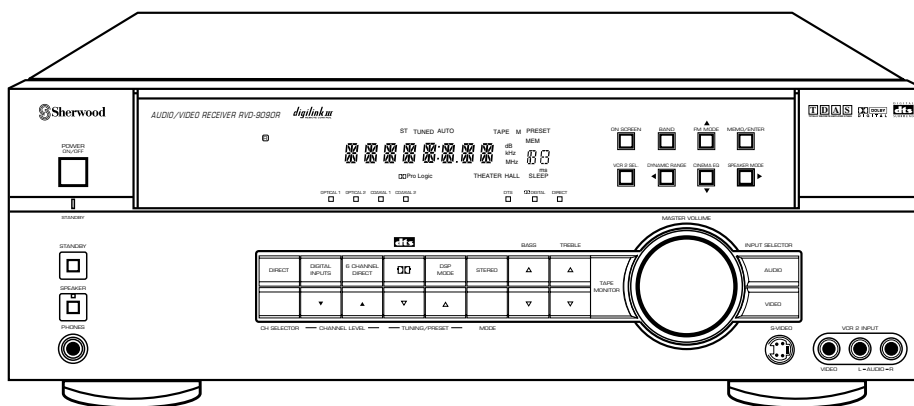

## RVD-9090R

### AUDIO/VIDEO RECEIVER



# Introduction

## UNPACKING AND INSTALLATION

### ***Congratulations on Your Purchase!***

Your new high fidelity receiver is designed to deliver maximum enjoyment and years of trouble free service. Please take a few moments to read this manual thoroughly. It will explain the features and operation of your unit and help ensure a trouble free installation. Please unpack your unit carefully. We recommend that you save the carton and packing material. They will be helpful if you ever need to move your unit and may be required if you ever need to return it for service. Your unit is designed to be placed in a horizontal position and it is important to allow at least two inches of space behind your unit for adequate ventilation and cabling convenience.

To avoid damage, never place the unit near radiators, in front of heating vents, in direct sunlight, or in excessively humid or dusty locations. Connect your complementary components as illustrated in the following section.

	<b>CAUTION</b> RISK OF ELECTRIC SHOCK DO NOT OPEN	
<b>CAUTION : TO REDUCE THE RISK OF ELECTRIC SHOCK, DO NOT REMOVE COVER (OR BACK). NO USER-SERVICEABLE PARTS INSIDE. REFER SERVICING TO QUALIFIED SERVICE PERSONNEL.</b>		



This symbol is intended to alert the user to the presence of uninsulated "dangerous voltage" within the product's enclosure that may be of sufficient magnitude to constitute a risk of electric shock to persons.



This symbol is intended to alert the user to the presence of important operating and maintenance (servicing) instructions in the literature accompanying the appliance.

### **WARNING**

To reduce the risk of fire or electric shock, do not expose this appliance to rain or moisture.

**Caution : Do not block ventilation openings or stack other equipment on the top.**

### **FOR U.S.A.**

■ **Note to CATV System Installer:** This reminder is provided to call the CATV system installer's attention to Article 820-40 of the NEC that provides guidelines for proper grounding and, in particular, specifies that the cable ground shall be connected to the grounding system of the building, as close to the point of cable entry as practical.

### ■ **FCC INFORMATION**

This equipment has been tested and found to comply with the limits for a Class B digital device, pursuant to Part 15 of the FCC Rules. These limits are designed to provide reasonable protection against harmful interference in a residential installation. This equipment generates, uses and can radiate radio frequency energy and, if not installed and used in accordance with the instructions, may cause harmful interference to radio communications. However, there is no guarantee that interference will not occur in a particular installation. If this equipment does cause harmful interference to radio or television reception, which can be determined by turning the equipment off and on, the user is encouraged to try to correct the interference by one or more of the following measures:

- Reorient or relocate the receiving antenna.
- Increase the separation between the equipment and receiver.
- Connect the equipment into an outlet on a circuit different from that to which the receiver is connected.
- Consult the dealer or an experienced radio/TV technician for help.

**CAUTION:** Any changes or modifications in construction of this device which are not expressly approved by the party responsible for compliance could void the user's authority to operate the equipment.

## READ THIS BEFORE OPERATING YOUR UNIT

FOR U.S.A. AND CANADA ..... 120 V

### FOR YOUR SAFETY

Units shipped to the U.S.A. and Canada are designed for operation on 120 V AC only.

Observe all safety precautions with use of a polarized AC plug.

However, some products may be supplied with a nonpolarized plug.

**CAUTION :** To prevent electric shock, match wide blade of plug to wide slot, fully insert.

FOR EUROPE AND AUSTRALIA .....230 V/240 V

### FOR YOUR SAFETY

Units shipped to Australia are designed for operation on 240 V AC only.

To ensure safe operation, the three-pin plug supplied must be inserted only into a standard three-pin power point which is effectively earthed through the normal household wiring. Extension cords used with the equipment must be three-core and be correctly wired to provide connection to earth.

Improper extension cords are a major cause of fatalities. The fact that the equipment operates satisfactorily does not imply that the power point is earthed and that the installation is completely safe. For your safety, if in any doubt about the effective earthing of the power point, consult a qualified electrician.

#### PAN-EUROPEAN UNIFIED VOLTAGE

All units are suitable for use on supplies 230-240 V AC.

FOR OTHER COUNTRIES..... 110 V/220 V

### FOR YOUR SAFETY

Units shipped to countries other than the above countries are equipped with an AC voltage selector switch on the rear panel. Refer to the following paragraph for the proper setting of this switch.

#### AC VOLTAGE SELECTION

This unit operates on 110-220 V AC. The AC voltage selector switch on the rear panel is set to the voltage that prevails in the area to which the unit is shipped. Before connecting the power cord to your AC outlet, make sure that the setting position of this switch matches your line voltage. If not, it must be set to your voltage in accordance with the following direction.

AC voltage selector switch

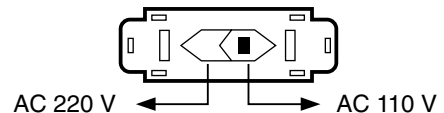

Move switch lever to match your line voltage with a small screwdriver or other pointed tool.

# CONTENTS

## Introduction

- UNPACKING AND INSTALLATION ..... 2
- READ THIS BEFORE OPERATING YOUR UNIT ..... 3

## System Connections ..... 5

## Front Panel Controls ..... 8

## Speaker Placement ..... 9

## DIGI LINK III System Remote Controls ..... 10

- REMOTE CONTROL OPERATION RANGE ..... 11
- LOADING BATTERIES ..... 11

## Operations

- ADJUSTING SPEAKER SETTINGS ..... 12
- ADJUSTING DELAY TIMES ..... 14
- LISTENING TO A PROGRAM SOURCE ..... 15
- SURROUND SOUND ..... 18
- ENJOYING SURROUND SOUND ..... 19
- LISTENING TO RADIO BROADCASTS ..... 20
- RECORDING ..... 22
- OTHER FUNCTIONS ..... 23

## Using the OSD

- CURRENT STATUS DISPLAY ..... 24
- MENU SCREEN ..... 24

## Troubleshooting Guide ..... 27

## Specifications ..... 28

# System Connections

- When making system connections, please be certain the AC cord is not plugged into an AC outlet.
- When making connections between components, please be sure to connect the white RCA plugs to the L(left) and the red RCA plugs to the R (right) jacks respectively.
- Change the position of the FM indoor antenna until you get the best possible reception of your favorite FM stations.
- A 75 ohm outdoor FM antenna may be used to further improve the reception. Disconnect the indoor antenna before connecting the outdoor antenna.
- Place the AM loop antenna as far as possible from the receiver, TV set, speaker cords and the AC input cord and set it to a direction it to a for the best reception.
- If the reception is poor with the AM loop antenna, an AM outdoor antenna can be used in place of the AM loop antenna.
- Make connections firmly and correctly. If not, it can cause loss of sound, noise or damage to the receiver.
- If the electricity fails or the AC input cord is left unplugged for about 2 weeks, the memorized contents will be lost. Memorize them again.

## CONNECTING AUDIO COMPONENTS

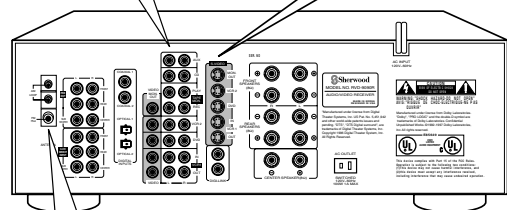
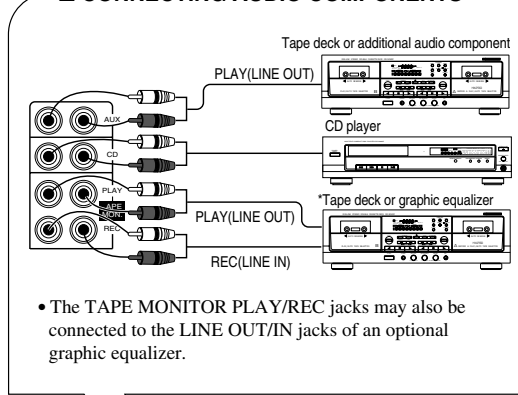

## CONNECTING ANTENNAS

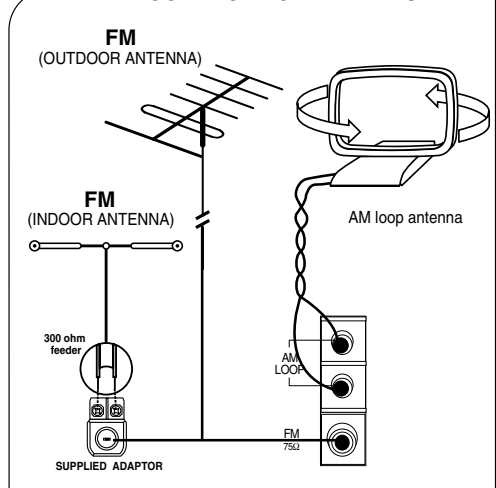

## CONNECTING VIDEO COMPONENTS

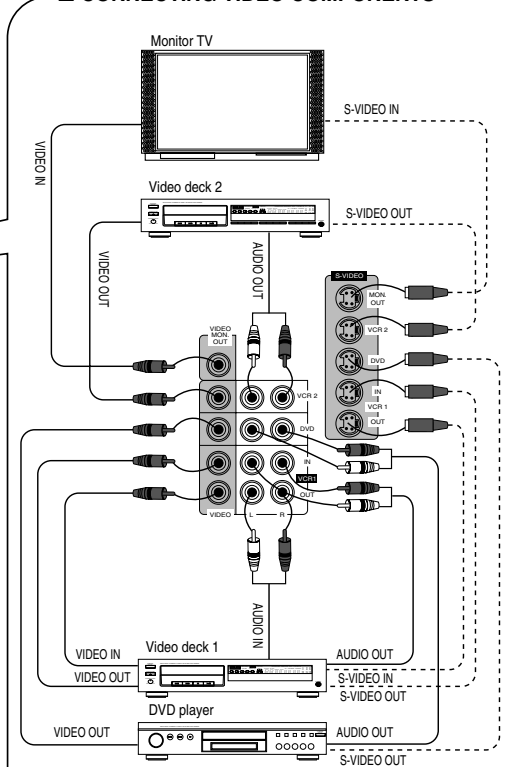

- The VCR 2(or DVD) jacks may also be connected to an additional video component such as a cable TV tuner, a LD player or satellite system.
- Use the S-VIDEO jacks to make connections to video components with S-VIDEO IN/OUT jacks. A signal input into the S-VIDEO jack will be output in only the S-VIDEO jack and a signal input into the normal VIDEO jack will be output in only the normal VIDEO jack.

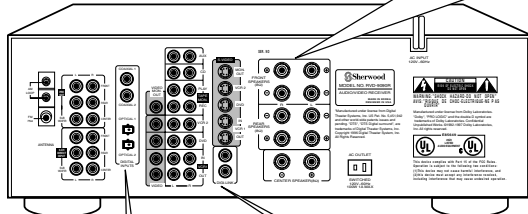

■ CONNECTING SPEAKERS

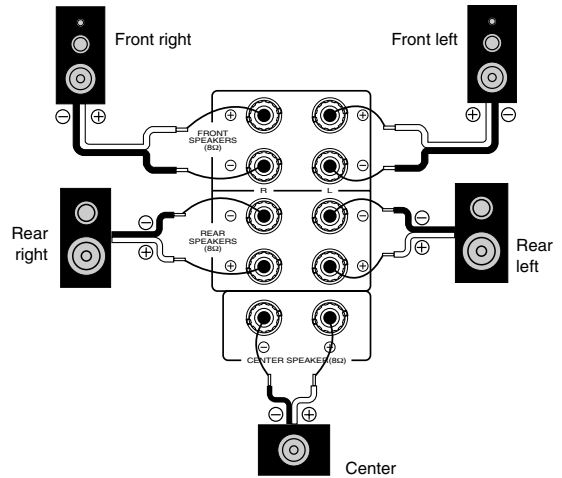

- Never short circuit the + and - speaker wires.
- Be sure to connect speakers firmly and correctly according to the channel (left and right) and the polarity (+ and -).
- Be sure to use the speakers with the impedance of over 8 Ω.
- For installing the speakers, refer to "Speaker placement" on page 9.

■ CONNECTING DIGITAL INPUTS

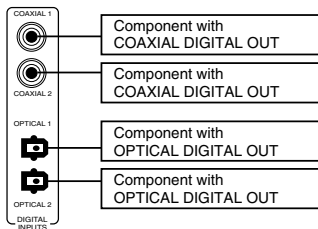

- The COAXIAL or the OPTICAL DIGITAL OUTs of the components that are connected to "CD", "VCR2" and "DVD" of this unit can be connected to these DIGITAL INPUTS.
- A digital input should be connected to the components such as LD player, CD player or DVD player, etc. capable of outputting DTS Digital Surround, Dolby Digital(AC-3) or PCM format digital signals.
- For details, refer to the operating instructions of the component connected.
- When making the COAXIAL DIGITAL connection, be sure to use a 75Ω COAXIAL cord, not a conventional AUDIO cable.

■ CONNECTING SYSTEM CONTROL

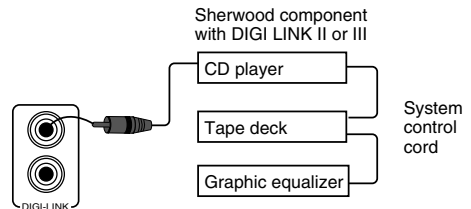

- Connect this jack to the DIGI LINK jack of the external Sherwood component that uses the DIGI LINK II or III remote control system.

**PRE OUT connections**

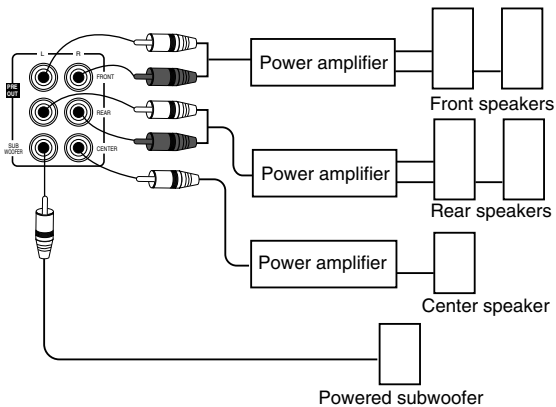

- Use these jacks when adding additional amplifiers.
- Connect the PRE OUT jacks to the powered speakers or the power amplifiers connected to speakers respectively.
- To emphasize the deep bass sounds, connect a powered subwoofer.

**AC INPUT CORD**

Plug this cord into a wall AC outlet.

**CONNECTING 6 CH DIRECT INPUTS**

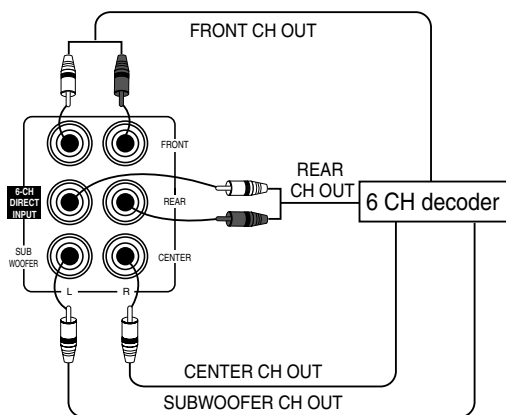

- Use these jacks to connect the corresponding analog outputs of 6 CH decoder or DVD player with 6 CH output for Dolby Digital or DTS, etc. (For details, see the operator's manual of the component to be connected.)

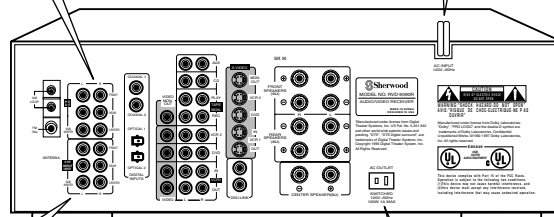

**SWITCHED AC OUTLET**

- This outlet is switched on(power on mode) and off(standby mode) according to power controls as follows(Maximum total capacity is 1A, 100W):

[ Standby mode – switched AC outlet off ]  
 [ Power on mode – switched AC outlet on ]

# Front Panel Controls

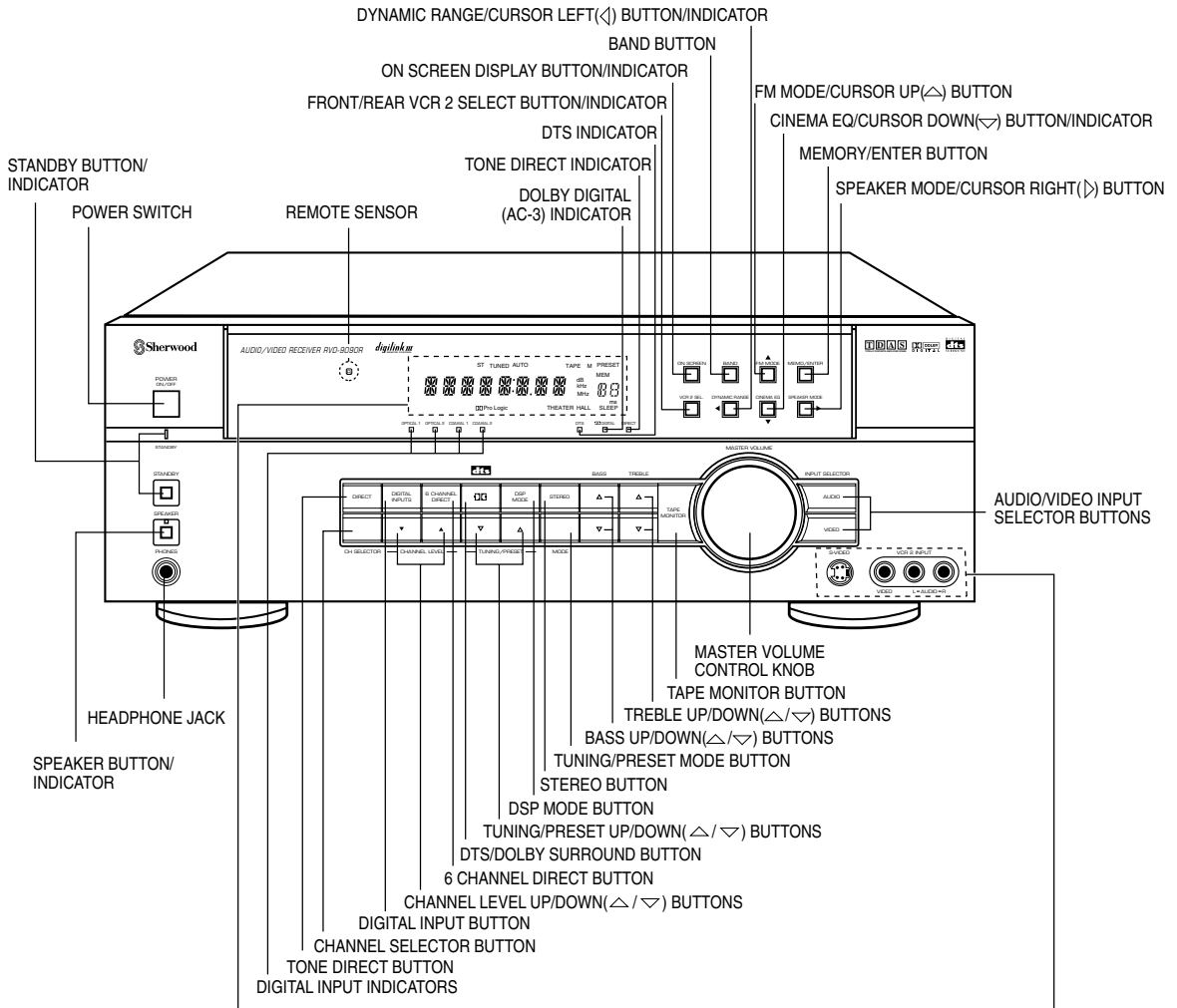

## ■ FLUORESCENT DISPLAY

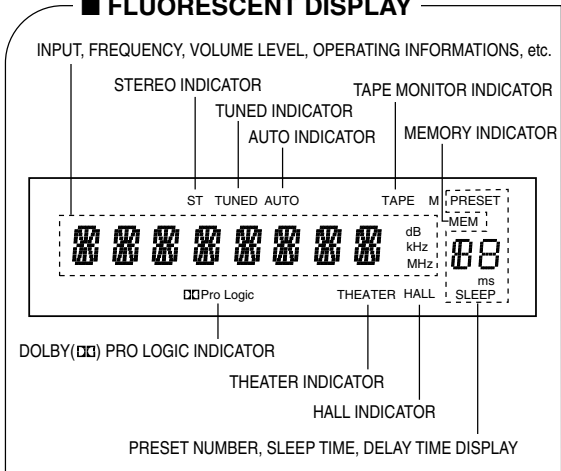

## ■ FRONT VCR 2 INPUT JACKS

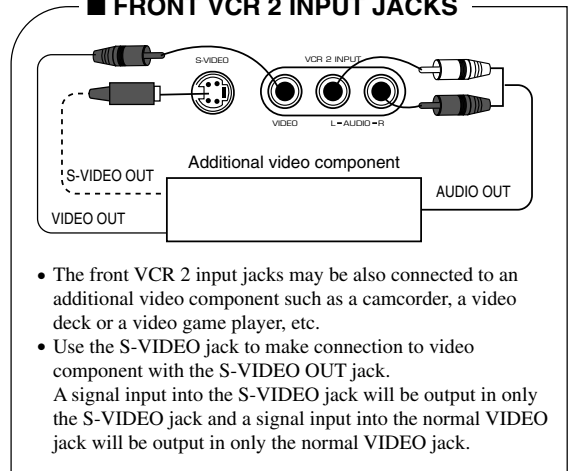



# Speaker Placement

To obtain the best surround sound effect in your home, place the speakers as follows;

- Front speakers: Place each front speaker about 1m (40") from the TV set.
- Center speaker: Place the center speaker either above or below the TV set to assure good visualization of center channel program.
- Rear speakers: Place the rear speakers approximately 1m above the ear level of a seated listener on the direct left and right of them or slightly behind.
- Subwoofer: Reproduces powerful deep bass sounds. Place a powered subwoofer anywhere in the front as desired.
- The ideal surround system needs all the speakers listed above.
- To accurately reproduce DTS digital surround, center and rear speakers as well as front speakers should be full range speakers.
- To enjoy the surround sound best, the speakers to be connected are as follows;

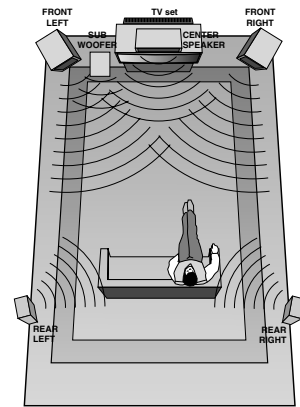

Speakers \ Modes	DTS	Dolby Digital(AC-3)	Dolby Pro Logic	Other Surround	Stereo	6 CH DIRECT
Front	Yes	Yes	Yes	Yes	Yes	Yes
Center	Yes	Yes	Yes	Optional	-	Yes
Rear	Yes	Yes	Yes	Yes	-	Yes
Subwoofer	Yes	Yes	Optional	Optional	Optional	Yes

Note: To avoid interference with the TV picture, use only magnetically shielded center and front speakers.

# DIGI LINK III System Remote Controls

- This receiver and other compatible Sherwood components can be operated via remote control.
- Compatible Sherwood components bear the DIGI LINK II or III logo.
- To enable the DIGI LINK control system, you must first interconnect the green(Digi Link) jacks on each Sherwood component using standard RCA cables. (See page 6 for details)

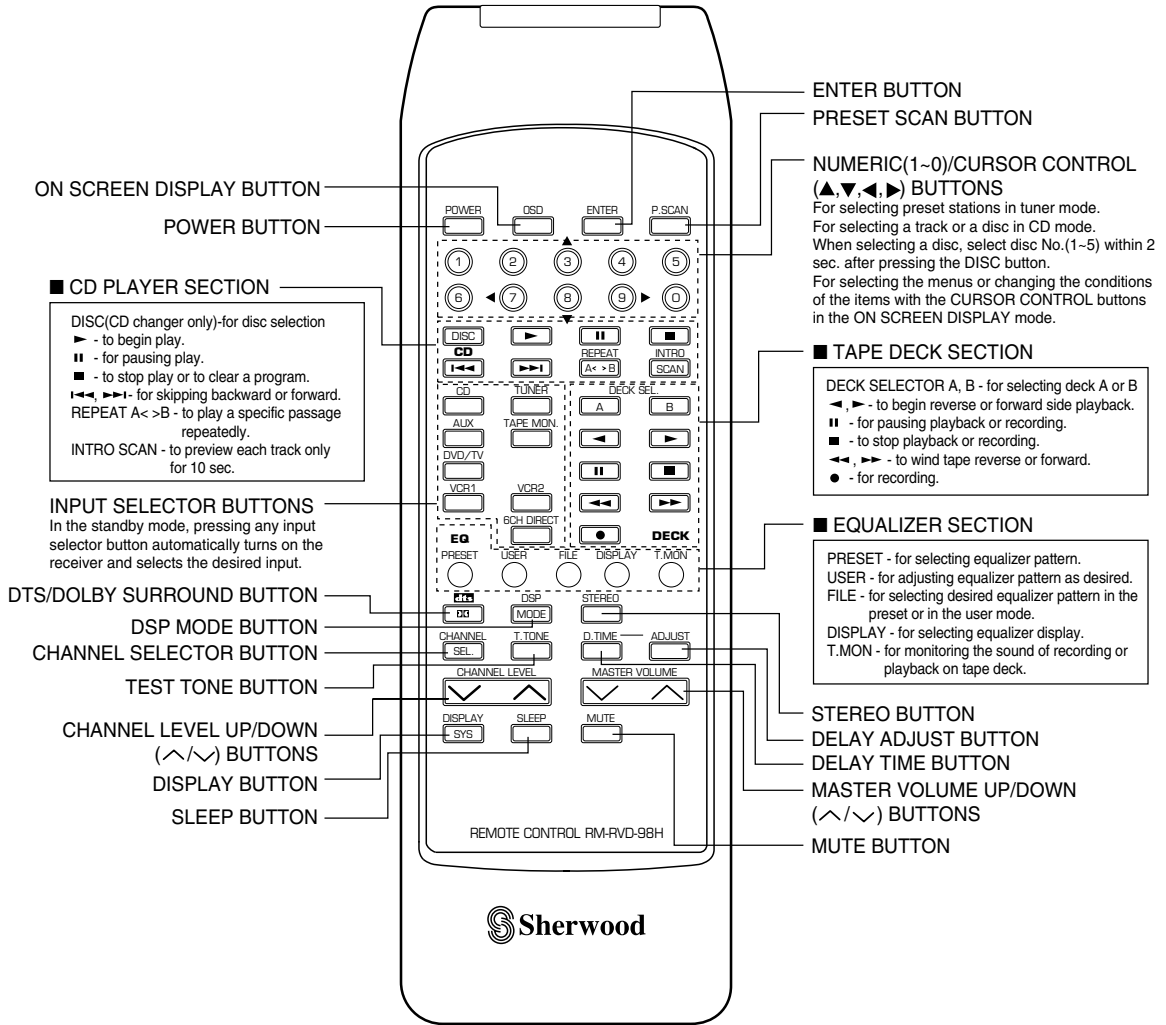

- With the Sherwood Digi Link III system, pressing a transport control key such as PLAY, on a Sherwood CD player or tape deck will automatically engage that input on the receiver and then PLAY will start.

**Notes:**

- Some functions for CD players, tape decks or equalizer may not be operable from the remote control.
- For details about functions, refer to the operating instructions of each component.

## REMOTE CONTROL OPERATION RANGE

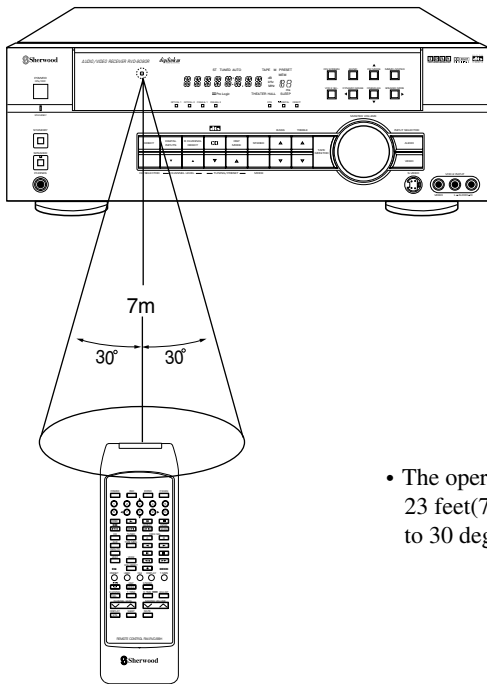

- The operating range of the remote control is about 23 feet(7 Meters) and it will operate at angles of up to 30 degrees. Aim the remote at the remote sensor.

## LOADING BATTERIES

**1**

Remove the cover.

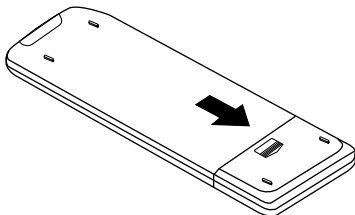

**2**

Load two batteries matching the polarity.

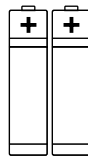

2 x 1.5V  
R 6/SUM-3/AA

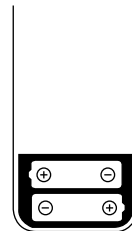

- Remove the batteries when the remote will not be used for a long time.
- Do not use the rechargeable batteries(Ni-Cd type).

## ADJUSTING SPEAKER SETTINGS

### Adjusting the speaker settings

- This receiver is equipped with circuitry that allows the use of a wide range of speaker systems.
- This circuitry works by redirecting the bass frequencies or the entire channel to speakers that are capable of reproducing them.
- When a large or full range speaker capable of deep bass response is used for one of the channels, that channel should be set to L.
- When a small or satellite speaker with limited bass capability is used, that channel should be set to S. Deep bass from that channel will be redirected to the main left and right speakers or to the subwoofer.
- When there is no speaker available, that channel should be set to N. All the information in that channel will be redirected to other available speakers.

1

With the receiver in any of the surround modes, press the SPEAKER MODE button for more than 2 seconds to enter the front-center-rear speaker set-up mode.



- The existing front-rear-center speaker setting is displayed.
- This set-up mode is not available when 6 CH DIRECT is selected as the input source or when ANALOG is selected as the signal input in the STEREO mode.

3

Memorize the desired speaker settings. Press the MEMO/ENTER button while your choice is displayed.

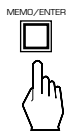

- Your requested speaker settings are entered into memory and the set-up procedure advances to the subwoofer mode.
- If the speaker setting display disappears before the MEMO/ENTER button is pressed, you must start again from Step 1, above.

5

Memorize the subwoofer setting. Press the MEMO/ENTER button while your choice is displayed.



- Your requested subwoofer setting is entered into memory.
- If the subwoofer display disappears before the MEMO/ENTER button is pressed, you must start again from Step 2, above.

2

Select the desired speaker setting.



- Each time this button is pressed, one of 11 different speaker settings is selected and displayed for 8 seconds as follows;  
FL--CS--RS, FL--CL--RS, FL--CL--RL, FL--CL--RN, FL--CS--RL, FL--CN--RL, FL--CS--RN, FL--CN--RS, FS--CS--RS, FS--CS--RN and FS--CN--RS.
- In the above, F stands for Front Speakers, C for Center Speaker, R for Rear Speakers, L for Large, S for Small and N for None.
- Large speakers are capable of deep bass response and typically have one driver with a cone that is 10" (25 cm) or larger.
- The following speaker settings cannot be selected: Front, Small : Center, Large : and Rear, Large(FS--CL--RL) : or Center, None and Rear, None(CN--RN).

4

Select the desired subwoofer setting.



- Each time this button is pressed, the subwoofer setting changes and is displayed for 8 seconds as follows;
  - ↓
  - SUB W(oofer) -- Y(es): When using a powered subwoofer.
  - ↓
  - SUB W(oofer) -- N(o) : When not using a powered subwoofer.
- If the front speakers are set to S(mall), the subwoofer is automatically set to "Y".

### Checking the speaker setting



- Each time this button is pressed briefly, the front-center-rear speaker or subwoofer setting is displayed.

## Adjusting each channel level

**6**

Select the channel to adjust.

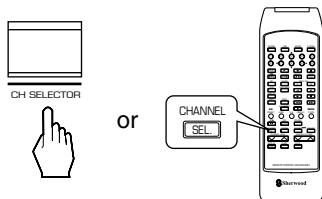

- Each time this button is pressed, the corresponding channel is selected and displayed for 3 seconds in the following order;

→ Front Left → Center → Front Right  
 ← SubWoofer ← Rear Left ← Rear Right ←

- If the receiver is in the STEREO mode, the center, rear and subwoofer channels are not available and will not be displayed.
- Speakers set to “N” are not available and will not be displayed.

**7**

Adjust the level of the selected channel as desired.

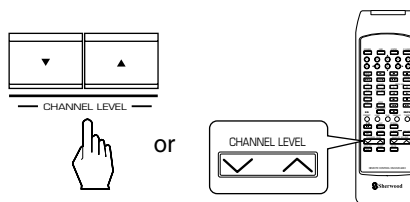

- If the channel display disappears, you must start again from step 6, above.

**8**

Repeat the above steps 6 and 7 to adjust the levels of the other channels.

## In Dolby Digital (AC-3) or Dolby Pro Logic Mode

- In these modes, the volume level of each channel can be adjusted using the test tone function.

**9**

Engage the Test Tone mode by pressing the Test Tone button on the remote control.

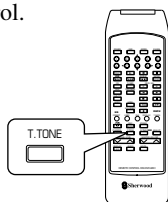

- The test tone will cycle from channel to channel and will be heard from each speaker for 2 seconds as follows;

→ Front Left → Center → Front Right  
 ← SUBwoofer ← Rear Left ← Rear Right ←

- Speakers set to “N” are not available and will not be displayed.

**11**

Cancel the test tone function by pressing the Test Tone button on the remote control.

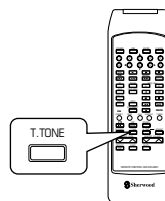

# ADJUSTING DELAY TIMES

## Adjusting delay times of the speakers in Dolby Digital(AC-3), Dolby Pro Logic and the DSP modes

- Your receiver allows you to optimize the arrival time of the sound from your speakers. This can help focus the audio image and add enjoyment to your home theater experience.

Measure the distance from the prime listening position to each of the speakers to the nearest foot.

-In the Dolby Digital mode, the optimum performance of your system occurs when the sound from all five speakers arrives at your primary listening position at the same time. If all speakers are equidistant from the main listening position, set the following delay.

Center delay time : 0 mS, Rear delay time : 0 mS

- If the center speaker is closer to your prime listening position than the average distance to the left and right main speakers add 1 mS of center channel delay for each foot of difference. The maximum is 5 mS.
- If the surround speakers are closer to your main listening position than the main left and right speakers add 5 mS of surround channel delay for each 5 feet of difference. The maximum is 15 mS.

-In Dolby Pro Logic and the three DSP modes rear channel delay can be adjusted to add spaciousness to the presentation and to minimize any sibilant leakage into the surround channels.

If the surround speakers are the same distance from your primary listening position as your main left and right front speakers, set the Rear Delay time at 15 mS.

- If the surround speakers are further from your listening position than the main left and right front speakers, set the rear delay at 10 mS.
- If the surround speakers are closer to your main listening position than the main left and right speakers add 5 mS of surround channel delay for each 5 feet of difference. The maximum is 30 mS.

### 12

Check the current delay time. Press the D.Time button on the remote control.

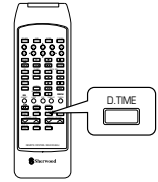

- The current delay time will be displayed for 5 seconds.
- In the Dolby Digital mode, only, the center delay is adjustable and the corresponding delay time is displayed.
- When playing Dolby Digital program sources in the Theater, Hall 1 or Hall 2 modes, the center and rear delay is adjustable just as it is in the Dolby Digital Mode.

### 13

Adjust the delay time.

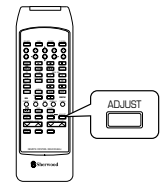

- Each time this button is pressed, the delay time changes in regular steps.
- If the delay time disappears, please start again from step 12.

### 14

Memorize the delay time.

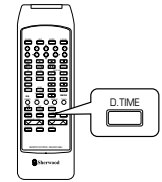

- For center delay in the Dolby Digital mode, only. The rear delay time is memorized automatically without pressing the DELAY TIME button.

### 15

In the Dolby Digital mode, repeat the above steps 13 and 14 to adjust the rear delay time.

## Downmixing into 2 front channels

- Allows the multi-channel DTS or Dolby Digital(AC-3) signal to be reproduced through only two speakers or through headphones.
- While playing the DTS or Dolby Digital(AC-3) program sources, press the STEREO button.

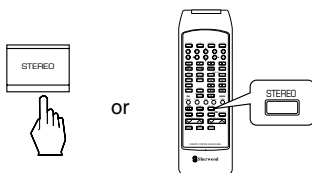

- The "ST" and the "DTS" or "Dolby Digital" indicators light up indicating that the program has entered the 2-CH downmix mode and the 5 discrete channels(left front, center, right front, left surround and right surround) are mixed down to the 2 front channels.

- To cancel the 2-CH downmix mode, select the desired surround mode.
- When play is stopped or interrupted, etc., the 2-CH downmix mode is not canceled even though the "ST" and the "DTS" or "Dolby Digital" indicators go out.
- DTS and Dolby Digital multi-channel program material will be heard automatically in the 2-CH downmix mode if headphones are plugged in and the SPEAKER switch is set to off. However, only the DTS or Dolby Digital indicator will be illuminated. Unplugging the headphones and setting the SPEAKER switch to on will restore the previous mode.

# LISTENING TO A PROGRAM SOURCE

## Before operation

- Enter the standby mode.

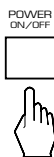

- The STANDBY indicator lights up. The receiver remains connected to the AC main electrical supply and a small amount of current is retained to support the on-board memory and rapid turn-on.
- To switch the power off, push the POWER switch again.
- Then the power is cut off and the STANDBY indicator goes off.

1

In the standby mode, turn the power on.

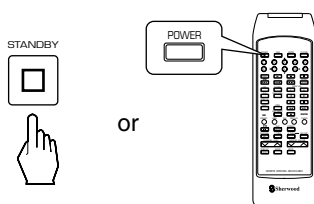

- Each time the STANDBY button on the front panel or the POWER button on the remote control is pressed, the receiver turns on and enters the operating mode or turns off to enter the standby mode.
- In the standby mode, pressing any INPUT SELECTOR button automatically turns the receiver on and selects the desired input.

2

Switch the speakers on.



- The SPEAKER indicator will light up and sound can be heard from the speakers connected to the receiver's speaker terminals.
- When using the headphone for private listening, press the SPEAKER button again to turn the speakers off.

3

Select the desired input source.

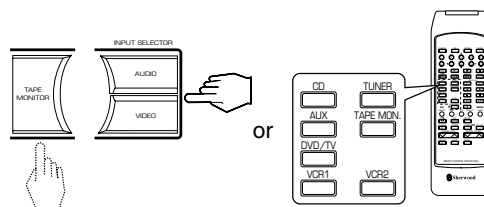

- Each time the "AUDIO" button is pressed, the input source changes as follows;

→ TUNER → CD → AUX  
(frequency display)

- Each time the "VIDEO" button is pressed, the input source changes as follows;

→ VCR1 → VCR2 → DVD

- When the TAPE MONITOR button is set to on, the "TAPE M" indicator lights up and the source connected to the TAPE MONITOR input can be heard. To listen to a source other than the one connected to the TAPE MONITOR, be sure the TAPE MONITOR is set to off.

### TAPE MONITOR function

Either a tape deck or a graphic equalizer can be connected to the receiver's TAPE MONITOR jacks. To listen to the component connected to these jacks, press the TAPE MONITOR button to on.

If a 3-Head tape deck is connected to the TAPE MONITOR jacks, you can listen to the sound directly from the tape while it is being recorded and not the source.

For further details, refer to the operating instructions of the component connected to these jacks.

- When the VCR 2 is selected as input source.

- Select the front or the rear VCR 2.



- If the front VCR 2 is selected, the "VCR 2 SEL" button lights up.

• The 6 CH DIRECT INPUT

Use this input to listen to the audio output of an external decoder or a DVD player with built-in 6 channel decoder.

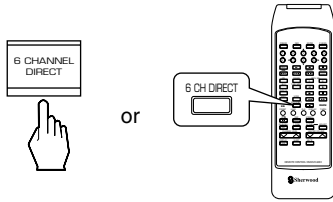

- 6-DIRECT is displayed and the 6 separate analog signals from a decoder or DVD player will be connected to this unit. You can use the tone controls and volume control to adjust the signal. (If the TAPE MONITOR button is on, it will automatically be set to off.)
- To cancel the 6 CH direct function, press the 6 CH DIRECT button again or select the desired input source.
- These 6 separate analog signals can be heard, only. They cannot be recorded.

**5** Operate the selected component for playback.

- When playing back the program sources with surround sound, refer to “ENJOYING SURROUND SOUND” on page 19.

**6** Adjust the (overall) volume.

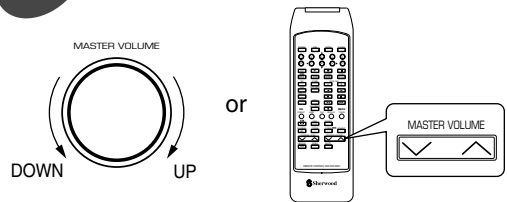

**When CD, VCR2 or DVD is selected as input source**

**4** Select the digital or the analog input connected as desired.

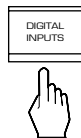

- Each time this button is pressed, the corresponding input is selected as follows;



- To listen to Dolby Digital (AC-3) program source in the 2-CH downmix mode, in the stereo mode, the corresponding digital input should be selected. (For details, refer to “Downmixing into 2 front channels” on page 14)

■ Notes:

- When there is no signal at the selected optical or coaxial digital input, the selected DIGITAL INPUT indicator will flicker meaning there is no sound at the input. (refer to “ENJOYING SURROUND SOUND” on page 19).
- The sound from the component connected to the selected digital input can be heard regardless of the selected input source.

**7** Adjust the tone(bass and treble).

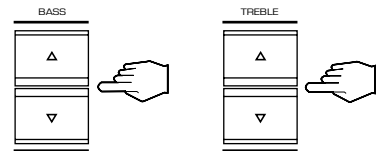

■ Notes:

- Extreme settings at high volume may damage your speakers.
- In the DTS or Dolby Digital (AC-3) mode, the tone cannot be adjusted and the tone direct function is automatically enabled.

**8** To listen to a program source without the tone effect.

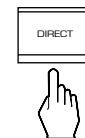

- The TONE DIRECT indicator lights up and the sound bypasses the tone circuitry.
- To cancel the tone direct function, press this button again.



**9**

To compensate for edgy or shrill movie sound tracks.



- Press it again to cancel.

**10**

To mute the sound.

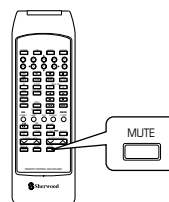

- "MUTE" will flicker.
- To resume the previous sound level, press it again.

**11**

To listen with headphones.





- Ensure that the SPEAKER button is set to off.
- DTS or Dolby Digital multi-channel program material will be heard automatically in the 2-CH downmix mode if headphones are plugged-in and the SPEAKER switch is set to off. (For details, refer to "Downmixing into 2 front channels" on page 14.)

## SURROUND SOUND

- This unit incorporates a sophisticated Digital Signal Processor that allows you to create optimum sound quality and sound atmosphere in your personal Home Theater.

### Surround modes

This unit has 6 different surround modes to allow you to enjoy surround sound with various program sources: DTS, DOLBY DIGITAL(AC-3), DOLBY PRO LOGIC, THEATER, HALL 1, HALL 2.

**DTS (Digital Theater System)** : Allows you to enjoy 5.1(or 6) discrete channels of high quality digital audio from DTS program sources bearing the “”, “” or “HIGH DEFINITION SURROUND” trademark such as laser discs, DVD and compact discs, etc., DTS Digital Surround delivers up to 6 channels of transparent audio identical to the original masters and results in exceptional clarity throughout a true 360° soundfield. “DTS” and DTS Digital Surround are trademarks of Digital Theater Systems, Inc.

Note : The DTS program sources should be played back in the DTS mode. If not, no sound or a sound like continuous noise will be heard.

**DOLBY DIGITAL(AC-3)** : Allows you to enjoy up to 5.1 channels of digital surround sound from Dolby Digital(AC-3) program sources bearing the “” trademark such as laser discs, Digital Television Broadcasts and some satellite transmissions. Dolby Digital (AC-3) provides better sound quality, improved dynamic range and great sense of direction, when compared with conventional Dolby Surround.

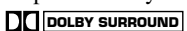
**DOLBY PRO LOGIC** : This unit incorporates the Dolby Pro Logic Surround Decoder which has the same functions for playback as movie theaters and gives a theater- like experience in your home. Use with Dolby Pro Logic program sources bearing the “” trademark such as video cassette tapes or laser discs.

- Manufactured under licence from Dolby Laboratories. “Dolby”, “Pro Logic” and the double-D symbol are trademarks of Dolby Laboratories. © 1992-1997 Dolby Laboratories, Inc. All rights reserved.

**THEATER** : This mode provides the effect of being in a movie theater when watching a movie source that has a stereo sound track.

**HALL 1** : This mode provides the ambience of a concert hall for classical music sources such as orchestral, chamber music or an instrumental solo.

**HALL 2** : This mode provides the expansive sound field. For music sources like a rock concert, you will feel as if you were actually at the live concert.

- When the 6 CH DIRECT INPUTS are connected to the 6 CH decoder for surround sound such as Dolby Digital(AC-3) or DTS, etc., you can enjoy the corresponding surround sound, too.(For details, see the operator’s manual of the component to be connected.)

# ENJOYING SURROUND SOUND

- Surround sound will not work properly if the signal passes through a graphic equalizer. Please refer to your equalizer operating instructions for guidance on switching off (or defeating) the equalizer.

Select the desired surround mode.

- When selecting the DTS or Dolby Surround mode.

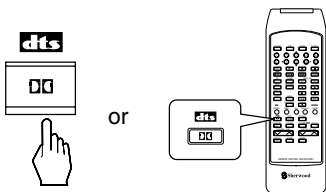

- When selecting a surround mode between THEATER, HALL 1 and HALL 2 modes.

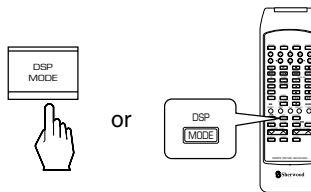

- When playing program sources bearing the “”, “” or “” trademark such as video, DVD or LD software, the DTS, Dolby Digital (AC-3) or Dolby Pro Logic mode is automatically selected according to the input signal.
- When playing the Dolby Digital (AC-3) program sources encoded into 2 channel format, either the Dolby Pro Logic mode or the Dolby Digital (AC-3) mode is automatically selected according to the encoding process. (If the Dolby Digital (AC-3) mode is automatically selected, pressing the DTS/DOLBY SURROUND button will select the Dolby Pro Logic mode.)
- To enjoy the DTS or Dolby Digital mode, be sure that the program source and the corresponding digital input are selected correctly. If not, no sound will be heard.

- Each time the DSP MODE button is pressed, the surround mode changes as follows;



- Playing the DTS or Dolby Surround program sources (bearing the “”, “” or the “” trademark) in THEATER, HALL 1 or HALL 2 mode will produce better surround effects.
- When the 6 CH DIRECT is selected as input source, the surround mode cannot be selected.

- When canceling the surround mode for normal stereo operation.

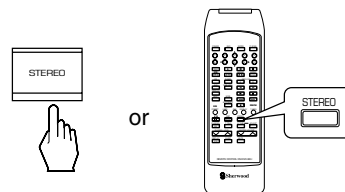

# LISTENING TO RADIO BROADCASTS

## Auto tuning

**1** Select the tuner.

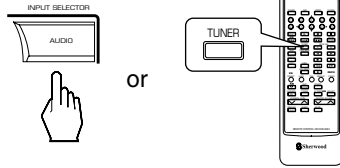

**2** Select the desired band.

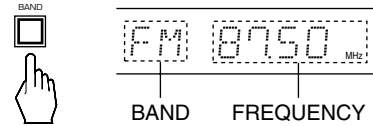

- Each time this button is pressed, the band is changed to FM or AM.
- When pressing the BAND button without selecting the TUNER, the tuner will be selected automatically.

**3** Select the tuning mode.

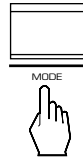

- Each time this button is pressed, the mode changes as follows;

↳ Tuning mode : “PRESET” goes off.      ↳  
 ↳ Preset mode : “PRESET” lights up.      ↳

**4** Press the TUNING/PRESET UP(Δ) or DOWN(∇) button for more than 0.5 second.

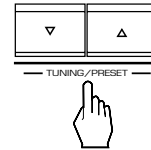

- Then “AUTO” appears on the display. The tuner will now search until a station of sufficient strength has been found. The display shows the tuned frequency and “TUNED”.
- If the station found is not the desired one, simply repeat this operation.
- Weak stations are skipped during auto tuning.

## Manual tuning

- Manual tuning is useful when you already know the frequency of the desired transmitter.
- Perform the steps 1~3 in “Auto tuning” procedure and press the TUNING/PRESET UP(Δ) or DOWN(∇) button repeatedly until the right frequency has been reached.

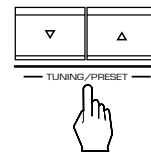

## Presetting radio stations

- You can store up to 30 preferred stations in the memory.

**1** Tune in the desired station with auto or manual tuning.

**2** Press the MEMORY/ENTER button.



- “MEM” will flicker for 5 seconds.

3

Select the desired preset number (1~30) and press the MEMORY button.

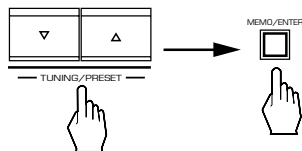

- When using the NUMERIC buttons on the remote control.  
Examples)  
For “3” : ③
- For “15” : ① → ⑤ (within 2 seconds)
- The station will now be stored in memory.
- When using the NUMERIC buttons, the station is stored automatically without the MEMORY/ENTER button.
- A stored frequency is erased from the memory by storing another frequency in its place.
- If “MEM” goes off, start again from the above step 2.

4

Repeat the above steps 1 to 3 to memorize other stations.

■ MEMORY BACKUP FUNCTION

The following items, set before the receiver is turned off, are memorized.

- INPUT SELECTOR settings
- Surround mode settings
- Preset stations, etc.

Note : If the electricity fails or the AC cord is disconnected for about 2 weeks, memorized items will be lost. Memorize them again.

Tuning to preset stations

1

After selecting the tuner as input source, select the preset tuning mode.

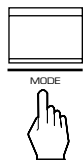

- Then “PRESET” lights up.

2

Select the desired preset number.

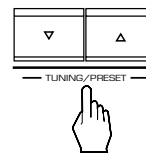

- When using the NUMERIC buttons on the remote control.  
Examples)  
For “3” : ③
- For “15” : ① → ⑤ (within 2 seconds)
- When selecting the desired preset number with the NUMERIC buttons, the desired preset station will be tuned to automatically without first selecting the preset tuning mode.

Listening to FM stereo broadcasts

- While listening to FM broadcasts.

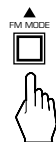

- Each time this button is pressed, the FM mode changes as follows;

↳ Stereo mode : “ST” lights up.      ↳  
↳ Mono mode : “ST” goes off.      ↳

- When FM stereo broadcasts are poor because of weak broadcast signals, select the FM mono mode to reduce the noise, FM broadcasts are then reproduced in monaural sound.

Scanning preset stations in sequence

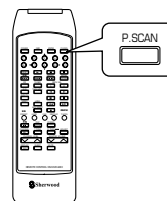

- The receiver will start scanning the stations in the preset sequence and each station is received for 5 seconds.
- At the desired station, press this button again to stop scanning.

# RECORDING

- The analog signals from the 6 CH DIRECT inputs and the digital signals from the coaxial or optical digital input can be heard but cannot be recorded.
- The volume and tone (bass, treble) settings, etc. have no effect on the recording signals.

## Recording with TAPE MONITOR

- 1** Select the desired input as recording source except for TAPE MONITOR.

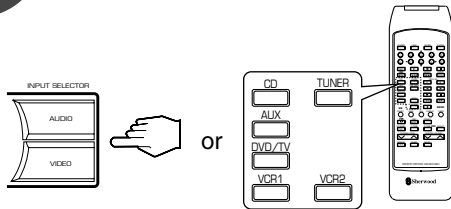

- Be sure that "TAPE M" goes off.

- 2** Start recording on the component connected to the TAPE MONITOR.

- 3** Start play on the desired input.

- For tape monitor function, refer to "TAPE MONITOR function" on page 15.

## Dubbing from video components onto VCR 1

- 1** Select VCR 2 or DVD as recording source.

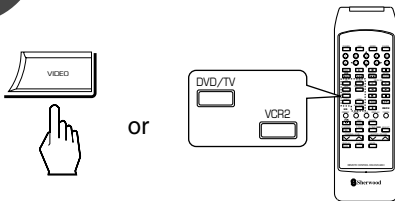

- 2** Start recording on the VCR 1.

- 3** Start play on the VCR 2 or the DVD.

- The audio and video signals from the VCR 2 or the DVD will be dubbed onto the VCR 1 and you can enjoy them on the TV set and from the speakers.

## Dubbing the audio and video signals separately onto VCR 1

Example) When dubbing the DVD video signal and the CD audio signal separately onto VCR 1.

- 1** Select DVD as video recording source.

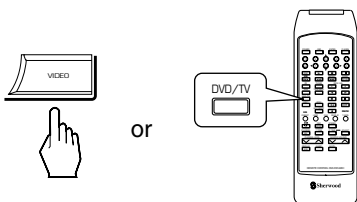

- 2** Select CD as audio recording source.

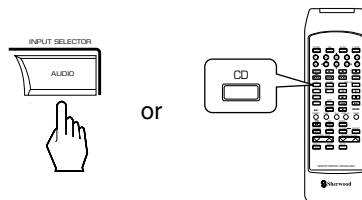

**3** Start recording on the VCR 1.

**4** Start play on the DVD and the CD respectively.

- The audio signal from the CD and the video signal from the DVD will be dubbed and you can enjoy them on the TV set and from the speakers.

Note : Be sure to observe the order of the above steps 1 and 2.

## OTHER FUNCTIONS

### Compressing the dynamic range (Dolby Digital(AC-3) mode only)

- This function compresses the dynamic range of previously specified parts of the Dolby Digital(AC-3) sound track(with extremely high volume) to minimize the difference in volume between the specified and non-specified parts. This makes it easy to hear all of the sound track when watching movies at night at low levels.

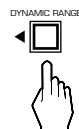

- Then the DYNAMIC RANGE button lights up.
- Press again to cancel.
- In some Dolby Digital(AC-3) software, this function may not be available.

### Operating the sleep timer

- The sleep timer allows the system to continue to operate for a specified period of time before automatically shutting off.
- To set the receiver to automatically turn off after the specified period of time.

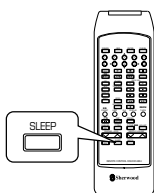

- Each time this button is pressed, the sleep time changes as follows;

→ 10 → 20 → 30 → 60 → 90 → OFF →  
Unit : minutes

- When the sleep time is selected, all display panels of Sherwood components connected by the DIGI LINK III will dim.

### Adjusting the brightness of the fluorescent displays

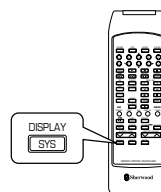

- Each time this button is pressed, the brightness of all fluorescent displays of Sherwood components connected by the DIGI LINK III change together as follows;

→ ON → dim → OFF →

- In the display OFF mode, pressing any button will restore the display ON mode.

# Using the OSD

This unit incorporates an OSD(On screen display) function to provide information about basic operation of this unit and to simplify the set-up procedures.

The OSD function uses a monitor TV connected to this unit as a display and has two kinds of display modes; current status display and menu screen.

Note:

- Any on screen display visible on the monitor TV will not be recorded on VCR 1.

## CURRENT STATUS DISPLAY

This mode shows the status corresponding to each operation.

- The on screen display will automatically disappear in 5 seconds.
- For examples, there are 2 status displays as follows.
  - When selecting the desired input source.
  - When selecting the TEST TONE mode.

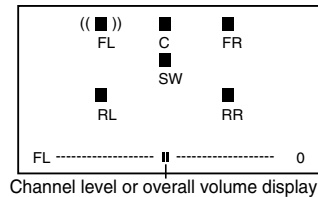
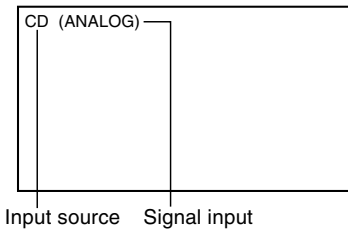

- When adjusting each channel level or overall volume, the volume level display will be shown.
- The test tone display will be shown until the test tone mode is canceled.

## MENU SCREEN

- This function simplifies the set-up procedure such as speaker mode, function select, surround mode, delay time and channel level trim.
- The menu screen operation is performed easily with the CURSOR control(▲, ▼, ◀, ▶), ON SCREEN DISPLAY and (MEMORY/) ENTER buttons.

The FM MODE button on the front panel corresponds to the CURSOR UP(▲) button on the remote control, the CINEMA EQ to the CURSOR DOWN(▼), the DYNAMIC RANGE to the CURSOR LEFT(◀) and the SPEAKER MODE to the CURSOR RIGHT(▶).

1

Turn the menu screen on.

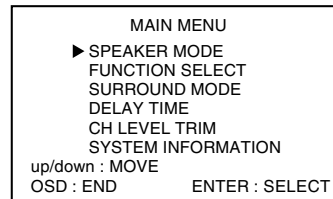
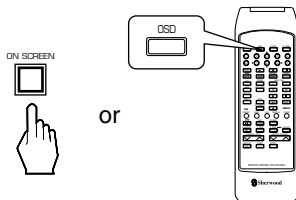

Main menu display

- The main menu will be shown.
- To turn the menu screen off, press this button again.

In the bottom of the display, “up” stands for the CURSOR UP(▲) button, “down” for the CURSOR DOWN(▼), “→” for the CURSOR RIGHT(▶), “←” for the CURSOR LEFT(◀), “OSD” for the ON SCREEN DISPLAY and “ENTER” for (MEMORY/) ENTER.



**2** Select the desired menu using the CURSOR UP(▲) or DOWN(▼) button.

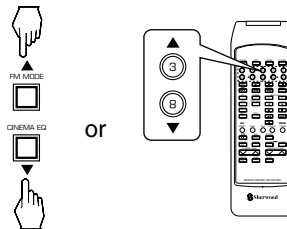

**3** Confirm your selection.

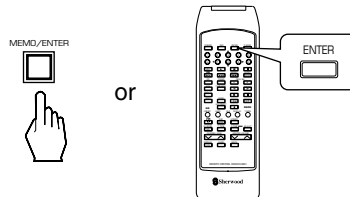

■ When selecting the SPEAKER MODE.

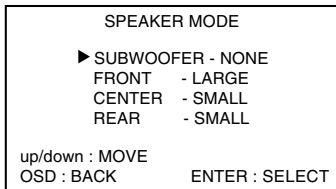

■ When selecting the FUNCTION SELECT.

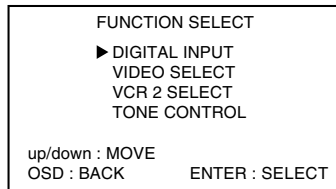

■ When selecting the SURROUND MODE.

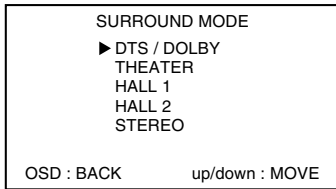

■ When selecting the DELAY TIME.

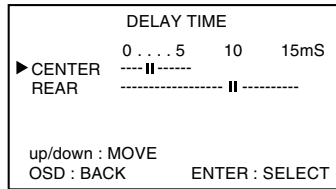

■ When selecting the CH LEVEL TRIM.

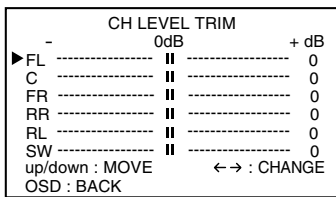

■ When selecting the SYSTEM INFORMATION.

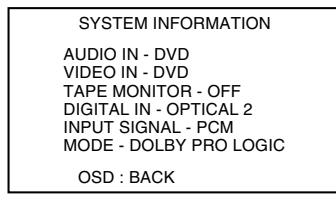

• The conditions of each menu may differ according to the actual settings of the speaker mode, surround mode, etc.

**4**

Select the desired menu or (and) change the condition with the corresponding buttons.

**5**

Repeat the above steps 2~4 to change the conditions on other menus.

# Troubleshooting Guide

If a fault occurs, run through the table below before taking your receiver for repair.

If the fault persists, attempt to solve it by switching the receiver off and on again. If this fails to resolve the situation, consult your dealer. Under no circumstances should you attempt to repair the receiver yourself as this could invalidate the warranty!

PROBLEM	POSSIBLE CAUSE	REMEDY
No power	<ul style="list-style-type: none"> <li>• The AC input cord is disconnected.</li> <li>• Poor connection at AC wall outlet or the outlet is inactive.</li> </ul>	<ul style="list-style-type: none"> <li>• Connect cord securely.</li> <li>• Check the outlet using a lamp or another appliance.</li> </ul>
No sound	<ul style="list-style-type: none"> <li>• The speaker wires are disconnected.</li> <li>• The master volume is adjusted too low.</li> <li>• The MUTE button on the remote control is pressed to ON.</li> <li>• Speakers are not switched on.</li> <li>• Incorrect selection of input source.</li> <li>• Incorrect connections between the components.</li> </ul>	<ul style="list-style-type: none"> <li>• Check the speaker connections.</li> <li>• Adjust the master volume.</li> <li>• Press the MUTE button to cancel the muting effect.</li> <li>• Press the SPEAKER button to ON.</li> <li>• Select the desired input source correctly.</li> <li>• Make connections correctly.</li> </ul>
No sound from the rear speakers	<ul style="list-style-type: none"> <li>• Surround mode is switched off(normal stereo mode).</li> <li>• Master volume and rear level are too low.</li> <li>• Monaural source is used.</li> <li>• Rear speaker setting is "N".</li> </ul>	<ul style="list-style-type: none"> <li>• Select a surround mode.</li> <li>• Adjust master volume and rear level.</li> <li>• Select a stereo or surround source.</li> <li>• Select the desired rear speaker setting.</li> </ul>
No sound from the center speaker	<ul style="list-style-type: none"> <li>• Surround mode is switched off(normal stereo mode).</li> <li>• Center speaker setting is "N".</li> <li>• Master volume and center level are too low.</li> </ul>	<ul style="list-style-type: none"> <li>• Select the desired surround.</li> <li>• Select the desired center speaker setting.</li> <li>• Adjust master volume and center level.</li> </ul>
Stations cannot be received	<ul style="list-style-type: none"> <li>• No antenna is connected.</li> <li>• The desired station frequency is not tuned in.</li> <li>• Antenna is in wrong position.</li> </ul>	<ul style="list-style-type: none"> <li>• Connect an antenna.</li> <li>• Tune in the desired station frequency.</li> <li>• Move antenna and retry tuning.</li> </ul>
Preset stations cannot be received	<ul style="list-style-type: none"> <li>• An incorrect station frequency has been memorized.</li> <li>• The memorized stations are cleared.</li> </ul>	<ul style="list-style-type: none"> <li>• Memorize the correct station frequency.</li> <li>• Memorize the stations again.</li> </ul>
Poor FM reception	<ul style="list-style-type: none"> <li>• No antenna is connected.</li> <li>• The antenna is not positioned for the best reception.</li> </ul>	<ul style="list-style-type: none"> <li>• Connect an antenna.</li> <li>• Change the position of the antenna.</li> </ul>
Continuous hissing noise during FM reception, especially when a stereo broadcast is received.	<ul style="list-style-type: none"> <li>• Weak signals.</li> </ul>	<ul style="list-style-type: none"> <li>• Change the position of the antenna.</li> <li>• Install an outdoor antenna.</li> </ul>
Continuous or intermittent hissing noise during AM reception, especially at night.	<ul style="list-style-type: none"> <li>• Noise is caused by motors, fluorescent lamps or lightning, etc.</li> </ul>	<ul style="list-style-type: none"> <li>• Keep the receiver away from noise sources.</li> <li>• Install an outdoor AM antenna.</li> </ul>
Remote control unit does not operate.	<ul style="list-style-type: none"> <li>• Batteries are not loaded or exhausted.</li> <li>• The remote sensor is obstructed.</li> </ul>	<ul style="list-style-type: none"> <li>• Replace the batteries.</li> <li>• Remove the obstacle.</li> </ul>
Other system components do not react to remote control commands.	<ul style="list-style-type: none"> <li>• DIGI LINK connections are not made properly.</li> </ul>	<ul style="list-style-type: none"> <li>• Make proper DIGI LINK connections.</li> </ul>
OSD function is not be available.	<ul style="list-style-type: none"> <li>• Video connections between this unit and the monitor TV are not made correctly.</li> </ul>	<ul style="list-style-type: none"> <li>• Make proper video connections.</li> </ul>

# Specifications

## ■ AMPLIFIER SECTION

- Power output, stereo mode, 8  $\Omega$ , THD 0.2%, 40 Hz~20 kHz ..... 2  $\times$  100 W
- Total harmonic distortion, 8  $\Omega$ , 100 W, 1 kHz ..... 0.09%
- Intermodulation distortion  
60 Hz : 7 kHz= 4 : 1 SMPTE, 8  $\Omega$ , 100 W ..... 0.07%
- Input sensitivity, 47 k $\Omega$   
Line (CD, TAPE, VCR) ..... 200 mV
- Signal to noise ratio, IHF "A" weighted  
Line (CD, TAPE, VCR) ..... 95 dB
- Frequency response  
Line (CD, TAPE, VCR), 10 Hz~60 kHz ..... +0 dB, -3 dB
- Output level  
TAPE REC, 2.2 k $\Omega$  ..... 200 mV  
PRE OUT(Front, Center, Rear, Subwoofer), 1 k $\Omega$  ..... 1.0 V
- Bass/Treble control, 100 Hz/10 kHz .....  $\pm$  10 dB
- Surround mode, only channel driven  
Front power output, 8  $\Omega$ , 1 kHz, THD 0.7 % ..... 105 W+105 W  
Center power output, 8  $\Omega$ , 1 kHz, THD 0.7 % ..... 105 W  
Rear power output, 8  $\Omega$ , 1 kHz, THD 0.7 % ..... 105 W+105 W

## ■ DIGITAL AUDIO SECTION

- Sampling frequency ..... 32, 44.1, 48 kHz
- Digital input level  
Coaxial, 75  $\Omega$  ..... 0.5 Vp-p  
Optical, 660 nm ..... -15~-21 dBm

## ■ VIDEO SECTION

- Television format..... NTSC
- Input sensitivity(=Output level), 75  $\Omega$   
Video(Composite (normal)) ..... 1 Vp-p  
S-video(luminance signal) ..... 1 Vp-p  
(chrominance signal) ..... 0.286 Vp-p

## ■ FM TUNER SECTION

- Tuning frequency range ..... 87.5~108 MHz
- Usable sensitivity, THD 3%, S/N 30 dB ..... 11.2 dBf
- 50 dB quieting sensitivity, mono/stereo ..... 15.2/38.2 dBf
- Signal to noise ratio, 65 dBf, mono/stereo ..... 70/68 dB
- Total harmonic distortion, 65 dBf, 1 kHz, mono/stereo ..... 0.2/0.3 %
- Frequency response, 30 Hz~15 kHz .....  $\pm$  1.5 dB
- Stereo separation, 1 kHz ..... 45 dB
- Capture ratio ..... 1.25 dB
- IF rejection ratio ..... 120 dB

## ■ AM TUNER SECTION

- Tuning frequency range ..... 520~1710 kHz
- Usable sensitivity ..... 500  $\mu$ V/m
- Signal to noise ratio, 80 dB/m ..... 45 dB
- Selectivity ..... 30 dB

## ■ GENERAL

- Power supply ..... AC 120 V, 60 Hz
- Power consumption ..... 2.8 A
- Switched AC outlet ..... TOTAL 1 A, 100 W max.
- Dimensions (W  $\times$  H  $\times$  D) ..... 440  $\times$  140  $\times$  380 mm(17-3/8  $\times$  5-1/2  $\times$  15 inches)
- Weight (Net) ..... 11 kg(24.3 lbs)

Note: Design and specifications are subject to change without notice for improvements.

# O P E R A T I N G I N S T R U C T I O N S



**RVD-9090R**  
**AUDIO/VIDEO RECEIVER**

5707-04712-001-0

## Free Manuals Download Website

<http://myh66.com>

<http://usermanuals.us>

<http://www.somanuals.com>

<http://www.4manuals.cc>

<http://www.manual-lib.com>

<http://www.404manual.com>

<http://www.luxmanual.com>

<http://aubethermostatmanual.com>

Golf course search by state

<http://golfingnear.com>

Email search by domain

<http://emailbydomain.com>

Auto manuals search

<http://auto.somanuals.com>

TV manuals search

<http://tv.somanuals.com>