



RX-5502
AM/FM 4CHANNEL STEREO RECEIVER



5707-00000-054-0S



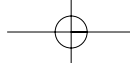

OPERATING INSTRUCTIONS

RX-5502
AM/FM 4CHANNEL STEREO RECEIVER



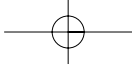

SAFETY INSTRUCTIONS

- 1. Read Instructions** - All the safety and operating instructions should be read before the product is operated.
- 2. Retain instructions** - The safety and operating instructions should be retained for future reference.
- 3. Heed Warnings** - All warnings on the product and in the operating instructions should be adhered to.
- 4. Follow Instructions** - All operating and use instructions should be followed.
- 5. Cleaning** - Unplug this product from the wall outlet before cleaning. Do not use liquid cleaners or aerosol cleaners. Use a damp cloth for cleaning.
- 6. Attachments** - Do not use attachments not recommended by the product manufacturer as they may cause hazards.
- 7. Water and Moisture** - Do not use this product near water - for example, near a bath tub, wash bowl, kitchen sink, or laundry tub; in a wet basement, or near a swimming pool; and the like.
- 8. Accessories** - Do not place this product on an unstable cart, stand, tripod, bracket, or table. The product may fall, causing serious injury to a child or adult, and serious damage to the product. Use only with a cart, stand, tripod, bracket, or table recommended by the manufacturer, or sold with the product. Any mounting of the product should follow the manufacturer's instructions, and should use a mounting accessory recommended by the manufacturer.
- A product and cart combination should be moved with care. Quick stops, excessive force, and uneven surfaces may cause the product and cart combination to overturn.
- 10. Ventilation** - Slots and openings in the cabinet are provided for ventilation and to ensure reliable operation of the product and to protect it from overheating, and these openings must not be blocked or covered. The openings should never be blocked by placing the product on a bed, sofa, rug, or other similar surface. This product should not be placed in a built-in installation such as a bookcase or rack unless proper ventilation is provided or the manufacturer's instructions have been adhered to.
- 11. Power Sources** - This product should be operated only from the type of power source indicated on the marking label. If you are not sure of the type of power supply to your home, consult your product dealer or local power company. For products intended to operate from battery power, or other sources, refer to the operating instructions.
- 12. Grounding or Polarization** - This product may be equipped with a polarized alternating-current line plug (a plug having one blade wider than the other). This plug will fit into the power outlet only one way. This is a safety feature. If you are unable to insert the plug fully into the outlet, try reversing the plug. If the plug should still fail to fit, contact your electrician to replae your obsolete outlet. Do not defeat the safety purpose of the polarized plug.
Alternate Warnings - This product is equipped with a three-wire grounding-type plug, a plug having a third(grounding) pin. This plug will only fit into a grounding-type power outlet. this is a safety feature. If you are unable to insert the plug into the outlet, contact your electrician to replace your obsolete outlet. Do not defeat the safety purpose of the grounding-type plug.
- 13. Power-Cord Protection** - Power-supply cords should be routed so that they are not likely to be walked on or pinched by items placed upon or against them, paying particular attention to cords at plugs, convenience receptacles, and the point where they exit from the product.
- 14. Outdoor Antenna Grounding** - If an outside antenna or cable system is connected to the product, be sure the antenna or cable system is grounded so as to provide some protection against voltage surges and built-up static charges. Article 810 of the National Electrical Code, ANSI/NFPA 70, provides information with regard to proper grounding of the mast and supporting structure, grounding of the lead-in wire to an antenna discharge unit, size of grounding conductors, location of antenna-discharge unit,



PORTABLE CART WARNING

connection to grounding electrodes, and requirements for the grounding electrode. See Figure 1.

Figure 1
Example of antenna grounding as per
National Electrical Code, ANSI/NFPA 70

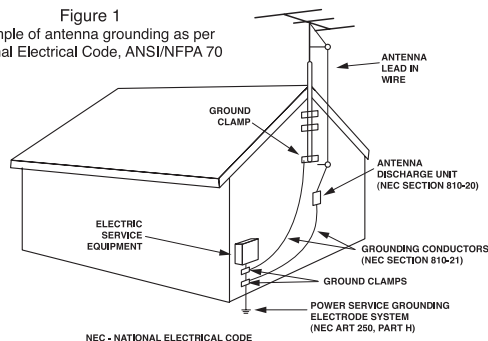



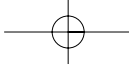

- 15. Lightning** - For added protection for this product during a lightning storm, or when it is left unattended and unused for long periods of time, unplug it from the wall outlet and disconnect the antenna or cable system. This will prevent damage to the product due to lightning and power-line surges.
- 16. Power Lines** - An outside antenna system should not be located in the vicinity of overhead power lines or other electric light or power circuits, or where it can fall into such power lines or circuits. When installing an outside antenna system, extreme care should be taken to keep from touching such power lines or circuits as contact with them might be fatal.
- 17. Overloading** - Do not overload wall outlets, extension cords, or integral convenience receptacles as this can result in a risk of fire or electric shock.
- 18. Object and Liquid Entry** - Never push objects of any kind into this product through openings as they may touch dangerous voltage points or short-out parts that could result in a fire or electric shock. Never spill liquid of any kind on the product.
- 19. Servicing** - Do not attempt to service this product yourself as opening or removing covers may expose you to dangerous voltage or other hazards. Refer all servicing to qualified service personnel.
- 20. Damage Requiring Service** - Unplug this product from the wall outlet and refer servicing to qualified service personnel under the following conditions:
 - When the power-supply cord or plug is damaged,
 - If liquid has been spilled, or objects have fallen into the product,
 - If the product has been exposed to rain or water,
 - If the product does not operate normally by following the operating instructions. Adjust only those controls that are covered by the operating instructions as an improper adjustment of other controls may result in damage and will often require extensive work by a qualified technician to restore the product to its normal operation.
 - If the product has been dropped or damaged in any way, and
 - When the product exhibits a distinct change in performance - this indicates a need for service.
- 21. Replacement Parts** - When replacement parts are required, be sure the service technician has used replacement parts specified by the manufacturer or have the same characteristics as the original part. Unauthorized substitutions may result in fire, electric shock, or other hazards.
- 22. Safety Check** - Upon completion of any service or repairs to this product, ask the service technician to perform safety checks to determine that the product is in proper operating condition.
- 23. Wall or Ceiling Mounting** - The product should be mounted to a wall or ceiling only as recommended by the manufacturer.
- 24. Heat** - The product should be situated away from heat sources such as radiators, heat registers, stoves, or other products (including amplifiers) that produce heat.



Introduction

READ THIS BEFORE OPERATING YOUR UNIT

  	 <p>This symbol is intended to alert the user to the presence of uninsulated "dangerous voltage" within the product's enclosure that may be of sufficient magnitude to constitute a risk of electric shock to persons.</p>
<p>CAUTION : TO REDUCE THE RISK OF ELECTRIC SHOCK, DO NOT REMOVE COVER (OR BACK). NO USER-SERVICEABLE PARTS INSIDE. REFER SERVICING TO QUALIFIED SERVICE PERSONNEL.</p>	 <p>This symbol is intended to alert the user to the presence of important operating and maintenance (servicing) instructions in the literature accompanying the appliance.</p>

WARNING : TO REDUCE THE RISK OF FIRE OR ELECTRIC SHOCK, DO NOT EXPOSE THIS APPLIANCE TO RAIN OR MOISTURE.

Caution regarding installation

Note : For heat dispersal, do not install this unit in a confined space such as a bookcase or similar enclosure.

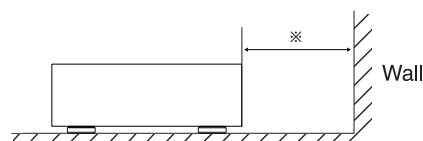
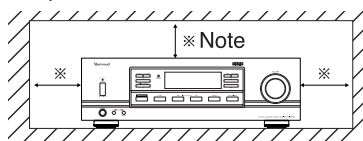

Do not block ventilation openings or stack other equipment on the top.

Note to CATV System Installer :

This reminder is provided to call the CATV system installer's attention to Article 820-40 of the NEC that provides guidelines for proper grounding and, in particular, specifies that the cable ground shall be connected to the grounding system of the building, as close to the point of cable entry as practical.

FCC INFORMATION

This equipment has been tested and found to comply with the limits for a Class B digital device, pursuant to Part 15 of the FCC Rules. These limits are designed to provide reasonable protection against harmful interference in a residential installation. This equipment generates, uses and can radiate radio frequency energy and, if not installed and used in accordance with the instructions, may cause harmful interference to radio communications. However, there is no guarantee that interference will not occur in a particular installation. If this equipment does cause harmful interference to radio or television reception, which can be determined by turning the equipment off and on, the user is encouraged to try to correct the interference by one or more of the following measures:

- Reorient or relocate the receiving antenna.
- Increase the separation between the equipment and receiver.
- Connect the equipment into an outlet on a circuit different from that to which the receiver is connected.
- Consult the dealer or an experienced radio/TV technician for help.

Caution : Any changes or modifications in construction of this device which are not expressly approved by the party responsible for compliance could void the user's authority to operate the equipment.

FOR YOUR SAFETY

<p>U.S.A CANADA</p>	<p>120 V</p>	<p>Units shipped to the U.S.A and CANADA are designed for operation on 120 V AC only. Safety precaution with use of a polarized AC plug. However, some products may be supplied with a nonpolarized plug.</p> <p>CAUTION : To prevent electric shock, match wide blade of plug to wide slot, fully insert.</p> <p>ATTENTION : Pour éviter chocs électriques, introduire la lame la plus large de la fiche dans la borne correspondante de la prise et pousser jusqu' au fond.</p>
--------------------------------	---------------------	-------------------------------------------------------------------------------------------------------------------------------------------------------------------------------------------------------------------------------------------------------------------------------------------------------------------------------------------------------------------------------------------------------------------------------------------------------------------------------------------------

CAUTION

- Leave a space around the unit for sufficient ventilation.
- Avoid installation in extremely hot or cold locations, or in an area that is exposed to direct sunlight or heating equipment.
- Keep the unit free from moisture, water, and dust.
- Do not let foreign objects in the unit.
- The ventilation should not be impeded by covering the ventilation openings with items, such as newspapers, table-cloths, curtains, etc.
- No naked flame sources, such as lighted candles, should be placed on the unit.
- Please be care the environmental aspects of battery disposal.
- The unit shall not be exposed to dripping or splashing for use.
- No objects filled with liquids, such as vases, shall be placed on the unit.
- Do not let insecticides, benzene, and thinner come in contact with the set.
- Never disassemble or modify the unit in any way.
 - Notes on the AC power cord and the wall outlet.
- The unit is not disconnected from the AC power source(mains) as long as it is connected to the wall outlet, even if the unit has been turned off.
- When disconnecting the power cord from the wall outlet, always pull the plug, not the power cord.
- Disconnect the plug from the wall outlet when not using the unit for long periods of time.
- The wall outlet shall be installed near the unit and shall be easily accessible.

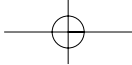

CONTENTS

SAFETY INSTRUCTIONS	2
Introduction	
• READ THIS BEFORE OPERATING YOUR UNIT	3
System Connections	5
Front Panel & Remote Controls	8
• REMOTE CONTROL OPERATION RANGE	10
• LOADING BATTERIES	10
Operations	
• LISTENING TO A PROGRAM SOURCE	11
• LISTENING TO RADIO BROADCASTS	15
• RECORDING	18
• OTHER FUNCTIONS	18
• ROOM2 PLAYBACK	19
Troubleshooting Guide	21
Specifications	22



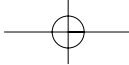

System Connections

- Do not plug the AC input cord into the wall AC outlet until all connections are completed.
- Be sure to connect the white RCA pin cords to the L (left) and the red RCA pin cords to the R (right) jacks when making audio connections.
- Make connections firmly and correctly. If not, it can cause loss of sound, noise or damage to the receiver.

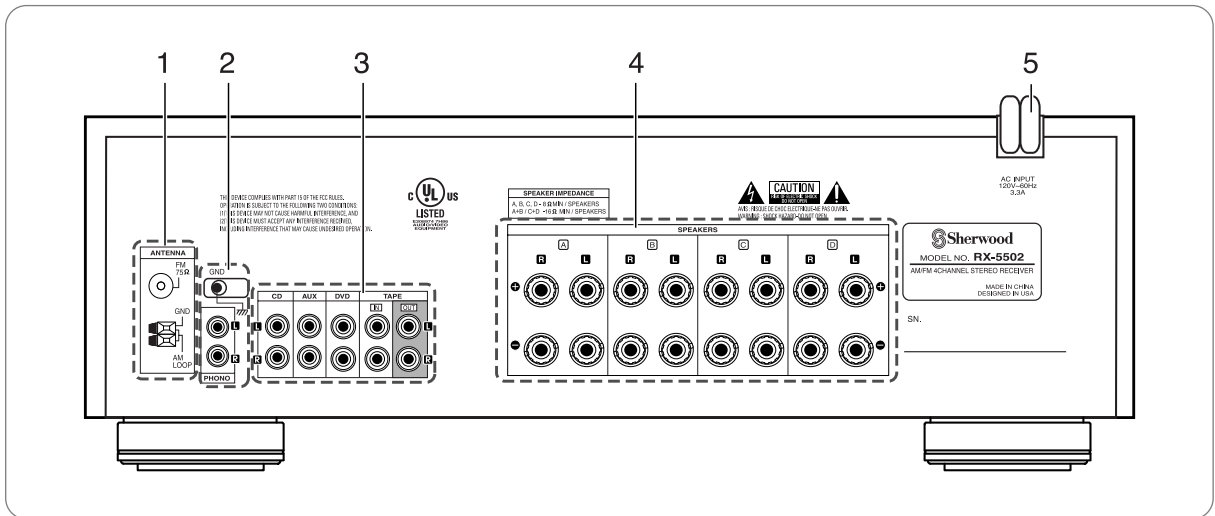

1. CONNECTING ANTENNAS

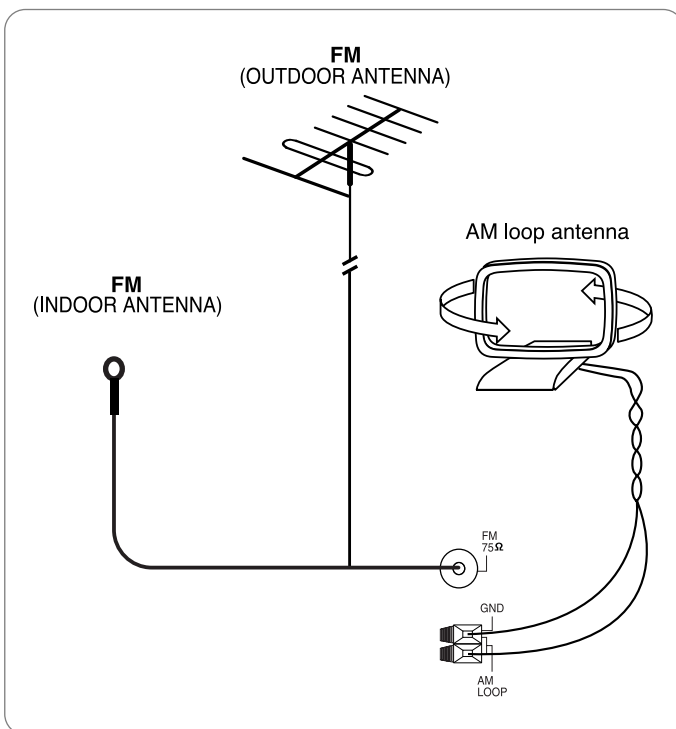

- Change the position of the FM indoor antenna until you get the best reception of your favorite FM stations.
- A 75Ω outdoor FM antenna may be used to further improve the reception. Disconnect the indoor antenna before replacing it with the outdoor one.
- Place the AM loop antenna as far as possible from the receiver, TV set, speaker cords and the AC input cord and set it to a direction for the best reception.
- If the reception is poor with the AM loop antenna, an AM outdoor antenna can be used in place of the AM loop antenna.

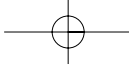

2. CONNECTING PHONO

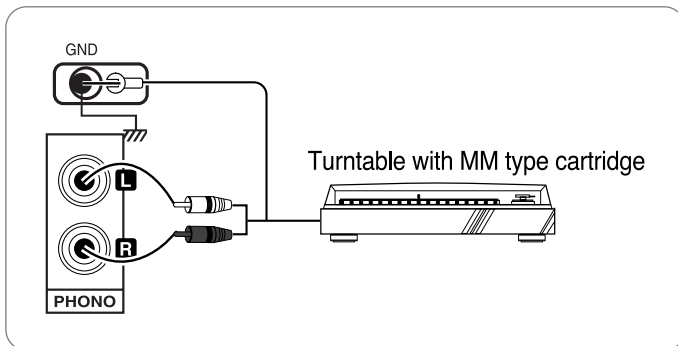

■ Note

- Do not connect the turntable with MC type cartridge directly. If so, use a separate head amplifier or step-up transformer.

3. CONNECTING AUDIO COMPONENTS

- The AUX jacks may also be connected to an additional component.
- The DVD jacks may be connected to AUDIO OUT jacks of video components such as DVD player, TV, etc.
- The TAPE IN/OUT jacks can be connected to audio recording equipment such as a tape deck, an MD recorder, etc.

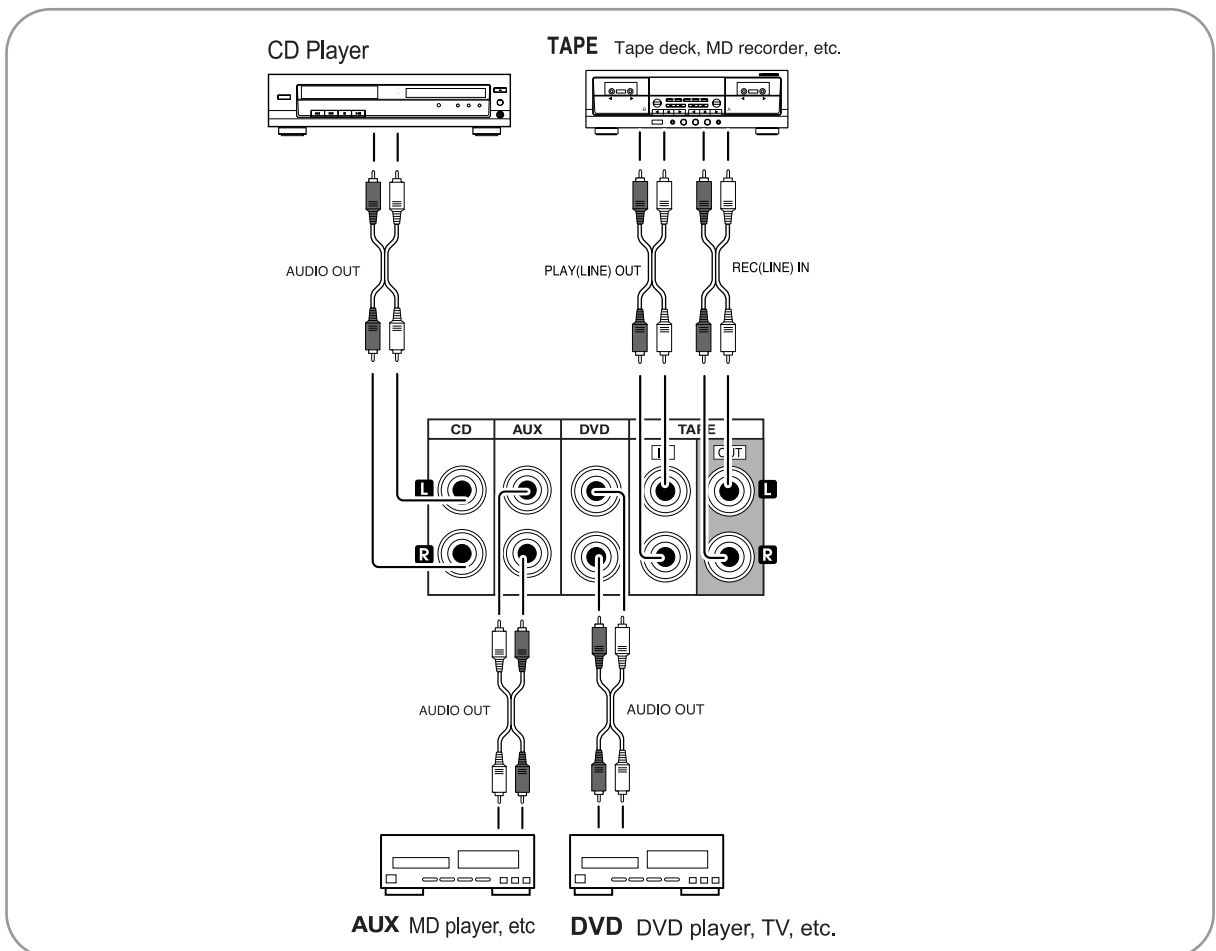

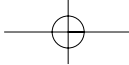

4. CONNECTING SPEAKERS

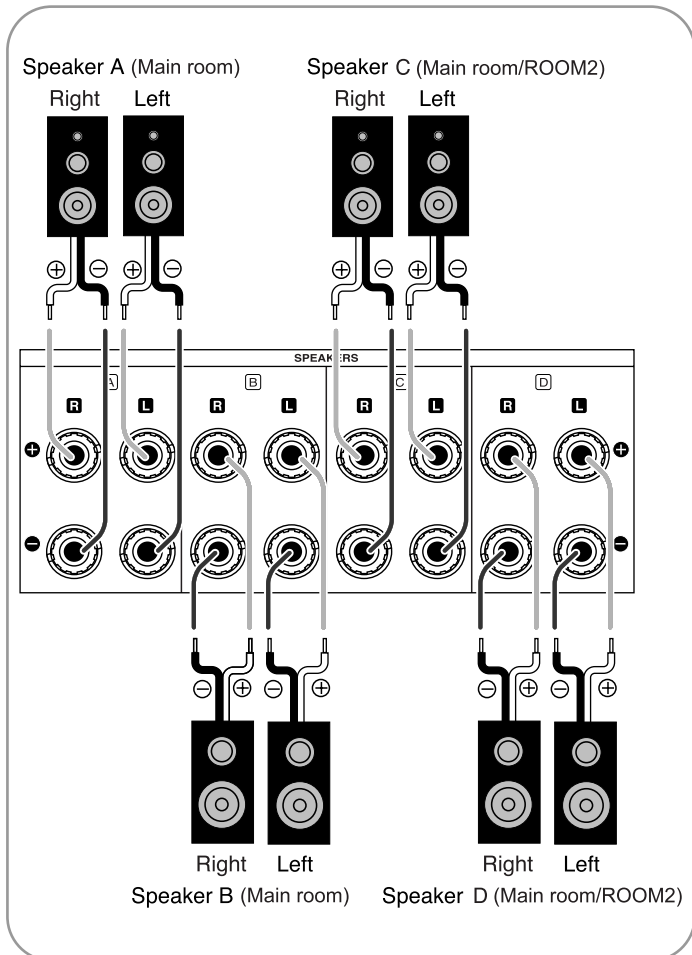

- You can connect up to four pairs of speakers to this receiver and select the various combinations of speakers according to your tastes.
- The speakers C and D can be installed in the main room as the speakers A and B can or in the another room (ROOM2) for ROOM2 playback. (For details, refer to "ROOM2 PLAYBACK" on page 19.)
- Be sure to connect speakers firmly and correctly according to the channel (left and right) and the polarity (+ and -).
- If the connections are faulty, no sound will be heard from the speakers, and if the polarity of the speaker connection is incorrect, the sound will be unnatural and lack bass.

■ Notes :

- For safe amplifier operation, use the speakers with impedance of over 8Ω when you connect a pair terminals of SPEAKER A and B terminals or/and a pair terminals of SPEAKER C and D terminals and use the speakers with impedance of over 16Ω when you connect both SPEAKER A and B terminals or/and both SPEAKER C and D terminals.
- Do not let the bare speaker wires touch each other or any metal part of this receiver. This could damage this receiver and/or the speakers.

5. AC INPUT CORD

- Plug the cord into an wall AC outlet.

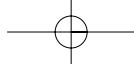

Front Panel & Remote Controls

FRONT PANEL

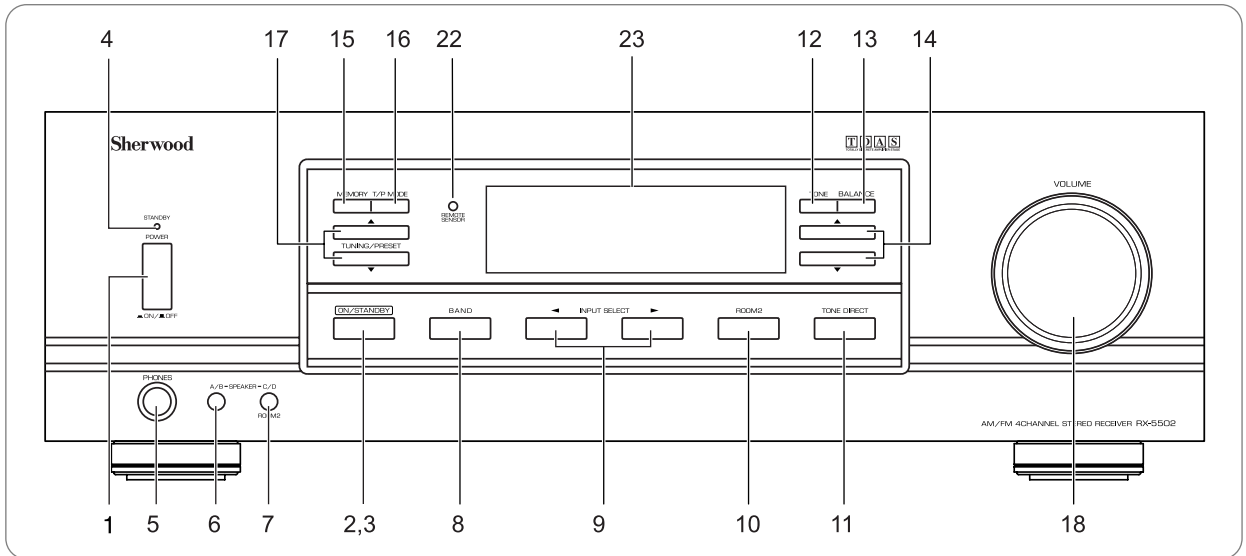

REMOTE CONTROLS

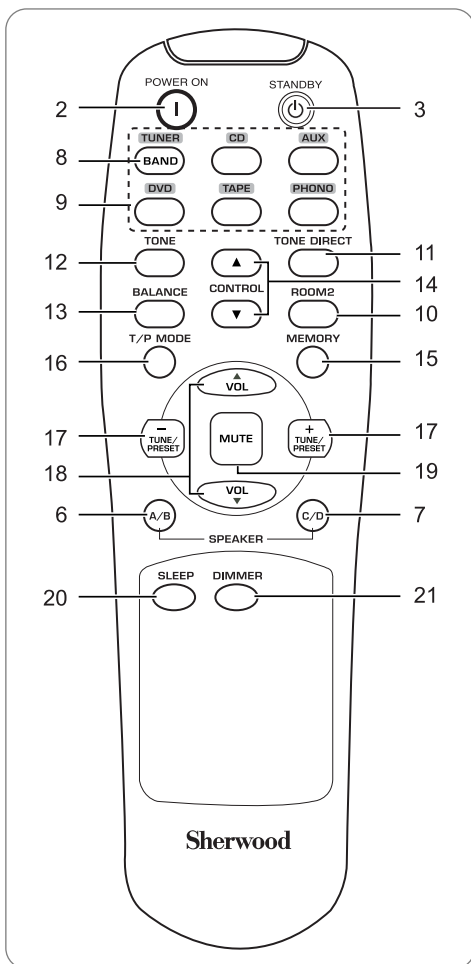

FLUORESCENT DISPLAY

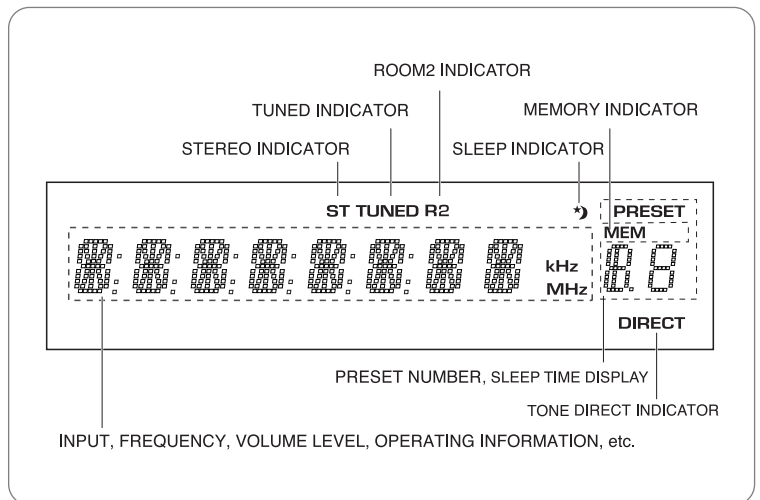

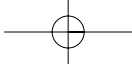

1. POWER SWITCH

Push this switch to enter the standby mode.
To switch the power off, push again this switch.

2. POWER ON BUTTON

In the standby mode, when this button is pressed, the unit is turned on to enter the operating mode.

3. STANDBY BUTTON

In the operating mode, when this button is pressed, the unit is turned off to enter the standby mode.

4. STANDBY INDICATOR

5. HEADPHONE JACK

Stereo headphones with a standard 1/4 inch plug can be plugged into this jack for private listening.

6. SPEAKER A/B SELECTOR BUTTON

Each time this button is pressed, the speakers are switched on or off as follows :

→ A/B ~ → ~ - / - ~ → A / - ~ → ~ - / B ~
or (MAIN A/B) or (MAIN - / -) or (MAIN A / -) or (MAIN - / B)

() : When the ROOM2 mode is set to on.

7. SPEAKER C/D SELECTOR BUTTON

Each time this button is pressed, the speakers are switched on or off as follows :

→ ~ C/D → ~ - / - → ~ C / - → ~ - / D
or (R2 C/D) or (R2 - / -) or (R2 C / -) or (R2 - / D)

() : When the ROOM2 mode is set to on.

8. BAND (TUNER) BUTTON

Each time the BAND (TUNER) button is pressed, the band changes as follows:

→ FM ST → FM MONO → AM

9. INPUT SELECTOR BUTTONS

Press the button to select the desired input source.

10. ROOM2 BUTTON

Press this button to enter the ROOM2 mode.

11. TONE DIRECT BUTTON

Press this button to listen to a program source without the tone effect.

12. TONE BUTTON

When adjusting the tone (bass and treble), press this button to select the desired tone mode.

- Each time this button is pressed, the tone mode is changed to bass or treble.

13. BALANCE BUTTON

When adjusting the sound volume balance, press this button to enter the balance mode.

14. BALANCE, TREBLE/BASS UP/DOWN (▲/▼) BUTTONS

At the balance mode, adjust the sound volume balance between left and right speakers with these buttons.

At the desired tone mode, adjust the tone as desired with these buttons.

15. MEMORY BUTTON

Press this button to store preset stations.

16. T/P (TUNING/PRESET) MODE BUTTON

Press this button to select the tuning mode or the preset mode.

17. TUNING/PRESET UP/DOWN (▲,+/▼,-) BUTTONS

Press these buttons to tune in the desired stations.

18. VOLUME CONTROL KNOB, UP/DOWN (▲/▼) BUTTONS

Adjust the volume to a comfortable listening level with this knob or these buttons.

19. MUTE BUTTON

Press this button to temporarily mute the sound.
Press it again to resume the previous sound level.

20. SLEEP BUTTON

Press this button to activate the sleep timer for a specified period of time.

- Each time this button is pressed, the sleep time changes as follows:

→ 10 → 20 → 30 → . . . → 90 → OFF
Unit : minutes

21. DIMMER BUTTON

Press this button to select the brightness of the fluorescent display as desired.

- Each time this button is pressed, the brightness of the fluorescent display changes as follows:

→ ON → dimmer → OFF

22. REMOTE SENSOR

This receives the signals from the remote control unit.

23. FLUORESCENT DISPLAY

For details, see the previous page.

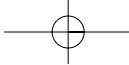

REMOTE CONTROL OPERATION RANGE

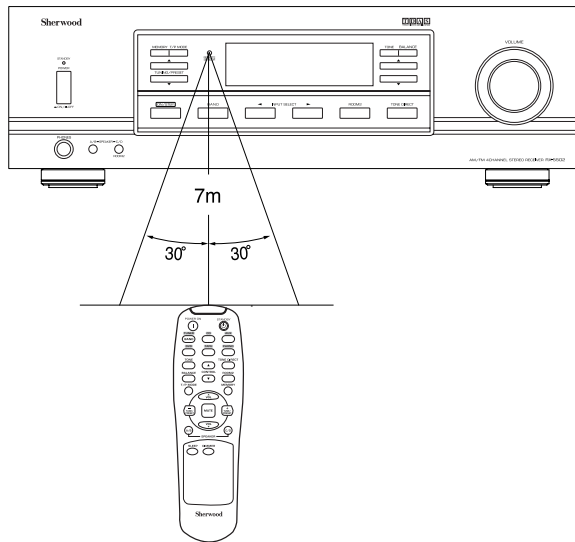

- Use the remote control unit within a range of about 7 meters (23 feet) and angles of up to 30 degrees aiming at the remote sensor.

LOADING BATTERIES

1. Remove the cover.

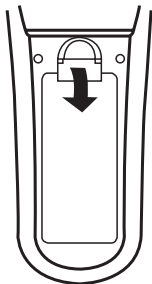

2. Load two batteries matching the polarity.

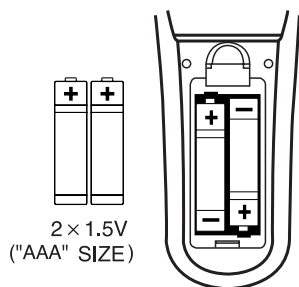

- Remove the batteries when they are not used for a long time.
- Do not use the rechargeable batteries(Ni-Cd type).

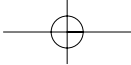

Operations

LISTENING TO A PROGRAM SOURCE

Before operation

- Push the POWER switch.



- This unit enters the standby mode and the STANDBY indicator lights up. This means that the receiver is not disconnected from the AC mains and a small amount of current is retained to support the operation readiness.
- To switch the power off, push the POWER switch again. Then the power is cut off and the STANDBY indicator turns off.

1. In the standby mode, turn the power on.

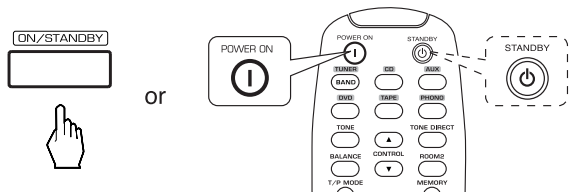

- Each time the ON/STANDBY button on the front panel, the receiver is turned on to enter the operating mode or off to enter the standby mode.
- On the remote control, press the POWER ON button to enter the operating mode or press the STANDBY button to enter the standby mode.

2. Switch the desired speakers on.

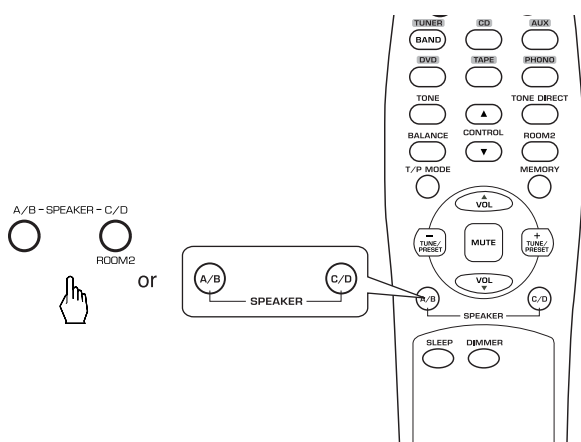

- You can select the various combinations of speakers depending on where the speakers C or/and D are installed.
- Each time the SPEAKER A/B SELECTOR button is pressed, the speakers are switched on or off as follows :

→ A/B ~ → - / - ~ → A/ - ~ → - /B ~
or (MAIN A/B) or (MAIN -/-) or (MAIN A/-) or (MAIN -/B)

() : When the ROOM2 mode is set to on.

- Each time the SPEAKER C/D SELECTOR button is pressed, the speakers are switched on or off as follows :

→ ~ C/D → ~ - / - → ~ C/ - → ~ - /D
or (R2 C/D) or (R2 -/-) or (R2 C/-) or (R2 -/D)

() : When the ROOM2 mode is set to on.

- When using the headphones for private listening, switch off all the speakers installed in the main room.

■ Note :

- To use ROOM2 function, you should install speakers C or/and D in another room (ROOM2) and set the ROOM2 mode to on. (For details, refer to "CONNECTING SPEAKERS" on page 7 and "ROOM2 PLAYBACK" on page 19.)

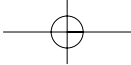

3. Select the desired input source.

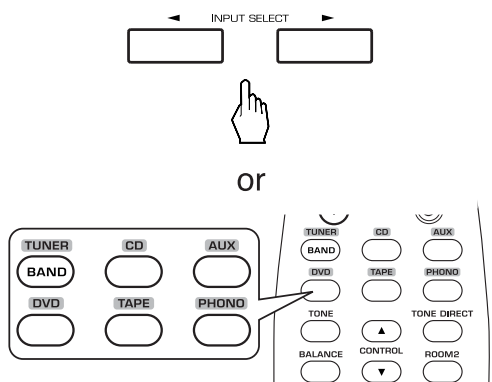

- Each time the "INPUT SELECT ◀/▶" buttons are pressed, the input source is changed as follows :

→TUNER ↔ CD ↔ AUX ↔ DVD ↔ TAPE ↔ PHONO ↔ (Frequency display)

4. Operate the selected component for playback.

5. Adjust the volume to a comfortable listening level.

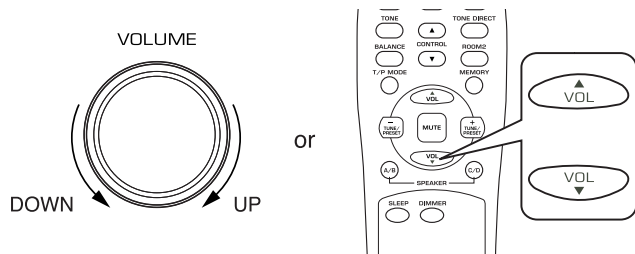

6. To mute the sound.

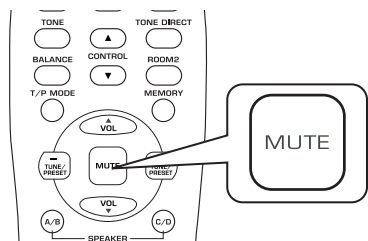

- "MUTE" flickers.
- To resume the previous sound level, press this button again.
- When adjusting the volume, the mutting effect is turned off.

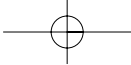

7. To listen with the headphones.

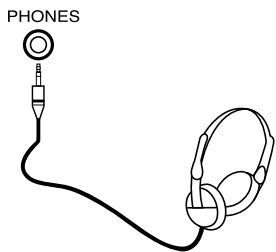

- Be sure to switch off all the speakers installed in the main room.

Adjusting the tone (bass and treble)

8. Enter the tone mode.

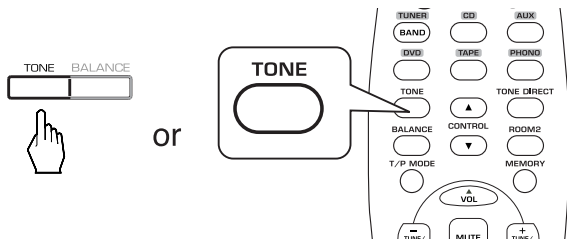

- Each time this button is pressed, the corresponding tone mode is selected and shown for 5 seconds as follows:

→ BASS → TRBL →

- Note:
- When the tone direct function is activated, the tone mode cannot be entered and "TON DIR" flickers for 3 seconds.

9. At the desired tone mode, adjust the tone as desired.

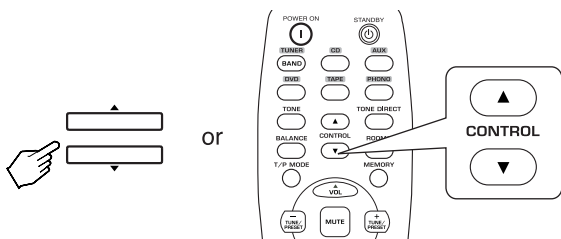

- If the tone display disappears, start from the step 8 again.
- The tone (BASS and TRBL) can be adjusted within the range of -10 ~ +10 dB.

- Notes:
- Extreme settings at high volume may damage your speakers.
- In general, the bass and treble levels are adjusted to 0.

10. To listen to a program source without the tone effect.

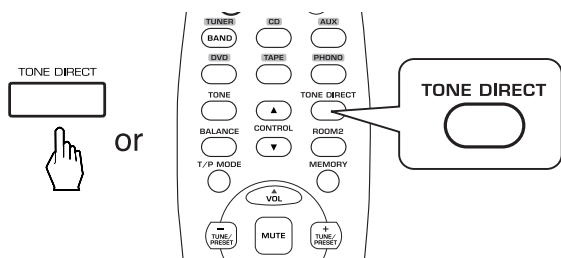

- "TON DIR" is displayed, "DIRECT" lights up and the sound that bypasses the tone circuitry will be heard.
- To cancel the tone direct function, press this button again to display "TON CTRL", and then "DIRECT" turns off.

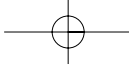

Adjusting the sound volume balance

11. Enter the balance mode.

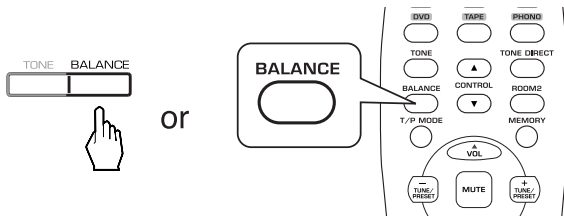

- "BAL" and the balance level are displayed for 5 seconds.

12. Adjust the sound volume balance between the left and right speakers.

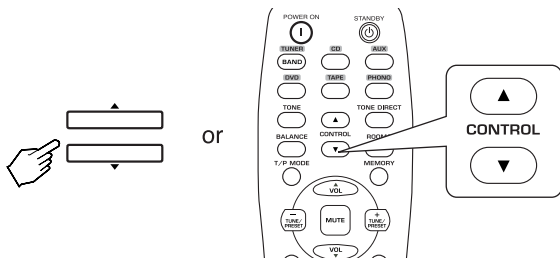

- If the balance display disappears, start from the step 11 again.
- The balance level can be adjusted within the range of L10 ~ R 10.
- Note:
- In general, the balance level is adjusted to 0.



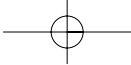

LISTENING TO RADIO BROADCASTS

Auto tuning

1. Select the tuner and then the desired band.

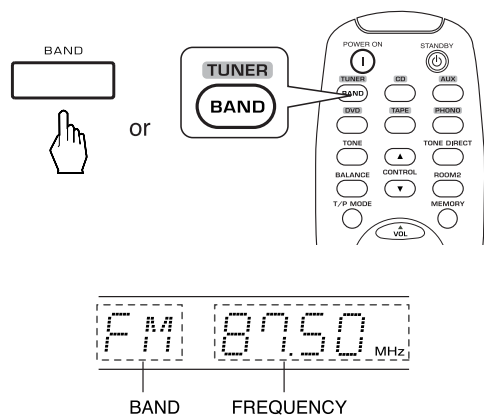

- Each time this button is pressed, the tuner is automatically selected and the band is changed as follows :

→ FM ST → FM MONO → AM →

- When the FM stereo broadcast is tuned, the FM mode changes as follows:

→ Stereo mode : "ST" lights up. ←
 → Mono mode : "ST" turns off. ←

- When FM stereo broadcasts are poor because of weak broadcast signals, select the FM mono mode ("ST" turns off) to reduce the noise, then FM broadcasts are reproduced in monaural sound.

2. Select the tuning mode.

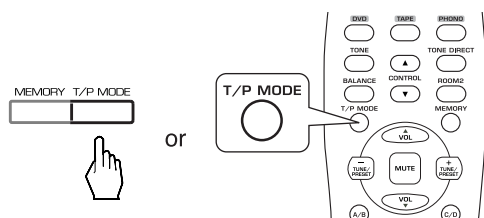

- Each time this button is pressed, the mode changes as follows:

→ Tuning mode : "PRESET" turns off. ←
 → Preset mode : "PRESET" lights up. ←

3. Press the TUNING/PRESET UP (▲/+) or DOWN (▼/-) button for more than 0.5 second.

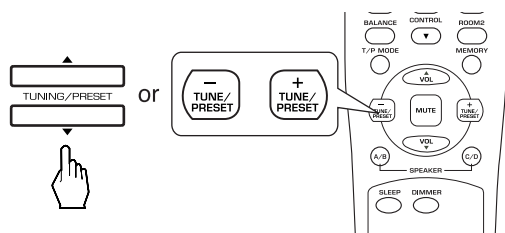

- The tuner will now search until a station of sufficient strength has been found. The display shows the tuned frequency and "TUNED".
- If the station found is not the desired one, simply repeat this operation.
- Weak stations are skipped during auto tuning.

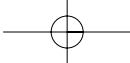

Manual tuning

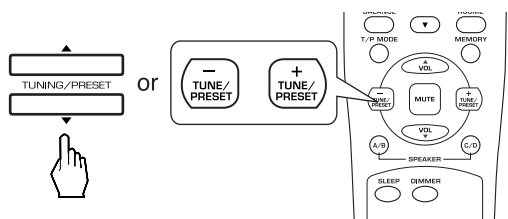

- Manual tuning is useful when you already know the frequency of the desired station.
- Perform the steps 1 and 2 in "Auto tuning" procedure on page 15 and press the TUNING/PRESET UP (▲ / +) or DOWN (▼ / -) button repeatedly until the right frequency has been reached.

Auto presetting

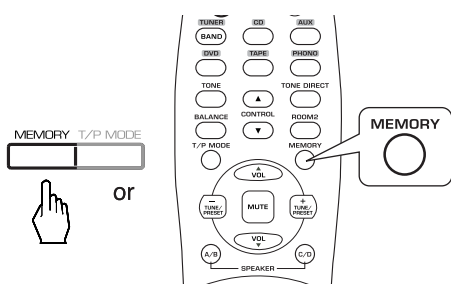

- Auto presetting function automatically searches for FM stations only and store them in the memory.
- While listening to radio broadcasts, press and hold down the MEMORY button for more than 2 seconds.
- Then "AUTO MEM" is displayed and this receiver starts auto presetting.
- Up to 30 FM stations can be stored.

■ Notes:

- FM stations of weak strength cannot be memorized.
- To memorize AM stations or weak stations, perform "Manual presetting" procedure with using "Manual tuning" operation.

Manual presetting

- You can store up to 30 preferred stations in the memory.

1. Tune in the desired station with auto or manual tuning.

2. Press the MEMORY button.

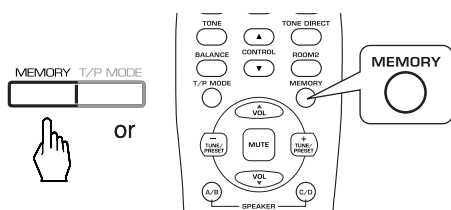

- "MEM" is flickering for 5 seconds.

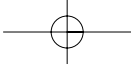

3. Press the TUNING/PRESET UP ($\blacktriangle/+$) or DOWN ($\blacktriangledown/-$) button to select the desired preset number and press the MEMORY button.

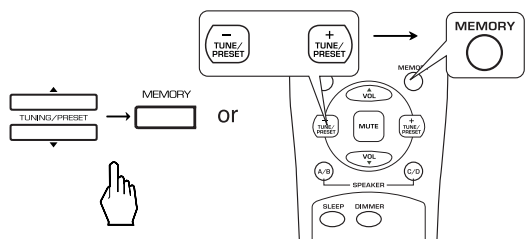

- The station has now been stored in the memory.
- A stored frequency is erased from the memory by storing another frequency in its place.
- If "MEM" turns off, start again from the above step 2.

4. Repeat the above steps 1 to 3 to memorize other stations.

■ MEMORY BACKUP FUNCTION

The following items, set before the receiver is turned off, are memorized.

- INPUT SELECTOR settings
- Preset stations, etc.
- The ROOM2 settings.

Tuning to preset stations

1. After selecting the tuner as an input source, select the preset mode.

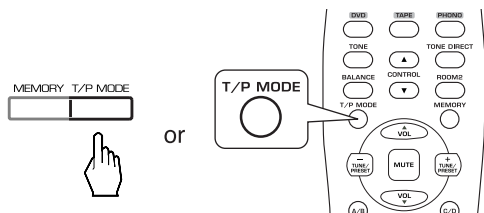

- Then "PRESET" lights up.

2. Select the desired preset number.

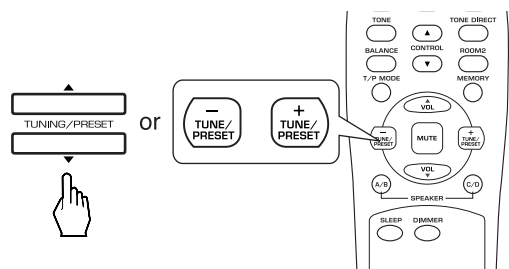

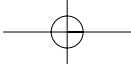

RECORDING

- The volume, tone(bass, treble) and balance settings have no effect on the recording signals.
- When you select tuner, CD, DVD, AUX or PHONO as a recording source, recording can be made on the TAPE.
- The ROOM2 input source cannot be recorded onto the TAPE.

Recording with TAPE

1. Select the desired input as a recording source except for TAPE.

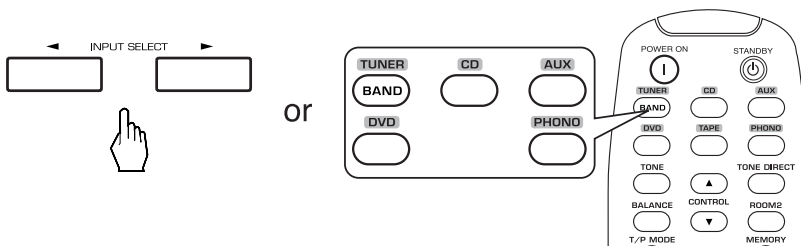

2. Start recording on the TAPE.

3. Start play on the desired input.

OTHER FUNCTIONS

Operating the sleep timer

- The sleep timer allows the system to continue to operate for a specified period of time before automatically shutting off.
- Each time this button is pressed, the sleep time changes as follows:

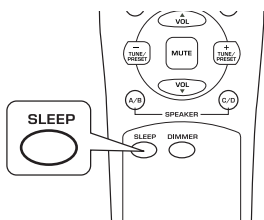

→ 10 → 20 → 30 → . . . → 90 → OFF
Unit : minutes

- While operating the sleep timer, " ★ " lights up.
- When the sleep time is selected, the fluorescent display is dimly lit.
- When the ROOM2 function is operating, it will not be turned off by the sleep timer.

Adjusting the brightness of the fluorescent display

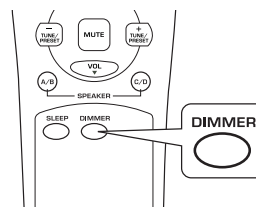

- Each time this button is pressed, the brightness of the fluorescent display changes as follows:

→ ON → dimmer → OFF

- In the display OFF mode, pressing any button will restore the display ON mode.

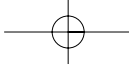

ROOM2 PLAYBACK

- This function allows enjoying one source in the main room and playing another in a different room at the same time.
- Even when this receiver enters the standby mode, in such a case that "R2" is dimly lit, meaning only the ROOM2 circuitry operates, the ROOM2 source can be played independently. Therefore, when you do not use the ROOM2 function, turn off the ROOM2 function to save electricity.
- To enjoy ROOM2 source, turn on the ROOM2 function and adjust the ROOM2 settings as below.

1. Enter the ROOM2 mode.

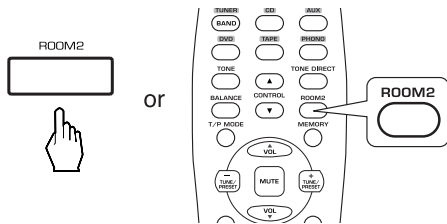

- "R2 > ~" is displayed for several seconds.
- Each time this button is pressed, the mode is changed to the ROOM2 mode ("R2 > ~") or the main mode (main input display).
- When "R2 > ~" is not displayed, press this button again.
 - Note :
 - Only while displaying the ROOM2 mode, you can set the ROOM2 mode.

2. Turn on the ROOM2 mode.

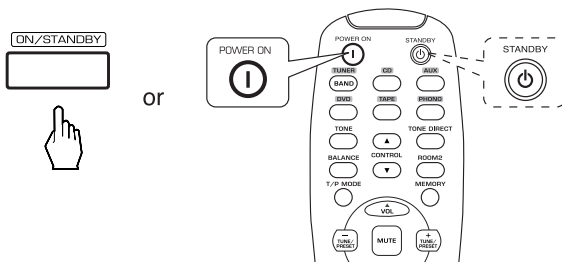

- Each time the "ON/STANDBY" button on the front panel is pressed, the ROOM2 mode changes as follows :
 - R2 > OFF : ROOM2 off mode ("R2" turns off)
 - ↕
 - R2 > input display : ROOM2 on mode ("R2" lights up)
- On the remote control, press the POWER ON button to turn on the ROOM2 mode or press the STANDBY button to turn it off.
 - Note :
 - Only while displaying the ROOM2 on mode, you can adjust the ROOM2 settings.

3. Select the desired ROOM2 speakers.

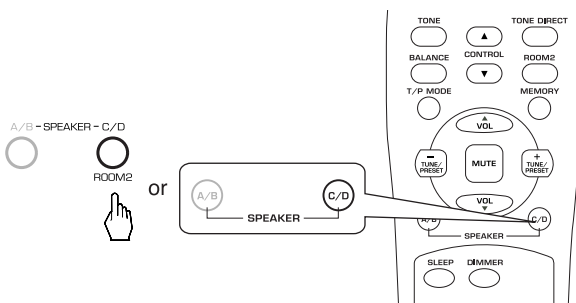

- Each time the SPEAKER C/D SELECTOR button is pressed, the speakers are switched on or off as follows:
 - R2 C/D → R2 - / - → R2 C/ - → R2 - /D
- Note :
 - Only when the ROOM2 mode is set to on, the speakers C or/and D can be used as ROOM2 speakers.

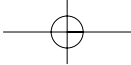

4. Select the desired ROOM2 input.

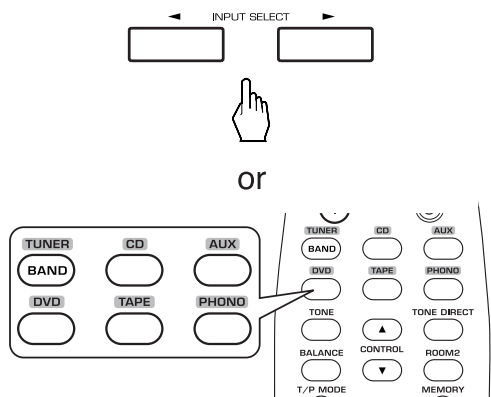

- Each time the "INPUT SELECT ◀/▶" buttons are pressed, the ROOM2 input source is changed as follows :

→TUNER ↔ CD ↔ AUX ↔ DVD ↔ TAPE ↔ PHONO ←

5. Start play on the component related to the ROOM2 source.

6. Adjust the ROOM2 volume to a comfortable listening level.

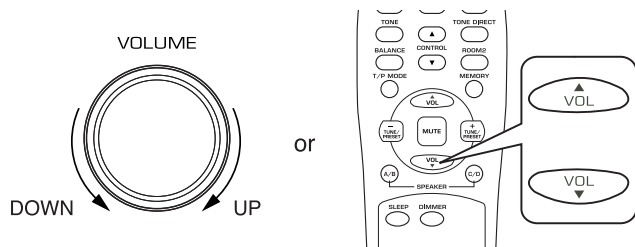

7. To mute the sound.

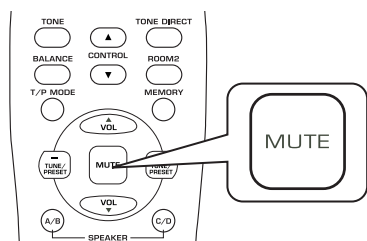

- While the mute function for ROOM2 is operating, "R2" is flickering.
- To resume the previous sound level, press this button again.

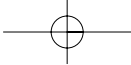

Troubleshooting Guide

If a fault occurs, run through the table below before taking your receiver for repair.

If the fault persists, attempt to solve it by switching the receiver off and on again. If this fails to resolve the situation, consult with your dealer. Under no circumstances should you repair the receiver yourself as this could invalidate the warranty.

PROBLEM	POSSIBLE CAUSE	REMEDY
No power	<ul style="list-style-type: none"> • The AC input cord is disconnected. • Poor connection at AC wall outlet or the outlet is inactive. 	<ul style="list-style-type: none"> • Connect the cord securely. • Check the outlet using a lamp or another appliance.
No sound	<ul style="list-style-type: none"> • The speaker cords are disconnected. • The volume is adjusted too low. • The MUTE button on the remote control is pressed to ON. • Speakers are not switched on. • Incorrect selection of the input source. • Incorrect connections between the components. 	<ul style="list-style-type: none"> • Check the speaker connections. • Adjust the volume. • Press the MUTE button to cancel the muting effect. • Switch on the desired speakers. • Select the desired input source correctly. • Make connections correctly.
Stations cannot be received	<ul style="list-style-type: none"> • No antenna is connected. • The desired station frequency is not tuned in. • The antenna is in wrong position. 	<ul style="list-style-type: none"> • Connect an antenna. • Tune in the desired station frequency. • Move the antenna and retry tuning.
Preset stations cannot be received	<ul style="list-style-type: none"> • An incorrect station frequency has been memorized. • The memorized stations are cleared. 	<ul style="list-style-type: none"> • Memorize the correct station frequency. • Memorize the stations again.
Poor FM reception	<ul style="list-style-type: none"> • No antenna is connected. • The antenna is not positioned for the best reception. 	<ul style="list-style-type: none"> • Connect an antenna. • Change the position of the antenna.
Continuous hissing noise during FM reception, especially when a stereo broadcast is received.	<ul style="list-style-type: none"> • Weak signals. 	<ul style="list-style-type: none"> • Change the position of the antenna. • Install an outdoor antenna.
Continuous or intermittent hissing noise during AM reception, especially at night.	<ul style="list-style-type: none"> • Noise is caused by motors, fluorescent lamps or lightning, etc. 	<ul style="list-style-type: none"> • Keep the receiver away from noise sources. • Install an outdoor AM antenna.
No recording	<ul style="list-style-type: none"> • Incorrect selection between the components. • Incorrect operation of each component for playback and recording. 	<ul style="list-style-type: none"> • Make connections correctly. • Operate each component correctly.
Remote control unit does not operate.	<ul style="list-style-type: none"> • Batteries are not loaded or exhausted. • The remote sensor is obstructed. 	<ul style="list-style-type: none"> • Replace the batteries. • Remove the obstacle.

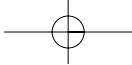

Specifications

■ AMPLIFIER SECTION

- Power output, 8Ω, THD 0.7 %, 20 Hz~20 kHz, only a pair of speakers driven 2 X 100 W
- Total harmonic distortion, 8Ω, @ -3dB, 20 Hz~20 kHz 0.05 %
- Intermodulation distortion
60 Hz : 7 kHz= 4 : 1 SMPTE, 8Ω, 100 W 0.03 %
- Input sensitivity, 47 kΩ
Phono(MM) 2.5 mV
Line(CD,DVD,TAPE,AUX) 220 mV
- Signal to noise ratio, IHF "A" weighted
Phono(MM) 75 dB
Line(CD,DVD,TAPE,AUX) 98 dB
- Frequency response
Phono(MM), RIAA, 20 Hz~20 kHz ±0.3 dB
Line(CD,DVD,TAPE,AUX), 10 Hz~100 kHz ±3 dB
- Output level
TAPE OUT, 2.2 kΩ 200 mV
- Bass/Treble control, 100 Hz/10 kHz ±10 dB

■ FM TUNER SECTION

- Tuning frequency range 87.5~108 MHz
- Usable sensitivity, THD 3%, S/N 30 dB 15 dBf
- 50 dB quieting sensitivity, mono/stereo 25.2/45.2 dBf
- Signal to noise ratio, 65 dBf, mono/stereo 68/65 dB
- Total harmonic distortion, 65 dBf, 1 kHz, mono/stereo 0.5/0.8%
- Frequency response, 20 Hz~14 kHz ±3 dB
- Stereo separation, 1 kHz 30 dB
- Capture ratio 4 dB
- IF rejection ratio 75 dB

■ AM TUNER SECTION

- Tuning frequency range 520~1710 kHz
- Usable sensitivity, S/N 20 dB 55 dBμ/m
- Signal to noise ratio 50 dB
- Selectivity 30 dB

■ GENERAL

- Power supply 120 V~ 60 Hz
- Power consumption 3.3 A
- Dimensions (W × H × D, including protruding parts) 440 × 141 × 368mm(17-3/8 × 5-9/16 × 14-1/2 inches)
- Weight (Net) 8.85 kg(19.5 lbs)

Note: Design and specifications are subject to change without notice for improvements.

Free Manuals Download Website

<http://myh66.com>

<http://usermanuals.us>

<http://www.somanuals.com>

<http://www.4manuals.cc>

<http://www.manual-lib.com>

<http://www.404manual.com>

<http://www.luxmanual.com>

<http://aubethermostatmanual.com>

Golf course search by state

<http://golfingnear.com>

Email search by domain

<http://emailbydomain.com>

Auto manuals search

<http://auto.somanuals.com>

TV manuals search

<http://tv.somanuals.com>