

SHINDAIWA OWNER'S/OPERATOR'S MANUAL

MULTIPURPOSE TILLER/ CULTIVATOR TOOL

Model: 80265

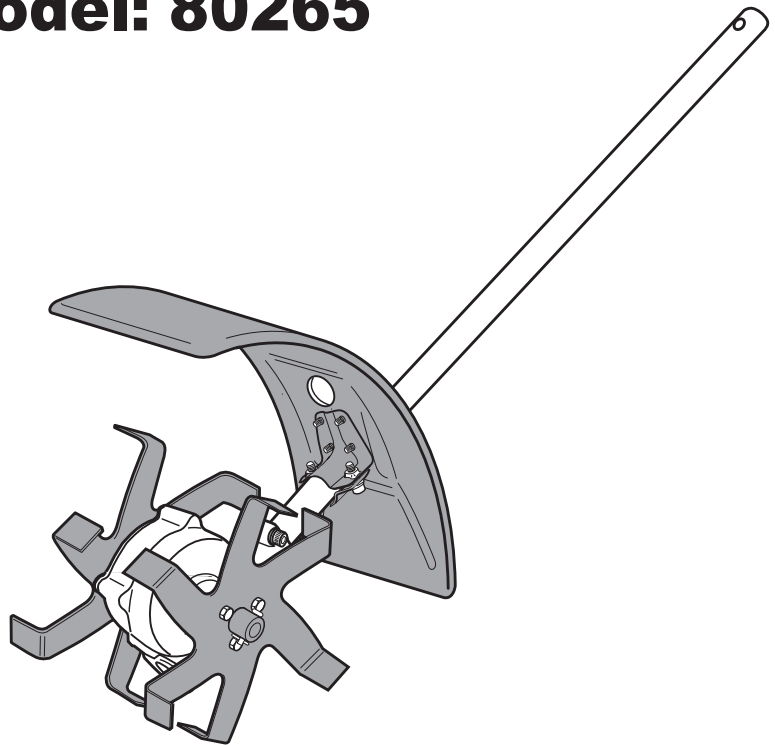

WARNING!

Minimize the risk of injury to yourself and others! Read this manual and familiarize yourself with the contents. Always wear eye and hearing protection when operating this unit.

Introduction

The Shindaiwa Multipurpose Tiller/Cultivator Tool is designed and built to deliver superior performance and reliability without compromise to quality, comfort, safety or durability. As an owner/operator, you'll soon discover for yourself why Shindaiwa is simply in a class by itself!

IMPORTANT!

The information contained in these instructions describes units available at the time of publication.

Echo Inc. reserves the right to make changes to products without prior notice, and without obligation to make alterations to units previously manufactured.

Contents

	PAGE		PAGE
<i>General Safety Instructions</i>	3	<i>Assembly</i>	6
<i>Safety Labels</i>	3	<i>Operating</i>	8
<i>Operating Precautions</i>	4	<i>Maintenance</i>	9
<i>Product Description</i>	5	<i>Troubleshooting Guide</i>	10
<i>Specifications</i>	5	<i>Warranty Statements</i>	11

IMPORTANT!

The procedures described in this manual are intended to help you get the most from your unit as well as to protect you and others from harm. These procedures are guidelines for safe operation under most conditions, and are not intended to replace any safety rules and/or laws that may be in force in your area. If you have questions regarding your power tool, or if you do not understand something in this manual, contact Shindaiwa at the address printed on the back of this Manual.

Attention Statements

Throughout this manual are special "attention statements".



WARNING! A statement preceded by the triangular attention symbol and the word "WARNING" contains information that should be acted upon to prevent serious bodily injury.

CAUTION! A statement preceded by the word "CAUTION" contains information that should be acted upon to prevent mechanical damage.

IMPORTANT!

A statement preceded by the word "IMPORTANT" is one that possesses special significance.

NOTE:

A statement preceded by the word "NOTE" contains information that is handy to know and may make your job easier.

Safety and Operation Information Labels



Read and follow this manual, make sure anyone using the unit does likewise. Failure to do so could result in serious personal injury or machine failure. Keep this manual for future reference.



Always wear a hard hat to reduce the risk of head injuries during operation of this machine. In addition, always wear eye and hearing protection. Shindaiwa recommends wearing a face shield as additional face and eye protection.



Beware of thrown objects. Keep bystanders at least 15 M (50 feet) away during operation.



Never operate this tool or any other power equipment if you are tired, ill, or under the influence of alcohol, drugs, or any substance that could affect your ability or judgement.

General Safety Instructions

Work Safely

This machine operates at very high speeds and has the potential to do serious damage if misused, abused or mishandled. To reduce the risk of injury, you must maintain control at all times, and observe all safety precautions during operation. Never permit a person without training or instruction to operate this machine!

 **WARNING!**
Never make unauthorized attachment installations.

 **WARNING!**
Never operate power equipment of any kind if you are tired or if you are under the influence of alcohol, drugs, medication or any other substance that could affect your ability or judgement.

Stay Alert

You must be physically and mentally fit to operate this unit safely.

Be Aware of the Working Environment

- Be careful when operating on a slope or on slippery terrain, especially during rainy weather.
- Never operate this machine around buried electrical cables!
- **Do not** operate the tiller/cultivator in standing water.
- If the tines jam, switch the engine OFF, disconnect the spark plug lead, and inspect the tines, axles and gearcase for damage.
- Never operate the tiller/cultivator around vines or roots that could tangle in the tines and cause loss of control.
- Maintain a shallow working angle and avoid steep angles of operation. A steep working angle risks loss of control of the machine.
- Transport the machine with the engine OFF.

 **WARNING!**
Minimize the Risk of Fire

- STOP engine before refueling.
- ALWAYS allow the engine to cool before refueling!
- Wipe all spilled fuel and move the engine at least 10 feet (3 meters) from the fueling point and source before restarting!
- NEVER start or operate this unit if there is a fuel leak.
- NEVER start or operate this unit if the carburetor, fuel lines, fuel tank and/or fuel tank cap are damaged.
- NEVER smoke or light any fires near the engine or fuel source!
- NEVER place any flammable material near the engine muffler!
- NEVER operate the engine without the muffler and spark arrester in good working condition.

Safety Labels

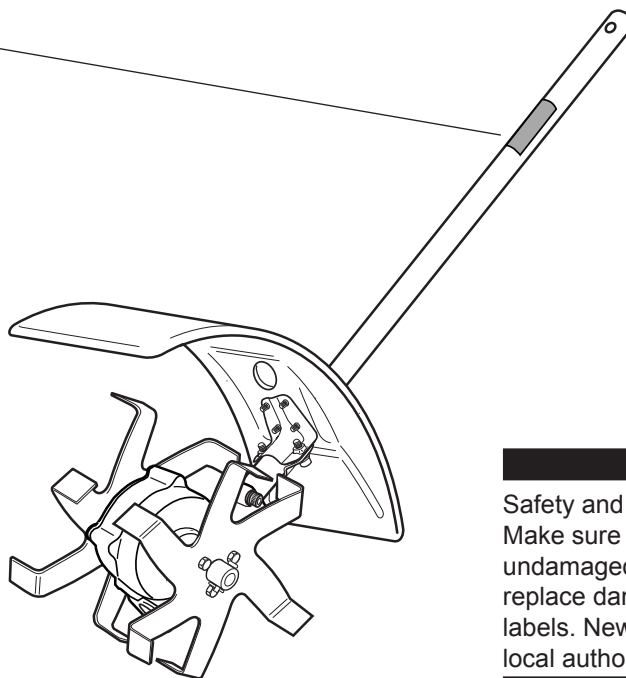

IMPORTANT!

Safety and Operation Information Labels: Make sure all information labels are undamaged and readable. Immediately replace damaged or missing information labels. New labels are available from your local authorized Shindaiwa dealer.

The Properly Equipped Operator



Operating Precautions



WARNING! Use Good Judgement

- This Shindaiwa Cultivator Tool is specifically designed for use on the Shindaiwa Multipurpose Tool Carrier. Installation and/or use on any other model, brand or type of power tool is not approved by Shindaiwa. Attempts to use on non-approved models can damage the equipment and cause accidents, serious injury or death.
- Cultivator tine belts may move when starting engine. Place the multipurpose tool on a smooth level surface when starting.
- Always make sure the cultivator attachment is properly installed and firmly tightened before operation.
- Make sure there are no missing or loose fasteners, and that the ignition switch and throttle controls are working properly.
- Do not operate the unit with the muffler removed.
- Operate this unit only in a well ventilated area. Be aware of carbon monoxide poisoning. Exhaust gases and lubrication oil mist can cause serious injury or death.
- Always hold the machine firmly with both hands when tilling, and maintain control at all times.
- Always stop the engine immediately and check for damage if you strike a foreign object or if the unit becomes tangled. Do not operate with broken or damaged equipment.
- Stop the unit immediately if it suddenly begins to vibrate or shake. Inspect for broken, missing or improperly installed parts or attachments.
- Never transport the unit nor set it down with the engine running. An engine that's running could be accidentally accelerated causing the tine assemblies to rotate.
- Always clear your work area of trash or hidden debris that could be thrown back at you or toward a bystander.
- Always keep the handles clean.
- Always disconnect the spark plug wire before performing any maintenance work.
- Always wear eye protection to shield against thrown objects.
- Always protect yourself from hazards such as thorny brush and flying debris by wearing gloves and close fitting clothing that covers arms and legs. Never wear shorts. Don't wear loose clothing or items such as jewelry that could get caught in machinery or underbrush. Secure long hair so it is above shoulder level.

CAUTION!

- Always maintain this unit according to this owner's manual and follow the recommended scheduled maintenance.
- Never modify or disable any of the unit's safety devices.
- Always use genuine Shindaiwa parts and accessories when repairing or maintaining this unit.
- Do not make unauthorized modifications to this unit.
- Never allow the engine to run at high RPM without a load. Doing so could damage the engine.
- When transporting the unit in a vehicle, tie it down securely to prevent damage and fuel spillage.
- Always clear your work area of trash or hidden debris to help ensure good footing.
- Keep the unit as clean as possible. Keep it free of loose vegetation, mud, etc.

Product Description

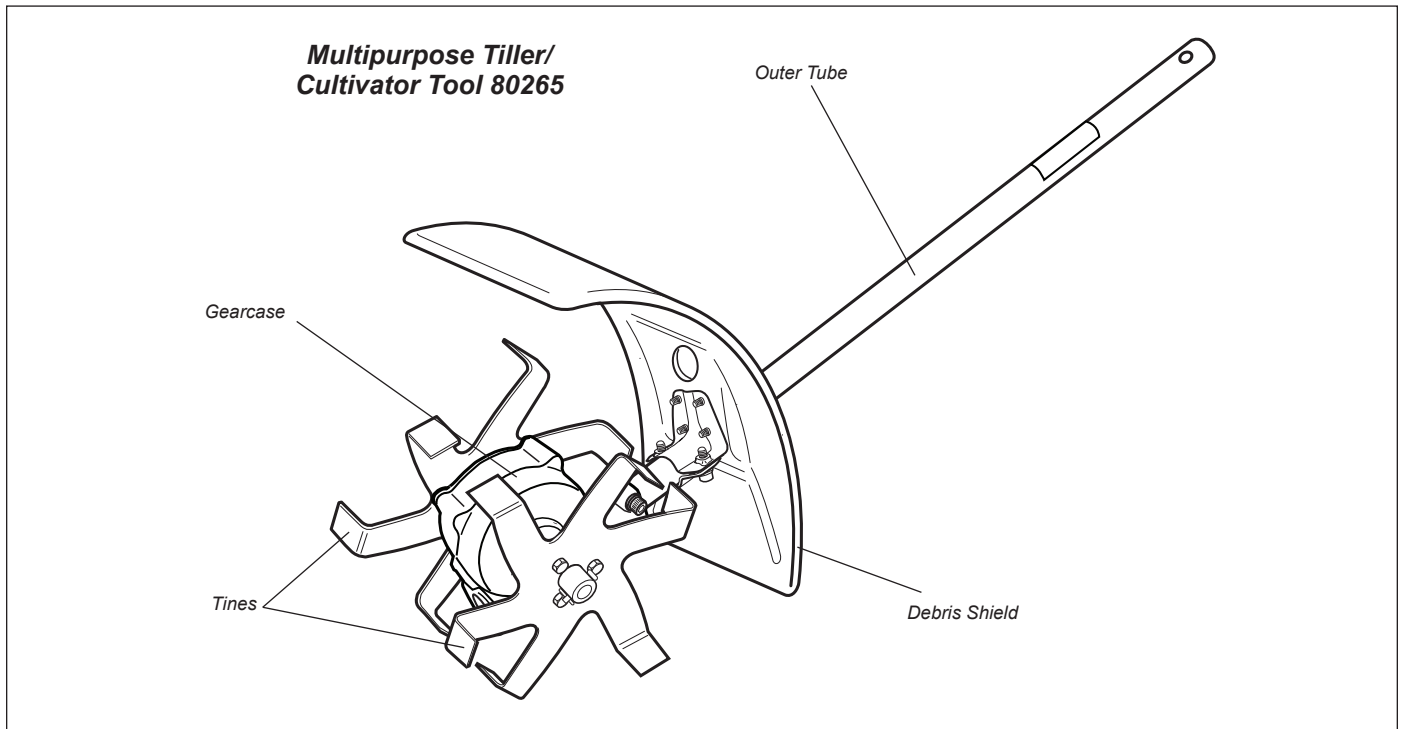

Using the illustration as a guide, familiarize yourself with your machine and its various components. Understanding your machine helps ensure top performance, long service life and safer operation.



WARNING!

Do not make unauthorized modifications or alterations to any of these units or their components.

Specifications

Multipurpose Tiller/Cultivator Tool (w/debris shield & tines)	3.0 kg (6.7 lbs.)
Gearcase Lubrication	Mobil SCH 634 synthetic gear lubricant
Gear Reduction	49:1

Specifications are subject to change without notice.

Assembly

Prior to assembly

Before assembling, make sure you have all the components required for a complete unit:

- Outer Tube/Mainshaft Assembly
- Tiller/Cultivator Tool Assembly
- Kit containing hardware, owner/operator's manual, and a 5 mm hex key.

Carefully inspect all components for damage.

IMPORTANT!

The terms "left", "left-hand", and "LH"; "right", "right-hand", and "RH"; "front" and "rear" refer to directions as viewed by the operator during normal operation.



WARNING!

Do not make unauthorized modifications or alterations to your unit or its components.

Tine Installation and Orientation

Tine installation directly affects the Tiller/Cultivator Tool's ability to break new ground. Using the illustrations as a guide, determine the correct tine orientation for the tilling/cultivating job at hand:

1. Install the tine assemblies to the gearcase output shafts.
2. Secure each tine assembly with one clevis pin and one hitch pin as shown.



WARNING!

Always switch the engine OFF before working on the gearcase or tines!

Install the tine assemblies

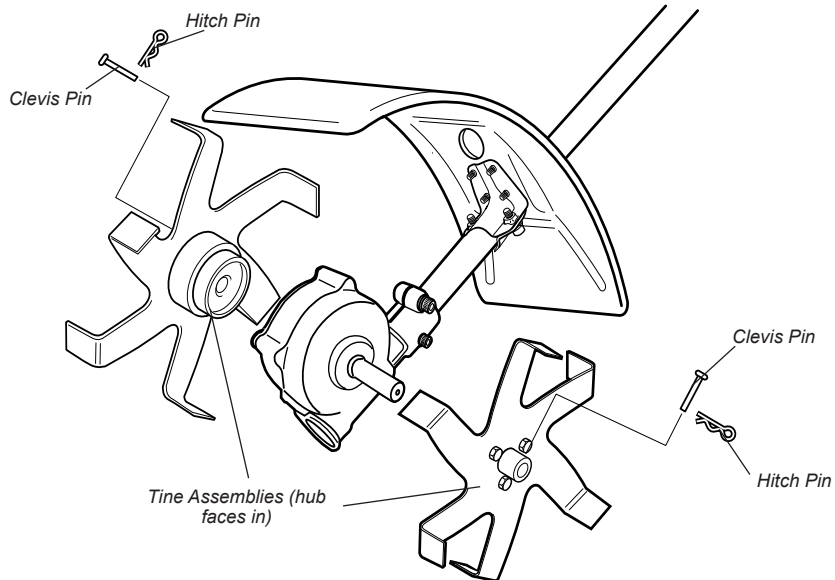

Tilling/Digging in Hard Soil

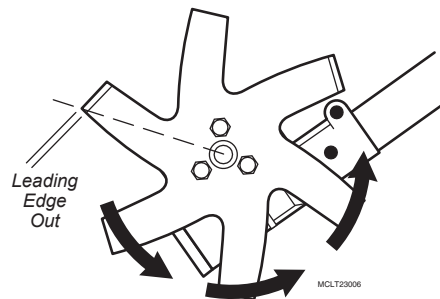

Tiller Leading edge out for aggressive action in hard soils.

Weeding/Cultivating in Softer Soil

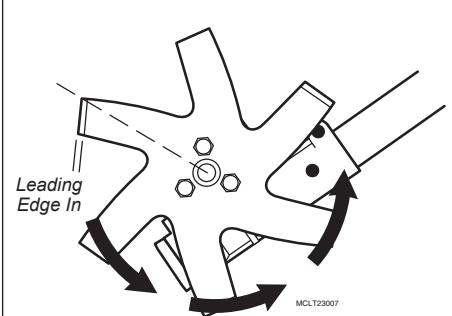

Cultivator Leading edge in for weeding or turning softer soils.

Assembly

Assembling tube sections

1. Place powerhead/lower tube assembly on a clean, flat surface so that both assemblies fit end to end. The powerhead/lower tube assembly should be facing positioned with the locking hole in the tube end facing up.

CAUTION!

Keep the open ends of the tubes clean and free of debris!

2. Slip off the protective plastic covers from the ends of both tubes, and loosen the coupler screw knob.
3. Insert the tool assembly into the coupler, with the tool decal facing up, until the line of the decal is flush with the end of the coupler.
4. Twist the tool assembly back and forth until you are sure it snaps in place by the coupler latch.
5. When the two tube halves are locked together, press down on the spring-loaded latch protector and tighten the coupler screw knob.

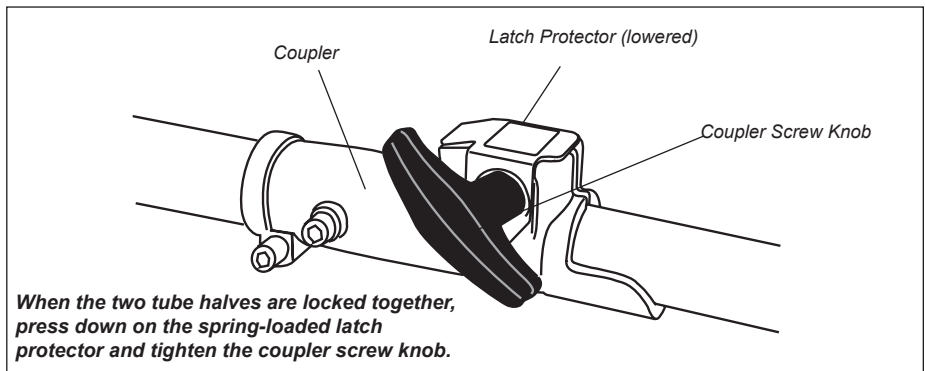
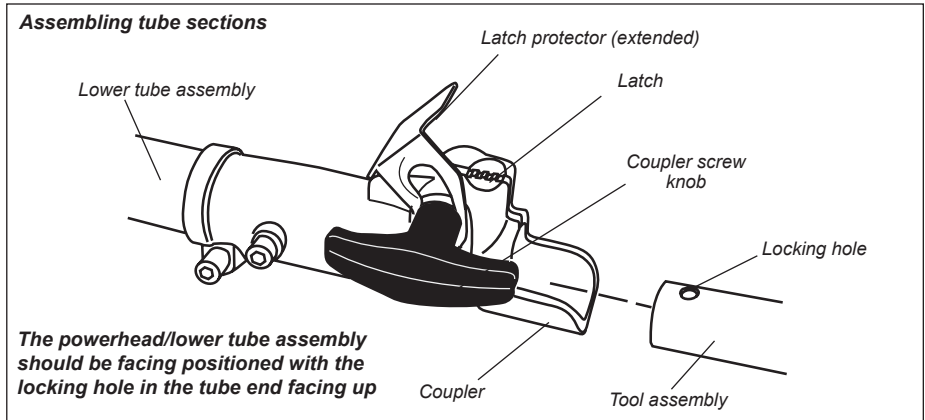

Disassembling the tube sections

1. With the unit on a clean, flat surface, loosen the coupler screw. The spring-loaded coupler protector should pop up.
2. Press down on the latch with your finger or thumb. This releases the coupler lock.
3. Pull the upper tube assembly out of the coupler.

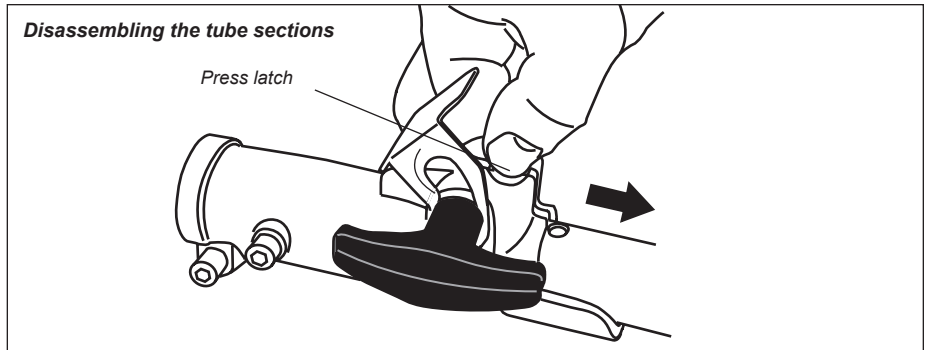

Optional Accessories

Strap and Hanger

Although a strap and hanger is not required for use with this unit, it is recommended to reduce operator fatigue during extended periods of operation. Make sure all hooks and adjusting devices are secure. Adjust the harness shoulder strap so the shoulder pad rests comfortably on the off-side shoulder.



Operating Checking Unit Condition

NEVER operate the unit with the protective devices (ignition switch, etc.) removed!

ALWAYS make sure the tool attachment is properly installed and firmly tightened before operation.

Use only authorized Shindaiwa parts and accessories with your Shindaiwa Multipurpose Tool. Do not make modifications to your machine without the written approval of Shindaiwa.

Starting and Fueling

For detailed instructions on general safety procedures, fueling, starting, and stopping the powerhead assembly, refer to the appropriate Owner's Manual for your machine.

Operating Techniques

Your Shindaiwa Tiller/Cultivator Tool's reversible tines allow you to quickly change from operation as a cultivator-weeder to an aggressive tiller for quickly digging a new garden or landscaping plot. For best operation in either mode:

1. **WATER** the area to be tilled at least 24 hours before your planned tilling operation; then water again about 3 hours before the actual tilling.
2. **PULL** the tiller slowly toward you when tilling or cultivating.

Use the correct method for the job:

- **FOR DEEP TILLING** (up to 25 cm/10" depth) use full throttle while slowly rocking the tiller back and forth over the work area.
- **SHALLOW WEEDING** in soft soils is easiest when the tines are installed in the cultivating configuration, with additional depth available by using a gentle rocking motion as described above.
- **HEAVY WEEDS** or weeding in harder soils may require reversing the tines to the more aggressive tiller configuration.

NEVER use a cracked or warped tine: replace it with a serviceable one.

ALWAYS stop the engine immediately and check for damage if you strike a foreign object or if the machine becomes tangled. Do not operate with broken or damaged equipment.

NEVER allow the engine to run at high RPM without a load. Doing so could damage the engine.

NEVER operate a machine with worn or damaged fasteners or attachment holders.

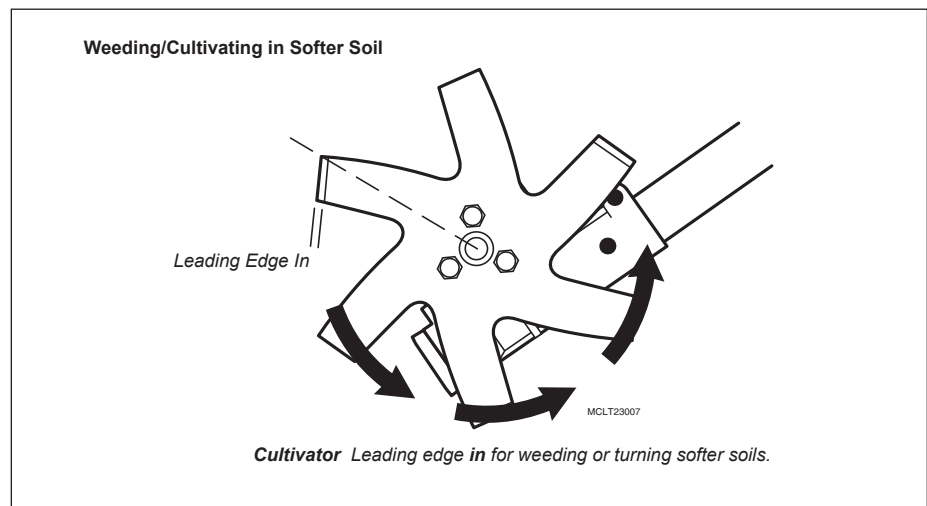
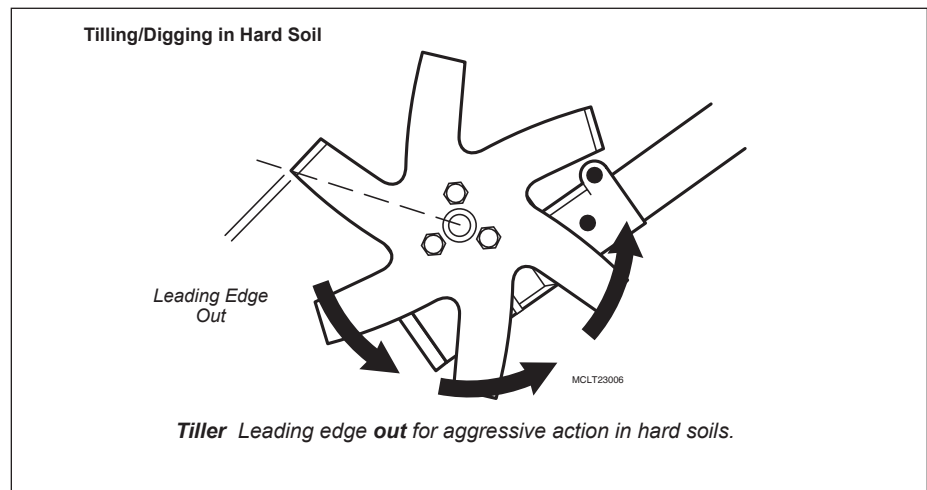
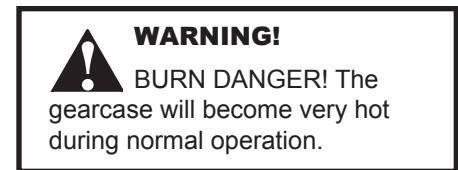
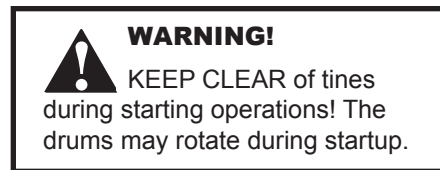

Maintenance

IMPORTANT!

For detailed maintenance information about your unit, consult the owner's manual that was provided with it. If it has been lost or misplaced, contact Shindaiwa for a replacement.

NOTE

Using non-standard replacement parts could invalidate your Shindaiwa warranty.

Daily Maintenance

Prior to each work day, perform the following:

- Remove all dirt and debris from the engine, check the cooling fins and air cleaner for clogging, and clean as necessary.
- Make sure nuts, bolts, and screws (except carburetor idle speed adjusting screws) are tight.

300 Hour Maintenance

Gearcase Lubrication

The gearcase should be filled with 60 cc (2.0 fl.oz.) of Mobil SHC634 Synthetic Gear Oil. A maximum of 75-80 cc can be used, but never to exceed 80 cc. Operation with excessive oil level will result in high operating temperatures. Do not overfill!

Replacing the gearcase oil



WARNING!

BURN DANGER! The gearcase will be extremely hot after use!

1. Disconnect spark plug wire at engine.
2. Remove the LH Drum and axle assembly (as viewed from the operating position). Wipe the sideplate clean and remove four screws (it is not necessary to remove the gearcase from the outer tube).
3. Turn gearcase side plate to break the seal and lift the plate from the gearcase.



WARNING!

Before performing any maintenance, repair, or cleaning work on the unit, make sure the engine and cutting attachment are completely stopped. Disconnect the spark plug wire before performing service or maintenance.



WARNING!

Non-standard accessories, cutting attachment, or replacement parts may not operate properly with your unit and may cause damage and lead to personal injury.

- Carefully remove any accumulations of dirt or debris from the muffler and fuel tank. Check cooling air intake area at base of crankcase. Remove all debris. Dirt build-up in these areas can lead to engine overheating, fire, or premature wear.
- Clean any debris or dirt from the cutting attachment.

- Check for loose or missing screws or components. Make sure the cutter attachment is securely fastened.
- Check the entire unit for leaking fuel or grease.

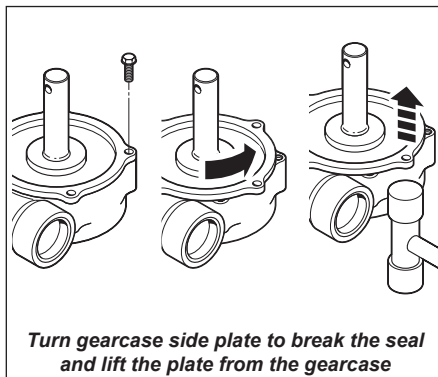

Turn gearcase side plate to break the seal and lift the plate from the gearcase

4. Turn the gearcase to the LH side and allow all used gearcase oil to drain into a small container.

NOTE:

It may be necessary to use a heat gun to soften the sealer material.

5. Place the gearcase on the RH side and supported so the outer tube is parallel to the ground. Refill the gearcase with 60 cc (2.0 fl.oz) of Mobil SHC634 Synthetic Gear Oil to the bottom of the chamfer on the output gear. The correct oil depth is 15.5 mm (5/8"). **DO NOT OVERFILL!**

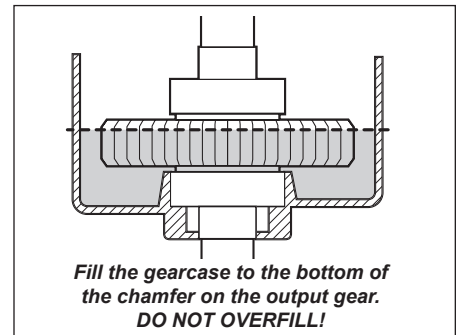

6. Inspect the sideplate for damage and clean off all remaining liquid gasket material with brake cleaner or acetone. Coat the outer sealing flange of the sideplate with Loctite Ultragrey Silicon Sealant or Threebond No. 1104 Liquid Gasket.
7. Replace the cover and install the four sideplate screws. Tighten securely.
8. Reinstall the drum and axle assembly per the sweeper assembly instructions.

Troubleshooting Guide

ADDITIONAL PROBLEMS

What To Check	Possible Cause	Remedy
Tines rotates at engine idle.	Engine idle too high. Broken clutch spring or worn clutch spring boss. Loose attachment holder.	Check Multipurpose Engine manual for correct idle speed and adjustment procedure. Replace spring/shoes as required, check idle speed. Inspect and re-tighten holders securely.
Excessive vibration.	Warped or damaged attachment. Loose gearcase. Bent main shaft/worn or damaged bushings.	Inspect and replace attachment as required. Tighten gearcase securely. Inspect and replace as necessary.
Tines will not rotate.	Shaft not installed in powerhead or gearcase. Broken shaft. Damaged gearcase.	Inspect and reinstall as required. Consult with a authorized servicing dealer.

**SHINDAIWA LIMITED WARRANTY STATEMENT FOR
PRODUCT SOLD IN USA AND CANADA BEGINNING 01/01/2010**

ECHO, INC'S RESPONSIBILITY

ECHO Incorporated's (ECHO, INC.) Limited Warranty, provides to the original purchaser that this Shindaiwa product is free from defects in material and workmanship. Under normal use and maintenance from date of purchase, ECHO, INC. agrees to repair or replace at its discretion, any defective product free of charge at any authorized Shindaiwa servicing dealer within listed below application time periods, limitations and exclusions. **THIS LIMITED WARRANTY IS ONLY APPLICABLE TO SHINDAIWA PRODUCTS SOLD BY AUTHORIZED SHINDAIWA DEALERS. IT IS EXTENDED TO THE ORIGINAL PURCHASER ONLY, AND IS NOT TRANSFERABLE TO SUBSEQUENT OWNERS EXCEPT FOR EMISSION RELATED PARTS.** Repair parts and accessories replaced under this warranty are warranted only for the balance of the original unit or accessory warranty period. Any damage caused by improper installation or improper maintenance is not covered by this warranty. All parts or products replaced under warranty become the property of ECHO, INC. This warranty is separate from the Emission control warranty statement supplied with your new product. Please consult the Emission Control Warranty Statement for details regarding emission related parts. For a list of Authorized Shindaiwa Dealers refer to WWW.SHINDAIWA.COM or call **1-877-986-7783**.

OWNER'S RESPONSIBILITY

To ensure trouble free warranty coverage it is important that you register your Shindaiwa equipment on-line at WWW.SHINDAIWA.COM or by filling out the warranty registration card supplied with your unit. Registering your product confirms your warranty coverage and provides a direct link if we find it necessary to contact you.

The owner shall demonstrate reasonable care and use, and follow preventative maintenance, storage, fuel and oil usage as prescribed in the operator's manual. Should a product difficulty occur, you must, at your expense, deliver or ship your Shindaiwa unit to an authorized Shindaiwa servicing dealer for warranty repairs (within the applicable warranty period), and arrange for pick-up or return of your unit after the repairs have been made. For your nearest authorized Shindaiwa servicing dealer, call Shindaiwa's Dealer Referral Center, at 1-877-986-7783 or you can locate a Shindaiwa servicing dealer at WWW.SHINDAIWA.COM. Should you require assistance or have questions concerning Shindaiwa's Warranty Statement, you can contact our Consumer Product Support Department at 1-800-673-1558 or contact us through the web at WWW.SHINDAIWA.COM.

PRODUCT WARRANTY PERIOD

RESIDENTIAL APPLICATION

- **2 YEAR WARRANTY** - Units for residential, or non-income producing use will be covered by this limited warranty for **two (2) years** from date of purchase.

EXCEPTIONS:

- For engine powered products, the electronic ignition module, flexible drive cable, and solid drive shaft are warranted for the **life*** of the product on parts only.
- Cutting attachments such as, but not limited to, bars, chains, sprockets, tines, blades, Power Broom™, belts, and nylon trimmer heads for residential or non-income producing use will be covered for failures due to defects in material or workmanship for a period of **60 days** from original product purchase date. Any misuse from contact with concrete, rocks, or other structures is not covered by this warranty.
- Multipurpose Tool Attachments carry the same warranty duration as the units they are designed to fit.

COMMERCIAL APPLICATION

- **90 DAY WARRANTY** - All Chain Saws and Cut-Off Saws for commercial, institutional, agricultural, industrial, or income producing use will be covered by this limited warranty for **90 Days** from the date of purchase.
- **2 YEAR WARRANTY** - Units for commercial, institutional, agricultural, industrial, or income producing use will be covered by this limited warranty for **two (2) years** from the date of purchase.

EXCEPTIONS:

- For engine powered products, the electronic ignition module, flexible drive cables, and solid drive shafts are warranted for the **life*** of the product on parts only.
- Cutting attachments such as, but not limited to, bars, chains, sprockets, tines, blades, Power Broom™, belts, and nylon trimmer heads for commercial, institutional, agricultural, industrial, rental, or income producing will be covered for failures due to defects in material or workmanship for a period of **30 days** from original product purchase date. Any misuse from contact with concrete, rocks, or other structures is not covered by this warranty.
- Multipurpose Tool Attachments carry the same warranty duration as the units they are designed to fit.

RENTAL APPLICATION - 90 DAYS WARRANTY

- Units for rental use will be covered against defects in material and workmanship for a period of 90 days from the date of purchase.

* ECHO INC's liability under the "Lifetime" coverage is limited to furnishing parts specified under the PRODUCT WARRANTY PERIOD section of this warranty statement for "**Life**" free of charge for a period of ten (10) years after the date of the complete unit's final production.

PURCHASED REPAIR PARTS AND ACCESSORIES

- 90-day all applications

ATTENTION ENGINE POWERED PRODUCT OWNERS

This Shindaiwa engine powered product is a quality-engineered unit which has been manufactured to exact tolerances to provide superior performance. To help ensure the performance of the unit, it is required to use engine oil which meets the ISO-L-EGD Standard per ISO/CD 13738 and JASO M345/FD Standards. Shindaiwa Red Armor™ and Shindaiwa One™ are a premium engine oil specifically formulated to meet ISO-L-EGD (ISO/CD 13738) and JASO M345/FD Standards. The use of engine oils designed for other applications, such as for outboard motors or lawnmowers can result in severe engine damage, and will void your engine limited warranty.

THIS WARRANTY DOES NOT COVER DAMAGE CAUSED BY:

- Lack of lubrication or engine failure, due to the use of engine oils that do not meet the ISO-L-EGD (ISO/CD 13738) and JASO M345/FD Standards. Shindaiwa ONE™ Engine Oil meets the ISO-L-EGD and JASO M345/FD Standard. Emission related parts are covered for 2 years regardless of engine oil used, per the statement listed in the EPA or California Emission Control Warranty Explanation.
- Damage caused by use of gasohol, containing methanol (wood alcohol), or gasoline containing less than 89 octane. Only use gasoline which contains 89 octane or higher. Gasohol which contains a **maximum** 10% ethanol (grain alcohol) or 15% MTBE (methyl/tertiary/butyl/ether) is also approved. The prescribed mixing ratio of gasoline to oil is listed on the Shindaiwa oil label and covered in your operator's manual.
- Engine damage caused by use of ether or any starting fluids.
- Damage caused by tampering with engine speed governor or emission components, or running engines above specified and recommended engine speeds as listed in your operator's manual.
- Operation of the unit with improperly maintained/removed cutting shield or removed/damaged air filter.
- Damage caused by dirt, pressure or steam cleaning the unit, salt water, corrosion, rust, varnish, abrasives, and moisture.
- Defects, malfunctions or failures resulting from abuse, misuse, neglect, modifications, alterations, normal wear, improper servicing, or use of unauthorized attachments.
- Incorrect storage procedures, stale fuel, including failure to provide or perform required maintenance services as prescribed in the operator's manual. Preventative maintenance as outlined in the operators manual is the customer's responsibility.
- Failures due to improper set-up, pre-delivery service or repair service by anyone other than authorized Shindaiwa servicing dealer during the warranty period.
- Certain parts and other items are not warranted, including but not limited to: lubricants, starter cords, and engine tune-ups.
- Use of spark plugs other than those meeting performance and durability requirements of the OEM spark plug listed in the Operator's Manuals.
- Overheating or carbon scoring failures due to restricted, clogged exhaust port or combustion chamber, including damage to spark arrester screen.
- Adjustments after the first (30) thirty days and beyond, such as carburetor adjustment and throttle cable adjustment.
- Damage to gears or gear cases caused by contaminated grease or oil, use of incorrect type or viscosity of lubricants, and/or failure to comply with recommended grease or oil change intervals.
- Damage caused by pump or sprayer running dry, pumping or spraying caustic or flammable materials, or lack of or broken strainers.
- Additional damage to parts or components due to continued use after operational problem or failure occurs. Should operational problem or failure occur, the product should not be used, but delivered as is to an authorized Shindaiwa servicing dealer.

It is a dealer's and/or customer's responsibility to complete and return the warranty registration card supplied with your Shindaiwa product or by visiting WWW.SHINDAIWA.COM. Your receipt of purchase including date, model and serial number must be maintained and presented to an authorized Shindaiwa servicing dealer for warranty service. Proof of purchase rests solely with the customer. Some states do not allow limitations on how long an implied warranty lasts, so the above limitations may not apply to you. Some states do not allow the exclusion or limitation of incidental or consequential damages, so you may also have other specific legal rights which vary from state to state. This limited warranty is given by ECHO Incorporated, 400 Oakwood Rd., Lake Zurich, IL 60047.

DISCLAIMER OF IMPLIED WARRANTIES

This limited warranty is in lieu of all other expressed or implied warranties, including any warranty of FITNESS FOR A PARTICULAR PURPOSE OR USE and any implied warranty of **MERCHANTABILITY** otherwise applicable to this product. ECHO, INC. and its affiliated companies shall not be liable for any special incidental or consequential damage, including lost profits. There are no warranties extended other than as provided herein. This limited warranty may be modified only by ECHO, INC.

99922201031
02/05/2010

Servicing Information

Parts/Serial Number

Genuine Shindaiwa Parts and Assemblies for your Shindaiwa products are available only from an Authorized Shindaiwa Dealer. When you do need to buy parts **always** have the Model Number, Type and Serial Number of the unit with you. You can find these numbers on the engine. For future reference, write them in the space provided below.

Model No. _____ Type _____ SN. _____

Service

Service of this product during the warranty period must be performed by an Authorized Shindaiwa Service Dealer. For the name and address of the Authorized Shindaiwa Service Dealer nearest you, ask your retailer or call: 1-877-986-7783. Dealer information is also available on WWW.SHINDAIWA.COM. When presenting your unit for Warranty service/repairs, proof of purchase is required.

Consumer Product Support

If you require assistance or have questions concerning the application, operation or maintenance of this product you may call the Shindaiwa Consumer Product Support Department at 1-877-986-7783 from 8:30 am to 4:30 pm (Central Standard Time) Monday through Friday. Before calling, please know the model and serial number of your unit.

Warranty Registration

To ensure trouble free warranty coverage it is important that you register your Shindaiwa equipment by filling out the warranty registration card supplied with your unit. Registering your product confirms your warranty coverage and provides a direct link if we find it necessary to contact you.

Additional or Replacement Manuals

Replacement Operator and Parts Catalogs are available from your Shindaiwa dealer or at WWW.SHINDAIWA.COM or by contacting the Consumer Product Support Department (1-877-986-7783). Always check WWW.SHINDAIWA.COM for updated information.

shindaiwa

ECHO Incorporated.
400 Oakwood Road
Lake Zurich, IL 60047-1564 U.S.A.
Telephone: 1-877-986-7783
Fax: 1-847-540-8416
www.shindaiwa.com

Yamabiko Corporation
7-2 Suehirocho 1-Chome, Ohme,
Tokyo, 198-8760, Japan
Phone: 81-428-32-6118
Fax: 81-428-32-6145

Copyright© 2010 By Echo, Incorporated
All Rights Reserved.

Free Manuals Download Website

<http://myh66.com>

<http://usermanuals.us>

<http://www.somanuals.com>

<http://www.4manuals.cc>

<http://www.manual-lib.com>

<http://www.404manual.com>

<http://www.luxmanual.com>

<http://aubethermostatmanual.com>

Golf course search by state

<http://golfingnear.com>

Email search by domain

<http://emailbydomain.com>

Auto manuals search

<http://auto.somanuals.com>

TV manuals search

<http://tv.somanuals.com>