



Model MX692 User Guide

SHURE MX692 WIRELESS BOUNDARY MICROPHONE TRANSMITTER



- Integrated functionality of Microflex boundary microphone and UC Series wireless transmitter
- Frequency agile transmitter offers over 100 user selectable channels for UA and UB frequency bands; run up to 32 systems simultaneously
- User programmable touch-sensitive switch and status LED
- 9V battery-powered with 3-stage battery life LED indicator
- Thread mount cartridge connection for easy field replacement
- Internal antenna
- Requires Shure UC4 receiver (sold separately)

TABLE OF CONTENTS: ENGLISH

Introduction	2
MX692 Features and Controls	3
MX692 Features and Controls Continued	4
Checking and Replacing the Battery	5
Adjusting the Transmitter Gain Level	6
Changing the Transmitter Group/Channel Settings	6
Positioning the Microphone	7
Positioning Multiple Microphones	8
Positioning the Receiver	9
Removing the Grille	10
Additional or Replacement Cartridges	11
The Internal DIP Switches	12
Customizing Microphone Switch Functionality	13
Tips for Optimum Performance	14
Using the MX692 in Large Installations	14
Troubleshooting	15
Specifications	16

INTRODUCTION

The MX692 wireless boundary microphone is for use in a variety of boardroom, education, government, and house of worship applications that require a clean, cable-free installation. Additionally, the MX692 is useful in retrofit installations where the modification of existing architecture and furnishings is unwelcome, and in facilities where a flexible, mobile audio system is required.

The user-programmable mute switch and interchangeable microphone cartridges allow customization of microphone behavior and audio response to suit many applications. The transmitter antenna is mounted internally, giving the microphone a sleek appearance.

The MX692 integrates a boundary microphone and a wireless transmitter. The transmitter broadcasts on the UA (782.125–805.750 MHz) and UB (692.500–715.625 MHz) frequency bands. These frequencies are legal for broadcast in the U.S., Canada, Central and South America, and Australia.

The Shure UC Wireless system divides frequency bands into “groups” and “channels.” Up to sixteen individual MX692 transmitter/UC4 receiver pairs, each with its own channel, may be assigned to a single group. With two frequency bands to choose from, it is possible to run up to 32 microphones simultaneously in a single sound system.

MX692 FEATURES AND CONTROLS

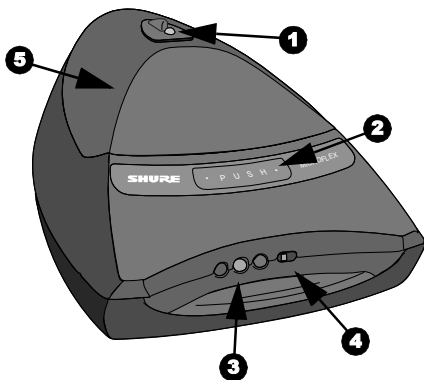

- 1** Microphone Status LED
Microphone is active when lit.
- 2** Programmable Touch-sensitive Switch
Touch to mute or activate microphone, depending on logic settings.
- 3** Power/Battery Life Gauge
LED color indicates battery power status.
- 4** Power On/Off Switch
- 5** Protective Grille
Grille can be removed to access microphone cartridge and DIP switches.

MX692 FEATURES AND CONTROLS CONTINUED

To access gain and channel settings, open the battery compartment door.

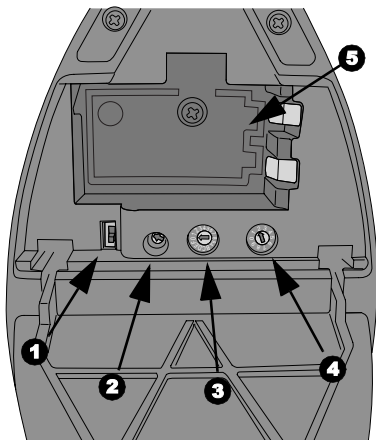

1 Input Attenuation Control

This two position switch lets you select either 0 dB or 20 dB attenuation, depending on the volume of the talker's voice.

2 Transmitter Output Gain Control

Changes the audio level to accommodate various input volumes. Use the supplied screwdriver to make adjustments.

3 Channel Setting Control (green dial)

Rotating the Channel dial changes the Channel setting. Use the supplied screwdriver to make adjustments.

4 Group Setting Control (red dial)

Rotating the Group dial changes the Group setting. Use the supplied screwdriver to make adjustments.

5 Battery Compartment

Holds one 9V battery

CHECKING AND REPLACING THE BATTERY

To check the battery charge:

1. Turn the transmitter switch to on
2. Verify that one of the battery power LEDs is glowing (see page 3).
3. The amount of battery life remaining is indicated by which LED is lit, as shown in the following table:

Transmitter LED Color	Remaining Operating Time
Green	2 to 8 hours
Amber	45 minutes to 2 hours
Red	45 minutes or less

Replacing the battery:

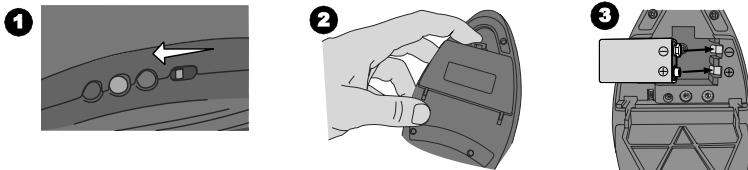

For extended performance, use a 9V lithium battery. Rechargeable, carbon-zinc, and zinc-chloride batteries are not recommended.

ADJUSTING THE TRANSMITTER GAIN LEVEL

If transmitter gain is set correctly, the audio LED meter on the UC4 receiver should reach amber during normal speech and momentarily flash red during the loudest

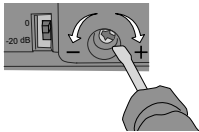

speech. If transmitter output needs to be increased or decreased, adjust the output gain control.

Set the input attenuation control switch to 9 dB for normal use (default) or -20 dB for loud voices (this is rare).

CHANGING THE TRANSMITTER GROUP/CHANNEL SETTINGS

For a wireless transmitter such as the MX692 to communicate with a receiver, the transmitter and receiver must be communicating on the same frequency. The frequency is set by changing the transmitter and receiver “group” and “channel” settings. For a MX692 transmitter to communicate with a UC4 receiver, the two must have matching group and channel settings.

See the Shure website for recommended group and channel settings for your area.

To change MX692 group and channel settings:

1. Turn the transmitter off.
2. Using the supplied

screwdriver, rotate the GROUP dial (see page 4) until the desired setting is reached. Then rotate the CHANNEL dial until the desired setting is reached.

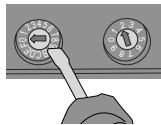

POSITIONING THE MICROPHONE

With the standard cardioid cartridge installed, the MX692 will pick up audio at conversational volume levels within 1.5 M (5 ft.) in a 130 degree range.

As a general rule, a single microphone should be used for every two people speaking.

If a tighter pickup range is required, a supercardioid cartridge may be used.

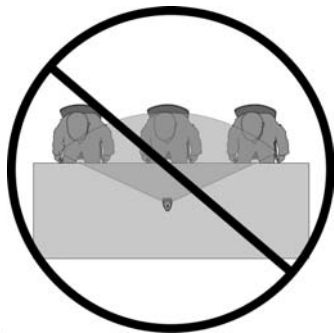
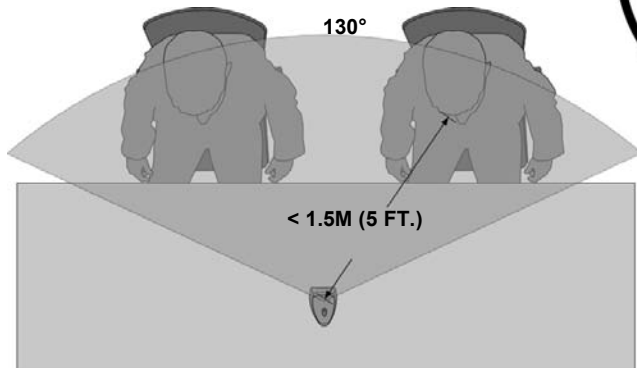

POSITIONING MULTIPLE MICROPHONES

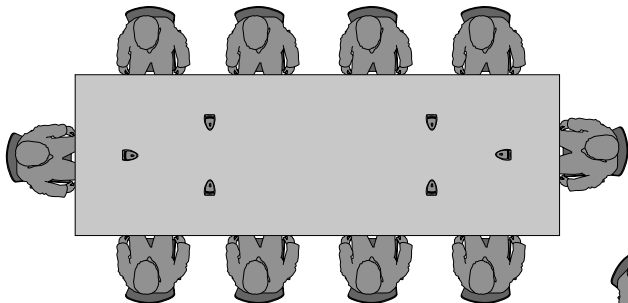

In any installation, good vocal pickup can be achieved by following the positioning rules on page 7. Maintain at least .3 m (1 ft.) separation between transmitters. If you experience transmitter interference, increase the distance between transmitters, or change the channel of one transmitter/receiver pair.

For information on receiver setup and positioning, see the UC4 Wireless System user guide.

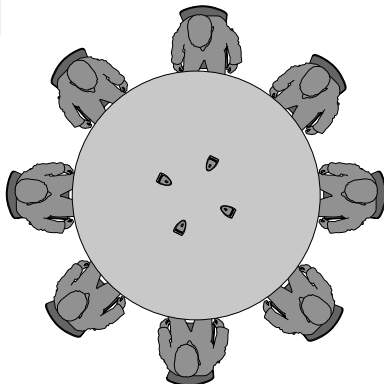

POSITIONING THE RECEIVER

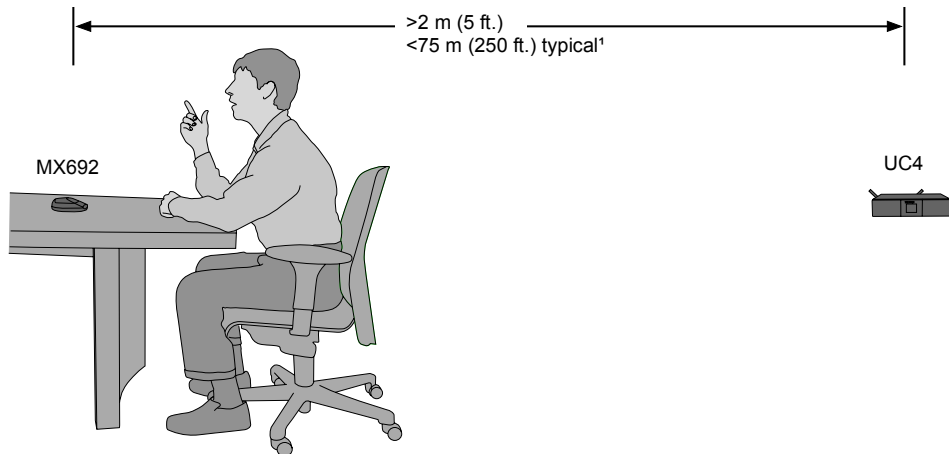

The UC4 receiver may be rack mounted. See page 14 for information on systems with multiple transmitters and receivers.

¹ Maximum distance depends on signal absorption, reflection, and interference.

REMOVING THE GRILLE

1. Open the battery compartment
2. Remove the battery
3. Loosen and remove the screw at the base of the battery compartment

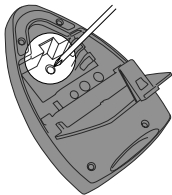

4. Remove the retainer from the top of the microphone

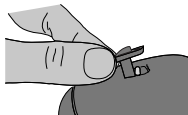

5. Insert the screwdriver into the opening above the battery compartment

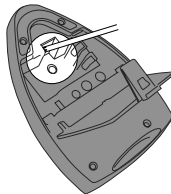

6. Press gently on the underside of the microphone grille with the tip of the screwdriver until the grille pops out

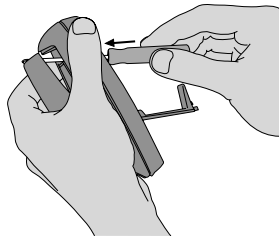

ADDITIONAL OR REPLACEMENT CARTRIDGES

Additional or replacement cartridges may be purchased for the MX692. For more information or to order cartridges, contact the Shure service department or an authorized Shure service center.

To replace the microphone cartridge:

1. Remove the grille (see page 10)
2. Loosen the screw and remove the cartridge clamp
3. Twist to remove the existing cartridge
4. Reverse procedure to install new cartridge

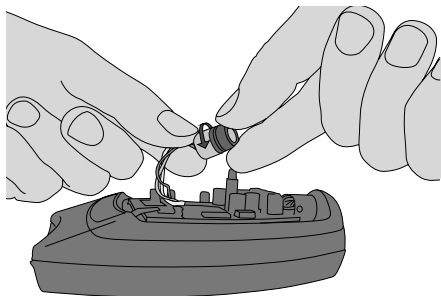
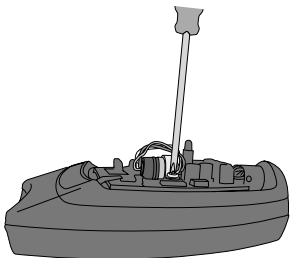



Omnidirectional Cartridge	R183B
Supercardioid Cartridge	R184B
Cardioid Cartridge	R185B

THE INTERNAL DIP SWITCHES

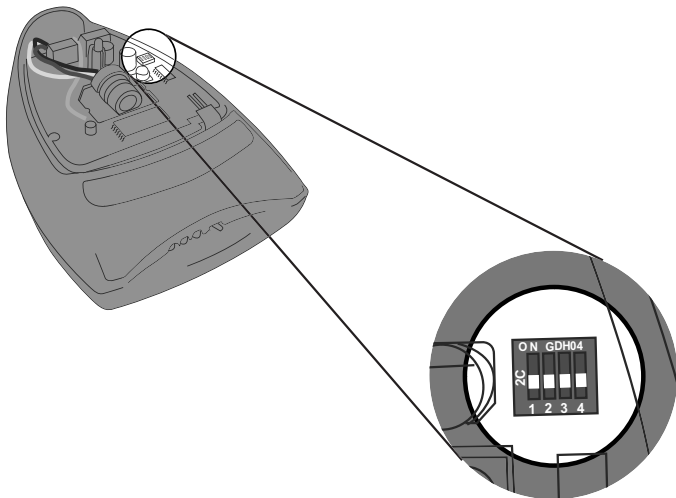
The functionality of the touch-sensitive switch on the microphone's front panel (see page 3) can be customized using the internal DIP switches. See page 13 for customization options.

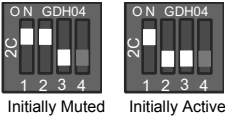

CUSTOMIZING MICROPHONE SWITCH FUNCTIONALITY

DESIRED SWITCH FUNCTIONALITY	DESIRED LED FUNCTIONALITY	DIP SWITCH SETTING
Push to mute, release to talk (as shipped)	LED on when microphone is active	
Push to talk release to mute	LED on when microphone is active	
Toggle: push on/push off	LED on when microphone is active	

Note: switch 4 of the MX692 DIP switch panel is not active

TIPS FOR OPTIMUM PERFORMANCE

- Maintain a line of sight between transmitter and receiver antennas.
- Avoid using the MX692 microphone on metal surfaces.
- Avoid placing laptop computers or other obstructions in front of the microphone during use.
- The MX692 wireless microphone/transmitter must be used with the Shure UC4 wireless receiver.

USING THE MX692 IN LARGE INSTALLATIONS

- When using multiple receivers in a single location, use successive channels within the same group.
- Use the UA845 UHF Antenna Distribution System to split the signal from one pair of antennas to multiple UC4 receivers.
- To improve RF reception, use the UA500 Remote Mount Antenna Kit to mount 1/2-wave receiver antennas closer to the transmitters.
- For installations with long cable runs, use the UA830 UHF In-Line Antenna Amplifier. If a cable run exceeds 50 ft., two UA830's may be chained together.

TROUBLESHOOTING

If you experience difficulty, check the following:

- Make sure both the transmitter and the receiver are turned on.
- Check the MX692 battery gauge. Replace the battery if necessary.
- Make sure the transmitter and receiver frequency group/channel settings are identical.
- Make sure there is an unobstructed line-of-sight between the transmitter and receiver.
- If necessary, reposition the receiver, or decrease the distance between transmitter and receiver.
- Remove local sources of RF interference, such as lighting equipment.

For in-depth troubleshooting, see your UC Wireless System user guide.

SPECIFICATIONS

Frequency response (see insert)

50 to 17,000 Hz

Polar pattern (see insert)

Cardioid (supplied)

Current drain

62 ± 10 mA, typical (V_{SS} = 6.0 to 9.6 VDC)

Battery life

7 hours (based on alkaline battery)

Dynamic range

>100 dB minimum, A-weighted

Gain Adjustment Range

-6 to 34 dBs

Modulation

+/-45 kHz deviation

Polarity

Positive pressure on the diaphragm produces a positive voltage on pin 2 of the XLR output of the UC4 receiver.

Transducer type

Electret condenser

Power Requirements

9V alkaline battery

Temperature Range

Operating: (20° to 120° F)

Storage: (-20° to 165° F)

RF Carrier Frequency Range

692–716 MHz (UB)

782–806 MHz (UA)

Working Ranges

75 m (250 ft.) typical

250 m (800 ft.) line-of-sight

Note: actual working range depends on RF signal absorption, reflection, and interference

Minimum Distance Between Transmitters

.3 m (1 ft.)

RF Power Output

50 mW Max (conducted)

30 mW Typical (radiated)

Certification

See insert

SHURE[®]

SHURE Incorporated <http://www.shure.com>

United States, Canada, Latin America, Caribbean:

5800 W. Touhy Avenue, Niles, IL 60714-4608, U.S.A.

Phone: 847-600-2000 U.S. Fax: 847-600-1212 Int'l Fax: 847-600-6446

Europe, Middle East, Africa:

Shure Europe GmbH, Phone: 49-7131-72140 Fax: 49-7131-721414

Asia, Pacific:

Shure Asia Limited, Phone: 852-2893-4290 Fax: 852-2893-4055

Free Manuals Download Website

<http://myh66.com>

<http://usermanuals.us>

<http://www.somanuals.com>

<http://www.4manuals.cc>

<http://www.manual-lib.com>

<http://www.404manual.com>

<http://www.luxmanual.com>

<http://aubethermostatmanual.com>

Golf course search by state

<http://golfingnear.com>

Email search by domain

<http://emailbydomain.com>

Auto manuals search

<http://auto.somanuals.com>

TV manuals search

<http://tv.somanuals.com>