

DA5320 8-CHANNEL AES AUDIO MIXER/ ROUTER MODULE

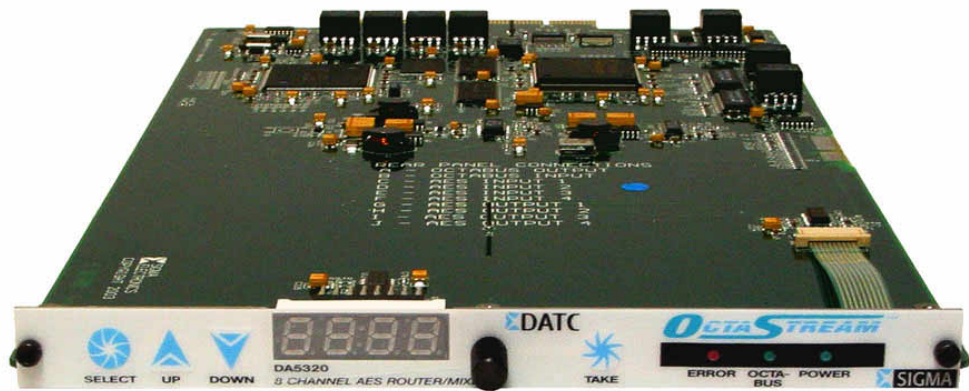

SIGMA ELECTRONICS's products are certified to comply with the regulations and recommendations of several certifying agencies.

For complete details, as well as copies of the certification documents, please visit our website at www.sigmaelectronics.com or contact us using the Technical Support contacts listed elsewhere in this document.

SYMBOLS



The presence of this symbol in or on SIGMA ELECTRONICS equipment means that it has been designed, tested and certified as complying with applicable Underwriter's Laboratory (USA) regulations and recommendations.



The presence of this symbol in or on SIGMA ELECTRONICS equipment means that it has been designed, tested and certified as essentially complying with all applicable European Union (CE) regulations and recommendations.

COPYRIGHT AND TRADEMARKS

Copyright © 2004, SIGMA ELECTRONICS, Inc. All rights reserved. Printed in USA.

SIGMA ELECTRONICS is a registered trademark of SIGMA ELECTRONICS, Inc.

DISCLAIMER OF LIABILITY

Contents of this publication are current as of the publication date. SIGMA ELECTRONICS reserves the right to change the contents without prior notice. **In no event shall SIGMA ELECTRONICS be liable for any damages resulting from loss of data, loss of use, or loss of profits and SIGMA ELECTRONICS further disclaims any and all liability for indirect, incidental, special, consequential or other similar damages. This disclaimer of liability applies to all products, publications, and services during and after the warranty period.**



SIGMA ELECTRONICS
P.O. Box 448
East Petersburg, PA 17520, USA
In USA and Canada: 1-866-569-2681
Outside USA and Canada: 717-569-2681
FAX: 717-569-4056
Email: sales@sigmaelectronics.com

CUSTOMER APPRECIATION STATEMENT

SIGMA ELECTRONICS would like to take this opportunity to compliment you on your intelligent selection of high-quality audio or video equipment. It is our goal to provide the highest quality products and unparalleled service to all of our valued customers. Please contact us, as shown below, if you have any questions about, or suggestions for, any of our products.

TECHNICAL SUPPORT

SIGMA ELECTRONICS has made every effort to ensure that the equipment you receive is in perfect working order. In the event that problems arise which you cannot resolve, or if there are any questions regarding this equipment or information about other products manufactured by SIGMA ELECTRONICS, please contact your local representative or contact SIGMA ELECTRONICS directly through one of the appropriate means listed below:

Telephone:* Main Number - 1-717-569-2681*
Technical Support - 1-717-569-2681
Sales - 1-866-569-2681/1-717-569-2681

Facsimile: Main Number - 1-717-569-4056
Sales - 1-717-569-4056

Email: Technical Support - service@sigmaelectronics.com
Sales - sales@sigmaelectronics.com

Web Site: <http://www.sigmaelectronics.com>

Mail: SIGMA ELECTRONICS
P.O. Box 448
East Petersburg, PA 17520, USA

Shipping:* SIGMA ELECTRONICS
1027 Commercial Avenue
East Petersburg, PA 17520, USA

* Return Authorization required before any equipment is returned.

INTRODUCTION/OVERVIEW

The multi-function Sigma DA5320 8 Channel Mixer/Router module is a member of the Sigma 5000 series OctaStream™ product line. The DA5320 is to be used in facilities utilizing AES digital audio signals requiring input gain and phase adjustment or where AES digital audio mixing and single channel routing is needed.

PRODUCT SCOPE

This module has the capability to perform two distinct functions -

1. As a member of the Sigma OctaStream™ product family, it includes the OctaBus™ TDM interconnect. This allows the DA5320 to function as a 64 X 8 channel AES router utilizing a single input connector. Deformatting AES signals into single channel streams along with distinct input/output channel assignment facilitates channel-swapping across AES signals.
2. It has the capability to proportionally mix individual input channels into a single output. Each output channel has an 8-channel mixer.

RECEIVING INSPECTION AND UNPACKING

By the time you have found and opened this manual, you have already begun to unpack the shipping container. Since damage may have occurred in shipping it is important to perform the following checks immediately:

- Inspect the shipping container(s) for damage.
- If you find any damage to the containers, carefully inspect the product for damage.
- If any damage is discovered, notify the shipping carrier immediately.

Compare what you received against the packing slip. If anything is missing or has suffered damage unrelated to shipping, contact SIGMA ELECTRONICS Technical Support immediately. Contact information is located at the front of this manual.

SYSTEM COMPONENTS

Frame

The DA5320 module is engineered to operate in a Sigma S5000 Signal Management Frame. This frame provides all the necessary interface components and power for operation of the DA5320 module.

Interface Components

To accommodate a variety of connector requirements necessary for the signal formats accepted by the S5000 Signal Management System, a number of backplanes are available. The DA5320 requires either an RP302 Twisted Pair I/O or RP303 BNC I/O Backplane.

Each S5000 Signal Management System frame is supplied with two (2) backplanes. The required backplane(s) is specified at the time of order. If an existing frame does not have the required backplane, replacement backplanes are available from Sigma Electronics and can easily be installed in the field.

Power

The S5000 Signal Management System frame provides the required power to operate the DA5320 via the backplane adapter. Dual power supplies are available for redundant applications.

Modules

The DA5320 consists of a single-slot card containing a front panel interface of switches, indicator LED's and a four-digit, seven-segment LED display. Via this interface all common configuration settings and status indications are available to the user.

Optionally, if a CI5705 Communications Interface Adapter is installed in the S5000 Signal Management System frame, the DA5320 may be configured and controlled from a remote location via the EIA-485 port. The CI5705 is also necessary if an external video reference is required.

MODULE INSTALLATION/REMOVAL

The DA5320 may be installed in any module slot in a S5000 Signal Management System frame. Up to ten (10) modules of any type may be installed in the same frame. Modules may be hot-swapped eliminating the need to power down the entire frame during replacement.

Modules are held in place by a combination of the retention force of the cardedge connector pins and the motion restriction afforded by the proper installation of the frame front door.



Caution: *For proper cooling, the frame door must remain closed. The door may be opened for a short time, but irregular performance may occur. The temperature and performance will stabilize again within 5 minutes after the door is closed.*

MODULE INSTALLATION

1. Verify that the appropriate backplane is installed in the frame.
2. Remove front door from frame.
3. Insert module into any slot associated with the appropriate backplane.
4. Holding knurled knob, push until module is completely seated in cardedge connector on backplane.
5. Reinstall front door (required for proper operation of S5000 Signal Management System frame - see Caution above).

MODULE REMOVAL

1. Remove frame front panel.
2. Firmly grasp knurled knob on front of module.
3. Pull module out of slot.

Connector Assignment

Because the flexibility of the S5000 Signal Management System frame allows a module to be inserted into any slot position of an appropriate back plane (see Interface Components above), the function of the back plane connectors will vary depending upon the module inserted. The connector assignments for the DA5320 are shown in the following figure.

RP303 BACKPLANE CONNECTOR ASSIGNMENTS - DA5320

A	B	C	D	E	F	G	H	I	J
OCTABUS OUTPUT	OCTABUS INPUT	AES INPUT 1	AES INPUT 2	AES INPUT 3	AES INPUT 4	AES OUTPUT 1	AES OUTPUT 2	AES OUTPUT 3	AES OUTPUT 4

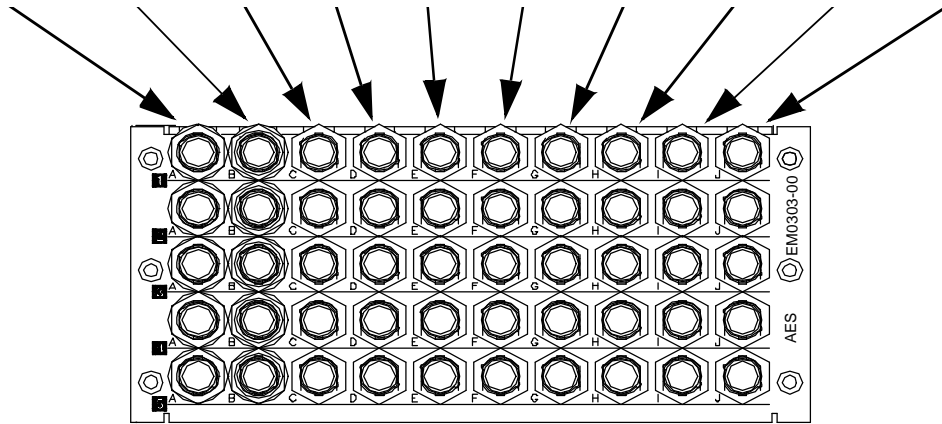

RP302 BACKPLANE CONNECTOR ASSIGNMENTS - DA5320

A	B	C	D	E	F	G	H	I	J
OCTABUS OUTPUT	OCTABUS INPUT	AES INPUT 1	AES INPUT 2	AES INPUT 3	AES INPUT 4	AES OUTPUT 1	AES OUTPUT 2	AES OUTPUT 3	AES OUTPUT 4

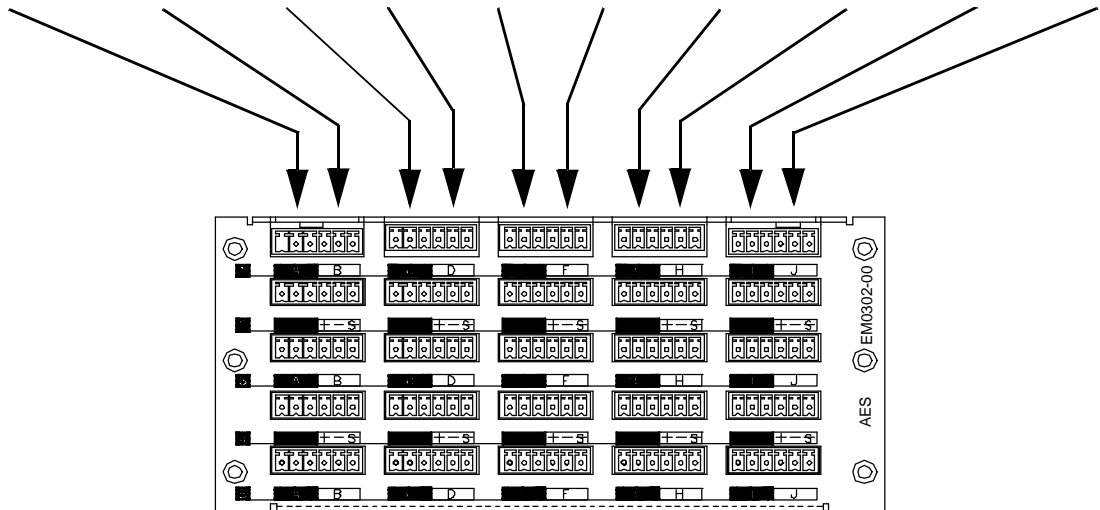

OPERATION

Front Panel Controls/Displays

The front panel, shown below, has three distinct functional areas - the Indicator LED's under the OctaStream logo on the right side; the switch controls, mostly on the left side and the 7-segment display in the middle.

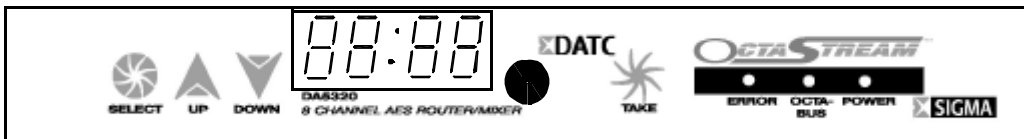

INDICATOR LED'S

LED's are visible from the exterior of the frame when the front door is installed to accommodate checking the status of the modules without affecting the operating conditions within the frame. The LED's provide information about the status of three operating conditions - error status, OctaBus™ status and power bus status.

1. **ERROR** - When this red LED is illuminated an invalid operating condition exists within the DA5320. These errors fall into three categories - power-on self-test failure, missing inputs or problems with the OctaBus™.
 - a. **Power-On Errors** - cycle the power to the unit.
 - b. **Missing Inputs** - The Error LED will illuminate when either the selected input is unavailable or the defined reference signal is not present. To relieve this condition, change the configuration information to specify a different source or turn off the missing input.
 - c. **OctaBus™** - If there are problems with the signal on the OctaBus the ERROR LED will be illuminated and error messages can be accessed via the Diagnostic menu.
2. **OCTABUS** - This green LED indicates the presence of a valid signal connected to the OctaBus™ input BNC.
3. **POWER** - This green LED indicates the presence of suitable power being supplied to the module by the power supply in the S5000 frame.

CONTROLS



SELECT BUTTON

The Select button is used to progress to a lower menu level. If pressed repeatedly, the display will always return to the idle display (see below) *without making any changes to any menu items*. Pressing select after a data store (TAKE) resets the menu to the level where the last option selection was initiated, allowing the operator to perform similar operations on other channels or modify the data just stored.



UP & DOWN BUTTON

The Up and Down buttons are used to toggle, up or down, through the available menu options at the present level in the menu structure. Pressing an ARROW button immediately after a valid data store (TAKE) will change the display to an adjacent channel/selection for that parameter.



TAKE BUTTON

The Take button is used to store the current eligible data into memory. Display data is only eligible for storage when the display is blinking. Pressing the TAKE button immediately after a valid store will return the DA5320 to the idle display (see below).

7-SEGMENT DISPLAY

The 7-segment display is used to display configurable menu items/parameters, provide the current status of a configured parameter, display entry data for modification of configurable parameters and provide details about error conditions.

Typically, after the menu has been accessed and no more buttons have been pushed, the display will return to the idle display after a short delay. The display can also be set to monitor a single channel on a continuous basis to show its current delay.

Power-On Self Test (POST)/Idle Display

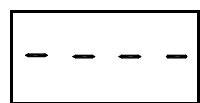

IDLE DISPLAY

On power-up, the DA5320 runs a self-diagnostic routine. If the self-diagnostic routine is completed successfully, the DA5320 will display the idle screen (shown on left). If the POST does not complete, verify that all proper operating conditions exist in the frame, then cycle the power to run the POST again. If it still does not complete, contact technical support as listed earlier in this manual.

Display Activation

To access menus when the Idle Display is showing, press any button.

Status Check

To check the current status of any parameter, activate the menu display and navigate through the menu to the edit screen for the parameter of interest. The initial display will be static, indicating the current data being held in memory for that parameter. If no additional keys are pressed at this time the display will revert to its previously configured idle state (Idle display or channel delay).

Parameter Configuration

Activate the menu display and navigate through the menu to the edit screen for the parameter to be configured. Pressing the UP or DOWN arrows will change the display to a new value and it will begin to blink. Pressing the SELECT button at this point will abort the change and return the display to the idle screen.

To record the parameter change requires that the TAKE button be pushed when the display is blinking. If there are multiple fields (characters) to be changed for a particular parameter, each time the TAKE button is pressed the display will advance to the next field. The new value for the parameter will be stored in memory only after all necessary fields have been defined.

Configurable Parameters/Menu Items

Note: What follows is a discussion of the configurable parameters in the DA5320. To view a diagram of the flow of the menu structure with simple operating instructions, see the section of the manual entitled **MENU STRUCTURE** that follows this discussion.

There are a number of items that are configurable on the DA5320. These fall into two basic categories - Input Parameters and Output Parameters. Additionally, there are some diagnostic, reset and memory storage functions that can be accessed from the front panel through the menu commands.

Input Parameters

Each DA5320 is an 8X8 AES Digital Audio router that can route the signals that are physically connected to it *or any of the other 56 channels available on the OctaBus™*. Which of the available signals it should consider to be Inputs is defined under the I n P menu item. With this menu item the operator defines, by selecting the OctaBus™ ID and the channel number, exactly which signal on the OctaBus™ should be defined as each of the numbered inputs (1-8) to the module being configured, without regard to the physically connected inputs to the module.

NOTE: If OctaBus™ is not enabled, requests for inputs defined as being from other modules (OctaBus™ ID's other than 1), will generate an ERROR condition.

Each of the defined inputs may also have a gain value assigned to them to adjust their incoming level to the mixer or router stages. This gain adjust is adjusted via the G R I n menu item that appears under the I n P main menu selection by specifying the gain factor for each channel. The gain can be adjusted in 1 dB increments.

Output Parameters

Due to the nature of some of the parameters able to be modified, for example enabling outputs, it may be desired to change all or selected groups of outputs simultaneously. To accommodate this, grouping of outputs is provided. Output grouping does not apply to routing functions in the DA5320. Output grouping is the first parameter detailed in this section.

If the module being configured is to be a part of a system that utilizes the OctaBus™, this feature must be activated. This feature is detailed in the OctaBus™ ID Assignment section below.

To operate as a 64 X 8 channel router, the definition of which of the defined inputs should be routed to specific outputs must be detailed. As a mixer, which inputs will be mixed as they are directed to the outputs must also be defined. Finally, the level of the signal to be

sent to the output may be adjusted immediately prior to being sent to the output connector. These features are detailed in the Output Channel Assignment/Mixing/Gain Control section below.

The DA5320 has two additional features that are available to the user to assist in providing quality I/O routing. It can be configured to provide V-fades in the event of data errors or abrupt level changes caused by wiring or routing changes. It can also be configured to synchronize the output timing to match an internal reference that is available to all modules in the S5000 frame.

Output Grouping

To allow flexibility and convenience, the DA5320 can be configured to group output signals with multiple channels having their configuration parameters modified simultaneously. There are three different signal groupings available in the DA5320 that are set under the output grouping menu **OutGrp**.

- a. Independent **IndP** - Each channel's parameters are set individually.
- b. Pair - **PAIR** - Output pairs (as defined by the output settings) have their parameters set together. When the PAIR mode is active, only the odd channels will appear as available menu selections when toggling through the menu.
- c. All - **All** - All outputs are simultaneously set for the same parameter. When the ALL mode is active, toggling through channels on the menu is disabled.

OctaBus™ ID Assignment

To accurately identify the signals being put onto the OctaBus™ from multiple modules having eight outputs, each module must have a unique module ID. This module ID is defined via the **ob:ID** menu selection which is available as a submenu from the **obus** main menu item. The default ID for unconfigured modules is (1). If Octabus is not enabled or is not being utilized, multiple modules in a system having identical Octabus ID's is acceptable.

Anytime the channel designation requires an OctaBus™ ID, the display will show a decimal between the last two characters - the next to last character being the OctaBus™ ID and the last character being the channel number on the module specified by that OctaBus™ ID.

Output Channel Assignment/Mixing/Gain Control

The **OP:Ab** sub-menu item is used to configure the routing matrix of defined inputs to specific physical output connectors and the mixing operation of the DA5320. It is located under the **OP** main menu item. When the **OP:Ab** menu item is initially selected, it displays the current mix selection for the selected output.

This menu item also allows selection of which channels are to be mixed to create the specified output. When the **OP:Ab** screen that follows the **OP:Ab** menu item has data entered into it, the actual channels to be mixed will be defined. If the data entered is 1:5.6, then Output 1 will consist of equal parts of input channels 5 and 6 (50% gain on each channel). If the data entered into **OP:Ab** were 1:5.-, then Output 1 would consist of only input channel 5 (“-” is the selection for redundant input) with unity gain on channel 5.

The DA5320 is capable of much greater flexibility in its mixing operations when controlled via the serial port on the rear of the S5000 frame. If a mix has been defined in this manner that is not able to be displayed through the front panel selection, the display will show **RE** indicating that the setting was made via the remote feature.

Each mixed signal may have a gain value applied to adjust the signal level sent to the output connector. The gain is adjusted via the **GA in** menu item under **OP** main menu selection by specifying the gain factor for each output channel. The gain can be adjusted in 1 dB increments.

V-fades

The V-fade parameter enables the DA5320 to conceal AES framing errors that occur upstream due to asynchronous switching or signal interruptions. With V-fade enabled, fast error transitions (clicks and pops) are eliminated.

V-fades can be enabled through the **FEDE** menu item in Set-up.

Output Synchronization

The internal reference signal used for output synchronization is introduced into the frame through a connector on the rear panel of the S5000 Signal Management System frame labeled Video Reference. This reference is distributed throughout the frame by the CI5705 Communications Interface located above the power supplies. The reference signal can be

any valid NTSC or PAL video signal or AES Digital Audio. The DA5320 will match its output signal timing to be synchronized to this reference.

To have the DA5320 match its output signal timing to the internal reference the **REF** menu setting must be set to ON.

Reset Type/Initiation

Occasionally it may be necessary, or convenient, to clear the data stored in memory by resetting the DA5320. Because it may be desirable to erase only some of the data, there are six different Reset levels available in the DA5320. They are labeled Input, Output, ALL and Board. All reset options are accessed under the **RS** menu item.

- a. Input - **RS:IP** - resets the source of all inputs. Inputs will be set to the physical inputs of the module, 1=1, 2=2, 3=3, etc.
- b. Output - **RS:OP** - This type of reset clears all values stored defining the source of the signal connected to each output. All values will be set correlating the actual inputs of the module to its equivalent output, In 1 to Out 1, In 2 to Out 2, In 3 to Out 3, etc.
- c. ALL - **RS:AL** - This type of reset clears all stored values defining every parameter on the module. This is a combination of all the previously defined Reset functions.
- d. BOARD - **RS:BD** - This type of reset includes all the capabilities of the ALL reset but also toggles power to the board initiating the Power-On Self Test.

Diagnostic Data Display

If, at any time, the DA5320 encounters any anomalies with the data on the OctaBus, the red, ERROR LED will be illuminated in the front panel and an error message will be stored for display when the **DIAG** menu item is accessed. The OctaBus error categories to be reported under the **OBUS** menu item are

- A. OctaBus receive error 0 **REr0**
- B. OctaBus state error **cond**
- C. OctaBus receive error 1 **REr1**

To assist the technicians in the unlikely event of a service call, the **VER5** menu item will display the version number of the software used to program the DA5320.

Non-Volatile Configuration Parameter Storage

All configuration data can be stored in the FlashROM to preserve it in the event of a loss of power. On power-up, all settings will be returned to their previous settings. The save operation is initiated via the **SAVE** menu item.

MENU STRUCTURE

The following graphic display of the menu structure is provided to give the user an overall view of the commands that are accessible via the front panel controls. Detailed explanations of each parameter have been provided above. To access the menus from the Idle Display, press any button.

Note:  around character indicates character will be blinking - data entry mode active.

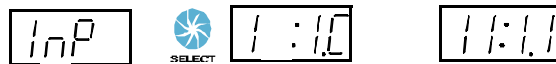
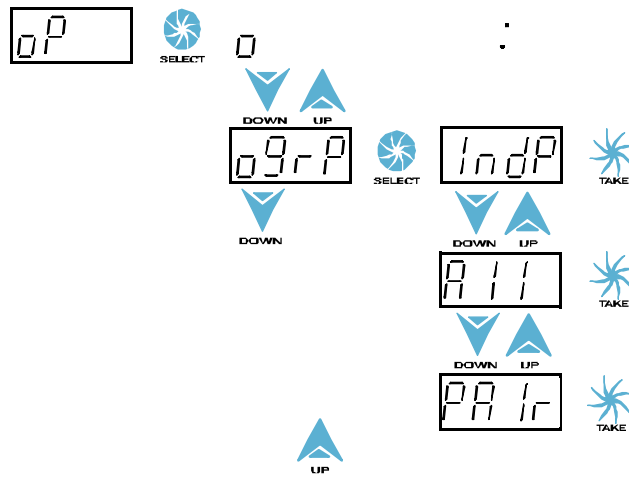

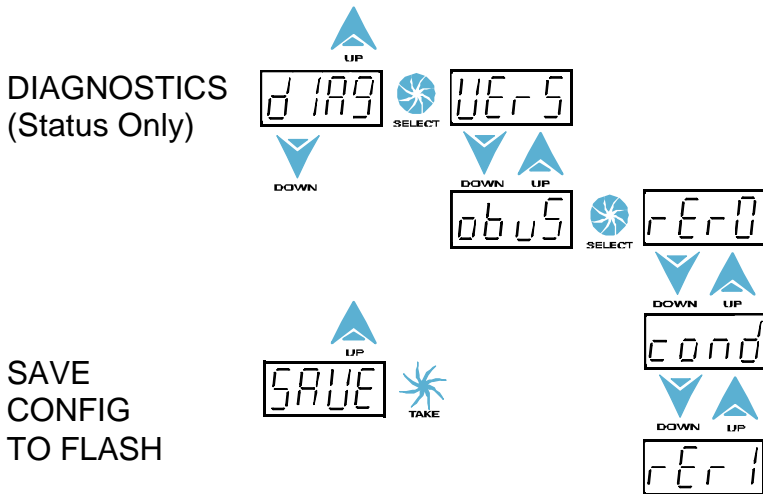
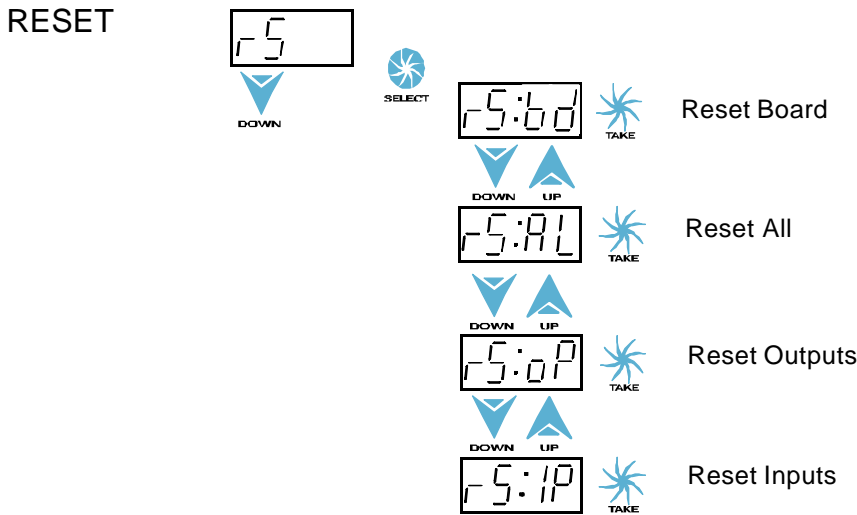
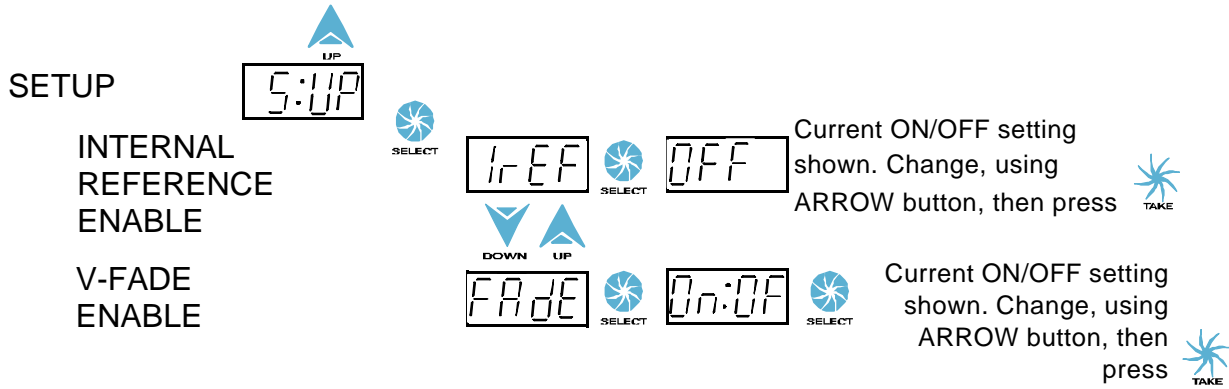

NOTES

Free Manuals Download Website

<http://myh66.com>

<http://usermanuals.us>

<http://www.somanuals.com>

<http://www.4manuals.cc>

<http://www.manual-lib.com>

<http://www.404manual.com>

<http://www.luxmanual.com>

<http://aubethermostatmanual.com>

Golf course search by state

<http://golfingnear.com>

Email search by domain

<http://emailbydomain.com>

Auto manuals search

<http://auto.somanuals.com>

TV manuals search

<http://tv.somanuals.com>