

SilverCrest KH 2450

DIGITAL VOICE RECORDER



Operating Instructions

ID-Nr.: KH2450 10/2008 V2

KOMPERNASS GMBH
BURGSTRASSE 21
D-44867 BOCHUM

www.kompernass.com



Contents

Contents	4
1. Intended use	6
2. Technical Data	6
Power supply	6
Memory	6
3. Safety Instructions	6
4. Items supplied	9
5. Operating elements, connections and displays	9
5.1 Front	9
5.2 Left	9
5.3 Top	10
5.4 Right	10
5.5 Bottom	10
5.6 Bottom	10
6. Preparing the voice recorder for use	10
7. Using the voice recorder	14
7.1 Switching the voice recorder on	14
7.2 Switching the voice recorder off	16
7.3 Recording dictation	16
7.4 Playback of recorded dictation	18
7.5 Options during playback	19
7.5.1 Stopping the playback	19
7.5.2 Adjusting the playback sound volume	19
7.5.3 Adjusting the playback speed	20
7.5.4 Fast forward/rewind	20
7.6 Handling recorded dictations	22
7.6.1 Overwriting passages in a recorded dictation	22
7.6.2 Inserting a passage into a recorded dictation	22
7.7 Deleting recorded dictations	23
7.7.1 Completely deleting recorded dictations	24
7.7.2 Partially deleting recorded dictations	25
8. Further functions and adjustments of the voice recorder	27
8.1 Activating/deactivating the key lock	27
8.2 Selecting a folder for saving dictation recordings	27
8.3 Provide dictation recordings with references	29
8.4 Using memory cards instead of the device internal storage system	33
8.5 Switching voice activation on/off	34

SilverCrest

Warranty

Digital Voice Recorder KH 2450

To ensure you receive a free repair procedure, please contact us via our Service-Hotline. Ensure that you have your sales slip handy.

GB **DES Ltd**

Tel.: 0870/787-6177
Fax: 0870/787-6168
e-mail: support.uk@kompennass.com

IE **Irish Connection**

Tel: 00353 (0) 87 99 62 077
Fax: 00353 18398056
e-mail: support.ie@kompennass.com

Sender, please write clearly:

www.mysilvercrest.de

Last Name: _____

First Name: _____

Street Address: _____

Postal Code/City: _____

Country: _____

Telephone: _____

Date/Signature: _____

Description of the defect: _____

Fill in this section and submit it with the device!

8.6	Microphone sensitivity.....	36
8.7	Using the voice recorder as a PC microphone.....	38
8.8	Switch-off options.....	40
8.9	Switching audio signals on/off.....	42
8.10	Adjusting the illumination	44
8.11	Selecting the recording mode	46
8.12	Setting the date and time	47
8.13	Resetting the internal dictation counter.....	49
8.14	Returning the voice recorder to factory settings.....	51
8.15	Formatting the internal memory of the voice recorder	52
8.16	Changing the display language.....	54
8.17	Display the version number of the Firmware.....	56
9.	Maintenance	58
9.1	Changing the batteries/cells	58
9.2	Recharging cells in the battery compartment of the voice recorder	58
10.	Copying dictation recording from the voice recorder to a PC	60
10.1	Installing the software »Convert« onto a PC.....	61
10.2	Using the software »Convert«.....	63
10.3	Deinstalling the software »Convert« from a PC	67
11.	Connecting ancillaries to the voice recorder.....	68
11.1	Connecting headphones to the voice recorder.....	68
11.2	Connecting an external microphone to the voice recorder.....	69
12.	Cleaning the voice recorder	69
13.	Troubleshooting	69
13.1	The voice recorder indicates no functions	69
13.1.1	With cell/battery operation	69
13.1.2	With mains power operation	70
13.1.3	With connection of the voice recorder to a PC via a USB-cable (USB operation)	70
13.2	Voice recorder has crashed/input not possible.....	70
13.3	Error messages	71
13.4	Other Malfunctions.....	71
14.	Disposal	72
14.1	Device.....	72
14.2	Batteries/Cells.....	72
14.3	Packaging materials.....	72
15.	Warranty and Service	72
16.	Importer	73

1. Intended use

The digital voice recorder SilverCrest KH 2450 is intended exclusively for the recording, storage and playback of dictations. This dictation device is not intended for utilisation in commercial or industrial applications. No warranty claims will be approved for damage resulting from improper use!

2. Technical Data

Power supply

Battery operation: 2 Batteries of Type AA/LR06

Mignon 1.5 V or 2 Cell Type AA/Mignon 1.2 V

Mains operation: 5 V DC, 0.5 A, Polarity: ⊖ ⊕

Memory

Internal memory: 512 MB

Expandable memory: SD and MMC memory cards up to a capacity of 2 GB

3. Safety Instructions

Read the operating instructions carefully before using the device for the first time and preserve this booklet for later reference. Pass this booklet on to whoever might acquire the device at a future date.



DANGER!

Should moisture/water penetrate into the voice recorder, ...

- there is the risk of receiving an electric shock!
- it could be irreparably damaged!

Thus: Do not use or store the voice recorder . . .

- in moist environments!
- in close proximity to water! Additionally, never expose the voice recorder to spray water or rain.
- NEVER place water-filled receptacles on the voice recorder!

Exposure to extreme heat sources can lead to an overheating of the voice recorder and to the melting of plastic parts. This could irreparably damage the voice recorder, and there is the additional risk of a fire! Thus:

- Never place the voice recorder directly adjacent to sources of heat.
- Do not place any open fire sources – e.g. burning candles – on the voice recorder!
- Do not leave the voice recorder in a vehicle when the outdoor temperature is high.
Especially in summer the temperature inside a vehicle can become extremely high.
- Do not subject the voice recorder to direct sunlight or strong artificial light.

When operating the voice recorder on mains power use only a suitable and undamaged power adapter; Output voltage: 5 V DC, Output current: 500 mA, DC-Plug (Barrel plug) 1,0/3,0 mm (Inner/Outer diameter), Polarity DC-Plug: . Suitable power adapters are available in electronic and audio/video specialist shops. Should the voice recorder be used with an unsuitable or damaged power adapter there is the risk of you receiving an electric shock! Additionally, the voice recorder could be irreparably damaged!

Never attempt to recharge standard batteries in the battery compartment of the voice recorder! Essentially, only cells can be recharged. Never throw batteries/rechargeable cells into a fire! NEVER open batteries or cells, never solder or weld them! Should you do so, there is a risk of fire or explosion! Additionally, the voice recorder could become irreparably damaged.

Keep batteries and cells well away from children. Children could put batteries and cells into their mouth and swallow them. Should a battery or a cell be swallowed, seek medical assistance IMMEDIATELY!

In the event of a defect, NEVER attempt to repair the voice recorder or a power adapter yourself! There is a risk of receiving an electric shock! Instead, consult our service partner responsible for your country. The contact information for our service hotline can be found on the warranty card at the end of this operating manual.

Do not leave packaging material lying unattended. Plastic foils and bags and pieces of styropor etc. are not toys, they can be dangerous for small children. There is a risk of suffocation!



CAUTION!

Equipment connected to a power supply can be damaged during a thunderstorm. Thus:

- If working with mains power, always withdraw the plug from the power socket in the event of a thunderstorm.

→ The power socket should be close to the appliance and easily accessible at all times, so that the plug can be quickly removed in the event of danger.

The voice recorder could be irreparably damaged after a fall! Therefore, place the voice recorder only on firm, level and non-slip surfaces.

The voice recorder can be irreparably damaged by leaking battery acids.

Thus: Remove all batteries and cells from the battery compartment if you are not planning to use the voice recorder for an extended period.. Regularly check the inserted batteries/cells. In the event of a leaking battery/cell: Put on a pair of protective gloves. Then clean the battery compartment and the contacts for the batteries/cells with a dry cloth.

This device is not intended for use by individuals (including children) with restricted physical, physiological or intellectual abilities or deficiencies in experience and/or knowledge unless they are supervised by a person responsible for their safety or receive from this person instruction in how the device is to be used. Children should be supervised to ensure that they do not play with the device. Otherwise, there is a risk of injury!

The voice recorder should not be used or stored in dusty environments. Dust particles could penetrate into the appliance. If large quantities of dust penetrate the voice recorder it could overheat and be irreparably damaged. There is also the risk of a fire!



NOTICE:

NEVER open the housing of the voice recorder! The voice recorder does not contain any user-serviceable components! If the housing of the voice recorder is opened, the warranty will become void!

Thus: In the event of a defect with your voice recorder contact our service hotline responsible for your locality! The contact information for our service hotline can be found on the warranty card at the end of this operating manual.

The voice recorder becomes warm when it is switched on. This is no cause for concern and does not indicate a technical problem.

For damage to the voice recorder that is a result of...

- improper use of the voice recorder,
- impact caused by falls,
- the effects of moisture, resp.
- water that has permeated into the voice recorder,
- the effects of heat/overheating,
- the utilisation of power adapters that do not conform to the specifications given in this operating manual,

- an attempt to recharge standard (non-rechargeable) batteries in the battery compartment of the voice recorder,
 - opening of the voice recorder housing, and
 - attempts at repair effected by non-qualified personnel,
- no liability/warranty will be accepted!
-

4. Items supplied

- Digital Voice Recorder SilverCrest KH 2450
 - 2 × Batteries (Type AA/Mignon 1.2 V)
 - Storage case
 - USB-Cable for connection of the voice recorder to a PC
 - CD-ROM with the software »Convert«, for data transfer from the voice recorder to a PC
-

5. Operating elements, connections and displays





5.1 Front

- ① Display
- ② Function button A (for diverse adjustments; the respective function is shown in the display ① above the function button)
- ③ Function button B (as function button A)
- ④ Function button C (as function button A)
- ⑤ Function button D (as function button A)
- ⑥ Loudspeaker







5.2 Left

- ⑦ Jack socket »DC 5V 0.5 A« for a power adapter (not supplied)
- ⑧ Headphone jack »EAR « (for connecting headphones with a 3.5 mm jack plug to the voice recorder)

5.3 Top

- ⑨ Memory card slot » SD/MMC« (for SD/MMC memory cards)
- ⑩ Button »ON/OFF« (for switching the voice recorder on and off)
- ⑪ Microphone jack socket »MIC  « (for connecting an external microphone with a 3.5 mm jack plug)
- ⑫ Status lamp »DICT  «
- ⑬ Microphone »MIC  « (internal microphone of the voice recorder for dictation recording)

5.4 Right

- ⑭ Button » DICT«
- ⑮ Multi-function slider for the functions
 - » FFWD« (fast forward at playback)
 - » STOP« (stop dictation recording/playback)
 - » START« (start dictation recording/playback)
 - » REW« (fast rewind at playback)
- ⑯ Slider » HOLD« (Activate/Deactivate the key lock)

5.5 Bottom

- ⑰ USB interface » « (to connect the voice recorder to a PC)

5.6 Bottom

- ⑱ Battery compartment »OPEN/BATT  «
- ⑲ Button »RESET«

6. Preparing the voice recorder for use

- 1 Carefully remove the voice recorder from the packaging.
- 2 **Only for battery/cell operation:** Open the battery compartment ⑱ at the rear of the voice recorder. Insert ...
 - the two supplied cells, resp.,
 - two batteries of the type AA Mignon 1.2 V or
 - batteries of the type AA/LR06 1.5 V.

Be sure to insert the batteries/cells with their correct polarities. The correct polarity is indicated inside the battery compartment. When done, close and secure the battery compartment.

- 2 **Only for mains power operation:** Insert the DC plug (barrel plug) of a suitable power adapter into the socket »DC 5V 0.5A« ⑦ on the voice recorder. A power adapter is not supplied. Pay heed to the correct polarity of the DC plug. For this voice recorder, a suitable power adapter must have a positive polarity. Insert the plug of the power adapter into a mains power socket.

 **DANGER!**

For mains power operation of the voice recorder use exclusively a suitable power adapter; Output voltage: 5V DC, Output current: 500 mA, DC-Plug (Barrel plug) 1,0/3,0 mm (Inner/Outer diameter), Polarity DC-Plug: ⊖-⊕. Suitable power adapters are available in electronic and audio/video specialist shops. Should the voice recorder be used with an unsuitable power adapter, there is the risk of you receiving an electric shock! Additionally, the voice recorder could be irreparably damaged!

- 2 **Only for USB operation:** Check to ensure the PC is switched on. Insert the small plug of the supplied USB cable into the USB interface »!« ⑰ on the voice recorder. Insert the large plug of the USB cable into a free USB interface on your PC. If batteries/cells have not been inserted into the battery compartment of the voice recorder: **Immediately** switch the voice recorder on by pressing the button "On/Off" ⑩. If batteries/cells have been inserted into the battery compartment: Switch the voice recorder on **before** connecting it to the PC. If you do not, the voice recorder will switch over to PC operation and will be identified by the PC as a removable media. In PC operation, dictations from the voice recorder can be copied onto the PC; for this, see also chapter 10. »Copying dictation recording from the voice recorder to a PC«. However, in PC operation the voice recorder **cannot** be used for dictations. Additionally, in PC operation you cannot utilise the menu or any of the other adjustments for the voice recorder.
- 3 Switch the voice recorder on by pressing the button "On/Off" ⑩. In the display ① the battery selection screen appears:

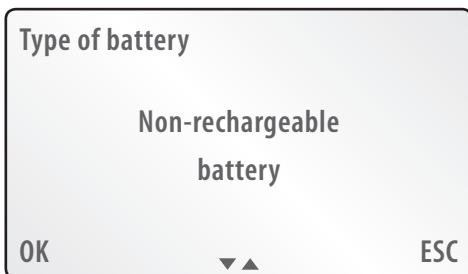

4 After pressing function button B ③/C ④, choose between the settings:

- Rechargeable battery
- Non-rechargeable battery

Select »Rechargeable battery« if you have inserted rechargeable batteries into the battery compartment.

Select »Non-rechargeable battery« if you have inserted standard non-rechargeable batteries into the battery compartment.

Also select »Non-rechargeable battery« if you wish to use the voice recorder ...

- with a power adapter (not supplied) connected to a mains socket.
- via a USB cable (supplied) connected to the USB interface.

On completion, and by pressing the function button D ⑤, select »OK« to confirm the adjustment. If you do not, the voice recorder will automatically select the adjustment »Non-rechargeable battery«.

DANGER!

Ensure absolutely that the correct adjustment has been selected. Otherwise, there is the risk that standard batteries, ones not suitable for recharging, could be recharged. In this case, there is the real risk of fire or an explosion!

In cases of doubt: Remove the batteries/cells from the battery compartment; check to confirm if they are standard batteries or rechargeable batteries. Then reinsert the batteries/cells into the battery compartment. Switch the voice recorder on then select the correct adjustment in the battery selection screen.

Alternatively, you can remove the batteries/cells from the battery compartment if you wish to use the voice recorder ...

- with a power adapter connected to a mains power socket
- via a USB cable connected to the USB interface on a PC.

NOTICE:



To carry out the steps 5 to 14 you have ca. 30 seconds for each. Otherwise, the adjustment of the time and date indicator breaks off. In this case, you can reach the adjustment data for the time and date indicators via the main menu. This is explained in chapter 8.12 »Setting the date and time«.

- 5 In the display ① the date/time setting screen is now indicated. First of all the hour indicator is marked. Adjust the hour indicator by selecting »▼«/»▲« with the function buttons B ③/C ④.
- 6 On completion, and by pressing the function button D ⑤, select »OK« to confirm the adjustment. The marking changes to the minute indicator.
- 7 Adjust the minute indicator by selecting »▼«/»▲« with the function buttons B ③/C ④.
- 8 On completion, and by pressing the function button D ⑤, select »OK« to confirm the adjustment. The marking changes to the date indicator.
- 9 Adjust the day indicator by selecting »▼«/»▲« with the function buttons B ③/C ④.
- 10 On completion, and by pressing the function button D ⑤, select »OK« to confirm the adjustment. The marking changes to the month indicator.
- 11 Adjust the month indicator by selecting »▼«/»▲« with the function buttons B ③/C ④.
- 12 On completion, and by pressing the function button D ⑤, select »OK« to confirm the adjustment. The marking changes to the year indicator.
- 13 Adjust the year indicator by selecting »▼«/»▲« with the function buttons B ③/C ④.
- 14 *Should you decide to once again change one of the settings:* By pressing the function button D ⑤ select »OK«. The marking then changes back to the hour indicator.

Alternatively: Subsequently select with the function button A ② »End«, to confirm all of the settings. Appearing briefly in the display ① ...

- the SilverCrest logo
- »INT«, should there not be a memory card inserted into the memory card slot ⑨; then the internal memory of the voice recorder is used for dictations.
- »EXT«, should there be an SD/MMC memory card inserted into the memory card slot ⑨ and this is being used for dictations.

As the software of the voice recorder is loading, the hourglass symbol is blended in briefly. Subsequently, the start screen is displayed. In the upper right corner of the display ① appears ...

- in battery/cell operation, the battery symbol ; the beams in the battery symbol indicate the current full resp. charged condition of the batteries.
- in mains power/USB operation the symbol .

The voice recorder is now ready for use.

7. Using the voice recorder

7.1 Switching the voice recorder on



- 1 To switch the voice recorder on: Press the button »ON/OFF« (10) once. The status lamp »DICT « (12) briefly lights up once. In the display (1) the SilverCrest logo is briefly shown; indicated subsequently are:
 - should the batteries/cells have been exchanged before switching on: the battery selection screen (see chapter 6 »Preparing the voice recorder for use«, step 3); the battery selection screen is **not** indicated if ...
 - the batteries/cells were not exchanged before switching on
 - the switched-off voice recorder is connected to a PC via a USB cable (PC operation)
 - subsequently the SilverCrest logo
 - »INT«, should there not be a memory card inserted into the memory card slot (9); in this case the internal memory of the voice recorder is used for dictations.
 - »EXT«, should there be an SD/MMC memory card inserted into the memory card slot (9); in this case the memory card is used exclusively as an external memory for dictation recording.

During software loading phases the hourglass symbol is blended in briefly.

Consequently, a short signal tone sounds and the start screen appears with the following indicators/menu choices:

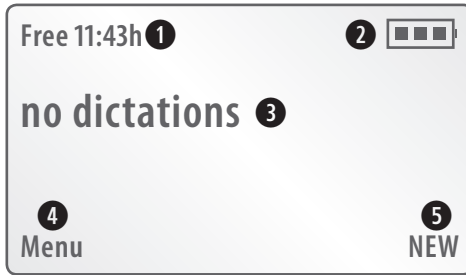
Should it be that no dictations have yet been saved:



- ① The amount of recording time currently available for dictations, e.g. »Free 11:43h«
- ② With battery/cell operation: the battery symbol ; the beams in the battery symbol indicate the current full resp. charged condition of the batteries. With mains power/USB operation: the symbol 
- ③ »no dictations«, insofar as no dictations have yet been saved
- ④ »MENU« (Selection of the main menu of the voice recorder, by using function button D ⑤, for adjusting the various functions of the voice recorder)
- ⑤ »NEW« (for effecting a new dictation)

Should dictations have already been saved:

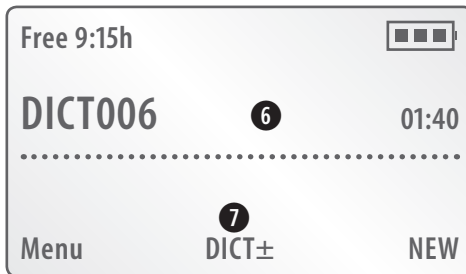

- ⑥ Name and length of the last saved dictation, e.g. »DICT006 01:40«
- ⑦ »DICT ±« (for selection of previously saved dictations by means of the function buttons B ③ and C ④)

7.2 Switching the voice recorder off

Hold the button »ON/OFF« (10) pressed down until »Off« appears in the display (1). The voice recorder then switches itself off.

7.3 Recording dictation

- 1 Switch the voice recorder on by pressing the button »ON/OFF« once.
As soon as the start screen is shown in the display (1):
- 2 Place the multi-function slider (15) at »STOP«.
- 3 Then select, by pressing the function button A (2), »NEW«. The voice recorder now allocates a new dictation reference with a successive number.

NOTICE:

Every new dictation recording is saved under a new, successive number. However, take note: The numbering of saved dictations does not subsequently change when you delete individual dictations.

→ EXAMPLE:

You start a new dictation recording. This is automatically assigned the number »DICT001«. At a later date you delete dictation recording »DICT001«. When you start a new dictation recording, this one is automatically assigned the next following number, »DICT002«, although the dictation with the prior number, »DICT001«, has been deleted.

You can however reset the dictate counter back to null. After the resetting of the counter, the subsequent dictations will again be automatically successively numbered, beginning at »DICT001«. The resetting of the internal counter for dictations is explained in chapter 8.13 »Resetting the internal dictation counter«.

However, the dictation recording does not start immediately, instead, at first it is in a pause-mode. The status lamp »DICT « (12) blinks; in the display (1) is indicated:

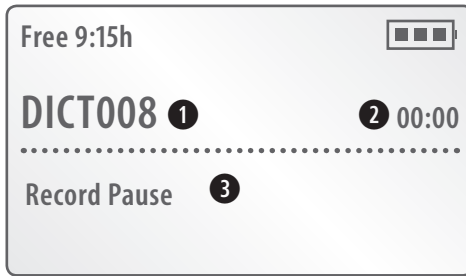

- ① The successive number of the new dictation recording, e.g. »DICT008«
 - ② The current length of the dictation recording (for new dictations that have not yet been started, always »00:00«)
 - ③ »Record Pause«
- 4 To start the dictation recording: Place the multi-function slider ⑮ at »▶ START«. In the display ① »Record« is indicated, then the dictation recording is started. During the dictation recording the lapsed period of the dictation recording is continuously indicated in the display ①. The status lamp »DICT Δ« ⑫ glows permanently during the dictation recording.

▶ NOTICE:

Every individual dictation recording can be up to three hours long (insofar as sufficient memory space is available). After three hours a new dictation recording is automatically initiated; thereby, the running dictation recording is not interrupted. The newly initiated dictation recording receives the same number as the original, but expanded by a letter. Example After a period of three hours of the dictation recording »DICT001«, the new dictation recording »DICT001A« is automatically initiated. In the display ① is indicated:



In accord with this pattern, after every further three hours additional dictations are automatically initiated (e.g. »DICT008B«, »DICT008C« etc.). For each of these an acoustic signal sounds.

- 5 When you wish to interrupt the dictation recording: Place the multi-function slider ⑮ at »⏏ STOP«. In the display ① »Record Pause« is indicated, the hitherto period of the dictation recording remains shown. For as long as the dictation recording is interrupted, the status lamp »DICT Δ « blinks.

To continue the dictation recording: Place the multi-function slider ⑮ back at »▶ START«.

- 6 When you wish to terminate the dictation recording: Press the button » Δ DICT« ⑭ once. The status lamp »DICT Δ « ⑫ goes out. In the display ① is indicated:

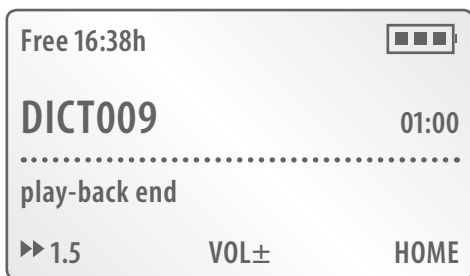

Now you can...

- play back the saved dictation recording. This is explained in the following chapter 7.4 »Playback of recorded dictation«.
- work on the saved dictation recording. This is explained in the following chapter 7.6 »Handling recorded dictations«.
- delete the dictation recording, either completely or partially. This is explained in the following chapter 7.7 »Deleting recorded dictations«.

7.4 Playback of recorded dictation

To play back saved dictations:

- 1 Switch the voice recorder on by pressing the button »ON/OFF« ⑩.
As soon as the start screen is shown in the display ①:
- 2 Place the multi-function slider ⑮ at »⏏ STOP«.

- 3 Should there be several dictations extant: Select the one you want by pressing the function buttons B ③/C ④ »DICT ±« to switch between the saved dictations. When the desired dictation recording is shown in the display ①:
- 4 Place the multi-function slider ⑮ at »▶ START«. The selected dictation recording is now played back. In the display ① is indicated:

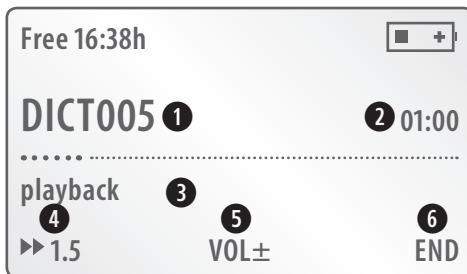

- ① The designation of the dictation recording being played back, e.g. »DICT005«
- ② The current playback time of the dictation recording
- ③ »play-back«
- ④ »▶▶ 1.5«: by pressing the function button D ⑤, change the playback speed by 1.5
- ⑤ »VOL ±« to adjust the playback sound volume
- ⑥ »END« to end the playback

7.5 Options during playback

7.5.1 Stopping the playback

To stop playback of a saved dictation recording: Place the multi-function slider ⑮ at »⏻ STOP«. Playback is stopped; in the display ① »play-back« is faded out. To continue playback: Place the multi-function slider ⑮ back at »▶ START«; playback is continued from the point where it had been stopped.

7.5.2 Adjusting the playback sound volume

During playback you can adjust the playback sound volume between the values of 00 (muted) and 15 (maximum volume).

To increase the playback sound volume: Press the function button B ③.:
With each press of the button you raise the playback sound volume by a step.
For a faster raising of the playback sound volume you can also hold down the function button B ③.

To reduce the playback sound volume: Press the function button C ④. With each press of the button you reduce the playback sound volume by a step. For a faster reduction of the playback sound volume you can also hold down the function button C ④.

The currently adjusted volume level is indicated for a few seconds in the display ①.

7.5.3 Adjusting the playback speed

The playback of saved dictation recordings can take place at two speeds:

- normal speed
- one and a half times speed

The standard factory setting is normal playback speed.

- 1 To switch to a one and a half times playback speed: Select it during playback by pressing the function button D ⑤ »▶▶ 1.5«. Playback now takes place at one and a half times normal speed.
- 2 To switch back to normal playback speed: Select it by pressing the function button D ⑤ »▶▶ 1.0«. Playback now takes place again at normal speed.

7.5.4 Fast forward/rewind

NOTICE:

During fast forward/rewind there is no sound playback.

To select passages of the dictation recording in fast forward during playback:

- 1 Place the multi-function slider ⑮ at »▶▶ FFWD« and hold it in this position; in the display ① is indicated:

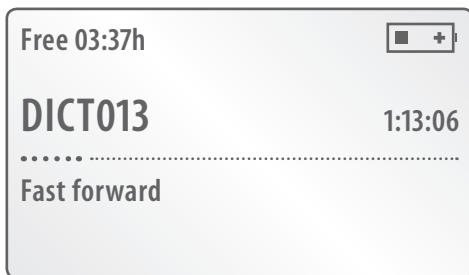

During fast forward the actual playback period of the dictation recording is continuously indicated in the display ①.

- 2 As soon as you have reached the desired passage in the dictation recording: Release the multi-function slider ⑮.
- 3 Should you wish to continue playback from the selected passage: Place the multi-function slider ⑮ back at »▶ START«.

To select passages of the dictation recording in fast rewind during playback:

- 4 Place the multi-function slider ⑮ at »◀ REW◀ and hold it in this position; in the display ① is indicated:

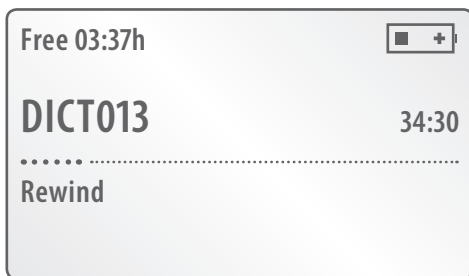

During fast rewind the actual playback period of the dictation recording is continuously indicated in the display ①.

- 5 As soon as you have reached the desired passage in the dictation recording: Release the multi-function slider ⑮. Playback is now automatically continued from the selected passage.

7.6 Handling recorded dictations

7.6.1 Overwriting passages in a recorded dictation

You can amend saved dictations at any point; for this, simply start a new dictation recording at the desired point:

- 1 Switch the voice recorder on by pressing the button »ON/OFF« (10). As soon as the start screen is shown in the display (1):
- 2 Place the multi-function slider (15) at »STOP«.
- 3 Should there be several dictations extant: Select the one you want by pressing the function buttons B (3)/C (4) »DICT ±« to switch between the saved dictations. When the designation of the dictation recording to be amended is shown in the display (1):
- 4 Place the multi-function slider (15) at »START«. The selected dictation recording is now played back. As soon as the point is played back at which you wish to amend the dictation recording:
- 5 Press the button »DICT« (14); as soon as »Record« is indicated in the display (1) you can start your new dictation recording. During the dictation recording the lapsed period of the dictation recording is continuously indicated in the display (1). The status lamp »DICT« (12) glows permanently during the dictation recording.
- 6 When you wish to interrupt the dictation recording: Place the multi-function slider (15) at »STOP«. In the display (1) »Record Pause« is indicated, the hitherto period of the dictation recording remains shown. For as long as the dictation recording is interrupted, the status lamp »DICT« (12) blinks.

To continue the dictation recording: Place the multi-function slider (15) back at »START«.

- 7 When you wish to terminate the dictation recording: Press the button »DICT« (14) once. The status lamp »DICT« (12) goes out.

7.6.2 Inserting a passage into a recorded dictation

- 1 Switch the voice recorder on by pressing the button »ON/OFF« (10). As soon as the start screen is shown in the display (1):

- 2 Should there be several dictations extant: Select the one you want by pressing the function buttons B ③/C ④ »DICT ±« to switch between the saved dictations. When the designation of the dictation recording to be amended is shown in the display ①:
- 3 Place the multi-function slider ⑮ at »▶ START«. Should »play-back end« be indicated in the display: Select, by pressing the function button A ② »HOME«. The selected dictation recording is now played back; in the display ① »play-back« is indicated. As soon as the position is played back at which you would like to insert a passage into the dictation recording:
- 4 Place the multi-function slider ⑮ at »Ⓢ STOP«.

NOTICE:

If you would like to continue a saved dictation recording (i.e. add a passage at the end of a dictation recording): Approx. two seconds before the end of playback place the multi-function slider ⑮ at »Ⓢ STOP«.

- 5 Press the button »△ DICT« ⑭; in the display ① »Record Pause« is indicated and the status lamp »DICT △« ⑫ blinks.
- 6 By pressing the function button D ⑤ select »INS«. In the display ① »Insert Pause« is indicated.
- 7 Place the multi-function slider ⑮ at »▶ START«. As soon as the display ① indicates »Insert« you can begin with the insertional dictation recording. The hitherto period of the insertional dictation recording is permanently shown in the display ①. The status lamp »DICT △« ⑫ glows permanently during the dictation recording.
- 8 When you wish to terminate the insertional dictation recording: Place the multi-function slider ⑮ at »Ⓢ STOP«. The status lamp »DICT △« ⑫ blinks. Then press the button »△ DICT« ⑭ once again; the status lamp »DICT △« ⑫ goes out. The new dictation recording is now inserted into the already extant dictation recording.

7.7 Deleting recorded dictations

Previously saved dictation recordings can be...

- completely or
- partially (i.e. just a passage in a dictation recording) deleted. To do this:

- 1 Switch the voice recorder on by pressing the button »ON/OFF« (10).
As soon as the start screen is shown in the display (1):
- 2 Place the multi-function slider (15) at »(7) STOP«.
- 3 Should there be several dictations extant: Select the one you want by pressing the function buttons B (3)/C (4) »DICT ±« to switch between the saved dictations. In our example we are dealing with a dictation recording designated with the number 010. When the designation of the dictation recording to be changed is indicated in the display (1):
- 4 Select, by pressing the function button D (5), »Menu«. In the display (1) is indicated:

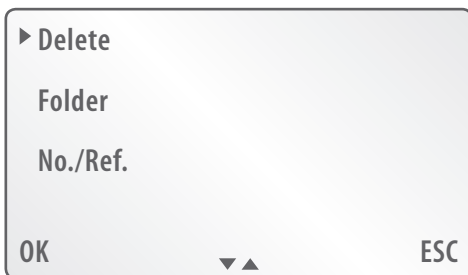

- 5 By pressing the function button D (5) select »OK«. In the display (1) is indicated:

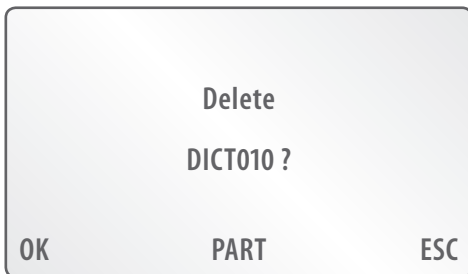

7.7.1 Completely deleting recorded dictations

To completely delete the selected dictation recording:

- By pressing the function button D ⑤ select »OK«. The dictation recording will now be deleted, subsequently, the Menu is once again indicated in the display ①.

7.7.2 Partially deleting recorded dictations

To partially delete the selected dictation recording:

- By pressing the function button B ③ or C ④ select »PART«. In the display ① is indicated:

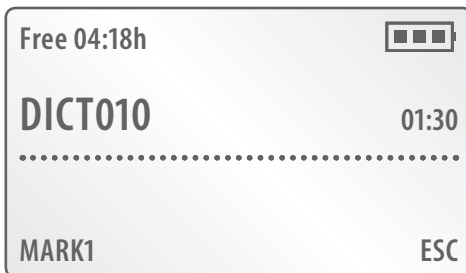

- Place the multi-function slider ⑮ at »▶ START«. Should »play-back end« be indicated in the display: Select, by pressing the function button A ② »HOME«. The selected dictation recording is now played back; at the start of the passage to be deleted from the dictation recording:
- Place the multi-function slider ⑮ at »▼ STOP«. Then, select by pressing the function button D ⑤ »MARK1«. In the display ① is indicated:

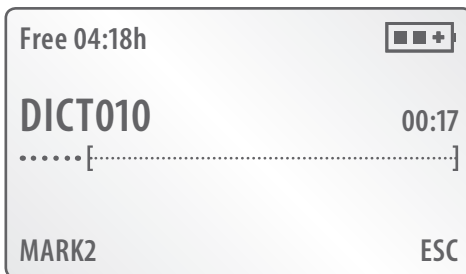

- 9 Place the multi-function slider (15) once again at »▶ START«. Should »play-back end« be indicated in the display: Select, by pressing the function button A (2) »HOME«. The selected dictation recording is now played back; at the end of the passage to be deleted from the dictation recording:
- 10 Place the multi-function slider (15) at »⏹ STOP«. Then select, by pressing the function button D (5), »MARK2«. In the display (1) is indicated:



- 11 Then select, by pressing the function button D (5), »DEL«. In the display (1) is indicated:

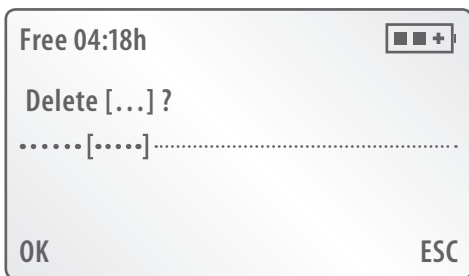

- 12 By pressing the function button D (5) select »OK«. The selected passage in the dictation recording is now deleted; subsequently, in the display (1) the start screen is once again shown.

8. Further functions and adjustments of the voice recorder

8.1 Activating/deactivating the key lock

This voice recorder is fitted with a key lock. With an activated key lock the voice recorder is protected against unintentional operation resp. being unintentionally switched on.

To activate the key lock: Place the slider »◀HOLD« (16) in the direction of the arrow, as shown in Fig. 1.



Fig. 1: Activate the key lock

In the display (1) »Keys locked« is faded in briefly. With the exception of the slider »◀HOLD« (16), all keys and the multi-function slider (15) are now locked.

To deactivate the key lock: Place the slider »◀HOLD« (16) in the direction of the arrow, as shown in Fig 2.



Fig. 2: Deactivate the key lock

8.2 Selecting a folder for saving dictation recordings

Dictations are saved at the top memory level of the voice recorder. Alternatively, dictations can also be saved in one of five folders in the voice recorder. This offers the possibility to separately store dictations from differing fields (e.g. private, commercial). For this, in the Menu of the voice recorder five automatically placed folders (A to E) are available. The folder required for saving a dictation recording must be selected before beginning the dictation.

To do this:

- 1 Switch the voice recorder on by pressing the button »ON/OFF« ⑩.
As soon as the start screen is shown in the display ①:
- 2 Place the multi-function slider ⑮ at »STOP«.
- 3 Then select, by pressing the function button D ⑤, »Menu«. In the display ① is indicated:

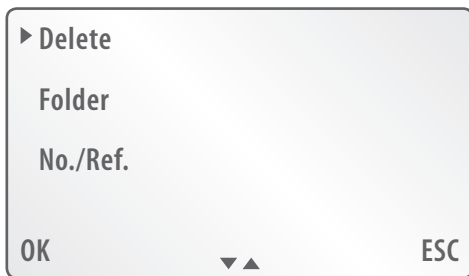

- 4 Select, by pressing the function button C ④, »Folder«. Subsequently select, by pressing the function button D ⑤, »OK«. In the display ① is indicated:

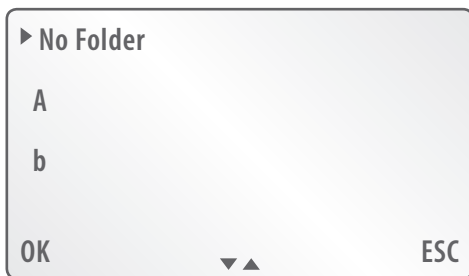

- 5 Select, by pressing the function buttons B ③ or C ④, one of the Folders, A to E. Subsequently select, by pressing the function button D ⑤ »OK«. In the display ① the Menu is once again shown; to return to the start screen: Select, by pressing the function button A ② »ESC«. The letter of the selected folder is indicated in the upper right corner of the start screen; in the following illustration, folder »A« has been selected:



8.3 Provide dictation recordings with references

Dictation recordings that you save onto the voice recorder can be provided with a reference. References can be serial numbers or freely selectable combinations of numbers, letters and characters. References can be useful to make dictations easier ...

- to allocate to specific subject areas
- to differentiate between themselves.

References do not appear in the display ① of the voice recorder; they are indicated in the column »No./Ref« of the software »Convert« (see Fig. 3). Information regarding the installation and utilisation of the software »Convert« is to be found in the chapters ...

- 10.1 »Installing the software »Convert« onto a PC«
- 10.2 »Using the software »Convert«

To allocate references to dictations, a choice of three possibilities is available:

- NR on: Enter in ones own reference (e.g. »Notice«). The reference entered in will be used for all following dictation recordings.
- NR off: The voice recorder allocates no reference numbers for new dictation recordings.
- NR auto: Automatic references; with this, the voice recorder allocates, additional to the entered reference (e.g. »Notice«), a consecutive reference number (1, 2, 3...) for every new dictation recording, see Fig. 3.

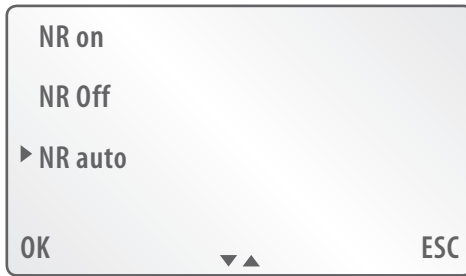

- 5 Select, by pressing the function buttons B ③ or C ④, the preferred programming. Subsequently select, by pressing the function button D ⑤, »OK«.

Should you have selected »NR off«: In the display ① the programming Menu is once again shown. to return to the start screen: Select, by pressing the function button A ② »ESC«.

Should you have selected »NR on« or »NR auto«, to enter in an own reference to all following dictation recordings:

- 6 In the display ① the input-screen is shown:

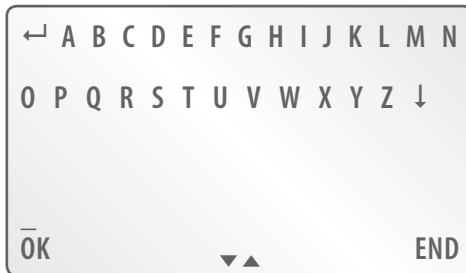

- 7 Initially, the symbol ← is marked. Shift this marking to the first letter of the reference-name to be entered in. To do this, select »▼«/»▲«, by pressing the function buttons B ③/C ④. As soon as the required letter is marked: By pressing the function button D ⑤ select »OK«. If you wish to enter in figures or characters: Shift the marking to the symbol ↓; Then select, by pressing the function button D ⑤, »OK«. In the display ① the input-screen shows the selection of figures/characters available:

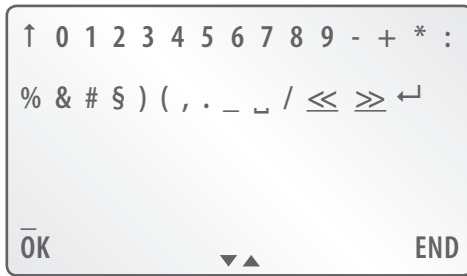

Select the figures and characters as per letters. All letters/figures/characters appear in the order of their input into the display ① above »OK«. The position at which your next input will be placed is marked by the cursor »_«. Should you wish to move the cursor to a specific position in your reference (to delete/enter): Shift the marking to the symbols << or >>. Then select, by pressing the function button D ⑤, »OK«. The cursor now moves itself back or forth by one position.

Should you wish to delete a letter/figure/character: Shift the marking to the symbol ↵; then select, by pressing the function button D ⑤, »OK«. With this your last entry is deleted.

Should you wish to return to the input-screen with letter selection: Shift the marking to the symbol ↑; then select, by pressing the function button D ⑤ »OK«.

When you have completed entry of the preferred reference: Select, by pressing the function button A ② »END«. In the display ① the programming Menu is once again shown. To return to the start screen: select, by pressing the function button A ② twice in succession »ESC«.

With immediate effect all new dictation recordings will be allocated the reference entered in by you.

NOTICE:

Your programming is only valid for the dictation recordings that are saved after this programming has been done. Dictations already saved on the voice recorder retain the references that were previously allocated to them.

8.4 Using memory cards instead of the device internal storage system

The internal memory of the voice recorder has a capacity of 512 MB available for use. Should there be a requirement for a larger memory capacity you can utilise memory cards of the types SD and MMC in the voice recorder. However, take note: Only memory cards with a maximum capacity of 2 GB can be used.

NOTICE:

Dictation recordings made with memory cards are saved exclusively to these. When using memory cards there is no access to the internal memory of the voice recorder.

Data cannot be transferred between the internal memory and the memory card - or the other way round.

Should you wish to use an SD/MMC memory card:

- 1 Slide the memory card into the memory card slot , as depicted on the rear of the voice recorder, until it engages. When sliding in the memory card use only light pressure.

NOTICE:

Should the memory card not, or not totally, allow itself to be slid into the memory card slot: Under no circumstances apply force! If you do, the card and/or the voice recorder could be irreparably damaged. Instead, remove the memory card. Check to see if . . .

- it is an SD/MMC memory card. Memory cards of other types cannot be used.
- you have possibly not inserted the memory card as per the illustration on the rear of the voice recorder.

If you insert the memory card with the voice recorder switched on, the SilverCrest logo appears briefly in the display . Subsequently, »EXT« is briefly indicated; then the start screen appears again. The indicated memory capacity for dictation recordings now refers to the memory card instead of the internal memory.

After insertion in the voice recorder the memory card must first of all be formatted. This also applies to pre-formatted memory cards.

NOTICE:

During formatting, ALL data that may be on the memory card will be deleted. If it contains data that you wish to retain, copy this data to another memory medium before commencing the formatting.

To do this:

- 2 Select, by pressing the function button D ⑤, »Menu«.
- 3 Select in the Menu, by pressing the function button C ④, the Menu item »Format«. Subsequently select, by pressing the function button D ⑤, »OK«. In the display ① »Format memory?« is indicated.
- 4 Select, by pressing the function button D ⑤, »OK«. Formatting of the memory card begins; during formatting the hourglass symbol is shown in the display ①. As soon as the formatting is complete, shown in the display ① is:

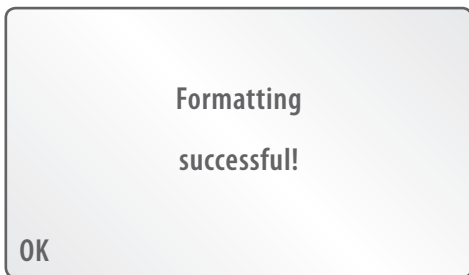

- 5 Select, by pressing the function button D ⑤, »OK«; formatting is now finished and the memory card can be utilised. In the display ① the Menu is once again shown; to return to the start screen: Select, by pressing the function button A ② »ESC«.

8.5 Switching voice activation on/off

With the function »voice activation«, a continuous dictation recording is interrupted whenever you make a pause in speaking. As soon as you continue to speak the dictation recording continues automatically. Using this benefit you can, especially with long dictations, save a lot of memory space.

To switch the function »voice activation« on:

- 1 Switch the voice recorder on by pressing the button »ON/OFF« ⑩.
As soon as the start screen is shown in the display ①:
- 2 Place the multi-function slider ⑮ at »STOP«.
- 3 Then select, by pressing the function button D ⑤, »Menu«. In the display ① is indicated:

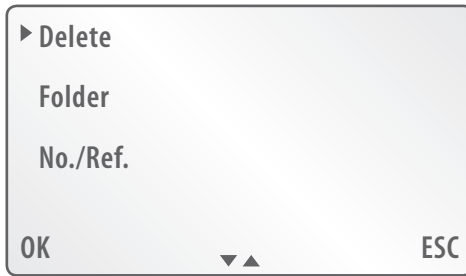

- 4 Select, by repeated pressing of the function button C ④, the Menu item »Settings«.
- 5 Then select, by pressing the function button D ⑤, »OK«. In the display ① is indicated:

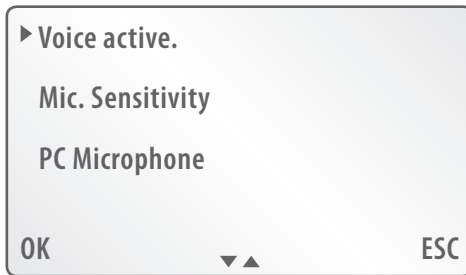

- 6 By pressing the function button D ⑤ select »OK«. In the display ① is indicated:

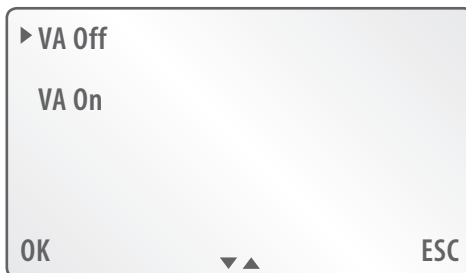

»VA« stands for »Voice Activation«.

- 7 Select, by pressing the function button C (4), »VA on«. Subsequently select, by pressing the function button D (5), »OK«. In the display (1) the Menu is once again shown; to return to the start screen: select, by pressing the function button A (2) twice in succession, »ESC«.

When voice activation is switched on, on the start screen and during dictation recordings »va« is indicated in the display (1):



To switch »voice activation« off: Follow the steps 1 to 6 in this chapter. Then select »VA off« in step 7 by pressing function button B (3).

8.6 Microphone sensitivity

The microphone in this voice recorder can be set to two sensitivity levels, »Dictation« and »Conference«:

- ➔ Select »Dictation« when the voice recorder is to be used for dictation recordings by a single speaker.
- ➔ Select »Conference« when conversations are to be recorded.

To programme the microphone sensitivity:

- 1 Switch the voice recorder on by pressing the button »ON/OFF« (10). As soon as the start screen is shown in the display (1):
- 2 Place the multi-function slider (15) at »(V) STOP«.
- 3 Then select, by pressing the function button D (5), »Menu«. In the display (1) is indicated:

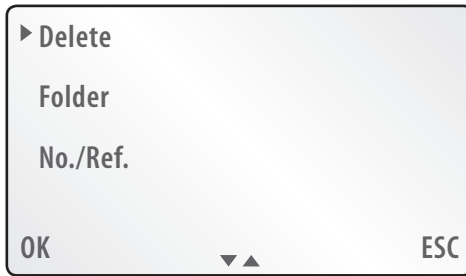

- 4 Select, by repeated pressing of the function button C ④, the Menu item »Settings«. Then select, by pressing the function button D ⑤, »OK«. In the display ① is indicated:

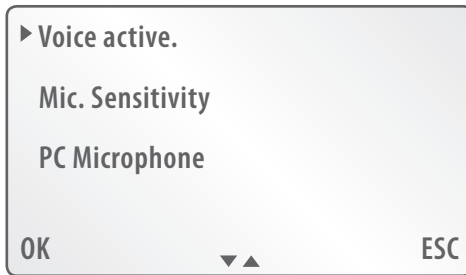

- 5 Select, by pressing the function button C ④ the Menu item »Mic. Sensitivity«. By pressing the function button D ⑤ select »OK«. In the display ① is indicated:

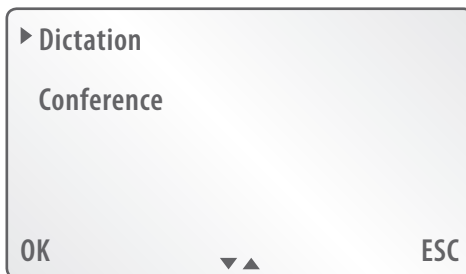

- Now select, by pressing the function buttons B (3) resp. C (4), »Dictation« or »Conference«. Subsequently select, by pressing the function button D (5), »OK«. The microphone sensitivity is now set to your personal selection; In the display (1) the Menu is once again shown. To return to the start screen: Select, by pressing the function button A (2) twice in succession, »ESC«.

8.7 Using the voice recorder as a PC microphone

This voice recorder can also, with the appropriate dictation/voice recognition software, be used as the microphone for a PC. For this you will require an audio cable with a 3.5 mm jack plug, available from specialist audio/video shops. To connect this voice recorder to a PC for utilisation as a microphone:

- Insert one of the 3.5 mm jack plugs on the audio cable into the headphone socket »EAR (8)« on the voice recorder.
- Insert the second 3.5 mm jack plug on the audio cable into the microphone socket of a PC.
- Switch the voice recorder on by pressing the button "On/Off" (10). As soon as the start screen is shown in the display (1):
- Place the multi-function slider (15) at »(7) STOP«.
- Then select, by pressing the function button D (5), »Menu«. In the display (1) is indicated:

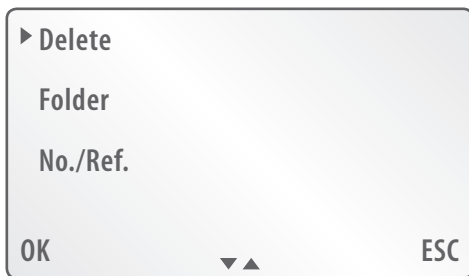

- Select, by repeated pressing of the function button C (4), the Menu item »Settings«. Then select, by pressing the function button D (5), »OK«. In the display (1) is indicated:

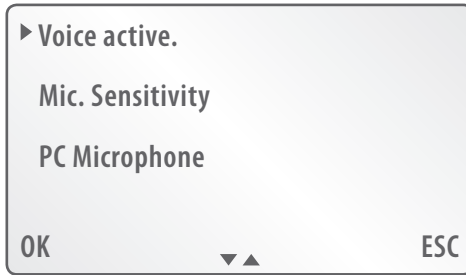

- 7 Select, by pressing the function button C ④, the Menu item »PC Microphone«. By pressing the function button D ⑤ select »OK«. In the display ① is indicated:

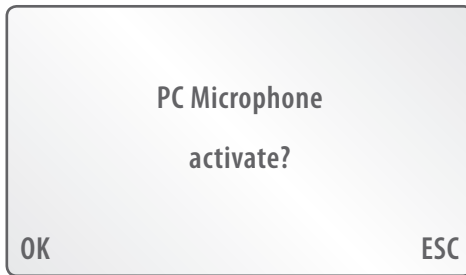

- 8 Select, by pressing the function button D ⑤, »OK«. In the display ① is indicated:

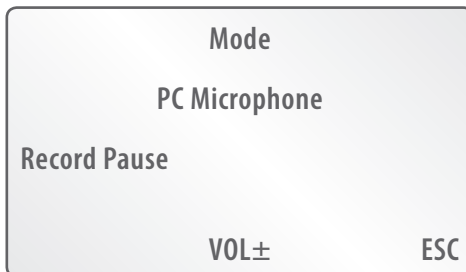

- 9 Start the dictation/voice recognition software on the PC to which the voice recorder is connected.

- 10** Place the multi-function slider ⑮ at »▷ START«; the voice recorder now functions as the microphone for the dictation/voice recognition software on the PC. In the display ① is indicated:

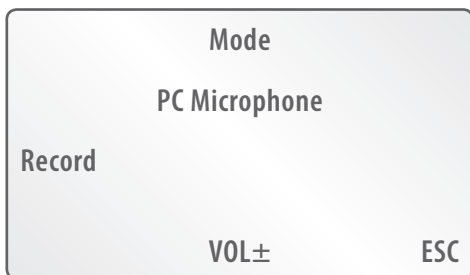

In the meanwhile you can adjust the record sound volume level between the values of 000 (muted) and 250 (maximum volume).

To increase the record sound volume: Press the function button B ③: With each press of the button you raise the record sound volume by a step. For a faster raising of the record sound volume you can also hold down the function button B ③.

To reduce the record sound volume: Press the function button C ④: With each press of the button you reduce the record sound volume by a step. For a faster reduction of the record sound volume you can also hold down the function button C ④.

The currently adjusted record volume level is indicated for a few seconds in the display ①.

To terminate PC microphone operation: Select, by pressing the function button A ②, »ESC«; In the display ① the Menu is once again shown. To return to the start screen: select, by pressing the function button A ② twice in succession, »ESC«.

8.8 Switch-off options

From the factory, this voice recorder is set so that after 10 minutes, and without a button being pressed, it switches itself off automatically. Additionally, it can be set so that ...

- ➔ it automatically switches itself off after 30 minutes without a button being pressed.
- ➔ it can only be manually switched off by pressing the button »ON/OFF« ⑩.

To carry out the settings:

- 1 Switch the voice recorder on by pressing the button »ON/OFF« ⑩.
As soon as the start screen is shown in the display ①:
- 2 Place the multi-function slider ⑮ at »▼ STOP«.
- 3 Then select, by pressing the function button D ⑤, »Menu«.
In the display ① is indicated:

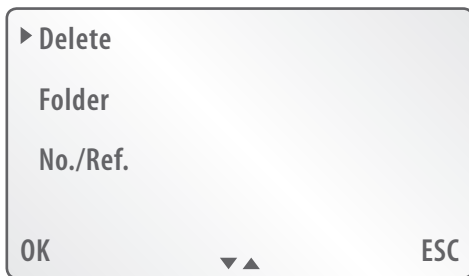

- 4 Select, by repeated pressing of the function button C ④, the Menu item »Settings«. Then select, by pressing the function button D ⑤ », OK«. In the display ① is indicated:

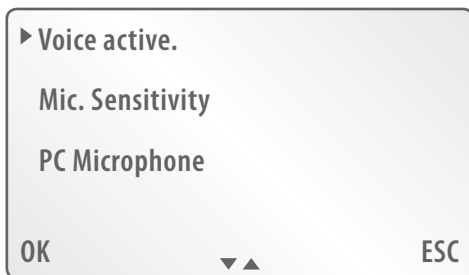

- 5 Select, by pressing the function button C ④, the Menu item »Power off«. By pressing the function button D ⑤ select »OK«. In the display ① is indicated:

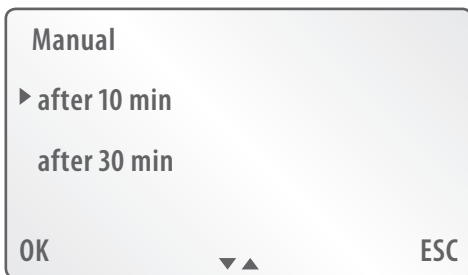

- 6 Select, by pressing the function buttons B ③ resp. C ④, your preferred setting. Subsequently select, by pressing the function button D ⑤, »OK«. In the display ① the Menu is once again shown. To return to the start screen: select, by pressing the function button A ② twice in succession, »ESC«.

8.9 Switching audio signals on/off

This voice recorder is equipped with two types of audio signals:

- Ack. beep (e.g. after switch-on of the voice recorder, as soon as the start screen is shown.)
- Audio warning (e. g. discharged batteries/cells)

From the factory all audio signals are switched on. However, you can separate both warning and ack. beep tones from each other manually, for switch-on and switch-off purposes. To do this:

- 1 Switch the voice recorder on by pressing the button »ON/OFF« ⑩.
As soon as the start screen is shown in the display ①:
- 2 Place the multi-function slider ⑮ at »STOP«.
- 3 Then select, by pressing the function button D ③, »Menu«. In the display ① is indicated:

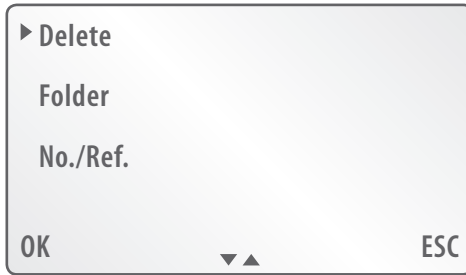

- 4 Select, by repeated pressing of the function button C (4), the Menu item »Settings«. Then select, by pressing the function button D (5) », OK«. In the display ① is indicated:

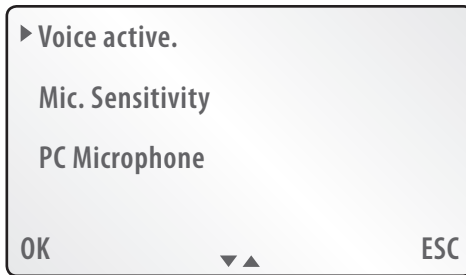

- 5 Select, by pressing the function button C (4), the Menu item »Audio signals«. Subsequently select, by pressing the function button D (5), »OK«. In the display ① is indicated:

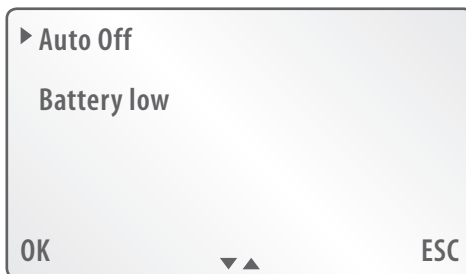

- 6 Select, by pressing the function button B ③ or C ④, the type of audio signal to be switched on/off. »Auto off« stands for Ack. beep, »Battery low« for audio warnings. Subsequently select, by pressing the function button D ⑤, »OK«. In the display ① is indicated:

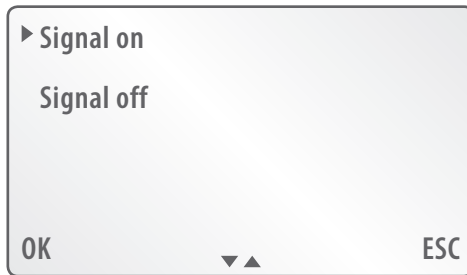

- 7 To switch off the signal tone type selected in step 6: Select, by pressing the function button B ③ or C ④, »Signal off«.
- To switch the signal tone type selected in step 6 back on: Select, by pressing the function button B ③ or C ④, »Signal on«.
- 8 Select, by pressing the function button D ⑤, »OK«. In the display ① the selection of the type of audio signal is now shown again. To return to the start screen: select, by pressing the function button A ② three times in succession, »ESC«.

8.10 Adjusting the illumination

The background illumination of the display can be adjusted so that ...

- it switches on with every press of a button and, after about ten seconds, automatically switches itself back off (Setting »auto«)
- remains permanently switched off (Setting »Off«)

From the factory, the setting is »auto«. To change the setting:

- 1 Switch the voice recorder on by pressing the button »ON/OFF« ⑩. As soon as the start screen is shown in the display ①:
- 2 Place the multi-function slider ⑮ at »STOP«.
- 3 Then select, by pressing the function button D ⑤, »Menu«. In the display ① is indicated:

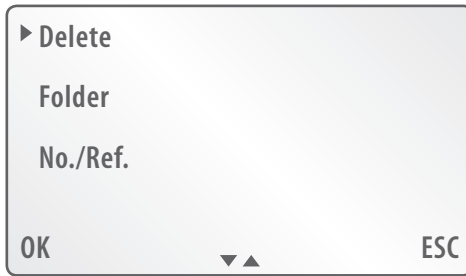

- 4 Select, by repeated pressing of the function button C ④, the Menu item »Settings«. Then select, by pressing the function button D ⑤, »OK«. In the display ① is indicated:

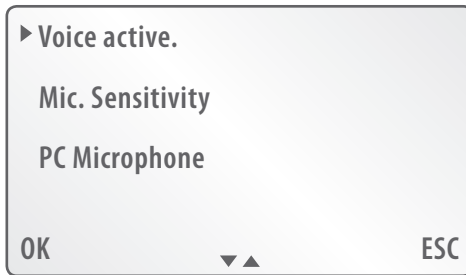

- 5 Select, by pressing the function button C ④, the Menu item »Illumination«. Subsequently select, by pressing the function button D ⑤, »OK«. In the display ① is indicated:

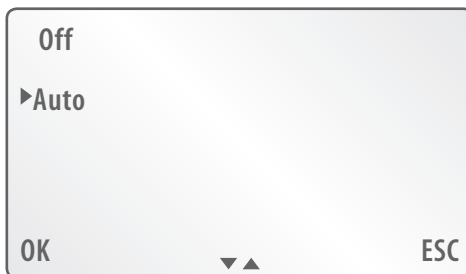

- 6 Select, by pressing the function button B ③ or C ④, »Off« or »Auto«. Subsequently select, by pressing the function button D ⑤, »OK«. In the display ① the programming Menu is once again shown. To return to the start screen: Select, by pressing the function button A ② twice in succession, »ESC«.

8.11 Selecting the recording mode

This voice recorder can record dictations with three varying sampling rates. The higher the sampling rate, the better the quality of the dictation recording; however, at the same time, the requirement for memory space for dictation recording rises accordingly.

Selection can be made from three sampling rates for dictations recordings:

- ➔ »HP« – highest quality level, dictations require a lot of memory space
- ➔ »SP« – standard quality level; optimal compromise between the demands on quality and memory space
- ➔ »LP« – lowest quality level; dictations require very little memory space; recommended for very long dictations

From the factory, »SP« is set as the sampling rate. To change the setting of the sampling rate:

- 1 Switch the voice recorder on by pressing the button »ON/OFF« ⑩.
As soon as the start screen is shown in the display ①:
- 2 Place the multi-function slider ⑮ at »STOP«.
- 3 Then select, by pressing the function button D ⑤, »Menu«.
In the display ① is indicated:

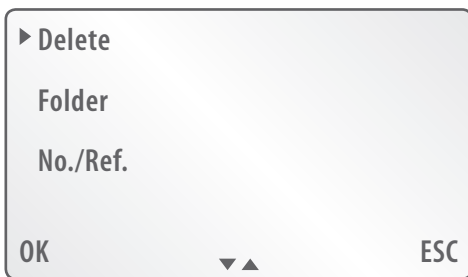

- 4 Select, by repeated pressing of the function button C (4), the Menu item »Settings«. Then select, by pressing the function button D (5), »OK«. In the display (1) is indicated:

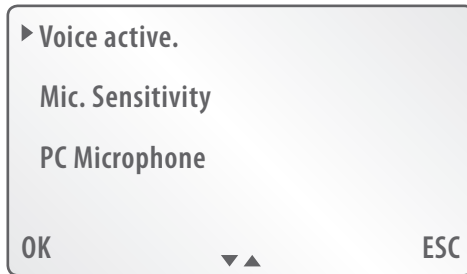

- 5 Select, by pressing the function button C (4), the Menu item »Rec. mode«. Subsequently select, by pressing the function button D (5), »OK«. In the display (1) is indicated:



- 6 Select, by pressing the function button B (3) or C (4), the required sampling rate. Subsequently select, by pressing the function button D (5), »OK«. In the display (1) the programming Menu is once again shown. To return to the start screen: select, by pressing the function button A (2) twice in succession, »ESC«.

8.12 Setting the date and time

Should it be ...

- you did not programme in the date and time when first taking the device into use, or
- wish to subsequently alter these settings

... you can do this as follows:

- 1 Switch the voice recorder on by pressing the button »ON/OFF« (10). As soon as the start screen is shown in the display (1):
- 2 Place the multi-function slider (15) at »(7) STOP«.
- 3 Then select, by pressing the function button D (5), »Menu«. In the display (1) is indicated:

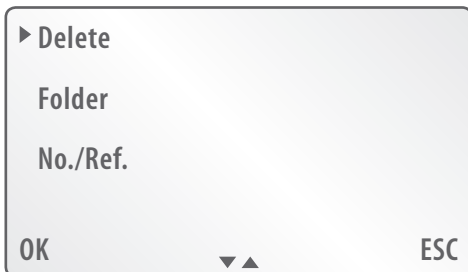

- 4 Select, by repeated pressing of the function button C (4), the Menu item »Settings«. Then select, by pressing the function button D (5), »OK«. In the display (1) is indicated:

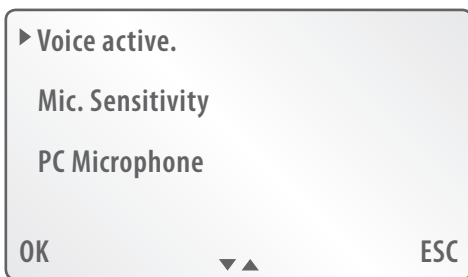

- 5 Select, by repeated pressing of the function button C (4) the Menu item »Time, Date«. By pressing the function button D (5) select »OK«. In the display (1) is indicated:

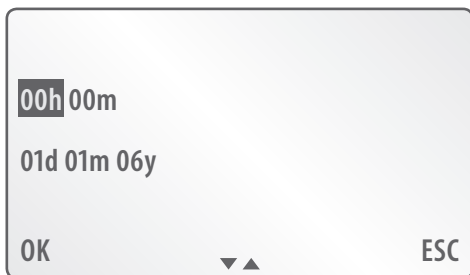

- 6 Carry out the steps 5 to 14 in chapter 6, »Preparing the voice recorder for use«.

To subsequently return to the start screen: Select, by pressing the function button A ② twice in succession, »ESC«.

8.13 Resetting the internal dictation counter

Every new dictation recording is saved under a new, consecutive number, beginning with »DICT001«. This numbering is automatically carried out by the internal dictation counter in the voice recorder. The numbering of saved dictations does not subsequently change when you delete individual dictations.

→ EXAMPLE:

You start a new dictation recording. This is automatically assigned the number »DICT001«. At a later date you delete dictation recording »DICT001«. When you start a new dictation recording, this one is automatically assigned the next following number, »DICT002«, although the dictation with the prior number, »DICT001«, has been deleted.

If you wish, that the next following dictation recordings begin their numbering again at »DICT001«: return the internal dictation counter back to null. To do this:

- 1 Switch the voice recorder on by pressing the button »ON/OFF« ⑩. As soon as the start screen is shown in the display ①:
- 2 Place the multi-function slider ⑮ at »STOP«.
- 3 Then select, by pressing the function button D ⑤, »Menu«. In the display ① is indicated:

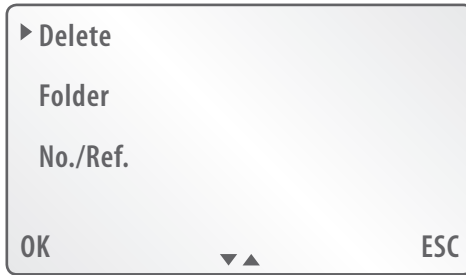

- 4 Select, by repeated pressing of the function button C ④, the Menu item »Settings«. Then select, by pressing the function button D ⑤, »OK«. In the display ① is indicated:

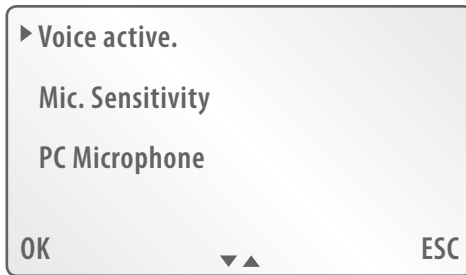

- 5 Select, by repeated pressing of the function button C ④, the Menu item »Dictation counter«. By pressing the function button D ⑤ select »OK«. In the display ① is indicated:

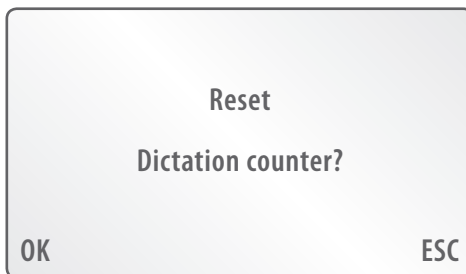

- By pressing the function button D (5) select »OK«. The dictation counter has now been returned to null. In the display (1) the programming menu is now once again shown. To return to the start screen: Select, by pressing the function button A (2) twice in succession, »ESC«.

8.14 Returning the voice recorder to factory settings

▶ NOTICE:

Take note that, in returning the device to factory settings, ALL of the setting entered in by yourself will be deleted.

If you wish to return the voice recorder back to factory settings:

- Switch the voice recorder on by pressing the button »ON/OFF« (10). As soon as the start screen is shown in the display (1):
- Place the multi-function slider (15) at »(7) STOP«.
- Then select, by pressing the function button D (5), »Menu«. In the display (1) is indicated:

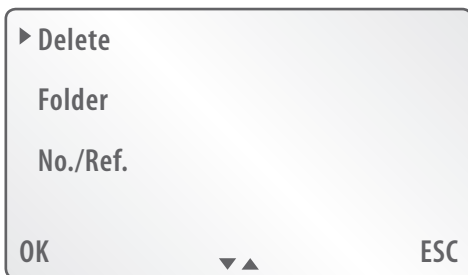

- Select, by repeated pressing of the function button C (4), the Menu item »Settings«. Then select, by pressing the function button D (5), »OK«. In the display (1) is indicated:

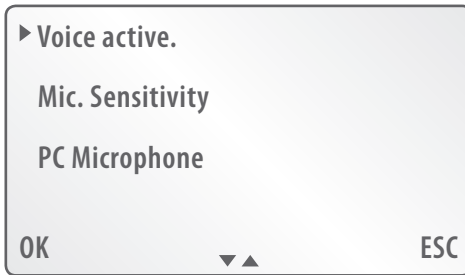

- 5 Select, by repeated pressing of the function button C ④, the Menu item »Factory setting«. By pressing the function button D ⑤ select »OK«. In the display ① is indicated:

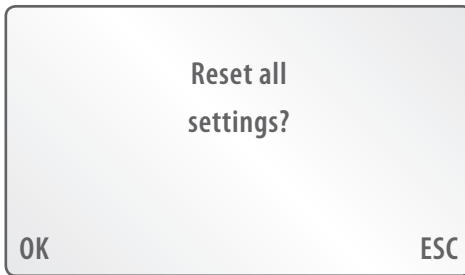

- 6 Select, by pressing the function button D ⑤, »OK«; the voice recorder has now been returned to factory settings. The display language is now English; In the display ① appears the language selection.
- 7 Select your preferred language by pressing the function buttons B ③ or C ④: Subsequently select, by pressing the function button D ⑤, »OK«. In the display ① the SilverCrest logo appears briefly, subsequently the start screen is shown.

8.15 Formatting the internal memory of the voice recorder

Should you frequently save and delete dictations, the access time to saved dictations could lengthen. In this case a formatting of the internal memory could be beneficial. Through this the access times could be shortened.

▶ NOTICE:

Please note: All dictation recordings saved in the internal memory of the voice recorder will be deleted by the formatting. If it contains data that you wish to retain, copy this data to another memory medium before commencing. For this you could use the supplied software »Convert«. For this, see also chapter 10. »Copying dictation recording from the voice recorder to a PC«.

To format the internal memory of the voice recorder:

- 1 Remove the memory card that may have been inserted into the memory card slot ⑨ of the voice recorder. To do this, press once on the upper edge of the memory card. Then remove the memory card from the memory card slot.

▶ NOTICE:

If you do not remove the memory card before formatting, the card will be formatted instead of the internal memory. In this case, all dictation recordings on the memory card will be deleted.

- 2 Switch the voice recorder on by pressing the button »ON/OFF« ⑩. As soon as the start screen is shown in the display ①:
- 3 Place the multi-function slider ⑮ at »STOP«.
- 4 Then select, by pressing the function button D ③, »Menu«. In the display ① is indicated:

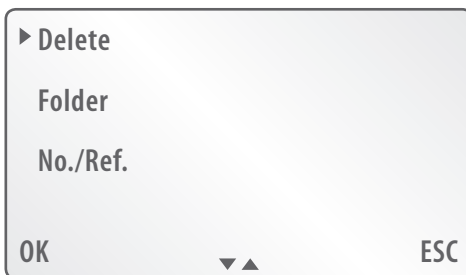

- 5 Select, by repeated pressing of the function button C ④ the Menu item »Format«. Then select, by pressing the function button D ⑤, »OK«. In the display ① is indicated:

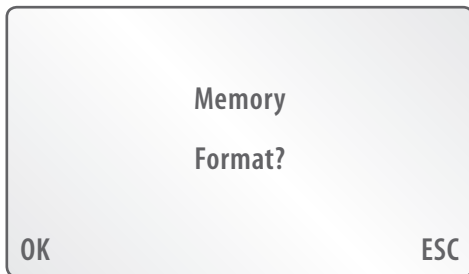

- 6 By pressing the function button D ⑤ select »OK«. Formatting of the internal memory begins; during formatting the hourglass symbol is shown in the display ①. As soon as the formatting is complete, shown in the display ① is:

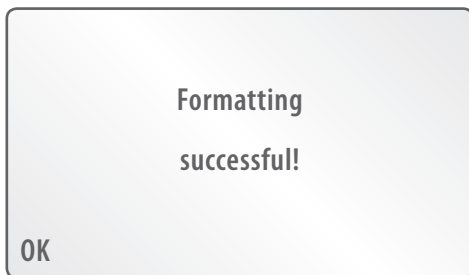

- 7 Select, by pressing the function button D ⑤, »OK«; the formatting is now complete.

The adjustments menu is now shown once again in the display ①. To return to the start screen: Select, by pressing function button A ②, »ESC«.

8.16 Changing the display language

This voice recorder can show all menus in the following languages:

- Danish (Dansk)
- German (Deutsch)
- English
- Finnish (Suomi)
- French (Français)
- Greek (Ελληνικά)
- Italian (Italiano)

- Croat (Hrvatski)
- Dutch (Nederlands)
- Norwegian (Norsk)
- Polish (Polski)
- Portugese (Português)
- Slovak (Slovenčina)
- Slovenian (Slovenski)
- Spanish (Español)
- Swedish (Svenska)
- Czech (Česky)
- Hungarian (Magyarul)

To change the display language:

- 1 Switch the voice recorder on by pressing the button »ON/OFF« (10). As soon as the start screen is shown in the display (1):
- 2 Place the multi-function slider (15) at »(17) STOP«.
- 3 Then select, by pressing the function button D (5), »Menu«. In the display (1) is indicated:

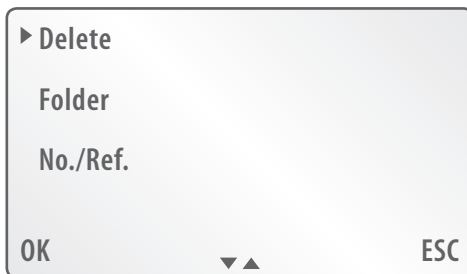

- 4 Select, by repeated pressing of the function button C (4), the Menu item »Settings«. Then select, by pressing the function button D (5), »OK«. In the display (1) is indicated:

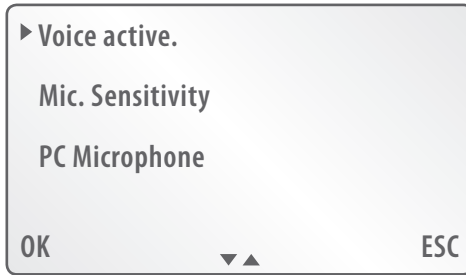

- 5 Select, by repeated pressing of the function button C ④, the Menu item »Language«. By pressing the function button D ⑤ select »OK«. In the display ① is indicated:

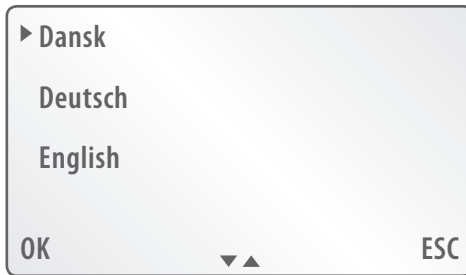

- 6 Select, by pressing the function buttons B ③ or C ④, the required language. Subsequently select, by pressing the function button D ⑤, »OK«. All menus will now be shown in the language you have selected.

In the display ① the programming menu is now once again shown. To return to the start screen: Select, by pressing the function button A ② twice in succession, »ESC«.

8.17 Display the version number of the Firmware

The term »Firmware« refers to the internal software in electronic devices. Should this voice recorder at some time in the future receive a Firmware-Update arranged by the importer: make available the version number of the Firmware that is installed on your voice recorder. The version number can be displayed as follows:

- 1 Switch the voice recorder on by pressing the button »ON/OFF« ⑩. As soon as the start screen is shown in the display ①:

- 2 Place the multi-function slider ⑮ at »**STOP**«.
- 3 Then select, by pressing the function button D ⑤, »Menu«. In the display ① is indicated:

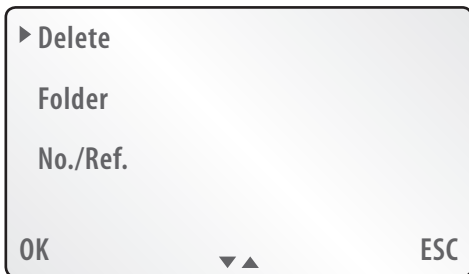

- 4 Select, by repeated pressing of the function button C ④, the Menu item »Settings«. Then select, by pressing the function button D ⑤, »OK«. In the display ① is indicated:

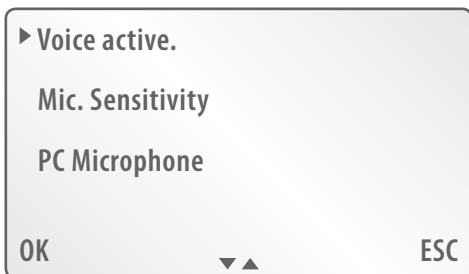

- 5 Select, by repeated pressing of the function button C ④ the Menu item »Version«. By pressing the function button D ⑤ select »OK«. In the display ① the version number is now displayed.
- 6 Subsequently select, by pressing the function button A ②, »ESC«; In the display ① the programming menu is now once again shown. To return to the start screen: Select, by pressing the function button A ② twice in succession, »ESC«.

9. Maintenance

9.1 Changing the batteries/cells

If the inserted batteries resp. cells are discharged, the battery symbol blinks in the display ①. An audio warning sounds, in the display ① »Low battery - Shutting down« is indicated. Subsequently, the voice recorder then switches itself off.

NOTICE:

Should this happen during a working dictation recording, cease it immediately. Otherwise, the dictation recording could be wholly or partly lost.

Change standard (non-rechargeable) batteries for new ones of the type AA/LR06/Mignon 1.5 V. Exchange drained cells for charged ones of the type AA/Mignon 1.2 V. Cells can also be charged in the battery compartment of the voice recorder; further information available in chapter 9.2 » Recharging cells in the battery compartment of the voice recorder.«

Alternatively, you can also adapt the voice recorder for mains power operation.

9.2 Recharging cells in the battery compartment of the voice recorder

Cells can be recharged in the battery compartment of the voice recorder when they are discharged. For this, the voice recorder must ...

- be connected to a mains power socket via a suitable power adaptor (not supplied), or
- be connected to a PC via the supplied USB cable.

DANGER!

Never attempt to recharge standard batteries in the battery compartment of the voice recorder! Essentially, only cells can be recharged. Otherwise, there is a risk of explosions or fire! Additionally, the voice recorder could become irreparably damaged.

When operating the voice recorder on mains power use only a suitable and undamaged power adapter; Output voltage: 5 V DC, Output current: 500 mA, DC-Plug (Barrel plug) 1,0/3,0 mm (Inner/Outer diameter), Polarity DC-Plug: ⊖-⊕. Suitable power adapters are available in electronic and audio/video specialist shops. Should the voice recorder be used with an unsuitable or damaged power adapter, there is the risk of you receiving an electric shock! Additionally, the voice recorder could be irreparably damaged!



To charge cells in the battery compartment ⑱:

a) via a power adapter (not supplied) connected to a mains power socket:

- 1 Insert the DC plug (barrel plug) of a suitable power adapter into the socket »DC 5V 0.5A« ⑦ on the voice recorder. Pay heed to the correct polarity of the DC plug. For this voice recorder, a suitable power adapter must have a positive polarity. Insert the plug of the power adapter into a mains power socket.

 **NOTICE:**





With many power adapters the polarity of the DC plug can be changed by replugging or reswitching. In a case of doubt, consult the operating handbook for the power adapter.

- 2 Switch the voice recorder on by pressing the button »ON/OFF« ⑩. In the display ① the symbol  appears briefly; afterwards, the battery symbol  blinks. As soon as the charging process begins, the battery symbol fills and empties itself continually. Should the charging process be interrupted, for a few seconds a completely charged battery symbol is shown; subsequently it indicates again the actual charge condition of the inserted batteries.
- 3 Ensure that the automatic switch-off of the voice recorder is deactivated. Check this under the Menu item »Power off« (see chapter 8.8 »Switch-off options«); for charging operations the setting »manual« must be selected. Bear in mind that the voice recorder in a switched-off condition cannot charge the batteries in the battery compartment.
- 4 When the inserted batteries are fully charged, the symbol  is indicated in the display ①. Remove the power adapter from the mains power socket; remove the DC plug of the power adapter from the socket »DC 5V 0.5A« ⑦ on the voice recorder.

b) via a USB cable connected to a PC:

- 1 Should the voice recorder be connected to a mains power source via a power adapter: Remove the power adapter from the mains power socket before connecting the voice recorder with a PC. Also remove the DC plug of the power adapter from the socket »DC 5V 0.5A« ⑦.
- 2 Switch the PC and the voice recorder on. If you do not, the voice recorder will switch over to PC operation and will be identified by the PC as a removable media. In PC operation cells are not charged in the battery compartment of the voice recorder. In PC operation, dictations from the voice recorder can be copied onto the PC; for this, see also chapter 10. »Copying dictation recording from the voice recorder to a PC«. However, in PC operation you cannot use

the voice recorder for dictation recordings. Additionally, in PC operation you cannot utilise the menu or any of the other adjustments for the voice recorder.

- 3 Insert the small plug of the supplied USB cable into the USB interface »« (17) on the voice recorder.
- 4 Insert the large plug of the USB cable into a free USB interface on your PC. In the display ① the symbol  appears briefly; afterwards, the battery symbol  blinks. As soon as the charging process begins, the battery symbol fills and empties itself continually. Should the charging process be interrupted, for a few seconds a completely charged battery symbol is shown; subsequently it indicates again the actual charge condition of the inserted batteries.
- 5 Ensure that the automatic switch-off of the voice recorder is deactivated. Check this under the Menu item »Power off« (see chapter 8.8 » Switch-off options«); for charging operations the setting »manual« must be selected. Bear in mind that the voice recorder in a switched-off condition cannot charge the batteries in the battery compartment.
- 6 When the inserted batteries are fully charged, the symbol  is indicated in the display ①. Remove the USB cable from the USB interface »« (17) on the voice recorder and the USB interface on the PC.

10. Copying dictation recording from the voice recorder to a PC

With the supplied software »Convert« you can copy saved dictation recordings from the voice recorder to a PC. Thereby, the dictation recordings are converted into Wave files (data ending .wav), which can be played back with standard commercial media players. The software can be installed and used on PCs complying with the following minimum requirements:

- Pentium III Processor, 500 MHz
- Operating systems ...
 - ... Windows® 2000
 - ... Windows® XP
 - ... Windows® Vista™
- USB 1.1 or 2.0

Before taking it into use ...

- ➔ the software must first of all be installed on the PC.
- ➔ the voice recorder must be connected with the supplied USB cable to a USB interface on the PC.

NOTICE:

The steps towards installing and using the software »Convert« will be shown for the case of the operating system Windows® XP. They are valid in a comparable form for the operating systems Windows® 2000 and Vista™.

Deactivate the anti-virus programme possibly installed on your PC before installing the software »Convert«. Otherwise, it could potentially cause problems with the installation. Absolutely remember to reactivate the anti-virus programme after the successful installation of the software »Convert«. In a case of doubt, consult the operating handbook for the anti-virus programme.

10.1 Installing the software »Convert« onto a PC

To install the software:

- 1 Switch the PC on and wait until the operating system has booted.
- 2 Installation of the software requires a minimum of 6 MB of free disc space on the hard drive.
- 3 Place the supplied CD-ROM into the CD-ROM drive of the PC to which you wish to copy dictation recordings from the voice recorder.

Should the function »AutoPlay« be activated on your PC: On the PC monitor a window opens automatically with the content of the CD-ROM.

If the function »AutoPlay« is not activated: Klick on »Start«, then on »My Computer«. Subsequently, double-click on the CD-ROM drive in which the CD has been inserted. On the PC monitor a window opens automatically with the content of the CD-ROM.

- 4 The following window appears on the PC monitor:

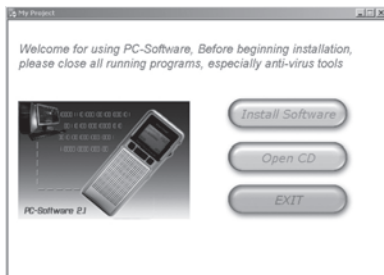

- 5 Click on the button »Install Software«. On the PC monitor there now appears the window for »Convert Setups«. This programme installs the software on your PC. Installation takes place in the folder »Programs«, whereby a sub-folder, »Convert«, is inserted there.; in this, the data required for the installation, operation and deinstallation of the software »Convert« will be deposited.

The installation progresses completely automatically. On completion of the installation there appears on the PC monitor the message



- 6 Click on the button »Finish«.
- 7 Finally, click in the window of the »Convert Setups« on the button »Exit«:  The window closes.

You can now use the software »Convert«.

On the Desktop of your PC a linkage will now be made to the software »Convert«:



10.2 Using the software »Convert«

NOTICE:

All of the screenshots shown in this chapter (pictures of the display on the PC monitor) are examples. Dependant on the operating system and settings, the displays on your PC may differ slightly from those shown here. Should message windows appear on the PC monitor whilst using the »Convert« software: Click each time on the »OK« button to close the window.

To use the software »Convert«:

- 1 Switch the PC on and wait until the operating system has booted.
- 2 Double click on the linkage »Convert« on the Desktop of your PC. The window of the software opens on the PC monitor.
- 3 Insert the small plug of the supplied USB cable into the USB interface »1« ⑰ on the voice recorder. **Thereby, the voice recorder must be switched off!**
- 4 Insert the large plug of the USB cable into a free USB interface on your PC. In the display ① of the voice recorder »PC operation« is indicated; the status lamp »DICT« ⑱ glows permanently.

The PC automatically recognises the switched-off voice recorder as a removable media resp. an external hard drive. Thereby, a drive letter is automatically assigned to it, in our example (L:). The drive letter that is assigned is dependant on the number of other data carriers installed on the PC; accordingly, the voice recorder could also be assigned a different drive letter than (L:). On the PC monitor the window opens with the content of the voice recorder:

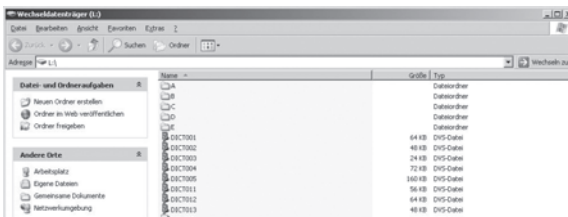

Should a memory card be inserted in the memory card slot ⑨ on the voice recorder: The memory card is – just as with the voice recorder itself – automatically recognised as an additional removable media. Above the window with the content of the voice recorder a dialogue window opens:

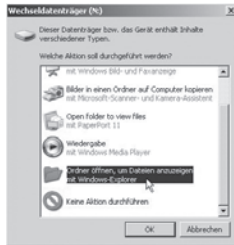

If you want to display the data extant on the memory card: Click on »Open Folder, to show data with Windows-Explorer«:

Finally, click on the button »OK«. An additional window opens, in which the content of the memory card is shown.

If you do not want to display the data extant on the memory card: Click on the button »Finish«. If you want to copy dictation recordings from the memory card to the PC in the next step: Take note of the drive letter that is indicated on the upper edge of the dialogue window; in our example (N:).

5 The window opened in step 2 of the software »Convert« now shows the following:

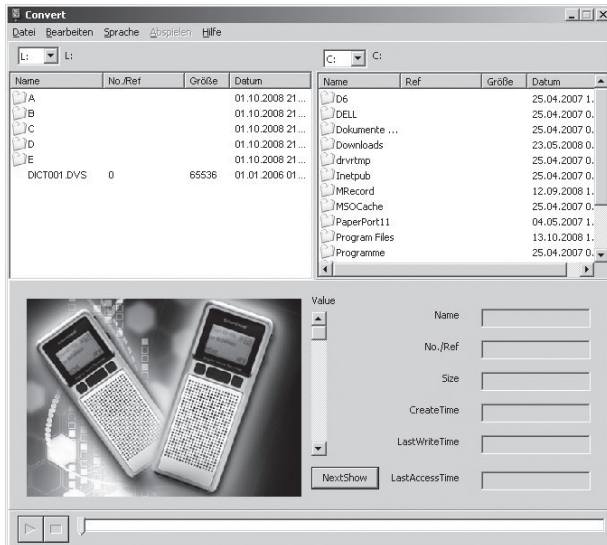

- on the left the content of the voice recorder, assigned the drive letter (L:). in our example one dictation recording (DICT001.DVS) is saved on the voice recorder. Should a memory card be inserted in the memory card slot ⑨ on the voice recorder: the content of the memory card, in our example (N:).
- on the right, the content of the hard drive (C:) of the PC.

Should you wish to rotate between the display of the voice recorder content and the display of the memory card content: Click on the dropdown menu above the left window:

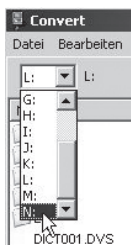

There, select the drive letter of the removable media whose content should be displayed in the left window. In our example you would select (N:) to display the content of the memory card; should you again wish to display the content of the voice recorder, you would select (L:).

- 6 First of all, if need be, programme the language of the software »Convert« into your own vernacular. For this, click in the menu bar at the upper edge of the window on »Language«:



Then select the required language from the drop down list:

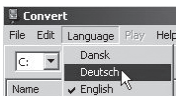

The menu bar at the upper edge of the window and their menu items now appear in the selected language.

- 7 With a double click on the right side of the window select the target folder; the dictation recording will be copied into this as a.wav file.

Should the target folder be located in a sub-folder: Open the superordinate file and then double click on the preferred sub-folder.

To leave a sub-folder and return to the superordinate file: Double click on the folder ...

- 8 On the left of the window, click on the dictation recording to be copied onto the PC.

Should it be that you have saved the required dictation recording into one of the folders A to E: Double click on the left on the respective folder, to display its content. Then click on the required dictation recording.

To return from one of the folders A to E back to the higher memory level of the voice recorder: Double click on the folder ...

- 9 Click in the menu bar at the upper edge of the window on »Process« and subsequently on »Convert«. The dictation recording is now converted to a.wav file and copied into the target folder. This can – subject to the size of the dictation recording – take a few minutes. You can follow the progress of the conversion on the blue beams in the middle of the window.

- 10 As soon as the conversion is completed, the last message »Conversion finished« is displayed:

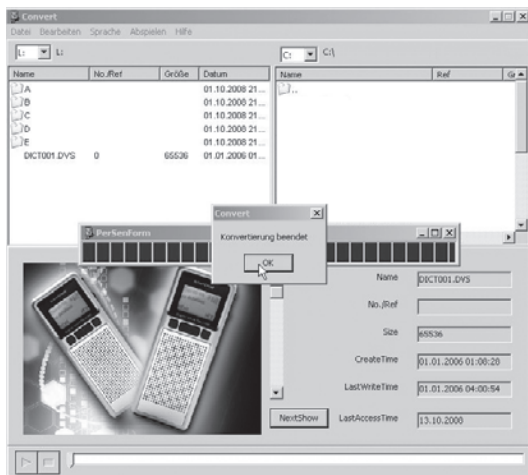

Click on the button »OK«. The conversion is now finalised. Should you wish to copy further dictation recordings: Repeat the steps 8 to 9.

You would like to separate the voice recorder from the PC:

- 11 First, click on the symbol »Securely remove hardware«  in the Info-area of the task bar. This is to be found on the lower right edge of the PC monitor.
- 12 Then select the removable media/the USB external hard drive with the drive letter that was assigned to the voice recorder on being connected to the PC.
- 13 As soon as the message »Hardware can now be removed« appears on the PC monitor: Remove the large plug of the USB cable from the USB interface on the PC.



10.3 Deinstalling the software »Convert« from a PC

Should you wish to uninstall the software »Convert« from your PC:

- 1 Click on »Start«  .
- 2 Click on »All Programmes«:



- 3 Click on »Convert«:



- 4 Click on »Uninstall Convert«:



5 On the PC monitor appears the notification

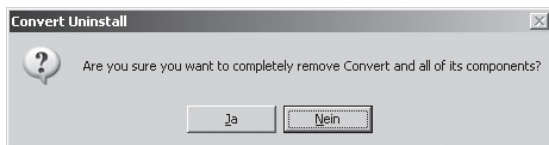

Click on the button »Yes«. Following this, the window for the »Uninstall Wizard« opens; the deinstallation then progresses completely automatically.

6 Indicated on completion of the deinstallation is:

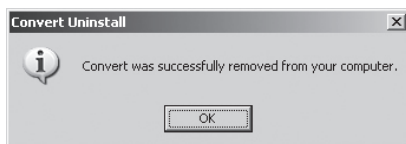

7 Finally, click on the button »OK«.

The software »Convert« is now deinstalled from the PC.

11. Connecting ancillaries to the voice recorder

11.1 Connecting headphones to the voice recorder

If you would like to connect headphones to the voice recorder: Insert the 3.5 mm jack plug of the headphones into the headphone socket »EAR « (8). The loudspeakers of the voice recorder are automatically switched off when headphones are connected. The playback sound volume can still be adjusted as described in chapter 7.5.2 »Adjusting the playback sound volume«.

 **DANGER!**



Too frequent and too loud sound playback over headphones can lead to hearing damage!

11.2 Connecting an external microphone to the voice recorder

Should you prefer to use an external microphone for dictation recording instead of the internal microphone of the voice recorder:

Insert the 3.5 mm jack plug of the microphone into the microphone socket »MIC« (11). The internal microphone of the voice recorder is automatically switched off when an external microphone is connected.

12. Cleaning the voice recorder

Clean the housing and display of the voice recorder with a lightly moistened cloth only. In case of stubborn stains, pour a few drops of a mild detergent on the damp cloth.



Ensure that moisture cannot permeate into the voice recorder during cleaning! This applies especially to the loudspeaker on the front of the voice recorder. Otherwise, there is the risk of receiving an electric shock!

13. Troubleshooting

13.1 The voice recorder indicates no functions

13.1.1 With cell/battery operation

Check that the batteries/cells have been inserted into the battery compartment of the voice recorder as per their polarity. The correct polarity is indicated inside the battery compartment. If they have been inserted correctly, they are either discharged or defect.

Change standard (non-rechargeable) batteries for new ones of the type AA/LR06/ Mignon 1.5 V. Exchange drained cells for charged ones of the type AA/Mignon 1.2 V. Cells can be recharged in the battery compartment of the voice recorder.

Alternatively, you can also adapt the voice recorder for mains power operation.

13.1.2 With mains power operation

- 1 Check to ensure that the DC plug of the power adapter is correctly inserted into the socket »DC 5V 0.5 A« (7).
- 2 Check to see if the power adapter cable is correctly inserted into the mains power socket.
- 3 Check to see that the mains power socket into which the power cable is inserted is "live". Connect a known working device to the power socket.
- 4 Separate the power adapter from the mains power. Wait a few seconds, then reconnect it to a mains power socket. Check to see if the malfunction is still extant.
- 5 Check to see if perhaps the key lock of the voice recorder is activated. For more details see chapter 8.1 »Activating/deactivating the key lock«.

13.1.3 With connection of the voice recorder to a PC via a USB-cable (USB operation)

- 1 Check to ensure that the PC to which the voice recorder is connected is also switched on.
- 2 Check to ensure that the small plug of the USB cable is correctly connected in the USB interface »⚡« (17) on the voice recorder.
- 3 Check to ensure that the large plug of the USB cable is correctly connected in the USB interface of the PC.
- 4 Check to see if the USB interface of the PC is carrying electrical power; connect a different but suitable device to this USB interface.
- 5 Check to see if the voice recorder can be operated at another USB interface on the PC.

13.2 Voice recorder has crashed/input not possible

If the voice recorder no longer reacts to input when in a switched on condition: The internal software of the voice recorder could have crashed. In this case, use the Reset button (19); it is to be found inside the battery compartment (18). Additionally:

- 1 Should a USB cable be inserted into the USB interface »⚡« (17): Remove this beforehand from the USB interface. If the voice recorder was previously supplied with power over the USB cable: Open the battery compartment (18).

Insert batteries or fully charged cells into the battery compartment. Be sure to insert the batteries/cells with their correct polarities. The correct polarity is indicated inside the battery compartment. Close and secure the battery compartment.

- 2 Check to see if the voice recorder now functions as it should.
Should this not be the case:
- 3 Open the battery compartment (18). Using a pointed object press the Reset button (19) down; it is to be found in the battery compartment, located somewhat sunken between the two batteries/cells. Take steps to ensure that the batteries do not fall out of the battery compartment. The voice recorder switches itself off through the pressing of the Reset button (19). Close and secure the battery compartment.
- 4 Switch the voice recorder on and check to see if the malfunction has cleared itself.

13.3 Error messages

When formatting new memory cards (see chapter 8.4 »Using memory cards instead of the device internal storage system«) error messages can occur. Confirm the error messages in these cases; select »OK« to them by pressing the function button D (5).

13.4 Other Malfunctions

Make contact with our service partners responsible for your country if ...

- the measures described in chapter 13. "Troubleshooting" do not eliminate the malfunctions as described, or
- other malfunctions occur during the operation of the voice recorder.

The contact information for our service hotline can be found on the warranty card at the end of this operating manual.



WARNING!

The voice recorder does not contain any parts that can be serviced by the user. If the housing of the voice recorder is opened, the warranty will become void! For repairs which may be needed, consult our service partner responsible for your country.

14. Disposal

14.1 Device



Do not dispose of the device in your normal domestic waste.

■ This product is subject to the provisions of European Directive 2002/96/EC.

Dispose of the device through an approved disposal centre or at your community waste facility. Observe the currently applicable regulations. In case of doubt, please contact your waste disposal centre.

14.2 Batteries/Cells

- Used batteries/cells may not be disposed of in household waste.
- Batteries/cells can contain toxic substances which may damage the environment. Therefore, dispose of the batteries/rechargeable batteries in accordance with statutory regulations.
- Every consumer is statutorily obliged to surrender batteries/cells to a community collection centre in their district or to a dealer. The purpose of this obligation is to ensure that batteries are disposed of in a non-polluting manner.
- Only dispose of batteries/cells when they are fully discharged.

14.3 Packaging materials



Dispose of all packaging materials in an environmentally friendly manner.

15. Warranty and Service

A 3-year warranty applies to this device, starting with the date of purchase. Should you, in spite of our high quality standards, have grounds for complaint please contact our Service Hotline. The telephone number of the service partner responsible for your region is given on the warranty card at the end of these operating instructions. If

an immediate resolving of your complaint is not possible, you will receive from there

- a processing number (RMA number) and
- an address to which you can send your product for warranty processing.

In the case of a mail-in shipment please enclose a copy of the purchase receipt (sales slip). The device must be securely packed and the RMA number clearly visible. Products received without the RMA number cannot be processed.

 **NOTICE:**

The warranty is valid only for material or manufacturing defects. The warranty does not apply to:

- wearing parts, or
- for damage to fragile parts such as switches
- or batteries/cells

This device is intended for private use only and is not intended for commercial or industrial use. The warranty shall be null and void in the case of abusive and improper handling, use of force or any other work not carried out by our authorized service branch. Your statutory warranty claims are not restricted by this warranty.

16. Importer

KOMPERNASS GMBH
BURGSTRASSE 21
D-44867 BOCHUM

www.kompernass.com



Index

.wav file, See Wave file
3.5 mm jack plug 9, 10, 38, 69

A

Access times 52
Ack. beep, See Audio signals
Anti-virus programme 61
Audio signals 42, 43
AutoPlay 61

B

Background Illumination, See Illumination adjustments
Barrel plug, See DC plug
Batteries 7, 9, 10, 12, 14, 15, 58, 72, 73
Batteries/rechargeable batteries
 changing 58, 70
 defect 69
 discharged 42, 58, 70
 full/charged condition 14, 15, 59, 60
 leaking 8
Battery compartment 7, 8, 9, 10, 12, 58, 70, 71
Battery operation 6, 10, 15, 70
Battery selection screen 11, 12, 14, 54
Battery symbol  15, 58, 59, 60
Button »DICT  10, 18, 22, 23
Button »ON/OFF« 10, 11, 14, 16
Button »RESET« 10, 70, 71

C

CD-ROM, See Software »Convert«
Cells 7, 9, 10, 12, 14, 15, 58, 72, 73, 74
 charging 58, 59, 60
Charge operation 59, 60
Charge procedure 59, 60
Cleaning 70
Convert, See Software »Convert«
Converting 66
Crash 71

D

Date 47, 48
Date indicator 12
Date/Time adjustment screen 13
DC plug 7, 10, 11, 58, 59, 70
Defect 7, 8
Dictation recording
 copy to PC 60, 66
 handling 22
 finish 18, 22
 period 17, 19, 21, 22, 23
 numbering 16, 17, 49
 insert passages 22
 overwrite passages 22
 delete partially 23, 25, 26

 delete completely 23, 24
 playback 18, 19
 stop playback 19
 finish playback 19
Dictation recording/playback stopping 10
Dictations
 alternate between saved 19, 22, 24
 save at uppermost memory level 27
 save on folders 27
Display 9, 44, 70
Display Language 52, 54, 55
Disposal 7, 73
Drive letter 63, 64, 65, 67

E

Error messages 72
Expandable memory, See memory cards

F



Factory settings 51, 52
Fast forward (FFWD) 10, 20
Fast rewind (REW) 10, 21
Firmware 56, 57
Folder 27, 28, 66
Folder »Programme Files«, PC 62
Formatting
 internal memory 52, 53, 54
 memory cards 33, 34, 53, 72
Function button a 9
Function button b 9, 20, 40
Function button c 9, 20, 40
Function button d 9, 15, 19

H

Hardware
 Minimum requirements 60
 remove securely 67
Headphone socket »EAR « 9, 38, 69
Headphones 69
Hourglass symbol 13, 14, 34, 54
Housing
 opening of the 8, 72
 Cleaning 70
HP, See Rec. mode

I

Illumination adjustments 44, 45
Importer 74
Indicator »EXT« 13, 14, 33
Indicator »INT« 13, 14
Input screen 31, 32
Intended Use 6
Internal dictation counter 16, 49, 50
Items supplied 9, 10, 12, 53, 58, 60, 61

- K**
Keys locked 10, 27, 71
- L**
Language selection
voice recorder, *See Display language*
Software »Convert«, *See Software »Convert«: display language*
- Liability, *See Warranty*
Loudspeaker 69, 70
LP, *See Rec. mode*
- M**
Mains power operation 6, 7, 10, 11, 14, 15, 58, 70
Memory 6
expandable, *See memory cards*
internal 6, 13, 14, 33, 52
Memory capacity 6, 33
Memory cards 6, 9, 13, 14, 33, 53, 63, 65, 72
Memory cards slot 9, 13, 14, 33, 53, 63, 65
Menu 11, 15, 27, 60
Microphone
external 69
internal 10, 36, 37, 69
Microphone sensitivity 36, 38
Microphone socket »MIC « 10, 69
MMC memory card, *Siehe memory cardn*
Multi-function slider 10, 17, 18, 19, 20, 21, 27
Mute switching 19, 40
- P**
Packaging material, *See Disposal*
Pause Mode 16
PC Microphone
Set record sound volume 40
Use the voice recorder as 38, 39, 40
PC operation 14, 59, 63
Playback sound volume 19, 69
Playback speed 19, 20
Polarity
Batteries/Cells 10, 70, 71
DC plug (Barrel plug) 6, 7, 10, 11, 58, 59
Power adapter 7, 8, 9, 10, 11, 12, 58, 59, 70, 71
- R**
Rec. mode 46, 47
Record Pause 17, 18, 22, 23
Record time 15
References 29, 32
allocated automatically (NR on) 29, 31
give own in (NR auto) 29, 31
none (NR off) 29, 31
Removable medium 11, 59, 63, 65, 67
Repair 9, 72
- S**
Safety information 6
- Sampling rate, *See Rec. mode*
SD memory card, *See memory cards*
Service 73
Service partner 72, 73
Settings 9, 11, 27, 35, 37, 38, 41, 43, 45, 47, 48, 50, 51, 55, 57, 60, 63
Shutdown/Switch off, automatic 58, 59, 60
Slider »HOLD«, *See Keys locked*
Socket »DC 5V 0.5A« 9, 10, 59, 70
Software »Convert« 9, 29, 30, 53, 60, 61, 63, 64
Language display 65
Deinstallation 68
Desktop linkage 62, 63
Installation 61, 62
Menu bar 65, 66
Setup, *See Software »Convert«: Installation*
Sound volume, maximum 19, 40
SP, *See Rec. mode*
start screen 13, 14, 36
status lamp »DICT « 10, 14, 16, 17, 18, 22, 23, 63
Storage bag 9
Sub Folder, PC 66
Switch-off options 40
Symbol  14, 15, 59, 60
- T**
Target Folder, PC 66
Task beam, PC 67
Time 47
Troubleshooting 70, 71, 72
- U**
Uninstall Wizard, *See Software »Convert«: Deinstallation*
Update, *See Firmware*
USB cable 9, 11, 12, 14, 58, 59, 60, 61, 63, 67, 71
USB external hard drive 63, 67
USB interface »i«, voice recorder 10, 11, 60, 63, 71
USB interface, PC 11, 12, 60, 61, 63, 67, 71
USB operation 11, 14, 15, 71
- V**
Version number, *See Firmware*
Voice activation 34, 35, 36
Voice Activation, *See language activation*
- W**
Warranty 6, 8, 9, 74
Warranty 8, 72, 73
Warranty handling 74
Wave files 60, 66
Windows® 60, 61

Free Manuals Download Website

<http://myh66.com>

<http://usermanuals.us>

<http://www.somanuals.com>

<http://www.4manuals.cc>

<http://www.manual-lib.com>

<http://www.404manual.com>

<http://www.luxmanual.com>

<http://aubethermostatmanual.com>

Golf course search by state

<http://golfingnear.com>

Email search by domain

<http://emailbydomain.com>

Auto manuals search

<http://auto.somanuals.com>

TV manuals search

<http://tv.somanuals.com>