



# OWNER'S MANUAL

**SMT9.2P SMT9.2AB**

Model Name SMT9.2/SMT9.2AB

Serial Number \_\_\_\_\_

Purchase Date \_\_\_\_\_

Write down for future reference.

[treadmillbynet.com](http://treadmillbynet.com)

[Smoothfitness.com](http://Smoothfitness.com)

-

**SALES: (888) 559-8810**

**SERVICE: (888) 340-0482**

**Smooth Fitness**

**Mt. Laurel, NJ**

Part# 15-0125

# Table of Contents



<b>Information</b>	<b>Page#</b>
Model Name Descriptions	3
Model Specifications	4
Important Safety Information	5
Before You Start	6
Warm Up Exercises	7
Assembly Instructions	8
Power Requirements	9
Console Functions and General Descriptions	10
Console Layout	11
Program Operating Instructions—Quick Start Manual Mode	12
Program Operating Instructions—Program Mode	12-13
Program Operating Instructions—Customizing Pre-set Programs	13
Program Operating Instructions—User Defined Programming	13
Program Profiles	14
Belt Adjustments and Tension	15
Maintenance Instructions	16
Troubleshooting Guide	17
Parts and Exploded View	18
Warranty and Registration	19

# MODEL NAME DESCRIPTIONS



## Product Name Definitions

Each Smooth treadmill has a model name and unique serial number. The serial number label is located on the back of the console upright.

Model name sample: SMT9.2AB This model name is a Smooth 9.2 treadmill with programming and an AeroBelt.

**SMT**—Smooth Treadmill

**9.2**—Series number

**P**— Programmable

**AB**—Programmable treadmill with AeroBelt (thicker, shock-absorbing, orthopedic-style belt)

Smooth Treadmill combinations

**SMT9.2P**—Smooth Treadmill 9.2 model with programs

**SMT9.2AB**—Smooth Treadmill 9.2 model with programs and AeroBelt

## IMPORTANT! PLEASE READ!

The serial number label indicates the model of the treadmill. To avoid confusion, the **SMT9.2AB** will have the **SMOOTH 9.2P** overlay on the console. Refer to the serial number label for proper identification.

The **SMOOTH 9.2P** overlay is used for the model **SMT9.2P** AND the **SMT9.2AB**

This manual covers operating instructions for all models shown above.

# Model Specification Sheet



<u>MODEL</u>	<u>SMT9.2P</u>	<u>SMT9.2AB</u>
Horsepower	3.0HP	3.0HP
Continuous Console Display	Four Multi-function LED Windows, One Multi-function Dot Matrix	Four Multi Function LED Windows, One Multi-function Dot Matrix
Pre-set Programs	4	4
Custom Programs	8	8
User Defined Programs	2	2
Heart Rate Interactive	NO	NO
Incline Range	0 to 15%	0 to 15%
Speed Range	.6 to 10 MPH	.6 to 10 MPH
Belt Type	2-Ply	AeroBelt 2-Ply
Belt Size (Width x Length) in inches	20" x 56.5"	20" x 56.5"
Residential Motor Warranty	10 Years	10 Years
Residential Parts Warranty	3 Years	3 Years
Residential Frame Warranty	Lifetime	Lifetime
Residential Labor Warranty	1 Year	1 Year
Light Institutional Warranty	1 Year Motor, Parts, Frame, & Labor	1 Year Motor, Parts, Frame, & Labor
Width x Length in inches	30" X 70"	30" X 70"
User Weight	400 lbs.	400 lbs.
Warranty Frame	Lifetime	Lifetime

# Important Safety Information



**WARNING!** Before using this treadmill or starting any exercise program, consult your physician. This is especially important for persons over the age of 35 and/or persons with pre-existing health problems. The manufacturer or distributor assumes no responsibility for personal injury or property damage sustained by or through the use of this product.

**WARNING!** To reduce the risk of electrical shock, burns, fire, or other possible injuries to the user, it is important to review this manual and the following precautions *before* operation.

## SAFETY PRECAUTIONS AND TIPS

- It is the owner's responsibility to ensure that all users of this treadmill have read the Owner's Manual and are familiar with warnings and safety precautions.
- The treadmills have a user maximum capacity of 400 pounds.
- The treadmill should only be used on a level surface and is intended for indoor use only. The treadmill should not be placed in a garage, patio, or near water and should never be used while you are wet. SMOOTH recommends a treadmill mat be placed under the treadmill to protect floor or carpet and for easier cleaning.
- Follow safety information in regards to plugging in your treadmill. Keep the power cord away from the incline wheels and do not run the power cord underneath your treadmill. Do not operate the treadmill with a damaged or frayed power cord.
- Wear comfortable, good-quality walking or running shoes and appropriate clothing. Do not use the treadmill with bare feet, sandals, socks or stockings.
- Always straddle the belt and allow it to start moving before stepping onto the belt.
- Hold on to handrails when adjusting speed, incline, or other controls.
- Always examine your treadmill before using to ensure all parts are in working order.
- Allow the belt to fully stop before dismounting.
- Pets should never be allowed near or on the treadmill.
- Do not leave children unsupervised near or on the treadmill.
- Never operate the treadmill where oxygen is being administered, or where aerosol products are being used.
- Never insert any object or body parts into any opening.
- For safety and to prevent damage to your treadmill, no more than one person should use the treadmill at a time.
- Always unplug the treadmill before cleaning and/or servicing. Service to your treadmill should only be performed by an authorized service representative, unless authorized and/or instructed by the manufacturer
- Failure to follow these instructions will void the treadmill warranty.
- Never leave the treadmill unattended while it is running

# Before You Start



Thank you for purchasing the **SMOOTH** treadmill! This quality product you have chosen was designed to meet your needs for cardiovascular exercise.

- Before you start, please read the Owner's Manual and become familiar with the operation of your new treadmill.
- **Remember to take the time to perform the stretching exercises provided to avoid injury.**
- Do not stand on the walking belt while pressing the Power button or Start/Stop button.
- Always adjust the speed of the treadmill in small increments as this treadmill is capable of high speeds.
- If you are taking medication, consult your physician to see if the medication will affect your exercise heart rate.
- If you have heart problems, you are not active, and/or are over the age of 35 years, do not use the pre-set treadmill programs or start an exercise program without first contacting and receiving approval from your physician.
- To avoid the risk of electrical shock, always keep the console dry. Do not spill liquids on the console. SMOOTH recommends a sealed water bottle for beverages consumed while using the treadmill.

# Warm Up Exercises



## EXERCISE GUIDELINES

**WARNING!** Before beginning this or any exercise program, you should consult your physician. This is especially important for individuals over the age of 35 or individuals with pre-existing health problems.

Warming up prepares the body for the exercise by increasing circulation, supplying more oxygen to the muscles and raising body temperature. Begin each workout with 5 to 10 minutes of stretching and light exercise to warm up. The photos on this page show several forms of basic stretching you may perform before your workouts. In order to achieve an adequate warm-up, perform each stretch three times.

### TOE TOUCH STRETCH

Stand bending your knees slightly and slowly bend forward from your hips. Allow your back and shoulders to relax as you reach down toward your toes as far as possible. Hold for 15 counts, then relax. This will stretch your hamstrings, back of knees, and back.



### HAMSTRING STRETCH

Sit with one leg extended. Bring the sole of the opposite foot toward you and rest it against the inner thigh of your extended leg. Reach toward your toes as far as possible. Hold for 15 counts, then relax. This will stretch your hamstrings, lower back, and groin.



### CALF/ACHILLES STRETCH

With one leg in front of the other, reach forward and place your hands against a wall. Keep your back leg straight and your back foot flat on the floor. Bend your front leg, lean forward and move your hips toward the wall. Hold for 15 counts, then relax. To cause further stretching of the Achilles tendon, bend your back leg as well. This will stretch your calves, Achilles tendons, and ankles.

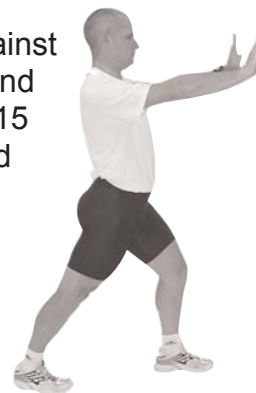

### QUADRICEPS STRETCH

With one hand against a wall for balance, reach back and grasp one foot with your other hand. Bring your heel as close to your buttocks as possible. Hold for 15 counts, then relax. This will stretch your quadriceps and hip muscles.



### INNER THIGH STRETCH

Sit with the soles of your feet together and your knees outward. Pull your feet toward your groin area as far as possible. Hold for 15 counts, then relax. This will stretch your quadriceps and hip muscles.

# Assembly Instructions



## Minor Assembly Required!

The **Smooth 9.2P and AB** treadmill is shipped in two pieces: the console upright assembly, and the base assembly. After opening the box, remove any packing materials from the treadmill. Do not throw away any packing materials until the unit is working properly. The treadmill box contains a package that includes the Owners Manual, a **RED SAFETY KEY**, and a belt adjustment tool. The treadmill will not operate without the Red Safety Key.

The console upright assembly is attached to the base assembly. Place the unit on a clean, level surface near an electrical outlet (extension cords are not recommended).

## See Figure 1

1. Raise the console into an upright position. Loosely install both 3/4" buttonhead screws on each side of the upright. Install and tighten each 3 1/2" x 5/16" bolt (2) with washers from the bottom of the base frame through the upright lock (diag. 1).
2. Now tighten the buttonhead screws securely from step 1.
3. Install motor hood cover using 5/8" phillips head screws (8 screws).

Be sure the treadmill is level to the floor. The rear feet can be adjusted to level the treadmill. Assembly is now complete!

Figure 1

Base Frame



# Power Requirements



**IMPROPER CONNECTION OF THE EQUIPMENT GROUNDING CONNECTOR CAN RESULT IN A RISK OF AN ELECTRIC SHOCK. CHECK WITH A QUALIFIED ELECTRICIAN OR SERVICE MAN IF YOU ARE IN DOUBT AS TO WHETHER THE PRODUCT IS PROPERLY GROUNDED. DO NOT MODIFY THE PLUG PROVIDED WITH THE PRODUCT IF IT WILL NOT FIT THE OUTLET. HAVE A PROPER OUTLET INSTALLED BY A QUALIFIED ELECTRICIAN.**

This treadmill can be seriously damaged by sudden voltage changes in your home's electrical power. Voltage spikes, surges, and noise interference can result from weather conditions or from other appliances being turned on or off. To reduce the possibility of treadmill damage, always use a surge protector (not included) with your treadmill.

Surge protectors can be purchased at most hardware stores. The manufacturer recommends a single outlet surge protector with UL 1449 rating as a Transient Voltage Surge Suppressor (TVSS) with UL suppressed voltage rating of 400V or less and an electrical rating of 120VAC, 15 amps.

This treadmill must be grounded to reduce the risk of electrical shock. Grounding provides a path of least resistance for electric current should the treadmill malfunction. This treadmill comes with an electrical cord with an equipment-grounding conductor and a grounding plug. Always plug the power cord into a surge protector, and plug the surge protector into an appropriate outlet that is properly installed and grounded in accordance with all local codes and ordinances.

This product is for use on a nominal 120-volt circuit and has a grounding plug that looks like the plug illustrated in the drawing below.

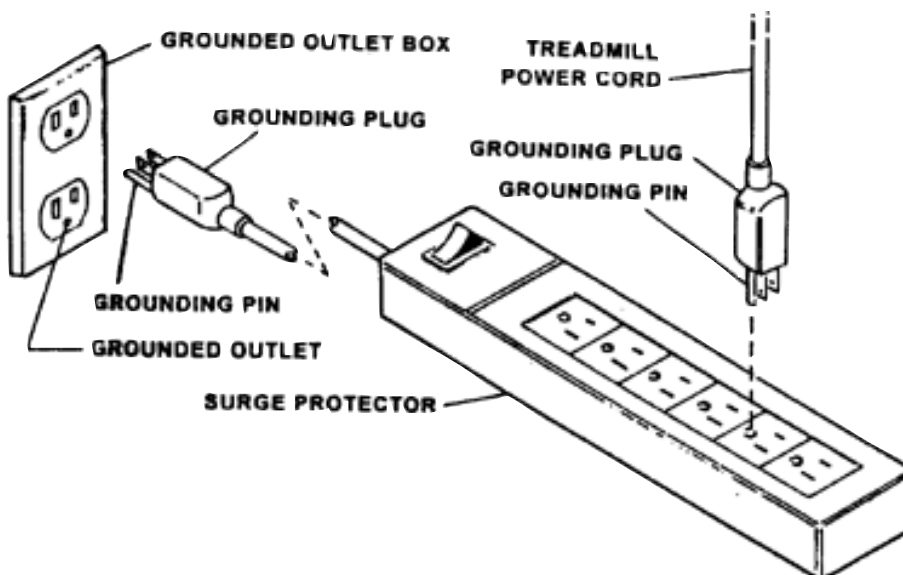

# Console Functions and Descriptions



There are five LED display windows on the control panel to provide you with vital feedback information.

## TIME WINDOW

- **TIME:** Indicates elapsed time after pressing start in minutes and seconds (0-99 minutes, 0-59 seconds)
- **PACE:** Indicates number of minutes to complete 1 mile at current speed.

## SPEED WINDOW

- **SPEED:** Indicates MPH (miles per hour) or Km/H (kilometer per hour) in .1 increments

## DISTANCE / CALORIES WINDOW

- **DISTANCE:** Indicates Miles or Kilometers traveled in .01 increments up to 9.99 and .1 increments starting at 10.0
- **CALORIES:** Indicates estimated calories used based on 150 lb. person at the indicated speed, incline, and time

## INCLINE WINDOW

- **INCLINE:** Indicates incline in percent of grade 0-15% in 1% increments.

## CENTER BRICKYARD

- Displays quarter mile track in Manual mode. Indicates position on track by a blink. In program mode, shows the change in speed profile across the interval range (1-10) and shows position with a blinking action.

## SPEED BAR

- The Speed Bar allows the user to adjust speed quickly. The Speed Bar works in all manual and program modes. To use the Speed Bar, the belt must already be moving. Press the desired speed (2 through 8), and the treadmill will slowly reach the speed selected. In program mode, the change in speed with the Speed Bar will only work in the current interval. Once the program switches to another interval, the speed will revert to the programmed speed.

## INCLINE BAR

- The Incline Bar allows the user to adjust Incline quickly. The Incline Bar works in all manual and program modes. To use the Incline Bar, the belt must already be moving. Press the desired Incline (2 through 8), and the treadmill will slowly reach the Incline selected. In program mode, the change in incline with the Incline Bar will only work in the current interval. Once the program switches to another interval, the incline will revert to the programmed speed.

## TOGGLE SWITCHES IN HANDLEBARS FOR SPEED AND INCLINE

Your treadmill is equipped with toggle switches that conveniently change the incline and speed without reaching up to the console. In program mode, the change in speed and/or incline with the toggle switches will only work in the current interval. Once the program switches to another interval, the speed and incline will revert to the programmed speed and incline.

## LED INDICATORS - (small green diode lights on console)

- **PROGRAM SELECTION:** The treadmill console will display the program selected with a LED light beside the program., showing on the left hand side of the window.
- **TIME: LED** indicators will toggle back and forth for the Pace and the Workout Time. The Pace will be indicated while in a program. The PACE is the number of minutes it would take to complete one (1) mile at the current speed of the treadmill. The WORKOUT TIME is the total time set at the beginning of a program, and will count down from the amount of time set throughout the program, or will count up in Manual mode.
- **CALORIES & DISTANCE: LED** indicators will toggle back and forth to show total Calories burned and total Distance covered. The Calories burned is an estimate based on a 150 lb person at the current speed and incline levels.

# Console Layout



## Console Layout, SMT9.2P and SMT9.2AB

IMPORTANT! Please note that the Console Overlay used on the SMT9.2AB will read SMT9.2P. The only difference in the two models is the type of walking belt used. The SMT9.2AB uses a thick, orthopedic-style belt. To verify the model you have received, review the SERIAL NUMBER LABEL located on the console upright. The Serial Number Label will indicate the actual model number.

### Program Buttons (5)

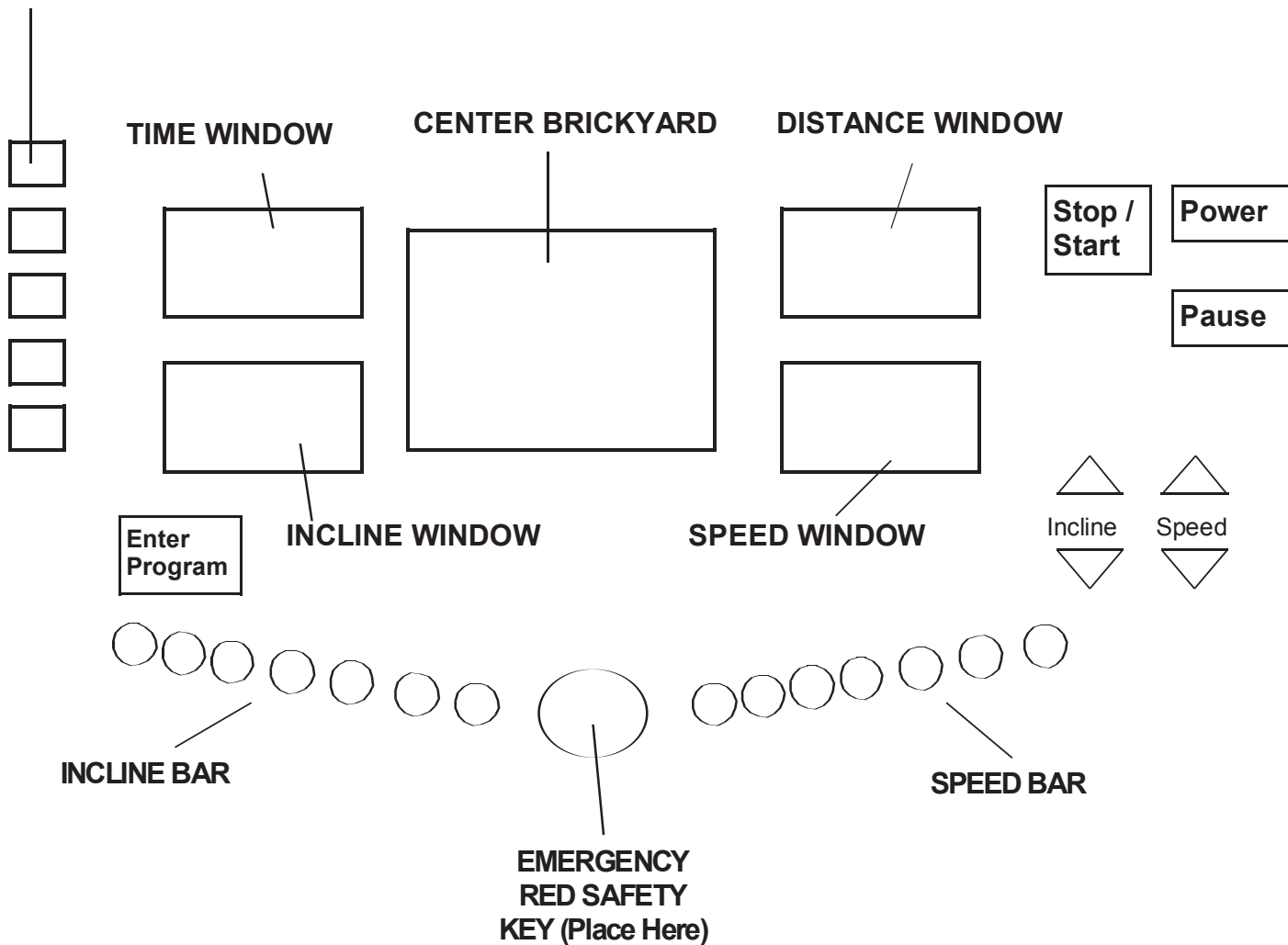

# Program and Operating Instructions



## QUICK START / MANUAL MODE

- Plug into a standard wall outlet (110-Volt AC, 15-amp circuit).
- Stand on the treadmill and straddle belt.
- Press POWER button. There will be an eight (8) second delay after pressing the POWER button before data can be entered. The TIME window will flash.
- Press START/STOP button. Belt will begin to move after 4 seconds. Step on belt slowly after the belt starts moving. Speed or incline may be adjusted by using the appropriate + (increase) or – (decrease) buttons.
- **To end your workout**, press START/STOP button. Belt will gradually slow to zero.
- **To pause your workout**, press PAUSE.
- **To re-start after pausing**: Press the PAUSE button. WARNING: The treadmill belt will resume at the speed the treadmill was moving before pausing.
- **Countdown Time, Preset Speed and/or Incline**: Time, Speed, and Incline may be preset prior to getting started. After pressing the POWER button, the time window will blink. Use the SPEED/TIME + or – arrows to select your workout time, then press the ENTER PROGRAM button. The SPEED/TIME window will now be flashing. Using the same + or – arrows, select the speed for your workout, then press ENTER PROGRAM. Now the INCLINE window will be flashing. Use the INCLINE + or – arrows to set your workout incline, then press ENTER PROGRAM. To start, press the START/STOP button.

## PROGRAM MODE

- Plug into a standard wall outlet (110-Volt AC, 15-amp circuit).
- Stand on the treadmill and straddle belt.
- Press POWER button. There will be an eight (8) second delay after pressing the POWER button before data can be entered. The TIME window will flash.
- There are four (4) pre-set programs in the 9.2P and 9.2AB. The programs includes Rolling Hills, Speed Intervals, Plateau, Weight Loss and User Programs. Select the program by pressing the appropriate button. An “OP” (meaning Original Program) will appear in the DISTANCE/CALORIES window.
- Press START/STOP button. Belt will begin to move after 4 seconds. Step on belt slowly after the belt starts.

### Pre-Set Program Descriptions

#### Rolling Hills Program

The Rolling Hills Program is designed to vary treadmill elevation while maintaining a constant walking belt speed.

#### Speed Intervals Program

The Speed Intervals Program is designed to vary treadmill speed while maintaining a constant elevation.

#### Plateau Program

The Plateau Program is designed to gradually increase treadmill Speed and elevation in the first segment (warm up), and gradually decrease speed and elevation in the last segment (cool down).

#### Weight Loss Program

**The Weight Loss Program** is designed to alternate between the programmed speed and incline. The program will alternate between: 1) the full programmed incline and half the programmed speed, to 2) zero incline and the maximum programmed speed.



## PROGRAM MODE continued

### Customizing Pre-Set Programs

- Customizing programs in P1 and P2 Mode: Each pre-set program can be customized in the P1 or P2 mode. After making the program selection, the top right window (CALORIES / DISTANCE) will read "OP." "OP" refers to "original program" and is preset. Press the same program button once more, and the CALORIE / DISTANCE window will read P1. The "P1" mode is now accessed. You can now program the Time, Speed, and Incline in P1 mode, which will save your entered information for future use. The time window will blink. Use the SPEED/TIME + or – buttons to select your workout time, then press the ENTER PROGRAM button. The SPEED/TIME window will now be flashing. Using the SPEED/TIME + or – buttons, select the speed for your workout, then press ENTER PROGRAM. Now the INCLINE window will be flashing. Use the INCLINE + or – buttons to set your workout incline, then press ENTER PROGRAM. To start, press the START/STOP button. To access P2 mode, press the selected program button three times (once for OP, twice for P1, three times for P2). Follow the above procedure to customize.
- **TO CHANGE A PREVIOUSLY PROGRAMMED CUSTOM PROGRAM P1 or P2:** Once you have programmed the P1 or P2 modes, you will need to use the PAUSE button to change the program you previously entered. For instance, if P1 in Rolling Hills has been programmed, to change to a new setting, press the Rolling Hills button twice to access P1. Then press the PAUSE button to get the TIME window to flash. Follow the directions above to continue to change the program.

### Customizing User Defined Programs

- User programs allow you to customize each of the 10 program segments. Press the User program button once for User Program 1 (U1), or press the User program button once more for User Program 2 (U2). The time window will flash. U1 or U2 will appear in the DISTANCE window. Set your workout time. Notice the first segment light flashing in the center brickyard. Now the SPEED window will flash, set your speed for the first segment using the SPEED/TIME + or – buttons, and press ENTER PROGRAM button to set. Now the INCLINE window will flash. Set the desired incline using the Incline + or - buttons, and press ENTER PROGRAM button to set. At this point, look at the center brickyard and notice the second segment light is now flashing. Repeat steps above to program all ten segments.
- **TO CHANGE A PREVIOUSLY PROGRAMMED USER PROGRAM U1 or U2:** Once you have programmed the U1 or U2 modes, you will need to use the PAUSE button to change the program you previously entered. For instance, if U1 (User Program 1) has been programmed, to change to a new setting, press the USER PROGRAM button once to access U1. Then press the PAUSE button to get the TIME window to flash. Follow the directions above to continue to change the program.

# Program Profiles

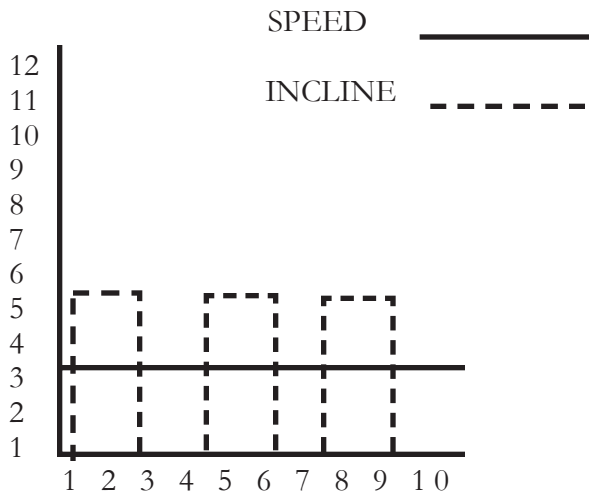

The Rolling Hills Program is designed to vary treadmill elevation while maintaining a constant walking belt speed.

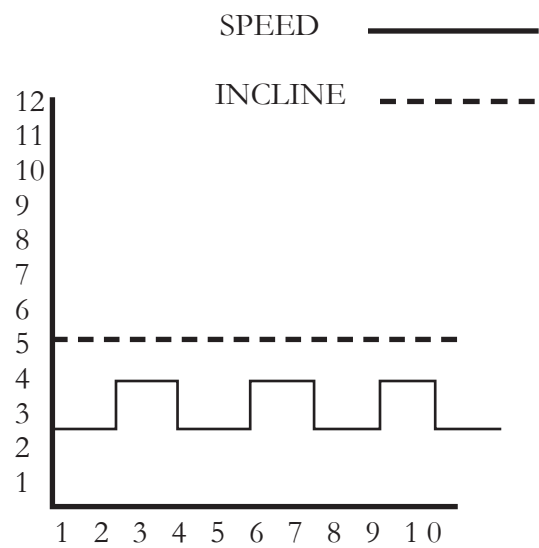

The Speed Intervals Program is designed to vary treadmill speed while maintaining a constant elevation.

Each program contains 10 segments or intervals. For instance, a 30 minute program will have 10 three-minute segments (30 minutes divided by 10). Also, each preset program may be customized for speed, incline, or both. Please see "Program and Operating Instructions" to customize each program.

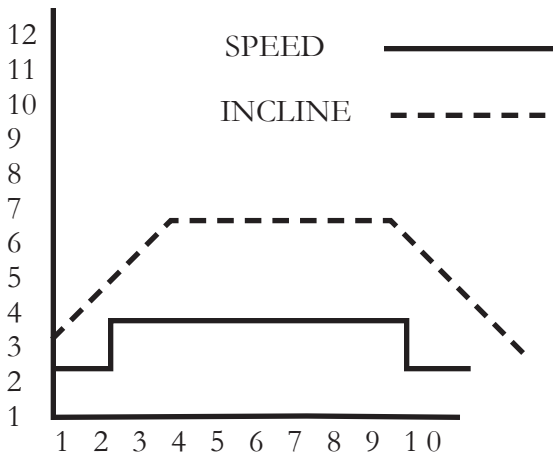

The Plateau Program is designed to gradually increase treadmill Speed and elevation in the first segment (warm up), and gradually decrease speed and elevation in the last segment (cool down).

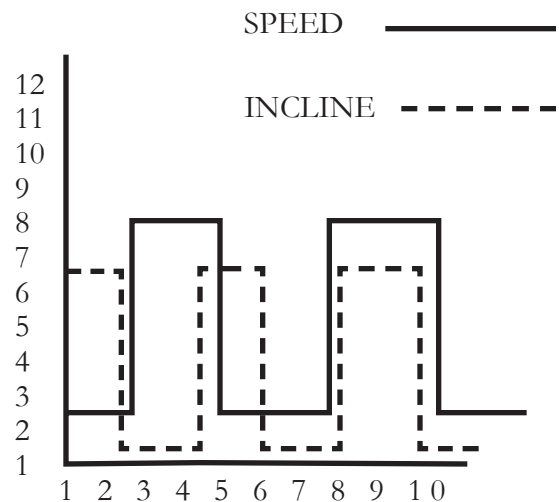

The Weight Loss Program is designed to alternate between the programmed speed and incline. The program will alternate between: 1) the full programmed incline and half the programmed speed, to 2) zero incline and the maximum programmed speed.

# Belt Adjustment and Tension



**WARNING! Do not overtighten rollers! This will cause premature roller bearing failure!**

Belt adjustment and tension performs two functions: adjustment for tension and centering. Your new treadmill comes pre-adjusted from the factory for tension and centering. Please follow the procedures below if the belt shifts to the left or right while walking:

## **WALKING BELT IS SHIFTING TO THE LEFT** (Diagram 1)

First, turn treadmill on to run at 1 mph. Using the hex key provided, turn the left rear roller adjustment bolt  $\frac{1}{4}$  turn in the clockwise direction. Next, run the treadmill at 2.5 mph. You should see start to correct itself by moving back towards the center. Repeat above procedure until the walking belt is centered. It may be necessary to set walking belt tension once you have completed this procedure if the belt feels like it is slipping while walking. Refer below to the "Walking Belt Slipping" instructions.



## **WALKING BELT IS SHIFTING TO THE RIGHT** (Diagram 2)

First, turn the treadmill on to run at 1 mph. Using the hex key provided, turn the right rear roller adjustment bolt  $\frac{1}{4}$  turn in the clockwise direction. Next, run the treadmill at 2.5 mph. You should see the belt start to correct itself, moving back towards the center. Repeat the above procedure until the walking belt is centered. It may be necessary to set walking belt tension once you have completed this procedure if the belt feels like it is slipping while walking. Refer below to the "Walking Belt Slipping" instructions.



## **WALKING BELT IS SLIPPING DURING USE** (Diagram 3)

First, unplug the power cord from the surge protector. Using the hex key provided, turn both left and right rear roller adjustment bolts the same distance, usually a  $\frac{1}{4}$  turn in the clockwise direction. Plug the power cord back into the surge protector and run the treadmill at 2.5 mph. You should now walk on the belt to determine if the belt is still slipping. Repeat the above procedure until the walking belt is not slipping. The tension should be just tight enough not to slip.

- Turning the hex key counter clockwise brings the rear rollers and belt towards you.
- Turning the hex key clockwise pushes the rear roller and belt away from you.



# Maintenance Instructions



**WARNING!** Before performing any maintenance to your treadmill, always unplug the power cord from the surge protector.

## CLEANING

Routine cleaning of your Smooth treadmill will extend the life of your treadmill. **WARNING!** To prevent electrical shock, be sure the power to the treadmill is OFF and the unit unplugged from the wall electrical outlet before attempting any cleaning or maintenance.

**AFTER EACH WORKOUT:** Wipe off the console and other treadmill surfaces with a clean, water dampened soft cloth to remove excess perspiration. **USE NO CHEMICALS.**

**WEEKLY:** Use of a treadmill mat is recommended for ease of cleaning. Dirt from your shoes contacts the belt and eventually makes it to underneath the treadmill. Vacuum underneath treadmill once a week.

## DECK LUBRICATION

The walking belt has been pre-lubricated at the factory. However, it is recommended that the walking board be checked periodically for lubrication to ensure optimal treadmill performance.

Every 30 days or 30 hours of operation, lift the sides of the walking belt and feel the top surface of the walking board as far under as you can reach. If you feel signs of silicone, no further lubrication is required. If it feels dry to the touch, follow the instructions below.

Smooth recommends "Lube N Walk" for cleaning and lubricating the treadmill belt and deck. You may also use silicone such as "Napa 8300" (available at most stores).

## TO APPLY LUBRICANT TO THE WALKING BOARD

- 1) Position the walking belt so that the seam is located on top and in the center of the center of the walking board.
- 2) Insert the spray nozzle into the spray head of the lubricant can.
- 3) While lifting the side of the walking belt, position the spray nozzle between the walking belt and the board approximately 6" from the front of the treadmill. Apply the silicone spray to the walking board, moving from the front of the treadmill to the rear. Repeat this on the other side of the belt. Spray approximately 4 seconds on each side.
- 4) Allow the silicone to 'set' for one minute before using the treadmill.

**WARNING: Do not overlubricate the walking board. Excess lubricant should be wiped off with a clean towel.**

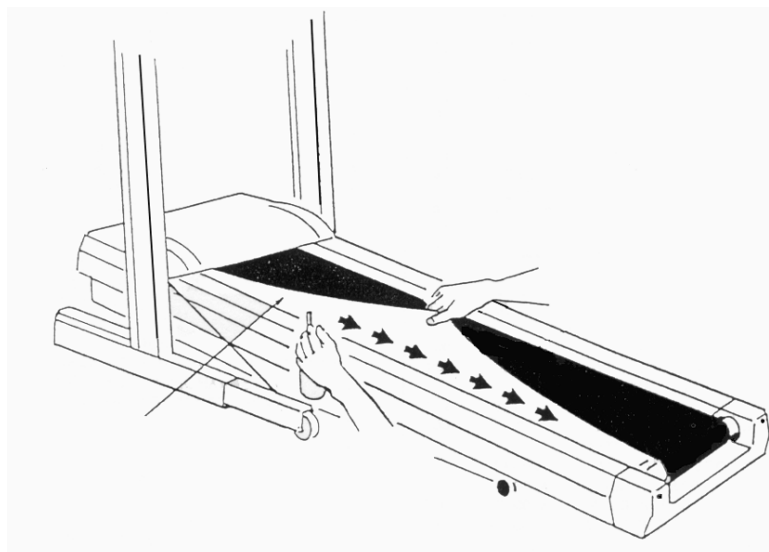





## **Treadmill will not start.**

- 1 Is the **Safety Key** inserted into the treadmill Console?
- 2 Make sure the power cord is plugged into a surge protector, the surge protector is plugged into a properly grounded outlet, and the surge protector is turned on. (Refer to “Power Requirements” on page 8)
- 3 Check the circuit breaker located on the front of the treadmill. If the switch protrudes, it has tripped. Wait five minutes and then press the switch back in.
- 4 Check the house electrical breaker box and the circuit breaker for the room where the treadmill is located. If it has tripped, reset or have an electrician replace the breaker in home.
- 5 Have an electrician check for inadequate voltage at the outlet.

## **Treadmill loses power during use.**

- 1 Check the circuit breaker located on the front of the treadmill. If the switch protrudes, it has tripped. Wait five minutes and then press the switch back in.
- 2 Check the house electrical breaker box and the circuit breaker for the room where the treadmill is located. If it has tripped, reset or have an electrician replace the breaker in home.
- 3 If the treadmill still will not operate, please call Technical Service at (888) 340-0482.

## **Treadmill walking belt slows during use.**

- 1 Check to make sure the treadmill is securely plugged into an UL-listed surge protector, rated at 15 amps, with a 14-gauge cord of five feet or less and the surge protector is securely plugged into the outlet.
- 2 If treadmill still will not operate, please call Technical Service at (888) 340-0482.

## **Treadmill walking belt slips or is not centered on rear roller.**

- 1 Refer to “Belt Adjustment and Tension” section on page 15.
- 2 Need help? Call Technical Service at (888) 340-0482.

## **Treadmill Error Messages.**

Your treadmill is equipped with a software package that enables error messages to be displayed when there is a problem. **To avoid possible damage to the treadmill and the possibility of injury, do not operate the treadmill until the problem is corrected.**

# Parts & Exploded View



	Part #		Part #		
1	Left Side Extrusion Rail	05-0028	12	Front Wheel (2)	06-0039
2	Right Side Extrusion Rail	05-0028	13	Uprights for Console (2)	various
3	Treadmill Belt AeroBelt	04-0010 04-0014	14	Motor Hood Cover Top	06-0040
4	Front Roller Assembly	24-0106	15	Motor Drive Belt	04-0023
5	Rear Roller	09-0009	16	Motor	12-0004
6	Treadmill Deck	03-0016	17	Elevation Motor (acuator)	12-0026
7	Left End Cap	06-0043	18	Console Assembly	24-0215
8	Right End Cap	06-0042	19	N/A	
9	Rear Adjustable Foot (2)	10-0008	20	Handlebars	various
10	Main Frame	various	21	Toggle switches (2)	08-0027
11	Bottom Motor Pan	06-0041	22	Lower Electronics M/Control P/Supply (855)	08-0016
			22	Controller	08-0050

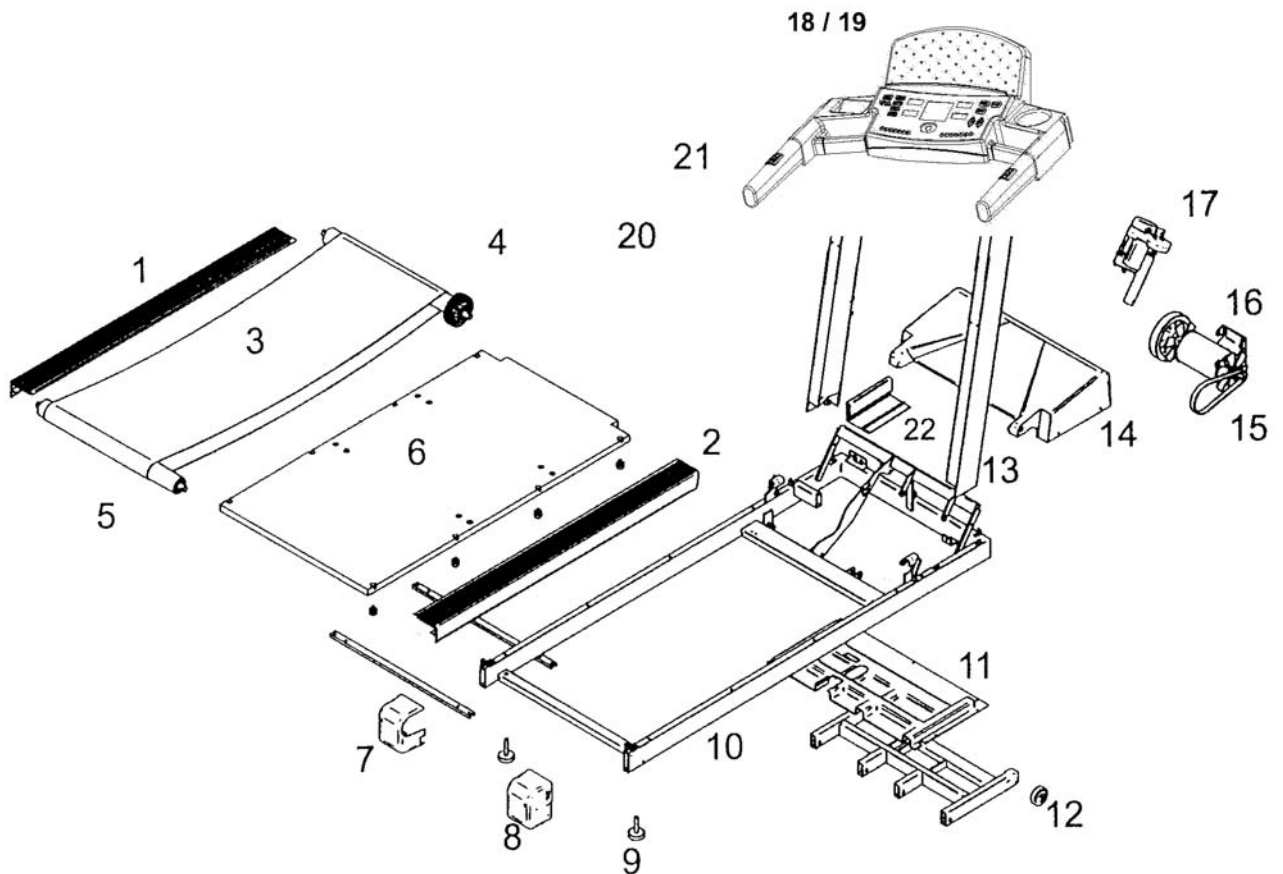

**SMOOTH 9.2P and 9.2AB Treadmills – LIMITED WARRANTY**



**CONSULT YOUR PHYSICIAN BEFORE USING THIS PRODUCT.**

This Limited Warranty applies in the United States to products manufactured or distributed by Smooth Fitness ("Smooth") under the SMOOTH brand name. The RESENTIAL warranty period to the original purchaser is (lifetime) on the frame, (10) years on the motor, (3) years on parts, and (1) year labor. This warranty does not cover wear and tear, only manufacturer defects for the periods specified. LIGHT INSTITUTIONAL WARRANTY is limited to specific settings (see below) and includes an original purchaser warranty of (1) year on the Frame, Motor, Parts, and (1) year labor.

Smooth warrants that the Product you have purchased for non-commercial, personal, family, or household use from Smooth or from an authorized Smooth reseller is free from defects in materials or workmanship under normal use during the warranty period. Your sales receipt, showing the date of purchase of the Product, is your proof of the date of purchase. This warranty only extends to you, the original purchaser. It is not transferable to anyone who subsequently purchases the Product from you. It excludes expendable parts. This Limited Warranty becomes VALID ONLY if the treadmill is purchased from a Smooth Fitness authorized dealer unless otherwise authorized by Smooth Fitness in writing (if anyone other than a Smooth Fitness authorized dealer sells a Smooth Fitness treadmill, the warranty will be void unless accompanied by written authorization by Smooth Fitness).

During the warranty period Smooth will at no additional charge, repair or replace (at Smooth' option) the part or product if it becomes defective, malfunctions, or otherwise fails to conform with this Limited Warranty under normal non-commercial, personal, family or household use. In repairing the Product, Smooth may replace defective parts, or at the option of Smooth, serviceable used parts that are equivalent to new parts in performance. All exchanged parts and Products replaced under this warranty will become the property of Smooth. Smooth reserves the right to change manufacturers of any part to cover any existing warranty.

To obtain warranty service, you must contact a Smooth authorized service technician or Smooth Fitness at our phone numbers located in this manual. Any parts determined to be defective must be returned to Smooth to obtain warranty service. You must prepay any shipping charges, export taxes, custom duties and taxes, or any other charges associated with transportation of the parts or Product. In addition, you are responsible for insuring any parts or Product shipped or returned. You assume the risk of loss during shipment. You must present Smooth with proof-of-purchase documents (including the date of purchase). Any evidence of alteration, erasing or forgery of proof-of-purchase documents will be cause to void this Limited Warranty.

This warranty does not extend to any product not purchased from Smooth or from an authorized Smooth reseller. This Limited Warranty does not extend to any Product that has been damaged or rendered defective; (a) as a result of accident, misuse, or abuse; (b) by the use of parts not manufactured or sold by Smooth; (c) by modification of the Product or normal wear and tear; (d) operation on incorrect power supplies; or (e) as a result of service by anyone other than Smooth, or an authorized Smooth warranty service provider. Product on which the serial number has been defaced or removed is not eligible for warranty service. Should any Product be submitted for warranty service be found ineligible therefore, an estimate of repair cost will furnished and the repair will be made if requested by you upon Smooth's receipt of payment or acceptable arrangements for payment.

**LIGHT INSTITUTIONAL SETTINGS** as defined here include hotel, motel, hospital or rehabilitation centers, multi-family dwellings (condominium or apartment complexes), police departments, fire departments, corporate wellness centers and the like. Any setting or application where usage would be more than six (6) hours per day will void the warranty. Health clubs, fitness centers, spas, and the like that have a membership fee are excluded as light-institutional settings, whereas the Product will carry no warranty in these settings. Written authorization from Smooth Fitness must be obtained regarding any other light-institutional uses.

EXCEPT AS EXPRESSLY SET FORTH IN THIS WARRANTY, SMOOTH MAKES NO OTHER WARRANTIES, EXPRESSED OR IMPLIED, INCLUDING ANY IMPLIED WARRANTIES OF MERCHANTABILITY AND FITNESS FOR A PARTICULAR PURPOSE. SMOOTH EXPRESSLY DISCLAIMS ALL WARRANTIES NOT STATED IN THIS LIMITED WARRANTY. ANY IMPLIED WARRANTIES THAT MAY BE IMPOSED BY LAW ARE LIMITED TO THE TERMS OF THIS LIMITED WARRANTY. NEITHER SMOOTH NOR ANY OF ITS AFFILIATES SHALL BE RESPONSIBLE FOR INCIDENTAL OR CONSEQUENTIAL DAMAGES. SOME STATES DO NOT ALLOW LIMITATIONS ON HOW LONG AN IMPLIED WARRANTY LASTS OR THE EXCLUSION OR LIMITATION OF INCIDENTAL OR CONSEQUENTIAL DAMAGES, SO THE ABOVE LIMITATIONS OR EXCLUSION MAY NOT APPLY TO YOU. This Limited Warranty gives you specific legal rights and you may also have other rights that may vary from state to state. This is the only express warranty applicable to Smooth-branded products. Smooth neither assumes nor authorizes anyone to assume for it any other express warranty.

PLEASE MAIL WARRANTY CARD TO: SMOOTH FITNESS, PO BOX 551239, DALLAS, TX 75355

<b>SMOOTH TREADMILL WARRANTY REGISTRATION</b>			<b>TELEPHONE</b>
<b>FIRST</b>	<b>M.I.</b>	<b>LAST</b>	<input type="text"/> <input type="text"/> <input type="text"/> - <input type="text"/> <input type="text"/> <input type="text"/> <input type="text"/> <input type="text"/> <input type="text"/> <input type="text"/> <input type="text"/>
<b>ADDRESS</b>			<b>APT. NO.</b>
<input type="text"/> <input type="text"/> <input type="text"/> <input type="text"/> <input type="text"/> <input type="text"/> <input type="text"/> <input type="text"/> <input type="text"/> <input type="text"/> <input type="text"/> <input type="text"/> <input type="text"/> <input type="text"/> <input type="text"/> <input type="text"/> <input type="text"/> <input type="text"/> <input type="text"/> <input type="text"/> <input type="text"/>			<input type="text"/> <input type="text"/> <input type="text"/> <input type="text"/>
<b>CITY</b>		<b>STATE</b>	<b>ZIP</b>
<input type="text"/> <input type="text"/> <input type="text"/> <input type="text"/> <input type="text"/> <input type="text"/> <input type="text"/> <input type="text"/> <input type="text"/> <input type="text"/> <input type="text"/> <input type="text"/> <input type="text"/> <input type="text"/> <input type="text"/> <input type="text"/> <input type="text"/> <input type="text"/> <input type="text"/> <input type="text"/>		<input type="text"/> <input type="text"/> <input type="text"/> <input type="text"/>	<input type="text"/> <input type="text"/> <input type="text"/> <input type="text"/> <input type="text"/> <input type="text"/>
<b>DATE OF PURCHASE</b>		<b>MODEL NO.</b>	<b>SERIAL NO.</b>
<input type="text"/> <input type="text"/> - <input type="text"/> <input type="text"/> - <input type="text"/> <input type="text"/>		<b>SMT9.2</b> <input type="text"/> <input type="text"/> <input type="text"/> <input type="text"/> <input type="text"/> <input type="text"/> <input type="text"/> <input type="text"/> <input type="text"/> <input type="text"/>	<input type="text"/> <input type="text"/> <input type="text"/> <input type="text"/> <input type="text"/> <input type="text"/> <input type="text"/> <input type="text"/> <input type="text"/> <input type="text"/>
Name of store or company where purchased:	Where did you learn about treadmills? TV ___ Radio ___ Friend ___  In Store Display ___ Salesperson ___  Print ad/flyer ___ Internet ___	How important are each feature: Least Most  Unique Features Horsepower Warranty Price Look/Design Folding Feature	Other Comments: _____ _____ _____
How do you plan to use the treadmill? Walk ___ Run ___ Both ___	Why did you purchase a treadmill?  Dr.'s Orders ___ Loose Weight ___ In-home convenience ___ Improve Cardiovascular Fitness ___ Safety from outdoors ___  Other _____	Smooth Fitness respects the rights of your privacy. Our company will not sell or distribute to others the information above. This information is used to track our product quality and to contact you in the event of a product safety concern. It may be used to offer you future product offerings only from Smooth. Please check here if wish not to receive any additional information.	
Who will use the treadmill? Male ___ Female ___ Both ___  How many family members? ___	AGE: 15-24 ___ 25-34 ___ 35-44 ___ 45-54 ___ 55-64 ___ 65+ ___		

## Free Manuals Download Website

<http://myh66.com>

<http://usermanuals.us>

<http://www.somanuals.com>

<http://www.4manuals.cc>

<http://www.manual-lib.com>

<http://www.404manual.com>

<http://www.luxmanual.com>

<http://aubethermostatmanual.com>

Golf course search by state

<http://golfingnear.com>

Email search by domain

<http://emailbydomain.com>

Auto manuals search

<http://auto.somanuals.com>

TV manuals search

<http://tv.somanuals.com>