

Attachment Illustrated Parts List



AGCO ALLIS

Simplicity
MANUFACTURING, INC.

500 N Spring Street / PO Box 997
Port Washington, WI 53074-0997 USA

© Copyright 2000 Simplicity Manufacturing, Inc. All Rights Reserved.

Rev. 11/2000

TP 400-2385-00-AT-SMA



Lift Lever - Lift Lever

984905

NOTE: Unless noted otherwise,
use the standard hardware torque
specification chart.

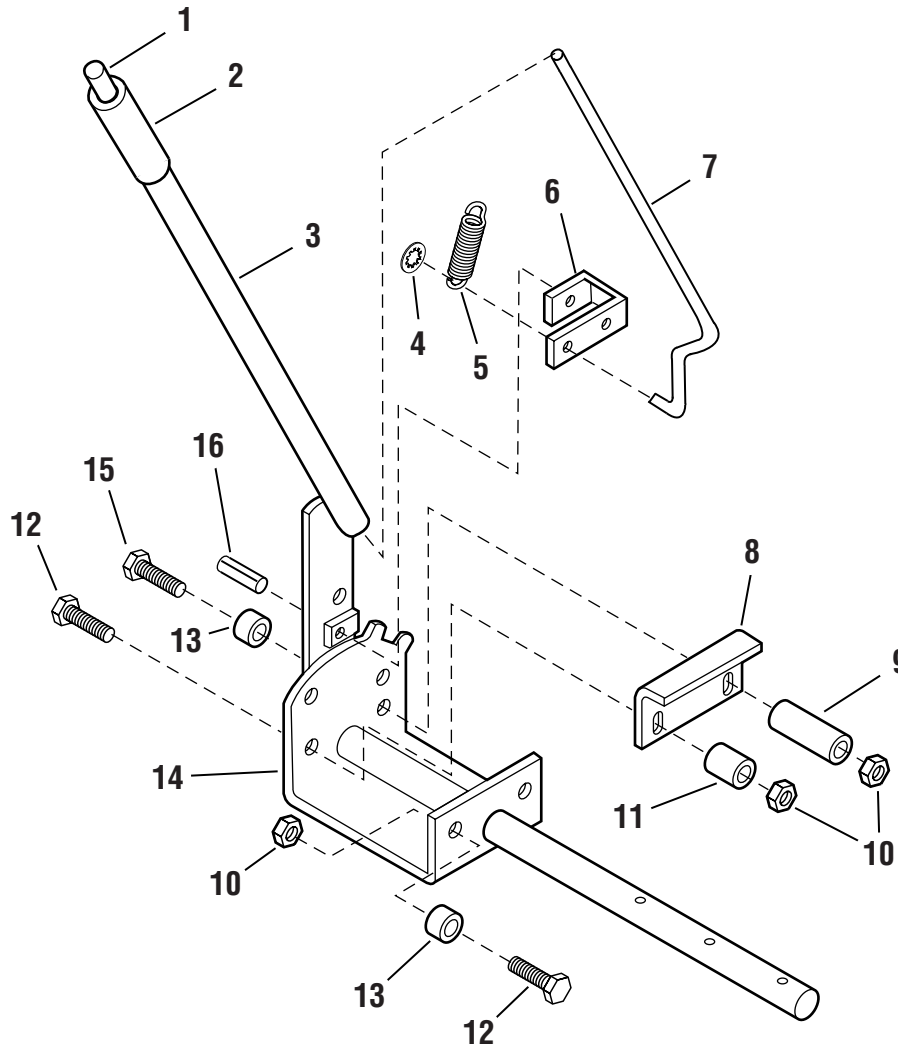

The above parts group applies to the following Mfg. Nos.:

1692623 Lift Lever - Regent

Lift Lever - Regent

REF NO.	PART NO.	QTY.	DESCRIPTION
1	1650157	1	BUTTON
2	1713995	1	GRIP
3	1704718	1	LEVER ASSEMBLY
4	1934953	1	PUSH NUT, 5/16
5	1667286	1	SPRING
6	1657648	1	LATCH, Lift Lever
7	1667290	1	ROD
8	1704715	1	BRACKET
9	1674669	1	SPACER
10	1919438	4	LOCKNUT, 5/16-18
11	1704716	1	SPACER
12	1921977	4	CAPSCREW, Hex Head 5/16-18 x 1-1/4
13	1675795	2	SPACER
14	1665591	1	QUADRANT, Lift
15	1921719	1	CAPSCREW, Hex Head, 3/8-18 x 2-1/2
16	1927609	1	ROLL PIN, 3/8 x 1

Footnotes:

The above parts group applies to the following Mfg. Nos.:

1692623 Lift Lever - Regent

Hardware Identification & Torque Specifications

Common Hardware Types

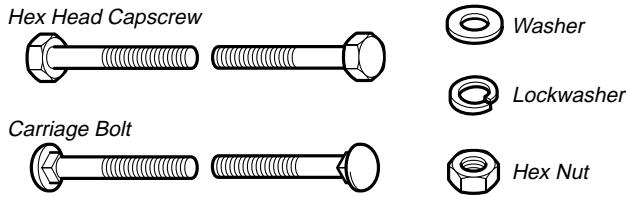

Standard Hardware Sizing

When a washer or nut is identified as **1/2"**, this is the *Nominal size*, meaning the *inside diameter* is 1/2 inch; if a second number is present it represent the *threads per inch*

When bolt or capscrew is identified as **1/2 - 16 x 2"**, this means the *Nominal size*, or *body diameter* is 1/2 inch; the second number represents the *threads per inch* (16 in this example, and the final number is the *body length* of the bolt or screw (in this example 2 inches long).

The guides and ruler furnished below are designed to help you select the appropriate hardware and tools.

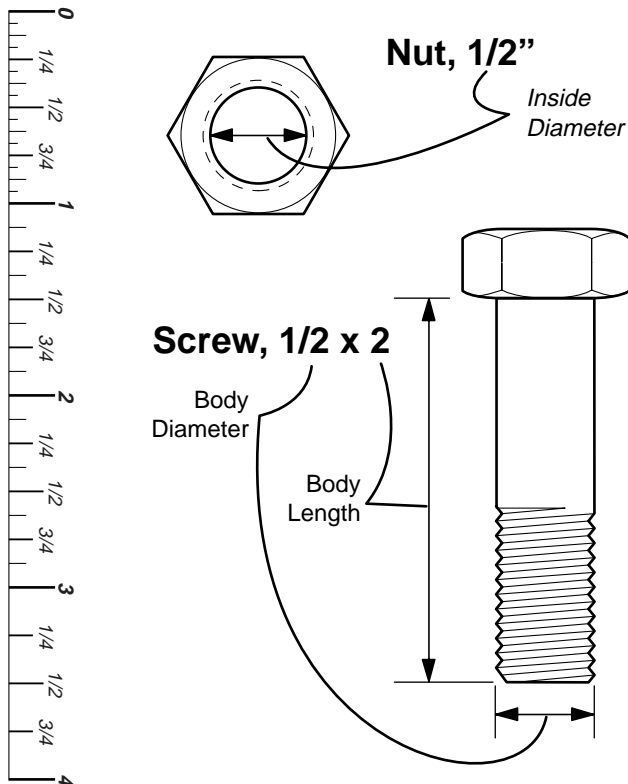

Torque Specification Chart

FOR STANDARD MACHINE HARDWARE (Tolerance ± 20%)

Hardware Grade	No Marks		SAE Grade 2		SAE Grade 5		SAE Grade 8	
	in/lbs	Nm.	in/lbs	Nm.	in/lbs	Nm.	in/lbs	Nm.
8-32	19	2.1	30	3.4	41	4.6		
8-36	20	2.3	31	3.5	43	4.9		
10-24	27	3.1	43	4.9	60	6.8		
10-32	31	3.5	49	5.5	68	7.7		
1/4-20	66	7.6	8	10.9	12	16.3		
1/4-28	76	8.6	10	13.6	14	19.0		
5/16-18	11	15.0	17	23.1	25	34.0		
5/16-24	12	16.3	19	25.8	27	34.0		
3/8-16	20	27.2	30	40.8	45	61.2		
3/8-24	23	31.3	35	47.6	50	68.0		
7/16-14	30	40.8	50	68.0	70	95.2		
7/16-20	35	47.6	55	74.8	80	108.8		
1/2-13	50	68.0	75	102.0	110	149.6		
1/2-20	55	74.8	90	122.4	120	163.2		
9/16-12	65	88.4	110	149.6	150	204.0		
9/16-18	75	102.0	120	163.2	170	231.2		
5/8-11	90	122.4	150	204.0	220	299.2		
5/8-18	100	136	180	244.8	240	326.4		
3/4-10	160	217.6	260	353.6	386	525.0		
3/4-16	180	244.8	300	408.0	420	571.2		
7/8-9	140	190.4	400	544.0	600	816.0		
7/8-14	155	210.8	440	598.4	660	897.6		
1-8	220	299.2	580	788.8	900	1,244.0		
1-12	240	326.4	640	870.4	1,000	1,360.0		

NOTES

- These torque values are to be used for all hardware excluding: locknuts, self-tapping screws, thread forming screws, sheet metal screws and socket head setscrews.
- Recommended seating torque values for locknuts:
 - for prevailing torque locknuts - use 65% of grade 5 torques.
 - for flange whizlock nuts and screws - use 135% of grade 5 torques.
- Unless otherwise noted on assembly drawings, all torque values must meet this specification.

Wrench & Fastener Size Guide



1/4" Bolt or Nut
Wrench—7/16"

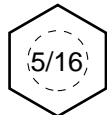

5/16" Bolt or Nut
Wrench—1/2"

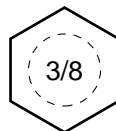

3/8" Bolt or Nut
Wrench—9/16"

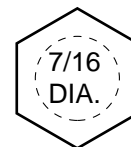

7/16" Bolt or Nut
Wrench (Bolt)—5/8"
Wrench (Nut)—11/16"

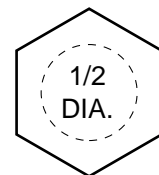

1/2" Bolt or Nut
Wrench—3/4"

Free Manuals Download Website

<http://myh66.com>

<http://usermanuals.us>

<http://www.somanuals.com>

<http://www.4manuals.cc>

<http://www.manual-lib.com>

<http://www.404manual.com>

<http://www.luxmanual.com>

<http://aubethermostatmanual.com>

Golf course search by state

<http://golfingnear.com>

Email search by domain

<http://emailbydomain.com>

Auto manuals search

<http://auto.somanuals.com>

TV manuals search

<http://tv.somanuals.com>